

Fall 2012

The historical fisheries in the Mediterranean Sea: A reconstruction of trawl gear, effort and trends in demersal fish stocks

Giacomo Chato Osio
University of New Hampshire, Durham

Follow this and additional works at: <https://scholars.unh.edu/dissertation>

Recommended Citation

Osio, Giacomo Chato, "The historical fisheries in the Mediterranean Sea: A reconstruction of trawl gear, effort and trends in demersal fish stocks" (2012). *Doctoral Dissertations*. 678.
<https://scholars.unh.edu/dissertation/678>

This Dissertation is brought to you for free and open access by the Student Scholarship at University of New Hampshire Scholars' Repository. It has been accepted for inclusion in Doctoral Dissertations by an authorized administrator of University of New Hampshire Scholars' Repository. For more information, please contact nicole.hentz@unh.edu.

**The historical fisheries in the Mediterranean Sea: a reconstruction
of trawl gear, effort and trends in demersal fish stocks**

BY

Giacomo Chato Osio

B.S., Marine Biology, Università degli Studi di Pisa, 2001
M.S., Marine Ecology, Università degli Studi di Pisa, 2001

Submitted to the University of New Hampshire
in partial fulfillment of
the requirements for the degree of

Doctor of Philosophy

in

Natural Resources and Environment

September 2012

UMI Number: 3533708

All rights reserved

INFORMATION TO ALL USERS

The quality of this reproduction is dependent upon the quality of the copy submitted.

In the unlikely event that the author did not send a complete manuscript and there are missing pages, these will be noted. Also, if material had to be removed, a note will indicate the deletion.



UMI 3533708

Published by ProQuest LLC 2012. Copyright in the Dissertation held by the Author.

Microform Edition © ProQuest LLC.

All rights reserved. This work is protected against unauthorized copying under Title 17, United States Code.

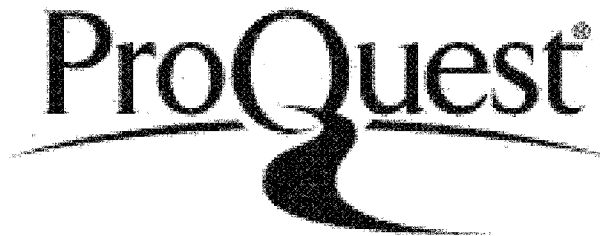

ProQuest LLC
789 East Eisenhower Parkway
P.O. Box 1346
Ann Arbor, MI 48106-1346

ALL RIGHTS RESERVED

©2012

Giacomo Chato Osio

*

This dissertation has been examined and approved.

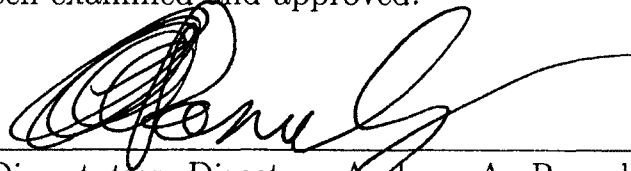

Dissertation Director, Andrew A. Rosenberg,
PhD

Professor of Natural Resources and the Environment,
University of New Hampshire



Andrew B. Cooper, Ph.D.

Associate Professor Resources and Environmental Management,
Simon Fraser University

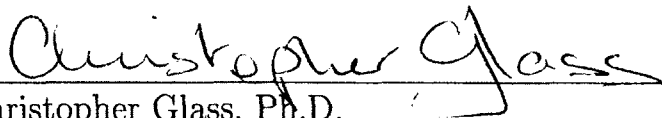

Christopher Glass, Ph.D.

Research Professor, University of New Hampshire

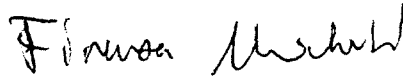

Fiorenza Micheli, Ph.D.

Professor, Stanford University

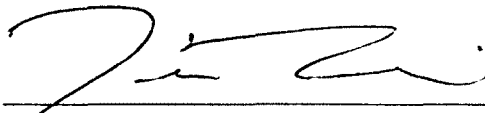

Timothy J. Miller, Ph.D.

National Marine Fisheries Service

8/13/12

Date

DEDICATION

This Dissertation is dedicated to my Family.

ACKNOWLEDGMENTS

I wish to thank a number of people without whom this thesis would have been impossible. I am deeply thankful to Prof Andrew Rosenberg for being supportive and inspiring for all these years and surely many more, the latter at least. My committee members, Fiorenza Micheli and Christopher Glass were always available and ready to provide valuable advice, thanks you. I am particularly indebted with Tim Miller and Andrew Cooper for great support and feedback with the statistical models.

This project relied on support from many Mediterranean colleagues and Institutes who believed in the value of recovering and analyzing historical data. *In primis* I want to thank Francesco Ferretti with whom I shared the ups and downs of recovering scattered data and analyzing it.

I am grateful to Henry Farruggio and Jean Marc Fromentin who facilitated access to French data, to Paolo Sartor, Mario Sbrana and Alessandro Ligas of CIBM for sharing valuable series and working on the EVOMED project. All colleagues on the EVOMED project were wonderful collaborators. A great thanks goes to Francesc Maynou and Charles Bas for providing the Catalan LPUE data and very useful advice for the analysis. The support from Alessandra Zampieri, Jann Martinshon and Thomas Barbas was very important, especially some flexibility in the final days of this work. Similar gratitude goes to my JRC colleagues for discussion and feedback. The thorough editing of the text from Kat Goetting and Karen Alexander was extremely valuable and gratefully improved the entire manuscript and I can't be thankful enough. Thanks to Massimiliano Cardinale for support and continuous feedback and encouragement.

This research was funded by the Fulbright Commission, the OAK foundation, HMAP and EC DG MARE via the EVOMED project. I also wish to express my gratitude to Paul Rago for the hospitality as visiting researcher at the NOAA NMFS Marine Lab in Woods Hole in June and July 2011. Without all this support this project would have not been possible and I am deeply thankful.

CONTENTS

	Page
Dedication	iv
Acknowledgments	v
LIST OF TABLES	xii
LIST OF FIGURES	xv
Abstract	xxvi
 CHAPTER	
1. BACKGROUND- INTRODUCTION	1
1.1 Historical shifting baselines	1
1.1.1 Mediterranean geophysical description	5
1.1.2 Nutrients and Eutrophication	6
1.1.3 Mediterranean fisheries description	7
1.1.4 Status of fish stocks and current management	9
1.2 Research Questions	11
1.3 Data Sources	13
1.3.1 Data mining	13
1.3.2 Landings and Fishing effort data	14
1.3.3 LPUE data	15
2. HISTORICAL EVOLUTION OF BOTTOM TRAWL GEAR IN THE MEDITERRANEAN SEA	16
2.1 Introduction	16
2.2 Sail trawling 1200-1930	17
2.2.1 French sailing trawl gear	18
2.2.2 Spanish sailing trawl gear	23
2.2.3 Italian sailing trawl gear	27

2.3	The transition from sailing to mechanized trawling 1900-1950	32
2.3.1	Steam Trawling	32
2.3.2	Motorized trawl gear in Spain.....	33
2.3.2.1	Catalan rig	35
2.3.2.2	Charleston rig.....	35
2.3.3	Motorized trawl gear in Italy.....	38
2.4	Modern trawl gear 1960-present	41
2.4.1	Nets	41
2.4.1.1	Vertical Opening	42
2.4.1.2	Net resistance, color, less drag	43
2.4.2	Otter doors	47
2.4.3	Vessel rigging	47
2.4.3.1	Navigation equipment	49
2.4.3.2	Deck equipment.....	49
2.5	Historical and modern trawl gear performance.....	52
2.5.1	Literature estimates of performance	54
2.5.1.1	Data and Methods.....	54
2.5.2	Results	59
2.5.3	Discussion.....	60
2.5.4	Simulation of Trawl gear.....	64
2.5.4.1	Data and Methods.....	64
2.5.4.2	Results and Discussion	65
2.5.5	Summary of 300 years of trawl gear evolution	68
2.6	APPENDIX 1	71
2.6.0.1	Net and mesh measurement in 1768	73
2.6.0.2	<i>Gangui</i>	74
2.6.0.3	<i>Gangui-Boeuf</i>	75
2.6.0.4	<i>Tartanne</i>	75
2.7	APPENDIX 2	79
3.	RECONSTRUCTION OF DEMERSAL TRAWL FISHING EFFORT IN THE MEDITERRANEAN SEA	85

3.1	Introduction	85
3.2	The expansion of sail trawling and subsequent social conflict 1200-1930	85
3.2.1	Trawl fleets in France	86
3.2.2	Trawl fleets in Spain	90
3.2.3	Trawl fleets in Italy	91
3.2.3.1	Adriatic Sea	93
3.2.3.2	Tyrrhenian Sea	94
3.2.3.3	Ligurian Sea	95
3.2.3.4	Southern Italy	95
3.2.4	Quantifying fishing days of sail trawlers	96
3.3	The transition from sailing to mechanized trawling 1900-1950	97
3.3.1	Motorized Trawling	97
3.3.2	Trawl fleets in Italy	97
3.3.2.1	Adriatic	98
3.3.2.2	Tyrrhenian Sea	100
3.3.2.3	Southern Italy	100
3.3.3	Trawl fleet in Spain	102
3.3.4	Trawl fleets in France	105
3.4	The growth in fishing power 1950-present	106
3.4.1	The Trawl fleet in France	106
3.4.1.1	Effort Control policies of 1970s in France	109
3.5	Temporal and spatial trends in fishing effort development	110
3.5.1	HP of a Sail Trawler	111
3.5.1.1	Relation between speed and power need	111
3.5.1.2	Vessel ratios	113
3.5.1.3	Conclusions	115
3.5.2	Reconstruction of trawling effort	116
3.5.2.1	HMAP Catalonia	119
3.5.2.2	ISTAT and IREPA Italian fleet	119
3.5.2.3	EU Fleet register data	120
3.5.3	Methods	121
3.5.4	Results and Discussion	123

3.5.4.1	Spain, Catalonia	123
3.5.4.2	France, Gulf of Lions	127
3.5.4.3	Italy, Adriatic	130
3.5.5	Conclusions	133
3.6	APPENDIX 3	134
4.	MEDITERRANEAN TOTAL DEMERSAL CATCH TRENDS FROM COMMERCIAL TRAWL LPUES	140
4.1	Introduction	140
4.2	Historical LPUE description	140
4.2.1	Description of historical trawl LPUE (pre-1950)	142
4.3	Modern Commercial LPUE	150
4.3.1	France, Pt. Vendres and Sete, 1950-present	150
4.3.1.1	Sete and Port Vendres	154
4.3.2	Adriatic Sea, data description former Yugoslavia 1950-present	155
4.3.3	Italy, data description Adriatic and Tuscany 1950-present	161
4.3.3.1	Tuscan Archipelago	161
4.3.4	Sicilian Channel	162
4.3.5	Spain, Blanes	163
4.4	Change in fishing power	164
4.4.1	Estimates of fishing power change	165
4.5	Analysis of commercial LPUE by sub-areas	169
4.5.1	Data description and preparation	172
4.5.2	Modelling	174
4.5.3	By Country models	180
4.5.3.1	France	180
4.5.3.2	Catalonia	190
4.5.3.3	Italy - Tuscany	195
4.5.3.4	Adriatic	200
4.5.3.5	Sicilian Channel and Tunisia	204
4.6	LPUE analysis all areas Western Mediterranean	207
4.6.1	Total Catch (kg/fishing day)	207

4.6.2	Total Catch (kg/60min)	214
4.6.3	Results	218
4.6.4	Discussion and Conclusions	221
4.6.4.1	Effect of fishing power	221
4.6.4.2	Effect of fishing areas	224
4.6.4.3	Effect of discard rates	226
4.6.4.4	Conclusions	227
4.7	APPENDIX 4	227
5.	LONG-TERM TRENDS IN ABUNDANCE OF DISAGGREGATED DEMERSAL SPECIES	233
5.0.1	Introduction	233
5.0.2	Metier and Clustering	233
5.1	Data description	235
5.1.1	Blanes 1956-present	235
5.2	Methods	237
5.2.1	Identification of targeting, CLARA	237
5.2.2	LPUE standardization with GAMMs	238
5.3	Results	240
5.3.1	Partitioning	240
5.3.2	Results LPUE standardization	253
5.3.2.1	Red Shrimp	255
5.3.2.2	Mediterranean hake	262
5.3.2.3	Blue whiting	268
5.3.2.4	Red mullets	274
5.4	Discussion and Conclusion	282
5.4.1	Clustering of metiers	282
5.4.2	Trend standardization	284
6.	CONCLUSIONS	288
6.1	Main Conclusions	288
6.1.1	Data mining and bibliography	288
6.1.2	Evolution of trawl fishing gear and effort in NW Mediterranean	289
6.1.3	Trends in total demersal commercial biomass LPUE	291
6.1.4	Individual species Blanes	292

- 6.1.5 Current demersal resource status 293
- 6.2 Fisheries Recovery 297
 - 6.2.1 Metrics and stock properties for recovery 298
 - 6.2.2 Policy framework to recovery 300
 - 6.2.3 Recovery prospectives in the Northwest Mediterranean 305

- BIBLIOGRAPHY..... 309**

- BIBLIOGRAPHY..... 310**

LIST OF TABLES

Table	Page
2.1 Summary table of the data sources by year and the number of sea trials of trawl gear used for modelling wing spread performance over time:	56
2.2 Summary table of fixed components estimates of best model fitted. The net material (<i>net_mat</i>) set as reference is hemp and the estimates of nylon and polyammide (PA) are compared with hemp. Estimates are shown on a Log scale.	62
2.3 Conversion of Ancient French units to the Metric System	72
2.4 Conversion of Ancient Spanish units to the Metric System	72
3.1 Comparison of fish landings in areas of Spain where there had been a trawling ban over the period 1831-1861 (Malaga) with areas where trawling had not been banned (Cadix, Sanlucar and Huelva)	91
3.2 Italian trawl fleet in 1864-65, according to ISTAT [1].	92
3.3 Number of yearly fishing days in Marseille (France) 1893-95, according to Marion.	96
3.4 Number of fishing days for sail trawlers on the Tuscan Archipelago in 1919 and 1920, from Mancini	97
3.5 Italian trawl fleet in 1937 according to ISTAT [2], (1) denotes all the vessels licensed in Italy while (2) the vessels fishing in Italy. HP(1) is total Horse Power and Tons (2) is total tons of entire Italian fleet. (3) <i>velieri m.a.</i> are sail trawlers with an additional motor for hauling fishing gear or navigation, but not for fishing.	98
3.6 Fishing fleet Fano 1910	99
3.7 Number of motor trawler fishing days, port of Sète (France), from Aparici-Fraticola [3] and Maupoint [4].	110
3.8 Effective Horse Power (E.H.P.) requirements as a function of velocity for a 10 m displacement vessel.	114

3.9	Data sources by Author and Year used for the reconstruction of trawl fishing effort in the western Mediterranean. * data provided by IREPA onlus and ** data provided by ISTAT.....	118
3.10	Summary table of fixed components estimates of best model fitted in Spain. The trawler type set as reference is motorized, and estimates of pair sail and single sail trawlers are compared to motorized trawlers. The estimates are on <i>Log</i> scale.	124
3.11	Summary table of fixed components estimates of best model fitted in France. The trawler type set as reference is motorized and the estimates of pair sail and single sail trawlers are compared to motorized trawlers. The estimates are on <i>log</i> scale.	127
3.12	Summary of vessel information available for Mediterranean trawlers from GFCM website for 2006/2007	139
4.1	Catch power coefficients redrawn after Bishop [5] and integrated with additional information.....	165
4.2	GLM model summary of the cpue estimated around Lampedusa Island in the summer of 1926 by Ermirio [6]. Reference vessels are a motor trawler, paranzamotore=pair trawler with sails and engine, piropeschereccio=steam trawler, stazza_netta=vessel tonnage	167
4.3	Summary table of data sources by country and year used in analyzing total commercial LPUE in the NW Mediterranean 1800-2009.....	175
4.4	AIC of different random effects models for Total Catch/Fishing Day in the Gulf of Lions (France)	186
4.5	AIC of different random effects models for Total Catch/Fishing Day in the Blanes series (Spain)	192
4.6	AIC of different random effects models for Total Catch/Fishing Day in the Porto Santo Stefano (PSS) and Castiglione della Pescaia (CDP) series (Tuscany, Italy)	196
4.7	AIC of different random effects models for Total Catch/Fishing Day in the Adriatic Sea.....	201
4.8	AIC of different random effects models for Total Catch/Fishing Day in the northwestern Mediterranean Sea.	211
4.9	Pair Sail Trawler catch in 1779 in Porto Fermo listed by owner, from [7]. The catch in <i>libbre</i> is converted to kg.	228

4.10	229
4.11	Comparison of fish landings in areas of Spain where trawling was banned over the period 1831-1861 (Malaga) with areas where trawling was not banned (Cadix, Sanlucar and Huelva)	229
4.12	Total catch of Italian trawlers fishing in the Sicilian Channel South of Lampedusa in the summer of 1926, according to Ermirio [6], NT= Net Tonnage, FD= fishing day	230
4.13	LPUE from the Conero steam trawler fishing activity in 1913 with 5 beam trawls.	231
4.14	Characteristics of the Pt. Vendres trawlers in 1951-1952, from Doumenge [8, p.69]	232
4.15	Characteristics of the Pt. Vendres trawlers in 1951, from Doumenge [8, p.71]	232
5.1	Mean scaled weight (kg) per cluster (K=5) for top scoring 10 species from best CLARA partitioning for historical Blanes data (1956-1965).	244
5.2	Mean scaled weight (kg) per cluster (K=5) for top scoring 10 species from best CLARA partitioning for modern Blanes data (1997-2009)	244
5.3	AIC of different random effects models for <i>Aristeus antennatus</i> standardization, Blanes (Catalonia, Spain).	256
5.4	AIC of different random effects models for <i>Merluccius merluccius</i> standardization, Blanes (Catalonia, Spain).	263
5.5	AIC of different random effects models for <i>Micromesistius poutassou</i> standardization, Blanes (Catalonia, Spain).	269

LIST OF FIGURES

Figure	Page
1-1 Mediterranean FAO landings grouped by ecological and size groups	12
2-1 <i>Gangui</i> net (C) towed by single vessel and <i>Gangui-Boeuf</i> , where vessels (A,D) tow the <i>Gangui</i> net (from Du Monceau, 1769)	19
2-2 <i>Gangui</i> net towed by single vessel, net wings (C,B), <i>partequ</i> (E), net mouth (A), cod-end (D) (from Du Monceau, 1769)	20
2-3 Boat rigging with <i>Gangui</i> (from Du Monceau, 1769)	20
2-4 <i>Tartanne</i> rig (from Du Monceau 1769), (A) main sail <i>grand voile</i> , (B) sail called <i>tente</i> , (CD) staysail called <i>coutelas</i> , <i>trinquette</i> , (EF) poles <i>bouted-dehors</i> , <i>paux</i> , (GG) warps <i>halins</i> , <i>sartis</i> in (H) double (bridles), (I) net wings <i>ailles</i> that precede the net body, (K) part of the wings where the mesh is smaller <i>enclestre</i> , (L) net mouth <i>margue</i> , (M) area where meshes are different <i>ségarié</i> , (N) cod-end <i>culaignon</i>	21
2-5 Construction and rigging of the net of a Spanish pair sail trawler according to drawings from Sáñez Reguart in 1795	24
2-6 Details of Spanish pair sail trawler net rigging, according to Sáñez Reguart in 1795	25
2-7 Operation of pair sail trawlers in Spain according to Sáñez Reguart in 1795	26
2-8 Net scheme of a <i>paranzella</i> (pair sail trawler) from Tuscany in 1866, according to Coccoluto Ferrigni [9]	28
2-9 Scheme of <i>Bragozzi</i> pair trawling with a <i>cocchia</i> net, from Faber 1882 [10, p.118].	29
2-10 Scheme of a <i>Tartana Grande</i> (pair sail trawling) net used in Fano (Italy) (from Ferretti, 1911)	31

2-11 <i>Tartana</i> net without otter boards (Fig.2) and the net rigged with otter boards (Fig.3) from the fishing experiments of the <i>Conero</i> steam trawler in Ancona, 1913 from Paolucci [11]	34
2-12 Net scheme of a traditional Catalan trawl net in use in Catalonia in 1950 according Bas et al. [12], for details see text.	36
2-13 Net scheme of a Charleston rig in use on Catalonian trawlers in the 1950s, from Bas et al. [12]	37
2-14 Drums and steel wire of a mechanical winch on a Catalonian trawler in the 1950s, from Bas et al. [12]	37
2-15 Otter doors of a 50-70 HP trawler in Catalonia in the 1950s from Bas et al. [12]	38
2-16 Scheme of the evolution of Mediterranean trawl fishing gear from 1700 to 1950, from Farina 1957 [13].	44
2-17 Split rigging of trawl wings to achieve higher vertical net opening, from Farina 1957 [13].	45
2-18 Percentage use of different net materials according to fishermen's interviews in the EVOMED Project, GSA06 (Catalonia), GSA17 (Northern Adriatic), GSA09 (Northern Tyrrhenian), GSA20+22 (Ionian and Aegean Sea) [14].	48
2-19 Frequency of occurrence of different navigation and cooling equipment since 1940 from fishermen's interviews EVOMED Project, GSA06 (Catalonia), GSA17 (Northern Adriatic), GSA09 (Northern Tyrrhenian), GSA20+22 (Ionian and Aegean Sea) [14].	50
2-20 Pairplot showing the relationship over time of the available trawl net gear and performance from 1950 to present from Mediterranean nets. Red lines are fitted polynomial smoothers.	51
2-21 Raw Wing Spread (WS) estimates plotted against Year by net material type. Estimates of WS were collected under different trawl conditions and nets are scaled to progressively larger HP.	57
2-22 Standardized Residuals versus fitted values for best model	60
2-23 Q-Q plot of Standardized residuals for best model	61
2-24 Random Effect Q-Q plot for best model	61

2-25	Comparison between the relations WS, Net drag and Total rig drag according to original sea trials and simulated performance for a hemp otter trawl from 1948 (HVAR), a hemp pair sail trawler net from 1795 (BOU) and a cotton otter trawler net used in 1965 (PDK). The hemp, nylon and polyammide WS and drag measurements are, respectively, from the 1950s, 1960-70, 1990-2009	67
2-26	Comparison between the relations HP and Total rig drag according to original sea trials and simulated performance for hemp otter trawl from 1948 (HVAR), a hemp pair sail trawler net from 1795 (BOU) and a cotton otter trawler net used in 1965 (PDK). The hemp, nylon and polyammide WS and drag measurements are respectively from the 1950s, 1960-70, 1990-2009	69
2-27	Timeline of the presence of each type of trawl gear in former Yugoslavian countries (Slovenia, Croatia, Serbia, Montenegro)[JUGO], Italy [ITA], France [FR] and Spain [ES].	70
2-28	Net scheme representative of a synthetic trawl net used on a 80 HP trawler of the Tyrrhenian Sea in late 1960s, from Bilio	80
2-29	Italian traditional net hemp, 1959, source Fao [15], headline=30.4 m , groundrope=35.6m	81
2-30	Net scheme of a Spanish Sail trawler in 1795 from original drawings and descriptions in Sáñez Reguart	82
2-31	Net scheme of the otter-trawl net used in the Hvar survey in 1948, after description and drawings in Karlova and Soljan	83
2-32	Net scheme of the otter-trawl net used in the survey performed by Juckic in 1963-67 on a 180 HP trawler, redrawn after description and scheme in Juckic 1975.....	84
3-1	Adriatic bragozzo pair sail trawler circa 1900 from Ferretti (1911) [16]	112
3-2	Pair sail trawlers fishing off Fano circa 1900	113
3-3	Number of trawlers by gear type per area over the period 1600-2000. Pre-1950s data derive from spotted surveys while post-1950 data are generally census statistics.	117
3-4	Cumulative KW for trawlers in ports of Spain, France and Italy in 2010, source EU Fleet Register. Trawlers belong to categories ‘Bottom otter trawls’ (OTB) ‘Otter twin trawls’ (OTT) and ‘Beam trawls’ (TBB)	121

3-5	Predicted historical number of trawlers and census statistics of the fleet for Catalonia (Spain).....	125
3-6	Predicted historical HP of sail and motor trawler compared to contemporary census statistics from Catalonia (Spain).....	125
3-7	Estimated and census numbers of trawl vessels by gear in the Gulf of Lions (France).	128
3-8	Estimated HP of trawl fleets by gear in the Gulf of Lions (France). Pre-1950 data are estimates and post-1950 data are from census statistics.	129
3-9	Estimated and census numbers of trawlers in the Adriatic Sea (Italy).	131
3-10	Estimated HP of trawl fleets by gear in the Adriatic Sea (Italy). Pre-1950 data are estimates and post1950 data are from census statistics.	132
3-11	Standardized Residuals versus fitted values for best model in Spain pre-1950	135
3-12	Q-Q plot of Standardized residuals for best model in Spain pre-1950	135
3-13	Random Effect Q-Q plot for best model in Spain pre-1950	136
3-14	Standardized Residuals versus fitted values for best model in Italy pre-1950	136
3-15	Q-Q plot of Standardized residuals for best model in Italy pre-1950	136
3-16	Random Effect Q-Q plot for best model in Italy pre-1950	137
3-17	Standardized Residuals versus fitted values for best model in France pre-1950	137
3-18	Q-Q plot of Standardized residuals for best model in France pre-1950	138
3-19	Random Effect Q-Q plot for best model in France per-1950	138
4-1	Mean monthly catch per pair of sail trawlers per year in Valencia (Spain) from 1792 to 1819, from Coronas 1821 [17]	144
4-2	LPUE for the <i>Conero</i> steam trawler fishing in the Fano area (Adriatic Sea, Italy) in 1913 with 5 beam trawls (<i>rapido</i>), from Paolucci (1913) [11].	149

4-3	LPUE of total demersal catch by country and area in the western Mediterranean. ITA=Italy, SCHAN=Sicilian Channel area, JUGO=former Yougoslavian area, TUNI=Tunisia, LIB=Lybia, ES=Spain (Catalonia)	151
4-4	Total demersal catch per fishing day from commercial trawlers in different areas of Spain, France and Italy over the period 1940-1955, from Doumenge [8]	154
4-5	Average daily catch in Yugoslavian waters in 1951, from commercial trawlers from Zupanovic [18]	156
4-6	Hourly trawler catch in KG in 1951 in Yugoslavian waters from Zupanovic [18]	157
4-7	Hourly catch in Yugoslavian water before and after WWII. Average trawler HP is between 40 and 60. Fishing grounds in Gulf of Rijeka and Kvarner were reopened in 1951 while the others were reopened in 1947, from Zupanovic (1953) [18].	158
4-8	Catch per fishing day for 4 different trawlers fishing in Northern Dalmatia in 1951-1953, from Zupanovic (1956) [19]	159
4-9	Daily catch for 3 Yugoslavian commercial trawlers fishing on the Blitvenica grounds in October of 1960, from Sharfe [20].	160
4-10	Standardized cpue for a pair sail-motor trawler, a steam trawler and a motor trawler fishing SW of Lampedusa Island in the summer of 1926 from Ermirio	168
4-11	LPUE estimates for Tunisian trawlers fishing in different areas between 1946 and 1971, from Bohulal (1972) [21].	170
4-12	Standardized catching power of modern vs old type of trawlers fishing in Tunisia over the period 1964-1971.	171
4-13	Summary of the Total number of fishing days retained for analyzing the LPUE (Tot demersal catch/fishing day) in the NW Mediterranean 1800-2009.	176
4-14	Set of scenarios simulating change in fishing power (FP) according to an increase of 0, 0.5, 1 and 2 % per year and the A_1 scenarios corresponding to the estimated increase in otter trawl wing spread switching from hemp, to nylon and polyester material over time, for detail see Chapter 1.	178

4-15 Percentage composition of combined LPUE from trawlers in different periods in the Gulf of Lions (France). More than 30 species make up the LPUEs, for plotting purposes, however, only those contributing more than 0.4% were retained.	182
4-16 Percentage composition of combined LPUE from trawlers in different periods after removal trips exceeding pelagic catches of 100 kg/day of individual species for <i>Trachurus trachurus</i> , <i>Scomber scombrus</i> , <i>Engraulis encrasicolus</i> and <i>Sardina pilchardus</i> , Gulf of Lions (France). Since more than 30 species make up the LPUEs, only those contributing more than 0.4% were plotted.	183
4-17 HP growth over time in Port Vendres (PV) and Sete (ST) plus smoothers in the Gulf of Lions (France).	184
4-18 Daily LPUE (Kg/fishing day) for the ports of Sete and Port Vendres in the Gulf of Lions (France) fitted with a simple smoother.	185
4-19 Estimated smoothing curves and random effects from the best GAMM for total catch/fishing day in the Gulf of Lions (France), with 95% Confidence Intervals	188
4-20 Model diagnostics for total catch/fishing day best model for the Gulf of Lions (France)	189
4-21 Daily LPUE (Kg/fishing day) for the port of Blanes (Catalonia) fitted with a simple smoother.	190
4-22 HP growth over time in Blanes (Catalonia, Spain) plus smoother.	191
4-23 Estimated smoothing curves and random effects from the best GAMM for total catch/fishing day in Blanes fishing grounds (Catalonia), with 95% Confidence Intervals	193
4-24 Model diagnostics for total catch/fishing day best model for Blanes fishing grounds (Catalonia)	194
4-25 Daily LPUE (Kg/fishing day) for the Porto Santo Stefano and Castiglione della Pescaia (Tuscany- Italy) fishing grounds fitted with a simple smoother.	195
4-26 Estimated smoothing curves and random effects from the best GAMM for total catch/fishing day on the Porto Santo Stefano and Castiglione della Pescaia fishing grounds (Southern Tuscany, Italy), with 95% Confidence Intervals.	198

4-27 Model diagnostics for total catch/fishing day best model for the Porto Santo Stefano and Castiglione della Pescaia fishing grounds (Southern Tuscany, Italy)	199
4-28 Daily LPUE (Kg/fishing day) for the Adriatic area with fitted lines for Year Kg per Fishing day.	200
4-29 Estimated smoothing curves and random effects from the best GAMM for total catch/fishing day in the Adriatic Sea, with 95% Confidence Intervals.....	202
4-30 Model diagnostics for total catch/fishing day best model for the Adriatic Sea.....	203
4-31 Daily LPUE (Kg/fishing day) for the Sicilian Channel fishing grounds fitted with a simple smoother.	204
4-32 Estimated smoothing curves and random effects from the best GAMM for total catch/fishing day in the Sicilian Channel, with 95% Confidence Intervals.....	205
4-33 Model diagnostics for total catch/fishing day best model for the Sicilian Channel. The diagnostics plots show bad residual patterns and a poorly fitting model	206
4-34 Daily LPUE (Kg/fishing day) for western Mediterranean countries fitted with a simple smoother.	208
4-35 Daily LPUE (Kg/fishing day) for the western Mediterranean fishing grounds fitted with a simple smoother.	209
4-36 Number of fishing days available and modeled in the LPUE standardization for the western Mediterranean fishing grounds, plotting based on area, country and year.	210
4-37 Vessel engine HP over time and by country used in the LPUE standardization for the western Mediterranean fitted with a loss smoother.	211
4-38 Estimated smoothing curves and random effects from the best GAMM for total catch/fishing day in the western Mediterranean (excluding Algeria and Morocco), with 95% confidence intervals.	212
4-39 Model diagnostics for total catch/fishing day best model for the western Mediterranean (excluding Algeria and Morocco)	213

4-40	Daily LPUE (Kg/fishing hour) for western Mediterranean fishing grounds fitted with a simple smoother.	214
4-41	Estimated smoothing curves and random effects from the best GAMM for total catch/fishing day in the western Mediterranean (excluding Algeria and Morocco), with 95% confidence intervals.	216
4-42	Model diagnostics for total catch/fishing hour best model for the western Mediterranean (excluding Algeria and Morocco)	217
4-43	Summary of the estimated year smoother, with 95% confidence intervals, for the main areas analyzed for kg/hour LPUE. The x-axis shows the year and the rug (little vertical lines along the axis) the years in which data are available. The y-axis is the contribution of the smoother to the fitted values relabeled to show the unit of LPUE.	219
4-44	Summary of the estimated year smoother, with 95% confidence intervals, for the western Mediterranean for kg/hour and kg/day (excluding Algeria and Morocco). The x axis shows the year and the rug (little vertical lines along the axis) the years in which data are available. The y-axis is the contribution of the smoother to the fitted values relabeled to show the unit of the LPUE.	220
5-1	Silhouette plot old data Blanes (1956-1965)	241
5-2	Silhouette plot for CLARA partitioning of the Blanes fishing trips in the modern series (1997-2009).	242
5-3	Species contribution to each cluster, after CLARA partitioning, given as scaled mean weight per cluster for historical Blanes data (1956-1965). Each panel (1 to 5) represents the corresponding cluster, for readability only top ranking species were plotted.	247
5-4	Species contribution to each cluster, after CLARA partitioning, given as scaled mean weight per cluster for modern Blanes data (1997-2009). Each panel (1 to 5) represents the corresponding cluster, for readability only top ranking species were plotted.	248
5-5	Sum of fishing days by metier/cluster per year in the Blanes trawl fishery in the old and new periods. The clusters (panels 1:5) don't match across periods, for approximate correspondence, see details in text.	249
5-6	Sum of fishing days by metier/cluster per month in the Blanes trawl fishery in the old and new periods. The clusters (panels 1:5) don't match across periods, for approximate correspondence, see details in text.	250

5-7	Trawler engine HP by metier/cluster in the Blanes fishery in the old and new periods. Clusters (panels 1:5) don't match across periods, for approximate correspondence, see details in text. Fitted smoother indicates the mean HP per year in each metier.	251
5-8	Calculation of nominal trawling fishing effort (Days at sea * vessel HP) and corrected nominal effort times catching power factor A_1 in Blanes (Catalonia).....	252
5-9	Correlation and histogram of vessels technical characteristics, in Blanes 1956-1965	253
5-10	Correlation and histogram of vessels technical characteristics, in Blanes 1997-2004	254
5-11	Raw LPUE for <i>Aristeus antennatus</i> in the Blanes (Catalonia) trawl fishery from all cluster old and new. Date go from 1955-1965 in the old clusters and from 1997-2009 in the new clusters.	258
5-12	Raw LPUE for <i>Aristeus antennatus</i> in the Blanes (Catalonia) trawl fishery from cluster 2 in the old data and 3 in the new data, fitted with a simple smoother.	259
5-13	Estimated smoothing curves and random effects from the best GAMM model for <i>Aristeus antennatus</i> in the Blanes (Catalonia) trawl fishery, with 95% Confidence Intervals.	260
5-14	Model diagnostics for total model for <i>Aristeus antennatus</i> in the Blanes (Catalonia) trawl fishery, with 95% Confidence Intervals.....	261
5-15	Raw LPUE for <i>Merluccius merluccius</i> in the Blanes (Catalonia) trawl fishery from all cluster old and new. Date goes from 1955-1965 in the old clusters and from 1997-2009 in the new clusters.....	264
5-16	Raw LPUE for <i>Merluccius merluccius</i> in the Blanes (Catalonia) trawl fishery from cluster 1,3 and 5 in the old data and 1 and 2 in the modern data, fitted with a simple smoother.	265
5-17	Estimated smoothing curves and random effects from the best GAMM model for <i>Merluccius merluccius</i> in the Blanes (Catalonia) trawl fishery, with 95% Confidence Intervals.	266
5-18	Model diagnostics for total model for <i>Merluccius merluccius</i> in the Blanes (Catalonia) trawl fishery, with 95% Confidence Intervals.....	267

5-19	Raw LPUE for <i>Micromesistius poutassou</i> in the Blanes (Catalonia) trawl fishery from all clusters, old and new. Date go from 1955-1965 in the old clusters and from 1997-2009 in the new clusters.	270
5-20	Raw LPUE for <i>Micromesistius poutassou</i> in the Blanes (Catalonia) trawl fishery from clusters 3 and 5 in the old data and 1 and 4 in the modern data, fitted with a simple smoother.	271
5-21	Estimated smoothing curves and random effects from the best GAMM model for <i>Micromesistius poutassou</i> in the Blanes (Catalonia) trawl fishery, with 95% Confidence Intervals.	272
5-22	Model diagnostics for total model for <i>Micromesistius poutassou</i> in the Blanes (Catalonia) trawl fishery, with 95% Confidence Intervals.	273
5-23	Raw LPUE for <i>Mullus barbatus</i> in the Blanes (Catalonia) trawl fishery from all clusters old and new. Date goes from 1955-1965 in the old clusters and from 1997-2009 in the new clusters.	276
5-24	Raw LPUE for <i>Mullus</i> sp. in the Blanes (Catalonia) trawl fishery from all clusters old and new. Date goes from 1955-1965 in the old clusters and from 1997-2009 in the new clusters.	277
5-25	Raw LPUE for <i>Mullus surmuletus</i> in the Blanes (Catalonia) trawl fishery from all clusters old and new. Date goes from 1955-1965 in the old clusters and from 1997-2009 in the new clusters.	278
5-26	Raw LPUE for <i>Mullus</i> sp. in the Blanes (Catalonia) trawl fishery from clusters 3 and 5 in the old data and 1 and 4 in the modern data, fitted with a simple smoother.	279
5-27	Estimated smoothing curves and random effects from the best GAMM model for <i>Mullus</i> sp. in the Blanes (Catalonia) trawl fishery, with 95% Confidence Intervals.	280
5-28	Model diagnostics for total model for <i>Mullus</i> sp. in the Blanes (Catalonia) trawl fishery, with 95% Confidence Intervals.	281
5-29	Standardized LPUE for Mediterranean hake, red shrimp, blue whiting and red mullets in the Blanes (Catalonia) trawl fishery, with 95% Confidence Intervals.	282
5-30	Summary of the exploitation levels of some stocks for which status was assessed by STECF working groups from 2008-2011. For the ratio F/F_{msy} on the x-axis, a value greater than 1 means the stock is overexploited.	286

- 6-1 Summary of the stock assessed by STEC in the Mediterranean Sea over the period 2008-2012. The fishing mortality reference point is the ratio between $\log(F/F_{MSY})$, where $F_{0.1}$ is used as a proxy for F_{MSY} . Stocks > 10 are considered overexploited and < 10 are sustainable. For small pelagics, the reference point is $E = 0.4$ 295

ABSTRACT

The historical fisheries in the Mediterranean Sea: a reconstruction of trawl gear, effort and trends in demersal fish stocks

by

Giacomo Chato Osio

University of New Hampshire, September, 2012

An extensive search of historical data sources and publications has been carried out in different countries of the Mediterranean. This led to the construction of the largest compilation of historical fisheries information existing in the Mediterranean region. The goal first here was to quantify historical trawling effort. This shows that Mediterranean demersal communities underwent a much longer and more systematic exploitation than previously thought, very likely the longest known exploitation by means of trawls in Europe and North America. Analysis of the data available for the Catalanian, Italian and French areas showed a clearly emerging pattern: fishing capacity increased in Mediterranean EU countries up to and through the 20th Century until the 1980s-1990s, depending on the area. From that period on, fleet size has been decreasing steadily. However, it is unclear whether this decrease in vessel numbers in the last 20 years has been accompanied by a decrease in fishing power and fishing mortality.

Trawl gear was reconstructed with the goal of deriving qualitative and quantitative estimates of increase in fishing power and improved gear performance. The rate of adoption of new technology (synthetic nets, hydraulic winches, navigation equipment, etc.) was reconstructed by area and the effect of these improvements on catch rates was discussed. Analysis of the change in the horizontal opening in trawl nets over time, parameter A_1 , proved that, with the adoption of new net material and net rigging, the actual size of the net, for the same vessel HP, almost doubled over 40 years.

Reconstructing relative trends in demersal species abundance was one of the primary goals of this project and the intention was to go as far back in time as possible. A first set of analyses was carried out by individual fishing areas/countries with consistent data going back only to 1950. In Blanes, France, the Adriatic Sea and the Sicilian Channel, the drop in

biomass was extremely large. In Tuscany the temporal trend since the mid 1960s appears flat but in this analysis the historical data are likely underestimates and a fishing power correction was not used. The second set of analyses pooled all available data together, including LPUEs from sail and steam trawlers from the beginning of the 20th Century and covered the entire western Mediterranean. When LPUE kg/fishing day was modeled, the highest relative biomass was identified in the 1920s with a second lower peak in the 1960s and contemporary biomass even lower. The further back the series was reconstructed, the larger the decline in demersal biomass. This is a quantification of the shifting baseline syndrome: today we are assessing stock solely based on data from the past 20 years, which correspond to the lower part of the trends in all models, so that we have no knowledge of the extent of the decline. A case study was built with data from Catalonia for individual species. Results showed steep declines for red shrimp and blue whiting and important declines for hake and mullets, although for the latter, residual patterns are not optimal.

The overall depleted status of demersal stocks in most West Mediterranean calls for serious management and implementation of credible recovery plans for most demersal stock via adequate reductions of F paired with the establishment of large MPAs. The latter will allow the recovery of vulnerable species that have life history traits that would not be unresponsive compatible with even reduced fishing mortality levels. The incorporation of historical data will be of crucial importance for proper assessment of demersal stocks given the exploitation history as well as for the constructing rebuilding plans.

CHAPTER 1

BACKGROUND- INTRODUCTION

1.1 Historical shifting baselines

The term baseline refers to a starting and fixed point against which change is measured. If only fixed baselines existed managing marine resources would be relatively simple. The problem is caused by the short life span of scientist and managers compared to the ecosystems longevity. In Daniel Pauly's [22] words, "this syndrome has arisen because each generation of fisheries scientists accepts as a baseline the stock size and species composition that occurred at the beginning of their careers, and uses this to evaluate changes. When the next generation starts its career, the stocks have further declined, but it is the stocks at that time that serve as a new baseline." The importance of recognizing ecological baselines was articulated in Pauly's paper and was corroborated by other high impact publications [23, 24, 25]. If today we manage a resource based on a poorly chosen baseline, we are likely failing to properly assess the extent of change and magnitude of system carrying capacity or function.

As an example, the current EC STECF assessments of Mediterranean resources [26] are done exclusively using as tuning indexes the MEDITS survey [27] data, which dates back to 1994. In 1994, however, it is unlikely that resources were anywhere near pristine as fisherman have been trawling for at least 300 years in the Mediterranean. According to such assessments, many stocks are overfished but few are not. While it is reassuring that some stocks are recognized as overfished, the extent to which they are depleted is very likely underestimated as in 1994 fishing impacts had already occurred for at least a century. Additionally, the species being assessed are important commercial species (Mediterranean hake, red mullets, and one species of shrimp) with life history traits that make them very

resilient to high fishing pressure. Rare species that once had high commercial interest are not assessed; an example in the Mediterranean is *Rombus maximus*.

Overfishing was hypothesized, although with no quantitative evidence, for Atlantic bluefin tuna as early as 1757 by Sarmiento [28]. Marion [29] in 1891 complained of an excessive development of fishing effort, of the damage trawl gear had on fish eggs and juveniles and talked about overfishing in the Gulf of Marseilles. In the same area Gourret [29] reported that there had been a trawling ban enforced from 1793 to 1830 because of the concern about the impact of trawling. When the ban was lifted single hauls from trawl vessels powered by sails reached as much as 1.5 tons, and Mediterranean hake (*Merluccius merluccius*) of 7-8 kg and John dories (*Zeus faber*) of 2-3 kg were commonly caught. For the sake of comparison, modern trawlers with 1000 HP catch a fraction of the catch reported by Gourret (GC Osio, Unpublished data). All trawlers were disarmed by 1877 because catches had declined too much and trawling was not profitable anymore. Zei and Sabioncello (1949) [30] measuring trawler cpues in the Adriatic before WWII declared that resources were depleted and called for reduction of fishing effort. Maurin did the same in the 1960s for the Gulf of Lion and many others in more recent times.

Besides the extent of the shifting baseline syndrome in Mediterranean resource management, these examples show the fact that today we cannot generate realistic null hypotheses about the composition and dynamics of ecosystems from our understanding of the present alone, since all ecosystems have almost certainly changed due to both human and natural environmental factors [24]. Without a baseline to measure change against we might end up managing or measuring noise in relic populations [31]. I will add two other examples about Mediterranean baselines that are lost.

Roman author Claudius Aelianus (circa 175-235 A.C.) in the *De Natura Animalium* mentioned Mediterranean monk seal (*Monachus monachus*) in different occasions. In his book he mixed the description of the therapeutic uses of seals with behavioral observation and stories. In particular Aelianus described monk seal colonies composed of many animals that lived on open beaches in the Bonifacio Strait between Sardinia and Corsica. During fall months “sea monsters”, that match the description of Killer whales, *Orcinus orca*,

appeared in that area to prey on the seals, attacking them directly on the beaches and outside sea caves. In 1560 Gesner and Rondelet, quoting Olaus Magnus (1490-1557), reported seals as to “fear the great whale-fish called “Ziphius”, a horrible whale-fish ... by which it is swallowed” (in Johnson (2004) [32]). A drawing of this scene recalls a killer whale with her calf or possibly a large shark, eating a seal.

Today killer whales, as well as large sharks, are rare occurrences in the Mediterranean Sea, but the description of their past behavior is very similar to that currently occurring on the Valdez peninsula in Argentina and in other areas. The rarity of orcas today might be related to the near extinction of monk seals, whose population is estimated to be between 200-350 individuals in the entire Mediterranean. While it is very difficult to quantify the abundance of Mediterranean monk seals during Roman and Medieval times, what appears clear is that the seals lived on almost every coast and that there was commercial and subsistence exploitation for oil, skin and medicinal use. The causes of a continuous recent decline are a mixed effect of direct killing due to fisheries conflict and human disturbance in breeding caves. From a historical point of view it could be that there are today in the entire Mediterranean as many seals as there were on few beaches in the Bonifacio Strait 2000 years ago when Aelianus was describing the seasonal predation of killer whales. A baseline set 2000 years ago would be very different from one set in the 1980.

A second example, two to three species of sturgeons (*Acipenser* sp.) were commonly caught at sea by commercial fisherman. Marion reported the catch of sturgeon as very common near Marseilles in France in 1883 [33]. Doumenge reported catch of sturgeons in Cambrils in the Gulf of Lion in 1950s [8]. In the Adriatic in the Hvar survey in 1948-1949 one sturgeon was caught in 200 hauls [34] and records from fish markets of Chioggia and Trieste consistently reported some catch until the late 1950s. Similarly capture of this fish have been reported from Catalonia [12], Tuscany [35] and other areas before the 1950s. Today, out of a database with thousands of tows from different trawl surveys from the entire Mediterranean (GC Osio, Unpublished data) not one single *Acipenser* was caught in the past 40 years. Sturgeons are on the IUCN Red List of endangered species.

The monk seal and sturgeon baselines and the early reports of fish depletion are, in different ways, useful examples for today's current management. Today sturgeons are probably extinct in the Mediterranean, but knowing that they were once a common part of the ecosystem is important for the understanding change in trophic webs over time. The same is true for seals, particularly because seals are top predators. Their removal might have triggered unknown predator release effects on coastal fish communities. If the density of seals described by Aelianus was common in many areas in the Mediterranean, the fish biomass removed by seals might have been very important.

Another consideration regarding seals, although very hypothetical, is that over the past 2000 years there probably have been different baseline abundances. As commercial seal exploitation for fur and oil increased at Roman times, the numbers must have declined as suggested by records of increasing fur prices [36]. There was likely a recovery in the Medieval period when human populations moved away from the sea [36]. From the Renaissance to the present, increasing exploitation of marine resources and use of coastal areas, in conjunction with direct exploitation and conflict with fisherman, have caused seal populations to steadily declined [32]. One other cause that might have worsened the status of the population in the past century could have been the depletion of coastal fish stock. Baerzi *et al.* (2006) [37] showed the impact of reduced food availability for some cetaceans in the Ionian sea. As monk seals have small foraging ranges and prey on coastal fish, the depletion of coastal fish stocks might have had a significant effect on growth and reproduction. The case of the near extinction of monk seals is to some degree similar to the disappearance of northern fur seals from the temperate part of the Pacific North West, although this species has been able to recover [38]. Another monk seal that was not able to recover was the Caribbean monk seals, which became extinct at the beginning of the century [39]. From a restoration point of view it would be important to understand the mechanisms by which the Mediterranean monk seal has remained stable or is slowly declining at very low population abundance and by which northern fur seals managed to recover. For the Caribbean monk seal it clear that deliberate killing just eradicated this species.

Identifying baselines and especially population trajectories over time can be informative of causal relationships with anthropogenic impact and climatic factors, and of population behavior under different levels of depletion. Lotze and Milewski (2004) [40] argue that untangling past causes and consequences of change will provide us with a long-term perspective, which is essential to understanding current conditions and predicting future changes in species, communities, and ecosystems.

A need for historical data and long time-series is also important in traditional fisheries science where parameters like the fish natural mortality M or carrying capacity K can be estimated only at the early fisheries development [41]. M and K are important for many stock assessment models and their correct estimation is recognized to be essential [41].

For example, using the Grahm-Schaefer production model, MSY and equilibrium biomass level (B_m) could be determined at MSY as

$$MSY = 0.5MB_{\infty} = MB_m \quad \text{and} \quad B_m = 0.5B_{\infty} \quad (1.1)$$

given a value of pristine biomass B_{∞} [42]. In this case if B_{∞} and M are estimated later than at the onset of fishing the estimation of MSY and B_m will be biased. This approach has often been used in developing fisheries where very few data are available [43].

In the Mediterranean area there is a very strong “shifting baseline syndrome” in current fisheries management as well as no perception of the extent of the change in fish communities over time. Identifying baselines and understanding what trajectories of restoration could be are the drivers of my research, with the goal of reducing the Mediterranean shifting baseline syndrome.

1.1.1 Mediterranean geophysical description

The Mediterranean Sea is a temperate sea enclosed by the land masses of Africa, Europe and Asia. The basin can be subdivided into different sub-areas. The Western Mediterranean is comprised of the area west of the Sicily Strait, including the Tyrrhenian and Alboran Seas. The Eastern Mediterranean is comprised of two areas: the most westerly part,

the Adriatic and Ionian Seas, and the most easterly part including the Aegean Sea and the Levantine Basin. The boundary between these two regions is formed by the Cretan Sea and the Cretan Strait. One main characteristic of the basin is a mean depth of 1000 m and limited continental shelf, with the exceptions of the Adriatic Sea and the Gulf of Lion.

The Mediterranean was formed by the enclosure of a part of the Thetys Ocean by the movement of the African Plate toward the European Plate. The only water exchange with the Atlantic Ocean is via the Straits of Gibraltar. During the Holocene and Pleistocene eras, water exchange has been very limited at times, leading to anoxic events in deep waters and primary productivity increases that generated sapropel depositions [44]. Sapropel layers alternate with carbon-poor silts and mud layers that are very similar to today's depositions. It is hypothesized higher productivity and sapropel depositions were consequences of a milder climate with higher precipitation and river discharge into the basin. This is very different from today's conditions of high evaporative rates in the Southern part of the basin that are influenced by North Africa's desert climate.

The Mediterranean Basin has historically been characterized by a net loss of water via evaporation. This generates a reverse thermohaline circulation with the inflow of surface Atlantic waters via the Gibraltar Strait. These waters, characterized by a low salinity (36.15 psu), flow along the North African coast, pass through the Sicilian Channel where they generating local northward gyres, and then enter the Levantine Basin.

1.1.2 Nutrients and Eutrophication

The Mediterranean is characterized by both a very ancient pervasive human presence and by a close and fast water-land coupling. Because of the coupling speed the Mediterranean is a sea that responds on very short time scales to human and environmental perturbations. In the last thirty years in the Northwestern basin there has been a change in the physical and chemical characteristics of deep waters. It has been estimated that phosphate concentrations have increased with a rate of 0.5% per year, with zinc and lead increasing at 6%, and copper and cadmium at 2% [45]. The water temperature and salinity have been steadily increasing over the same period at a 0.0036 ° Celsius per year and 0.0011 psu per

year, respectively. These rapid changes in deep water reflect changes in surface and coastal waters that result from several factors such as increased nutrient run-off, global warming, loss of natural buffers, etc. In other oceans there is no such rapid coupling between human impact and its pervasive environmental signature.

Eutrophication significantly accelerated during this century. The anthropogenic P load in Italy has almost tripled from 1910 to 1977, owing to intense development of agriculture (artificial fertilizers), industry and marine traffic and, after the 1950s, to massive use of polyphosphate detergents [46, 47]. These trends are very likely similar in other parts of the NW Mediterranean where agricultural, industrial and urban development followed similar paths. In addition to an increase in nutrients, very important habitats such as estuaries, marshes and coastal lagoons over the last centuries have been drained and transformed into agricultural land. Overall, it has been suggested that, in the Mediterranean Sea, 28,000 km^2 (> 90%) of coastal wetlands have been lost since Roman times [48]. Recent estimates have also suggested that approximately two thirds of all European coastal wetlands that existed at the beginning of the twentieth century have now been lost [49, 50]. This has not only reduced ecosystem services such as nursery areas for important coastal fish species [51], but also compromised the buffering capacity [52] of marsh ecosystems for removing nutrients from eutrophic waters.

1.1.3 Mediterranean fisheries description

The Mediterranean Sea has been the cradle of Western civilization and its coastal areas have been of great importance for urban and commercial development. Since ancient times, coastal communities have been exploiting all forms of marine life. During the Roman Empire fish products (dried, salted and sauce) were shipped across the Mediterranean and production areas were in almost every country, especially in areas near salt harvesting facilities [53]. Most species were exploited with multiple fishing gears. These techniques, some of which are still in place, included beach-seines, lamparo, hand-lines, trammel-nets, pots, harpoons, traps and extensive aquaculture in coastal salt marshes and lagoons [53].

Fisheries from the Classical Period to the Middle Ages operated from the beach, along the shoreline or on marsh and lagoons. The overall rate of exploitation is generally considered to be low. Greater effort targeting fresh water species lead to early depletion of freshwater stocks in most parts of Europe [54].

Since the XVI century, with the exception of the bluefin tuna fishery, fisheries were mostly small scale and artisanal, and targeted pelagic species and coastal and shallow demersal fish (*Thunnus thynnus*, *Sardina pilchardus*, *Sardinella aurita*, *Engraulis encrasicolus* and *Scomber japonicus*). Two important technological developments around this time were first the introduction of pelagic gear like the *Sardinal* an early version of the purse-seine for small pelagics in the XVI century and the invention of trawl gear by the Catalans and Neapolitans at the end of the XVII century. *Bous* or *Tartane* were the names in Catalan or Italian of the first trawl nets that were dragged by a pair of sailing vessels [29, 16], while beam trawls were deployed by a single small vessel. The first steam trawlers appeared in Algeria (a French colony at the time) around 1880 [29], then in Italy and Spain in the 1920s, along with the first trawlers with diesel engines [12, 55]. After WWII almost all trawlers were equipped with motor engines with Horsepower [HP] between 40-70 [56, 8]. Ever since HP has been increasing. Today vessels in the same size range as in the 1950s have up to 800-1000HP [3, 57]. In the mid 1960s the first trawl gear with *Grand Overture*, or high opening, were introduced [58, 3], roughly doubling or tripling the swept volume. In the same period eco-sounders and radar became common and facilitated the detection of fish schools and more precise navigation. Overall in the past two centuries, fishing effort has steadily increased, especially in the NW Mediterranean. In the past 80 years with the introduction of gasoline motors on fishing vessels, fishing capacity has grown exponentially. The Mediterranean fishery has been, and still is with some recent exceptions in the NW, an artisanal or semi-industrial fishery: often fishermen own the vessels, the fishing areas are limited, trips are short and there is a large workforce. In addition, the fleets are composed of small vessels with very diversified gears and strategies, and there are hundreds of landing ports [59]. Nevertheless, fishing effort has historically been very pervasive in coastal and shallow areas and then progressively expanded as technology allowed exploiting fur-

ther grounds and deeper areas. To some degree there have been temporal differences in the evolution of fishing effort in different areas, and historical gradients of fishing effort in the Mediterranean likely exist.

Since Phoenician times large pelagic fish like bluefin tuna on their migratory routes into and out of the Mediterranean have been exploited with fixed nets and beach-seines. With fundamental Arabic contributions to the technology in the Middle Ages, these nets became similar to modern tuna traps: between 200-300 of them were present from the XV to the XX centuries in most parts of the Western Mediterranean [60]. Tuna traps have been the largest industrial fishery in the Mediterranean over the past centuries. As such they were owned and operated by aristocratic and wealthy families with political power and available capital [61]. After World War II, with the development of tuna purse seines, the tuna fishery gradually abandoned traditional traps and started targeting bluefin tuna in the open Mediterranean and Atlantic Ocean. The new technology has allowed greater exploitation rates and, consequently, landings. The 2006 ICCAT SCRS assessment indicates that the stock in 2004 is 19% of the 1975 level (ICCAT 2006). Other important fisheries in the past three centuries have been the red coral fishery, which collapsed in the early XX century, and the sponge fishery, which collapsed a few decades after the coral fishery [62, 63, 59].

1.1.4 Status of fish stocks and current management

Today the Mediterranean consists of 21 neighboring countries. Of these, five are European Union member States and occupy a third of the Mediterranean coastline. No EEZ has been implemented and almost all countries have territorial waters within 12 nautical miles. Due to narrow continental shelves, shared fish stocks are limited to specific areas [59]. The EC is slowly implementing a common fisheries management plan through the General Fisheries Commission for the Mediterranean (GFCM), which has a mandate to coordinate management strategies for the 21 Mediterranean States.

Two important features of the Mediterranean Sea are the presence of a large variety of species representing 5.5% of the global marine fauna and the absence of large mono-

specific stocks comparable to those that inhabit other oceans [59]. In the last fifty years, official FAO fish landing totals for the Mediterranean have increased steadily until 1994 (FAO FishStat) and subsequently declined. Currently there are no long time series of estimated biomass of single stocks, and the analytical evaluation of the status of fish stocks has started improving in recent years. Full assessments have been made only for a few important commercial species, mostly over small geographic areas. According to the Scientific Advisory Committee (SAC) of GFCM (Marine resources-Mediterranean and Black Sea, 2005, FAO FIRMS), excluding pelagic species, between 2001-2004 there have been occasional assessments for only 14 species, most of which are either over or fully exploited. All other commercial and non-commercial species are not assessed. Given the high levels of exploitation, the multi-species fishery and the visibly declining trend of FAO landings of some species, the overall situation is likely much worse than what has been assessed by SAC and FAO. For example, elasmobranch communities have been declining since the early 1900s and at greater rates in the past 30 years, resulting in individual species declines up to 99%, as shown by Aldebert [64] and Ferretti (2008)[65].

FAO landings (1950-2004), grouped in functional and size groups (using ecological role and maximum size from Fishbase) were plotted over time (Figure 1-1). There is an apparent continuous increase in the landings of pelagic species, which authors like Caddy have associated with bottom up effects linked to increased nutrient release from major NW Mediterranean rivers [66]. Trends in small demersal species have been fairly constant until a decline started in the late 1980s, while medium-large demersals increased slowly and started declining in the mid 1990s. Large increases can be seen in the landings of cephalopods and shrimps, with sharp declines in the cephalopods after 1990. This pattern, already described by Caddy [67], is likely linked to predator release in the upward trends, and perhaps to overfishing in the declining trend. Multiple caveats need to be raised when looking at FAO data since trends in landings may or may not be representative of true population changes given the evolution of fishing effort on different time and spatial scales. The discussion on this topic by Worm [68], Murwaski [69] and Mutsert [70] is informative about different perspectives. In any case, it is important to relate landings to fishing ef-

fort and identify true population trends using higher resolution landings data than those available in the FAO database.

In other parts of the world, major fish stocks, such as the Peruvian anchoveta [41], the North Atlantic cod stocks [71], have collapsed to the point of disrupting fisheries. We have seen that overfishing has been identified numerous times in Mediterranean Sea, from 1757 [28, 29] to the eve of World War II [30]. In many cases overfishing was a strong argument used in the debate between traditional fishermen and trawlers, but this should be taken with due caution since there is no quantitative evidence to support such historical statements. Despite very high and ancient exploitation and although many stocks are considered overfished to an unknown extent, it appears that, with the exception of several elasmobranch species, no fish stock has collapsed as thoroughly as Atlantic cod. The lack of collapse evidence might be partially due to a lack of information, or to the fact that the fishery has been historically targeting multiple species. In addition some argue this could be related to increased productivity of the system or perhaps to a higher resilience due to the high biodiversity and redundancy in the ecosystem. Worm *et al.* [72] in their meta-analysis have shown a strong correlation between biodiversity, resilience and recovery capacity. Understanding if the same correlation is in place in the Mediterranean is of great importance for the assessment of trajectories of recovery if impacts are reduced or removed.

1.2 Research Questions

This PhD dissertation will articulate four interconnected research themes.

1. The first goal is to describe the development of fishing fleets, technology over the past 300 years in Italy, France, Spain, the former Yugoslavia and parts of North Africa. A qualitative analysis will describe change in trawl gear over time, then the timeline of change by area will be quantified. Regression models will be employed to estimate the improvement in trawl fishing gear. Different approaches will assess the HP equivalent of sail powered vessels.

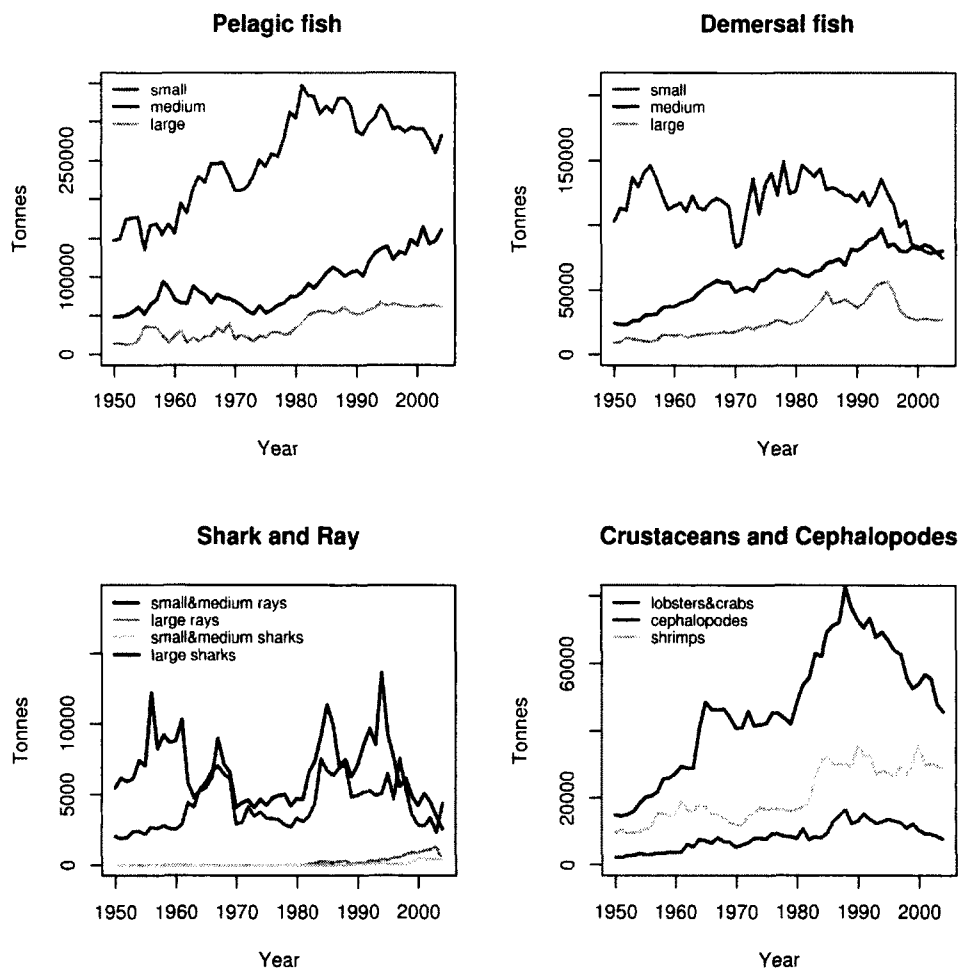

Figure 1-1. Mediterranean FAO landings grouped by ecological and size groups

2. The second goal is the reconstruction of trawl fishing capacity over the past 300 year in the NW Mediterranean by means of a quantification of the numbers of vessels, tonnage and fishing ranges. This information will be used to quantify the fishing pressure exerted on stocks over time and space, and relate effort and fish landings, or CPUEs, as well as to identify temporal and spatial gradients in demersal fishing effort.
3. The third goal is to reconstruct the changes in biomass of important commercial and non commercial species in the Adriatic, Tyrrhenian and Sardinian Seas, the Sicilian Channel and the Spanish Mediterranean. This will be achieved by analyzing mainly commercial landings per unit of effort (LPUE) and data originating from commercial scouting over the past 60 years, or on shorter time scales depending on availability. Statistical methodologies appropriate to the data and research question will be used, like Generalized Additive Mixed Models (GAMMs). Additionally, by comparing catch rates across trawler of different types (pair sail trawler, steam and motor trawlers), coefficients of fishing power will be derived.
4. The fourth part of the research focuses on analyzing one detailed dataset from Catalonia (Spain) that contains species specific LPUEs. Here, a first modeling step uses factorial analysis (Principal Components) to identify fishing metiers (or fish assemblages subject to targeting). A second step consists of standardizing the LPUEs with GAMMs once coherent clusters have been selected.
5. The last concluding part of this project will revise the current status of Mediterranean demersal resources based on current scientific advice and discuss recovery scenario perspectives for the main commercial demersal species.

1.3 Data Sources

1.3.1 Data mining

The first step necessary to achieve my research goals has been an extensive data mining exercise. In collaboration with F. Ferretti (Dalhousie University) extensive bibliographic

research has been carried out on digital databases and in historical archives. We searched the libraries of the Naples Anthon Dorn, the Villefranche's CNRS, the Monaco Aquarium, the Sete IFREMER, the Paris Ichthyological Museum, the Barcelona ICM, the Split IOF, FAO, Rome's Ministry of Agriculture, CNR and ISTAT; the Chioggia, Porto Santo Stefano and Trieste fish markets, and other minor sources. Digital copies of documents have been generated in pdf formats. Overall, 700 papers dating from 1757 to 2007 have been gathered and more than 220 pdf documents created. The available data is described in the Chapters as appropriate, and a brief overview is given in the data section.

From the historical documents, several viable datasets have been extracted, entered in a digital format and transformed into workable spreadsheets. To date, there are more than 2200 workable datasets with a standardized database incorporating all gear information, 2 for the evolutions of the trawling fleets, 1 for the total demersal biomass LPUE and 3 for individual species. Experimental trawl survey data has been collected and analyzed to some extent but is not included here.

1.3.2 Landings and Fishing effort data

In Italy, since 1863, the Istituto di Statistica Italiano (ISTAT) has been collecting data on fishing fleets with the resolution of maritime district, number of boats, GRT, HP, number of fishermen, fishing areas and targets (fish, coral, sponge) when fishing abroad [1][73]. Since 1953, fleet statistics improved and now include age, type of vessel, gear specifics such as freezing capacity, radar and other acoustic devices [74]. For the same period fish landings are reported monthly by region and maritime district for approximately 40 species/groupings. In addition, several reports scattered in time provide detailed effort and landing data for specific areas [10, 63, 75, 76, 6, 16, 77, 78, 79, 80, 81, 82, 83, 84, 85, 86]

French fleet statistics exist since the late 20th century, but are available with large temporal gaps since 1908 by maritime district. These report number, tonnage, HP of the fishing vessels, plus number of fishermen [87, 88]. The same documents report landing statistics by maritime district and year for 55 species/groupings. The series are currently incomplete. Additional reports with higher resolution are available [3, 89, 90, 29, 4, 91, 92, 93, 94]

In Spain, an extensive effort to build a landings and effort database has been carried out by Alegret and Garrido [95]. The resulting database is a product of the collection, systematisation and digitization of statistics published between 1831 and 1984 in the Official Spanish Fisheries Yearbooks from the coast of Catalonia. Additional data exist for other parts of Spain or with different resolution [57, 12, 96, 97, 98]

Some landing and effort data are available for Tunisia over the period 1930-1970 [99, 21, 100]

1.3.3 LPUE data

In 1966 F. Doumenge published his PhD dissertation on the trawl fisheries in the Mediterranean [8]. This fundamental document reports detailed commercial CPUE data gathered from logbooks, rather than official statistics, from different ports in Catalonia, France, Sardinia and the Adriatic during the period 1948-62. Daily or monthly catch per vessel are reported over several years with species aggregated in 5-6 categories and with details on each vessel. A total of 30,000 fishing trips have been monitored in this research and data is available in more or less aggregated tables.

Bas [57] has been monitoring trawlers landing in the ports of Barcelona and Blanes (Catalonia) over the periods 1956-1965 and 1988-2000. Detailed data are reported concerning vessel specifications (GRT, HP, Length, Year of construction, Fishing days) and species landings (15 species/groups) per fishing day.

For the Sicilian Channel there are CPUEs from commercial scouting for the period 1930-1980 [58, 101, 6, 102, 103, 104, 21].

Throughout the Chapters many other sources of data will be described and cited.

CHAPTER 2

HISTORICAL EVOLUTION OF BOTTOM TRAWL GEAR IN THE MEDITERRANEAN SEA

2.1 Introduction

Understanding the duration and the intensity of human exploitation of demersal marine resources is important in identifying when the resources were in a virgin and unexploited state. The temporal development and improvement of demersal fishing technology has several implications for the estimation of fishing effort as well as fishing power. In order to reconstruct trawl fisheries evolution in the Mediterranean Sea information on gear construction and development over time and on fishermen's harvesting strategies and behavior must be assessed. This type of information is the fundamental background needed to contextualize catch rates and fish landing statistics, data that will be analyzed in later chapters. Ultimately, this is the information needed to understand and estimate fishing effort and potential.

Chapter One will describe changes to trawl gear over the past 400 years in Spain, France and Italy, as well as construction of gear performance estimates across time, number of fishing days, and the depths at which fishing occurred. The chapter is divided into two parts: 1) details of trawl rigs and operation over different time periods and 2) simulation and comparison of gear performance. Historical records describing gear evolution are often inaccessible. The original documents used here are in Italian, French, Spanish and Catalan. Original sources were translated and summarized with as much detail as possible. Additionally, since most historical measurements were not in the International Metric System all units have been reported in the original unit and the converted unit (conversion tables are found in Appendix 1). For the sake of clarity, the terminology describing different trawl parts has been kept in the original language, accompanied by translation.

These editorial choices were made to provide an explicit account of how terminology was interpreted, given the challenges of interpreting old descriptions, and to allow referral to the original references. While this can be tedious for the general reader, it is a valuable resource for researchers with an interest in fishing gear. Trawl gear is described in chronological order and by geographic area with the broadest coverage possible in Italy, France and Spain. Summary statistics of trawl measures and technical specifications are used to analyze and derive broad patterns and dimensional correlations between vessels, trawl nets, and rigging.

In the 14th century, trawlers consisted of single-sail vessels that towed a net while drifting sideways. These trawlers operated between 1600 and the early 1800s, depending on the area, but were displaced by more efficient pair sail trawlers in most areas of the Northwest Mediterranean by the 18th century. In the beginning of the 20th century steam, sail and motor trawlers competed on fishing grounds, with motor trawlers emerging as the winners by the 1930s. Motor trawl fishing and fishing technology expanded rapidly after the Second World War. Vessel engine power increased in the 1960s, at the same time as fishermen began switching from natural fibers to synthetic nets. In the 1980s, trawl nets with high vertical openings emerged, and most recently, double net rigging has become commonplace on trawlers in the Mediterranean. The latter part of Chapter One investigates the implications of gear change over time based on physical performance parameters, exploring the relationship between vessel engine power, net material and effort (i.e. the area a trawl can sweep when towed, over time). We show that, on average, the adoption of synthetic nets and modern rigging has increased the wing spread 2.3 times. This relationship is useful to describe, quantify and correct in later analyses the effect of fishing gear improvement when long time-series of trawl data are used to infer stock abundance.

2.2 Sail trawling 1200-1930

In the Mediterranean basin, it is difficult to precisely date the origin of trawl fisheries and intensive exploitation of demersal fish. However, using descriptive references and legislative documents we can generate a time-line of trawling development over the past

centuries. Harvesters were fishing with beach seines during Roman times and this gear continued to be used from Medieval times until recently [105]. Beach seining was the most simple trawl fishery and at an unknown time evolved into nets towed by a sail boat. The first accounts of such gear, called *gangui* (in France) or *tartana* (in Italy) date back to the 14th century [106, p.214], although similar configurations might previously have been used. De Nicolò [106, p.214] reports a protest in 1337 against fishermen using a gear called *tartana*, claiming that it had deleterious effects [107]. The *tartana* (single sail trawler deriving its name from the *tartana* type of vessel used) fishery, characterized by relatively large vessels trawling sideways, was common until the mid 19th century when it was progressively displaced by more efficient and less capital-intensive pair sail trawling. Pair trawling is believed to have begun in the 13th century in the lagoons of the Albufera of Valencia (Spain) [17]. Here, fishers towed a *ganguil* (a small trawl net) with two sail boats. The same technique was later used at sea in the Valencia area with more appropriate boats. There are several accounts of pair sail trawling in different areas of the Mediterranean beginning in the early 18th century, and this fishing method dominated and survived on most Northwestern Mediterranean trawling grounds until the onset of motorized trawling. Sáñez Reguart [108] provided the oldest and most detailed description of trawl gear in Spain in the 18th century, while Duhamel du Monceau (1768) [109] described all trawl gear of his time in France, including different types of Mediterranean sail trawlers.

2.2.1 French sailing trawl gear

Duhamel du Monceau (1768) [109] wrote one of the most extensive and comprehensive encyclopedias of all fishing techniques known in the late 18th century. Du Monceau [109, p.152], gave detailed descriptions of the three main demersal trawl gears based on different fishing areas in Mediterranean France. Translations of relevant parts of the original French text are in Appendix 1, while summary descriptions of the three trawl gears follow.

The *gangui* was a small trawl net towed by one sailboat. The nets horizontal opening extended about 5 m, with a vertical opening of about 1 m Figure 2-2,2-3. The total net length was a maximum of 20 m, and the lead weight could be as much as 50 kg. Du

Monceau did not give information on mesh size, but the warps were short, requiring that the gear be fished at depths less than 10-12 m. It is believed that this fishery operated during the day from small boats near shore. The *gangui-boeuf* gear differed from *gangui* in a variety of ways. To start, the net was towed by two sail trawlers in parallel, instead of just one (Figure 2-1). In addition, the net length was larger, ranging between 23-31 m with a mesh opening of 11-13 mm in the net body. Given the warp length (160 m), the maximum operating depth would not have exceeded 100 m. No detailed information is available on weights and floats for the *gangui-boeuf*, and although there is no specific information on the fishing strategy, it is assumed that this type of gear was used 24 hours a day [108]. Of all towed gears, Du Monceau argues that these nets were the most destructive to benthic habitats and to fish eggs and juveniles [109, p.155]. The *tartanne* was a gear towed by one large single trawler drifting sideways. Du Monceau's description of this gear was the lengthiest and he repeatedly mentioned that this gear was very old, most likely used long before 1768. The net overall length was between 20-23 m with a mesh opening that ranged between 3.7 cm in the wings to less than 2.2 cm in the cod-end. Like the *gangui-boeuf*, this gear operated day and night, at depths between 30 and 60 meters. However, the *tartanne* was typically used further offshore than other trawled gear (more than 4 Nm) Figure 2-4.

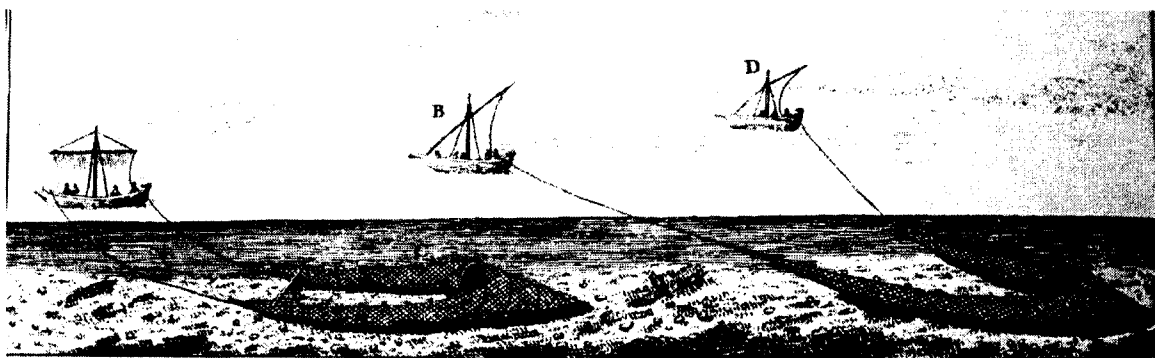

Figure 2-1. *Gangui* net (C) towed by single vessel and *Gangui-Boeuf*, where vessels (A,D) tow the *Gangui* net (from Du Monceau, 1769)

While Du Monceau gave extensive details on the different kinds of trawl gear and how they operated, he provided no information on the fishing fleet. Instead, Berthelot (1868) describes the French Mediterranean trawl fishery in terms of technical (gear and

Fig. 2.

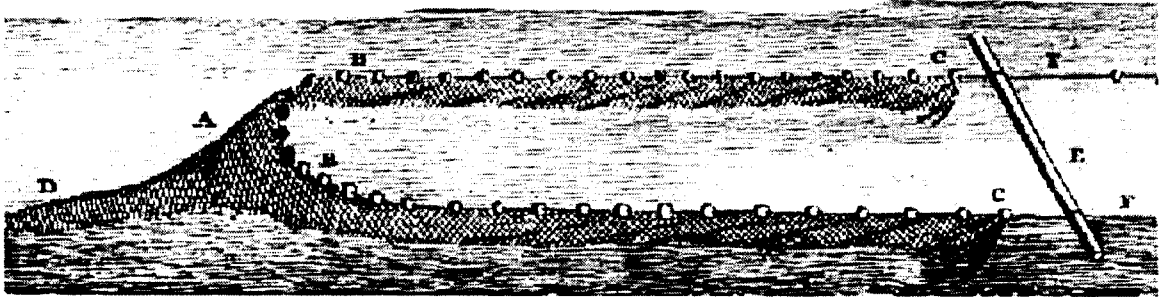

Figure 2-2. *Gangui* net towed by single vessel, net wings (C,B), *partequ* (E), net mouth (A), cod-end (D) (from Du Monceau, 1769)

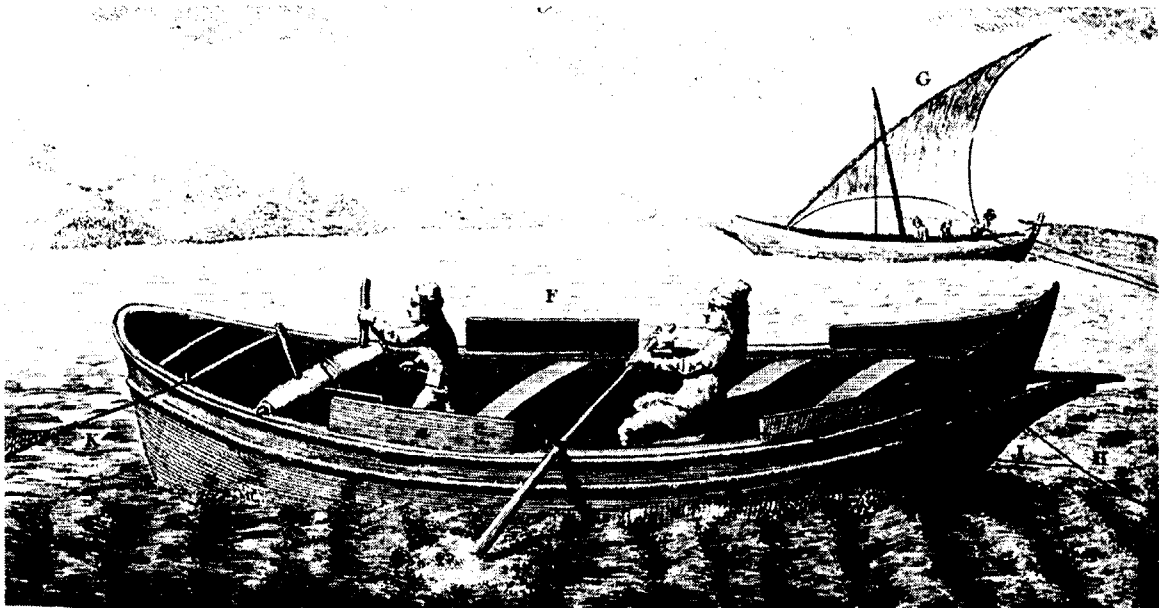

Figure 2-3. Boat rigging with *Gangui* (from Du Monceau, 1769)

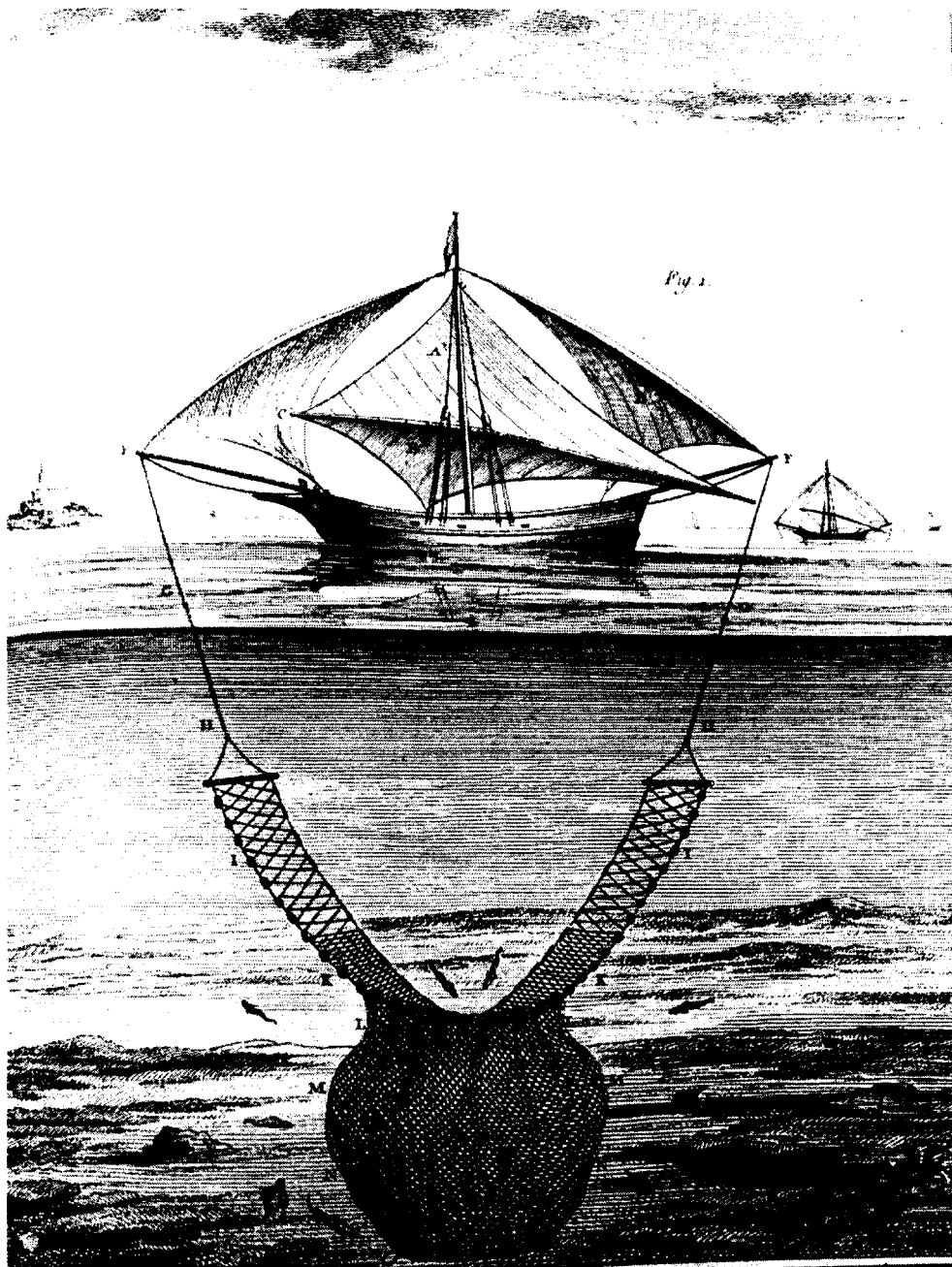

Figure 2-4. *Tartanne* rig (from Du Monceau 1769), (A) main sail *grand voile*, (B) sail called *tente*, (CD) staysail called *coutelas, trinquette*, (EF) poles *bouted-dehors, paux*, (GG) warps *halins, sartis* in (H) double (bridles), (I) net wings *ails* that precede the net body, (K) part of the wings where the mesh is smaller *enclestre*, (L) net mouth *margue*, (M) area where meshes are different *ségarié*, (N) cod-end *culaignon*

fishing fleet), legislative, and management perspectives [110, p.269-272]. He reconstructs the evolution of the trawl fishery in Mediterranean France up until 1868. In agreement with the accounts of Du Monceau, the *tartanne* (single sail trawler) was developed much earlier than the *gangui-boeuf* and was recognized as significantly impacting habitat and resources even by 1631, when its use was limited to certain times of the year [110, p.278].

It is unclear when trawling started in France, but likely much earlier than 1631, as in Spain it had already been developed. Berthelot dated the introduction of sail pair trawling (called *chalût aux boeufs* or *gangui bouef*) in the Gulf of Lion at around 1720, and argued that it arrived from Catalonia. Despite controversy with small scale fisherman and legislative interruptions, the *gangui bouef* technique has persisted and expanded over time. This, argues Berthelot, was because it was highly profitable and the shallow depths and soft sediments of the continental shelf were ideal for trawling.

The fisherman of Saint-Laurent de la Salenque were the first to use the *chalut boeuf* in France in 1720. In the port of Sète, twin pair trawling started in 1786 with vessels of 10-12 tons. By 1818 the boats had grown to 20-25 tons and continued to grow to even larger tonnages [110, p.271]. Fishing operations started in front of the port in 24 *brasse* (39 m) of water out to 5 Nm. Fishing was allowed year around except from April to June when fishing grounds were closed to protect juveniles (Law of 15 April 1791 on trawling in Languedoc-Roussillon). Each *gangui* net used with pair trawling in Sète in 1868 had 8 *brasse* (13 m) long wings and net body, for a total length of 26 m. The net mouth opening is estimated at 11 *pieds* (3.5 m). The *verveux* () was placed in the net body where the body started to restrict and was 2 *pieds* (36.6 cm) in diameter. The net bottom was tied to a long rope (1 *ligue*) that floated to the surface to indicate net position. The wing meshes were 18 *lignes en carré* (4 cm, mesh opening (MO)=8 cm) and decreased toward the net mouth. From the net mouth to the *verveux* the meshes further decreased in size all the way to the cod end. Fifteen *livres* (7.5 kg) of lead were attached to the foot-rope under the net mouth and wings. In 1868 on the coast of the Languedoc and Roussillon regions (Western part of Gulf of Lion), twin trawlers (*chalut aux boeufs*) were used that had a much larger *gangui* net than those found in Marseille. This *gangui* net was 20 *brasse* (32 m) long, including the

wings and the net body (*poche*) which alone was long 3.5 *brasses* (5.6 m). The meshes of the net body were 9 *lignes en carré* (2.0 cm, MO=4.0) at the end, 11 *lignes en carré* (2.5 cm, MO=5 cm) in the middle, 6.5 *lignes en carré* (1.5 cm, MO=3 cm) on the bottom, and 18 *lignes en carré* (4 cm, MO=8 cm) in the upper section near the wings. Five hundred *brasse* (800 m) of rope was used to tow a net made of 75% hemp and 25% *sparterie* (Esparto, or esparto grass, *Macrochloa tenacissima* and *Stipa tenacissima*, from <http://en.wikipedia.org/wiki/Esparto>). Pair trawlers reportedly towed at three knots and [110, p.268], according to Marion [33, p.99], in 1883 pair trawlers near Marseille could fish to depths of 150-200 meters.

2.2.2 Spanish sailing trawl gear

Inspired by the detailed work of Du Monceau, Sáñez Reguart (1795) [108] provided similar descriptions of fishing gear in Spain. However, Reugart gave more details on the cutting rates and net meshes that allow a better reconstruction of the true net scheme and rigging. According to Sáñez Reguart, *parjellas de Bou* involved two sail vessels towing a net in parallel. The distance between the vessels ranged between 300-500 *brasses* (480-800 m), however as the vessels were connected by a line, this distance seems excessive (Du Monceau indicates for similar vessels 100 m). Fishers fished at depths up to 100 *brassas* (167 m) and hauls could last 2-10 *leguas* (8-40 km). Pair trawlers were followed by a smaller vessel that carried fish to port. Typically, fishing occurred during the day but would continue at night if the catch was scarce. In 1777, this fishery was authorized to operate only from October 10th until the week of Easter (6-7 months per year). The net, made of hemp and other natural fibers, had an overall length of approximately 30 m (23 m wings, 8 m net body and cod-end) with mesh sizes tapering from 10.2 cm, for one leg of the mesh in the wings, to 7.6 mm in the cod-end. The net was rigged with variable numbers of cork floats, and leads and the danlenos were 50 cm long, as in Figure 2-5.

Bas et al. give the following description of sail trawling. Traditional trawling in Catalonia consisted of two vessels jointly towing a net using the power of sails. This technique developed in the 17th century and was called *pareja de vela* (in Spanish) or *parella de vela* (in Catalan) (which means pair sail trawling) or *bou* (which means male ox) [12]. It seems that

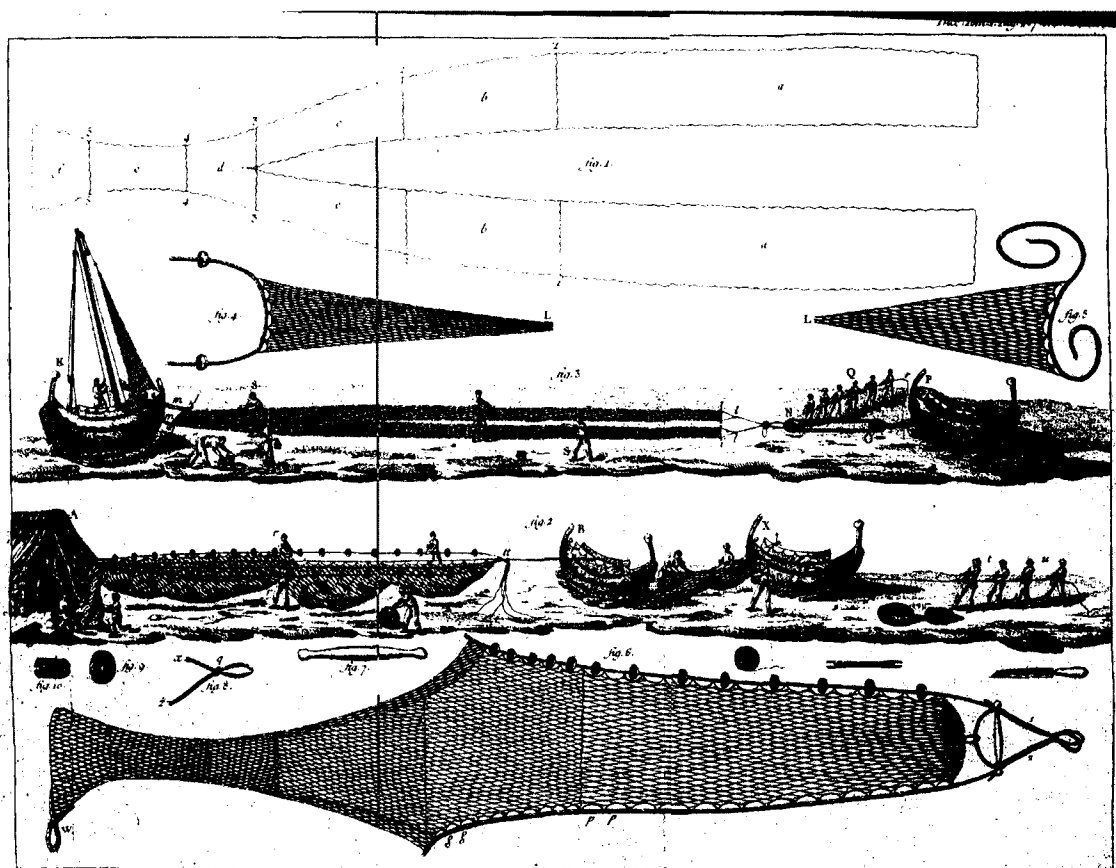

Figure 2-5. Construction and rigging of the net of a Spanish pair sail trawler according to drawings from Sáñez Reguart in 1795

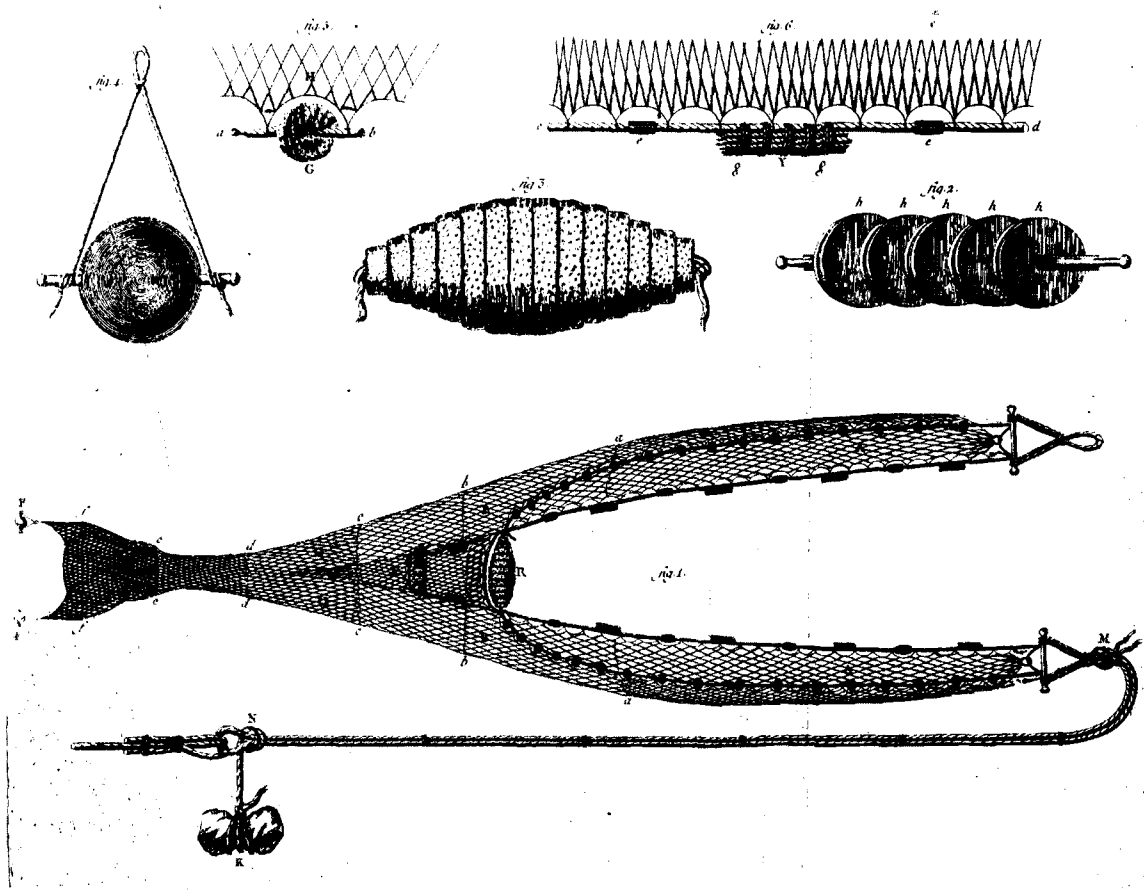

Figure 2-6. Details of Spanish pair sail trawler net rigging, according to Sáñez Reguart in 1795

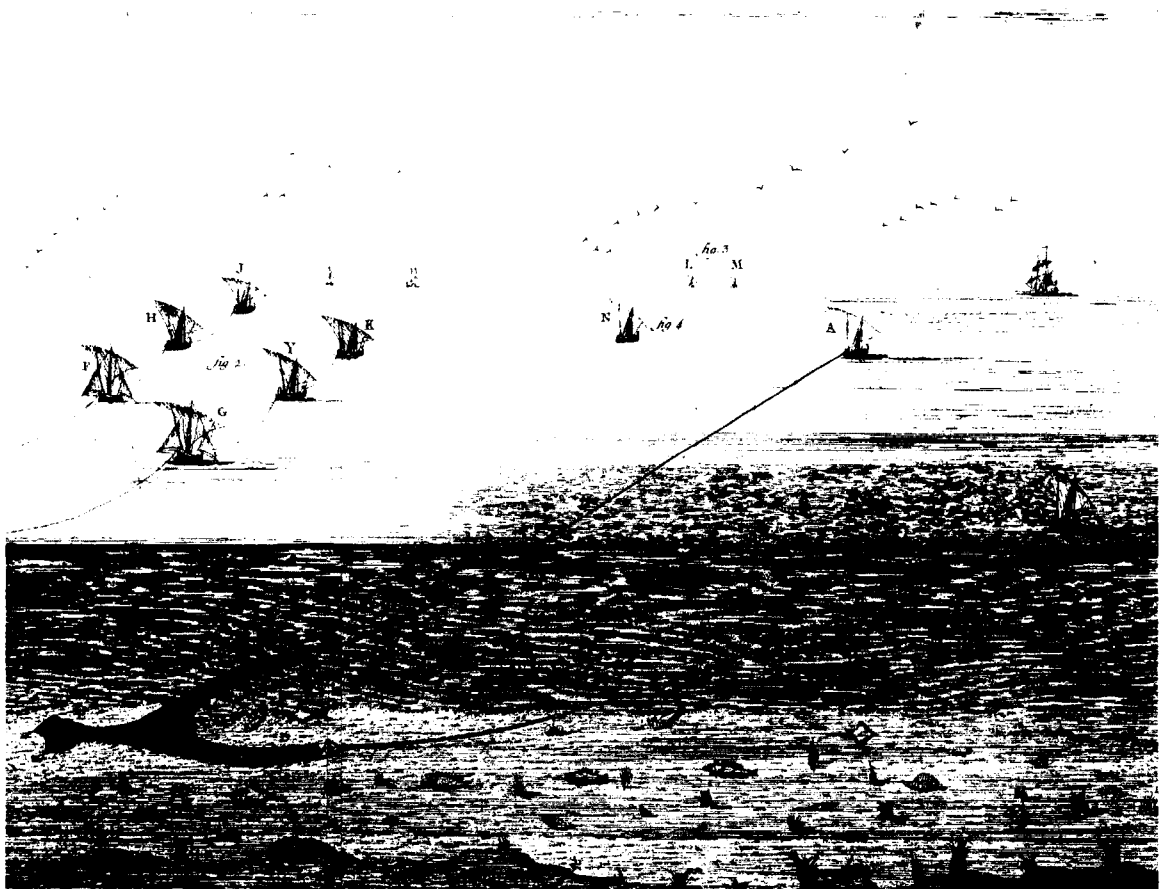

Figure 2-7. Operation of pair sail trawlers in Spain according to Sáñez Reguart in 1795

the name *bou* derived from the similarity of two oxen pulling a plow, or alternately from the latin word *bolus*, pulling nets [12, 105]. Two vessels towed one cable each that was connected to the wing ends. The boats themselves were connected with a rope that kept them 200-300 m apart. The boats were small (3-7 tons), with lateral removable dagger-boards so that they could be hauled on the beach. The structure of the net was that of a Catalan net described in the next paragraph. Fishing trips lasted one to three days and multiple tows where done each day.

2.2.3 Italian sailing trawl gear

The descriptions of trawl gear in Italy are not very detailed prior to 1800, with a few exceptions. The best available ones are from the Adriatic Sea in the 19th century. As of now, the oldest trawl gear descriptions for Italy date from 1800, but given the maritime exchange occurring within the Mediterranean and the sharing of fishing gear technology previously described [106, 109, 110], it is very likely that Italian trawl gear was similar to that found in France and Spain.

Coccoluto Ferrigni [9, p.34] summarized the scheme and main features of the standard and common *paranzella* net used in Tuscan waters in 1866 (Figure 2-8). Net size was reconstructed from the net scheme, however it is not clear for what tonnage vessel the net in that scheme was built. Total net length was approximately 54 m, while the wings were 21 m and the net body 33 m. Mesh openings are given as the length of one side of the mesh. According to this scheme, the openings are 6 cm per side (MO=12 cm) on the *stazze* (wings), 2 cm (MO=4 cm) on the *petto*, 1.8 cm (MO=3.6 cm) on the *sottogole* (net belly near wings), 1.7 cm (3.4 cm) on the *cannone* (net belly before cod-end), and 1.6 cm (MO=3.2 cm) on the *sacco* (cod-end). The diameter of the hemp twine used for the net webbing from the wings to the cod-end is, respectively, 1 mm, 0.9 mm, 0.9-1 mm, 1-1.5 mm and 1.5-3 mm. *paranzella* vessels of 40-50 tons would have towed a net with between 500 and 700 meshes, presumably at the net mouth, while smaller boats would have had nets with 300-500 meshes [9]. Ferrigni (1866) does not specify what was meant by the number of meshes. The *lima* (foot rope) of approximately 40 m (made of esparto and with 5 cm diameter) carried an unde-

fined amount of lead weight [9, p.64]. The hemp *corticiale* (float line) had circular floats of cork [9, p.64] and the wing ends were connected to a strong esparto fiber rope, which was connected to hemp warps 800 to 1000 m long [9, p.34].

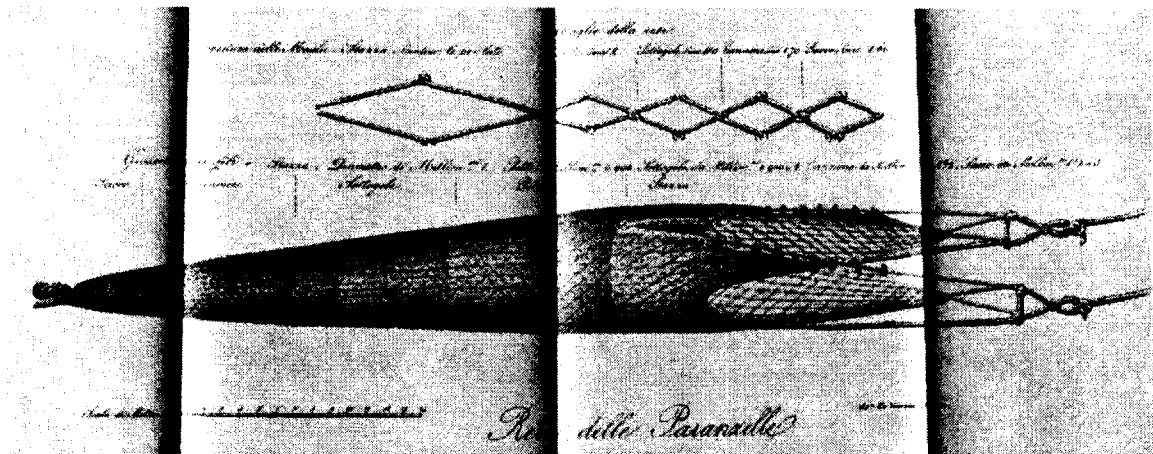

Figure 2-8. Net scheme of a *paranzella* (pair sail trawler) from Tuscany in 1866, according to Coccoluto Ferrigni [9]

Faber [10, p.118] detailed the different trawl rigs used in the Adriatic Sea in 1880, although the nets were described in a generic way. He reported measures in English units, we display original units and convert to the International Metric System. (1 foot=0.3048 m; 1 fathom=1.85 m). The *bragozzo* or *schiletto*, according to Faber, was a typical pair sail trawler from Chioggia (North Adriatic, Italy). It was a fore and aft-decked boat [10, p.118] with two masts, the foremast and sail being smaller than the main. The bottom was flat with a rudder extending well beyond the bottom. The average length was 30-40 feet (9-12 m) and 6-10 tons, and the vessel operated with a crew of 4-5 men [10, p.101]. The *bragozzi* had the capability of sailing and fishing in high winds due to the deep rudder that enhanced stability. The *cocchia* net was typically pair towed Figure 2-9 [10, p.118], with the *cocchia* connected with warps (called *alzana*) of 40-50 fathoms (72-90 m). These vessels operated in 20-50 fathoms (36-90 m) over sandy and muddy bottoms during the day and rocky bottoms at night. The net had a bag (called *sacco* or *panza*) with a conical shape that measured 5-6 fathoms (9-11 m) across at the opening [it is unclear if this is the wing-tip distance] and progressively tapered to a diameter of 8-10 feet (2.4-3 m), where the funnel

started. The funnel was kept open by wooden hoops (*cerchietti*) of 5 feet (1.5 m) diameter, and ended in the cod-end. The funnel and cod-end (called *cògolo*) were 6 fathoms (11 m) long, half of the bag total length (22 m). The *cògolo* was enclosed in a second net with stronger twine to protect it from bottom abrasion and damage from dolphins. The wings were 30 fathoms (55 m) long, with a vertical height of 10 feet (3 m) at the tips, which increased to 20 feet (6 m) at the beginning of the bag. Faber reported the meshes of the bag as being 1.5-2 c., which presumably meant centimeters, but it is not clear how this was measured. The net body was made of hemp.

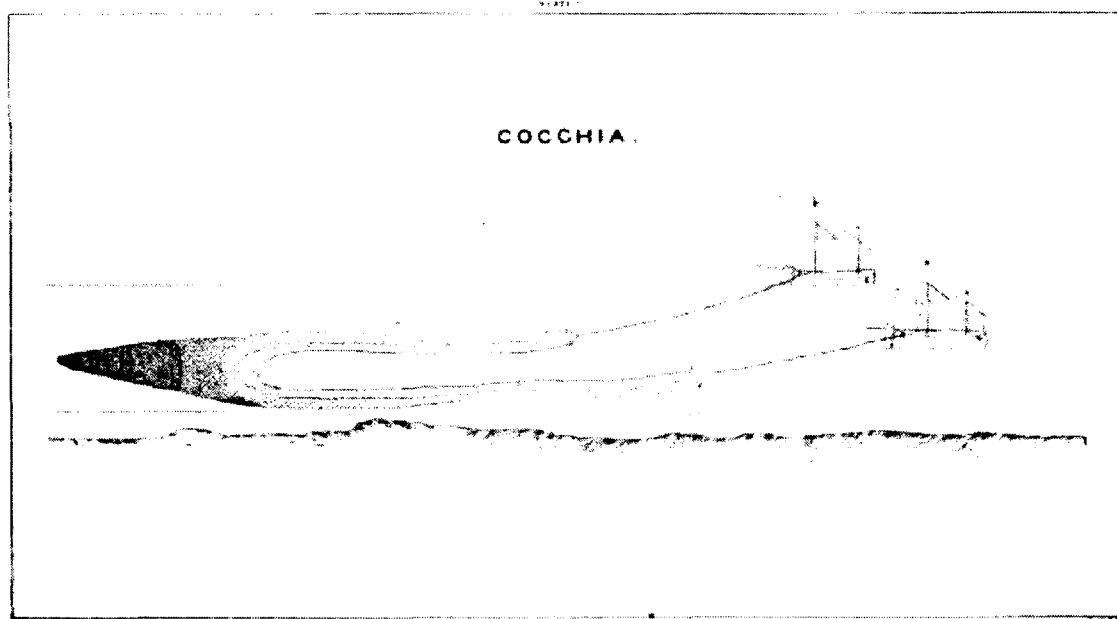

Figure 2-9. Scheme of *Bragozzi* pair trawling with a *cocchia* net, from Faber 1882 [10, p.118].

According to Faber, the *tartana* (single sail trawler) was used much less frequently in Chioggia after 1883. These trawlers originated in Southern Italy and were much more common in Sicily and Naples. The vessel was 60-100 feet (18-30 m) long and 10-15 tons, with more beam than a *bragozzo*. The rig was made of one mast with a larger lateen sail, a driver, and a jib. The *tartana* trawled alone and used two long spars (called *spontieri*) that extended from the bow and stern while the vessel drifted broadside to maximize the swept area. The *tartana* net, composed of a net body (*sacco*) and a *cògolo* [10, p.119], was smaller

than the *cocchia*. It was used by Chioggia fishermen for fish groundfish in 15 fathoms (27 m) and had a length of 12 m.

In 1911 Ferretti [16, p.95-98] described the *tartana grande* used in Fano (Central Adriatic, Italy) in detail. The net, formed by a body and two wings, was used by two boats (*barchetti*) trawling together (Figure 2-10). The mesh in the wings was 16 cm^2 and upper (called *carione da scorzo*) and lower triangular pieces (*carione da piombo*) of fine mesh enhanced the wing spread. The head rope (*lima da scorzo*) carried corks that progressively increased in frequency from the wing tips to the net opening. The ground rope carried leads, and the wings had four pieces of oak wood (called *rugoli*), 4-5 kg each, that prevented them from being torn by the sea bottom. The net bag was divided into three parts, as can be visualized in Figure 2-10: *Armatura* and *Gole*, the initial parts of the net bag, were made of webbing with a surface of 3.5 cm^2 . These were covered by another webbing called *tassello* with meshes of 6 cm^2 of surface area meant to protect the net from bottom abrasion. Above the *armatura* and *gole*, more webbing (called *cerbarina*) with meshes of 20 cm^2 of surface area and, on top of this, a third one called *delfinera*, were meant to protect the net from dolphin predation. The *delfinera* was made of strong twine and formed meshes of $50\text{-}60 \text{ cm}^2$. The *Manica* (cod-end) was the last part of the net, made of fine meshes (2 cm^2 surface area) and covered by the *cerbera*, with meshes of 30 cm^2 . The wings were connected to the trawler by four distinct cables: 30 m of hemp cable of 16 mm diameter; 60 m of manila cable of 110 mm diameter; 200 m of manila cable of 80 mm diameter; and 500 m of tarred hemp cable of 80 mm diameter. The manila cables had *rugoli* (pieces of oak wood) attached every 6 m to prevent the warps from getting entangled in rocks. The total weight of the trawl gear was 1,204 kg, the overall length (wing tip to cod end) 43 m, the wings 22 m, and the net bag 21 m. The distance between the pair trawlers was approximately 125 m and the net was hauled every 2 hours. The catch ranged between a few kilograms to multiple *quintali* (1 *quintale*=100 kg). The *barchetti* of Fano fished all year and moved to the Eastern Adriatic to fish for 6 months (December to April) 20. From here, daily market shipments were organized.

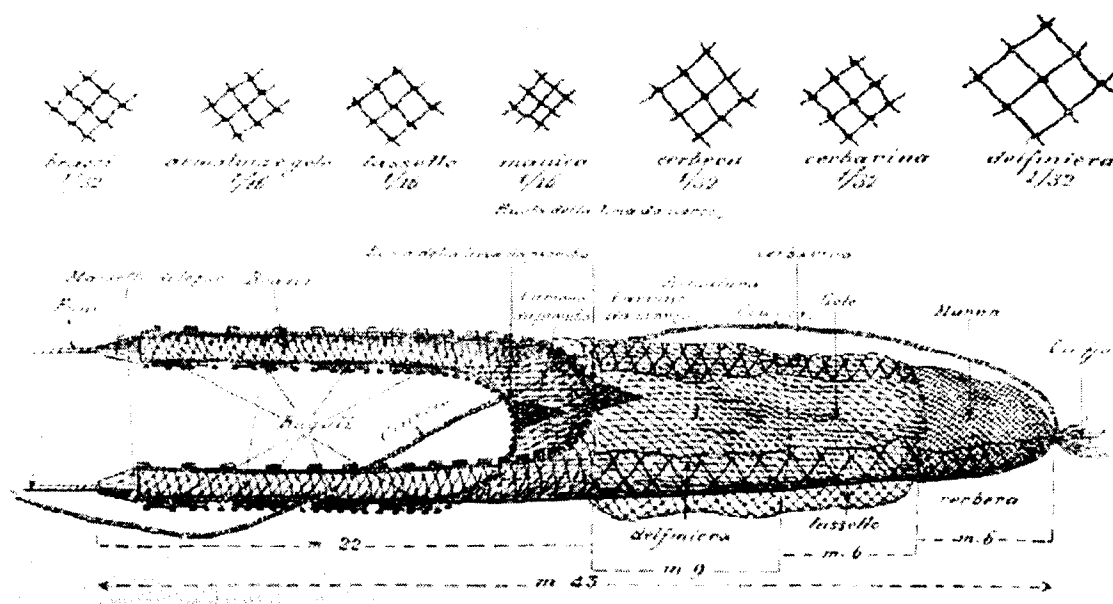

Figure 2-10. Scheme of a *Tartana Grande* (pair sail trawling) net used in Fano (Italy) (from Ferretti, 1911)

The *Tartana Mezzena*, as described by Ferretti [16, p.100] was a smaller trawl net used in Fano (Central Adriatic, Italy). It had the same shape of the *tartana grande* but was smaller. The total length was 38.7 m, wing length 19.8 m, *armatura* 8.1 m, *gale* 5.4 m and the cod-end 5.4 m. The *sfogliera* (beam-trawl) was very common in the Adriatic [16, p.100-101]. These were used at night as an alternative to the *tartana* and could produce good yields, between 10-25 kg to 60-85 kg, and occasionally exceeding 100 kg. Ferretti gave a detailed description of the trawl fishery in Fano (Central Adriatic, Italy) in 1911 [16]. The fishing area, between Ancona and Rimini and across the Adriatic all the way to Dalmatia (Croatia today), did not exceed depths of 100m. Steam time to the fishing grounds could be up to 6-7 hours for a distance of approximately 75 nm. In Fano there were two types of sail trawlers: the *barchetto* (also called *trabaccolo* equivalent to a *bragozzo*) with two masts; and the *battello* (also called *tartana*) with only one (3-4 tons). The *barchetti* ranged between 6-30 tons, but *barchetti* since 1890 were larger. There were 3 categories of *barchetti*:

1. Small, 6-10 tons, 8-10 m long and 3-3.30 m wide. These were mainly used with beam trawls.

2. Medium, 10-20 tons, 14-15 m long and 4.80-5m wide. These were used with beam trawls or trawled in pair with a medium *tartana*.
3. Large, 15-17 meters long, and 5.30 m wide. These vessels were mainly used for pair trawling with the large *tartana*.

The *barchetti* were supported by a *batelott* that made daily or twice daily trips to shore to land catch and get supplies for the vessel. The *batelott* were 2.5-3 tons with one mast and a two-person crew. Around 1900, fishers in Fano switched from snow to locally produced ice to preserve the catch [16, p.178].

2.3 The transition from sailing to mechanized trawling 1900-1950

Sailing trawlers, single or in pairs, were the dominant trawl technology for several centuries in the Northwest Mediterranean. The period between 1880 and 1940 represented the time with the largest overlap and development of different trawl gear. At this same time, large steam trawlers, the last remaining single sail trawlers, many sail pair trawlers and the newest modern otter trawlers were all operating together. The overlap in quantitative terms is analyzed in the next chapter; here gear differences will be discussed in chronological order with less emphasis on geographical differences.

2.3.1 Steam Trawling

Steam engines were first used on boats in the early 1800s. The first attempts to power fishing vessels were made in the Atlantic Ocean in 1838 using paddle wheels instead of propellers [105]. The Arcachon (France) Société des Pêcheries de l'Océan first built steam fishing vessels with propellers in 1865, but these first attempts were not financially successful. This changed in 1879 with the success of the vessel *Eurvin*, an iron boat of 167 tonnes built in Boulogne (France). This was the beginning of steam fishing. These methods and technologies were soon applied to trawling elsewhere in France and in England, and later on in other nations. In 1884 the first steam trawler was built in Germany and by 1906, 220 vessels were fishing from the same state [11]. The same year, England had 1721 steam

trawlers [11]. In the Atlantic Ocean steam trawling was extremely advantageous when compared to sail trawling, but despite initial strong resistance, it quickly won favour due to higher yields and crew share/compensation [105]. In contrast, steam trawling in the Mediterranean had a relatively short life. One of the first accounts was from Marseille (France) in 1890, where [29, p.23] four steam trawlers (*Plutus*, *Thémis*, *le Grondin* and *le Turbot*) fished in the waters off Algiers and Bona (Algeria) and shipped frozen fish to France. Similar shipments were made from Tunisia. The first steam fishing expeditions were made with the steam trawler *Conero* in Ancona (Adriatic Sea, Italy) in 1913 [11]. The *Conero* was built in Leith (England) in 1886, with an iron hull 24 m long, measured at 68.04 tonnes. It was later purchased by Mr. Malucci of Ancona in 1912. These trips were sponsored by the Italian Ministry of Agriculture, Industry and Commerce and by the Fishing Cooperative of Ancona. The *Conero* had a double rigging with *caprasfogie* (beam trawls) and with a *tartana* net used for sail pair trawling. While the use of beam-trawls was successful, the *tartana* was not as it was first rigged without otter boards and the lack of wingspread negatively affected catches. An attempt to rig the net with otter boards attached them to the wing ends, as shown in Figure 2-11. However, these changes were not successful. The net sank in the mud and did not spreading properly.

The main issues with steam trawlers were large vessel size and high operating costs coupled with relatively low yields. This perhaps made them successful only in the initial phases of exploitation of virgin fishing grounds, but when resources started declining steam trawlers became inefficient and too costly. For the most part, motor trawlers with diesel or gasoline engines started appearing in the Mediterranean after World War I (WWI). An important difference between motor and steam trawlers was vessel size with the former the size of traditional sail trawlers and the latter being much larger.

2.3.2 Motorized trawl gear in Spain

In 1920, the first otter trawls appeared, and similar vessels remained in used into the 1950s [12]. They were initially towed by individual steam trawlers, then by diesel powered trawlers. The new trawlers, called *quillats*, were heavier (10-20 tonnes initially and up to

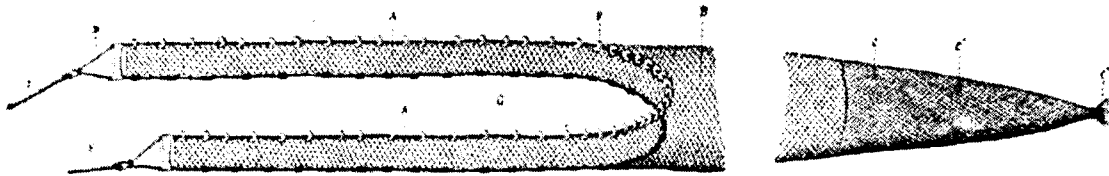

FIG. 2. - La Tartana

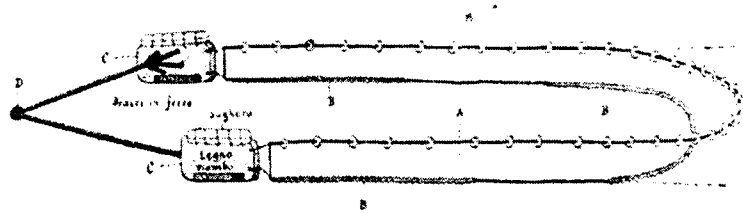

FIG. 3. -

Figure 2-11. *Tartana* net without otter boards (Fig.2) and the net rigged with otter boards (Fig.3) from the fishing experiments of the *Conero* steam trawler in Ancona, 1913 from Paolucci [11]

35-70 tonnes later) and had a sharper V-shaped hull that created more draft. For these reasons they could not be hauled onto beaches but instead required harbors. Bas [12] described in detail the trawl gear, generically called *bou*, used in Catalonia in the 1950s. The nets were traditionally made with hemp and the wings with cotton, but new material quickly emerged. The meshes decreased in size going from the wings to the cod end. The foot-rope (15-25 mm diameter) had 200 g lead weight and the head-rope (6-10 mm diameter) was lifted by 120mm diameter glass balls that replaced cork floats. Hemp nets needed to be dried after use to prevent rot. By the 1950s, the average trawler was between 10-40 tons in size and powered with a diesel engine between 20-200 HP. Crews generally averaged five members. Drums carrying net wire could hold 750-1500 m of 6-12 mm of wire. Two main types of trawl rigging were described by Bas [12, p.148]: Catalan and Italian rig.

2.3.2.1 Catalan rig

The Catalan rig described by Bas was a traditional local trawl net used on trawlers of 15-20 tons and between 60-100 HP, and also on vessels of less than 15 tons. This gear was heavier and more resistant than the Italian rig and more suitable for trawling at lower speed on rough grounds. Given the small meshes in the cod end, trawling resistance was considered higher than for the Italian rig. An average rig, shown in Figure 2-12, was 25 m long, with wings 10 m long and 120 meshes of 3.3 cm (6.6 cm MO); the net mouth (*cacarets*) was 3 m long and formed by two parts with 200 meshes each of 3.4 cm MO.

2.3.2.2 Charleston rig

The Charleston otter trawl was the improved version of traditional Catalan rig having as a main feature larger meshes in several parts of the net to reduce the drag resistance [12]. The *bandas* (net wings) were 10 m long with 120 meshes of 6 p/p and a hemp twine of 0.8 mm diameter. The *cacarets* (net mouth) was 3 m long with 200 meshes of 12 p/p and hemp twine of 0.8 mm diameter. The net body was 9 m long and formed by the *Goleró* (300 meshes, mesh of 16 p/p and hemp twine of 2 mm diameter), *Gairó* (3 p/p with 3 mm

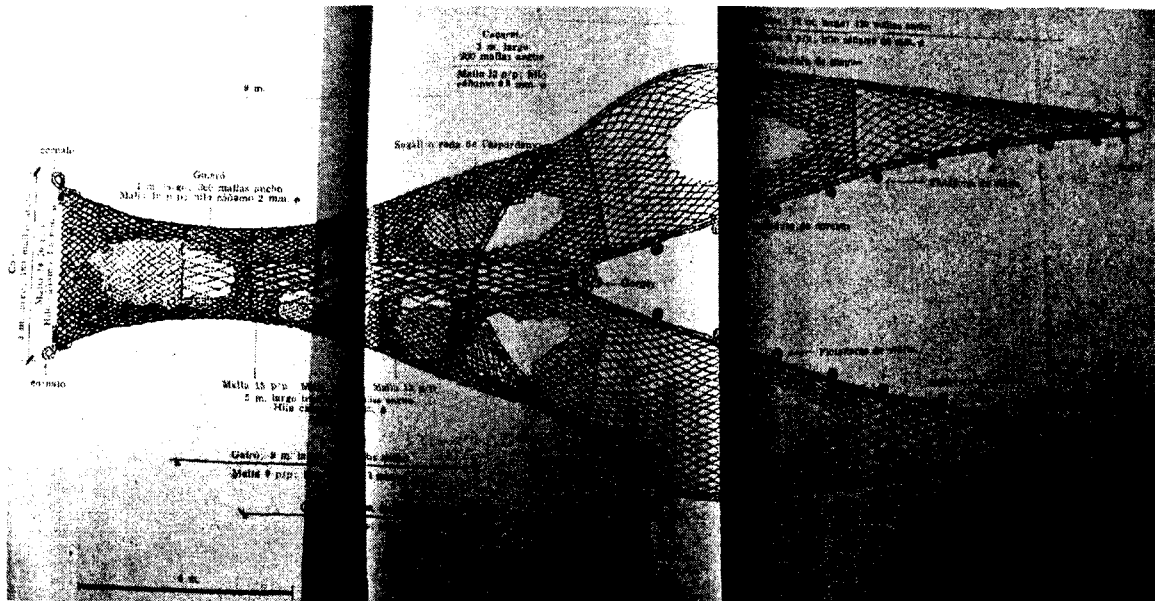

Figure 2-12. Net scheme of a traditional Catalan trawl net in use in Catalonia in 1950 according Bas et al. [12], for details see text.

hemp twine) and *Gaironet* (meshes of 7 p/p and 2 mm diam., hemp twine). Finally the *Cop* (cod end) was 3 m wide with 180 meshes of 14-16 p/p and 3-5 mm diameter hemp twine. For full net construction detail see Figure 2-12.

The ratio of wire to depth used for fishing was 3:1, meaning that, for fishing at 100m, 300m of wire needed to be shot. Therefore, the maximum fishing depth was 500m. Bridles were of hemp or other natural fiber and sometimes used mixed cables 20-30mm in diameter. The otter doors were made of wood reinforced with iron, 0.8 m high, 1.3 m long, and 2-3 cm wide.

Tows lasted several hours, with the larger boats making one tow per day. At the end of the tow, the bridles were hauled by hand, along with the cod end, unless it was too heavy. Tow speed was between 3-4 knots for large trawlers to a maximum of three knots for smaller ones. Trawling was allowed from sunrise to dawn, but in the spring, fishing grounds had to be between 3 and 6 nm from the coast to protect reproduction. The wire drums were connected directly to the engine, and, thus, had slow speed and power [12]. Since 1936 trawling was authorized from sunrise to dawn to control fishing effort, and

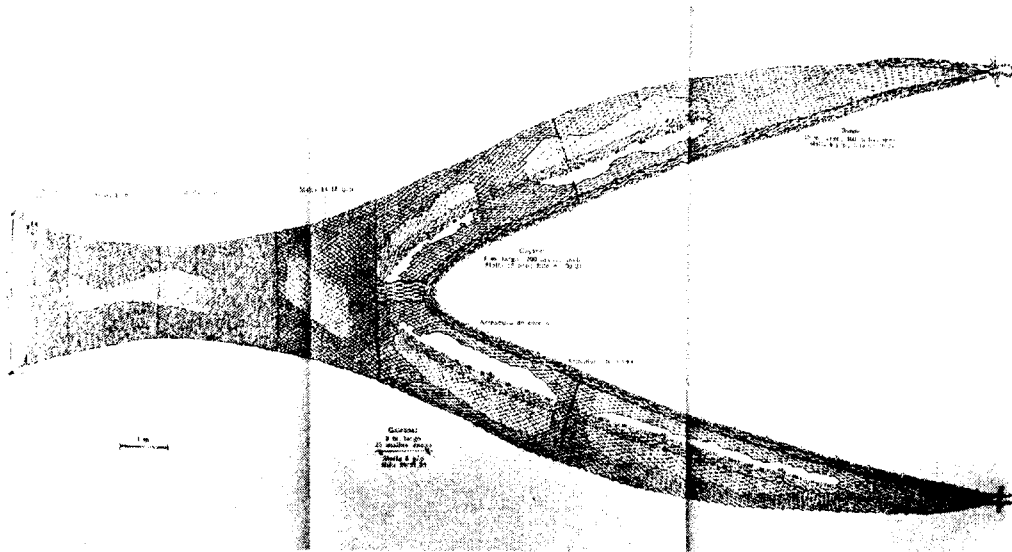

Figure 2-13. Net scheme of a Charleston rig in use on Catalonian trawlers in the 1950s, from Bas et al. [12]

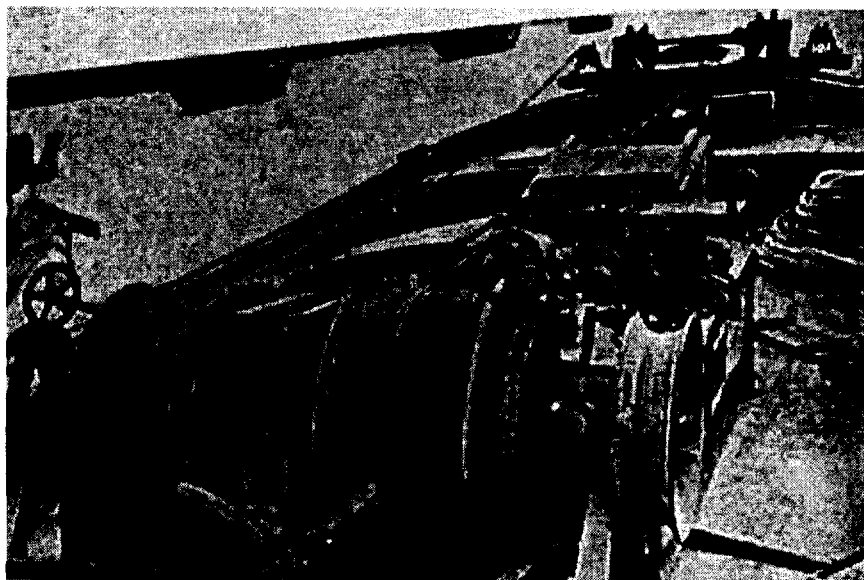

Figure 2-14. Drums and steel wire of a mechanical winch on a Catalonian trawler in the 1950s, from Bas et al. [12]

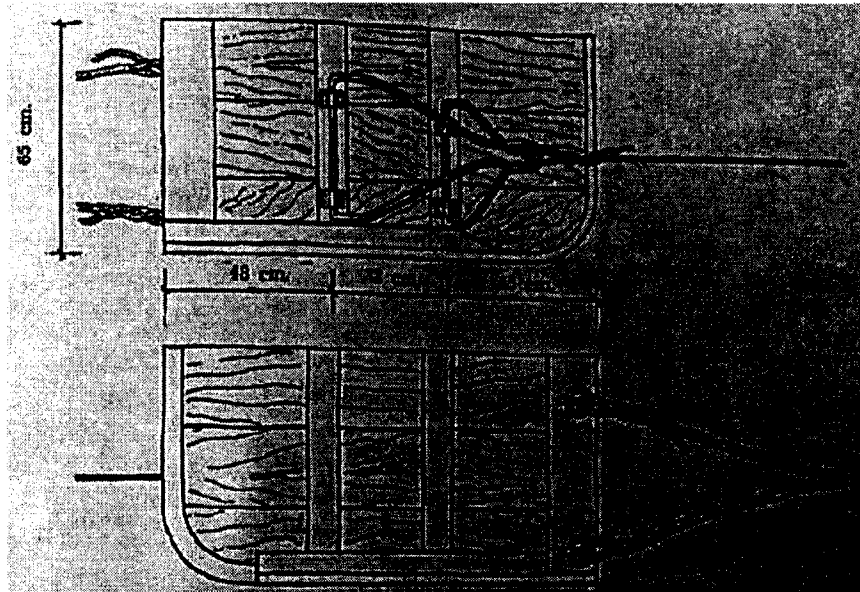

Figure 2-15. Otter doors of a 50-70 HP trawler in Catalonia in the 1950s from Bas et al. [12]

in spring the fishing grounds had to be between 3 and 6 nm from the coast to protect reproduction [12].

2.3.3 Motorized trawl gear in Italy

In Italy after WWI an increasing interest developed towards the industrialization and expansion of the fishing industry. Within the Royal Navy a special unit, called *Squadriglia Sperimentale di Pesca* (Experimental Fishing Unit), was formed in 1920 [111, p.97] and operated for about one decade in all Italian Seas [77, 112, 113, 114, 79, 81, 115, 55, 6, 116, 117]. The unit focused on describing overall fleets and fishing grounds, and on testing experimental gear such as otter-trawls, long-lines, motor trawlers and exploratory fishing. The information gathered by this unit provides effort and gear information for the decade 1920-1930. This very intense period in Italy, and likely in Spain and France, is one of major changes in the trawl fleet: assessments and experiments were made to determine the highest efficiency among sailing trawlers, steam trawlers and motor trawlers. The very first attempts to trawl with motor boats used two motorized boats towing in parallel like in traditional *paranza* sail trawling [111, p.117], but while yields were comparable to sail trawling costs were much higher. According to Mancini, before WWI fishing attempts made in Italy

with motorized otter-trawls were not financially successful. Further attempts started after WWI in the Tyrrhenian Sea also failed. Following experiments with the *Vedetta Sardegna*, a 350 tons military vessel rigged for fishing, Mancini drew the following conclusions [111, p.110]:

1. Trawlers with large tonnage are not well suited to work in coastal areas as yields were too low.
2. Fishing with otter-trawls would be successful if trawlers motorized with 60-80 HP had crews similar to traditional *paranza* sail trawlers.

In the trawling experiments Mancini discovered that a 40 HP trawler could not tow an ordinary *paranza* 600 mesh net. He suggested 70 HP for 600-700 mesh nets. Mancini supported his second point with examples of the motor trawlers *Folaga* and *Triglia*. The *Folaga* was a 120-150 HP steam trawler operating near Gaeta and the *Triglia* (built at the shipyard Lupi in Viareggio), with a 60-80 HP heavy oil engine, operated in Viareggio and Civitavecchia. Both used otter boards on their nets [111, p.112]. Interestingly, the first use of otter-trawls made in Italy employed large mesh hemp nets from the North Atlantic with the doors attached at the tips of the net wings and warps of steel Figure 2-16-2-17. Atlantic nets were returning very low yields and it was soon apparent that doors would improve the traditional Italian net. These doors, as in the rigging of the *Triglia* and *Folaga*, were attached indirectly to the net wings via bridles. The net (like the ones made in Naples or S. Benedetto del Tronto) was 400-500 mesh and rigged for a *bragozzo* (Adriatic pair sail trawler), which meant it was made of cotton, with small meshes and lighter rigging. At the wing tips *mazzette* (bridles) were attached, which were 8 m long and formed by 3 intertwined cables. Two of these were made of natural fibers 13 cm in diameter and one of hemp 10 cm in diameter. The *mazzetta* was attached to bridles that were 170 m of hemp cable between 6 and 10 cm in diameter. At the end of these bridles were attached the doors, strengthened with steel, 1.5 m long and 0.7 m high. The doors were connected to warps made of steel 4-5 cm in diameter. The warps are shot and hauled with mechanical drums [111, p.114].

Pasquini described the area of Ancona (Central Adriatic, Italy) as having the most advanced motorized trawl fleet in 1926 [79, p.32]. Here, the company *Enrico Giacobini* owned 4 former Norwegian military boats that had been reconverted to pair trawling. They fished January to June in the waters of Ancona and the rest of the year in Quarnero (Fiume at the time, Slovenia today). Each boat had a crew of 8-10 people. The company *Risorgimento* operated two wooden steam trawlers of 90 tons with 8-10 fishermen each. These trawlers fished permanently in Ancona waters and used *paranza* 800-1100 mesh nets from Chioggia. Alternatively, they used beam trawls of ordinary size. The trawlers operated in the area that extended north to Fano and south to the Conero, fishing mostly at night. Normally, one tow at 3 knots lasted for 20-25 nm.

During fishing experiments carried out in the Tuscan Archipelago (Tyrrhenian Sea) in 1919, Mancini [112] reported local fishing fleet characteristics along with average estimated yields. The trawl fleet fished at depths that ranged between 10 and 100 m, but mostly in deeper waters [112].

The operating fishing depth of motor trawlers in the Tuscan Archipelago did not exceed 200 m in the 1920s [118]. According to Iseel, quoted in [118], the Ligurian trawl fishery in 1930 was the first one to fish deeper than 300-400 m.

2.4 Modern trawl gear 1960-present

During WWII, the Mediterranean fishing fleet dramatically declined as many vessels were lost in military operations [3] or converted to minesweepers [56]. In Spain, however, fishing resumed after the Civil War in 1939 and continued through WWII [8]. Trawling slowly restarted after 1947, since prior to this many sea areas were still mined [34], and this became an opportunity for upgrading fishing gear and vessel equipment. In the 1950s vessels were larger on average than before WWII. However, the biggest gear improvements from pre-WWII technology started in the 1960s with the introduction of synthetic webbing, navigation equipment, and freezing capacity. Gear from the past 60 years is better known than sailing trawl gear, therefore, less emphasis on detailed descriptions that are geographically oriented is necessary. Several papers on trawl gear were published from 1959 onwards, coinciding with a more systematic study of trawl gear performance and improvements [56, 119, 120, 121, 122, 123, 15]. The main technical innovations from the past 60 years and their effects on fishing operations and efficiency will be summarized in this section.

2.4.1 Nets

The Italian type trawl was the most common type of net in Italy and other Mediterranean countries from the 1950s to the end of 1960s, France [4, 3], Spain [12], Israel [121, 122], Greece [14]. This net was characterized by a low vertical opening (0.9-1 m), and very good bottom contact at the groundropes and at the net body level. Bas (1955) and Ben-Yami (1963) [12, 122] provide good references for natural fiber nets and rigging from this period. An example of otter trawl nets used in the Adriatic can be found from the HVAR survey in 1948 in the former Yugoslavia [124, 34].

A more modern trawl net with synthetic webbing from 1967 is detailed in Bilio [125] and was used in the Ligurian Sea (Italy). The boat was a wooden trawler of 29 tons, 16.5 m long and equipped with a 80 HP Ansaldo engine. The nets were made of a combination of hand braided and machine made polyamide and polyethylene twine. The overall net length was 32 m and the cod end was made of 30 mesh of approximately 21-23 mm (for

full gear description see Figure 2-28 and the original source), with a headline of 26 m. The average wing spread ranged between 2.7 and 12.9 m. Bilio calculated the swept area of this type of trawler as being 0.24 km²/h fishing at 3.2 knots and at depths between 10-40 m. The trawler was equipped with a mechanical drum winch that took 1500 m of 9 mm steel cable and could fish to a maximum of 420 m. The bridles consisted of a sweepline and a mudrope. The mudrope was very heavy and 10m long, made of four ropes of a combination of steel wire and coco-fiber that were whipped together. Each individual rope had a diameter of 28 mm. The sweeplines ranged between 121 and 224 m and the ropes were of 16 mm diameter steel and manila combination. The otter boards (129 cm long and 69 cm high) were made of wooden boards strengthened with steel mountings. For a comprehensive description, Jukic (1975) drew fairly detailed otter trawl schemes of nets used in the Central Adriatic in the 1960s [126].

An average commercial net recently in use in the Central Adriatic (Italy) is characterized by polyamide knotless webbing. Detailed descriptions for the past three decades can be found in Fiorentini et al. [127] for the 1980s, Fiorentini et al. [128, 129, 130] for the 1990s, and for the most recent gear in Sala et al. [131, 132].

2.4.1.1 Vertical Opening

The vertical opening increased from 0.9 m on the traditional Mediterranean trawl to 3-6 m on current nets. Before WWII, it was already clear that increasing the otter trawl vertical opening would enhance the catches of semi-pelagic species [13]. Farina patented the first Mediterranean high vertical opening net in 1938 and called it *Rete Impero* (Imperial Net), likely after the Italian fascination for Imperialism. The development of the *Impero* net, however, was overshadowed by the war and although very innovative, especially in the rigging of its split net wings, as shown in Figure 2-17, it never entered the fishery. In Israel, similar attempts were carried out by Ben-Yami to increase the vertical opening around 1961-63 [121, 122] as well as in Malta [119]. It was not until the end of 1960s that the French research institute IFREMER started experimenting with high opening vertical trawls, called *Grande Ouverture Verticale* (GOV).

In the early 1970s, trawlers from Sète used the traditional Italian net, which was a two panel net with a low vertical opening (1 m). Until 1973 the majority of the vessels used this type of gear, with the exception of a few that used a two panel net with a vertical opening of 2-4 m [93, p.78]. At the same time the four panel high vertical opening net (4-6 m, or even 8-10 m for boats of 300-430 HP) was designed, developed and put into use by IFREMER of Nantes [93, p.78]. Two trawlers used high opening nets regularly in 1974 with excellent results, but others switched back to traditional nets because they were easier to use [3, p.30]. As previously mentioned, the use of high vertical opening nets had a major effect on the catch rate of pelagic and meso-pelagic species. Maupoint [4, p.124] estimated that between the period of 1970-73 and 1974-77 the catches of the following species increased relative to fishing effort: Sea Bream (*Diplodus vulgaris*) +533 %, European Mullet (*Mugil spp*) +152 %, Ghilthead Seabreams (*Sparus aurata*) +118 %, European Pilchard (*Sardina Pilchardus*) + 116 %, and Atlantic Mackerel (*Scomber scombrus*) + 24 %.

GOV nets appeared in Italy in the 1980s and are still commonly used in many areas in Italy, France, and Spain. Besides the four panel GOV, the vertical opening on modern trawl nets in general has increased to about 2 m. This increase in vertical opening has different implications: (1) the net fishes semi-pelagic and bathy-demersal species, in addition to targeted demersal species, thus expanding potential catches; and (2) the swept volume increases steeply with GOV nets.

2.4.1.2 Net resistance, color, less drag

Trawl nets have been built using natural fibers since the beginning of trawling, the most common being hemp. Cotton was used regularly in many fisheries until the mid 1960s [12, 14, 122]. One of the greatest improvements in trawl gear was the gradual introduction of synthetic filaments for the webbing of knotted and non-knotted nets [133, 122]. Klust [134] summarized the main advantages of synthetic nets:

Fibres of high quality provide reliability of operation. They enable a lighter netting yarn to be used and that means a reduction in the total mass of net. Lower mass facilitates handling during shooting and hauling operations, may reduce the bulk (storing), and eventually also the price. For the same breaking strength netting yarn made of strong fibers can be thinner than those made of

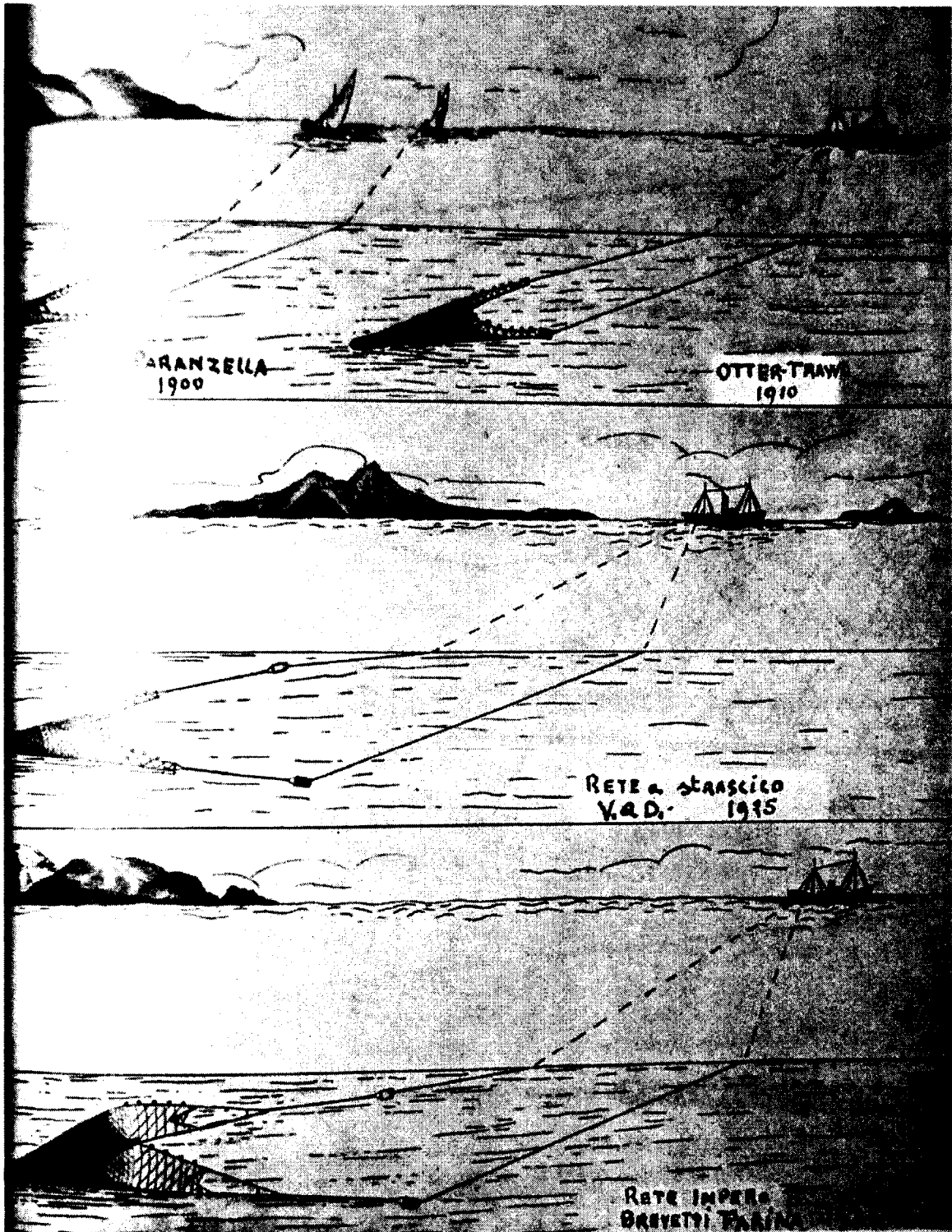

Figure 2-16. Scheme of the evolution of Mediterranean trawl fishing gear from 1700 to 1950, from Farina 1957 [13].

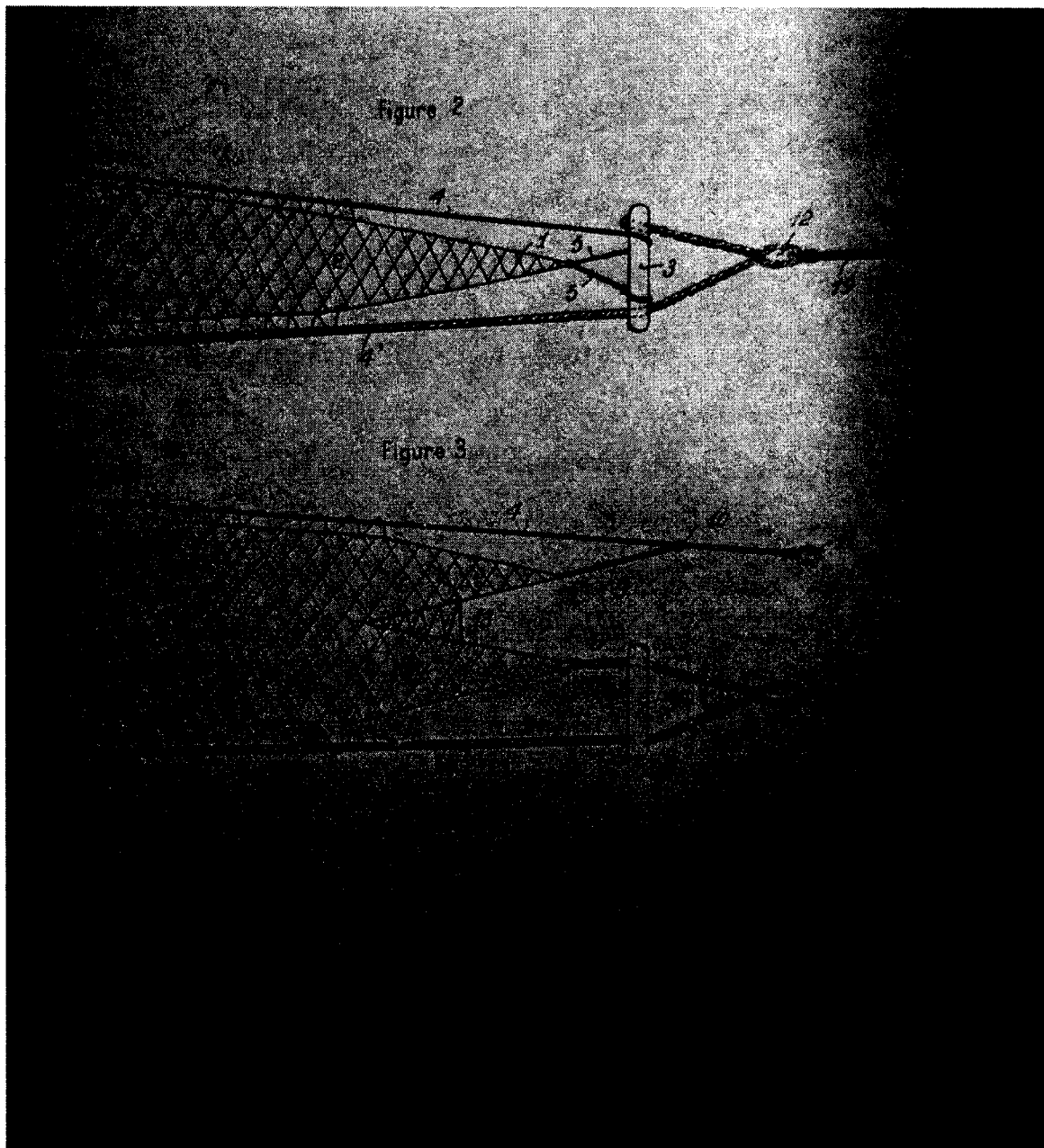

Figure 2-17. Split rigging of trawl wings to achieve higher vertical net opening, from Farina 1957 [13].

weaker fibers. The thinner the netting yarn, the lower the resistance to water flow. For trawl nets lower towing resistance allows either a reduction of towing power with consequent savings in fuel, or increased towing speed, or the use of a larger net by which the catching efficiency may be increased. Low water resistance usually means also reduced water stow and turbulence which makes the net less perceptible to fish. In general lighter nets fish better.

One important factor for gear handling on deck is the weight of the net. The switch from natural to synthetic fiber saw a major reduction in net weight, since the density of hemp is 1.40 g/cc, and cotton 1.54 g/cc, while polyamide (PA) is only 1.14 g/cc. Given the much higher breaking strength of the latter material, smaller twine can be used in synthetic nets with great weight savings. Net weights have decreased from 150 kg to approximately 30 kg thanks to the new webbing [122]. Additionally, synthetic material does not need to be tarred and dried, and this reduces labor as well.

Gear failure decreased with the switch of materials, and with the introduction of more advanced navigation equipment. Following fishermen interviews performed for the EVOMED project, it appears that gear failures were common in the 1950s, but today are very rare [14]. The chronology of the shift to synthetic materials has been area specific, with areas like GSA17 (Northern Adriatic) shifting to synthetics sooner than areas like Greece (GSA20+22), Figure 2-18. The precise timing of the introduction of each new gear is difficult to determine since the interviews took place over ranges, rather than specific years (i.e. 1940-1960, 1960-1980, 1980-present). For the sake of plotting, the midpoint of each interval is used. Thus, the percentage change allocated to 1950 could have happened in 1941 or in 1959. Unfortunately, higher temporal resolution is not possible.

One of the biggest advantages of synthetic nets is greater breaking resistance and flexibility than natural fiber filaments of equal diameter [135]. Operators can tow faster or larger nylon webbing nets, and drag resistance is further reduced when knotless meshes are used. In general, fishing vessel drag is 15-20% of the gear drag [127], significantly impacting the overall fuel consumption of vessels, and making it one of the parameters that any fishermen wants to minimize. For an average bottom trawler, of all gear components (trawl wire, doors, netting, floats and footrope gear), nearly 60% of total gear drag is gen-

erated by the netting [136]. In the early measurement of Italian trawl gear in 1959 [15] the net share of total drag was 68%. Reducing drag by switching net material and utilizing a better net design allowed an increase in net size and net opening, as explained in the next section.

2.4.2 Otter doors

Otter doors went from traditional flat wooden doors reinforced with iron to steel oval doors, and then to Oval Cambered, Slotted (polyvalent type) and Rectangular Vee Type, depending on the type of net and fishing. Overall, otter door area and weight have increased over time to maximize net wing spread and minimize drag resistance. Studies have been carried out over time that compare traditional doors with experimental doors [20, 137, 121, 127, 138].

2.4.3 Vessel rigging

Hull construction material has changed over time. Prior to 1950 all motor trawlers were wooden, followed by the introduction of steel hulls. Then in the 1970s, polyester hulls appeared in France [4]. Today all three materials are present, however geographical patterns are evident, with most newer vessels built in polyester in France and Spain, and steel hulls being the primary construction material in Italy.

Trawler engines have increased in power with the introduction of turbochargers, pitch propellers and nozzles. While in the 1950s the maximum engine size in the Mediterranean was 200-250 HP, in the past decade bottom trawlers have been equipped with engines exceeding 1000 HP [57]. Vessel HP and dimension are discussed in detail in the next Chapter.

Variable pitch propellers appeared on the first vessels in 1960, like on the Maltese trawler *Hannibal* [137], and in the 1970s in Sète (France) [93]. The advantage of variable pitch propellers is that towing force can be adjusted and maximized. As an example, a trawler with an engine having nominal Brake Horsepower (BHP) of 400, and equipped with a variable pitch propeller and nozzle, has an Apparent Nominal Pull (ANP) of 6 tons,

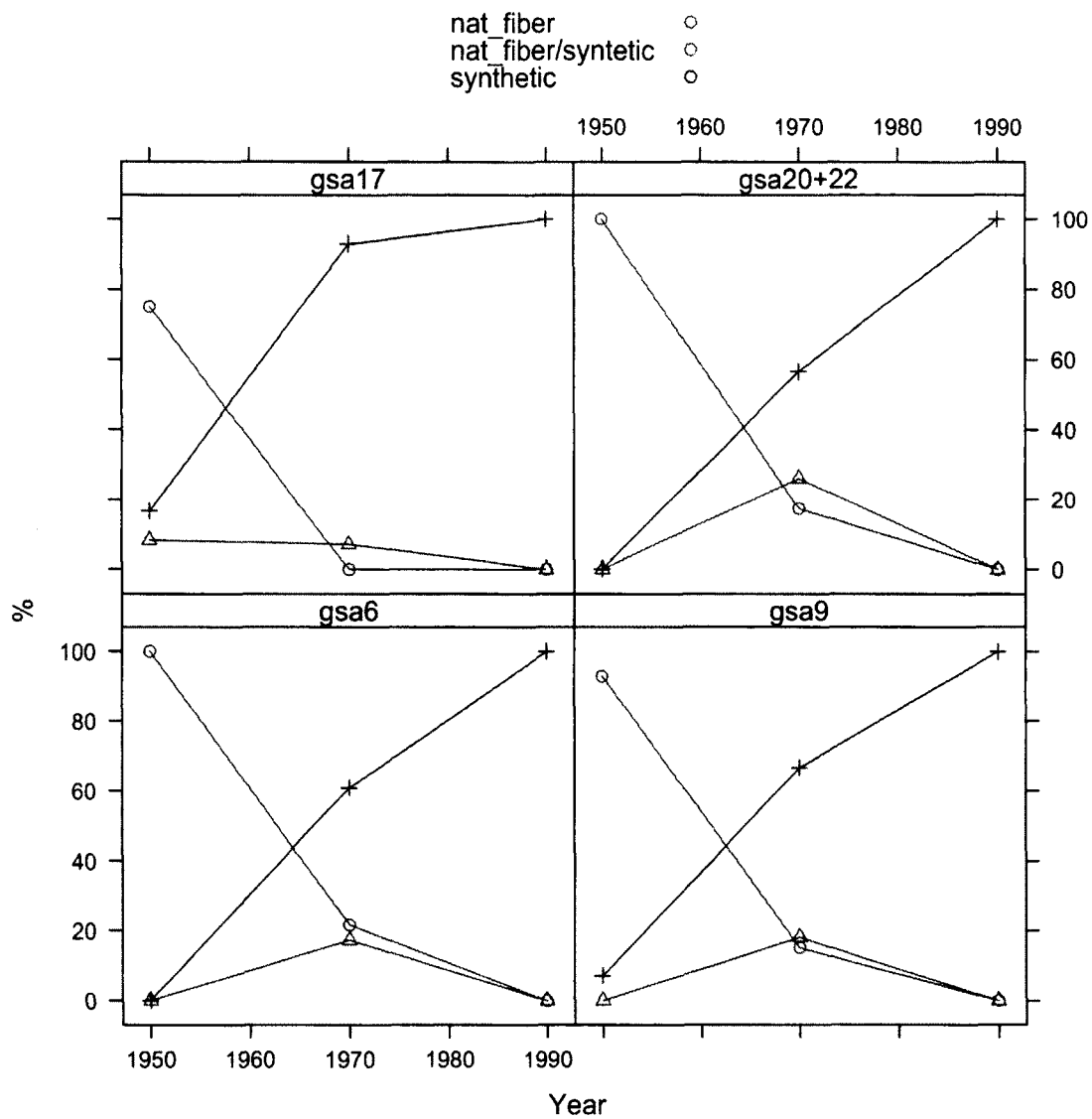

Figure 2-18. Percentage use of different net materials according to fishermen's interviews in the EVOMED Project, GSA06 (Catalonia), GSA17 (Northern Adriatic), GSA09 (Northern Tyrrhenian), GSA20+22 (Ionian and Aegean Sea) [14].

which is equivalent to 540 BHP. Today the degree of diffusion of variable pitch propellers is not recorded but it appears to be more common on modern trawlers.

Overall, increased engine power translates to faster cruise speed, which allows faster navigation to and from fishing grounds. It also enables harvesters to fish in areas that were previously too far away to make the trip and yield economical. The towing speed has increased as well over time, along with the size of the nets, as will be shown in the next sections.

2.4.3.1 Navigation equipment

Navigation equipment has emerged at different times on a country by country basis [14]. Based on the results of fishermen interviews in the EVOMED project, radar and echo-sounders were the first to appear, while GPS, radio, and phones emerged at later stages. Navigation equipment, in particular echo-sounders and GPS, allow better mapping of the sea-floor which enhances the ability of fishermen to exploit difficult areas [139]. Over time, along with more resistant nets and net rigging, harvesters now have access to rocky grounds that were previously too risky to fish.

2.4.3.2 Deck equipment

Because less research on deck equipment in the Mediterranean has been published and information was more difficult to gather, the fishermen interviews performed under the EVOMED project will serve as the primary source for this information [14].

The first wire drums used to store and haul net warps were mechanically connected to the vessel engine and had low power and low hauling speed. For example, hauling capacity on the 280 HP trawler *Hannibal* in 1960 was 0.5 m/s, which translates to 36 min to haul 1.100 m of warps, plus additional time for sweeps [137]. The same was found on the Yugoslavian trawler *Bios* in 1961 [20] with a hauling speed of 0.4-0.49 m/sec. Today hydraulic haulers are common on many trawlers and are more powerful. In comparison with the *Hannibal*, a modern trawler of equal HP [135] has a hauling speed of 1.3 m/s, which is equivalent to 14 min to haul 1.100 m of warps. This is a 225% increase in hauling speed.

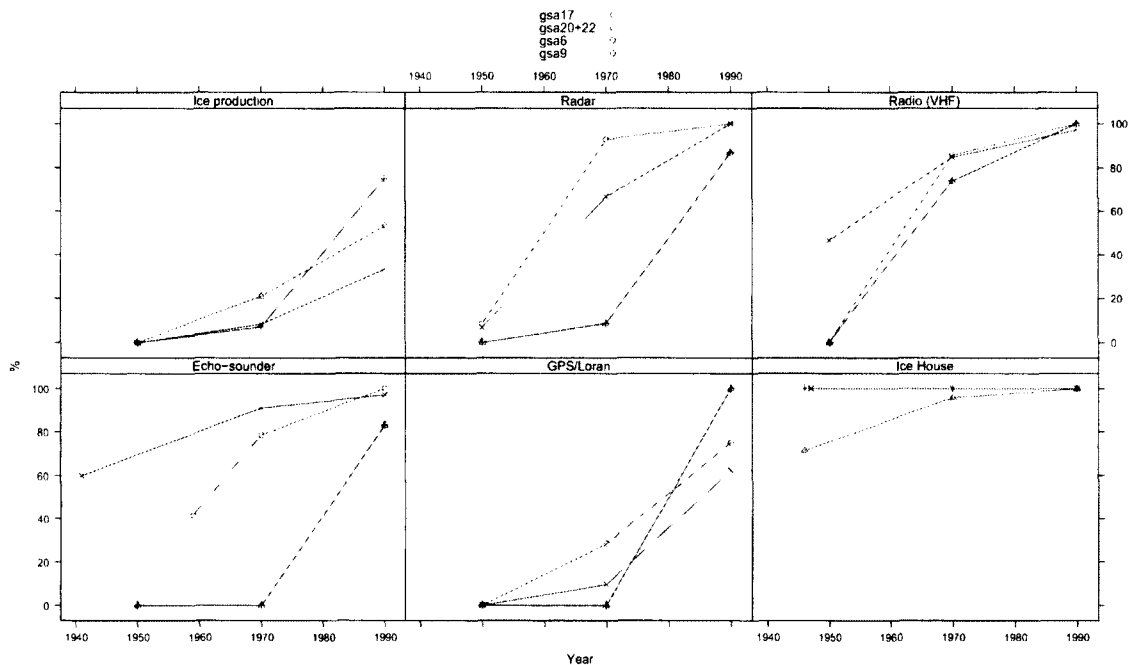

Figure 2-19. Frequency of occurrence of different navigation and cooling equipment since 1940 from fishermen interviews EVOMED Project, GSA06 (Catalonia), GSA17 (Northern Adriatic), GSA09 (Northern Tyrrhenian), GSA20+22 (Ionian and Aegean Sea) [14].

Over time, hauling speed improved and almost doubled at equivalent HP. This implies faster shooting and hauling operations that translate to more fishing time and more hauls. While in the past sail trawlers or even motor trawlers from the 1950s made one or two hauls per day [12, 8], today tow duration is considerably lower, with the exception of deep shrimp tows which can last up to 6 hours. A major effect of this is that the fish quality is better. Additionally, net haulers and rollers have entered in the Mediterranean trawl fishery in the past years. These allow faster net hauling as well as storage and gear-changing, which again increase the actual fishing time. Ultimately, bigger and more powerful wire drums allow carrying and managing up to 3000 m of steel warps that allow fishing down to 1000 m. This further expands trawlable areas beyond the continental shelf. To give an idea, the complete gear rig of an Adriatic pair sail trawler in 1911 weighed 1250 Kg and all operations were performed by hand by the crew [16]. Today, all gear components move

mechanically, with a great increase in the speed of any operation/ This translates to more fishing time.

In the next section we analyze gear performance with a series of available measurements collected from the literature. Here, to summarize some of the aspects described in the previous paragraphs, we plot major correlations among gear parameters. This shows how, over time, the net headline and vessel HP have increased along with wing spread, door spread and vertical opening Figure 2-20. The pairplots display how all these parameter covary and are collinear .

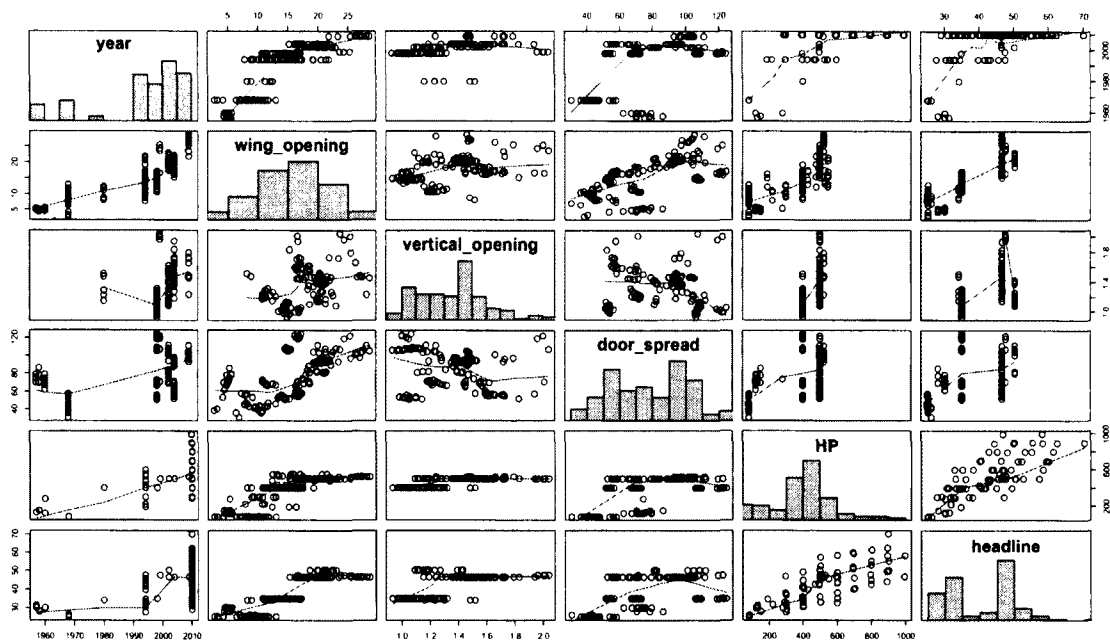

Figure 2-20. Pairplot showing the relationship over time of the available trawl net gear and performance from 1950 to present from Mediterranean nets. Red lines are fitted polynomial smoothers.

2.5 Historical and modern trawl gear performance

The previous section described in detail the main characteristics of demersal trawl gear, rigging, and operation in the most important Northwestern Mediterranean countries over a time span of approximately 300 years. From the description emerges a general increase in the size of nets and a specialization in net rigging. The increase in net size also parallels an increase in vessel HP. Gear dimensions alone, while indicative of general dimensional increase, cannot adequately explain how the gear will perform in terms of horizontal wing spread and vertical opening. These two parameters are, among others, important for understanding how much area and volume a net will sample.

In general, estimates of gear efficiency are important to compare how effective a sampling gear is for collecting the individuals of a species under investigation in a trawl survey or during commercial fishing.

A way of estimating trawl efficiency (Q) proposed by Sommerton [140, 141] is a combination of the net efficiency (i.e. the proportion of the fish in the path of the net that are caught) and the bridle/sweep efficiency (i.e. the proportion of fish from the area between the net wings and the doors that is herded into the path of the net). The following equation describes the relationship between catch (C), fish density on fishing grounds (D), the proportion of fish caught in the net area (e), the proportion of fish caught in the area between the wing ends and the doors (h), the area swept by the net (A_1), and the area between the wing ends and the doors (A_2).

$$C = (eA_2 + ehA_1)D \quad (2.1)$$

If we rearrange we can define Q as

$$Q = e + eh \left(\frac{A_2}{A_1} \right) \quad (2.2)$$

As A_1 and A_2 can be measured, only e and h need to be estimated. This can be done by carrying out herding experiments and net efficiency experiments as described in Sommerton (1996) [141]. The Sommerton equation is used here to primarily show how trawl efficiency

is the result of the combined effects of gear performance, fish behavior, gear selectivity and the relevance of gear performance on trawl efficiency.

This section examines gear performance and focuses particularly on what happens in front of the net mouth without considering net selectivity and fish escapement behavior. Given the importance of understanding the effects of trawl gear change on improving gear performance, the goal is to measure the trends and relationship between gear change and gear performance over time. Gear performance refers to the physical and dynamic performance of a trawl net moving across the water at a certain speed. The parameters analyzed include otter board spread (A_2), wing spread (which results in swept area) (e), net vertical opening, drag resistance of net, otter boards, and warps. The goal is to find the best model that predicts wing opening, one of the main components of trawl efficiency and fishing effort, as a function of gear construction and rigging over the past 60 years. The model needs to be able to estimate WS change from natural fibers to nylon and to the most recent polyamide netting.

Investigating the relationship between vessel engine power, net material, time, and vessel trawl size is very important to refining fishing effort and capacity definition by considering the fishing gear deployed. Ultimately, the overall aim is to enhance the understanding of how fishing mortality of different target species can be linked to standard measures of effort and capacity.

Other authors have performed similar analyses where HP has been related to net dimension, but they used a non-dynamic proxy of average trawl size, either headline length [142, 139] or fishing circle [132]. Here, while our aim is similar, we take a different approach and use a dynamic model parametrized with data collected in sea trials performed in the Mediterranean since 1957.

The goal of this section is ultimately to estimate and test if the Wing Spread to HP ratio has changed over time with the adoption of new technologies. Such results will have important implications for fishing effort estimation and for CPUE standardization.

2.5.1 Literature estimates of performance

Gathering Mediterranean Sea specific estimates of gear performance is not simple since little research has been carried out in this field in the past decades. We therefore used two approaches: one is based on extracting available historical and modern estimates from the literature, while the other relies on simulating gear performance when no performance estimates were available. Before 1950, some authors [109, 108] gave approximate estimates of trawl wing spread and vertical opening but since the method of estimation is unclear these will be taken with caution. While efforts to improve Mediterranean trawls have endured for centuries, as detailed in a previous section, the scientific investigation of trawl gear performance started in the 1950s at the Food and Agriculture Organization (FAO) with a number of fishing experiments carried out between 1957 and 1961 [143, 15, 137, 122, 121, 20]. At the same time former Yugoslavian scientists were testing the effects of sweepnet materials [144]. In 1960, underwater observations were carried out in Israel to measure wing spread and vertical opening [120], and experiments with different webbings [119] and selectivity experiments were carried out in Israel and Spain [145, 146, 147, 148, 149, 149, 149, 150]. Detailed work on performance was carried out in the late 1960s mainly in Italy by Bilio [125], who also provided a critical discussion of previous work performed in the Mediterranean, and then by Fiorentini [127, 129, 130, 128] and others [138, 131, 151, 152].

2.5.1.1 Data and Methods

All performance data were extracted from the sources described above and compiled in a unique dataset. Two sets of variables are reported: (1) gear technical specification (headline and groundrope length, net material), rigging (otter board dimensions and material, warp and sweepnet lengths), vessel HP, and time; and (2) dynamic gear performance (Wing Spread, Otter-board spread, Vertical Opening, Drag resistance) as a function of different towing velocity and depth. The data ranges from 1958 to 2008 with trawl experiments carried out in different parts of the Mediterranean in the historical part, while the performance data from the last 30 years is mostly from the Adriatic Sea.

The dynamic gear performance has been measured using different methods over time. The oldest measurements available are only for otter-door spread and derive from experiments carried out on hemp nets from the 1950s. These estimates were calculated via indirect measurement since no monitoring equipment existed at the time. Following the method described by Sharfe, otter spread was measured using trigonometric calculations based on warp angles and lengths [137]. With the exception of Catasta, who used scuba divers in shallow water to measure wing spread, no direct observations are readily available before Bilios measurements in 1967-69. Using formula, Bilio 2.3 back calculated estimated wing spreads (WS) from FAO reports prior to 1961. The author, however, was wary of measurement errors in the otter spread and the WS estimates. These are considered to be approximate minimum spread values. The gear performance collected after 1980 was recorded using SCANMAR Systems (Norway).

The equation for estimation of wing spread (WS) according to Bilio:

$$WS = \left(\frac{h}{2s + 2m + h} \right) y \quad (2.3)$$

where h =Headline length (m), s =length of sweepline (m), m =length of mudrope (m) and y =distance between otter-boards (m).

The data retained for analysis conforms to the following criteria: the need to report WS (m), headline, warp and sweep length (m); depth of the trials (m); and vessel HP, year, and speed of haul (knots). Additionally, only data representative of commercial gear used in the fishery at the corresponding time period was used. Comparative experimental hauls with, for example, different webbing or different otter-boards were discarded, with the exception of the pre-1960 data, for which there are too few data points. In the case of the data from Sharfe 1960 [20], a corrected HP was used following the authors indication (140 instead of 280 HP) as the net was largely undersized for the vessel. The final data used for fitting the models comprises 141 measurements for 11 different net types.

The raw data is plotted in Figure 2-21, sources and numbers of records are summarized in Table 2.5.1.1. Time is highly correlated with HP increase and headline increase as already shown in Figure 2-20.

Year	Source	Num Records
1957	[15]	9
1958	[122]	4
1960	[137]	8
1960	[153]	1
1968	[125]	26
1980	[127]	6
1998	[128]	44
1999	[130]	4
2002	[154]	12
2004	[138]	53
2009	[131]	11

Table 2.1. Summary table of the data sources by year and the number of sea trials of trawl gear used for modelling wing spread performance over time.

Three assumptions are made for generalizing the results of this analysis: (1) the nets for which there are performance estimates are a representative sample of the average commercial gear population present at the time of the experiments; (2) the measurements are reliable, especially compared to older ones; and (3) the nets are correctly sized to vessel HP.

An additional complication of this approach is that sea trials over time have been conducted at different depth, speed and rigging conditions; therefore, these additional covariates need to be modeled in order to make proper comparisons across nets over time.

Using the R software version 2.81 [155] we modeled the wing spread (WS) as a function of HP, haul speed (SP), depth (D), headline (HL), net material (NM) and warp length (WL). The model 2.6 was fitted using Linear Mixed Models (LME), package (*nlme*) [156]. This type of regression was chosen instead of the commonly used Generalized Linear Model (GLM) [157]. In early model runs with GLMs, we identified violation of the homogeneity of variance assumption which is one of the premises for reliable F statistics and p values. Additionally, since several net performance measurements are replicated within the same

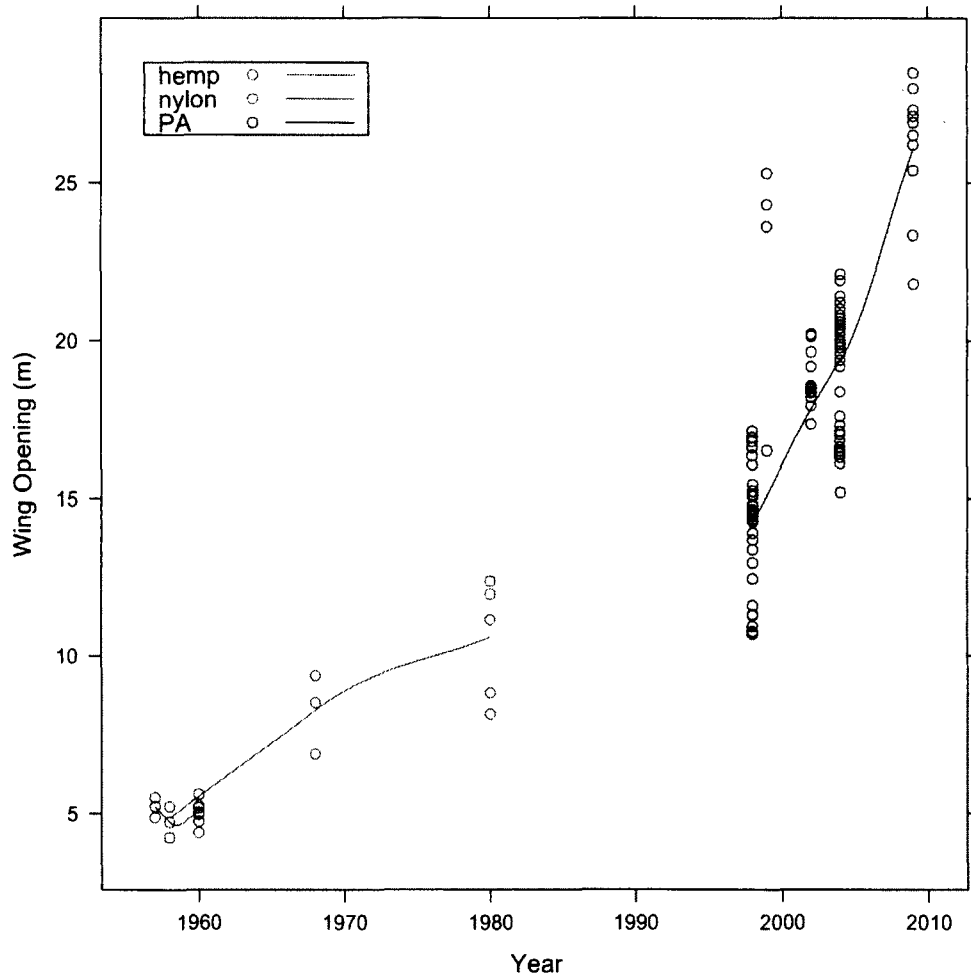

gear, autocorrelations are generated and thus need to be accounted for by using random effects models. LMEs explicitly allow relaxation of the homogeneity variance assumption and different variance structures can be fitted. In this analysis, the random intercept was the net model and different random slopes were tested. HP was modeled as an offset parameter.

Throughout this PhD when different statistical models had been fitted to data, the criterion for model selection relied on the Akaike Information Criterion (AIC) [158, 159] since for the majority of the models there were large amounts of data and the number of fitted parameters was never excessively large. When using GAMMs use of AIC is recommended by S Wood [160, 161] and when fitting LMEs is an accepted and standard criterion..

Model selection is performed via the AIC and can be used to discriminate between competing statistical models. The AIC criterion does not provide a framework for testing null hypothesis. Although it tells which model fits better, it does not give an indication of how a model fits the data in absolute terms:

$$AIC = 2k - 2\ln(L) \quad (2.4)$$

where k = is the number of parameters in the statistical model and L is the maximized value of the likelihood function for the estimated model. The best model will have the lowest AIC and the k parameter serves to penalize the AIC for increasing numbers of parameters added to a model and minimize the risk of overfitting.

At low sample size AIC might be biased and a corrected AIC was implemented (AICc) [162]:

$$AICc = AIC + \frac{2k(k+1)}{n-k-1} \quad (2.5)$$

where n represents the sample size. AICc penalizes AIC further for every additional k parameter and is recommended to avoid overfitting at small sample size [163].

In the specific case of trawl gear performance, there are only 141 observations for fitting this model; thus overfitting can be an issue. However, here no model selection was

performed, but only the starting full model and the final model were fitted. In detail, the following model was fitted:

$$\log(WS_{ij}) = \alpha + \log(HP) + \beta_1 S_{ij} + \beta_2 D_{ij} + \beta_3 HL_{ij} + \beta_4 NM_{ij} + \beta_6 WL_{ij} + \epsilon_{ij} \quad (2.6)$$

where:

WS = Wing Spread (m)

HP = Vessel Horse Power (HP)

S = Haul Speed (Knots)

D = Depth of Haul (m)

HL = Trawl Headline length (m)

NM = Net Material

WL = Warp Length (m)

The random effects are $b_i \approx N(0, D)$ and the variance is modeled as a power of the covariate variance structure:

$$\epsilon_{ij} \approx N(0, \sigma^2 \times |fitted|^{2\delta}) \quad (2.7)$$

$$var(\epsilon_{ij}) = \sigma^2 \times |fitted|^{2\delta_{ij}} \quad (2.8)$$

2.5.2 Results

The fitted *lme* model, in R language, is described as follows:

```
lme(log(wing_opening) ~ offset(logHP) + speed + depth + headline + warp_length + net_mat, random = ~ 1 | ntype, data=gear, weights= varPower(form=~fitted(.) | net_mat1), method= "REML")
```

and corresponds to the full initial model since it was not possible to drop any terms. The best model has as random effect the net type and power of the covariate variance structure. The model estimates for the fixed terms are summarized in Table ???. Standardized

residuals Figure 2-22 and Q-Q plots for normalized residuals, Figure 2-23, look normal. Additionally there seems to be no violation of the normality assumption of the random effects, Figure 2-23.

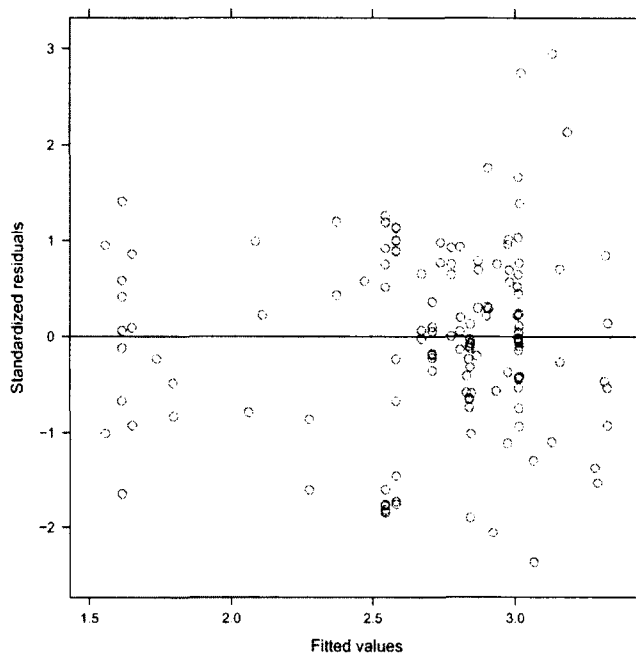

Figure 2-22. Standardized Residuals versus fitted values for best model

The main result of this analysis is that net built with nylon or polyamide achieve significantly larger wing spreads than hemp nets. In detail, nylon twine achieves a wing spread 1.72 (SE 1.24) fold wider than an equivalent hemp net, and a net in polyamide will open 2.38 (SE 1.43) times more than a hemp one (Table 2.5.2). This accounts for headline, speed and depth of the experimental hauls.

2.5.3 Discussion

The results of modeling showing increasing WS with change in net material are interesting and potentially useful. The increase of wing spread, after accounting for speed, depth, headline and warp length, is clearly not only due to net material but also incorporates the effects of better performance of otter-boards, better understanding of net design,

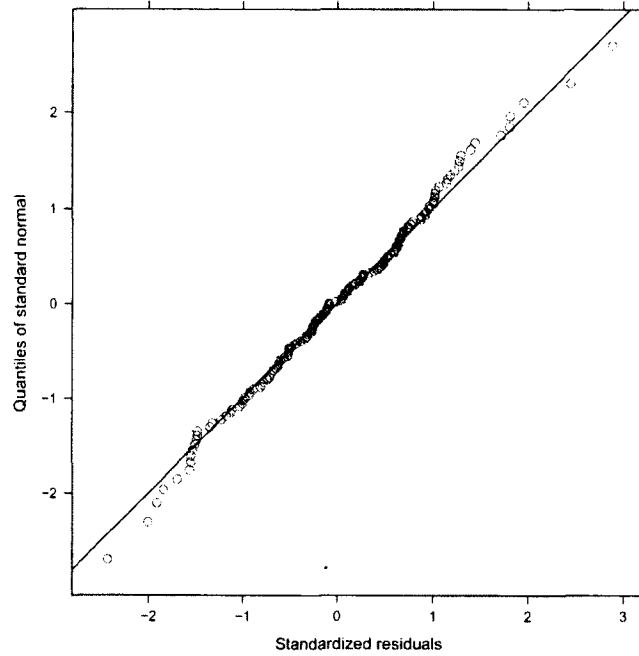

Figure 2-23. Q-Q plot of Standardized residuals for best model

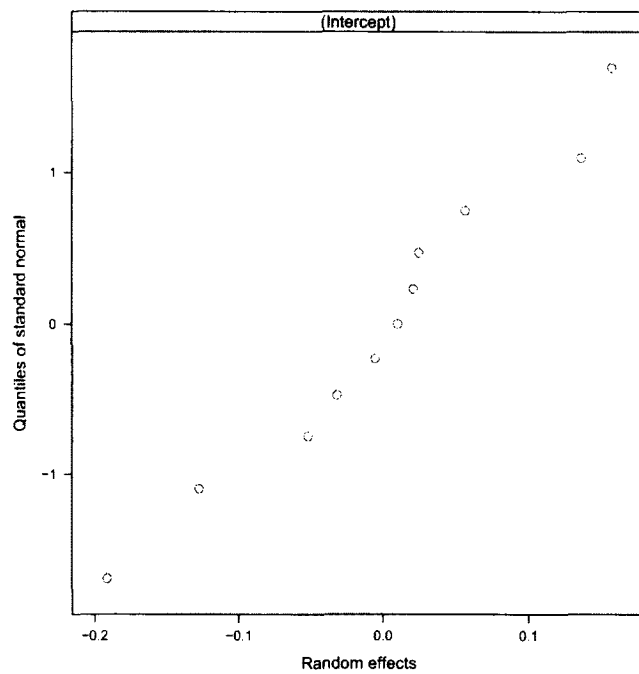

Figure 2-24. Random Effect Q-Q plot for best model

	Value	Std.Error	DF	t-value	p-value
(Intercept)	0.45	0.63	127.00	0.72	0.48
speed	-0.04	0.02	127.00	-2.30	0.02
depth	-0.00	0.00	127.00	-7.36	0.00
headline	0.03	0.02	7.00	1.69	0.14
warp_lenght	0.00	0.00	127.00	13.95	0.00
net_matnylon	0.54	0.22	7.00	2.51	0.04
net_matPA	0.87	0.36	7.00	2.40	0.05

Table 2.2. Summary table of fixed components estimates of best model fitted. The net material (net_mat) set as reference is hemp and the estimates of nylon and polyamide (PA) are compared with hemp. Estimates are shown on a Log scale.

and use of different floats. What the model estimates as net material effect in fact incorporates these additional effects.

The 2.38 fold wing opening increase we estimated over a period of 50 years corresponds to a 138% increase, or to an annual increase of 2.73%. Such rates, albeit linear and not in volume, do not seem particularly high when comparing them to similar results from other areas. Rahihainen & Kuikki [142] have shown that the average trawl size of Finnish herring trawlers has increased by a factor of 2.7 over 20 years (period 1980-2000), and in 2000 the average size of new trawls was 7.5 times larger than in 1980. Since the relationship between the circumference of the trawl (nominal size) and the fishing area is exponential, the rate of increase in the fishing circle is higher than the nominal sizes. Similarly it has been estimated that the Icelandic fleet bottom trawling for cod has annually increased efficiency by almost 5% from the mid-1970s to the mid-1990s [164]. These estimates show the importance of accounting for gear size. Our estimates did not account for time as a predictor variable, however, it seems that wing opening increase for the most recent polyamide nets increases more rapidly within the polyamide series from 1999 to 2009 (Figure 2-21). The rate of increase used in this analysis is measured over the entire time span and would have been larger if only the most recent nets were used.

The materials section explained how earlier wing spreads had been calculated by Bilio. To doublecheck these estimates, wing spread from headline length was recalculated according to formula 2.9 in Gomez & Jimenez [165], but all estimates of wing spread were

unrealistically similar to modern polyamide nets sized to much bigger trawlers (120-150 HP in the past and 400-500HP in recent years). Therefore, Bilios estimates seem more reliable and were retained. In fact, the formula 2.9 was derived from data on synthetic nets and vessels sized from 200 HP upwards, while historical hemp nets were sized for less than 200 HP. This is outside the prediction range of the wing spread model, in addition to being derived from synthetic net performance. The equation for wing spread estimation according to Gomez & Jimenez is:

$$WS = 0.655h - 2.9097 \quad (2.9)$$

In the current dataset, measurement error decreased over time while precision increased along with the number of measurements. In our analysis, there is greater uncertainty about the historical measurements. All estimates of trawling speed before 1970 were measured relative to the water and not to the ground, making them less accurate than more recent measures taken with radar, Loran or GPS. Another limit of the current analysis is that the data are unbalanced as more measurements are available for the recent period corresponding to polyamide nets, however linear mixed models are robust to a certain degree of unbalance. One further limitation is the lack of exact description of earlier nets in use (only headline length and material are reported). Information on mesh size, twine diameter, number of meshes and cutting rates would have been important for validation. For the above reasons, the current results should be used carefully.

The estimates could be improved by adding more data, if it is available. Another way to reduce limitations would be to reconstruct an old hemp otter trawl net and perform sea trials with modern performance monitoring equipment. This would provide a proper comparison with current synthetic nets and gear rigging equipment.

The force to tow the tested net in Anzio at 2.5 knots was 60-70 HP [143] however the net was sized on a 120 HP vessel. This shows how the net was undersized, however there are no estimates of WS for this net and it was not analyzed. Sharfe found a similar situation on the vessel *Hannibal* which, while equipped with a 280 B.H.P. only used about

half that power during fishing operations at 2.5 knots [137]. The reason why nets seemed undersized with regard to vessels HP, in these two early trials, could be due to a rough sizing of the nets at the time or to the fact that actual fishing occurred at higher towing speed, which would increase drag forces. In the case of the *Hannibal* trawler we corrected HP, while for the Anzio trials there were no data on wing spread to use.

Net vertical opening was not modeled since this parameter was absent for most early data. However, for the most recent data there is an appreciable increase over time and with increasing HP (Figure 2-20). This means that a synchronous increase in vertical and horizontal opening will cause a much more rapid increase in swept volume. While swept volume will not affect catching power in terms of demersal species like *Nephrops* [132] or flat fish [166, 167], it can greatly increase the catching power of semi-pelagic species, as discussed in previous sections on GOV nets.

The predictive model and estimates developed here can be useful for modeling commercial landings per unit of effort data (LPUE) derived from trawlers with hemp nets in the 1950s and trawlers with polyamide nets in the present. Since limited knowledge of specific gear types will be available for each trawler, the estimates of gear performance obtained here, with caution, will be used to correct the LPUEs.

2.5.4 Simulation of Trawl gear

The following part of the analysis is still ongoing and is being performed in collaboration with A. Sala, F. De Carlo and E. Notti at the CNR Laboratory of Gear Technology in Ancona (Italy). There are three goals for this analysis: (1) to estimate the drag forces at play in earlier nets for comparison with more modern ones; (2) to gather an approximate estimate of the towing forces required to drag early nets at speeds compatible with fishing (>2.5 knots); and (3) to estimate the HP of a sail trawler for estimation of fishing effort.

2.5.4.1 Data and Methods

Using the Trawl vision software (www.acruXsoft.com.uy), gear performance was simulated using the available trawl schemes and rigging information from the earliest avail-

able nets for which enough information was available in terms of mesh size, number of meshes, cutting rates and the difference between the upper and lower wedges. The nets reconstructed have been previously described in the historical section. They are a pair sail trawler from Spain described by Sáñez Reguart in 1795 [108], the net used in the Hvar survey in 1948 [34, 124], and the net used by the vessel *Predvodnik* in a survey performed by Jukic in the period 1963-67 [126]. All gear described is commercial gear in use, respectively, at those times in those places. The net schemes are drawn in Figures 2-30- 2-32 in APPENDIX 2.

The parameters of interest are wing opening and towing resistance at different trawl speeds and depth combinations. There are two main limitations of the Trawl Vision software. First, for otter trawls it considers otter-board distance an input parameter that should be measured during the hauls. Since this was impossible, a range of realistic values of otter spreads has been given, but for this reason, estimates of wing spread will not be considered fully reliable. Second, the simulator allows specification of net mesh and twine size but does not allow simulation of a natural fiber twine such as hemp or cotton. Natural fiber twine expands when wet and thus increases drag resistance. Since simulation does not account for this characteristic, estimates of net drag could be low. However the drag of a net is proportional to the number and type of meshes in the netting, and to the orientation of the net panel(s) in the water [135]. All available net details and gear rigging specifics were entered in the software models.

2.5.4.2 Results and Discussion

Only the pair sail trawler wing opening (WS) can be reliably estimated since WS is regulated by the distance between the vessels. By simulating increasing distance between the trawlers (from 122 to 200 m, values taken from the literature [168]), warp lengths (450 m) and 2.5 knots we obtained a mean WS of 12 m, with a min of 8.2 m and a max of 13.7 m. While uncertain, the vertical opening is surprisingly high, reaching 2.3-2.5 meters, which is consistent with descriptions in the literature [108]. Apart from wing spread, drag resistance estimates and their relation to vessel HP, when known, and the estimated wing

opening were the focus of the research. Drag estimates for total rig, net, otter-boards and warps in kgf at speeds of 3 knots, with in some cases upper and lower speeds, are reported in Table 2.5.4.2.

Type	Year	MAT	HP	HR	ND	S	TRD	WOD	SND	OD
pair sail	1790	hemp	na	32	356	2.3	504	89	59	
pair sail	1790	hemp	na	32	606	3.0	754	89	59	
pair sail	1791	hemp	na	32	825	3.0	973	89	59	
otter-trawl	1947	hemp	250	35	1174	3.0	1975	293	106	402
otter-trawl	1965	cotton	180	350	635	3.0	1379		119	625
otter-trawl	1965	cotton	180	350	864	3.5	1834		119	851
otter-trawl	1965	cotton	180	470	864	3.5	1733		160	709
otter-trawl	1965	cotton	180	470	864	3.5	1733		160	709
otter-trawl	1965	cotton	180	470	864	3.5	1733		160	709

Simulated net performance at different trawling speeds, material (MAT), HP, speed (S), net drag (ND), total rig drag (TRD), warp and otter drag (WOD), Sweep and net drag (SND), otter board drag (OD)

There are no estimates of either wing spread or drag forces from pair sail trawlers to compare with the sail trawler estimates made here. An attempt to validate the simulated results was made by comparing them to a series of drag estimates collected in the gear performance database described and analyzed in the prior section. The goal was to assess if the relation between WS and either net drag or total rig drag is comparable in the simulated data and in the existing estimates from different net materials. The plots (Figure 2-25), with a polynomial smoother fitted to net material nylon and polyamide, show that in either case the simulated data falls outside the range of natural fiber nets. In particular the pair sail trawler (BOU) should be compared with otter trawl gear, keeping in mind that the rigging does not use otter doors and therefore the total net drag will be by default much smaller. Similarly, the WS of the pair sail trawler can be higher than an otter trawler, given the spreading forces operated by the two vessels trawling in parallel. Nevertheless, when looking at WS versus net drag, the pair sail trawler is in the range of the otter trawler net of polyamide and of vessels of approximately 400 HP, which seems quite unrealistic given wind propulsion. Similar considerations are valid for the *Hvar* otter gear (HVAR) and the net used by the *Predvodnik* (PRK). Both achieve too large a WS and

too low a drag resistance and seem to be more performant compared to polyamide nets, which is unrealistic.

Visual inspection encouraged treating the simulated gear performance with caution and no formal statistical testing has been performed at this stage.

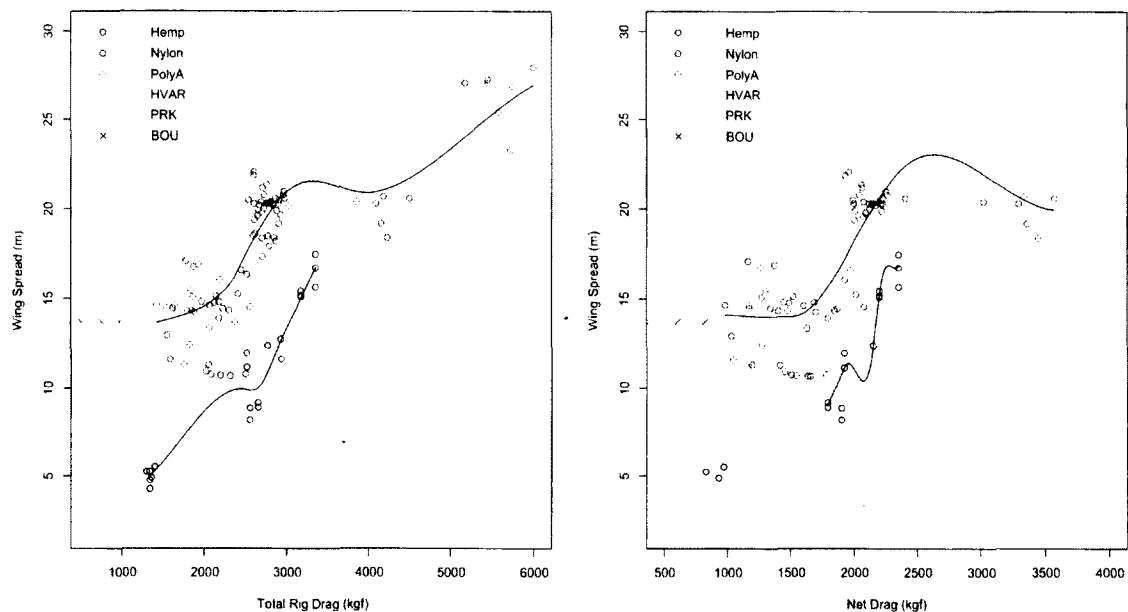

Figure 2-25. Comparison between the relations WS, Net drag and Total rig drag according to original sea trials and simulated performance for a hemp otter trawl from 1948 (HVAR), a hemp pair sail trawler net from 1795 (BOU) and a cotton otter trawler net used in 1965 (PDK). The hemp, nylon and polyamide WS and drag measurements are, respectively, from the 1950s, 1960-70, 1990-2009

One further comparison was made between HP and Total rig drag resistance (Figure 2-26). The main point here is to see if pair sail trawler estimated drag forces are compatible with 40-50 HP vessels. Multiple references state that ordinary pair sail trawlers would need at least 40 HP (20 HP for each trawler) to successfully operate. Based on trawling experiments Mancini stated that a 40 HP trawler could not tow an ordinary *paranza* net with 600 meshes [111], and suggested 70 HP for a net of 600-700 meshes. The first pair sail trawlers refitted with engines in the 1920s had 20 HP motors (each) [169]. We therefore assigned 40 HP to plot the drag forces of the pair sail trawler trawling at 2.5, 3 and 3.5

knots. An imaginary line on all the data points seems to indicate that 40 HP could be sufficient power for towing the net described by Sáñez Reguart at approximately three knots.

The net simulation results are still too preliminary to return reliable estimates on wing spread or drag resistance. The exercise was useful regardless as it allowed estimations of the dimensions of historical net lengths of footrope and groundrope in addition to the cutting rates. The latter in particular can be very useful for further simulations with other methods, or, even better, for the reconstruction of a hemp net to perform plume tank experiments with a scale model or sea trials with a fully reconstructed net. With adequate monitoring instruments gear performance could be easily measured and, if pair tows were possible with modern nets, potentially an intercalibration could be performed. Nevertheless, that a sail trawler is compatible with approximately 40 HP is an important indicator for the effort assessment performed in Chapter 2 and the LPUE standardization in Chapter 3.

2.5.5 Summary of 300 years of trawl gear evolution

Based on the available information concerning presence of a certain gear in a specific country, a plot was built to display the time line of operation of each gear (Figure 2-27). The plot is based on a quantitative database built and used to reconstruct fishing effort, and is thoroughly described in Chapter 2. Here, it is used to give a more robust and conservative time period for the use of each gear type in the countries under study, and also for Tunisia and the former Yugoslavia, where available data was collected that has not yet been analyzed. Historical anecdotal references explained in previous sections expand the timelines in the plot.

We have constructed a timeline covering more than 300 years for the introduction of new technologies in trawl gear and in fishing vessels. Details of the changes have been described along with a discussion of their impact on fishing capacity. Overall, the size of nets, their resistance, and ease of handling have increased over time. The capacity of trawlers with larger towing power has allowed a remarkable increase in the size of nets both in

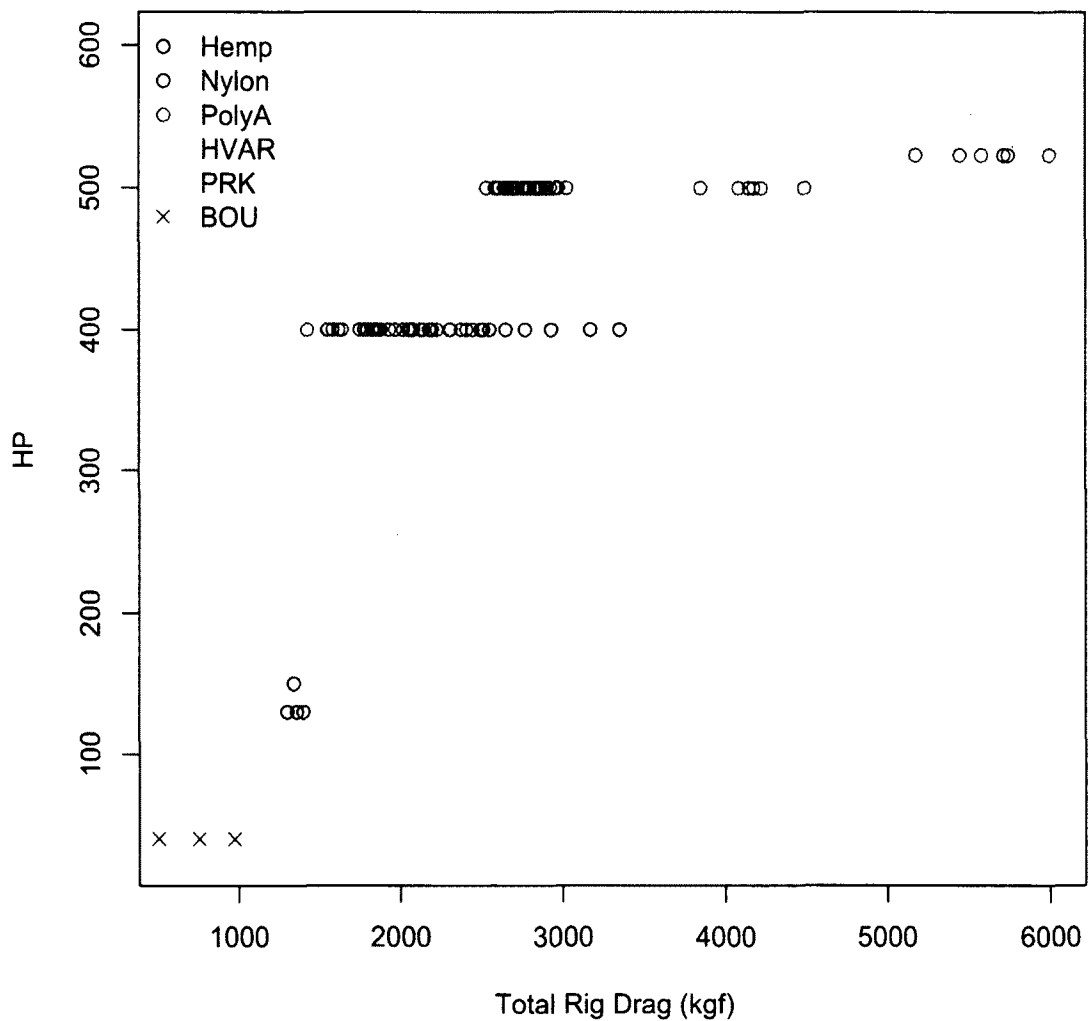

Figure 2-26. Comparison between the relations HP and Total rig drag according to original sea trials and simulated performance for hemp otter trawl from 1948 (HVAR), a hemp pair sail trawler net from 1795 (BOU) and a cotton otter trawler net used in 1965 (PDK). The hemp, nylon and polyamide WS and drag measurements are respectively from the 1950s, 1960-70, 1990-2009

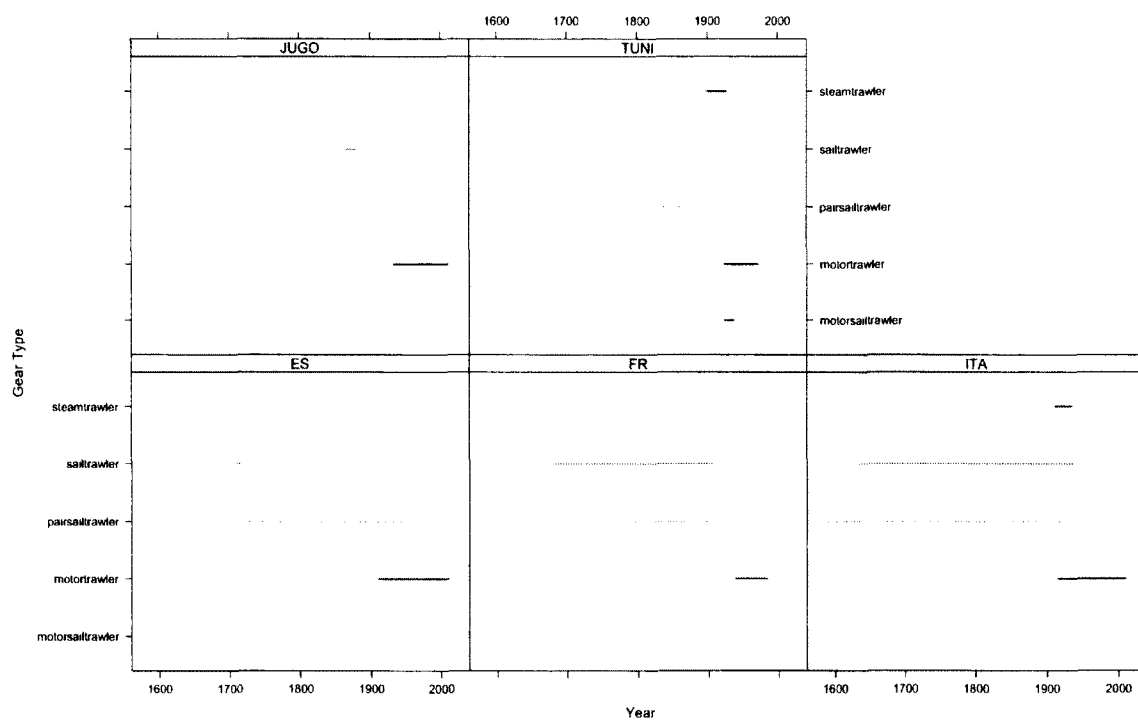

Figure 2-27. Timeline of the presence of each type of trawl gear in former Yugoslavian countries (Slovenia, Croatia, Serbia, Montenegro)[JUGO], Italy [ITA], France [FR] and Spain [ES].

horizontal and vertical spread. When horizontal spread was modeled, results showed that more recent trawl gear constructed with polyamide webbing achieved wing openings more than 2 fold larger than equivalent hemp nets. Over time, fishermen have been able to expand the area they fish thanks to vessels that were more seaworthy and to increased warp lengths. The latter allowed a 10 fold expansion to deeper grounds over 300 years. Modern navigation equipment has freed fishermen from manual and approximate depth estimates. In the 17th Century getting a net stuck on a shoal while sailing sideways on a single pair trawler often resulted in capsizing. Today, with a detailed vision of the sea floor, not only has the risk of capsizing decreased, but deep canyons that were previously unexploited can now be fished.

The effects of gear change in terms of fishing capacity (increased net sizes, faster hauling shooting, etc.) were described but the effect on fishing efficiency, as we defined it, has yet to be examined. Fishing efficiency is the most important factor that needs to be estimated for a proper comparison of catch data emerging over long time periods if any inference about fish stock abundance is to be made. In the next chapters, the focus will be to derive estimates of efficiency and use them, along with variables from net material to wing spread parameter, to standardize LPUEs.

2.6 APPENDIX 1

The measurement units adopted in Du Monceau are the French Royal Metric System; here for the sake of clarity the original unit along with its metric conversion are given according to Table 2.3. The original French text is translated and integrated with calculations on the gear.

Spanish gear measurements reported by Reguart in 1795 [108] and subsequent authors needed to be converted to the S.I. metric system using the conversion factors reported in Table 2.4.

Table 2.3. Conversion of Ancient French units to the Metric System

French Royal Measure	International Metric (rounded)
1 pied	32.5 cm
1 ligne	2.3 mm
1 pouce	2.7 cm
1 pan (=9 pouce)	24.3 cm
1 brasse	1.6 m
1 lieue marine	3 Nm or 5556 m
1 once	30.6 g
1 livre	490 g
1 quintal	48.9 kg
1 tonne	980 kg

Table 2.4. Conversion of Ancient Spanish units to the Metric System

Spanish Historical unit	International Metric
1 punto	0.1613 mm
1 línea	1.935 mm
1 pulgada	23.22 mm
1 pie	27.86 cm
1 vara	0.8359 m
1 paso	1.3932 m
1 legua	4.1795 km
1 braza	1.67 m
1 palmo	20 cm

2.6.0.1 Net and mesh measurement in 1768

According to Du Monceau [109, p.5] measuring net meshes was important for regulatory purposes. Although he states that there are difficulties in measuring mesh openings in *pouces* and *lignes* and inconsistencies in measurements, there is a standard way. In the Mediterranean fishermen count the number of knots *ourdres* that are within one *pan* (24.3 cm) or within one *brasse* (1.6 m). The mesh of natural fiber nets in use for some time tend to reduce the mesh opening because of untwisting twine and the tanning process. A larger and stronger twine will swell more and, over time, mesh openings will reduce more than with smaller twine. For what concerned the mesh of towed nets Du Monceau wrote [109, p.6]:

In the different fisheries regulations there has been a great focus in fixing the mesh openings of the different types of nets. But, among the problems we mentioned before, I am not sure if we noticed that when we tow a net sidelong to the current, or over the sand, the twines get closer, the meshes stretch and they reduce so much that especially on the net body *chausse* [of trawl gear] they close entirely. In this case the exact mesh size is only useful for the nets that have an appropriate tension and that are deployed perpendicularly to the current, which are either rare circumstances.

The net meshes were made by hand, with knots placed at chosen distances. For large meshes a tool called *moule* was used. This consisted of a piece of wood that set the length of the twine between two knots. Du Monceau explained that the mesh opening is double the length of the straight *moule*. In the case of small meshes, a cylindrical piece of wood, called *moule cylindrique*, was used along its circumference to produce the knots. The size of the cylindrical *moule* was given by the diameter. The length of the four sides of one mesh were equivalent to the circumference of the *moule*, and one quarter of it gave the length of one side, or the distance between two close knots. A mesh of 1 *pouce en carré* meant a mesh where each of the 4 pieces of twine of the mesh has a length of 1 *pouce* (2.7 cm) between two knots. To obtain such mesh required a *moule* of 16 *lignes* (37 mm) in diameter and a circumference of 48 *lignes*, of which one quarter is 12 *lignes*, equal to 1 *pouce* (2.7 cm).

Du Monceau distinguished three different types of trawls: *Gangui*, *Gangui-Boeuf* and *Tartana*.

2.6.0.2 *Gangui*

Du Monceau [109, p.152-154] described the *Gangui* gear with the following words [translation from original French text by G. C. Osio]:

This fishing gear seem to derive from a Spanish net called *Ganguil* and it's made of two wings (*bandes des filets* or *ailles*), designated by BC in Figure 2-1, with sizes of approximately 8-10 pied in height (2.6-3.2 m) and 30 pied in length (9.7 m) and a bag (*manche, nappe, sac*). The mesh size is not regulated as this net technically is not authorized to fish. The wings are delimited by a float line and ground rope which are made with *jonquines* (natural fibers from a plant of the *Juncus* family) or esparto *esparte* of respectively 1 and 2 *pouce* of diameter (2.7 cm and 5.4 cm). To the ground-rope are attached weights of lead in the proportion of 9 *livres* (4.5 kg) for each *brasse* (1.62 m) of length, this despite the fact that it is forbidden to place more than 1.5 *livre* (0.7 kg) of lead on each *brasse* of foot-rope. To the float line are attached, every *pied* (32.4 cm), floats of cork. The net body has a length of 30 *bras* (9.7 m), but often much less to scale it with the strength of the crew. In the net mouth (*margue, gorge de la manche*) is fixed, inside and outside, a wooden ring of 3 *pieds* in diameter (1 m) and sometimes there are additional smaller rings going toward the end of the cod-end. When only one vessel trawls, as the wings tend to approach to the point of collapsing, these are kept open with a wooden pole of 3 *brasses* (4.8 m) attached at the extremities to the head-rope across the net wings, as shown in E in Figure 2-2. This pole (*partequie*), from which the cables connect to the boat stern and bow is even more necessary when the wires of the small *gangui* are very short. The goal is that the wings are far apart all the time and form a tunnel that conduces the fish to the net body. It is at the extremities of the pole that the warps of *junquinne* are attached. The warps are sometimes of 7 *brasses* of length (11-12 m) and when the *gangui* is very small the wooden pole almost touches the boat. The warps are always attached to the boat starboard and port side: this allows the vessel to sail down-wind and have enough force to tow a net that can have as much as 80 to 100 *livres* (40 to 50 kg) of lead.

(...)

On the coast of Sète the *gangui* fishery is operated with the same boats and crews of the sardine fishery. Often the small *gangui's* have two man crew. (...) In Narbonne for this fishery are used boats with Latin sails and ores, and are 4-5 tonnes and carry 3-4 men. In Le Ciotat, the majority of vessels does not have sails and the *gangui* fishery is operated with ores.

Du Monceau [109, p.153] stated that the small *gangui* were slow in low to moderate wind and argued that the yields and damage they could do were limited. In low wind two boats tow the same *gangui* to increase speed [109, p.153]. A few other minor towed nets go under the name of *gangui*. Some with an iron frame at the net mouth operated more like

dredges and were suited to harvest oysters and sea urchins. In addition some very small *gangui* called *bregin* were used between Frontignan and Aigues Mortes [109, p.153].

2.6.0.3 *Gangui-Boeuf*

Du Monceau [109, p.154-155] gave an extensive description of the *Gangui-Boeuf* gear [translation from original French text by G. C. Osio]:

The *Gangui-Boeuf* rigging uses a *gangui* net similar to the one described above and two vessels towing in parallel. The net body has a length of 6-7 *brasse* (10-11 m) and the wings between 8-12 *brasses* (13-20 m). The overall length of the net is 28-30 *brasse* and a *chôte* (height? SEEMS UNLIKELY NEED VERIFY, perhaps is the opening of the mouth?) of 8 *brasse* (13 m). The meshes in the net body are 5-6 *lignes* of opening (11.3-13.5 mm). Other than this, the net is similar to a *Grand Gangui* but built with a stronger twine. The first rope that is attached to the net wings is normally of natural fibers (*herbage*). However, to avoid that the weight of the warps (*halins*) slows the net, to each wire are added 5 pieces of hemp ropes of 60 *brasses* each (100 m) that are called *mailles*. Each warp (F G H) is long 100 *brasses* (160 m). In addition cork floats are attached to the warps.

For this fishery are used two vessels, of 8-10 tonnes and that carry 5-6 fishermen. Each of the vessels jointly operating the *boeuf* fishery (pair trawling) carries one of the warps and the vessels stay 50 to 60 *brasses* apart (80-96 m). While navigating the cables and net are dropped in the water and the gear sets at a certain distance. At the net mouth the net has an opening between 4 and 6 *brasses* (6.5-10 m). When the net is in tension the two vessels sail down-wind with all sails deployed and tow the net with a speed equivalent to a strong current that funnels in the net. (...)

There are some *gangui* fisheries where there is no need to come to shore to haul the nets: these are hauled on board but to do this operation strong crews are necessary.

2.6.0.4 *Tartanne*

Du Monceau [109, p.155-160] gave the most extensive description of all trawl gear to the *tartanne* gear [translation from original French text by G. C. Osio]:

Tartanne is called a boat that is light and decked and that is very common in the Mediterranean. There are of different sizes that have different uses as much in Marseille as in Martigues and also around the coasts of Languedoc and in Spain and Italy.

In the port of Martigues has the reputation of building the best *tartannes* in the Mediterranean.

The sails have a Latin rigging with the mast positioned in the middle of the vessel and it carries a large boom that rigs the main sail called *meistre* (A in

Figure 2-4). To the main sail additional sails, called *foques*, *coutelas* (B in Figure 2-4) can be added according to necessity. Since a long time the name *tartanne* has been given to the net that is used with this type of boats. It is still used in Livorno (Italy) and in some other areas.

(...)

It is believed that in Senigallia people still call such net *tartena* and the vessel *pescareccia*. This boat is of 7 to 8 tonnes and when sailing it carries a 7-8 fishermen crew. In general, as the net used in the Vatican State [the Marche region in Italy today] is similar to those used in Martigue (France), this rig was also called *marteguali*. Fishermen in Provence (France) modified after 20 years the classical *tartanne* net and boat and called it *trabacou*, *trabaqué*. (...) This fishery is operated day and night, at 4 *milles* (4 Nm) from land: the stronger the wind, the more the fish catch.

(...) The *Tartane* fishery is comparable to the *dreige* fishery in the Ocean (Atlantic). It's a large net that is operated at 20, 30 or 35 *brasses* (respectively 32-49-56 m) of depth and that is towed on the sea bottom to catch the fish that is sheltering there. Favorable sea-bottoms such as sandy or muddy are rarely found at shallower depths. Fisherman carefully avoid rocky areas because they would catch nothing and would risk of losing or damaging the nets. The *tartanne* differs from a *dreige* (dredge) as the net body is much elongated from which fish can't escape as long as the net is moving. The *dreige* has no tubular structure and is more similar to a towed trammel net. The fishing vessels employed in France are approximately of 25 tonnes and carry 8-12 fishermen. (...) The net body is preceded on the two sides by wings (*alas*) that can be of 6-8 *brasses* (9.7-13 m) in length and between 1.5 to 6 *brasses* (2.5-10 m) in perpendicular height. The wings create a funnel ahead of the net mouth and the meshes are 8 *lignes en quarré* (1.8 cm) [in this case 1.8 cm is the length of one bar of the mesh, we can estimate the Mesh Opening (MO) as the double (3.7 cm)]. The net body is 6 *brasses* (10 m) long and the mesh in the first 2 *brasses* (3.2 m) is 7 *lignes en quarré* (1.6 cm, MO=3.2 cm), the following 2 *brasses* are 6 *lignes en quarré* (1.4 cm, MO=2.74). The fifth *brasse* (called *ségarié* has meshes of 5 *lignes en quarré* (1.1 cm, MO=2.2 cm) and the final part, the cod-end (called *Cul-de-sac*, *Culaignon* or *Curagnon* is more closed and the meshes are even smaller. As these meshes are made with a larger twine, the mesh size reduces by half when the net is wet as the natural fibers twines swell and contract a lot.

(...)

The twine that forms the net body is not worked in a circular way as on the *verveux* (.). The webbing of the net body in the first 5 *brasses* (8 m) is made of two parts of net the meshes of which get progressively smaller according to the following scheme. Each of these pieces has 80 meshes of width; as the meshes get smaller on one side than the other, in this area the two net parts have unequal width. One piece makes the right side and the other the left side: they are connected on the bottom and top part by two strips of webbing made with a strong twine. Fisherman call these *guirons*, *guyérons*: they are like two strong *galons* (braided bands) that extend from the mouth of the net to the *seguerie*, and often till mid or two thirds of the *marginue*.

skip 1586

The net mouth is surrounded by a rope that borders it. The foot-rope is added of as much lead as deemed necessary. The headline is added of cork floats, called *nattes* in Provence, to make sure the mouth stays open. Fisherman vary the amount of lead depending on the type of bottom where they plan on fishing. If it is on a sandy bottom, which normally is compact and hard, and on which flat fishes sit to rest, a lot of lead is used to force flatfishes to abandon the bottom and swim. There are certain bottoms for which 30 *livres* (15 kg) of lead are used, distributed in groups of three pieces of 9 *onces* each. However when it is necessary to sweep over muddy bottoms, not only fishermen put very little lead on the net mouth, but they also put on front of it the *paillettes*. These are bundles of ropes of 9 *pouces* (25 cm) of length that move over the bottom without loading the net. In any case where the net mouth connects to the wings they put some pieces of lead with some ropes. This is enough to keep the net body on the bottom. (...)

In some areas the *tartana* net is not loaded with lead but from wing to wing with stones of 8-10 *livres* (3.9-5 kg). The headline [in the net mouth] carries 40-50 *livres* (19.6-24.5 kg) of cork. This way the net trawls in between waters, or at least is mostly off the bottom: this is very advantageous for the conservation of fish. Fishermen have no interest in saving on cork floats because as the *tartanne* goes with full sails there is a need of a lot of cork to prevent the net from sinking. For this reason under the net body is placed a group of corks of approximately 15 *livres* (7.4 kg). The wings as well are lifted by 8 to 10 mats (*nattes*), with a weight of 8-9 *livres* (3.9-4.4 kg). These corks are insufficient to make the net body float but they keep the net mouth open.

For what concerns the wings that precede the net body and that form the net funnel, no lead weight are mounted on them; the float-line that borders the upper part is rigged with corks and the foot rope with lead. The net is connected to the vessel with long ropes, sometimes made of hemp, but most of time in Provence are made with a *Juncus* called *esparte*. These ropes, not as good as the hemp ones, are much cheaper.

The cables (warps) that connect the net to the *tartanne* boat, are called *libans*, *sartis*. These are ordinary ropes of 4-5 *pouces* (10-13.5 cm) of circumference: we can call these sheets of the net *écoutes du filet* as they have the same effect of the sheets of a sail. Each piece of rope is of 23 *brasses* (37 m) and 12 are tied together to form each cable (warp), which makes 276 *brasses* (448 m). At 225 from the boat or 26 *brasses* from the extremities of the wings the cables double [the double cable is equivalent to the bridles] and where they start is weighted down with stones [position were in an otter-trawl are located the doors]. The stone on the cable attached to the bow weights 35 *livres* (17 kg) and the one on the cable from the stern weights 25 *livres* (12.5 kg). The reason of such difference is that the stones are meant to absorb the oscillations that the net could receive from the boat. As the oscillations from the bow are greater of the ones from the stern, the stone (*baude*) that responds to it needs to be heavier. These stones assure that the towing point on the net is more close to the bottom, however without dragging on it. It is also for this reason that, between

the *baudes* and the net, are attached some old ropes, which, being softer glide better over the bottom. It should however not be believed that the *baudes* make a large difference: as they receive the first effects of the boat oscillations, they can raise one to two bras (1.5-3 m) above the bottom. The *baudes* raise or drop continuously, following the wind gusts or the boat accelerations.

Some fishermen place every 20-25 brasses (32-40 m) of the warps some corks attached to long pieces of fine twine: they call these *signaux* (signals) because they think that this small floating buoys indicate the position of the cables, or, which in fact is the same, of the net wings. This is a useful observation to manouver the gear so that the wings stay distanced one from another and the net body stays open. Each wing is connected to the cables by a piece of wood of 3 *pieds* (1 m) called *clava*, which is mounted vertically and on which are tied the warps.

Despite the fact that the *tartanne* boat cruises sideways in this fishery and despite the fact that the warps, called *libans* by the Provençal fishermen, are attached to the bow and stern of the vessel, the tunnel formed by the net wings could be too narrow. It's for this reason that fishing captains mount on the front and back of the boat some poles, called *paux, bout-hors, ailes*, that are long 38-42 *pieds* (1.2-1.4 m). Today these poles are even long 45 *pieds* (1.5 m). At the tip of the poles are attached the warps. (...) Any type of wind is good for this fishery as it is indifferent the trawling direction. Calm seas are feared, as they stop this activity, as well as storms that damage the net. In general strong winds are advantageous for the *tartanne*. (...) There is an understanding that the fish that is on the path of the wings is forced to enter in the net belly and to stay in it during the 15-20 hours, more or less, that fishing lasts, depending on the weather and other circumstances. In fact there are some coastal areas where the nets are hauled every 9-to hours. We are told that in Senigallia (Adriatic, Italy) this happens every 3-4 hours. (...) Skipped 1606 (...) Sometimes in the net are found only mud, rocks, shells etc.. However when fisherman have trawled in favorable areas the yields are of multiple *quintals* (1 quintal=49 kg) of all species of fish. The winter season is the most favorable for this fishery because fish stay on the bottom and because the NW wind blows often, which is advantageous as long as it's not too strong. As this fishery needs to be operated at 40-50 *milles* (40-50 Nm) from our coasts [of France], at depths between 25-60 *brasses* (40-96), it is allowed year around. However similar fisheries that are operated near the coasts are forbidden during the spawning period. *Tartanne* fishing is not used around Le Ciotat as the sea bottom is rocky. Fishermen from Martigue, that are particularly skilled with this fishery, go fishing in the Languedoc region [France], in Livorno [Italy] and Cadiz [Spain].

Du Monceau [109, p.159], in addition to the *tartanne* gear described the *trabacou* or *trabaqué*, an enlarged *tartanne* net and vessel developed in Martigues. The boats were 40-45 tons, carry 12-15 crewmen, and the net was proportionally larger. [problem finding unit of measure *pans*, so can't give net specs] [1 *pan*=9 *pouces*, 1 *brasse*=7.5 *pans*].

2.7 APPENDIX 2

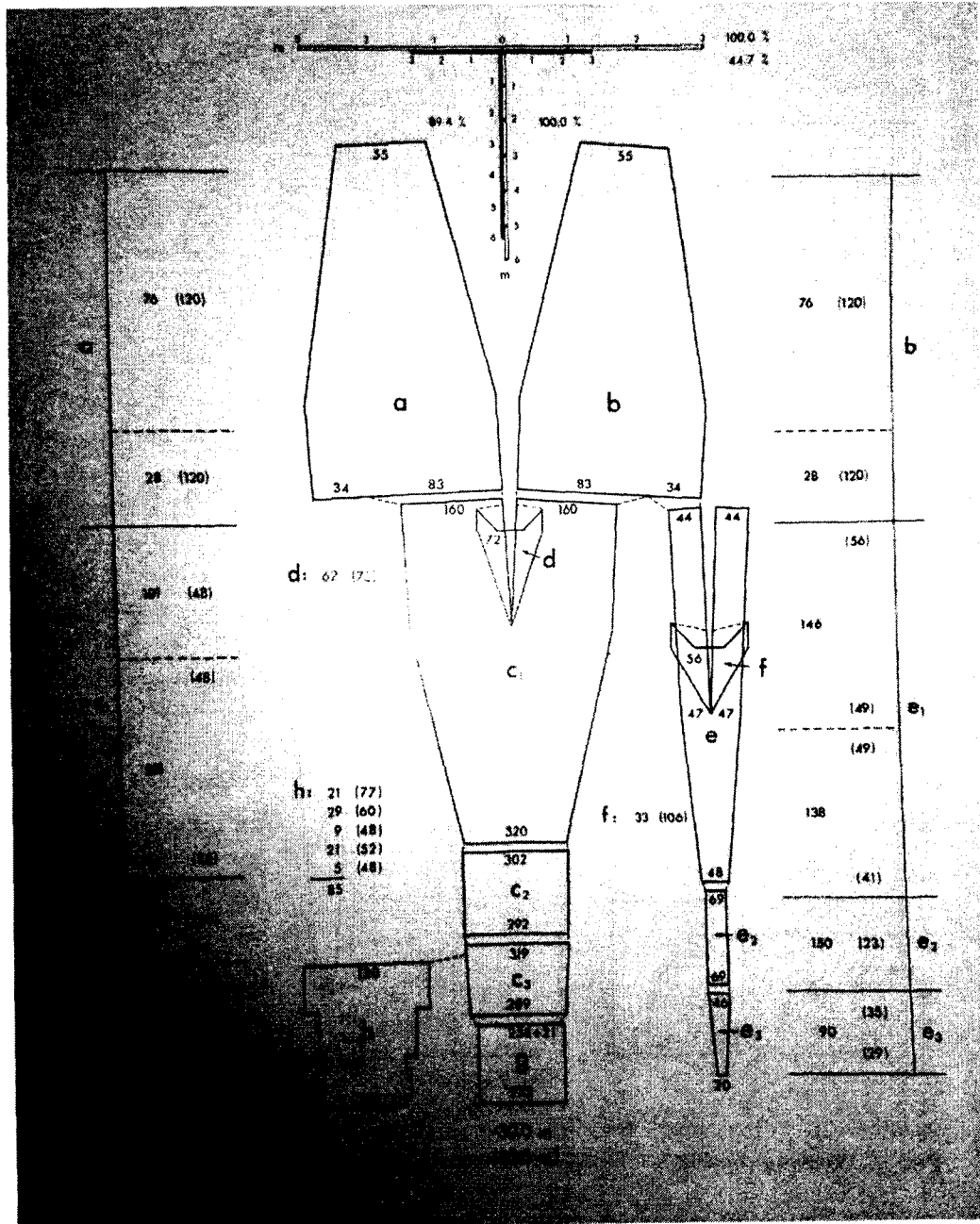

Figure 2-28. Net scheme representative of a synthetic trawl net used on a 80 HP trawler of the Tyrrhenian Sea in late 1960s, from Bilio

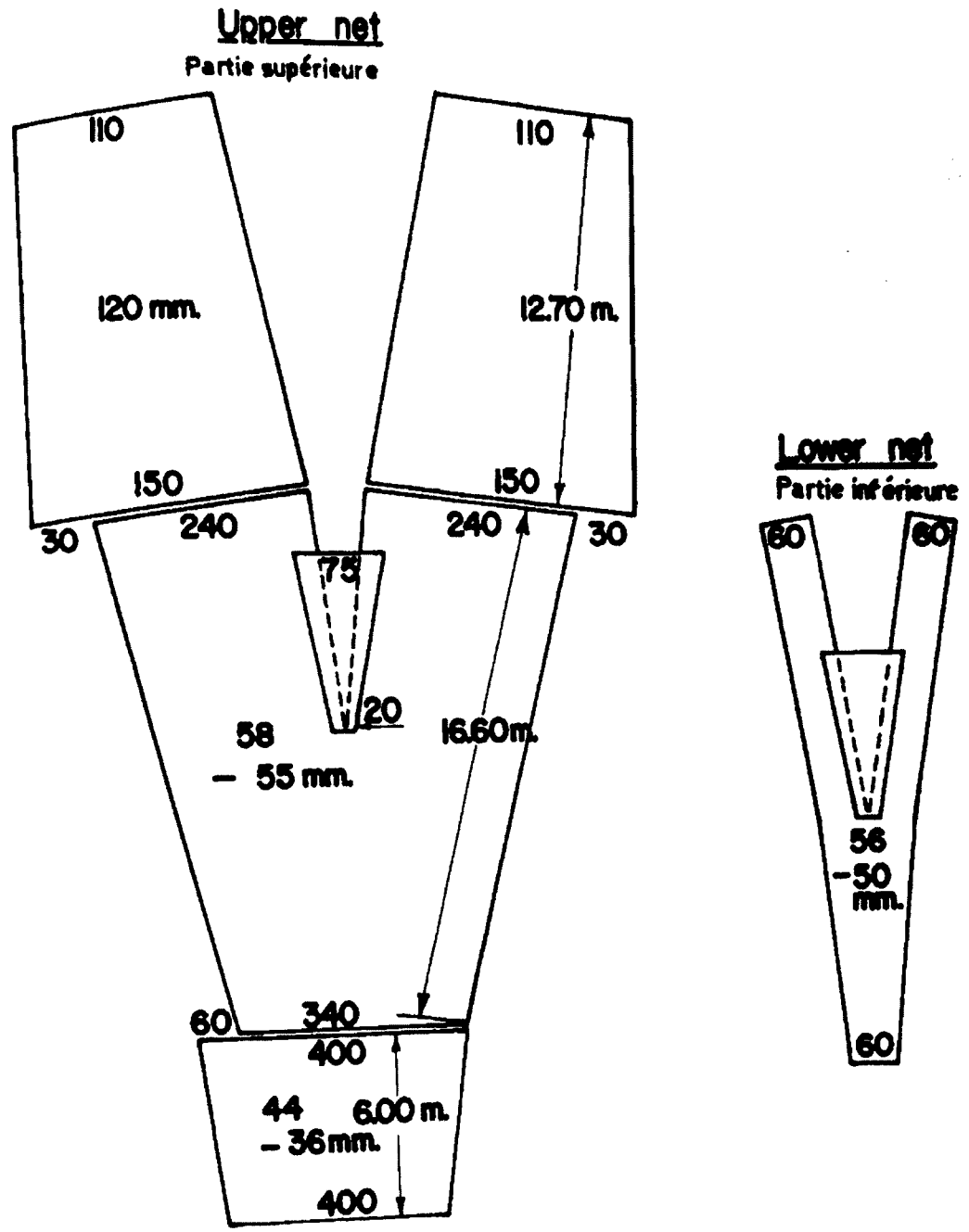

Figure 2-29. Italian traditional net hemp, 1959, source Fao [15], headline=30.4 m , groundrope=35.6m

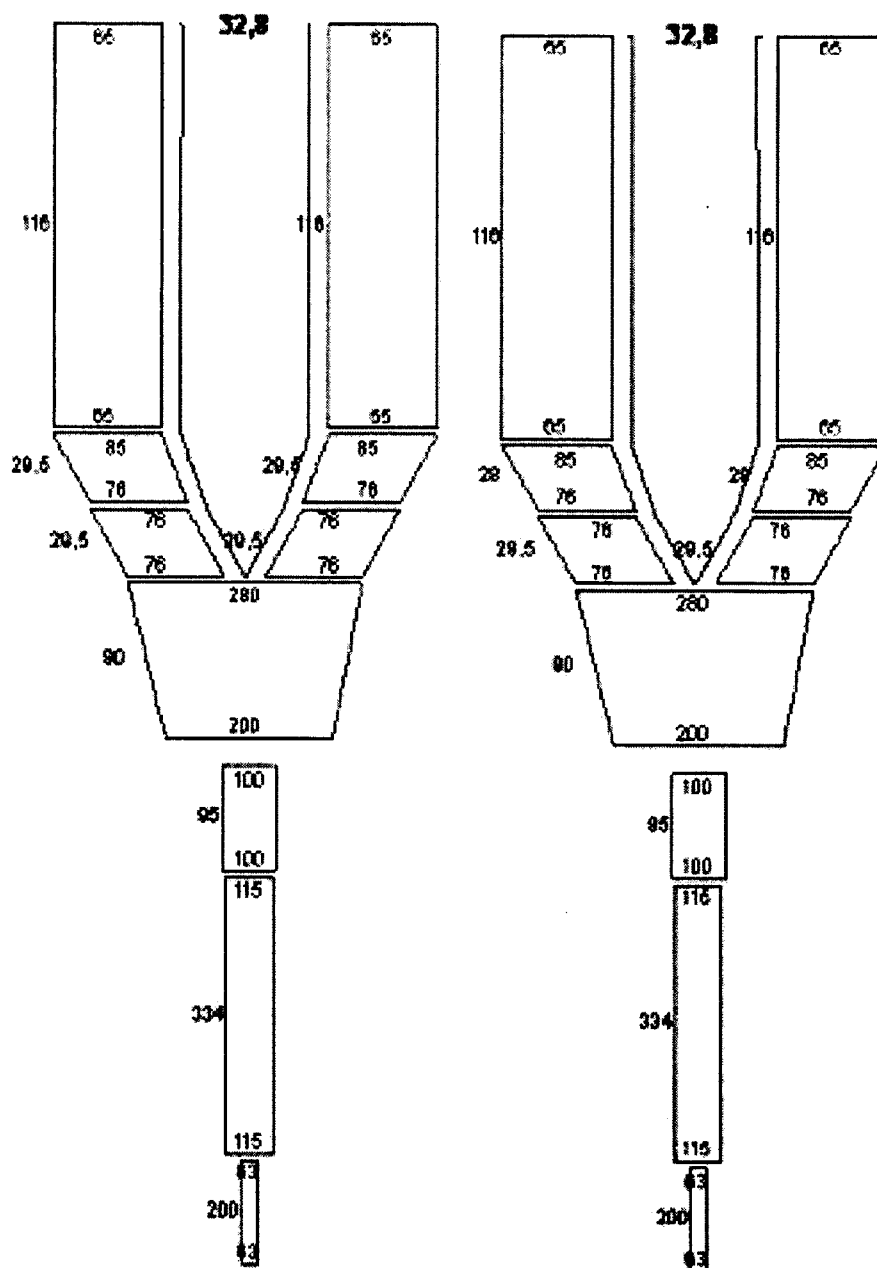

Figure 2-30. Net scheme of a Spanish Sail trawler in 1795 from original drawings and descriptions in Sáñez Reguart

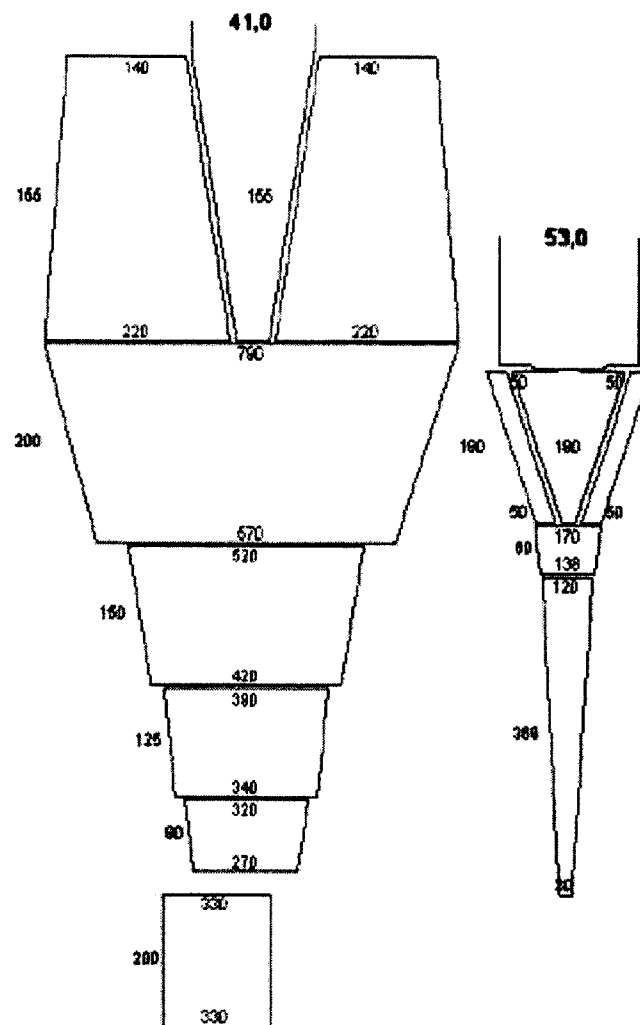

Figure 2-32. Net scheme of the otter-trawl net used in the survey performed by Juckic in 1963-67 on a 180 HP trawler, redrawn after description and scheme in Juckic 1975.

CHAPTER 3

RECONSTRUCTION OF DEMERSAL TRAWL FISHING EFFORT IN THE MEDITERRANEAN SEA

3.1 Introduction

The goal of this chapter is to quantify fishing effort development in the northwestern Mediterranean by estimating vessel number growth rate, HP growth rate, and the expansion of fishing grounds over the past 300 years. The first section of the Chapter describes and summarizes the available historical information in the literature in chronological order and by country following a scheme similar that in to Chapter 1. Historical sources of various types were used since, prior to 1950, there were very scattered and incomplete registers or statistical summaries describing the fleets with a resolution sufficient to identify the type of fishing activity. The second part of the Chapter analyzes fishing activities from 1950 to the present and explains the limitations of the available databases, and the assumptions applied in order to compare them with more recent information. Finally, to reconstruct historical patterns of effort, statistical models are used to estimate the numbers of trawlers and total HP for each country prior to 1950. The results are then compared to data from the last 60 years.

3.2 The expansion of sail trawling and subsequent social conflict 1200-1930

Precisely identifying a baseline for the beginning of trawling for demersal marine resources in the Mediterranean is complicated since the first accounts are exclusively qualitative. Chapter 1 qualitatively defined when each gear entered the fisheries in Italy, Spain and France. To determine the importance of the fleets and their temporal evolution, quantitative data is essential. In the next sections original accounts are reported in order to extract as much information as possible; incorporating all the fleet information in a database

(which has been done) would lose much background information. It is difficult to accurately date the origin of trawl fisheries and intensive exploitation of demersal fish. However, using descriptive references and legislative documents can help develop a timeline of trawling progression in the Mediterranean Sea. As revealed in Chapter One, the first accounts of single sail trawling (*tartana*) date back to the 14th century, although such gear might have existed before. De Nicoló [106, p.214], referencing Dorotea, reports the existence of a trawl gear called *tartana* in use in the Mediterranean since the 14th century.

3.2.1 Trawl fleets in France

The first accounts of conflict between traditional fishermen and trawl fishermen dates back to 1337, when traditional fishers protested against the use of *tartana* (single sail trawl) because of deleterious impacts upon habitat and abundance [107]. In Mediterranean France, the *grand gangui* or *tartanne* fishery developed much earlier than the *boeuf* fishery, and was already recognized as having a high impact in 1631 when its use was limited to certain times of the year [110, p.278]. The same issues arose 500 years later with the invention of pair trawling and fishermen using traditional gear like beach seines and longlines complained again in the 18th century. When trawling appeared, local fishermen complained. The first regulations for pair trawling emerged and, in 1723, when only 8 pair trawlers operated, it was forbidden to trawl in the Gulf of Valencia (Spain). Interestingly, Madoz [170, p.422] reported an exemption to the trawling ban of 1765 in Spain. The exception allowed pair trawling in Valencia and Naples to ensure that the royal tables should never lack flatfish, red mullets, and other valuable fish. In the Kingdom of Naples in Italy, the first limitation to trawling according to Tarigoni Tozzetti [171, p.509], referencing a Royal regulation of June 1627 (*Pesca in Italia*, T.I, P.I. pag. 495), banned or restricted the *paranza* fishery (pair sail trawling). The Tuscan region saw its first regulation much later in 1767 when *tartane* trawling was prohibited 30 years after it started in 1737. According to Parona [78, p.5], in the Ligurian Sea, a regulation (19 Agosto 1749 by the Magistrato de' Provisori delle Galee della Serenissima Repubblica di Genova) banned small mesh gear, particularly the *gangui* and *tartanoni* from Naples (both trawl nets).

While Du Monceau gave extensive details on the trawl gear of his time, he provided no information on fishing fleets. However, he expressed very strong concerns regarding the operation of pair trawlers that, in our perspective, are still valid today. As already mentioned in the Introduction, such statements certainly have scientific foundation but might as well incorporate a bias in favor of traditional fishermen who were economically out-competed by sail trawlers. Two sentences of particular interest are translated and quoted [109, p.154] [translation from original French text by G. C. Osio]:

It results that, from the description we just made, fishing with the Ganguí, called *Boeuf* [pair sail trawlers], is the most damaging of all the trawling activities: first of all because the nets are very long; because the meshes are small; & because the net is loaded with weights and ropes; & in addition as the net is towed with force and speed, it dredges and revolts the bottom, it uproots the marine plants, it does not allow any fish to escape; it greatly damages the valuable fishes that are trapped in the cod-end; finally a third reason is that this fishery is done year around, with any weather and at any depth. In addition it is noticeable the fish depletion in the areas where this fishery operates. However, as the this fishery can be carried out with few fishermen, the *Arrêts* [regulations] of the Council and declarations of the King, that have banned it, have not been able to halt this fishery

To emphasize the concepts, Du Monceau [109, p.183] wrote [translation from original French text by G. C. Osio]:

All the consideration we have made are of the greatest importance to favor the multiplication of fishes. And it would seem like Fishermen, that carry the most interest, should themselves be observing the rules that can't be considered not important. In fact it is the opposite. They have invented Dredges in the Ocean and the trawl fishery with *Boeuifs* [pair sail trawlers] in the Mediterranean, that are very destructive fisheries. They try to retain the smallest fish, even the fry and juveniles; the first to sell as bait to longliners, the seconds to make a kind of *resure* used for fishing sardines. Others use bags of cloth to catch fry...and they use it to feed pigs or to fertilize soil. Others finally, to avoid the infection that dead fry and small fish would cause to the boats while birds eat them, throw at sea this immense source of fish which they can't use. It seems that Fishermen have the mission of destroying fish: which nevertheless represent their entire revenue. I would be glad if I could persuade Fishermen that it's of greatest importance to favor the multiplication of fish, that becomes more and more scarce. They realize it, complain about it and they don't correct themselves at all.

Berthelot dated the introduction of pair trawling (called *chalût aux boeufs* or *gangui bouef*) in the Gulf of Lion to 1720, with influences coming from Catalonia. Despite controversy with small-scale fisherman and legislative interruptions, this technique has endured and expanded over time. This, argued Berthelot, was due to its high profitability and the suitability for trawling of the shallow soft sediments on the continental shelf.

The fisherman of Saint-Laurent de la Salenque were the first to use the *chalut boeuf* in France in 1720. In the port of Sète, twin pair trawling did not start until 1786 with vessels of 10-12 tons. By 1818 the boats had already grown to 20-25 tons and continued to grow up to 1842 [110, p.271]. Fishing operations extended from port in 24 *brasse* (39 m) of water out to 5 Nm. Harvesting occurred all year except from April to June, when it was closed to protect juveniles (Law of 15 April 1791 on trawling in Languedoc-Roussillon) [110, p.269-272]. In Agde and the vicinity, up to 46 pair trawlers of 25-40 tons operated in 1842. In Gruissan and Fleury, fisherman used 25-30 large *tartanes* for trawling in pairs or for shipping. The *boeuf* trawl fishery in this area operated illegally until 1770 when a royal law mandated the destruction of trawl vessels and nets. This law was not implemented, however, as fisherman shifted to single trawling with the *tartane*. In 1790, pair trawling was restored. Twenty-five large *tartanes* operated in the area between Serignan and Saint-Laurent de la Salenque in 1820, fishing at depths greater than 60 *brasses* (96 m) and 12 *milles* (12 Nm) offshore. In Collioure in 1842, 12 *chaluts aux boeuf* were built and in Banyuls 12 similar boats were rigged to fish on bottoms of 40-95 *brasses*. Small *gangui* were used in areas west of Toulon in 1868 and consisted of small sail boats towing a net with wings in shallow water over seagrass beds. Four fishermen comprised the crew, hauling while navigating to the next area. These small trawlers operated only in good weather. A Proudommie (Fishermens association) regulation set limits on ground-rope weights. Some harvesters ignored these rules and used iron bars, which destroyed the seagrass. In Toulon, the small *gangui* operated at 3 *lieuse* (3 Nm) and depths varying between 4 and 15 *brasses* (6.4 and 24 m) [110, p.267]. In 1868 in Marseille, there were 25-30 small *gangui* and 15-20 big *gangui* or *tartane* of 12-15 tons with 10-12 fisherman onboard. The *tartane* had much larger nets and operated at depths of 20-60 *brasses* (32-96 m) and at distances of 8-10 *lieuse* (8-10 Nm) from

the bay of Marseille [110, p.268]. On the coast of the Languedoc and Roussillon regions (Western part of Gulf of Lion) in 1868, twin trawlers (*chalut aux boeufs*) operated using much larger *ganguil* nets than in Marseille [110, p.268]. In the port of Martigues, there were 30 *chalut boeufs* with flat bottoms (18-30 tons and 12-15 fisherman), fishing in a southwest direction due to strong north winds, starting from 4-5 brasses (6-7 m) of depth and going offshore to greater depths.

In 1868, Berthelot [110, p.275] assessed that in the Gulf of Lions 250 trawlers operated for 6 to 8 months at depths between 4 and 60 *brasses* ; at least one third of these were large trawlers. It is estimated that between 1200 and 1500 fishermen were employed in the trawl fishery at that time. In Marseille, Gourret [29, p.21] reported that a trawling ban was enforced from 1793 to 1830 due to concern about the impacts of trawling. After the ban, Gourret reported catches of Mediterranean hake (*Merluccius merluccius*) weighing 7-8 kg and John dories (*Zeus faber*) of 2-3 kg. The consequence of such abundance was that 60 new trawlers were built in a few years once the trawl ban was lifted. These fished between Planier and the Rhône river mouth. After 10 years fishermen were already forced to move to better fishing grounds. These new grounds yielded very good catches that supported profitable activities for years. But by 1870 it was not economical to fish with pair sail trawlers except when fishing day and night with strong Mistral winds. By 1877 pair sail trawlers were no longer used because catches had declined too much and trawling was no longer profitable. Single trawlers (*vache*) were very productive in 1830 but subsequently less and, by 1879, trawling disappeared in the Marseille area. In 1888-1889, an attempt to rig a trawler ended with poor results. Gourret stated that the yields from a *ganguil* trawler in 1890 were only one quarter of the catch from 1868-1875, showcasing the destructive power of trawling.

Due to the proximity to Catalonia and the operation of Catalan pair sail trawlers in international waters, this fishing technique was very appealing to French fishermen in the Roussillon region, although still controversial. Local fishermen had protested the introduction of pair trawling at the beginning of the 18th century and it was subsequently banned in certain periods. Finally, in 1819 and 1820 in Banyuls and Saint Laurent, it was

authorized from October to March at more than 3 miles distance from the coast [8, p.65]. Collioure followed in 1836 and at that time the no-trawl zone was reduced to two miles from the coast. After that the sail trawl fishery expanded and in 1861 the fishing period was extended to the month of May. At the beginning on the 20th century Banyuls was an important port and had 20-25 pairs of pair sail trawlers (40-50 boats) [8, p.66]. The catches between 1902 and 1907 averaged 58 tons. This yield was significant since the trawl fishery operated only between the end of August and November and from March until May. In Collioure at this time, 12 pair sail trawlers (24 boats) operated, while in Port Vendres there was no trawl fleet [8, p.67]. After WWI and until 1930, there were approximately 10 *bouefs* in Banyuls and 20 in Collioure [8, p.68].

3.2.2 Trawl fleets in Spain

Berthelot also reconstructed the history of trawling in Spain and, on multiple occasions, stressed similarities between the French and Spanish fisheries of the time period [110, p.300-307]. According to Berthelot's accounts, early regulations banning trawling gears like the *tartanne* and *gangui* emerged around 1723, when it was forbidden to trawl in the Gulf of Valencia. In 1726, the pair trawl fishery was restricted to 15-16 couples of trawlers *parejas*. In 1765 in Valencia pair trawlers were reauthorized and 24 trawlers operated in pairs, in addition to the those fishing for the royal court and for the ambassadors of France and Naples. Since 1766, all restrictions on trawling were lifted and boat sizes increased to 15-25 tons for better sea worthiness. In 1786, along the Valencia coast in the districts of Grao, Canamelar and Cabanal, 62 pair trawlers and 466 small-scale vessels operated. Most trawlers worked in the Gulf of Valencia but some fished in the Andalusia region (where many moved permanently in 1791). Trawling was banned again in 1817 by royal law but was reauthorized two years later. By 1821, Valencia's fleet reached 50 pair trawlers of 15-25 tons (with 22 fisherman on crew each) and 12 trawlers of 6-12 tons (with 12 crew members). In Malaga in 1800, Count La Laing obtained the concession to operate 4 pair trawlers that were otherwise not allowed in the area. On the coasts of Andalusia there were 62 trawlers and by 1862 these boats had increased to 100. Eighty pair trawlers

(*parejas de bou*) of small tonnage and crews of 6-7 men operated on the Barcelona coast in 1844 [110, p.381].

On the coast of Malaga trawling activities were banned in 1828 while in other areas (Cadix, Sanlucar and Huelva) trawling activities continued and even expanded. When comparing landings in 1831 and 1861 for these areas, all quantities increased, but the largest increase was in Malaga where only a small-scale fishery operated. Landings doubled in Cadix and Sanlucar, tripled in Huelva, but increased about 12 fold in Malaga (Table 3.1). Berthelot saw this case [110, p.294] as evidence of the higher selectivity and long term yields of small-scale activities compared to trawling. In addition, small-scale fisheries had social advantages since more people were employed.

Table 3.1. Comparison of fish landings in areas of Spain where there had been a trawling ban over the period 1831-1861 (Malaga) with areas where trawling had not been banned (Cadix, Sanlucar and Huelva)

Maritime Province	Trawl Ban	Year	Catch (Kg)	Year	Catch (Kg)
Cadix	No	1831	1,095,225	1861	2,342,137
Sanlucar	No	1831	450,237	1861	1,070,050
Huelva	No	1831	896,475	1861	2,818,525
Malaga	Yes	1831	660,925	1861	7,778,162

The *Estatistica de Pesca* [96, p.] reported in 1893 a total of 1,061 *bou* trawlers along the Spanish Mediterranean coast, which are all assumed to be sailing trawlers. The number of vessels broken down by region is: Cadiz (55), Malaga (10), Almeria (15), Sanlucar (52), Alicante (80), Tarragona (179), Barcelona (521), Mallorca (139), and Mahon (10).

3.2.3 Trawl fleets in Italy

Reconstructing the history of the trawl fishery in Italy is more complicated than in France and Spain because unification only occurred in 1860. The current Italian State was comprised of a number of states in the 17th and 18th centuries. For instance, in 1773 within the boundaries of present day Italy there was the Papal State, the Kingdom of Sicily (under Spain), parts of the Austro-Hungarian empire, the kingdom of Sardinia, the Republic of Genoa, the Grand Duchy of Tuscany, the Republic of Venice, the Republic of Lucca, the

Duchy of Modena, the Duchy of Parma, and the Bishop of Trento. As a consequence, there are no uniform statistics before 1860, and statistics remained very general for many years after in regards to the fishing industry.

Since Italian unification, statistics on maritime activities, including fishing fleets and landings, have been collected [1]. One main focus was the movement of fishing vessels within Italian and Mediterranean waters. A quantitative list was given of the numbers and types of vessels, however, type of fishing gear was not reported (with the exception of the sponge and red coral fisheries). In 1865, 32 categories of maritime vessels ranging from less than 6 tons to more than 1000 tons were listed. The following types of vessels were used in the trawl fishery at the time: *Tartane*, *Martingane*, *Paranze*, *Paranzilli*, and *Baragozzi*. There is great uncertainty concerning the *Martingane*. Du Monceau and others reported that these vessels were used in the trawl fishery in the 18th century. However, in 19th century descriptions, this type of boat is rarely associated with fishing. Statistics recorded some of the *Martingane* at over 100 tons, which is much greater than the average tonnage of sail trawlers. Based on this consideration, this type of boat has been excluded from our analysis. Additionally, some of the *Tartane* and *Paranze* alternated between fishing and shipping activities [172]. These vessels have been counted as trawling vessels and totals compared with estimates from other sources from regional statistics. According to the National Institute of Statistics in Italy there were 2,262 sail trawlers in 1864, 2,078 in 1865, and 1,599 in 1869 (Table 3.2).

Table 3.2. Italian trawl fleet in 1864-65, according to ISTAT [1]

Year	Vessel Type	Number	Tons
1864	<i>tartane</i>	300	17894
1864	<i>paranze</i>	1601	31467
1864	<i>baragozzi</i>	361	4686
1865	<i>tartane</i>	302	18231
1865	<i>paranze</i>	372	7823
1865	<i>paranzelle</i>	1031	19769
1865	<i>baragozzi</i>	373	4783
1869	<i>tartane</i>	331	17888
1869	<i>Paranze e Paranzelli</i>	1268	23185

The statistical bulletins following 1864, 1865 to 1869 and until 1937 did not detail the types of fishing vessels and cannot be used to reconstruct the trawl fleet. For this reason, the next paragraphs will describe the Italian trawl fishery using the geographical areas of the Adriatic Sea, the Tyrrhenian Sea, and Southern Italy.

3.2.3.1 Adriatic Sea

In 1609, 1611, and 1630, the Marche region implemented bans against the *tartana* (single sail trawl) fishery [7, 46]. Such bans targeted some *tartane* sail trawlers coming from Martigues (France) [106, p.118]. In 1610, the Council of Ancona had granted permission to 11 of these boats to trawl in its water to supply the city with fish [106, p.119]. In 1680 on the coast of Fermo (Central Adriatic, Italy) approximately 40 *tartane* were active [7, 31]. Twenty *tartane* trawlers were reported in 1740 in Fermo. Further north, in Chioggia in 1784, 164 *tartane* and 150 *bragozzi* (Adriatic sailing pair trawlers) were rigged, employing 3,500 men [10, p.58]. According to Errera [173, p.277] in 1873 in Chioggia 24 *tartane* employed 192 fishermen, and 572 *bragozzi* employed 2264 fishermen. By 1883, the numbers had grown to 800 *bragozzi* and about 50 *tartane*, with 6,000 fishermen in total. The classic trawl boat of Chioggia was displaced by the *bragozzo*, a much smaller, less expensive trawler suitable for pair trawling. In 1868, 50 *tartane*, 550 *bragozzi* and 700 *battelli* were reported [174, p.203]. But by the end of the 1800s, only two *tartane* were left. Faber [10] described the fisheries of the Adriatic in 1883 and reported a broad range of information on fleets, gear, yields, and regulations. About 580-590 (a total of 6,000 tons) from Chioggia and 10-20 from Romagna (Italy) fished in the Austro-Hungarian (East Adriatic) region in 1869. According to the Austrian Ministry of Commerce, in 1869, the fishing fleets of Chioggia and Pellestrina were composed of 41 *tartani* of 1,106 tons, 399 *bragozzi* and 133 *bragozzetti* for a cumulative 3,764 tons, and 626 *battelli* of 1,743 tons [10, p.56].

In 1869, 525 fishing boats [175, p.138] operated in the maritime district of Ancona, but its not clear how many of each type there were. Among these were the *paranze* and *bragozzi* (also called *schiletti*) and small boats used to ship the fish to land. The *accappa sfoglie* were used in this area to catch flat fish. For the maritime district of Rimini (Central Adriatic) the

numbers of trawlers in 1839 and 1869 are available [175, p.161]. In Fano, sailing trawlers increased from 15 to 38 and vessel tonnage also increased. Pesaro went from 14 to 30 trawlers. Cattolica increased from 4 to 36 sail trawlers. Rimini had 140 vessels in 1839, but only 50 in 1860. Cesenatico built a fleet of 16 sail trawlers after the arrival of the *Chioggioti* in 1869. The construction of boats in the district was similar to that of the *bragozzo*. There were 184 *bragozzi* overall between 10 and 35 tons. Tarigoni Tozzetti [175, p.465] remarked that one of the reasons the *bragozzi* were preferred over the *tartane* is that when *tartana* trawled sideways there was high risk of capsizing if the net became entangled on the bottom, especially in high winds. The *Chioggioti* learned how to fish with *cocchia* gear from fisherman in Puglia (Southern Italy) during the Venetian Republic [175, p.464].

3.2.3.2 Tyrrehnian Sea

An early trawling regulation in the Grand Duchy of Tuscany (today's Tuscany) from 1767 banned fishing with *tartane* and the *trabacco* [176, p.685] [177, p.486]. While this account does not give quantitative information about trawling vessels, apparently there must have been a significant number of them if a regulation was implemented to control or ban this gear.

Under the Napoleonic domination in Tuscany, as in other areas, most fishing restrictions were lifted and trawling was readmitted until the Restoration [176, p.685]. In 1822 a regulation limited the time of the year when *paranze* (pair trawlers) were allowed to fish, but in 1831 this ban was lifted [176, p.686]. The first quantitative analysis of the trawl fleet occurred in 1850, according to a statistical report from the Grand Duchy of Tuscany [172, p.307]. At that time, different types of fishing vessels of unclassified type were registered but, based on vessel type and size, there could have been as many as 62 *paranzelle* and 9 *tartane* trawling. Coccoluto Ferrigni claims that in Tuscany in 1866 there were 106 *paranzelle* with tonnage varying between 13-50 tons [9, p.33].

3.2.3.3 Ligurian Sea

Parona [78], citing data from the Maritime Ministry, reported the numbers of *paranze* (pair sail trawlers) and smaller trawl gear in the maritime district of Liguria for the period 1890-1895. The *paranze* increased from 50 in 1890 to 91 in 1896, and the *tartane* from 307 to 312 over the same period. Ligurian vessels were, according to Parona [78, p.10-12], the *paranzelle* (sailing pair trawlers) that used a net with a 4 m long bag and mesh of few millimeters, and 20m long by 1.5 m high wings with mesh between 1 and 10 cm. In Tuscany, such nets were called *Martingane*. The *tartanone* was similar to the *paranzella* but heavier and stronger. The *gangano* was a net bag with no wings and an iron structure that kept the net mouth open, similar to a beam trawl.

3.2.3.4 Southern Italy

In the 18th century pair trawling developed in Southern Italy as well, in what was, at the time, the Kingdom of Two Sicilies under Spanish domination. According to Salvemini [178], the *paranza gaetana* (also called *bilancelle* or *paranzelli*), a pair sail trawler, developed in the Gulf of Gaeta (Naples) in the mid of 18th. Complaints of fish declines began almost immediately and the cause was attributed to the *paranze*. The first legislation restricting the operations of trawlers in the Tyrrhenian Sea, in the Naples area, were implemented in 1784. They reduced the expansion of pair trawling in the area. In Puglia, however, less conflict with small coastal fishermen allowed a greater expansion of trawling in the Southern Adriatic as well as in Campania (Central Tyrrhenian) [178, p.445]. Under the Kingdom of Two Sicilies, trawling with *paranze* and *tartanoni* was forbidden in 1835 [179, p.279]. By the mid 1700s there were 34 *tartane* and other large fishing vessels in Trani, 70 fishing vessels (of undefined type) in Bari, and 6 *barche bastarde* (used for shipping and fishing), 9 minor fishing vessels, and 34 larger fishing vessels, of which 16 were registered as *gaetane* (pair trawlers) in Molfetta [178, p.448]. Overall in 1750, at least 53 *tartane* and 16 *paranze* fished from Puglia. By 1841, these numbers increased to 349 *paranze*, and reached 295 *paranze* by 1852, according to data reported by Salvemini [178, p.448]. On average *paranze* trawlers from Puglia were between 15 and 23 tons. In 1869 in the maritime district

of Bari (Apulia region), 348 sailing trawlers (called *paranzelli a vela*) were in operation. [175, p.123]. This fishery harvested all year long, night and day. Boats from the Bari district fished from 3 miles to 50 miles offshore. They also started fishing for long periods of up to 6 months, and even 1-2 years in Thyrrenian, Greece, Turkey and Egypt [178, p.462]. By the end of 20th century, the trawl fleet in Puglia showed signs of decline due to social causes and overexploitation of local fish stocks.

3.2.4 Quantifying fishing days of sail trawlers

Marion [89, p7.] monitored the numbers of fishing days for small fishing boats and for sail trawlers, categorizing days as “easy fishing”, “difficult fishing” and “impossible to fish” (Table 3.3). On difficult fishing days small vessels cannot fish, but large pair trawlers need a strong breeze to be able to fish. For pair trawlers, Marion argued, difficult fishing days should be counted as favorable days and a large number of impossible days would be suitable for trawling. Therefore we can approximately estimate the number of fishing days for large trawlers as being all the difficult days plus half of the impossible days. This gives an average of 142 fishing days for trawlers in Marseille over the period 1893-95.

Table 3.3. Number of yearly fishing days in Marseille (France) 1893-95, according to Marion

Year	Easy fishing day	Hard fishing day	Impossible fishing
1891	172	92	101
1893	187	114	64
1894	180	121	64
1895	200	94	71

Ferretti reported on average 240 fishing days in Fano (Central Adriatic, Italy) for sail trawlers in 1911 [16], however this estimate does not specify that fishing is by means of trawling exclusively. Commonly, fishermen used fixed gear such as long-lines and gillnets when there was not sufficient wind for trawling. Mancini reported that in the Tuscan Archipelago in 1919-1920 the *paranze* sail trawlers could operate in winds in the range 1-5 Beaufort and sea force 0-4. Fishing days for sail trawlers are reported in Table 3.4 for the

Month	Argentario 1919	Argentario 1920	Giglio 1920	Elba 1919	Elba 1920
January	na	24	24	20	27
February	na	23	23	20	26
March	21	24	24	23	21
April	29	23	24	29	27
May	27	14	15	24	21
June	24	25	27	16	25
July	27	25	26	26	23
August	28	24	22	25	27
September	26	22	24	27	23
October	25	25	27	27	25
November	25	20	22	27	24
December	17	24	26	24	26
Total	249	273	284	308	295

Table 3.4. Number of fishing days for sail trawlers on the Tuscan Archipelago in 1919 and 1920, from Mancini

areas of Argentario, Giglio and Elba island (Tuscan Archipelago, Italy) [112, p.56]. For the Giglio and Argentario areas, the *paranze* fished approximately 270-280 days per year and in the Elba region, approximately 300 days.

3.3 The transition from sailing to mechanized trawling 1900-1950

3.3.1 Motorized Trawling

Motor trawlers with diesel or gasoline engines started appearing in the Mediterranean after World War I (WWI). As previously noted, motor and steam trawlers differed significantly in size as well as engine type. Motor trawlers were comparable in size to traditional sail trawlers, while steam trawlers were much larger. Detailed descriptions are given of fleet evolution on a country basis in the next sections.

3.3.2 Trawl fleets in Italy

Ruggero de Angelis [180] reported that in Italy in 1920 there were two steam trawlers and 20 fishing vessels with auxiliary engines. By 1921, there were 8 steam trawlers, 3 motor trawlers, and 26 vessels with auxiliary engines. The Italian Fascist Government, from 1920-1930, put great emphasis on developing an industrialized motor trawler fleet

to achieve fisheries autarky. For this sake, the Banca Nazionale del Lavoro created the Credito Peschereccio (Fisheries credit) to facilitate technical and industrial development [181, p.17].

In 1937, the National Statistic Institute (ISTAT) made the first national assessment of the Italian fishing industry both in terms of landings and effort, in marine and freshwater fisheries and aquaculture [2]. However, the available report is only an appendix with partial results. The full report was never published, as Salvemini suspected [178]. ISTAT reported the fishing fleet by category of vessel, fishing area/destination, and fishing system with two subcategories for exclusive or partial use of certain gear. Vessels and tonnage are reported within gear types. In addition, the year of construction is given for each vessel category for number of boats and tonnage. Numbers, tonnage and HP are reported in Table 3.5, however, these represent all trawlers registered in Italy, while different numbers were licensed to fish in or out of the Mediterranean. Of motorized trawlers, almost 50% operated outside of Italy, while the majority of sail trawlers remained in national waters in 1937.

Table 3.5. Italian trawl fleet in 1937 according to ISTAT [2], (1) denotes all the vessels licensed in Italy while (2) the vessels fishing in Italy. HP(1) is total Horse Power and Tons (2) is total tons of entire Italian fleet. (3) *velieri m.a.* are sail trawlers with an additional motor for hauling fishing gear or navigation, but not for fishing.

Vessel category	N.trawlers(1)	N.trawlers(2)	HP(1)	Tons(1)
<i>piroscafo</i> (steam-trawler)	84	36	20511	9832
<i>motonavi</i> (motor-trawler)	107	59	11202	3800
<i>motovelieri</i> (sail-motor trawler)	99	55	6898	1848
<i>velieri m.a.</i> (3) (sail trawler)	898	477	49888	15413
<i>velieri</i> (sail trawler)	968	784		9695
<i>barche</i> (small trawler)	414	2404	4884	5477
<i>barche</i> (small trawler)		2404	4884	5940

3.3.2.1 Adriatic

Ferretti gave a detailed description of the trawl fishery in Fano (Central Adriatic, Italy) in 1911 [16]. The fishing area was between Ancona and Rimini and across the Adriatic

all the way to Dalmatia (Croatia today) and did not exceed depths of 100m. Steam time could be up to 6-7 hours for a distance of approximately 75 nm. In Fano, there were two types of sail trawlers: the *barchetto* (also called *trabaccolo* and equivalent to a *bragozzo*) with two masts, and the *battello* (also called *tartana*) with only one mast (3-4 tons). The *barchetti* ranged between 6-30 tons, but started growing in size in 1890. There were 3 categories of *barchetti*:

1. Small, 6-10 tons, 8-10 m long and 3-3.30 m width. These were mainly used with beam trawls.
2. Medium, 10-20 tons, 14-15 m long and 4.80-5m wide. These were used with beam trawls or trawled in pair with a medium *tartana*.
3. Large, 15-17 meters long, and 5.30 m width. These vessels were mainly used for pair trawling with the large *tartana*.

The *barchetti* were supported by a *batelott* that made daily or twice-daily trips to shore to land the catch and get supplies for the vessel. The *batelott* were 2.5-3 tons with one mast and a two person crew.

Table 3.6. Fishing fleet Fano 1910

Type	Tons	Number
<i>Batelot</i>	2.5-3	30
<i>Battelli</i>	1-5	35
<i>Barchetti small</i>	5-10	15
<i>Barchetti medium</i>	10-20	51
<i>Barchetti large</i>	20-30	14

By 1932 in the same region, the Italian Fascist Government gave a special line of credit to facilitate the purchase or construction of new motor trawlers. From 1932 to 1940, 82 new vessels entered the fishery supported by this program [181, p.20]. In 1938, Fano was the Italian port with the highest number of motor trawlers (68) and had the second highest total HP (3,778) after S. Benedetto (with 6,182 HP) [181, p.21]. By 1940 Fano increased to 72 trawlers with a total of 5,090 HP.

3.3.2.2 Tyrrhenian Sea

Mancini, during the fishing experiments carried out in the Tuscan Archipelago in 1919, reported local fishing fleet characteristics along with average estimated yields. The trawl fleet fished at depths that ranged between 10 and 100 m, but mostly in deeper waters [112]. Overall, in 1919 53 *paranze* fished in the area.

During his exploratory fishing of Sardinia, Mancini reported the status of the local fishery [77]. In Arbatax, there were only a few long-liners and in Cagliari, the 20-30 fishing boats had very simple fishing gear and did not use trawls. Before WWI, *paranze* trawlers from Resina (Naples) used to fish in the Gulf of Cagliari but conflicts with local fisherman made them leave the northern part of the Gulf. Two *paranze* operated in the Gulf in 1919, and one in 1920, all of them coming from Resina. In 1916 a 40 ton motor trawler and with a 40 HP diesel engine fished in the Gulf from July to September. Mancini [77, p.41] estimated approximately 200 fishing days for a motor trawler in southern Sardinia, less for a sail trawler. In the Maritime District of S. Antioco, 20 *paranze* with 140 fishermen were registered in 1919. These operated mainly in the Iglesias Lagoon and estuary. In the Gulf of Terranova and Asinara there were multiple *paranze*.

The operating fishing depth of motor trawlers in the Tuscan Archipelago did not exceed 200 m in the 1920s [118]. According to Iseel [118], the trawl fishery in Liguria was the first to fish deeper than 300-400 m in 1930. The fishermen of Porto Santo Stefano (Tuscany, Italy) were already fishing at depths of 500 m by 1932. In 1937, 45 trawlers operated between Porto Santo Stefano and Porto Ercole with the most powerful ones (100-150-200 HP) fishing between 300-500 m [118]. About 20 steam and motor trawlers fished in Livorno. In other parts of Tuscany, some individual sail or motor trawlers also fished.

3.3.2.3 Southern Italy

Police [?, p.17] described the fishery of Calabria (Italy) in 1930. While this was primarily a small-scale fishery targeting small pelagics with longlines, there were a few trawlers. Two steam trawlers (*Alessandra* and *Giovanna*) from Naples fished with otter trawls in the area of Fuscaldo at depths of 30 m. In Fuscaldo, 8 *tartane* fished before the arrival of the

steam trawlers. In S. Eufemia, fishermen from Naples operated 8 *paranze*. In Pizzo two steam trawlers fished: the *Nanuk* 103 tons and 147 HP owned by Ricotti and the *Teresina* 28 tons and 140 HP owned by D Pizzonia. In Tropea there was 1 steam trawler and in Gioia, 8 *tartane*. In the following motor trawlers Crotone operated: *Tetide* and *Anfitrite*, owned by Vecchi, 21 tons (TSL) and 40 HP; *Emma* and *Francesca*, owned by Foti, 20 tons and 40 HP; *Nuova Annina* and *Nuovo S. Michele*, owned by Ranieri, 23 tons and 40 HP [?, p.72]. The Crotone vessels were pair trawlers (*paranza*) operated by fisherman from Puglia. According to Pierleoni these motor trawlers fished 300 days per year and towed approximately 4 times per day. Yields were between 60 and 90 tons per year [81, p.21]. In Ciró Marina there were 15 *tartane* [?, p.76], while in Trebisacce six *paranze* operated [?, p.92]. It appears that there was no trawling tradition/knowledge in Calabria in 1930 as all trawlers there were run by fishermen from outside the region. In addition, trawlers from Campania and Puglia fished in the Calabria waters [?, p.97].

The early 1920s saw the beginning of mechanized trawl vessels in Puglia (Southern Adriatic). In 1927 there were 18 motorized trawlers in Bari, increasing to 32 in 1930 and to 37 in 1931-32 [178, p.484]. The advent of motorboats made traditional sailing *paranza* obsolete very quickly since catches were 7-8 times higher than for *paranza trawlers* [178, p.484]. Harvesters, however, recognized that large trawlers were not economical on the limited resources of the Mediterranean and many sailing *paranze* switched successfully to motorized vessels while maintaining traditional techniques [178, p.486]. In Puglia the motorized fleet increased very rapidly from 30 to 96 motor trawlers in the period from 1927 to 1933.

In 1926 Ermiro [6] reported 13 trawlers fishing on the southern banks off Lampedusa (Sicilian Strait). Among these were 10 steam trawlers (ranging between 86 and 235 GRT) and 3 diesel engine trawlers (of 9 and 90 net tonnage). During the same period in Mazara (Sicily), there was one motor trawler, two *paranze* with engines, and 50 sail powered *paranze*. In Sciacca (Sicily) 8 *bilancelle* and 10 un-decked sail boats fished by trawling. Here, the trawlers operated along the coast down to depths of 150-200 m. In Porto Empedocle (Sicily), there were 206 fishing vessels totaling 902 tons, but it is unclear how many

were trawlers. Among these there were 6 steam trawlers between 30 and 42 m long, 50-100 tons, with 5-6 days of continuous sailing and fishing capacity. In 1930, 9 sail powered *paranze* of 10 tons [55, p.6], each with a 6 man crew, fished in Pozzallo (Sicily). These normally fished between Mazzarelli and Capo Passero within 10 nm of the coast but could go 20 nm offshore on banks of 90-100 m in good weather. Fishing occurred all year except in the 3-4 winter months. Tows lasted up to 6 hours and each haul in the cold season yielded 300-600 kg. They caught primarily hake, red mullets, gurnards, flat fishes, octopus, squid, and some lobster. Steam trawlers from Siracusa and Catania (Sicily) also fished in this area in the winter. Each sailing *paranza* caught about 100 tons per year (8-9 months of fishing) [55, p.7], averaging about 11.7 tons per month. In Augusta (Sicily), there were 2 sailing *paranze* of 16 tons and 8 fishermen each. Solari reported catches with the *Tritone* experimental trawler of 2 tons per hour in the area of Zuara (Libya) [55, p.42].

3.3.3 Trawl fleet in Spain

Miranda and Riveira (1923) [98] provided useful information on the Spanish Mediterranean fleet in the 1920s; the most relevant information is summarized in this section. In the Maritime District (MD) of Torre Vieja the *bou* fishery (pair sail trawling) operated from September 1st to April 30th in compliance with fisheries regulations. There were 8 *parejas* (8 pairs of sail trawlers) [98, p.125]. In the MD of Santa Pola there were sail trawlers, but the number is unknown. One hundred twenty pair sail trawlers operated in the MD of Valencia in 1920. In addition, two trawlers had both a sail and a motor. The sail trawlers carried 14 types of nets for each pair. From May to August when trawling was prohibited, longlines, gillnets and pots were used [98, p.140]. There were 70 pair trawlers in Vinaroz, 40 in Torrenostre, and 18 in Peñíscola [98, p.144]. Miranda and Riveira reported the number of nets (*artes*, divided by type) for other ports but it is not useful for reconstructing the fleets. Since trawlers have multiple gears there seems to be no fixed relation between number of nets and fleet composition.

In 1955, Bas et al. [12] wrote extensively on the fishing activities in Catalonia for the period 1900-1950. A small fleet of trawlers operated in the port of Llançà in 1955. This fleet

included 6 trawlers that ranged between 14 and 27 tons and 45-110 HP. The pelagic fishery was the main focus for fishers in Port de la Selva since 1900 [12, p.277-280]. In Rosas in 1955 there were 24 trawlers of 11-45 tons and 40-120 HP and carrying an 8 fishermen crew on average [12, p.287]. In 1913 there were between 11 and 22 pairs of sail trawlers (*parejas*) and in 1911, one motorized trawler fished in this area [12, p.287]. In L'Escala, *parejas fe bous* appeared at the end of the 19th century. By 1912 there were 12 couples, and 14 in 1914. By 1920 there were 5 trawlers (*art de traina*) and by 1945-48, the number had reached 54, however, it decreased to 40 in 1950 [12, p.293]. Some trawlers fished out of L'Estartit, but the method was abandoned in this region sometime after 1930 [12, p.295]. In Palamós from 1908 to 1914 there were 16 pair sail trawlers, and in 1917 35 vessels fishing with the *encesa* were converted into trawlers. The trawl fleet was comprised of 40 motor trawlers by 1955 [12, p.298-299] with more powerful engines than other ports due to fishing depths in the area. Vessel length was between 9 and 16.5 m, with a tonnage from 7.7-46.5, and 23 and 90 HP engines. Other trawlers of 35-40 tons had engines of 112 and 110 HP. The trawl fishery was year round and since 1933 fishing trip duration was regulated for departure from port at 6 am and return at 6 pm. In summer months the fishery mainly focused on red shrimps (*gamba*), for this reason, a Catalan trawl that required low tow speeds was the gear generally used [12, p.300]. In 1955 in Saint Feliu de Guíxols, there were 5 motor trawlers ranging from 7 tons and 15 HP to 17 tons and 55 HP. Trawlers could fish from 6-7 am to 6 pm [12, p.303].

Blanes was an important fishing port in the first half of the 20th century for trawl fleets due to the extension and variety of habitats on the continental shelf. Until 1933, Blanes was under the Maritime compartment of Mataró, then went under Sant Feliu de Guixols. Port construction started in 1914 and was finished in 1948, but was already functional for fleet motorization in 1927-1928 [12, p.308]. In 1955 the fleet consisted of 21 trawlers ranging between 3.5-37.5 tons and 10-120 HP. The average trawler was 10-15 tons, 40-60 HP, with a crew of 6-7 fishermen. Prior to 1927, there were 20 sail pair trawlers approximately 10 m long and 3-4 tons. Before the construction of port facilities, sail trawlers were hauled onto the beach. Around this time they also started experimenting with otter doors in pair

trawling. The fishermen of Blanes made their living exclusively from fishing, while in ports described above many were also farmers. In the 1950s, fish was sold at auction and buyers from Barcelona and Badalona used to buy here. Fleet modernization in 1927 allowed the exploitation of much deeper grounds and the harvest of new species like red shrimps and *cigalas* mantis shrimp [12, p.304-311].

By 1955, Sant Pol de Mar had 11 motor trawlers of 9 ton average, 15-25 HP, and 5-6 man crew [12, p.313]. In the period 1925-1930, there were 14 pairs of sail pair trawlers (28 boats). Mataró, at the beginning of the 1900s, counted 17 pairs (34 boats) of sail pair trawlers. At the end of the 1930s, 8 motor trawlers were built of 7-8 tons and 15-45 HP. These began fishing in 1955 and were hauled on the beach due to the lack of a safe shelter. Fishing in 1955 started at 5 am and trawlers needed to return to port by 5 pm [12, p.315-318]. Badalona had 45 sail pair trawlers in 1870 and added three more by 1878. The trawl fishery subsequently declined and by 1933 only 22 sail trawlers were left. Fleet motorization began in 1934 but the new trawlers used the port of la Barceloneta since the catch could no longer be landed on the beach. In 1945 there were 11 *embarcacione quilladas* [12, p.320]. Barcelona, in the 19th century, was characterized by a sail trawl fishery. Twenty-six pairs of *parjehas de vela catalanas* operated in 1924, later called *quilladas*, that included *quillats a motor*. In this year, most sail trawlers were converted to motor power. In 1955, 56 diesel motor trawlers of 2-70 tons and engines with an average HP between 35 and 152 HP operated from this port. In addition, 22 motor trawlers had gasoline motors, but were not operating with them due to high gasoline prices [12, p.324-328]. Vilanova i La Geltrú had an important trawl fleet in 1955, consisting of 20 small trawlers, *arrastrillos* of 7 tons, 12-20 HP and 5-6 fishermen. Such boats fished in shallow coastal areas. The 9 bigger trawlers averaged 30 tons, HP between 60 and 100, and lengths between 17 and 19 m [12, p.333]. A 20 trawler fleet similar to that in Vilanova was present in Calafell in 1955. After 1936 trawlers were only allowed to fish 12 hours per day along most of the coast [12, p.334].

Tarragona was the first fishing port to rig motor trawlers in 1929. In previous years there were 30 pairs of 16-17 ton sail pair trawlers with 6 man crews. In 1955 the fleet included 62 trawlers from 4-42 tons, with an average of 25 tons, and diesel engines of 50-100

HP [12, p.330]. Tarragona had a port since 1790 and the port in Cambrils was constructed in 1930. Before that fishing vessels were hauled onto the beach. The trawl fleet dominated the fishery in this area. At the beginning of the 1900s, 24 couples of sail pair trawlers operated but these were displaced by motor trawlers with diesel engines by 1930. In 1955 there were 45 trawlers that ranged between 10 to 29 tons, and 20 to 80 HP. The average trawler was 15-20 tons, 45 HP and carried 5-8 fishermen. A 12 hour fishing rule was implemented in this port as well [12, p.342]. Cambrils was a very favorable area for groundfish due to the extensive continental shelf in the area. According to Doumenge [8], between 1944 and 1956 30 trawlers of between 24 and 40 HP operated here. In 1954, ten larger trawlers of 50-60 HP entered the fleet. The estimated average HP from 1944 to 1953 was 975 HP in Cambrils. In 1954 Ametilla del Mar had 33 motor trawlers of 2-28 tons and 10-80 HP in 1955, with the average trawler between 20-23 tons and 50 HP. Additionally, in 1928 there were 24 couples of sail pair trawlers [12, p.347].

3.3.4 Trawl fleets in France

Few currently available sources describe the trawl fleet in France during the shift from sail to motorized trawling. According to the French Statistical Bulletin for maritime fisheries, there were in 1908 [87, p.72] 25 *boeufs* (pair sail trawlers) of a cumulative 122 tons in Saint Lorent de la Selenque. In Serignan, there were 22 *gangui* and *boeufs* sail trawlers for a total of 62 tons. Thirty-five *gangui* of a cumulative 190 tons operated out of Agde and 195 *gangui* of 1,315 overall tons fished from Sète. There seventy-four sail pair trawlers were present in 1908 (*pêche aux boeufs*) [4, p.13]. In Le Ciotat 42 *gangui* made up a total of 102 tons. In other ports, fishing gears of different types were reported but its impossible to uniquely distinguish trawl gear. A similar bulletin providing fleet data for 1912 carried mixed gear information and cannot be used [182].

When the trawl sail fleet was being dismantled in Banyuls and Collioure due to the economic crisis in the 1930s, the mechanized trawl fleet was developing in Port Vendres [8, p.68] as the result of large capital investments. In 1932, four steam trawlers fished from Port Vendres (3 of 35 tons and 1 of 55 tons) and additional trawlers from Sete, Martigues

and Marseille fished in the Roussillon region. Yields were very good but damage to the nets was frequent due to little knowledge of the fishing grounds. After WWII, the fishery restarted slowly. In the Gulf of Lion the main focus was the Rhone delta. In the Languedoc region, fishing occurred on the continental platform where post war yields were extraordinary [8, p.69]. However, a rapid decline followed and approximately 10 trawlers transferred permanently to Port Vendres in 1951 in search of new fishing grounds [8, p.68]. At this time one trawler of 18 m and 120 HP fished on grounds of 150-180 m; 5 trawlers of 13-15 m and 70-90 HP fished on grounds from 30 to 100 m and 2 small trawlers of 9-10 m and 36-40 HP. In addition, other vessels occasionally fished on the grounds near Roussillon [8, p.69]. Specifically, motorized trawlers appeared with 30-70 HP in Sète in 1929 and by 1939, the number grew to 30 motor trawlers and a few pair sail trawlers [3, p.10]. In 1933, the sail trawlers were equipped with 25-30 HP motors and operated as pair trawlers. Fishing occurred 6 days per week and only one tow of 6 hours was allowed [3, p.29]. The catch was allocated one day to one boat and one to the other, generating disputes when there was a significant difference in size. In the 1930s, trawlers with 70 HP engines equipped with two winches otter boards emerged [3, p.29].

3.4 The growth in fishing power 1950-present

For the evolution of trawl fleet over the past 60 years we give a detailed description for France only, since several sources were available for that country. For Italy and Spain fleet trends and available data are analyzed in detail in the next sections.

3.4.1 The Trawl fleet in France

Available data sources were used to reconstruct the evolution of the French motorized trawl fleet in the Mediterranean Sea. Due to the historical presence of the former ISTPM lab (today IFREMER) in Sète, the most detailed historical records in terms of fleet and gear evolution are for this port. Due to its trawl fleet Sète has also been the most important port in the Gulf of Lion, as will be shown in the next paragraphs.

According to Giffard, in 1967 the French Mediterranean trawl fleet sailed mainly out of the ports of Agde, Sète, and Grau du Roi; Valras and Palavas had very small contingents [183, p.150]. In 1966, the motor trawl fleet in Grau du Roi was composed of 11 trawlers measuring 1,940 HP and 215 tons in total. Average trawler size prior to 1966 was 120 HP, 19 Tons and 16 meter in length, while larger trawlers of 400 HP, 35 tons and 20 m length entered the fleet in 1966. In Agde there were 15 trawlers longer than 14 m, totaling 275 tons and 1,940 HP. On average trawlers longer than 14 m in 1966 were 130 HP, 18 tons and 15.5 m long. In addition there were 4 trawlers less than 14 m length and more than 10 tons. Since 1960 new trawler construction has sharply increased as half the Agde fleet was built after 1960 [183, p.152]. The port of Agde had a small pelagic fishing tradition and trawlers in summer months converted to the *lamparo* fishery, which targets sardines.

During WWII most of the Sète trawl fleet was lost with the exception of few vessels, and a wave of new construction began after the war ended [3, p.10]. In 1961 a second wave of trawler constructions began, and in 1962 trawlers that left Algeria after the revolution were repatriated [183, p.154]. Ninety large trawlers, with tonnage between 20 and 90 tons and 150 to 300 HP, moved to the ports of southern France [184, p.367]. These were larger than the average trawlers in the Gulf of Lion, but the new vessels had to adapt to local fishing grounds. By the end of 1962, 40 trawlers were re-rigged and distributed between Port-Venderes, Port-la-Nouvelle, Sète, Port-St-Louis, Martigues, Marseilles, Toulon, St-Tropez and Bastia [184, p.367].

Between 1946-47 20 trawlers were built, and an additional 21 more trawlers were added to the fleet between 1961 and 1966. Using fleet data from Giffard [183], we can calculate that in 1966 the Sète fleet included 60 motor trawlers for a cumulative 1,180 tons and 11,950 HP. The average trawler in 1966 was 20 m long, 19.6 tons, and 199 HP. Trawlers in Sète were allowed to leave port at 1 am and required to return by sunset. Combining the work of Giffard in 1966 and Aparici-Fraticola in 1975, we find that 20 new trawlers were built in Sète and over this 10 year period, showing a continuous increase in vessel size, tonnage, and horse power [3, p.13]. In 1974, the number of trawlers in Sète decreased to 41, but cu-

mulative tonnage and HP increased to 1,462 tons and 13,245 HP, respectively. The average trawler in Sète in 1974 was 18.6 m long, 34.8 tons and 315 HP.

The expansion of fishing power in Sète trawlers continued and, by 1978, the 65 trawlers totaled 22,505 HP [4, p.19]. In the mid 1970s the first trawler with hulls made of composite materials instead of wood entered the fleet [4, p.30].

Between 1972 and 1985, the cumulative HP of the trawl fleet in the Gulf of Lion doubled from 30,000 to 60,000 HP, while the overall number of vessels fluctuated around 180 [93, p.78]. This increase in HP was largely due to modernization that replaced small and medium trawlers (less than 19m long and 250 HP) with larger 25 m vessels with more powerful engines [93, p.78]. The largest fleet variation was in the maritime Compartment of Sète where trawlers increased from 82 in 1975 to 125 in 1983 [93, p.78].

According to Berthou [185, p.7] in 2001 the trawl fleet in the Languedoc-Roussillon region included 72 vessels for 4,202 cumulative tons and 30,151 cumulative HP based in Sète, and 22 more in Port Vendres for 1,353 tons and 9,067 HP. Of these trawlers, 77 had a mixed license for bottom and pelagic trawling, 18 for bottom trawling, and 8 for pelagic trawling only. Trawlers averaged 22 m in length, 416 HP and 59 tons and usually carried a 5 man crew. In the Provence Alpes Côte d'Azur region, [185, p.13]34 trawlers operated from the ports of Marseille and Martigues in 2001. In these ports were, respectively, 11 trawlers (nominal 3756 HP and 462 tons) and 23 trawlers (nominal 9261 HP and 1416 tons). The fleets in this region had 2 vessels with pelagic licenses, 8 with demersal pelagic licenses and 24 with only demersal licenses. An average trawler was 21.3 m long, 382 HP, 55.2 tons and carried approximately 4 fishermen.

According to IFREMER SIH (Système d'Informations Halieutiques), in 2007 the 83 trawlers in the Languedoc Roussillon region had 83 a nominal 34,817 HP and a tonnage of 7,927 (UMS) (https://www.ifremer.fr/isih/affichagePageStatique.do?page=/produits/rapports_syntheses/activite/2007/FICHE_LIEU_2007_ZME_52_LR.pdf). In the same year in the Provence - Alpes - Côte d'Azur region, (https://www.ifremer.fr/isih/affichagePageStatique.do?page=/produits/rapports_syntheses/

\\activite/2007/FICHE_LIEU_2007_ZME_52_PA.pdf) 30 trawlers operated with cumulative nominal 11,263 HP and 2281 (UMS).

In the Province of Girona (Spain) the number of trawlers increased from 89 in 1970 to 122 in 1982 and installed horse power during the same period increased from 17,800 to 53,000 HP [94]. The Catalan fleet largely operated in the Gulf of Lion and competed with French vessels [94].

3.4.1.1 Effort Control policies of 1970s in France

In 1971 and 1972 it was determined that some stocks were over-fished and policies to control effort were implemented. The first, in 1972, introduced a limitation on fishing power by setting a maximum value of 430 HP for the new vessels entering the fishery. A second regulation the same year limited the number of licenses to the number of trawlers in 1972 [4, p.102]. Sète was allocated 70 trawling licenses, the entire Sète maritime district 108, and the entire South of France 300 [4, p.102]. In addition, trip duration was reduced by moving departure time up from 1 am to 3 am. This decreased fishing time to 12-13 hours [4, p.103]. Also in 1972, no-trawl zones out to 3 nm from the coastline were set in place to protect juveniles [4, p.104]. However, there was no specification on net mesh size as long as the smallest meshes in the net were larger than 20 mm or 40 mm stretch mesh [4, p.104]. An additional limitation was placed on vessel size increase (length and tonnage). When a vessel exceeded 25m or 50 tons it passed to a different administrative category with higher costs for the owner.

While the intention of the above 1970s regulations was to freeze fishing effort, harvesters quickly found ways to circumvent them. Licenses could be purchased in different maritime districts and used to rig new and larger boats. Nominal HP was increased by applying variable pitch propellers, turbo chargers, propeller Kort nozzles, or by installing larger engines with removable blocks [93, p.78]. Therefore, it is apparent from the reported violations of the rules at the onset of BHP regulation that actual BHP is much higher than officially recorded figures. This is similar to what happened in Spain in the 1990s.

The number of fishing days in the port of Sète started declining in 1971 when fishing was prohibited on Sundays [4, p.48]. The progression of average number of fishing days per vessel over the period 1968-1977 is summarized in Table 3.7.

Year	N. fishing days	N.trawlers
1968	257	66
1969	259	63
1970	239	60
1971	242	58
1972	237	46
1973	238	51
1974	238	43
1977	167	49

Table 3.7. Number of motor trawler fishing days, port of Sète (France), from Aparici-Fraticola [3] and Maupoint [4]

3.5 Temporal and spatial trends in fishing effort development

The previous sections outlined details of historical fleet composition in different Mediterranean countries over approximately 300 years. The historical data (pre-1950) is characterized by spotty records and a multitude of missing data, while more recent data (post-1950) is census based and aims at covering entire national fisheries. Given the goal of reconstructing historical trends in trawl fishing effort, it is necessary to reconcile the two types of data to make them comparable. One objective is to quantify the yearly number of vessels by fishing gear type in each State or Region. Since the number of vessels is not a good descriptor of effort alone, particularly when there has been a significant change in fishing techniques and vessel power, we need to find a common metric for quantitative analysis. One of the most common effort indicator is the HP/Kw and number of fishing days [186, 187, 188, 132]. While such an indicator is robust, despite the limitations discussed in Chapter 1 and in Eigard et al. [132], it is difficult to quantify the HP of sail trawlers. Concerning the number of fishing days, some references are found in the literature and other indications in fishermen interviews performed under the EU EVOMED project [14].

As presented in the introduction, fishing effort is a proxy of fishing mortality and both intensity and duration are needed to understand the trajectory of decline and potential recovery of fish stocks. The goals of this section are the following:

1. Assessing the HP of a historical pair sail trawler using literature references and nautical engineering calculations.
2. Modeling the historical numbers of single and pair sail trawlers and motor trawlers before the advent of census statistics.
3. Predicting total HP across all trawling techniques.
4. Comparing historical and current estimates of numbers of trawlers and total HP.

3.5.1 HP of a Sail Trawler

Chapter 1 already showcased attempts at estimating the HP of a pair sail trawler, and provided historical references giving clues of potential sail trawler HPs that have already been reported. A different approach is used in this section to attempt to build convincing and conclusive evidence of actual sail trawling power. The following work has been done in collaboration with Ing. Emilio Notti of CNR Ancona (Italy). We want to estimate the propulsive power that a sailboat of a given size needs to generate in order to tow a trawl net at a certain speed. Since not all the necessary information is available for a direct assessment of the required power, different hypotheses are presented for deriving a valid estimate. Figures 3-1 and 3-2 show Adriatic *bragozzo* type pair sail trawlers, the kind that are simulated in this section.

3.5.1.1 Relation between speed and power need

A vessel in need of reaching a certain speed determines a power requirement that relates to its hull advancement resistance. Its propulsive system must be sized to allow the vessel to reach maximum speed. Maximum reachable speed depends upon the length of the vessels hull flotation line under full load. The sailboats under investigation (such as the Adriatic *bragozzo* pair sail trawler described in Chapter 1) have a displacement hull.

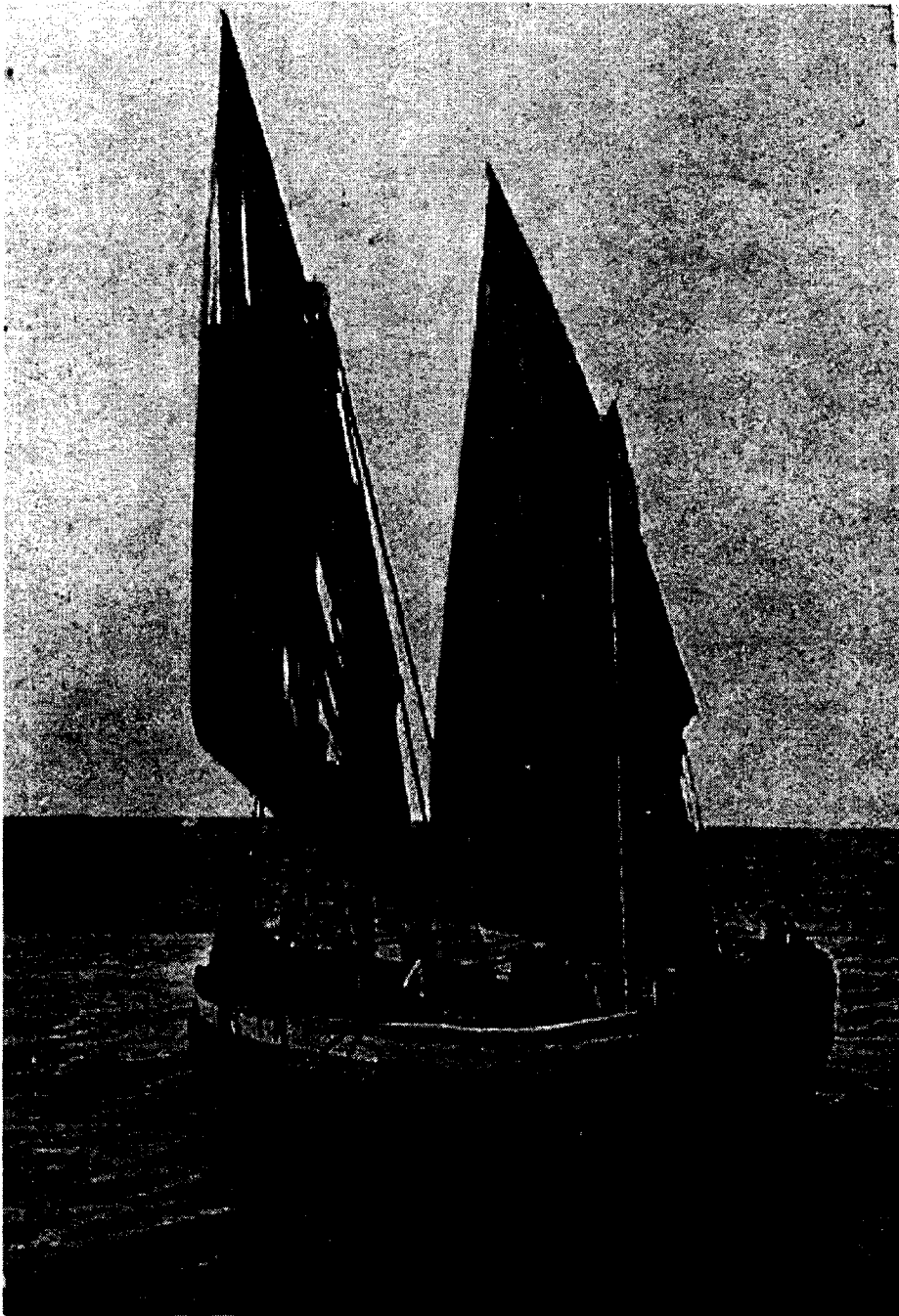

Figure 3-1. Adriatic bragozzo pair sail trawler circa 1900 from Ferretti (1911) [16]

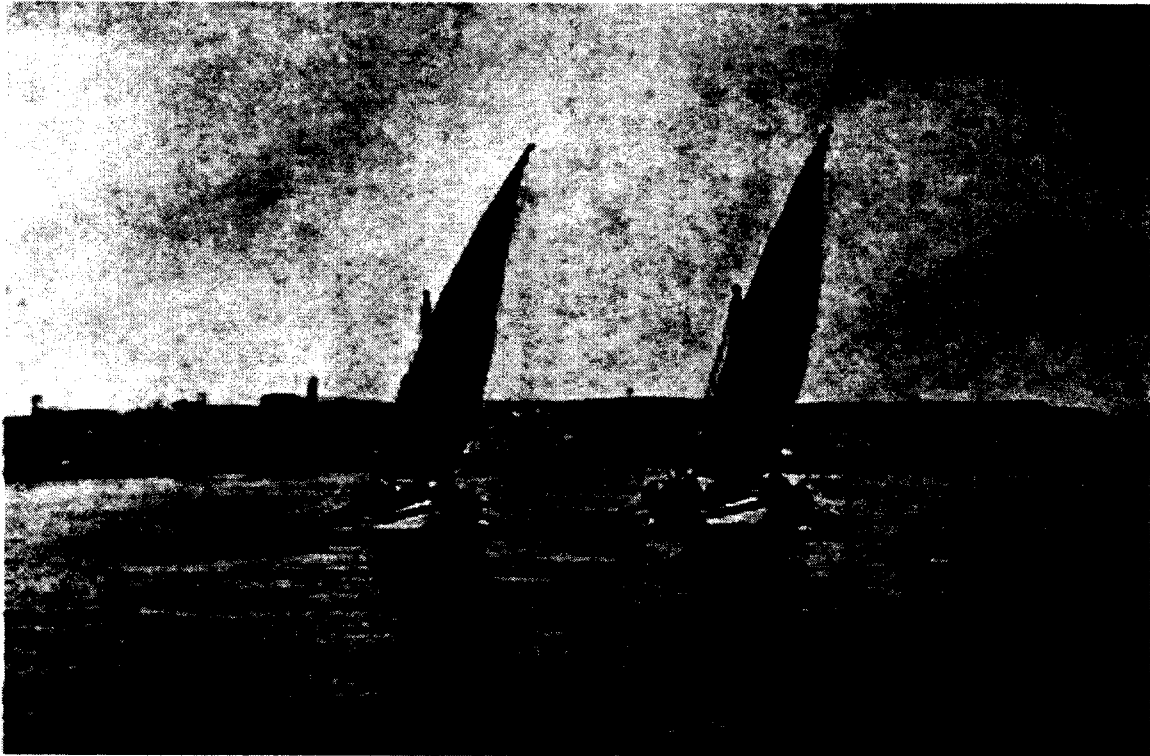

Figure 3-2. Pair sail trawlers fishing off Fano circa 1900

Maximum achievable speed (V) relates to a vessels float line according to the following equation:

$$V = 2,43 \times \sqrt{L_{Wl}} \quad (3.1)$$

where V is speed in Knots and L_{Wl} is flotation line in meters.

3.5.1.2 Vessel ratios

When it is not possible to directly determine the power demand of a boat due to lack of construction specifics, one alternative approach involves estimating power through a comparison with the power of known vessels. Based on the principle of similitude, and since hull geometry is known, we attempt to estimate the power by comparison with similar vessels. As a function of speed, the effective power (EHP) and break horse power (BHP) for a boat with displacing hull of 10 m are reported in Table 3.8. EHP is the power required by the hull to reach a certain speed; BHP is the amount of power that needs to be installed on the vessel in order to provide the power requested. These two types of powers differ in

their propulsion efficiency; propulsion efficiency characterizes a propulsive system with a propeller as this largely contributes to the dissipation of break power. In a sail propulsion system, no analogy is possible since the wind conditions are unknown for the vessels under study. For this reason, we assume that EHP will be equal to the power generated by vessel sails.

Based on this assumption, a displacement hull of 10 m will have a maximum sailing speed of 7.68 kn. Therefore, based on Table 3.8, the power needed according to prior definitions will be approximately 25 HP.

V(kn)	E.H.P.
6.50	8.0
6.94	12.2
7.21	16.2
7.48	24.3

Table 3.8. Effective Horse Power (E.H.P.) requirements as a function of velocity for a 10 m displacement vessel.

Suppose that there is sufficient wind for the sailing vessel under investigation to move at a maximum speed of 7.68 kn. If under these conditions, the use of a trawl net is assumed at a speed of 3 kn, the propulsive power available to towing the net will be 25 EHP minus the power absorbed by the hull cruising at 3 kn, which will be negligible at this velocity. Thus, the towing force (T) that the vessel can generate relates to the power (EHP) and speed (V) according to:

$$T = \frac{EHP \times 75}{V \times 0.514} = \frac{25 \times 75}{3 \times 0.514} = 1313kg \quad (3.2)$$

The approximation method employed here is commonly used in naval engineering, however the principle is one of the tools available for an accurate estimation, which is carried out with additional methods. Validation is often performed experimentally in naval flow tanks and with complex mathematical modeling.

3.5.1.3 Conclusions

The BHP generated by a 10 m sail trawler is thus equivalent to 25 HP and with sufficient wind force, it can tow a net with a drag of up to 1313 kg. In the case of pair sail trawlers, the power available for trawling is the sum of the respective HPs. Therefore, a pair could generate enough force to trawl a net with a drag force of 2600 kg if there is sufficient wind. Wind force is the main driver of uncertainty in this case. For example, with winds under 5 kn it would be very unlikely that the sails could generate 25 HP. By contrast, 35 kn winds would certainly generate 25 HP, however sea conditions would become prohibitive for navigation. Mancini reported that, in the Tuscan Archipelago in 1919-1920, pair sail trawlers could operate in winds in the range of 1-5 Beaufort (from 1-2 kn to 16-20 kn) and sea force of 0-4 [112]. In the trawling experiments from 1921, a 40 HP trawler could not tow an ordinary *paranza* (pair sail trawler) net with 600 meshes [112]. It was suggested that towing a 600-700 mesh net required 70 HP. Interestingly, ApariciFraticola stated that the pair sail trawlers of Sete (France) had been refitted with motors had on average 27 HP each [3, p.10].

We can infer that the actual HP of sail trawlers is variable. Depending on conditions, fishermen adopted different strategies, like using beam trawls in very light wind conditions, pairing two vessels with variable size nets depending on the wind, or pairing more than two vessels. Since 25 HP seems the minimum required towing force for an ordinary pair sail trawl and a sail trawler could have a towing force up to 70 HP based on Mancini's suggestion, we will assume that a pair sail trawler will generate 40 HP on average. For single sail trawlers, it was not possible to derive direct estimates of sailing power, but there are some useful indications. Single sail trawlers were less efficient due to their sideways drift. Not having a heavy daggerboard or keel meant that their sails could not equal the surface area of pair trawler sails. Several references confirm the superior towing capacity of pair sail trawlers [175, 110]. Based on these considerations, the average power of a single sail trawler is assumed to be 30 HP. To derive a mean value of pair sail trawler HP three approaches were used: literature review, simulation of net drag and theoretical calculations from naval engineering. These approaches yielded a range of comparable results

thus our assumptions are not uninformed. Of course pair sail trawlers were of different sizes; thus 40 HP might be more or less than the true HP of each individual vessel. However, when this is compared to wind variability it might not be that relevant. When the derived HP of sail trawlers is used for modeling fishing effort, or as a covariate in LPUE standardization (Chapter 3), we use a mean value that will be approximately correct. This is not too dissimilar from when motor trawler HP is unreported and a mean value derived from similar trawlers of the same period. Additionally, in the last two decades there is significant under-declaration of trawler HP (see Chapter 1 and 3). Thus, there is an overall uncertainty about all trawler HP irrespectively of whether they are historical or contemporary. The most important aspect that we want to capture is order of magnitude differences in HP. Sail trawlers may have been in a range of 20-70 HP, with modern trawlers in the range of 400-1000, but the order of magnitude difference are approximately 2-3 and this is the most significant result.

3.5.2 Reconstruction of trawling effort

All the records of fishing trawlers in this Chapter, whether single or pair trawler, steam trawler, sail with motor trawler and motor trawler, have been gathered in a unique database. The Mediterranean Trawl Fleets database was organized by gear, year, country, region, Maritime District, and city, depending on the spatio-temporal resolution. The sources are reported and each entry is classified as to whether it came from a spot record or from a systematic census statistics. Figure 3-3 shows the yearly sum of the number of trawlers by gear type based on the available datapoints collected from historical research. Countries not under direct investigation, such as Tunisia and the former Yugoslavia, are included as data was collected for these areas. It is difficult to understand trends since data are unbalanced between regions within individual countries and across periods.

In addition to the sources already described and cited, additional datasets available for the 20th century have been added to the Trawl Fleet database. These are:

1. Fleet data from HMAP project in Catalonia [95].

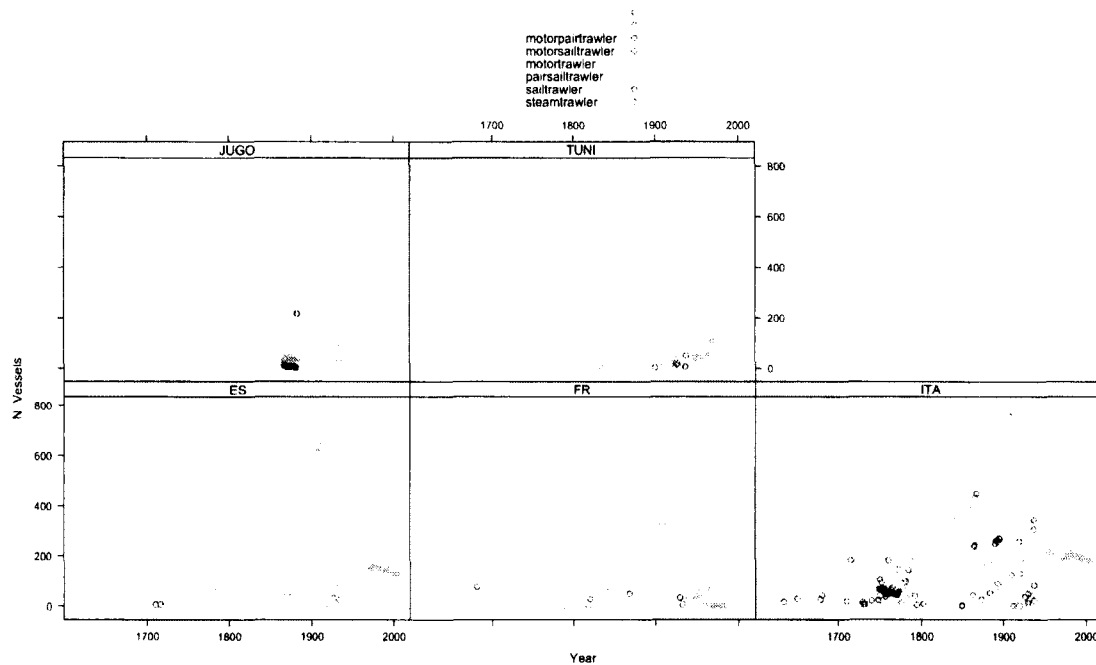

Figure 3-3. Number of trawlers by gear type per area over the period 1600-2000. Pre-1950s data derive from spotted surveys while post-1950 data are generally census statistics.

2. Fleet data from Catalonia 1971-2010.
3. Italian fleet statistics collected by ISTAT 1953-2000.
4. Italian fleet statistics collected by IREP 2000-2008.
5. EU Fleet register data.

Since each database has its own structure and different spatial resolution, it was necessary to standardize all of them to a National standard. The first step was to build a geo-referenced database for Italy, France and Spain containing the different geographical aggregation levels. The structure is the following: State, GSA, Region, Maritime District, Port, Port Code, and Port Latitude and Longitude. The geo-referenced database was merged with all datasets so that the different levels of spatial aggregation would be correctly represented. Data sources are summarized by Author, year of publication and number of years of data for each source in Table 3.5.2. The following sections describe in detail each database and the steps for extraction and standardization of fleet data.

Author	Year	Reference	N. Years of Data
D'Ancona & Razzauti	1937	[118]	2
Bas	1955	[12]	2
Berthelot	1868	[110]	14
Bohualhal	1972	[21]	26
Caddy & Oliver	1996	[189]	2
Ciotti	2006	[7]	7
Coccoluto Ferrigni	1866	[9]	1
Crnkovic	1970		4
Darboux	1906	[100]	5
De Angelins	1939	[180]	3
De Niccoló	2004	[106]	26
Doumenge	1966	[8]	2
Ermirio	1932	[6]	3
Errera	1873	[173]	2
Anon	1893	[96]	1
Ferretti	1911	[16]	1
GFCM	2009		12
Garrido	2008	[95]	11
IREPA	2008	*	7
ISTAT	2002	**	34
ISTAT	1937	[2]	3
ISTAT	1965	**	4
Kastriot	2003	[190]	33
Lleonart	1987	[191]	2
Mancini	1920	[112]	1
Marzari	1983	[169]	5
Matta	1958	[56]	1
Maynou	2010	[14]	37
Meuriot	1986	[91]	26
Aparici-Fraticola	1975	[3]	3
Anon	1911	[87]	2
Paolucci	1913	[11]	1
Parona	1898	[?]	14
Pascal	1954	[192]	1
Pasquini	1926	[79]	4
Police	1930	[?]	4
Salvemini	1985	[178]	10
Anon	1934	[99]	3
Anon	1937	[193]	1
Tarigoni-Tozzetti	1874	[175]	2
Zuccagni-Orlandini	1850	[172]	3
Zupanovic	1953	[18]	11

Table 3.9. Data sources by Author and Year used for the reconstruction of trawl fishing effort in the western Mediterranean. * data provided by IREPA onlus and ** data provided by ISTAT.

3.5.2.1 HMAP Catalonia

Fleet data collected by the HMAP project in Catalonia [95] is published on the HMAP web site, HMAP Dataset 10 (<http://www.hull.ac.uk/hmap/Library/Library.htm>) and is publicly available. In order to extract only trawl fleet information we subset the database using the field *X1.EFFORT.NET.TYPE == Trawl* and then used the number of vessels under the field *X2.EFFORT.VESSEL.NO*. This returned numbers of trawlers for Catalonian ports only for 1868 and for the period 1908 to 1914. Other effort data could not be used as it was reporting the number of nets as an indicator of effort and this was deemed not reliable as vessels have multiple rigs. The subset of valid trawl data was then collated into the general fleet database.

3.5.2.2 ISTAT and IREPA Italian fleet

The main source of Italian fleet statistics after WWII is provided by the Italian National Institute of Statistics (ISTAT). Since 1953 ISTAT started reporting, on an annual basis, information on the Italian fishing fleet. The data has been published yearly in the *Statistica della Pesca e della Caccia* annualies. For the period 1953-1971, data were extracted from printed volumes at ISTAT, while the series from 1972-2000 was made available by IREPA onlus, which, since 2000, is in charge of data collection.

Fleet data for the period 1953-1970 are based on the division between *Motopescherecci* and *Motobarche*. The former are defined as fishing vessels with an engine used for navigation and also to power mechanical devices like winches; the latter defines vessels that use engines only to move. The number of vessels, horse power, tonnage, and length are reported by maritime districts for both *Motopescherecci* and *Motobarche*. Fishing gear/activity is reported separately for *Motopescherecci* and *Motobarche* and specifies the following categories: trawl (*strascico*), purse-seine (*circuizione*), longlines (*Posta/Palangresi*), other gear, and mixed gear. Unfortunately, important information like HP is given for the aggregated class *Motopescherecci* or *Motobarche* but it is impossible to know the exact number of HP of *Motopescherecci* that fish with trawl gear, while number and tonnage is available. Based on tonnage the majority of *Motopescherecci* are actual motor trawlers so it was assumed that

the total HP of *Motopescherecci* is the HP of all motor trawlers. The data were subsequently subset and only *Motopescherecci* information was extracted for the period 1953-70.

From 1971 to 2000 ISTAT statistics gained more resolution on gear types since the number of vessels, tonnage, and HP are reported on fishing licenses. The trawling licenses that were retained are the following: *motopesche strascico* (trawling), *strascico costiera* (coastal trawling), and *strascico e volante* (trawling and pair trawling).

In 2000, Italian fleet statistics collection moved to IREPA. The data provided by IREPA covers the period 2000-2006 and identifies only the category 'trawlers', for which are reported numbers, tonnage, and HP (in KW) by Maritime District. An additional category classified as polyvalent license exists in the IREPA classification. Often, but not consistently, trawlers are classified under this category, therefore IREPA estimates are to be taken with caution, since the number of trawlers classified as such underestimates the total number of trawlers.

3.5.2.3 EU Fleet register data

In order to gather detailed fleet information with vessel specifics we accessed EU fleet register information. In light of the need to collect detailed information on the Community fleet, particularly to help with the management of structural measures where financial support is provided to the fisheries sector, the Commission adopted Regulation (CE) No 163/89 of 24th January 1989 (published in the OJ of 25.01.89), forming the legal basis for the collection of information on all professional fishing vessels from 1 January 1989 onwards (<http://ec.europa.eu/fisheries/fleet/index.cfm>). In spite of data collection requests to EU Member States (MS), most data report vessel information starting in 1995. It has to be kept in mind that fleet data was provided by MS within the EU Common Fisheries Policy (CFP) reform with the purpose of assessing, maintaining levels of fishing effort and receiving subsidies to modernize the fleet. Each of these steps involves management and politics and, as such, misreporting is not uncommon.

Fleet data has been downloaded from the EU website (<http://ec.europa.eu/fisheries/fleet/index.cfm>) for Italy, France and Spain. As the focus of this work is on bottom

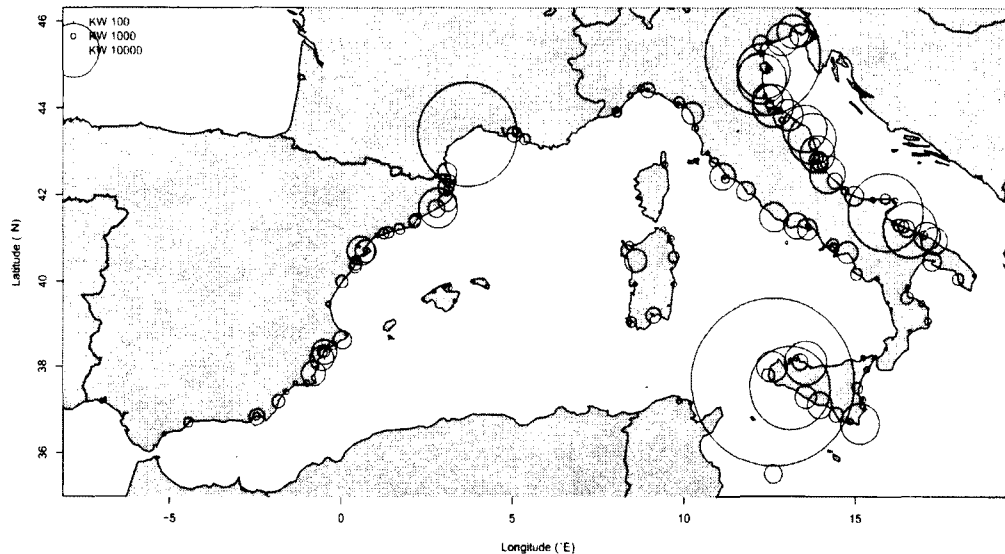

Figure 3-4. Cumulative KW for trawlers in ports of Spain, France and Italy in 2010, source EU Fleet Register. Trawlers belong to categories 'Bottom otter trawls" (OTB) "Otter twin trawls" (OTT) and "Beam trawls" (TBB)

trawling, datasets have been subset for the primary and secondary gear coded as Bottom otter trawls (OTB), Otter twin trawls (OTT), and Beam trawls (TBB). Only Mediterranean ports have been selected. Given different census starting dates in different countries and a complicated data structure to identify the active vessels on a yearly basis, this database was used only to reconstruct numbers of vessels and total HP by port for 2010. KW per port is plotted for Italy, France and Spain for 2010 in Figure 3-4.

3.5.3 Methods

To reconstruct the number of trawl vessels for the period prior to census statistics (pre-1950) a robust method for dealing with the missing data is necessary. Random mixed models effects are an appropriate tool for estimating yearly means.

The issue of expanding the number of trawler estimates from few ports, likely not sampled at random, is challenging. The yearly mean number of vessel (\hat{n}_{ij}) for the sampled ports is estimated with a mixed model where port is a random intercept. To extrapolate

\hat{n}_{ij} to the entire port population, a criterion for assessing the number of ports per year (p_{ij}) was established. The total number of vessels per year (N_{ij}) is:

$$N_{ij} = \hat{n}_{ij} \times p_{ij} \quad (3.3)$$

where i =year and j =gear.

Conceptually, as the fishery expands, not all ports will have trawlers in the beginning, so for a port to be included as an expansion factor it needs to recruit to the ports population. Therefore to each port is assigned a 0/1 step function where 0 corresponds to a port not yet recruited, 1 to a port when it recruits, and 0 again after a port already recruited. The number of port per year and gear, p_{ij} , is calculated by summing consecutively the 0/1/0. This implies that the number of ports can only increase. If the yearly mean estimate of trawlers declines this will lower the total number of vessels. The index of ports is calculated independently for each gear type.

Only effort for pair sail trawlers, sail trawlers and motor trawlers was modeled. For the other categories (steam trawler and sail trawler with auxiliary motors) not enough points are available. One pair of sail trawlers is counted as one fishing unit as it operates with only one net at a time, however it consists of two trawling vessels.

In R terms the starting model was:

```
lme(fixed=log(average_number)~year*gearSD, random =~1|city, family=gaussian)
```

Model selection was performed by first using Akaike Information Criterion (AIC) [158] with Maximum Likelihood (ML) to chose the best random intercept and the best variance structure. The best fit was refitted with REML and then the model was used to predict the number of vessels per year by gear for the period 1630-1950. The mean yearly prediction was then multiplied by the sum of the number of ports recruited in that given year. This returns the predicted total number of vessels in a given region.

To estimate the yearly total HP by region, the estimated total number of vessels was multiplied by the yearly average HP. As previously explained, this was 40 HP for pair sail trawlers, and 30 HP for single sail trawler. When not available, the mean yearly HP of

motor trawlers was assigned using average literature estimates from the corresponding regions and time periods.

Since the R *nlme* [194] package does not output at 95% confidence intervals (CI), results were manually calculated using the diagonal of the variance covariance matrix. CIs on the total yearly trawler estimates were used to derive CIs for the total yearly HP estimates. The census data is then plotted and compared to the historical reconstruction using the same spatial scale. Since census data should represent the entire fleet population, no CIs are provided.

3.5.4 Results and Discussion

The results of effort reconstruction are presented on a Regional basis.

3.5.4.1 Spain, Catalonia

Since the Catalonia region carries the most historical information on trawler fleets, in Spain we focus only on this region. The best model resulted as:

```
lme(fixed=log(average.number)~year*gearSD, random=~1|city
```

Model estimates and standard errors (SE) are reported in Table 3.10. Standardized residuals Figure 3-11 and Q-Q plots for normalized residuals, Figure 3-13, do present some problems. There seems to be some violation of the normality assumption of the random effects, Figure 3-13. Therefore, the results from this model should be taken with caution and further steps to improve the model should be taken. Nevertheless, given the uncertainty in the number of ports and the significantly large difference with modern effort, the goodness of the residuals might not be of greatest concern.

Figure 3-5 displays the predicted numbers of the different type of trawlers before 1950 with relative CIs and for the period after 1950. In the case of Catalonia, only one point is available for 1955 from Bas et al. [12] and official statistics started only in 1971. Single sail trawlers appear to be almost absent in Catalan waters in 1750, while the pair sail trawlers steeply increased after 1850. This result is consistent with historical descriptions in the beginning sections of the Chapter. In the 1920s, motor trawlers start increasing steeply and

	Value	Std.Error	DF	t-value	p-value
(Intercept)	-82.74	36.07	280.00	-2.29	0.02
year	0.04	0.02	280.00	2.36	0.02
gearSDpairsailtrawler	72.13	36.82	280.00	1.96	0.05
gearSDsailtrawler	32.41	298.80	280.00	0.11	0.91
year:gearSDpairsailtrawler	-0.04	0.02	280.00	-1.92	0.06
year:gearSDsailtrawler	-0.01	0.17	280.00	-0.08	0.94

Table 3.10. Summary table of fixed components estimates of best model fitted in Spain. The trawler type set as reference is motorized, and estimates of pair sail and single sail trawlers are compared to motorized trawlers. The estimates are on *Log* scale.

the prediction matches the point estimates of Bas in 1955. This approach of counting the population of ports does not allow estimates of pair sail trawlers, for example, to decline, as zeros are not reported in the available records. In fact, declining numbers of pair sail trawlers are not reported. What is likely to have happened, and the literature confirms this, is that many sail trawlers had been refitted with motors and thus had progressively been classified as motor trawlers. This would also justify the steep increase in motor trawlers. Additionally, since the model is linear it would not allow the mean numbers of vessels to decline. Adding polynomial terms on year could improve this aspect of the analysis.

The number of trawlers in the past 50 years peaked in the 1980s and afterward declined to less than 400 trawlers. In terms of numbers of trawlers, the difference between before and after WWII is not appreciable, however the real picture of effort is given by the reconstruction of total HP.

The estimated and census total HP (Figure 3-6) show an extremely large increase in HP since the advent of motorized trawling. The peak in HP is in the mid 1980s, when legislation to limit engine horse power was introduced. The subsequent decline is in part due to the decreasing number of vessels, but it is believed that the actual HP did not decline as rapidly, given that engine HP is commonly underdeclared. This reality clearly emerged from the fishermen's interviews in Catalonia [14]. Nevertheless from 1850 to 1980, HP increased to more than 120,000 HP, with fastest growth after 1970.

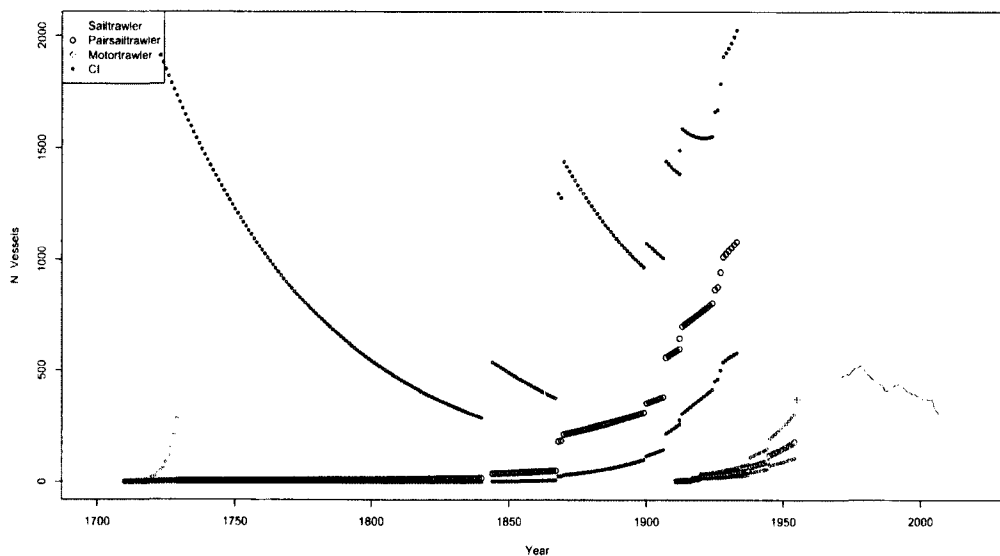

Figure 3-5. Predicted historical number of trawlers and census statistics of the fleet for Catalonia (Spain).

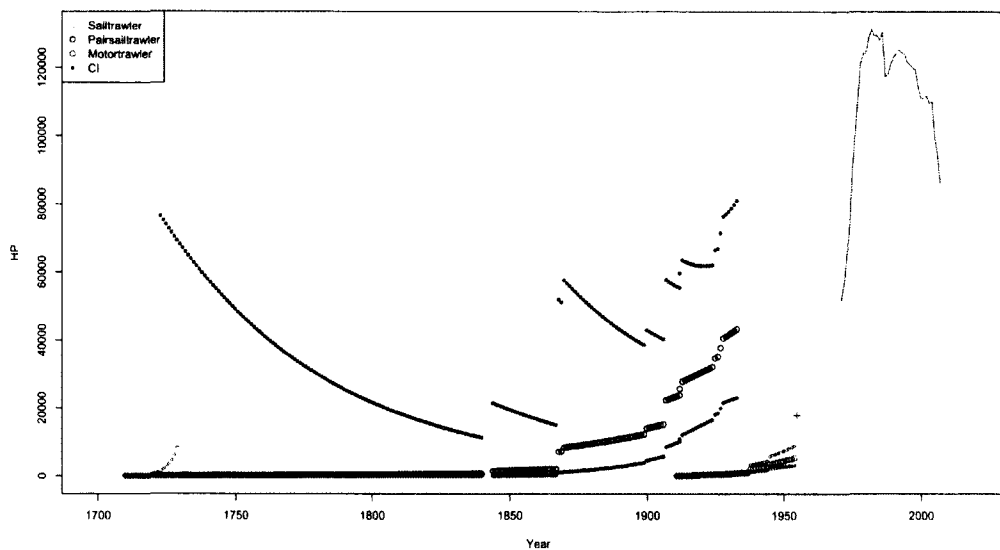

Figure 3-6. Predicted historical HP of sail and motor trawler compared to contemporary census statistics from Catalonia (Spain).

The uncertainty about historical sail trawler HP, while still important, seems negligible in the face of such large increase in HP.

3.5.4.2 France, Gulf of Lions

In Mediterranean France, the most important fishing area has historically been the Gulf of Lions and this is where most fleet records come from. Trawling effort for this area has been reconstructed. The best model is described in R code as follows:

```
lme(fixed=log(average_number)~year*gearSD, random=~1|city
```

Model estimates and SE are reported in Table 3.11. Standardized residuals Figure 3-17 and Q-Q plots for normalized residuals, Figure 3-18, are acceptable. However there seems to be some violation of the normality assumption of the random effects, Figure 3-19.

	Value	Std.Error	DF	t-value	p-value
(Intercept)	-65.19	9.80	37.00	-6.65	0.00
year	0.03	0.01	37.00	6.87	0.00
gearSDpairsailtrawler	72.69	13.58	37.00	5.35	0.00
gearSDsailtrawler	81.57	12.11	37.00	6.73	0.00
year:gearSDpairsailtrawler	-0.04	0.01	37.00	-5.19	0.00
year:gearSDsailtrawler	-0.04	0.01	37.00	-6.43	0.00

Table 3.11. Summary table of fixed components estimates of best model fitted in France. The trawler type set as reference is motorized and the estimates of pair sail and single sail trawlers are compared to motorized trawlers. The estimates are on *log* scale.

Figure 3-7 shows the estimated total number of trawlers by year and gear with relative 95% CIs for the historical data plus census data after 1950. Pair sail trawlers were present into the early 1900s, with faster growth starting around 1850 and peaking at around 200 pairs before 1930. The expansion of motor trawlers occurred earlier in Catalonia than in the Adriatic. The census data numbers of motor trawlers are incomplete and only few data points are reliable. These show a peak in the number of motor trawlers in 1983 and a subsequent reduction.

Reconstructing total HP gives a different picture than looking at only the numbers of vessels. Figure 3-8 shows the pattern of yearly HP by trawler type. As in Catalonia and Italy, pair sail trawlers rapidly increased after 1850, while single sail trawlers remained in the fishery until the beginning of the 20th century. Motorized trawling HP developed less rapidly before 1950 while after 1960, HP steeply increased and peaked at 64,000 HP in 1984.

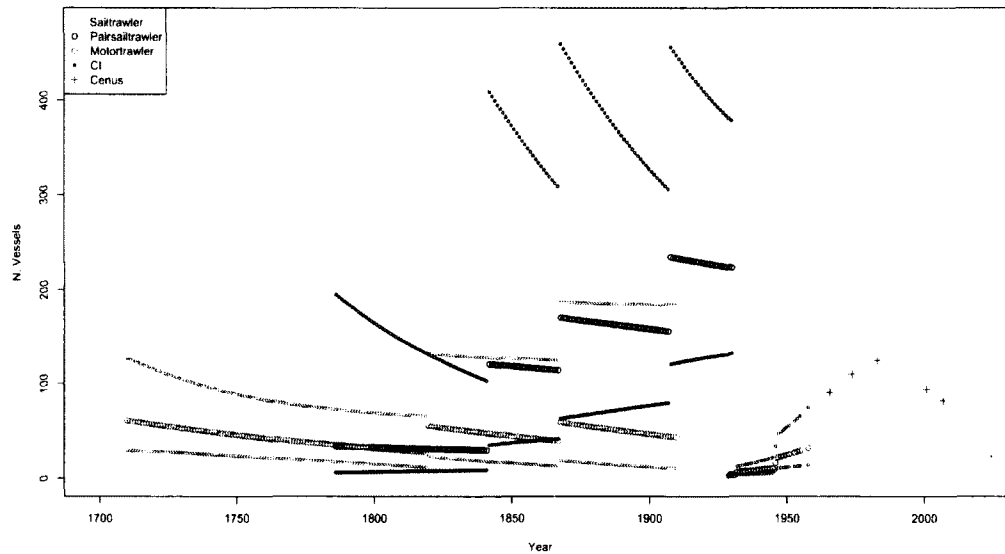

Figure 3-7. Estimated and census numbers of trawl vessels by gear in the Gulf of Lions (France).

The model prediction for motor trawlers seems to be in line with the census estimated. Information on HP for the last 20 years is more scattered but shows a significant drop. As in the other cases, part of the drop is likely due to a decrease in the number of vessels, however given the legal limit of vessel HP, we believe the drops are in part due to under-declarations as explained in prior sections.

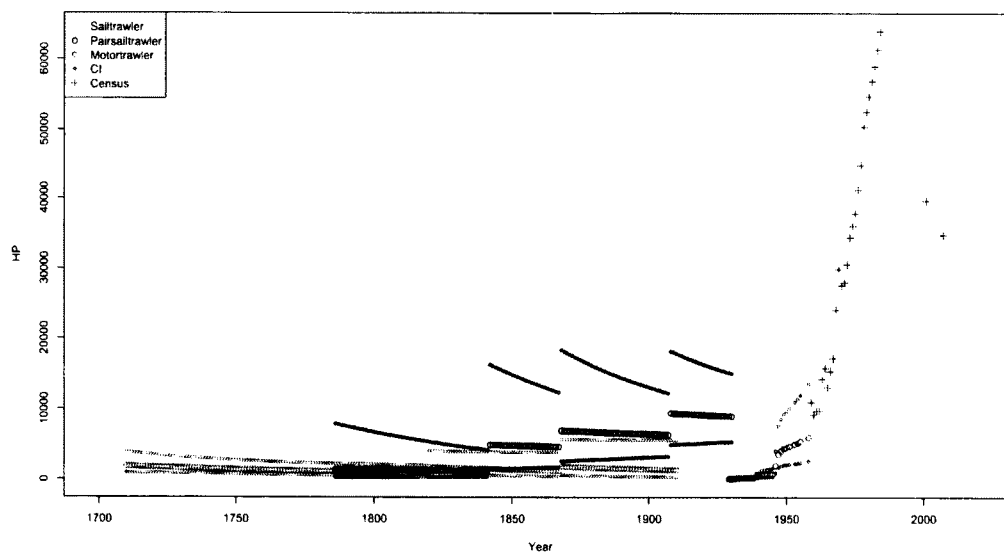

Figure 3-8. Estimated HP of trawl fleets by gear in the Gulf of Lions (France). Pre-1950 data are estimates and post-1950 data are from census statistics.

3.5.4.3 Italy, Adriatic

Since the most consistent data points in Italy are from the Adriatic Sea, a model was fitted for this area only. The Adriatic represents a particularly interesting area since fleet data go back to the 17th century and carry a good spatial representation of the entire basin on the Italian side.

The best model resulted in the following:

```
lme(fixed=log(average_number)~year*gearSD, random =~1|city
```

Model estimates, SE and p-values are reported in Table 3.5.4.3. The standardized residuals (Figure 3-14) and Q-Q plots for normalized residuals (Figure 3-15), look normal. Additionally, there seems to be no violation of the normality assumption of the random effects (Figure 3-16).

	Value	Std.Error	DF	t-value	p-value
(Intercept)	-409.79	85.98	163.00	-4.77	0.00
year	0.21	0.04	163.00	4.80	0.00
gearSDpairsailtrawler	393.59	85.85	163.00	4.58	0.00
gearSDsailtrawler	405.63	86.11	163.00	4.71	0.00
year:gearSDpairsailtrawler	-0.20	0.04	163.00	-4.56	0.00
year:gearSDsailtrawler	-0.21	0.04	163.00	-4.70	0.00

The predicted number of trawlers by gear and year are shown in Figure 3-9. The numbers of single sail trawlers is the longest on record and anticipates in time both Catalonia and France. This might be due to data availability only, however it could be also real and related to the ease of trawling on the shallow depths of the Adriatic Sea. The development of pair sail trawling started earlier than in the other analyzed areas but increased similarly after 1850. Motorized trawling rapidly expanded and by 1950 had reached the highest levels in terms of fleet size. Census data confirm the model predictions for the 1950s. The drop in motor trawlers between 1960 and 1970 is unclear, but no data are available for that period. The number of trawlers had a new relative increase in the 1980s and has been dropping since. In the last 10 years, there is high variability, which could be due to the IREPA census data where some trawlers have been allocated to the 'trawlers' or 'polivalent' fleet sections.

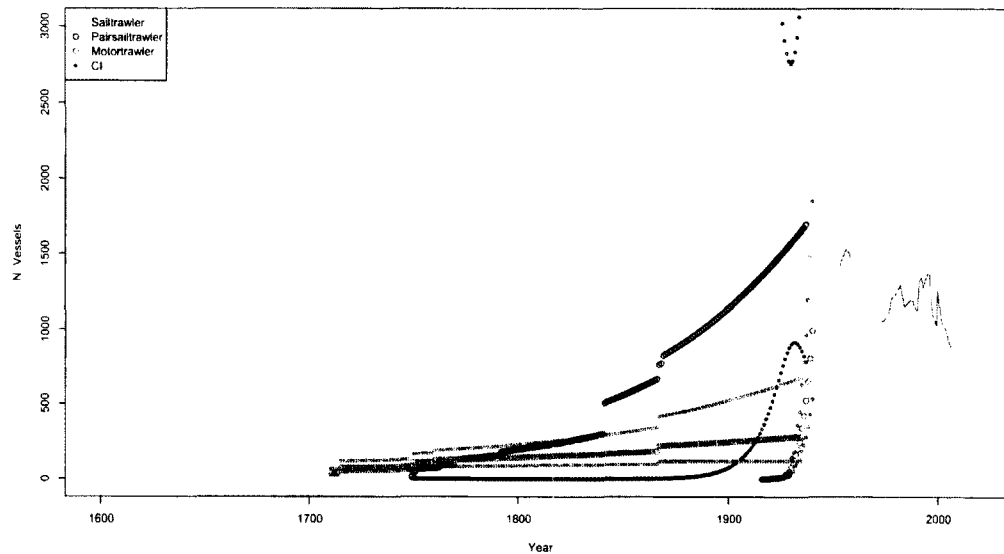

Figure 3-9. Estimated and census numbers of trawlers in the Adriatic Sea (Italy).

Figure 3-10 summarizes the predicted yearly HP by gear. As in previous analyses of Catalonia and France, the prediction of motor HP is in line with the census estimates. The growth in HP has been steep since the early years and peaked around 1990. After that follows a steep decline in part due to a reduction of fleet size and also due to reporting issues. In Italy, there is not a legal limit on individual trawler HP, like in Spain or France, but the EU Common Fisheries Policy (CFP) has mandated a freeze in fishing effort since the mid-1990s. Additionally, as argued before, we have low confidence in IREPA fleet estimates, therefore the recent drop in HP should be considered carefully.

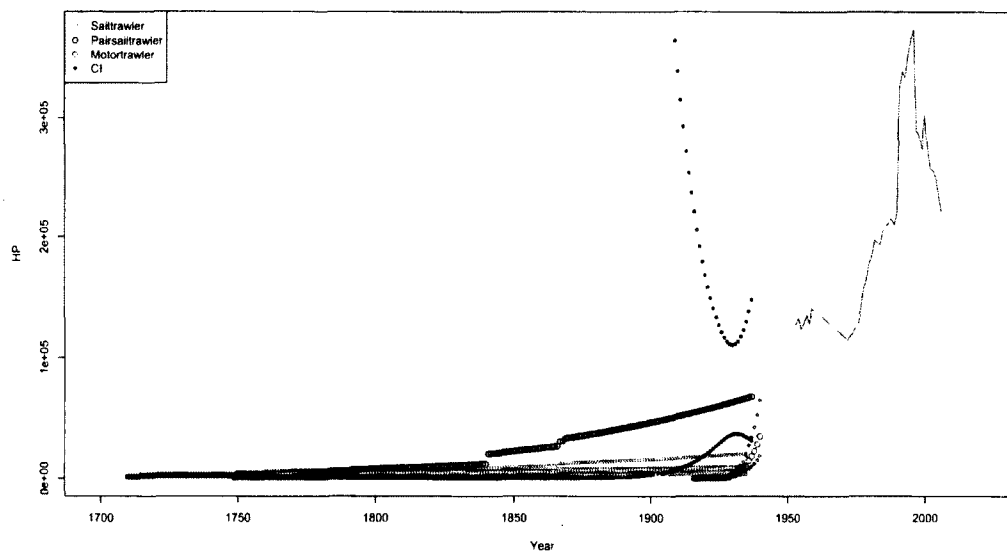

Figure 3-10. Estimated HP of trawl fleets by gear in the Adriatic Sea (Italy). Pre-1950 data are estimates and post1950 data are from census statistics.

3.5.5 Conclusions

In this analysis, HP was used as a proxy of fishing effort. This is an approximation since a more proper estimator of effort would be the total HP multiplied by the number of fishing days. Under the current analysis, it is assumed that fishing days were constant over time. While information on fishing days was collected for different types of gear and areas, these were deemed insufficiently detailed to incorporate in the analysis. In the past fishermen fished most days of the week, even weekends, whereas today fishermen do not fish on weekends and, in some areas like the Adriatic, fish only 4 days per week. Additionally in the past, sail trawl vessels also operated non-towed gear when wind was insufficient, thus using fishing days without knowing how many were trawling days can bias the analysis. For instance, for a proper comparison of fishing days on sail trawlers, wind force should be considered as well since the HP of a sail trawler depends on wind. This would be rather challenging and we believe it is acceptable to compare effort based solely on HP.

The reconstruction of historical fleets and fishing effort gives several interesting results. Effort from 1700 to 1900 was not negligible. In particular, since all trawling effort was exerted on fishing grounds shallower than 100 m, fishing mortality on coastal stocks was likely already significant. Historical complaints of stock depletions in the 1800s, albeit referring to coastal areas and potentially grounded in economic interest, cannot be dismissed and are supported by the effort levels that emerge from this analysis. In fact, many elasmobranchs species had already disappeared at the beginning of the 20th century [195, 65], and this is likely due to the coastal trawling effort levels at the time. The declining LPUE in the sail trawl fishery of Valencia in the early 1800s could indicate local stock depletion already occurring at the time (Figure 4-1).

The increase in effort (HP) after the 1950s is remarkable, between 3 and 4 fold if we compare the 1950s to the 1980s. From the 1850s to the 1980s the average increase in HP is approximately 10 times in the areas under investigation. The uncertainty about historical sail trawler HP, while still important, seems negligible compared to such a large increase in HP in the modern series. If we generalize the patterns identified in Catalonia, the Gulf

of Lions, and the Adriatic to the northwestern Mediterranean, we can assert that this area underwent the earliest trawling fishing impacts in the Western world. An enduring fishing pressure with non-selective gear for more than 400 years is not negligible. Assessing Mediterranean fish stocks starting from 1994 will have some problems: the first issue will be life history parameters which will have been estimated at best using samples post 1950. Similarly, carrying capacity estimates will not be near pristine biomass. The other aspect that could be of concern is the effect of a centuries-long fishing selection process. Evolutionary effects caused by selective fishing pressure have been hypothesized to affect the genetic variability, the growth rate, and the maturity at age of fish [196, 197, 198, 199, 200]. Biro *et al.* (2008) [199] distinguish between fish with slow growing and fast growing genotypes. Fast-growing individuals typically are more active, more bold in the face of risk, and more aggressive than slow-growing genotypes. Fast and slow growth parameters, where the fast are more recent estimates, are being used in recent SGMED assessments. Because the use of one set or the other makes a significant difference in assessment results, this is clearly an issue that needs to be evaluated in sight of long human exploitation of Mediterranean demersal stocks. An additional effect of a long-term trawl use will be on benthic habitats of fished areas, where complex habitat structures will have been destroyed with potential consequences for fish habitat.

If the conclusions on fishing efficiency derived in Chapter 1 are applied here, the true estimate of fishing effort would significantly change. If fishing days are not considered, it is assumed that fishing effort depends on the area swept by a net, which is sized to vessel HP. Under this scenario, the polyamide nets of trawlers in 2000 will sweep an area that is 2.3 times larger than the area swept by equivalent sized vessels with hemp nets in 1950. This would imply that the decline in HP after the mid-1980s has been largely compensated for by increased swept area of the nets. In addition, HP has certainly been under-declared since the mid 1980s in Spain, the 1970s in France, and the 1990s in Italy [4, 92, 201, 14].

3.6 APPENDIX 3

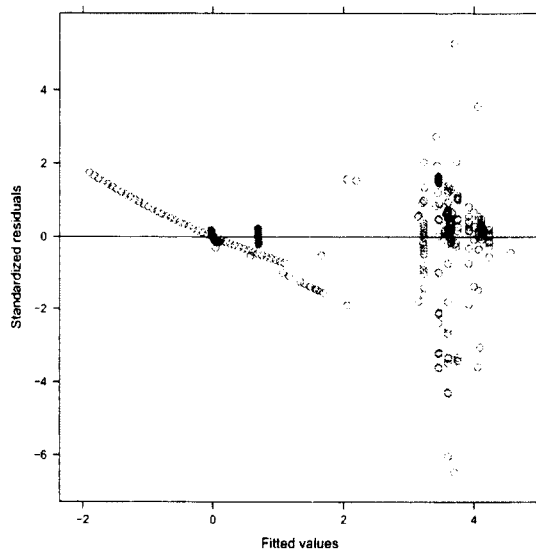

Figure 3-11. Standardized Residuals versus fitted values for best model in Spain pre-1950

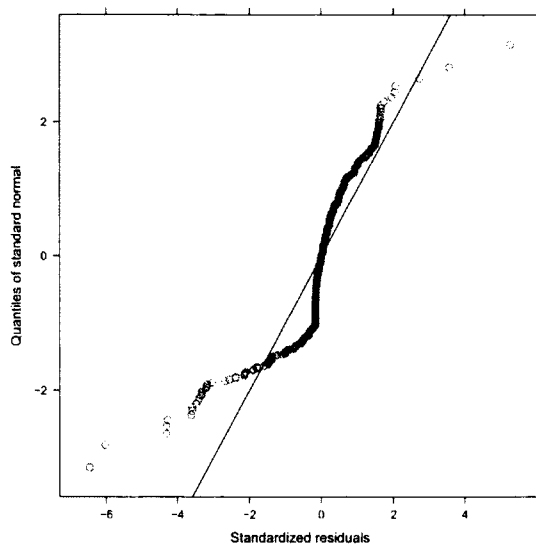

Figure 3-12. Q-Q plot of Standardized residuals for best model in Spain pre-1950

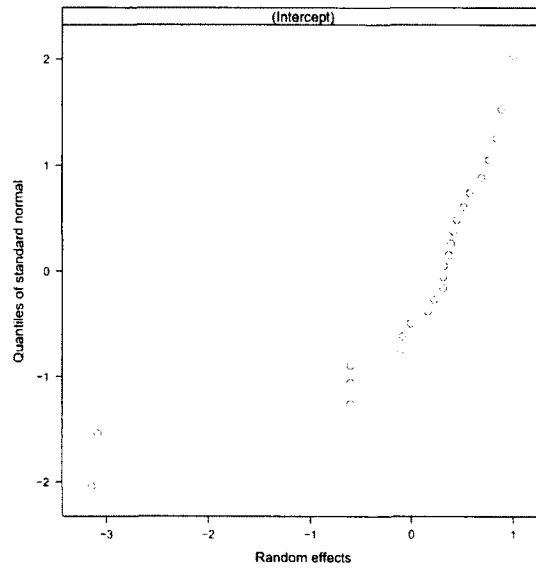

Figure 3-13. Random Effect Q-Q plot for best model in Spain pre-1950

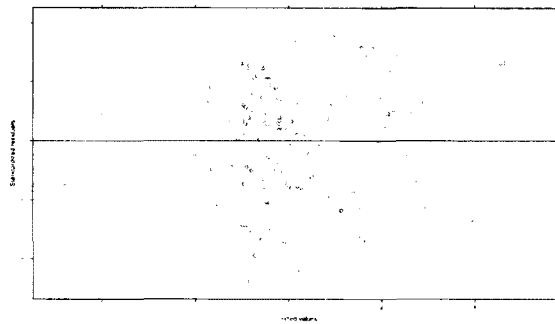

Figure 3-14. Standardized Residuals versus fitted values for best model in Italy pre-1950

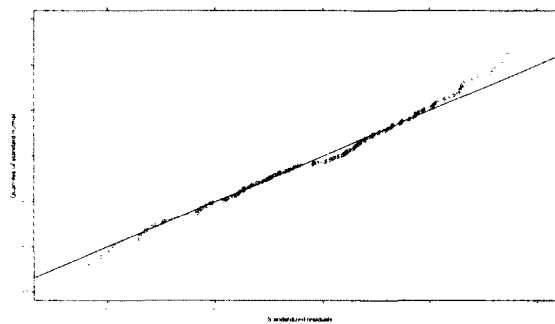

Figure 3-15. Q-Q plot of Standardized residuals for best model in Italy pre-1950

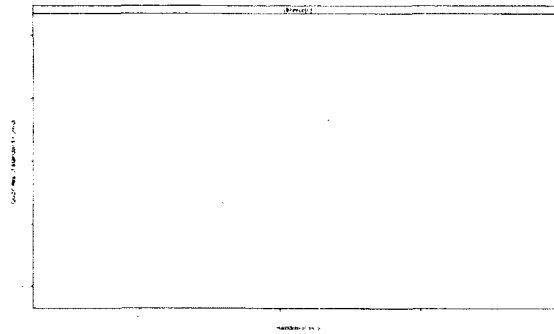

Figure 3-16. Random Effect Q-Q plot for best model in Italy pre-1950

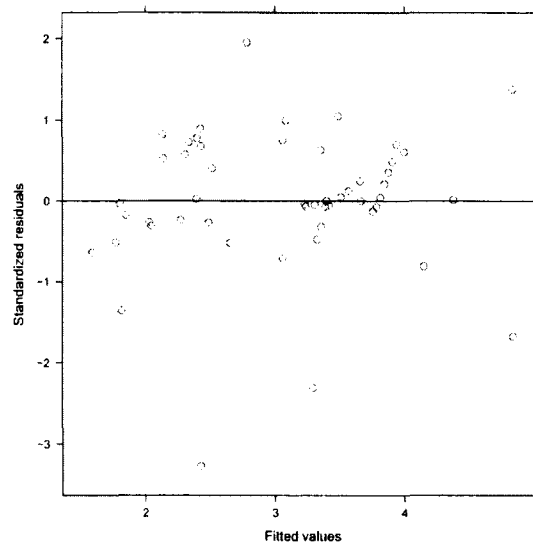

Figure 3-17. Standardized Residuals versus fitted values for best model in France pre-1950

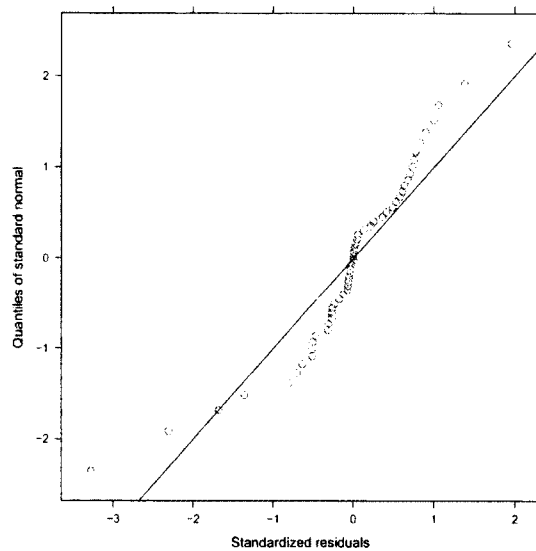

Figure 3-18. Q-Q plot of Standardized residuals for best model in France pre-1950

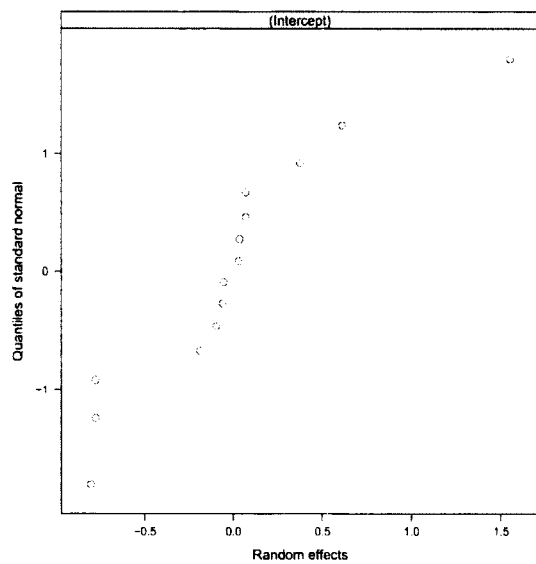

Figure 3-19. Random Effect Q-Q plot for best model in France pre-1950

country	GRT	GT	LOA	number
Albania	7648.35	11282.22	3335.21	148
Bulgaria	1218.34	1845.08	493.57	22
Croatia	6938.26	10587.16	3282.67	152
Cyprus	542.66	789.04	249.39	12
Egypt	53466.65	81979.85	24505.43	1110
France	5159.24	6914.52	2191.11	104
Greece	14478.81	22186.48	6754.09	312
Italy	87035.91	131502.46	38563.68	1747
Libya	9422.14	14465.93	4131.22	185
Malta	1101.00	1097.39	352.59	17
Slovenia	269.85	339.89	116.34	6
Spain	39022.50	58040.55	16402.30	743
Syria	851.53	2048.40	428.07	17
Turkey	10023.71	13710.50	4229.93	196

Table 3.12. Summary of vessel information available for Mediterranean trawlers from GFCM website for 2006/2007

CHAPTER 4

MEDITERRANEAN TOTAL DEMERSAL CATCH TRENDS FROM COMMERCIAL TRAWL LPUES

4.1 Introduction

This chapter explores trends in total demersal fish from LPUE data with the objective of identifying shifts in relative abundance over long temporal scales. It is structured in two parts, a detailed description of the historical data and a modeling section. The oldest LPUEs will be described in the first section in chronological order from 1779. These include average values reported by different authors, gathered from fishermen interviews, or from official records. The second section describes systematically collected quantitative trawler catch starting after 1940. All of the more recent records are by commercial species or species groups, with the notable exception of the data for the Sicilian Channel. Since the LPUEs from different periods derived from trawl vessels of different size, HP and fishing power, proper standardization is very important to derive reliable trends in abundance. LPUE data was first standardized and then modeled with generalized additive mixed models incorporating a correction for fishing power increase. A set of models at the country level was fitted first to explore local trends and then a unique model for the entire western Mediterranean was fitted to all data, including most historical series. The results in both cases show very large declines in total commercial demersal catch over the past 50 years and even larger over the past 100 years although uncertainty is greater for the oldest LPUEs.

4.2 Historical LPUE description

Fisheries dependent or independent data can be used to reconstruct temporal change in fish biomass. In the case of the Mediterranean Sea, sources of fisheries independent

information prior to 1945 are extremely rare. To build trends in fish biomass or a proxy index over longer periods it is necessary to rely on fisheries dependent data. This chapter focuses specifically on this type of data. The goal is to estimate trends in relative biomass of demersal species caught in trawl nets for different areas in the Western Mediterranean.

Historically, fisheries landings have been used for stock assessments [41] to build catch per unit effort (CPUE) as a proxy of true fish biomass, and to estimate the parameters of biomass production models. In this case the main source of data are LPUEs, which relate to CPUE by:

$$LPUE = CPUE - DISCARD \quad (4.1)$$

LPUE is what a trawler landed after sorting the catch of a fishing trip, or what is classified as commercial catch during exploratory fishing. The difference between LPUE and CPUE, discard, can be significantly large. Thus, the criterion of retaining only LPUE or total commercial catch was followed through data collection and analysis. The Mediterranean demersal fisheries are and have been historically [168, 108, 9, 17, 202, 78, 16, 203] and currently [201, 204, 205] characterized by a multi species approach with at least 50 species retained that have commercial value. In the case of the Mediterranean Sea, we researched many sources of commercial data from demersal trawlers from 1700 to the present and collected heterogeneous information with the following properties:

1. Heterogeneous units of fishing effort: Different authors reported effort in units ranging from catch per year over an aggregated number of vessels, to catch per fishing hour and catch per tow.
2. Fishing power: Over time the fishing power of trawlers has changed as vessels changed (pair sail trawlers, steam trawlers and modern trawlers). Since these are temporally segregated from one another, reliable estimates of fishing power were necessary to adequately compare LPUEs.
3. Fishing areas: Old sail trawlers were capable of trawling only in relatively shallow coastal areas, however modern trawlers can fish on the continental shelf, much

deeper on the slope, and far from the coast, making comparisons of fishing areas difficult. With the exception of commercial scouting, data were reported by port of landing or region where the fishing occurred, so that exact locations of fishing areas are unknown.

4. Catch composition: Authors from the past often report only total commercial catch and if discarding practices or targeting have changed over time, total commercial catch in one period might be different from another.

Despite these potentially confounding elements, we have collected LPUE data from all possible sources and have attempted, when possible, to standardize the LPUEs to common metrics.

4.2.1 Description of historical trawl LPUE (pre-1950)

The earliest accounts of LPUE data come from the Adriatic Sea. Here, Ciotti reported for 1779 the landings from 24 owners of sail trawlers in Porto San Giorgio (at the time called Porto Fermo) in the Marche region in Italy [7, p.154]. Landings were reported by pair of trawlers by owner and the boats are defined as *paranza*, the typical pair sail trawlers of the Central Adriatic at the time. In 1778, Porto San Giorgio, registered 12 pairs of trawlers and, in 1779, landings broken down by owner reported the yield of each pair when only one net was operated. The number of fishing days is not known, so mean catch per year per vessel is estimated. The catch was reported in *libbre* weight unit and has been converted to kg (1 *libbra*=0.327 Kg). Results show that a pair sail trawler fishing in the Adriatic in 1779 yielded an average total catch of 13.5 tons, with a range of 6.1 to 22.6 tons (Table 4.9).

Ciotti also reported average LPUEs for sail trawlers from later periods. According to Liburdi (quoted in [7, p.120]) in San Benedetto (Adriatic Sea, Italy) in 1812 the total catch from 10 pairs of sail trawlers was 70 tons (7 tons per pair per year). In 1846 in Porto San Giorgio, approximately 20 sailing pair trawlers (*paranze*) caught on average 18.6 tons per pair per year [7, p.120]

In the 18th Century fish landings in Valencia (Spain) were written on the registers of D. Pedro Esteve, the royal official charged with collecting duties of one fifth of the catch from the Albufera lagoon and one third of the fish caught at sea. These records reveal that the catch of pair sail trawlers sold in Valencia between 1792 and 1818 was 10,409,350 kg, and catch of other marine fisheries was 8,664,812 kg. That is an average yearly catch of 385,525 kg for all trawlers and 320,912 kg for other gear. In 1819 trawlers caught 102,912 kg and other gear 274,175 kg. In 1844 total marine catch did not exceed 400,000 kg and in 1860 total fishery landings on the Valencia coast were reported at 588,062 kg [110, p.392]. Information with the raw data of sail trawler landings reported by Berthelot is found in the manuscript of Coronas in 1866 [17]. This author gave the landings of fish sold in Valencia per year from 1792 to 1818 in *arrobas*, the unit of weight used in Valencia at the time. From Berthelot [110, p.392] we can derive the conversion unit 1 *arroba* = 12.52 kg. Total landings for pair sail trawlers and long-liners are also reported [17, ?]. The author reported that sail pair trawlers (*pareja de bou*) increased steadily from 16 pairs in 1792 to 31 in 1818. In addition, trawlers were allowed to fish from October 1st to April 1st (6 fishing months) until 1804; after that the fishing season was extended from September 1st to May 31st (9 fishing months). To calculate an LPUE (tons/year), we reconstructed a number of vessel series by calculating a yearly rate of increase of 2.5 % per year starting with the figure for the earliest year, 16 pair trawlers. We then divided the catch by the number of fishing months and the estimated the number of trawlers. This returns a monthly mean catch per pair of trawlers for each year, which is plotted in Figure 4-1. A decreasing trend in LPUE is evident over the time-series.

In 1868, Berthelot [110, p.275] assessed that in the Gulf of Lions 250 trawlers operated for 6 to 8 months, with at least one third consisting of large trawlers. Approximately 1,200-1,500 fishermen were employed in the trawl fishery and the total yield was assessed at 880,000 francs or 880,000 kg of fish. The discard rate was believed to be very large due to unmarketable juveniles and damaged fish. Berthelot considered discards to be half of the catch and estimated the daily yield of a *chalut boeuf* (pair sail trawler) as 500 kg while a small long-liner, or purse-seiner did not exceed 50 kg daily [110, p.292].

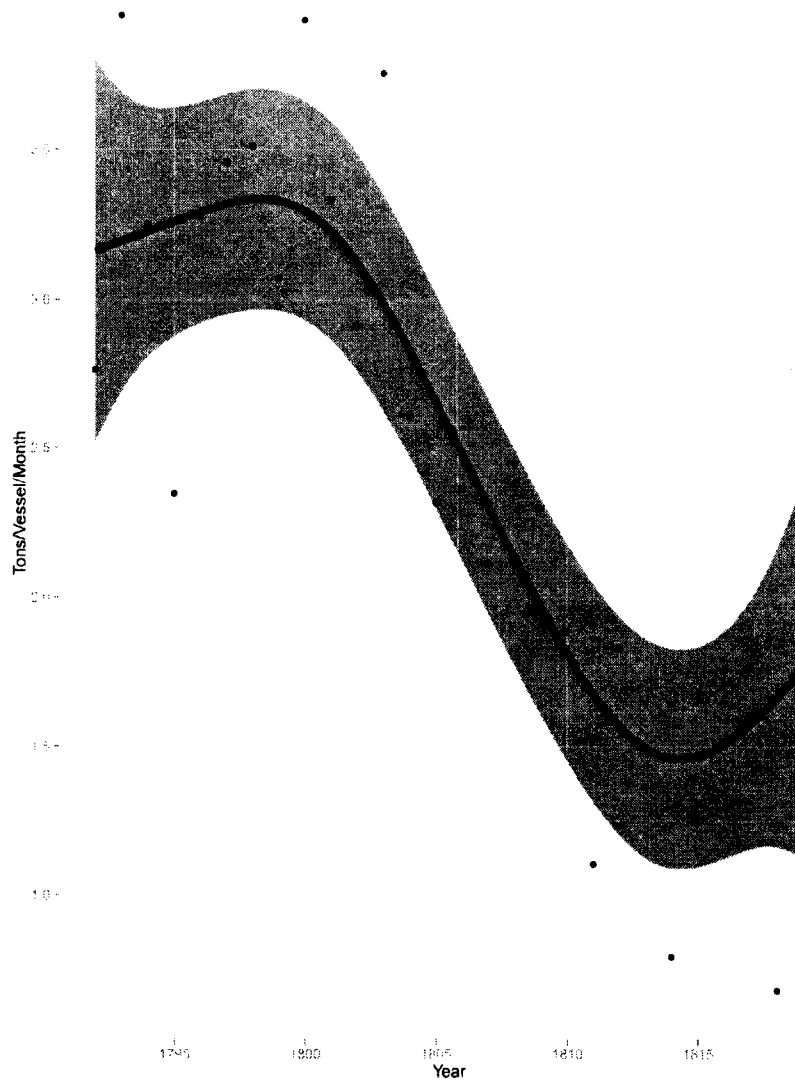

Figure 4-1. Mean monthly catch per pair of sail trawlers per year in Valencia (Spain) from 1792 to 1819, from Coronas 1821 [17]

In Marseille (France), Gourret [29, p.21] wrote that a trawling ban had been enforced from 1793 to 1830 because of concern about the impact of trawling. When the ban was lifted 10-12 ton sail trawlers fished on soft bottoms deeper than 100m. According to old fishermen's accounts reported by Gourret, single tows carried by pair trawlers yielded as much as 150 *quintals* of fish.. The historic French royal *quintal* was 100 *livres* (48,951 kg)([http://fr.wikipedia.org/wiki/Quintal_\(unit\)](http://fr.wikipedia.org/wiki/Quintal_(unit))) but this unit was abandoned and replaced with the metric *quintal* which corresponds to 100 kg. It is unclear which metric system Gourret's yields of 150 *quintals* employed. If the historic *quintal*, the per tow yield in 1830 was 7,342 kg, but the metric *quintal* gives approximately 15,000 kg. Taking the most conservative as the correct conversion still yields approximately 7 tons of catch per tow, an extremely large catch even by today's Mediterranean standards. This record is, however, quite anecdotal and should be considered with caution. Post-ban, Gourret reported catches of Mediterranean hake (*Merluccius merluccius*) weighing 7-8 kg and John dories (*Zeus faber*) of 2-3 kg.

Chudeau [206, p.5] stated that in Algeria landings of 10 kg Mediterranean hake were common in 1885 but by 1905, the average weight had dropped to 5 kg. This corroborates Gourret's description of the decreasing size of fish brought to Marseille by steam trawlers fishing in Algeria and Tunisia in 1880-1890 [29].

Berthelot [110, p.302] quoted the work of the Spanish Fisheries Commission in 1814 [207, p.21], which began investigating the impact of trawling. Upon inspection of some pair trawlers operating in Malaga the Commissioners reported:

The first boat that we boarded was that owned by Mariano Coscollo, that we obliged to haul the net. The large net body of this gear, laid on the deck, offered to the eyes of the commissioners an immense mess of mud, mixed with sand, debris of sea-grasses and a multitude of fish, of which some of medium size but the large majority of juveniles coming from feeding grounds where they were born. All these juveniles species, died of asphyxia in the mud, that we could not recognize before having them removed from the mud and washed with water, were discarded at sea as useless. The Commission proceeded to another inspection on board two trawlers that were hauling their net: ten *quintals* (500 kg) of fish were sorted from the muddy debris and more than half was composed by juveniles that were discarded at sea. The owner of another pair trawler, Vincent Pascual, declared that he normally started fishing at 1/4 of

lieue (0.75 Nm) from land trawling offshore for 5 *lieuese* (15 Nm), trawling over anything that was on the sea bottom, and that he always had to discard half of his catch that was composed by juveniles with no commercial value.

Ferretti wrote that fishing yields in Fano (Adriatic, Italy) were very high [16, p.154]. He reported that in 4 fishing days between October and November in 1910, the yield from a pair sail trawler (*muta di barchetti*), regardless of size, brought in revenue of 1,000 *Lira* from the sale of the catch. From Ferretti's estimated value of 0.28 *Lira* per kg of fish, 3,571 kg were caught in 4 days of fishing, or 892 kg per fishing day for a pair trawler. The yield of 4 weeks fishing at that time exceeded 100,000 *Lira* [16, p.154]. Conversions based on the previous calculation return a catch of 357,142 kg over 24-30 fishing days. However, it should be mentioned that 30 fishing days is highly unlikely for a sail trawler due to unfavorable wind or weather. Dividing the catch by the estimated fishing days returns a range of 1.5-1.2 tons per fishing day for a pair sail trawler. A third estimate of catch described by Ferretti was based on the number of boxes of fish caught. Each box held approximately 30 kg of fish. According to reports, it was possible for vessels fishing on soft muddy bottoms in the Eastern Adriatic to catch 20-30 and up to 40 boxes of groundfish in a few hours. Translating the number of boxes in kg returns an average of 750 kg, with peaks at 1200 kg, for a few hours of fishing, which we assume to be the maximum hours fishing in one day. In the Adriatic, Ferretti reported that a pair of sail trawlers from Fano caught 1,600-2,000 kg in one night during the migration of *Clupea sprattus*.

In 1916 a 40 ton motor trawler with a 40 HP diesel engine fished in the Gulf of Cagliari (Sardinia, Italy) from July to September. Fishing at night at 20-30 *braccia* (11-17 m) depth in single tows could yield up to 12-13 *quintali* (1.2-1.3 tons) of Blotched picarel (*zeroli Spicara maena*). The total yield from one night's trawling was at minimum 3 *quintals* (300 kg) and on average 6-7 *quintals* (600-700 kg) [77, p.29]. Such yields were on sandy and algae bottoms in areas that were already exploited. Mancini argued that more distant areas would give greater yields.

By 1932, fishermen of Porto Santo Stefano (Tuscany Italy) were fishing at depths of 500 m. In 1937 there were 45 trawlers between Porto Santo Stefano and Porto Ercole, and

vessels with the most power (100-150-200 HP) fished between 300-500 m [118]. According to Porto Santo Stefano fishing captains, yields on bottoms at 450-500m depth were 400-500 kg per tow, while at 100-150m the catch was 100 kg per tow [118].

Several 40 HP trawlers operated in Crotona (Italy) in 1930 [82, p.72]. These trawlers pair trawled, fishing for 300 days per year with 4 tows per day as usual fishing practice. In 1926 yields averaged 60 tons for those owned by Foti and 90 tons for those owned by Vecchi [81, p.21]. An estimated average catch per fishing day in 1926 is 200-300 kg for one pair motor trawler of 40+40 HP and 20+20 tons.

In 1926 Ermiro [6] reported 13 trawlers fishing in the southern banks off Lampedusa (Sicilian Strait). Among these were 10 steam trawlers (ranging between 86 and 235 GRT) and 3 diesel engine trawlers (of 9 and 90 Net tonnage). The average catch over the summer months was 2,473 kg per fishing day with a standard deviation of +/-1,485.

In 1926 in Mazara del Vallo (Sicily) there were 1 motor trawler, 2 *paranze* with engines (pair motor trawlers), and 50 sail powered *paranze* (pair sail trawlers). Under good fishing conditions daily yield per trawler was 1.5-1.8 tons, with an average of 1 ton and exceptional catches of 3-3.5 tons [6, p.15]. In Porto Empedocle, 206 fishing vessels totaled 902 tons, but it is unclear how many were trawlers. Among these were 6 steam trawlers between 50-100 tons and 30 and 42 m in length. Each trawler made on average 5 fishing trips per month yielding 20 tons. Assuming each trip had a duration of 6 fishing days, the average daily catch was 3.3 tons.

Nine 10 ton sail powered pair trawlers [55, p.6] with 6 fishermen crews each fished from Pozzallo (Sicily) in 1930. These normally fished between Mazzarelli and Capo Passero within 10 nm from the coast, but in good weather could go 20 nm offshore on banks 90-100 m deep. Fishing was year round except for 3-4 months in the winter. Tows lasted up to 6 hours and each haul in the winter could yield 300-600 kg. Targeted species included hake, red mullets, gurnards, flat fishes, octopus, squid, and lobster., steam trawlers from Siracusa and Catania (Sicily) also fished in the winter in this area. Each sailing *paranza* caught 100 tons per year (8-9 months of fishing) [55, p.7], averaging 11.7 tons per month.

Solari reported catches with the *Tritone* experimental trawler of up to 2 tons per hour in the area of Zuara (Libya) [55, p.42].

There were two main fishing grounds in the Tunis area, the Gulf of Tunis and the Gulf of Hammamet. Harvesters began fishing on the former around 1830 [100] and on the latter in 1923 [208]. Most of the fishermen in Tunisia came from Sicily and half of the landings were generated by steam and pair sail trawlers [208]. In 1926 trawlers landed 1,970 tons of fish. A small motor trawler caught 135 tons of fish while fishing with 29 sail trawlers in the Gulf of Tunis in 1923. Two sail pair trawlers caught 356 tons in the Gulf of Hammamet in the same year. Since the motor trawlers were performing well, the following year, 11 small steam trawlers and 16 sail trawlers were equipped with motors, while 16 sail trawlers remained unchanged. There were already signs of overfishing by 1925 in the Gulf of Tunis so the larger trawlers were sold and some other boats moved to different fishing grounds. The data in Monconduit reported tons of catch per year. In order to be able to convert these estimates into Kg per fishing day, we used estimates of fishing days from Tunisia for motor trawlers over the period 1967-1971 [21]. These data generate an average of 112 fishing days per year. Assuming the same number of fishing days seems reasonable when applying it to sail trawlers and steam trawlers given the better sea worthiness of the motor trawlers from 1970.

Paolucci described the fishing activity of the *Conero* steam trawler [11], which Mr. Malucci had purchased in 1912 in England. Fishing experiments carried out with the trawl nets regularly used in the Adriatic Sea failed as the nets were not rigged with otter doors. On the contrary, the *Conero* gave good yields when rigged with 5 beam trawls (*rapido*) with mouth openings 5 m wide and 0.45 m high, and 35 mm mesh at the mouth tapering to 25 mm at the codend. Fishing strategy was based on daily trips of 8 hours fishing. Yields were reported daily from July to November of 1912 (Figure 4-2).

Mengaroni [181] estimated that the fishing yields of a sail trawler were ten times less than the yields of a motorized trawler, and he also reported the catch of a 120 HP trawler in Fano in 1939. Over 4 fishing cycles of 7 days, the average catch per cycle was 2.7 tons, and average of 385 kg per fishing day [181, p.77].

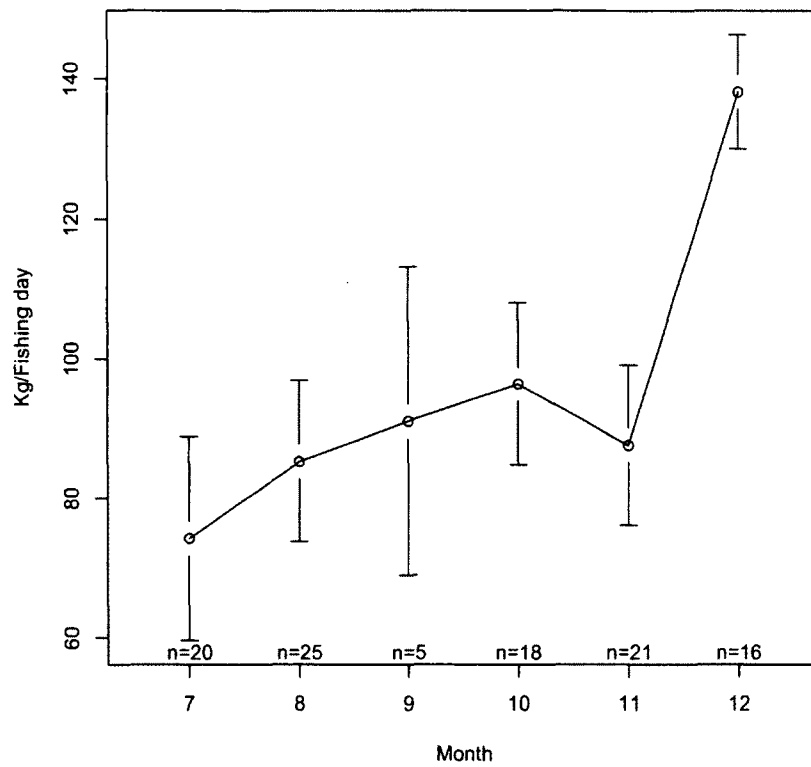

Figure 4-2. LPUE for the *Conero* steam trawler fishing in the Fano area (Adriatic Sea, Italy) in 1913 with 5 beam trawls (*rapido*), from Paolucci (1913) [11].

Puglia (Southern Adriatic) in the early 1920s saw the start of trawler mechanization and in Bari in 1927 there were 18 motorized trawlers. By 1930, there were 32, and five more were added in 1931-1932 [178, p.484]. The advent of motor boats quickly made the traditional sailing *paranza* obsolete since it had yields that were 7-8 times lower than the motor trawlers [178, p.484].

In Castellon (Valencia, Spain) trawler LPUEs were collected on a monthly basis from 1945 to 1946 for the whole fleet of approximately 30 trawlers with 60 HP mean engine power [209]. The data report catch per month, number of trawlers, and the range of HP for which the mean is used. Additionally, LPUEs (kg/day) of 5 trawlers ranging between 25-70 HP are given for the same period. To convert the aggregated monthly estimates to kg/day, we estimated a number of fishing days that would make the two series comparable (we used 15 fishing days per vessel to scale the monthly catches).

All the LPUEs collected have been plotted by country, area and year under since kg/-fishing day since not enough information was available to convert from one unit to the other in many cases (Figures 4-3).

4.3 Modern Commercial LPUE

In the previous paragraph we described the available accounts of yields from sail, steam and motor trawlers prior to WWII. For the post WWII period numbers of records increase and overall data quality improves. As much LPUE information has been searched and compiled covering areas from all the western Mediterranean, we will describe the areas that will subsequently be used to perform analysis. Two studies performed in the 1950s and 1960s by F. Doumenge and C. Bas are extremely useful in providing trawler yields from that period, and will be described in detail.

4.3.1 France, Pt. Vendres and Sete, 1950-present

For his PhD in 1966, F. Doumenge did extensive work comparing fishing practices and yields in different Mediterranean countries [8]. He mainly focused on the demersal trawl

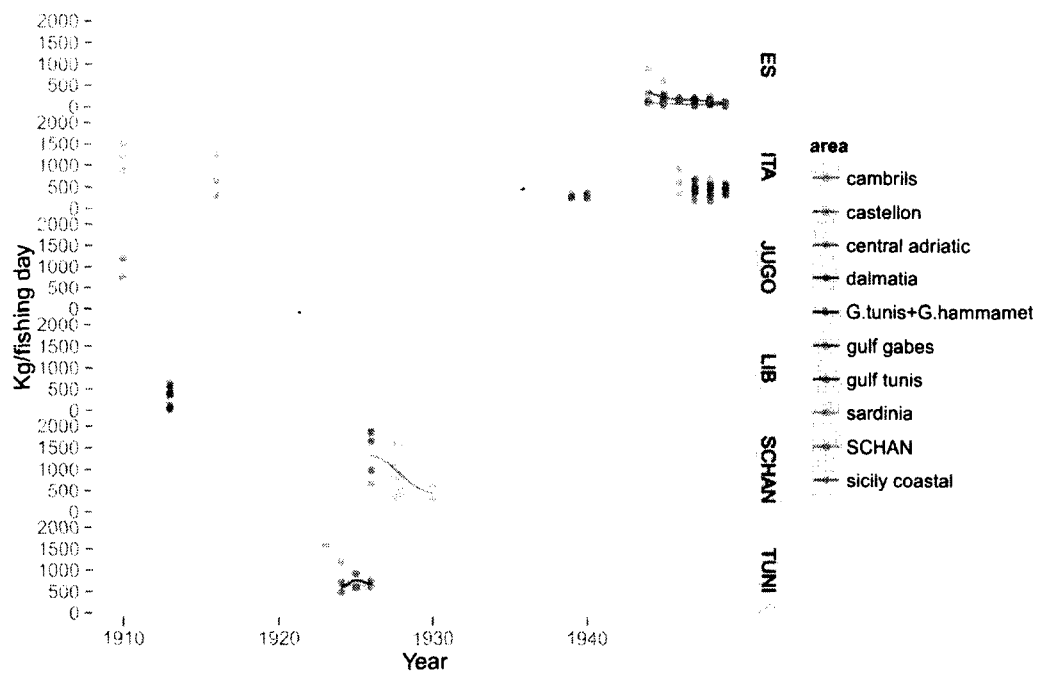

Figure 4-3. LPUE of total demersal catch by country and area in the western Mediterranean. ITA=Italy, SCHAN=Sicilian Channel area, JUGO= former Yugoslavian area, TUNI=Tunisia, LIB=Lybia, ES=Spain (Catalonia)

fishery in Spain, France and Italy over the period 1948-1958. Here we also describe data from Italy and Spain since the collection criterion is the same.

Doumenge often stated that official landings are highly unreliable in the Mediterranean. To avoid potential confounding in data and results, he established a data collection protocol articulated in four main premises [8, p.51-54]:

1. Because of natural variability, trawl yields change over time and therefore time series should be at least 3 years long to account for such effects.
2. It was decided to sample the entire fleet population in the selected ports rather than using random sub-sampling.
3. Fisheries data were selected by avoiding any source of official statistical data. Most samples were recorded on board, on the dock, or during fish auctions. When this was not possible private and reliable records from fishermen were used. To respect fishermens privacy, data series more recent than 10 years ago were not used.
4. There is need for uniform data that allows for standardizing series from different geographical areas based on technical and biological criteria. These criteria are the following:
 - Gather only data from unregulated fisheries in order to not introducing management confounding. For example, the multitude of regulations in France made it difficult to select a fishery.
 - Obtain complete catch records. In the 1950s in France, the discard rate was high for species like horse mackerel, sprat and anchovies, while in Italy and Spain there was no discard and all catch was landed.
 - As WWII had imposed long no fishing periods in different countries, Doumenge argued that to compare series from different areas it was necessary to wait until the yields had stabilized. For this reason he chose data from Spain from 1945, Italy from 1949, and France since 1950.

- Gather data that can be standardized by technical gear. For this reason ranges of trawlers with 20-40 HP, 50-90 HP, and 90-150 HP, were chosen.

In France in the Roussillon region, Doumenge monitored 10 trawlers (6 with more than 90 HP and 4 with 50 HP) based in Port Vendres over the period 1951-1953. Data from 4000 fishing days were collected and the main commercial species were recorded separately [8, p.56]. Vessel characteristics and fishing operations are reported in Table 4.14, 4.15. Fishing trips lasted one day for the trawlers in Port Vendres that Doumenge monitored [8, p.69].

In Spain's Catalonia region the port of Cambrils is located in the northern part of the Ebro delta. It was chosen for data availability and because the southern part (Castellon) was already well described by Spanish researchers [8, p.58]. In Cambrils the reconstructed series covered the periods 1945-1947 and 1951-1952 for a total of 55,101 fishing days. Only total landings were recorded. Weight estimations were uniquely precise as this was the only port that used a scale instead of selling the fish by the box [8, p.58]. After 1958 the sale system shifted to box and baskets unit and Doumenge deemed it too unreliable to report the data. This same year saw an increase in the size of trawlers, which started exploiting deeper grounds, adding a new variability to the landings and series that were not taken into account [8, p.59]. The Spanish data were complemented with records from the port of Adra in Andalusia where, in 1955, a total of 1,908 fishing days were observed, but only total catch reported.

In Italy one investigated area was Porto Torres in the north of the Sardinia Region. Here the Farra family gave access to their fishing logbooks, and data from 1944-1958 was collected for a total of 8,451 fishing days [8, p.59]. Here the fish landed were registered in one of four commercial categories and there was generally very little discard. To gain insight into the Adriatic trawl fishery in 1955, Doumenge gathered data from the ports of Cattolica, where 1,986 fishing days had been recorded. In Fano 10,885 fishing days were monitored, but only total catch was reported [8, p.60].

When Doumenge described the misreporting of fish landing, an interesting practice emerged. It was common knowledge and practice to under-declare fish catch in order to

avoid paying sales tax. However in places like Spain in from 1940-1950, where fish prices were fixed by law, fishermen would set the market value of their catch by over-reporting the amount to be sold at the legal fixed price [8, p.52].

The LPUEs collected by Doumenge are summarized in Figure 4-4.

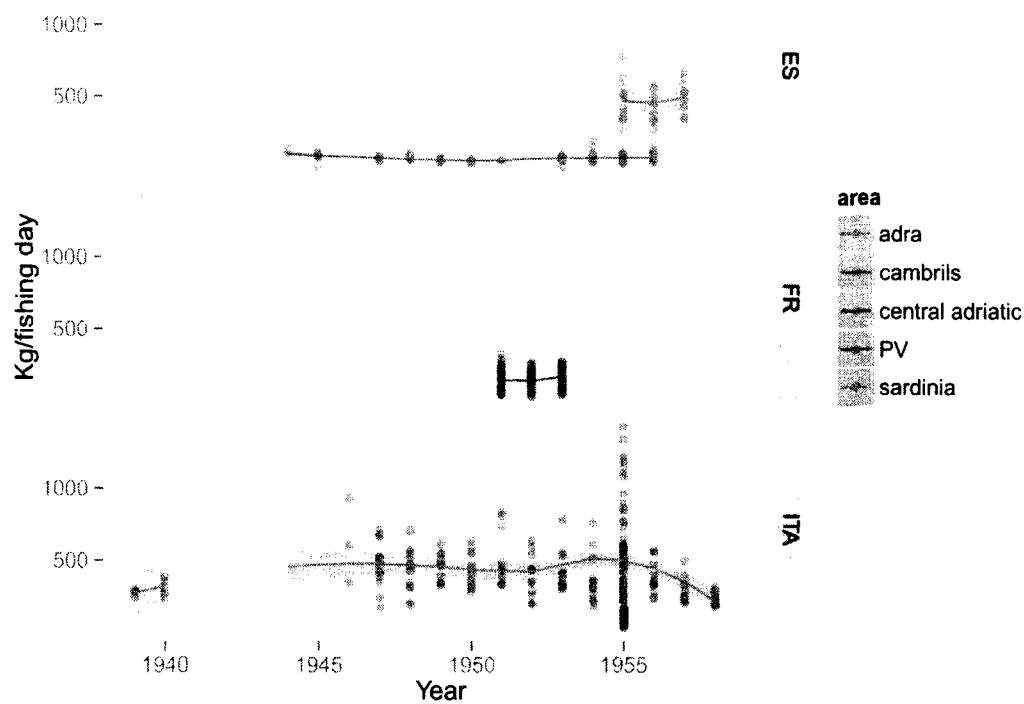

Figure 4-4. Total demersal catch per fishing day from commercial trawlers in different areas of Spain, France and Italy over the period 1940-1955, from Doumenge [8]

4.3.1.1 Sete and Port Vendres

Sète data from the old series, covering 874 fishing days of 10 trawlers discontinuously between 1971 and 1974, has been collected by the former INSTPM (today IFREMER Sete). The trawlers sampled are representative of all HP classes in the fleet as they range from the smallest to the largest, although for many trawlers GRT or length are not reported. In this period a subsample of vessels from Sète was monitored for approximately 60 commercial

species. At the time most of their fleet operated with trawls with low vertical openings [93, p.78].

The modern series covers 742,461 fishing days and all Sète trawlers fishing between 1994 and 1997. This data series, as well as data from Port Vendres for the same time period, have been collected by the Office Interprofessionnel des Produits de la Mer et de l'Aquaculture (OFIMER) (for a full data description see Peredou and Adrianlavy, 1999) [186]. The OFIMER database reported catches landed at the Port Vendres fish auction for a total of 172,029 fishing days. The fish auction in Sete reports 142 species categories in the modern period, while in Port Vendres there were 211. In both cases a category can be juveniles or medium-sized specimens of certain species. At this time there were 3 types of trawlers: (1) traditional low vertical opening targeting demersal fish, (2) GOV targeting demersal and small pelagics, and (3) GOV targeting only small pelagic [186]. Fishing trip duration was fixed at one day with the trawlers departing and returning to port at fixed hours in both past and recent periods. In the case of French trawlers, a legal limit of 316 Kw had applied to trawler engines since 1974 . Almost all trawlers in the modern period declared engine power equal to the legal limit, although there is clear evidence that power was grossly under-declared [93, 186] .

Finally for 2002-2004 LPUEs available from Sète and Port Vendres cover a total of 28,237 daily fishing trips by demersal trawlers.

4.3.2 Adriatic Sea, data description former Yugoslavia 1950-present

The Adriatic Sea provides good records of commercial trawler yields particularly due to Yugoslavian authors who monitored trawl fleets for long periods for management purposes. The earliest authors, Zei and Sabioncello [210], compared hourly catch rates before and after WWII.

Zupanovic in 1951 [18] organized fishing logbooks for captains in order to gather catch information from different areas of Yugoslavia. The coast was divided in fishing boxes of 10 deg Latitude and 8 deg Longitude, for an approximate area of 80 nm². A total of 99 fishing areas grouped in 18 macro areas were defined, although there is some uncertainty

in attributing fishing areas to macro areas. Yearly landings by trawlers are available for 1951 at fishing box level (Table 7, [18, p.180]) while fishing effort is given in terms of number of trawlers and number of hauls at the macro area level (Table 8, [18, p.188]). The fact that effort is given as the number of hauls makes it difficult to compare to later LPUE estimates that are given as either catch per fishing day or per fishing hours. However the author generalized that, on each fishing day, 2 hauls were performed. so this estimate is used to estimate fishing days. Unfortunately trawler HP is not specified in detail, but data reported by Crinkvic [211, p.36] show that the average vessel HP in 1958 for Yugoslavian trawlers was 88 HP. Weight of catch (kg) per fishing day are plotted by area for 1951 in Figure 4-5 and kg of total catch per fishing hour are plotted in Figure 4-6.

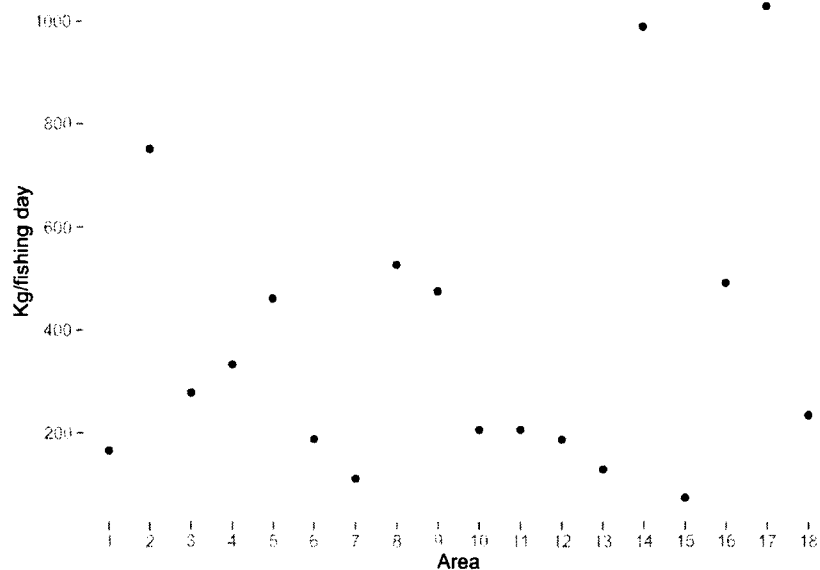

Figure 4-5. Average daily catch in Yugoslavian waters in 1951, from commercial trawlers from Zupanovic [18]

The following information was reported by 99 areas [18, p.216-219]: total catch, and catch of target species (*Merluccius merluccius*, *Gadus* spp., *Smaris* spp., *Mullus* spp., *Pagellus erythrinus*, Selacians and Crustacea) and other fish. In addition, number of hauls and number of fishing vessels are presented. Further information are the uncorrected (not accounting for differences in HP among vessels, for details see [18, p.190-191]) and corrected

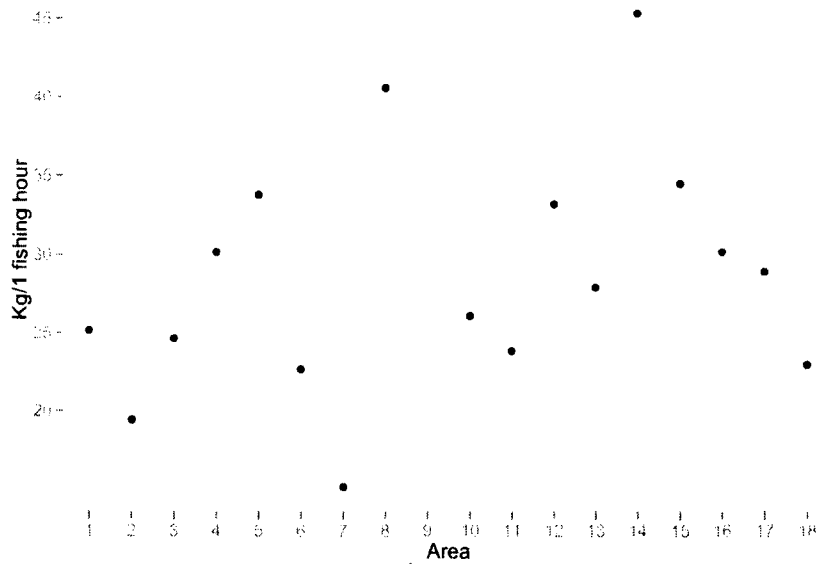

Figure 4-6. Hourly trawler catch in KG in 1951 in Yugoslavian waters from Zupanovic [18]

(accounting for differences in HP among vessels) hourly trawling LPUEs at macro-area level derived by Zupanovic across all fishing vessels. The author also reported hourly LPUEs from pre-WWII and post-WWII from other authors for the sake of comparison (Table XI in [18, p.193]) as shown in Figure 4-7.

Additional LPUE data from Yugoslavian trawlers was reported again by Zupanovic with aggregated estimates for the Northern Dalmatia region [19, Table 2-3, pag. 11]. The data refer to the aggregated catch per fishing day of 4 trawlers of 10, 20, 25 and 50 HP by year. Mean daily catch per trawler is also reported and the relationship between fishing power and HP explored (Figure 4-8).

The FAO supported trawl gear experiments in the Adriatic Sea in 1960 and some useful LPUE data can be extracted from the report by Sharfe [20, p.13-15], which outlines comparative tows by experimental gear and Yugoslavian commercial trawlers operating on the same fishing grounds. Figure 4-9 plots only the daily total catch, catch of *Nephrops norvegicus* and *Trachurus* sp. for the commercial trawlers *Sarag*, *Usata* and *Nabredak* fishing for 3 days in October 1960 on the Blitvenica grounds (Central Adriatic).

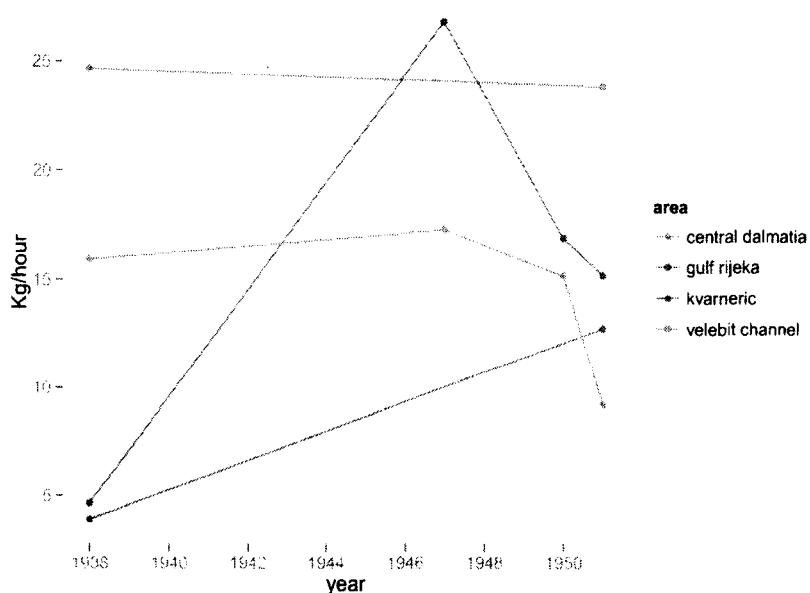

Figure 4-7. Hourly catch in Yugoslavian water before and after WWII. Average trawler HP is between 40 and 60. Fishing grounds in Gulf of Rijeka and Kvarner were reopened in 1951 while the others were reopened in 1947, from Zupanovic (1953) [18].

Crinkovic [211] reported different trawler LPUEs from Yugoslavian waters, most specifically monthly landings per fishing day in 1959 from the Kvarner and Rovinj areas [211, p.34]. Here, catch is detailed for 15 species groups. Additional LPUEs are reported [211, p.44] for the Kvarneric, Gulf of Rijeka and Velebit Channels over the period 1959-1963, with mixed monthly and yearly estimates. Crinkovic also detailed the LPUEs of individual trawlers fishing in the same areas [211, p.72].

In a paper from 1974, Jukic reported LPUEs for *Nephrops norvegicus* in the Northern Channels and Open Central Adriatic [212] over the period 1960-1970. Although the paper focused on *Nephrops*, the author reported either the total catch or the percentage that *Nephrops* represented of total catch, so that total catch can be reconstructed. There are major differences between the two fishing grounds. In the Northern Channels from 65 to 116 wooden trawlers with an average size of 16 m, 25 GRT and 112 HP fished all year at depths of 40-100 m. In the Central Adriatic, a fleet of 6-10 larger vessels (on average 22 m, 80 GRT

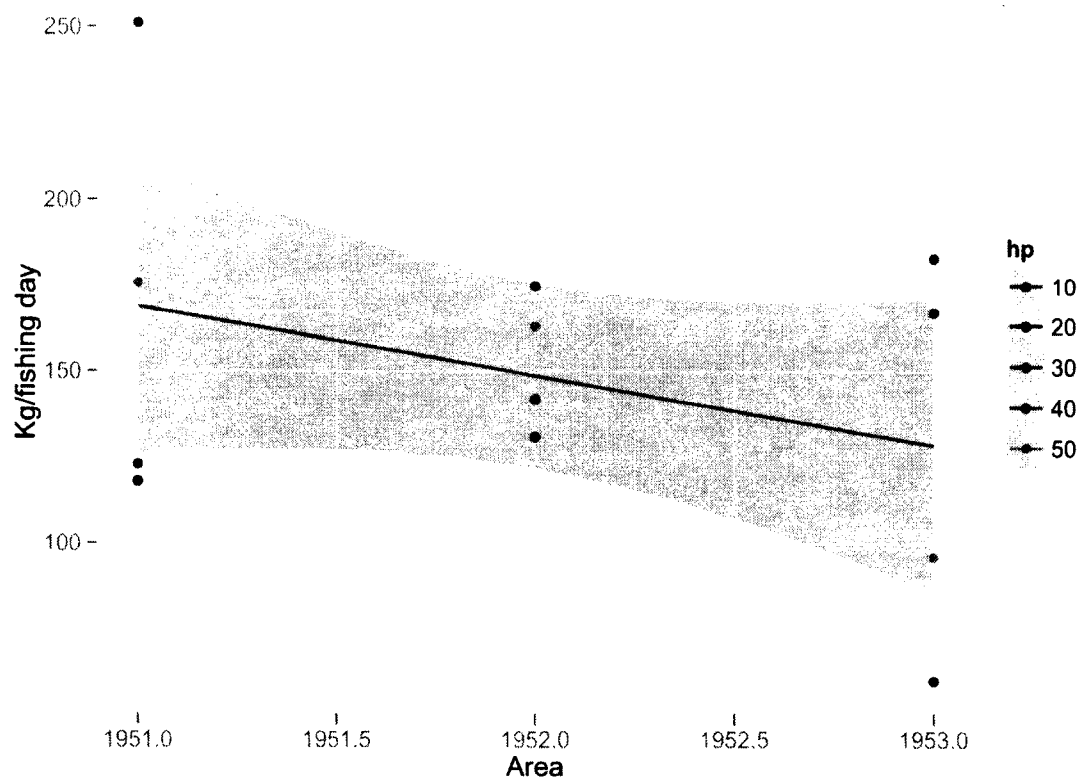

Figure 4-8. Catch per fishing day for 4 different trawlers fishing in Northern Dalmatia in 1951-1953, from Zupanovic (1956) [19]

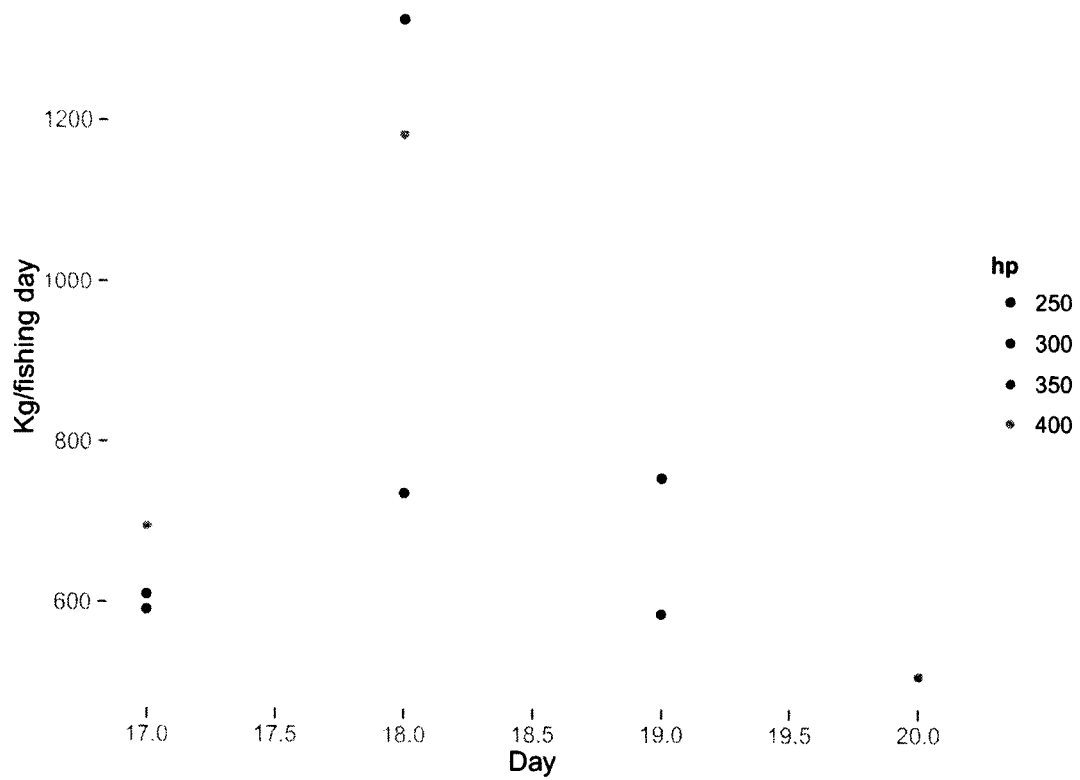

Figure 4-9. Daily catch for 3 Yugoslavian commercial trawlers fishing on the Blitvenica grounds in October of 1960, from Sharfe [20].

and 310 HP) operated on grounds of 180-220 m depth, fishing for six months (spring and fall) for demersal species and switching to purse seining in the summer.

Jukic in 1975 [126, Table 36, pag.22] published detailed LPUEs from approximately 10 commercial trawlers of 240 HP fishing in the Pomo Pit (Eastern Central Adriatic Sea) from 1960 to 1970. Here the unit of effort is fishing day, quantified as 1 fishing day equaling 8-9 hours of towing time. This dataset is of particular importance as catch is detailed at the species level and the series extends over 11 years in the same area, likely with the same boats.

LPUE data is reported in Jukic and Piccinetti [213] from exploratory fishing outside the island of Dougi Otok that, according to the authors, was pristine in 1972-1974 since very little fishing occurred there. Fishing was performed with the 300 HP Italian trawler Santi Medici in November and December. Mean catch for 1 hour of fishing was 195.8 kg in 1972, 128.5 kg in 1973 and 162.3 kg in 1974, however these LPUEs were generated from 9, 12.9 and 9.8 fishing hours, respectively. Forty-one commercial species are detailed in the catch data.

4.3.3 Italy, data description Adriatic and Tuscany 1950-present

4.3.3.1 Tuscan Archipelago

The fish auction of Porto Santo Stefano and Castiglione della Pescaia (Tuscan Archipelago, Italy) have been monitored from 1990 to the present by the Centro Interdipartimentale di Biologia Marina in Livorno (Italy) (CIBM). Landing from each vessel were recorded in fish boxes and by species or commercial group on a sampling basis of 3-4 days per month. On average, landings of 15-20 trawlers have been recorded and fishing trip duration spans from 1 to 3 days. Data was recorded by number of fish boxes and a weight conversion was performed a posteriori using estimated coefficients (for full data description see [187, 214]). Fish are separated and priced by commercial category as size determines price. Given increased enforcement of legal size on juveniles since 2000, the commercial category D (undersized) is not landed anymore and therefore has been excluded from all analyses. To

reduce the variability within commercial categories it was decided to pool different categories within the same species.

Additional data available from this port concerns trawler vessel characteristics such as HP, length, age, tonnage and net used (i.e. low vertical or high vertical opening).

It was decided to restrain the analysis to only fishing trips of 1 day. This is in order to standardize the LPUEs. Longer fishing trips are more difficult to standardize in terms of effective fishing effort since they can include remote areas as away far as Sardinia and include night fishing.

4.3.4 Sicilian Channel

By Sicilian Channel, for the purpose of the current analysis, we define the area ranging between Tunisia, Lybia and Southern Sicily, including Malta.

In 1913 fishing experiments were carried out on fishing grounds off of Tripoli (Lybia) by two steam pair trawlers fishing in pair [215]. Thirty-three tows were performed over 14 days and an average of 360 kg/day and 152 kg/tow were obtained. However given the unknown grounds and the gear failure/entanglement in practically all fishing operations, the reported mean catches are very likely underestimated. HP of vessels Tripoli and Bengasi was not reported

FAO sponsored fishery exploration in the most important areas of Tunisia over the period 1957-1959 [216]. A total of 173 tows were performed with the trawler *Dauphin* (200 HP). Catch per hour is reported in the following bins: <30 kg/hour, 30-59,60-89, 90-119,120-150, >150 kg/hour. We used the mid point for the ranges, 30 for <30 and 150 for >150. In 17 tow catches were higher than 150 kg/hour but by an unknown amount. Traditional Tunisian trawlers up to 1960 exploited fishing ground shallower than 250 m, while the *Dauphin* mostly explored the fishing potential of unexploited grounds deeper than 250 m. In 1969 Italian trawlers from Mazara del Vallo normally did not exceed trawling depths of 300m [58].

Exploratory fishing for a total of 34 hauls was performed in 1965 in areas offshore Misurata and Tripoli in Libya [217].

120 tows were performed as commercial scouting exploration of fishing grounds in 1969 in the Gulf of Gabes (Tunisia) between 60-300m deep, and hourly catch rates have been reported [103]. The vessel, the Dauphin, had been used in prior fishing experiments.

Sara performed some fishing exploration on known grounds in NW Sicily as well as on the fishing grounds south of Pantelleria [58] for a total of 15 hauls in the summer months of 1967 and 1968.

In 1972 Bohulal [21] reported the landings and the effort of Tunisian trawlers in the ports of Bizerte, La Goulette, Sousse, Mahdia and Sfax spanning from 1946 to 1971.

In 1979, 76 exploratory tows were distributed on the most important fishing grounds around Tunisia and part of Libya [218].

Arena, during the period 1978-1979, performed commercial experimental trawling around Sicily for a total of 240 hauls and 488.5 hours of trawling [219]. The goal of the study was to estimate commercial yields as well as discard rates. The following parameters are reported by area: number of tows, tow duration, total catch, total commercial catch and discard (the latter 3 variables are reported by mean number of tows and standardized by fishing hour). The vessels used were the ESPI vessel *Centro Pesca 1* (22 tons and 230 HP) and some unidentified commercial vessels which generate a problem which HP and tonnage identification.

The most recent estimates of total commercial catch from Tunisia were collected by Gharbi in 1986 [220]. 53 hauls were performed on the major fishing grounds around Tunisia and a traditional Mediterranean net was operated along a GOV net.

4.3.5 Spain, Blanes

In the port of Blanes (Catalonia, Spain) detailed landing statistics from individual trawlers have been collected daily by boat for the historical period between 1956 and 1965, and for the modern period between 1997 and 2009. The data specifically distinguish approximately 130 species or species groups. In the decade 1956-1965 a group of 39 different trawlers operated, however never all at the same time. Vessels characteristics are reported for both periods and include year of construction, length, boat name, GRT, HP and type

of gear. For some boats there are missing parameters and incorrect years of construction. In addition, 400 HP has been the legal maximum for trawl vessels since 1989, therefore all registered vessels have subsequently under-declared their effective HP.

In Barcelona daily landings are available only for 1961 and 1962 during the historic period and for 1992-2009 in the modern period. The daily landings of individual trawlers were also recorded during the historic period, however due to the large number of simultaneous sales by different fishing captains, the observer could not record individual species except for Mediterranean hake, *Aristeus antennatus* and blue whiting. In most cases kg of catch sold and kg of catch unsold were reported, without a specification of the species composition. The same parameters have been recorded for vessel, with HP under-reported after 1989.

4.4 Change in fishing power

One of the main problems of assembling time series of LPUE data is the fact that each LPUE was collected with different sampling devices (the trawl nets) and under different population densities. These two factors and their interaction represent the greatest problem for robust relative abundance trend estimation. Often correcting factors that account, at least, for change of gear have been developed and adopted to correct the series [221, 222, 5]. In the case of the Mediterranean such fishery specific correcting factors have not been estimated before, with the exception of Kirkely et al. (2004) [223], unlike other areas such as the North Sea [221, 222, 5]. Table 4.1 (taken from Bishop 2006 [5]) summarizes the effects on catch rates of different technological improvements in the trawl fisheries.

As we are comparing time series from different periods spanning over approximately 200 years, assuming constant catchability would be wrong. From the literature it is apparent that the increase in fishing power has been large over much smaller time scales [5]. For example, according to Alverson (1959) the catch efficiency for some species of a synthetic net is between 1.5 to 4 times higher than a natural fiber net, at a worldwide level. Assuming this range of estimates holds in the Mediterranean, comparing catch rates from nets made with natural fibers to synthetic ones might underestimate relative fish abun-

dance, even after standardizing for vessel HP and/or tonnage. For instance in Chapter 1 it's been estimated that over 50 years with the move from natural fiber to nylon and to polyamide, improvements of 1.8 and 2.3, respectively, in trawl horizontal spread have been achieved. Assuming proportionality of catch to swept area, these estimates alone show an increased fishing capacity solely related to net material and rigging. All other factors that can improve fishing efficiency previously described, navigation equipment, deck operations, vessel speed, freezing capacity etc., are likely to add further fishing power.

Technology	Relative impact on catch rates	Fishery	Author(s)	Year of publication
Fleet composition (apart from tonnage effects)				
Steam and motor trawl versus sail	3.84	North Sea Bottom trawl	Garstang	1900
Innovation in fishing technology: harvesting power and catch efficiency				
Otter gear vs beam trawls	1.3	North Sea Bottom Trawl (steamer)	Garstang	1900
Synthetic nets vs vegetable fibers	1.54.0	Worldwide	Alverson	1959
Roller (bobbin) gear Charlotte:	1.16	Pacific ocean perch trawl fisheries	Kimura	1981
	Vancouver: 1.53			
Twin rig vs single	1.4 1.5	review Pacific cod Western Canada	Westrheim and Foucher	1985
Quad gear vs double	2	Gulf of Mexico shrimp fishery	Klima	1989
Innovation in fishing technology: searching power				
Paper recorders with acoustic fish-finding gear Charlotte:	no effect	Pacific ocean perch trawl fisheries	Kimura	1981
	Vancouver: 1.47			
GPS and plotters	1.14	Australia's Northern Prawn fishery	Robins et al.	1998

Table 4.1. Catch power coefficients redrawn after Bishop [5] and integrated with additional information.

4.4.1 Estimates of fishing power change

To date, in the literature there is only one study of change in fishing power of Mediterranean trawl vessels over a short period time, and none on the scale of centuries. In the

Sète trawl fishery (France) technical change enhanced productivity by approximately 1% per year between 1985 and 1999 [223]. We reconstructed the evolution of fishing effort over the past 300 years and have assembled trawler LPUEs from single sail trawlers from the 18th century, from pair sail trawlers in the 19th, and from steam and motor trawlers in the 20th. To be able to compare these relative abundance estimates in a realistic way we need to know the efficiency of one relative to another, and to do this we need to have trawlers with different technologies fishing at the same time in the same areas as was done by Engelhard [224] and Thurstan et al [221]. The key period is the 1920s when the first motorized vessels (steam and motor) displaced sail pair trawlers that 150 years before had outcompeted single sail trawlers from the northwestern Mediterranean (see Chapter 2).

Monconduit [208] reported catches from sail, steam and motor trawlers fishing in the Gulf of Tunis and off Hammamet in Tunisia in the period 1923-1926. Yearly catch rates were given for one steam trawler and 1 boat of a pair sail trawler for 1924 to 1926 aggregated over the two Gulfs under investigation. Additionally, the catch rate of pair sail trawlers and pair sail trawlers equipped with auxiliary engines was provided separately for the Gulfs in 1926. Fleet composition was also outlined but with aggregated tonnage estimates: 8 steam trawlers fishing in the Gulf of Tunis averaging 37 tons, 1 steam trawler in the Gulf of Hammamet of 27 tons, 11 pair sail trawlers and 16 more with auxiliary engines displacing on average 22.4 tons per boat (a pair is the double). All pair trawlers were similar in terms of construction. Data are reported in different aggregation levels and never by individual vessel, therefore only an approximate fishing estimate could be derived. Following methods adopted by Garstang [222] and Engelhard [224] we calculated the ratio of a steam and motorized pair sail trawler to a pair sail trawler using the total catch of a pair of sail trawlers for reference. The ratio of steam trawler to sail, calculated for the aggregated Hammamet and Tunis Gulfs, is 1.43, 1.54 and 1.21 for the years 1924, 1925 and 1926, respectively. The overall tonnage of the different types of trawlers is comparable. The catching power ratio between pair sail trawlers with engines and pair sail trawlers calculated in only 1926 is 1.35 in the Gulf of Tunis and 1.52 in Gulf Hammamet. The latter Gulf had overall higher yields as trawling started much later than in the Tunis Gulf. How-

ever, this estimate might be biased by the fact that few steam trawlers were fishing on the more productive fishing grounds.

Ermirio [6] reported catch rates of individual trawlers fishing in 1926 on a bank SW of Lampedusa Island in the Sicilian Channel, less than 50 miles from the Gulf of Hammamet in Tunisia. During one summer, an Italian steam, a sail and a motor trawler each operated there (Table 4.12). The LPUE (kg/number fishing days) of each vessel was compared fitting a Generalized Linear Model (GLM) [157] where kg per fishing day is modeled as a function of vessel type and tonnage using a Gaussian family (Table 4.4.1). The model is used to predict the catch rates for a standardized trawler of 90 tons for each vessel type and the predicted LPUEs are used to build catching power rates (Figure 4-10). Results show that a motor trawler catches 3.9 times more than a pair sail trawler with an auxiliary engine and 2.53 times more than a steam trawler. A steam trawler catches 1.55 times more than a pair sail trawler with an auxiliary engine.

	Estimate	Std. Error	t value	Pr(> t)
(Intercept)	5164.1077	973.9097	5.30	0.0007
pairsail_motor trawler	-4716.8011	1142.2272	-4.13	0.0033
steam trawler	-3827.9036	763.9857	-5.01	0.0010
vessel tons	12.9914	7.3232	1.77	0.1140

Table 4.2. GLM model summary of the cpue estimated around Lampedusa Island in the summer of 1926 by Ermirio [6]. Reference vessels are a motor trawler, paranzamotore=pair trawler with sails and engine, piropeschereccio=steam trawler, stazza_netta=vessel tonnage

In 1972 Bohulal [21] reported the landings and effort of Tunisian trawlers in the ports of Bizerte, La Goulette, Sousse, Mahdia and Sfax spanning from 1946 to 1971 (Figure 4-11). Trawl fleets in these areas were composed of older locally or foreign built trawlers averaging between 150 and 200 HP. In most areas new trawlers with echo-sounders and radio and HP greater than 250 entered the fleet in 1967. The data reported allow construction of an LPUE index of tons caught per fishing trip, after adjusting for trip duration, for the entire fleet in each of the five areas. Assuming that the stocks remained constant, which is reasonable given the low overall fishing effort at the time, we compared catch rates in the

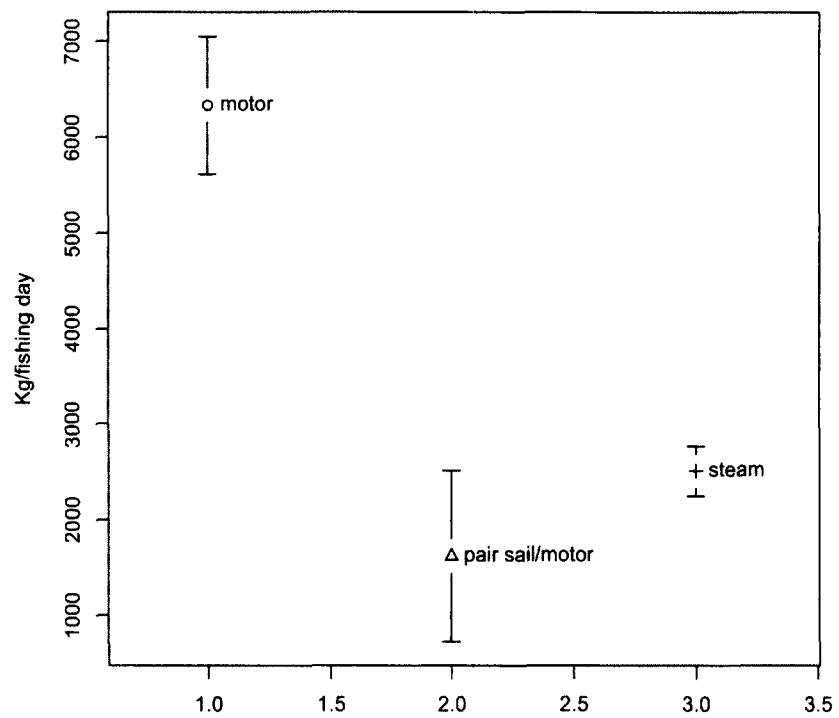

Figure 4-10. Standardized cpue for a pair sail-motor trawler, a steam trawler and a motor trawler fishing SW of Lampedusa Island in the summer of 1926 from Ermirio

different areas categorizing all trawlers as old until 1967, and those after that year as new. We fitted a linear mixed model with the dummy variable (old, new) and port as a random intercept to estimate the catch rate of new trawlers versus old ones. It has to be clarified that several new vessels entered the fishery in each area, however due to data aggregation, the new category incorporated older trawlers that fished after 1967. This implies that our fishing power results underestimate the real increase in fishing power. Over all the different areas, new trawlers have a 50% higher catch rate than older ones on average (Figure 4-12)

The estimates of catching power differences between pair sail, pair sail motor trawlers and steam trawlers derived from Tunisia in 1926 are consistent with the estimates reported in Engelhard [224]. This suggests that results are consistent between Tunisia and the North Sea we can likely use these coefficients across the western Mediterranean to correct LPUE data from identified types of vessels. The estimates derived from Bouhaul, while they show an increase in fishing power, are certainly undervalued, but to date they are the only ones that could be derived.

The fishing power estimates derived here are based on very small datasets and while the estimates should be accurate, more validation is needed before they can be used at correcting factors for change in fishing power in LPUE standardization.

4.5 Analysis of commercial LPUE by sub-areas

The goal of collecting historical and current LPUE data from demersal trawlers is to estimate relative trends in abundance in demersal fish stocks. Beyond the problem of change in fishing power, it should be clear from the historical data description that all LPUEs prior to 1950 consist of aggregated catch over an unknown number of species with commercial value, with few exceptions. Modern data in most cases are given by individual commercial species. This constitutes the first main limitation on the resolution of the available data. The only way of making use of the historical data is to reduce the species resolution of modern data by aggregation to total catch. A second important feature in LPUE data consists of a second aggregation level difference. In the old data, especially those collected by

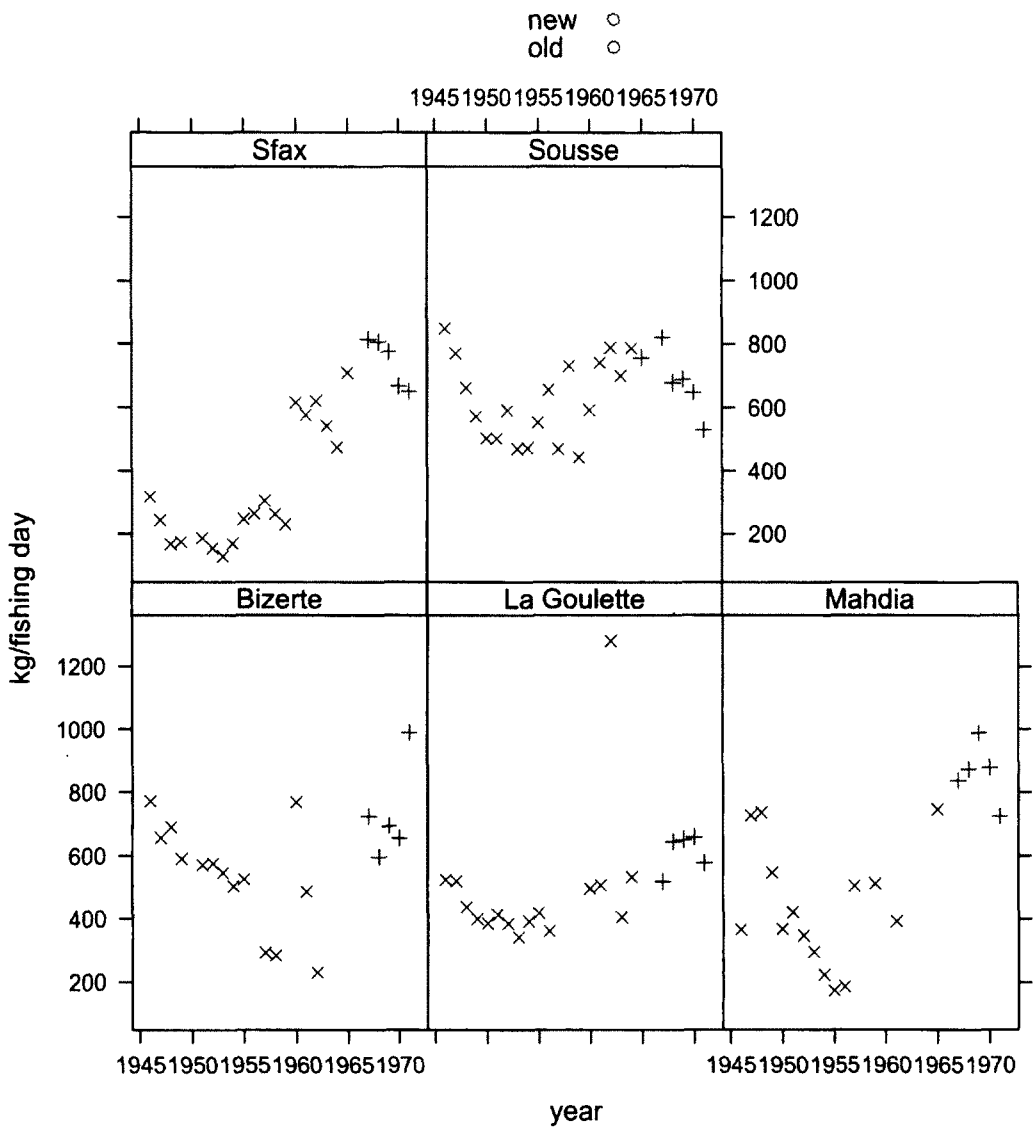

Figure 4-11. LPUE estimates for Tunisian trawlers fishing in different areas between 1946 and 1971, from Bohulal (1972) [21].

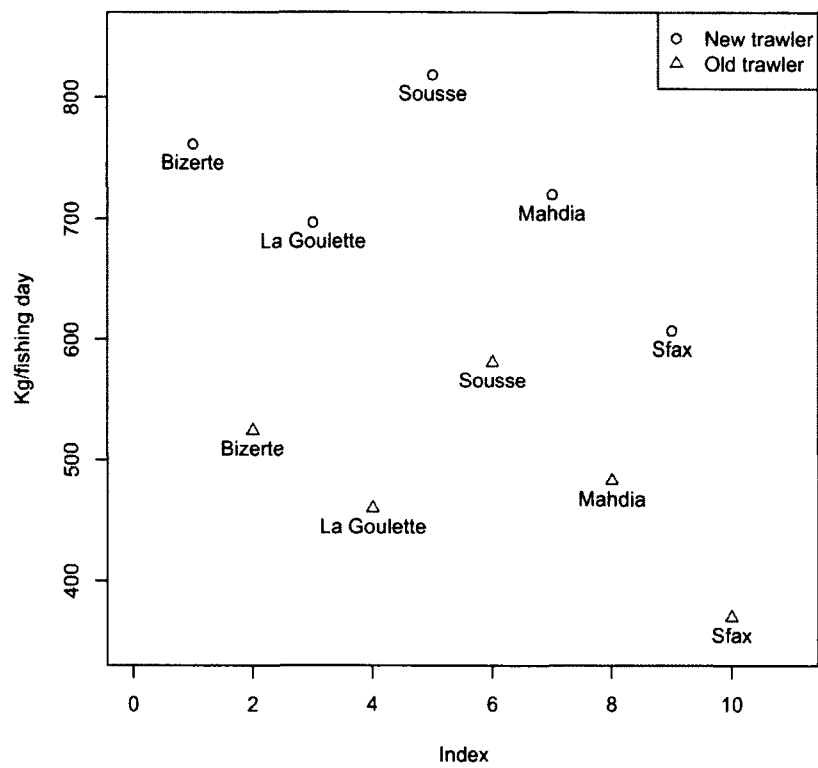

Figure 4-12. Standardized catching power of modern vs old type of trawlers fishing in Tunisia over the period 1964-1971.

Doumenge [8], LPUE is averaged across multiple vessels and multiple fishing days while in modern series data are disaggregated to the level of single fishing day and individual fishing vessel.

Therefore a first set of analyses will focus on modeling trends in total aggregated catch at different spatial scales. First, time series of LPUE data are modeled, either by area or by the largest and most consistent datasets in each area, to understand individual data features. Second, all data are aggregated and analyzed to estimate a general trend in total catch from trawlers in the western Mediterranean. The main goal is estimating an unbiased trend in mean LPUE for total demersal catch with commercial value, taking into account the effects of change in vessel engine size (HP), type of trawler, area, country and seasonal effects where possible. A second part, in Chapter 4, will explore post 1950 data with the aim of reconstructing trends at the individual species level.

An important aspect of these analyses is the lack of the exact position of fishing operations from which we model the LPUEs. These are never reported in the Mediterranean Sea, historically or today. This is an important limitation, but there is no means of overcoming it. For example, it's impossible to assess exactly when new fishing grounds started being exploited, a fact that certainly occurred in several areas around the end of the 1950s, as Massuti [225] documented precisely in the Balearic Islands (Spain), or in Maurins [226] accounts of grounds still unfished in the 1950s, but fished in later years.

4.5.1 Data description and preparation

The analysis used all the sources available, which are described in the prior section and summarized by source, total number of fishing days and area in Table 4.3 and Figure 4-13. Due to the high heterogeneity of LPUE types and of different levels of data aggregation, several criteria for standardizing the data have been established.

1. If both catch and number of fishing days are given in the original reference, LPUE (kg/fishing days) is calculated by dividing total catch by number of fishing days.

2. If trawler HP is reported for individual vessels and if aggregated HP is given for multiple vessels, the mean HP is calculated by dividing total HP by the number of vessels. For missing HP, the mean value for similar years in the same or neighboring areas is assigned.
3. For a sail powered vessel HP is assumed to be 40 as explained in Chapter 2. Based on available references, a pair motor trawler is assumed to have 60 HP and a steam trawler, 100 HP.
4. When the number of fishing days of a yearly LPUE is not reported, in the case of sail powered vessels we assign a value of 20 fishing days per month. This value is only used for estimating weights and not for converting kg/year into kg/fishing day.
5. Since 1975 the appearance of high vertical opening (GOV) nets (see Chapter 2) has lead to much higher catches of pelagic species along with mixed metiers including mid-water trawling (specifically in the French case). Since this could cause major bias, it was decided to remove fishing trips with the pelagic catches above a threshold of 100 kg/fishing day for individual species.
6. Areas appearing only one or two times generates estimation problems when using area as a random effect. In those cases data were pooled to a higher aggregation.

In standardization of the data described above, some parts were particularly critical. Two important data sanitization steps were performed prior to model fitting:

1. Define total demersal biomass and address the issue of large pelagic catches with GOV and traditional opening nets.
2. Aggregate all commercial species landed by summation by boat and fishing trip

To elaborate, the variable modeled, *kg_day*, is total catch from the daily fishing trips of demersal trawlers, therefore the objective is to estimate the relative trend in biomass of all demersal species with commercial value which are landed. Since 1975 small pelagics have been increasingly caught due to the introduction of high vertical opening nets and the

development of mid water trawling [223]. Therefore a standardization method was implemented to avoid the risk of including large catches of pelagic species. Since large pelagic catches could cause major bias it was decided to remove fishing trips with pelagic catches above a threshold of 100 kg/fishing day of individual species. The species filtered were sardine, anchovies and horse mackerel. This was only possible when data were disaggregated, thus it was applied to series from Blanes, Sete, Port Vendres, Porto Santo Stefano and Castiglione della Pescaia. For details see the French case study. This was particularly important in the case of the modern data from the two French ports since in the datasets (and in the fleet), several trawlers having mixed licenses and fishing both demersal and small pelagics. More details are provided in the French analysis section.

After removing fishing trips with high pelagic catches, LPUE from the demersal trips was generated by adding the cumulative weight of all species caught per trip and vessel. Pelagic catches of less than 100 kg/day are still retained. When aggregated catches were recorded, as in the case of Doumenge, LPUE was derived by dividing total catch by the total number of fishing days. In this case it was not possible to remove large pelagic catches, however when the 100 kg/day threshold was applied to old data (Blanes and Sete) practically no fishing trip exceeded the threshold. Therefore we are confident that retaining all historical aggregated LPUEs is robust.

4.5.2 Modelling

Regression models were fit to each area first (Spain, France, Tuscan Archipelago, Sicilian Channel and Adriatic) and then all data were analyzed together but separated for the different LPUEs: tot catch/day and total catch/hour. The choice of using separate LPUE units is contingent on the fact that a conversion from one to the other would be arbitrary since the exact number of fishing hours in one fishing day can vary, and are not clearly identified over time. Given the data came from different areas of the western Mediterranean with very discontinuous time steps and substantial unbalance, it was decided to use generalized additive mixed model effects (GAMM) to account for replication within area and within vessel, nonlinearities and unbalance. In the literature there is good sup-

Country	Source	N. Fishing days	year
ITA	[7]	5000	1779
ES	[17]	72862	1792
ES	[110]	200	1868
ITA	[16]	3	1910
JUGO	[16]	2	1910
ITA	[77]	3	1916
TUNI	[208]	896	1923
ITA	[6]	232	1926
ITA	[81]	600	1926
LIB	[55]	3	1927
SCHAN	[55]	3	1927
ITA	[55]	3	1930
ITA	[118]	2	1932
JUGO	[18]	3687	1932
ITA	[181]	1200	1935
JUGO	[210]		1938
JUGO	[210]		1938
ITA	[8]	21549	1939
ES	[209]	930	1944
ES	[8]	55556	1944
JUGO	[210]		1947
FR	[8]	3874	1951
FR	IFREMER	89752	1951
JUGO	[19]	2105	1951
ES	[57]	62840	1956
JUGO	[211]	4798	1959
JUGO	[126]	6286	1960
JUGO	[20]	9	1960
JUGO	[126]	99150	1961
ITA	edda.tallybook	107	1962
TUNI	[21]	55145	1967
ITA	[227]	22	1972
JUGO	[213]	4	1972
ITA	[101]	2	1976
LIB	[101]	3	1976
SCHAN	[101]	5	1976
LIB	[228]	6	1983
SCHAN	[228]	16	1983
ITA	[214]	12857	1991
ITA	CIBM	151	2003
ITA	[229]	34	2004
ITA	[131]	11	2009

Table 4.3. Summary table of data sources by country and year used in analyzing total commercial LPUE in the NW Mediterranean 1800-2009.

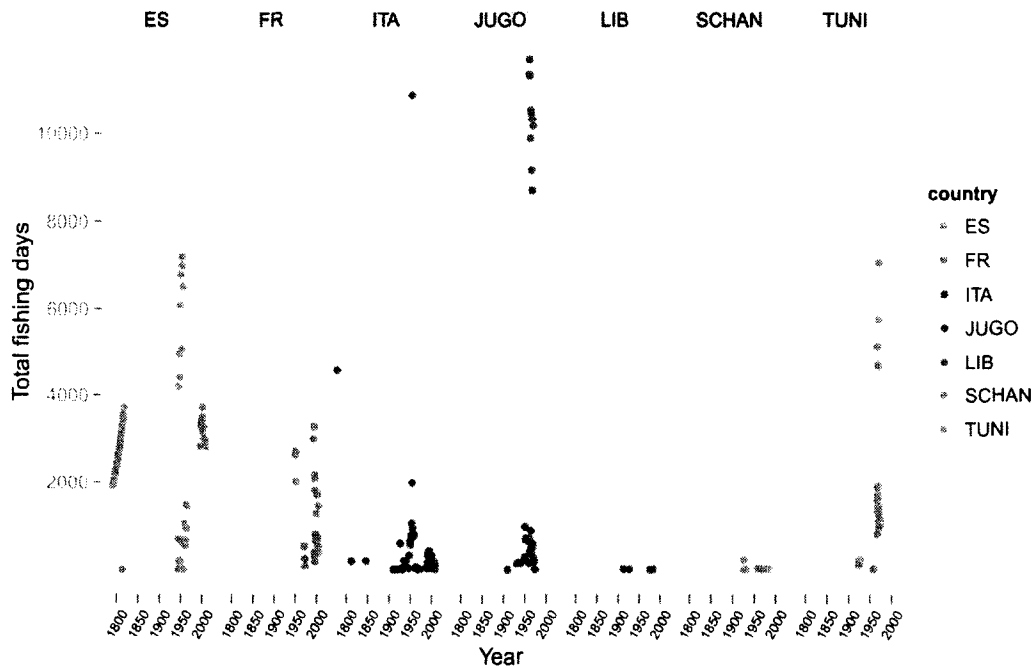

Figure 4-13. Summary of the Total number of fishing days retained for analyzing the LPUE (Tot demersal catch/fishing day) in the NW Mediterranean 1800-2009.

port for the use of this type of model for LPUE standardization [230, 231]. Additionally, to account for the different levels of LPUE aggregation (individual vessels fishing days or multiple vessels and days), it is essential to be able to weight the LPUE variance with the number of fishing days. The logic is that a mean LPUE estimate over 100 fishing days should have more weight than one from 1 fishing day, and this should correctly enter in the model uncertainty. Therefore, how the weighting function and the offset parameter worked were fundamental choosing an appropriate package to perform GAMMs.

In the models the inverse of the number of fishing days is used as a weight, this is essential to correctly accommodate LPUEs from most historical data prior to 1950 and Tunisian data in the 1960s. Figure 4-36 shows the level of aggregation present in the fishing day variable and justifies the need of this modeling decision.

The first choice for modeling environment was the R package *gamm4* [160] but this package could not handle the size of the datasets and does not allow the use of an offset. An alternative choice *mgcv* [160] was using the function *bam* (as indicated by S. Wood) as

it allows specification of random term smoothers, specification of weights, offset and it can handle large datasets while still providing good estimates when there are few random effects levels . We therefore used *bam* for all analyses although this package is not very well documented and few work around had to be implemented.

Change in fishing power is an issue of primary importance when analyzing time series of LPUEs longer than few years. In Chapter 1 we dealt with reconstructing technological improvement on Mediterranean trawl vessels and derived estimates of improvement in trawl wing opening (which, following Sommertons notation in Chapter 1, corresponds to A_1) with types of netting material and rigging. Since A_1 is correlated with time, estimates of wingspread were used in the regression models to further standardize LPUEs. Therefore the estimated values of wingspread A_1 were used as an offset parameter, which represents the increase in trawl wing opening according to different net materials and rigging in different periods. A_1 was estimated to be $A_1 = 1$ over the period 1920-1960 (meaning that we consider catching power constant), $A_1 = 1.72$ from 1960-1980 and $A_1 = 2.24$ from 1980-2009. In all models, the $\log(A_1)$ was used as an offset parameter, meaning that LPUE is assumed proportional to A_1 . If we compare the values of A_1 with a scenario of theoretical constant yearly fishing power increase, from 0 to 2 % per year, we can see that a hypothetical A_1 scenario, albeit implemented as a step function, would be comparable to a yearly increase of fishing power of 1% per year over a span of 90 years Figure 4-14. Fishing power scenarios ranging from 0 to 2% have not been implemented but only the A_1 scenario was used. Since it is in the same range of FP 1% we will use interchangeably the terms fishing power and increased efficiency of the net in terms of swept area.

The choice of predictor variables, in both individual and combined areas, was dictated by the goal of using the minimum subset of covariates that would allow inclusion of the oldest LPUEs in the models. This choice sacrificed explanatory power (by dropping some covariates for which there is no information in the historic data) in favor of extending temporal span. Individual area models with more suitable covariates are expected to have more explanatory power and be more robust, while the combined area model will have the best temporal resolution despite a standardization based mainly on HP and trawler type.

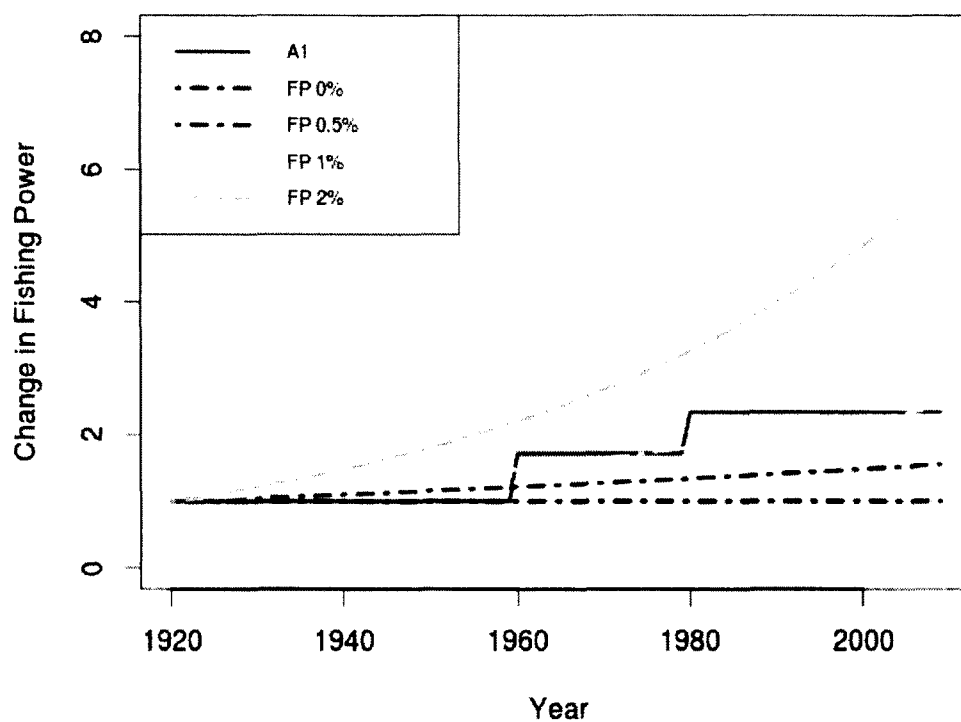

Figure 4-14. Set of scenarios simulating change in fishing power (FP) according to an increase of 0, 0.5, 1 and 2 % per year and the A_1 scenarios corresponding to the estimated increase in otter trawl wing spread switching from hemp, to nylon and polyester material over time, for detail see Chapter 1.

Early model trials and variance to mean tests showed increasing mean/variance relationship. Log transformation was thus necessary and applied in all models [232]. All models were fitted with a Gaussian family distribution.

Model selection followed these steps: start with the full model, test which random effects could be dropped, update, test which smoothers could be dropped, update, test which parametric interactions and then variables could be dropped [232]. Deciding which terms to include in the model is based on a comparison of the GCV/UBRE/ML scores for models with and without the terms of interest [161]. In our case we used ML estimation for model comparison. Comparisons via GCV score and via AIC normally yield similar answers [160] and AIC was used. P-values for dropping fixed terms were not used since in these models p-values are approximate and not entirely reliable [160]. Another important parameter for GAMMs is the choice of basis dimensions (k) of the smooths when penalized regression smoothers are used [161]. Wood argues that the exact choice is generally not critical but that k should be checked to ensure that it has enough degrees of freedom to represent the underlying truth in the data reasonably well, but at the same time is small enough to maintain computational efficiency [160]. In these analysis the basis dimensions of the smooths were tested by using different sets of k s and verifying the these did not introduce statistically important changes, and also by visual inspection of residual patterns [160].

Once the best model was identified, parameters were estimated using REML since it gives better parameter estimates [161, 232].

4.5.3 By Country models

4.5.3.1 France

One case study was built using LPUE data from Mediterranean France over the period 1951-2004. Data from the fishing ports of Port Vendres and Sète were used. There is unbalance in the data as the oldest information is from Port Vendres only (1951-1953) [8], intermediate data for Sète are available for 1971-1973, and LPUE is available for both ports from 1994-1999 and 2002-2004. LPUE from Port Vendres in 1982-84 could not be used as it focused only on four species and would be biased for a total demersal biomass estimate.

The main issue for analysis is the comparison of low vertical opening traditional otter trawl nets operating from 1951 to 1973 with a large portion of high vertical opening (GOV) nets in the modern series and vessels fishing under the license "polyvalent demersal metier" (type C). Unfortunately, no covariate specifies modern trawler type in detail or the metier of each fishing trip. The main effect is that GOV nets are used for bottom as well as for semi-pelagic trawling and consequently have much higher catches of pelagic and semi-pelagic fish, as explained in Chapter 2, and [3]. Total kg per fishing days is the response variable being modeled and it is at risk of high confounding due to potential change in fishing tactics when the fleet switches between demersal and pelagic targeting. Including large pelagic catches in the analysis can undermine the analysis of total catch of demersal species.

The 1950s data [8] show some catch of pelagic species, and also data from the 1970s. This was verifiable since the data are originally disaggregated by species or groups of species. To investigate catch composition for each period (1951-53, 1971-73, 1995-97 and 2001-04) the percentage composition of the cumulative LPUEs was calculated (Figure 4-15). Some pelagic species have been caught in all periods, however with major differences: in the 1950s the percentage catch was, respectively, 2.81% *Scomber* sp. , 0.94% *Trachurus trachurus* and 0.58% *Sardina pilchardus*. In the early 1970s, before the advent of GOV nets, LPUEs of small pelagics were similar in proportion to the 1950s: 7.73% *Scomber* sp. , 6.02% *Trachurus trachurus*, 3.58% *Sardina pilchardus* and 0.36% *Engraulis encrasicolus*. Since the 1990s a major shift in the catch composition of trawlers from Sète and Port Vendres

has taken place: 6.34% *Scomber scombrus* sp. , 3.25% *Trachurus trachurus*, 22.34 % *Sardina pilchardus* and 25.57% *Engraulis encrasicolus*. Catch composition in the 2000s is similar to prior decade with LPUEs of 4.8% *Scomber scombrus* sp. , 2.26% *Trachurus trachurus*, 27.15 % *Sardina pilchardus* and 20.96% *Engraulis encrasicolus*.

The predominant increase in small pelagic catches mainly pertains to sardines (*Sardina pilchardus*) which increased from 0.58% to 27.15 % and anchovies (*Engraulis encrasicolus*) which went from 0.36% to 20.96%. These increases are in relative percentages, thus comparing total catch from the early period with the recent can be biased if the catches of small pelagics are very large in the latter period. This shows the importance of filtering out a relevant part of fishing trips with large catches of small pelagics.

To try to address this potential confounding from pelagic species in the modern series we identified fishing trips that had high catch rates of small pelagics (greater than 100 kg per trip) and removed them. This correctly accounts for true targeting of demersal species. Such an approach has the same aim of a full PCA analysis implemented to identify specific targeting (Chapter 4), but is implemented in a simpler way since the goal is only to remove vessels that were midwater trawling.

To explore the effect of filtering out trips with catches of more than 100 kg of individual small pelagics, the percentage composition was recalculated on the same data after filtering (Figure 4-16). In the filtered data, catch composition is now comparable with the historical series since sardines and anchovies have a catch share of less than 0.4% which was used as level for plotting. Horse mackerels (*Scomber scombrus* sp.) retained a level between 5-8 % which is in the same range of the 1950s. Fundamentally, sardines and anchovies make up the bulk of pelagic trawling, with predominantly large catches on the order of tonnes per day. This is confirmed since a 100 kg filter causes them to virtually disappear from the catches. Even if the filtering threshold were lower than 100 kg, pelagic fishing trips would have been detected and removed.

We estimated total catch per day after removing all catch records from fishing trips that meet the pelagic catch criterion of above 100 kg/day of *Trachurus trachurus*, *Scomber scombrus*, *Engraulis encrasicolus* and *Sardina pilchardus*., With the exception of data from

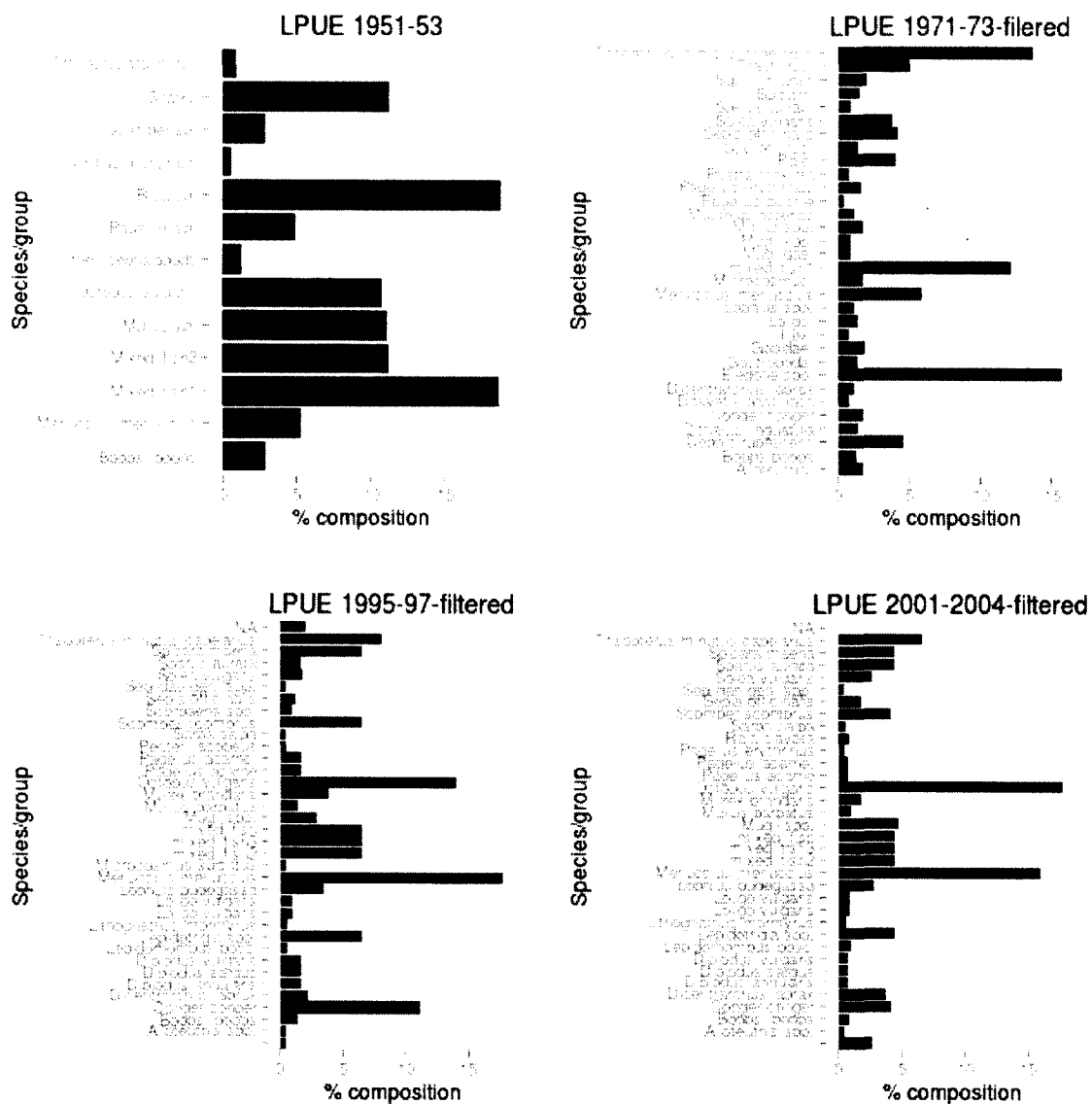

Figure 4-16. Percentage composition of combined LPUE from trawlers in different periods after removal trips exceeding pelagic catches of 100 kg/day of individual species for *Trachurus trachurus*, *Scomber scombrus*, *Engraulis encrasicolus* and *Sardina pilchardus*, Gulf of Lions (France). Since more than 30 species make up the LPUEs, only those contributing more than 0.4% were plotted.

the 1950s and 1970s, several hundred fishing trips were removed from all series based on this filtering criterion.

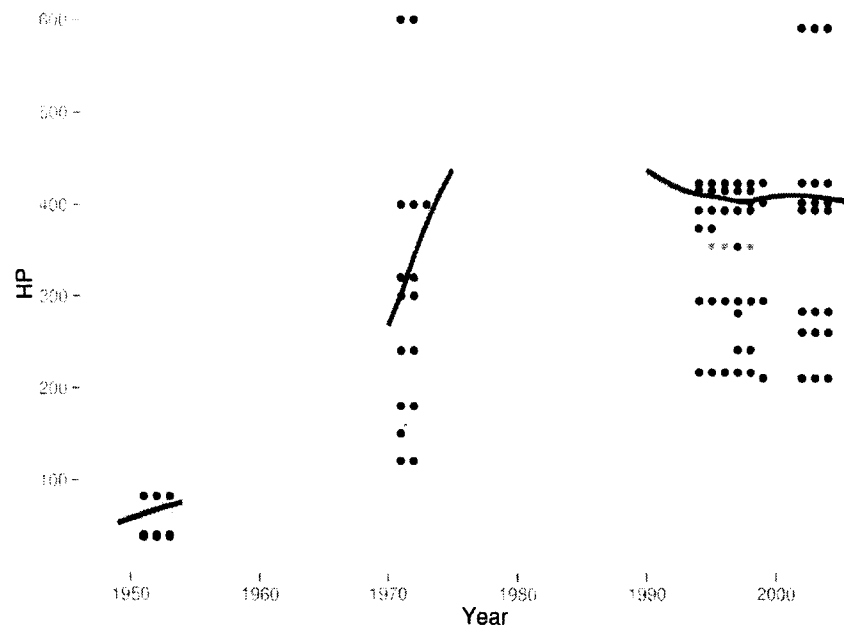

Figure 4-17. HP growth over time in Port Vendres (PV) and Sete (ST) plus smoothers in the Gulf of Lions (France).

Total catch per day (kg/fishing day) was modeled as a function of a smooth of year and HP with a random effect for vessel id; fishing port was modeled as a fixed effect since only two ports were modeled. The inverse of number of fishing days was used as a prior weighting factor. Generalized additive mixed models were used with the *bam* function (GAMs for large datasets) in R Core, version 1.15.0 package *MGCV 1.7-11*.

A dummy variable *dumn* was introduced to identify trawlers with improved fishing efficiency over time according to the following classification: prior to 1960 (level A), between 1960 and 1980 (level B), after 1980 (level C). This dummy variable was used as an interaction with the covariate HP, to allow HP to vary over periods of time, since in the most recent period engine HP is known to be under-declared and constant at the legal limit (316 kw) (Figure 4-17). A second dummy variable (a vector of 1s) (*dum1*) was added to allow for group-wide prediction in the *bam* function (<http://www.mail-archive.com/r->

help@r-project.org/msg139013.html), although in the current models no predictions were produced. The change in wing spread (A_1) was modeled as an offset parameter in *log* scale since the LPUE was *log* transformed.

Data used for the analysis are plotted in Figure 4-18 and are representative of the LPUE after the removal of pelagic trips. In total 13502 fishing trips were retained.

The list of fitted models used as covariates: Year, Month, HP, Area, Dumn, A_1 , vessel and, as weights, the inverse of the number of fishing days, is reported below in R code.

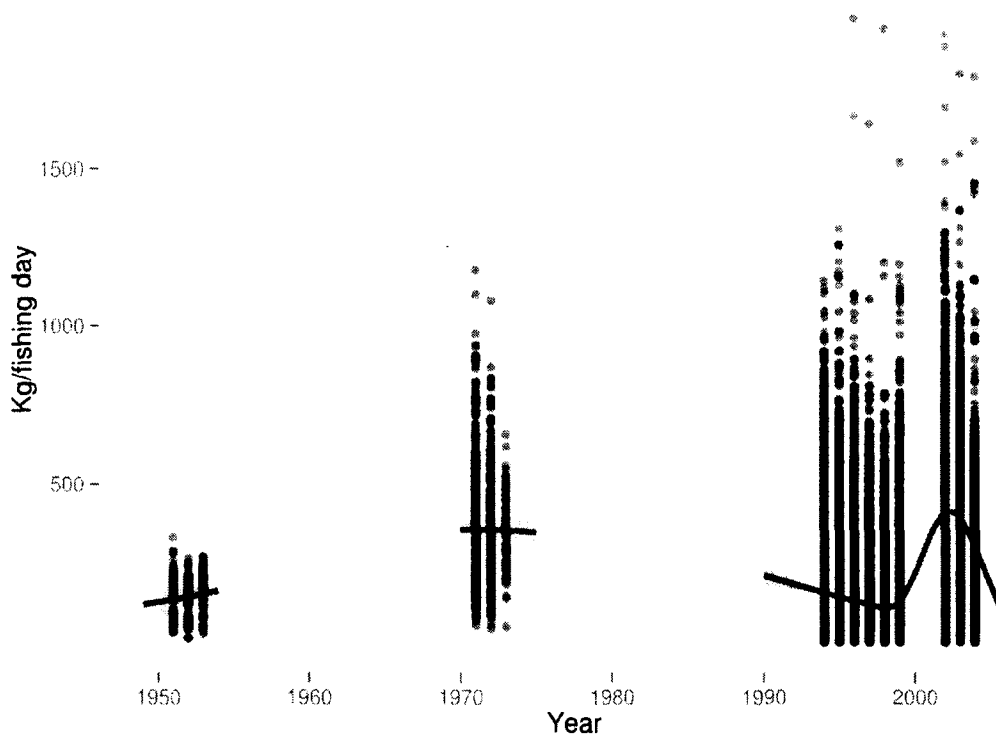

Figure 4-18. Daily LPUE (Kg/fishing day) for the ports of Sete and Port Vendres in the Gulf of Lions (France) fitted with a simple smoother.

```
k=15; l=7; m=8
fr.gamm1q<-bam(log(kg_day) ~ s(year, k=k)+ s(HP, k=l)+s(month, k=m)+area+dumn+offset(log(A1))+s(vessel, bs="re", by=dum1), weights=1/fishing_day, data=france4, family=gaussian, method="ML")
fr.gamm2q<-bam(log(kg_day) ~ s(year, k=k)+ s(HP, by=dumn, k=l)+s(month, k=m)+area+dumn+offset(log(A1))+s(vessel, bs="re", by=dum1), weights=1/fishing_day, data=france4, family=gaussian, method="ML")
fr.gamm3q<-bam(log(kg_day) ~ s(year, k=k)+ s(HP, by=dumn, k=l)+s(month, k=m)+area+offset(log(A1))+s(vessel, bs="re", by=dum1), weights=1/fishing_day, data=france4, family=gaussian, method="ML")
```

```

fr.gamm4q<-bam(log(kg.day) ~ s(year, k=k)+ s(HP, by=dumn, k=1)+s(month,k=m)+area+dumn+
  offset(log(A1))+s(vessel, bs="re", by=dum1), weights=1/fishing.day, data=france4,
  family=gaussian, na.action=na.omit, method="ML")
fr.gamm5q<-bam(log(kg.day) ~ s(year, k=k)+ s(HP, by=dumn, k=1)+s(month,k=m)+area+offset(
  log(A1))+s(vessel, bs="re", by=dum1),weights=1/fishing.day, data=france4, family=
  gaussian, method="ML")
fr.gamm53q<-bam(log(kg.day) ~ s(year, k=k)+ s(HP, k=1)+s(month,k=m)+area+offset(log(A1))+s
  (vessel, bs="re", by=dum1),weights=1/fishing.day, data=france4, family=gaussian,
  method="ML")
fr.gamm6q<-bam(log(kg.day) ~ s(year, k=k)+s(HP,by=dumn, k=1)+month+area+offset(log(A1))+s(
  vessel,dum1, bs="re"), weights=1/fishing.day, data=france4, family=gaussian, method="
  ML")
fr.gamm7q<-bam(log(kg.day) ~ s(year, k=k)+s(HP,by=dumn, k=1)+area+offset(log(A1))+s(vessel
  ,dum1, bs="re"), weights=1/fishing.day, data=france4, family=gaussian, method="ML")
fr.gamm8q<-bam(log(kg.day) ~ s(year, k=k)+s(HP,by=dumn, k=1)+s(month,k=m)+offset(log(A1))+
  s(vessel,dum1, bs="re"), weights=1/fishing.day, data=france4, family=gaussian, method
  ="ML")

```

The best model, by AIC criterion is *fr.gamm53q* as reported in Table 4.4

Model	df	AIC
fr.gamm1q	121.41	27916.82
fr.gamm2q	116.90	27954.18
fr.gamm3q	120.30	27921.86
fr.gamm4q	116.90	27954.18
fr.gamm5q	120.30	27921.86
fr.gamm53q	120.98	27915.99
fr.gamm6q	116.48	28063.72
fr.gamm7q	115.54	28065.43
fr.gamm8q	120.90	27965.74

Table 4.4. AIC of different random effects models for Total Catch/Fishing Day in the Gulf of Lions (France)

Model summary for model *fr.gamm53qrem1* shows a Deviance explained of 44.5%; model diagnostics don't show violation of heterogeneity. The deviance residuals vs. theoretical quantiles despite a heavy tail are acceptable, the residuals histogram is reasonably normal (Figure 4-20) and the random term QQ plot is acceptable (bottom right panel, Figure 4-19).

Formula:
 $\log(\text{kg.day}) \sim s(\text{year}, k = k) + s(\text{HP}, k = 1) + s(\text{month}, k = m) + \text{area} + \text{offset}(\log(A1)) + s(\text{vessel}, \text{bs} = \text{"re"}, \text{by} = \text{dum1})$

Parametric coefficients:

	Estimate	Std. Error	t value	Pr(> t)
(Intercept)	4.33388	0.06797	63.763	< 2e-16 ***
areaST	0.40173	0.05161	7.784	7.53e-15 ***

Signif. codes: 0 '***' 0.001 '**' 0.01 '*' 0.05 '.' 0.1

Approximate significance of smooth terms:

	edf	Ref. df	F	p-value
s(year)	9.546	10.914	47.54	< 2e-16 ***
s(HP)	2.179	2.259	17.39	4.8e-09 ***
s(month)	6.029	6.682	25.08	< 2e-16 ***
s(vessel):dum1	100.589	104.000	77.41	< 2e-16 ***

Signif. codes:	0	***	0.001	**	0.01	*	0.05	.	0.1	1
----------------	---	-----	-------	----	------	---	------	---	-----	---

R-sq.(adj) =	0.66	Deviance explained =	44.4%
REML score =	13816	Scale est. =	0.43628
		n =	13502

The fitted model year effect (top left panel in Figure 4-19) shows the smoother for year with over plotted residuals on log scale. The decline in LPUE has been almost continuous from the 1950s to mid 1990s and there seems to be a slight increase in the most recent years. Since year smoother is on log scale, the drop of the standardized LPUE is approximately seven fold. Lack of intermediate data leaves several periods uncovered, but the overall model explains a relatively good part of the deviance despite not having many explanatory covariates.

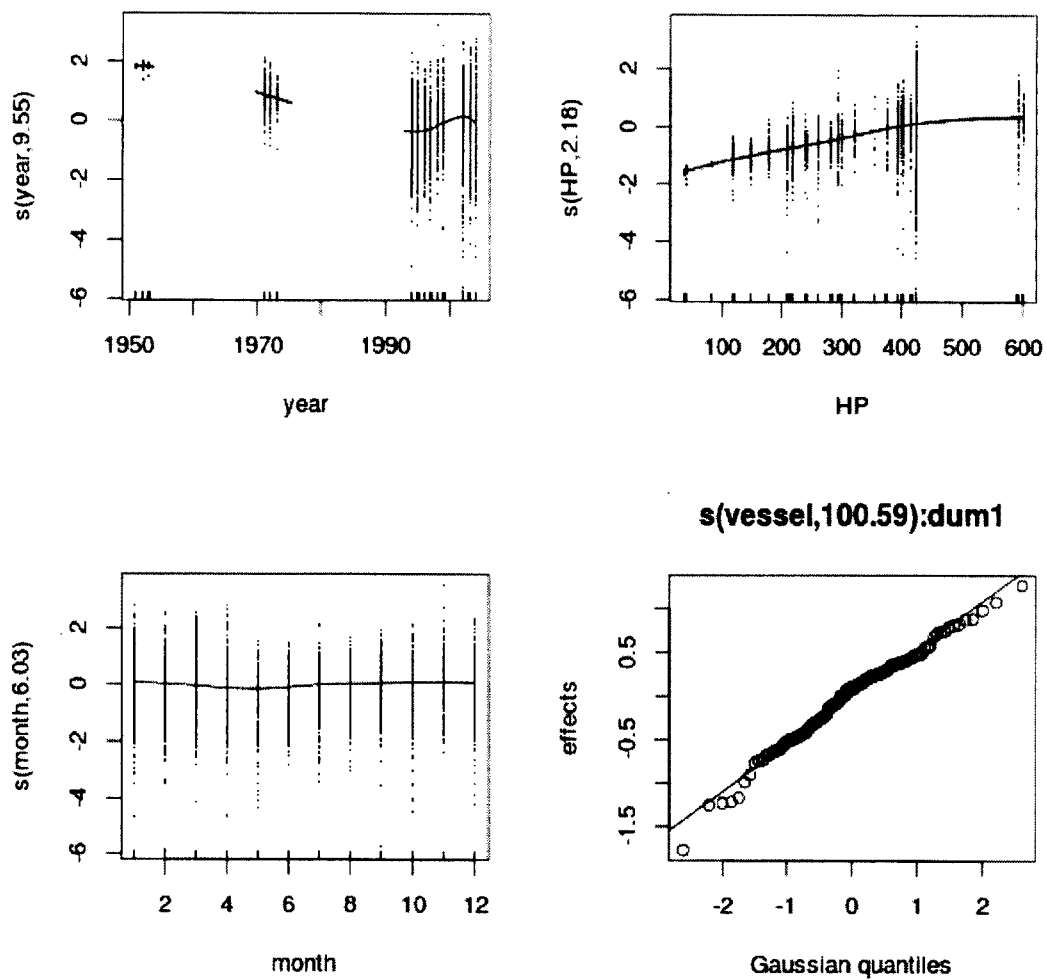

Figure 4-19. Estimated smoothing curves and random effects from the best GAMM for total catch/fishing day in the Gulf of Lions (France), with 95% Confidence Intervals

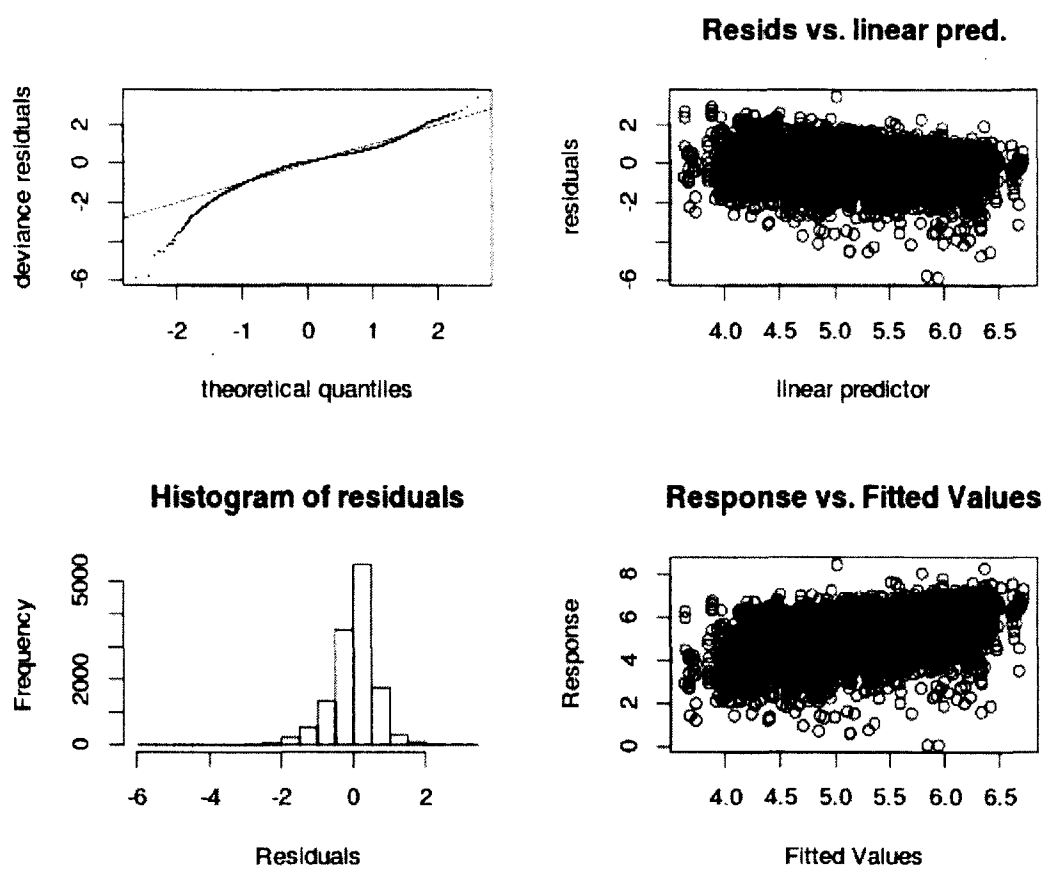

Figure 4-20. Model diagnostics for total catch/fishing day best model for the Gulf of Lions (France)

4.5.3.2 Catalonia

The same approach as in the French case was adopted for modeling the time series of the port of Blanes (Catalonia, Spain). The data cover two main periods, as described in prior sections, and data with a fitted smoother are plotted in Figure 4-21. Figure 4-22 shows the evolution in trawler engine power (HP) over the two periods with available data. The set of models tested is below, model selection was performed using maximum likelihood (ML) and parameter estimates were obtained using restricted maximum likelihood (REML). The covariates used in this area, slightly different from those in the French case, are the following: Year, HP, Month, Day, GRT (Gross Registered Tonnage), material (Vessel Material) and year.constr (Year of Construction of the vessel). Since all data was reported on the basis of 1 fishing day, weights were not used. A_1 was modeled as an offset.

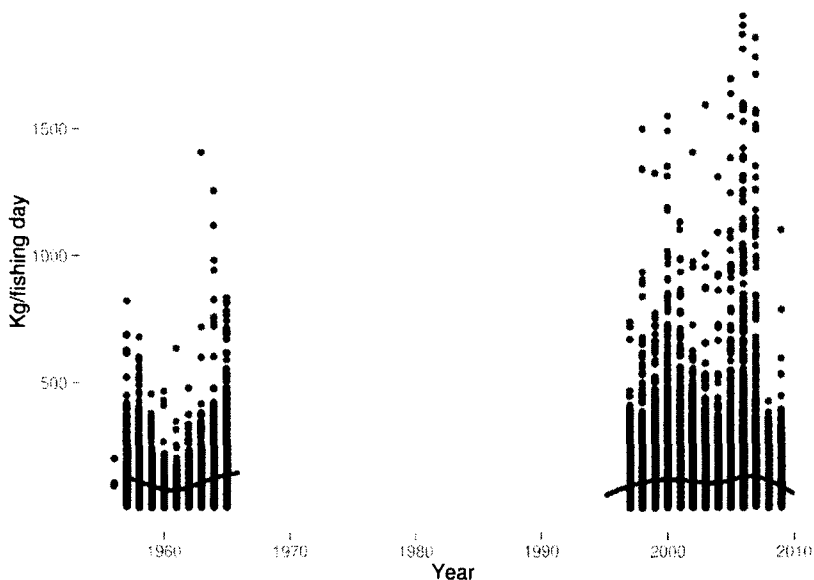

Figure 4-21. Daily LPUE (Kg/fishing day) for the port of Blanes (Catalonia) fitted with a simple smoother.

Listed below is the complete set of models fitted to the Blanes data:

```
k=20; l=15;m=8;n=10; o=10
bla.gammlq<-bam( log(kg-day) ~ s(year, k=k)+ s(HP, by=material, k=1)+s(month, k=m)+s(day,
k=n)+ s(grt, k=o)+ material*year.constr +offset(log(A1))+s(vessel, bs="re", by=dum1),
data=blatot1, family=gaussian, method="ML")
bla.gamm2q<-bam( log(kg-day)~ s(year, k=k)+ s(HP, by=dumn, k=1)+s(month, k=m)+s(day, k=n)
+ s(grt, k=o)+ material*year.constr +offset(log(A1))+s(vessel, bs="re", by=dum1),
data=blatot1, family=gaussian, method="ML")
```

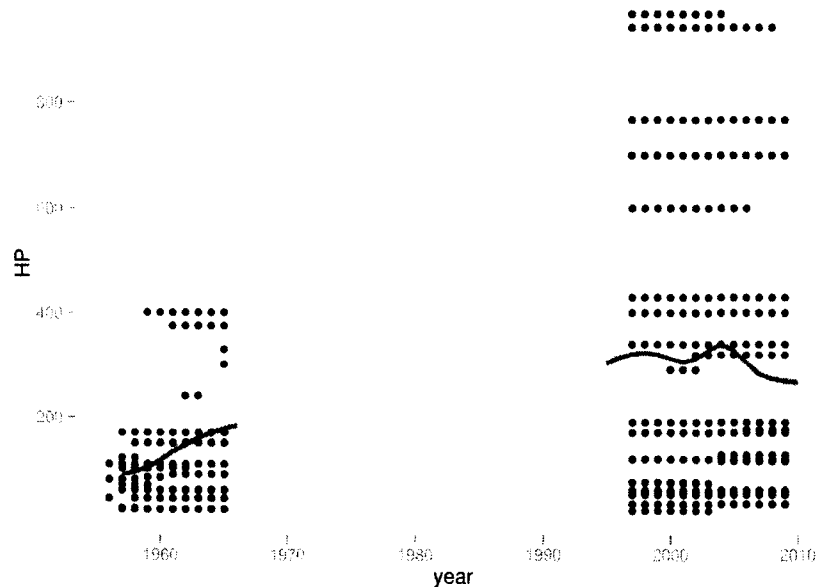

Figure 4-22. HP growth over time in Blanes (Catalonia, Spain) plus smoother.

```

bla.gamm3q<-bam( log(kg.day) ~ s(year, k=k)+ s(HP, by=dumn, k=1)+s(month, k=m)+s(day, k=n)
+ s(grt, k=0)+ material+year.constr +offset(log(A1))+s(vessel, bs="re", by=dum1),
data=blatot1, family=gaussian, method="ML")
bla.gamm4q<-bam( log(kg.day) ~ s(year, k=k)+ s(HP, by=dumn, k=1)+s(month, k=m)+s(day, k=n)
+ s(grt, k=0)+ material +offset(log(A1))+s(vessel, bs="re", by=dum1), data=blatot1,
family=gaussian, method="ML")
bla.gamm5q<-bam( log(kg.day) ~ s(year, k=k)+ s(HP, by=dumn, k=1)+s(month, k=m)+s(day, k=n)
+ s(grt, k=0) +offset(log(A1))+s(vessel, bs="re", by=dum1), data=blatot1, family=
gaussian, method="ML")
bla.gamm7q<-bam( log(kg.day) ~ s(year, k=k)+ s(HP, by=dumn, k=1)+s(month, k=m)+s(day, k=n)
)+ s(grt, by=material, k=0)+ material*year.constr+offset(log(A1))+s(vessel, bs="re"),
data=blatot1, family=gaussian, method="ML")
bla.gamm8q<-bam( log(kg.day) ~ s(year, k=k)+ s(HP, by=dumn, k=1)+s(month, k=m)+s(day, k=n)
)+ s(grt, by=material, k=0)+ material+year.constr+offset(log(A1))+s(vessel, bs="re"),
data=blatot1, family=gaussian, method="ML")
bla.gamm9q<-bam( log(kg.day) ~ s(year, k=k)+ s(HP, by=dumn, k=1)+s(month, k=m)+s(day, k=n)
)+ s(grt, k=0)+ material+year.constr+offset(log(A1))+s(vessel, bs="re"), data=blatot1,
family=gaussian, method="ML")
bla.gamm10q<-bam( log(kg.day) ~ s(year, k=k)+ s(HP, by=dumn, k=1)+s(month, k=m)+s(day, k=n)
)+ grt+ material*year.constr+offset(log(A1))+s(vessel, bs="re"), data=blatot1, family=
gaussian, method="ML") # can't drop s grt
bla.gamm11q<-bam( log(kg.day) ~ s(year, k=k)+ s(HP, by=dumn, k=1)+s(month, k=m)+day+ s(grt)
)+ material*year.constr+offset(log(A1))+s(vessel, bs="re"), data=blatot1, family=
gaussian, method="ML")

```

Based on AIC and ML estimation the best fitting model is *bla.gamm8* (Table 4.5), which was refitted with REML estimation and summarized below. A set of knot parameter was tested to find the best ones using visual inspection of residual patterns and increase of

estimated degrees of freedom (EDF) of the smooth terms. Diagnostics plots (Figure 4-24) are good and present no problem.

Model	df	AIC
bla.gamm1q	70.17	84167.98
bla.gamm2q	74.17	84413.10
bla.gamm3q	74.60	84321.69
bla.gamm4q	79.75	84233.40
bla.gamm5q	75.10	84244.60
bla.gamm7q	74.20	84080.26
bla.gamm8q	75.11	84044.49
bla.gamm9q	74.60	84321.69
bla.gamm10q	76.31	84143.57
bla.gamm11q	73.78	84082.48

Table 4.5. AIC of different random effects models for Total Catch/Fishing Day in the Blanes series (Spain)

Summary table of model *bla.gamm8reml*, the model explains 21.8% of the Deviance. The random effects on vessel (bottom left panel Figure 4-23) are normal. The yearly trend in mean LPUE (top left smoother in Figure 4-23) shows a decline in LPUE within the old series, a steep drop with the new series and, within the latter, a plateau phase with some slight variation. In this model it was possible to use Month and Day as predictors, which both are highly significantly decreasing. The type of material was used as a parametric predictor and estimates show that vessels with polyester hulls, which correspond to the most modern trawlers, have higher catches. The best model selected explains 26% of the deviance.

```

k=20; l=15;m=8;n=10; o=10
Formula:
log(kg-day) ~ s(year, k = k) + s(HP, by = dumn, k = l) + s(month,
  k = m) + s(day, k = n) + s(grt, by = material, k = o) + material +
  year.constr + offset(log(AI)) + s(vessel, bs = "re")

Parametric coefficients:
              Estimate Std. Error t value Pr(>|t|)
(Intercept)   1.317653   7.192048   0.183   0.855
materialsteel -0.342979   0.813408  -0.422   0.673
materialwood  -0.017807   0.242696  -0.073   0.942
year.constr    0.001371   0.003608   0.380   0.704

Approximate significance of smooth terms:
              edf Ref. df      F p-value
s(year)      16.388 16.913 136.116 < 2e-16 ***
s(HP):dumna  6.773  6.929  16.473 < 2e-16 ***

```

s(HP):dumnb	4.795	4.904	13.144	1.29e-12	***
s(HP):dumnc	3.996	3.996	0.457	0.767	
s(month)	5.946	6.116	49.476	< 2e-16	***
s(day)	2.092	2.626	13.525	5.46e-08	***
s(grt):materialpolyester	1.000	1.000	0.298	0.585	
s(grt):materialsteel	1.000	1.000	0.002	0.960	
s(grt):materialwood	1.998	1.998	0.990	0.371	
s(vessel)	26.909	28.191	13.861	< 2e-16	***

Signif. codes: 0 *** 0.001 ** 0.01 * 0.05 . 0.1 1

R-sq. (adj) = 0.259 Deviance explained = 26%
REML score = 42260 Scale est. = 0.34667 n = 47211

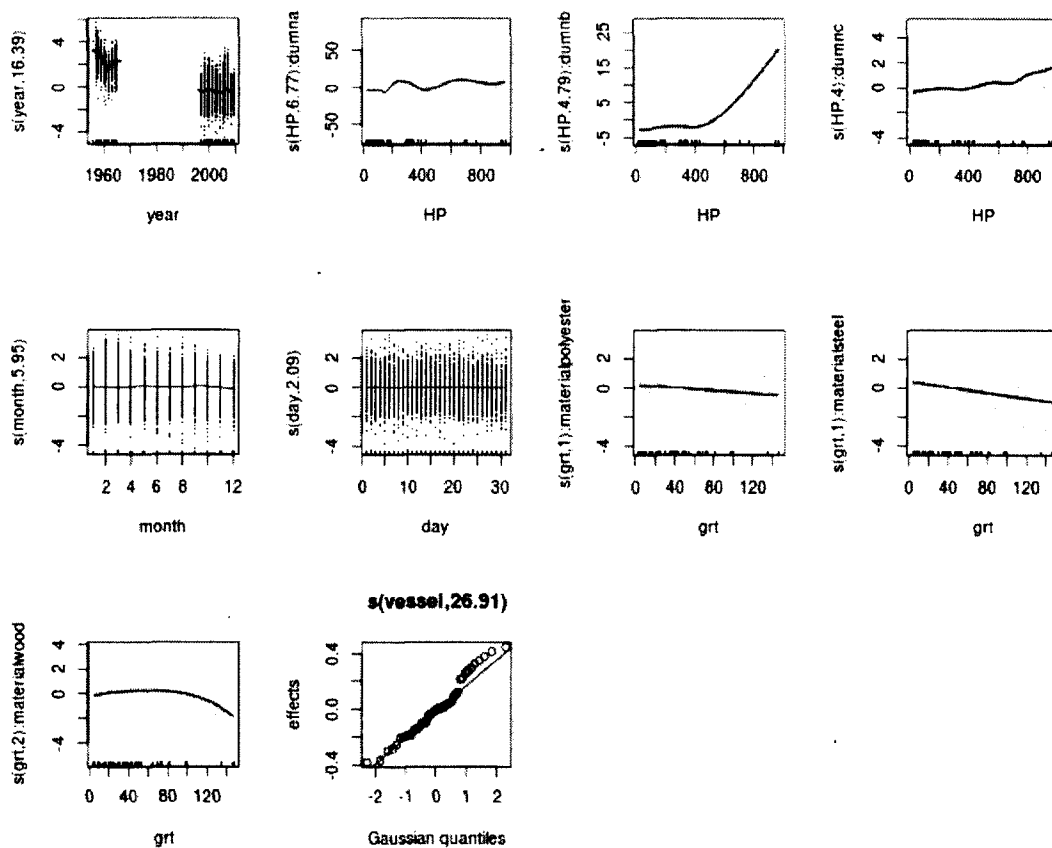

Figure 4-23. Estimated smoothing curves and random effects from the best GAMM for total catch/fishing day in Blanes fishing grounds (Catalonia), with 95% Confidence Intervals

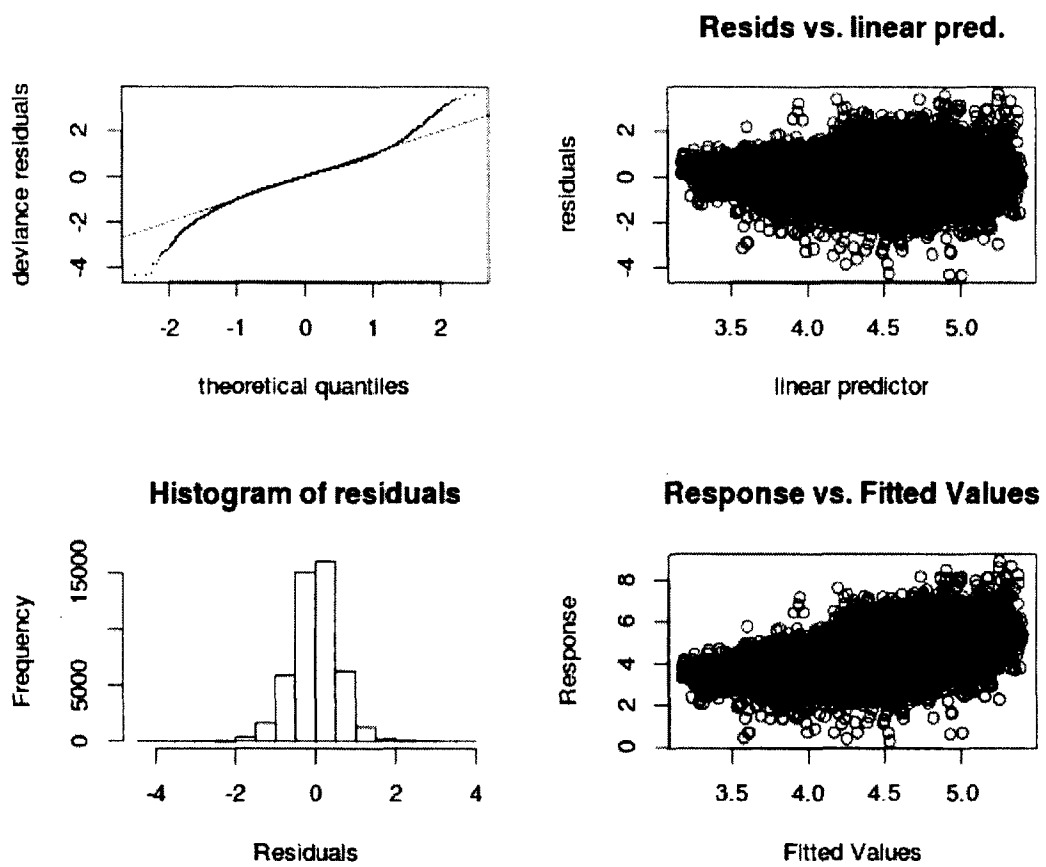

Figure 4-24. Model diagnostics for total catch/fishing day best model for Blanes fishing grounds (Catalonia)

4.5.3.3 Italy - Tuscany

The same modeling approach as in the French case was adopted. A specific set of models was fitted to the Tuscan subarea of Porto Santo Stefano (PSS) and Castiglione della Pescaia (CDP), fishing grounds where a 20 year time series of LPUE is available. To this series, log-book data from the trawler Edda was added for years 1964-1969 [14]. The set of models tested is below, model selection was performed using maximum likelihood (ML) and parameter estimates were obtained using restricted maximum likelihood (REML). The set of predictor variables is Year, HP, Month, Day, boat material, length (vessel length), year of construction, gear (type of net, two levels ST (traditional low opening Mediterranean trawl) and SF (high vertical opening net)), Area (2 ports, PSS and CDP).

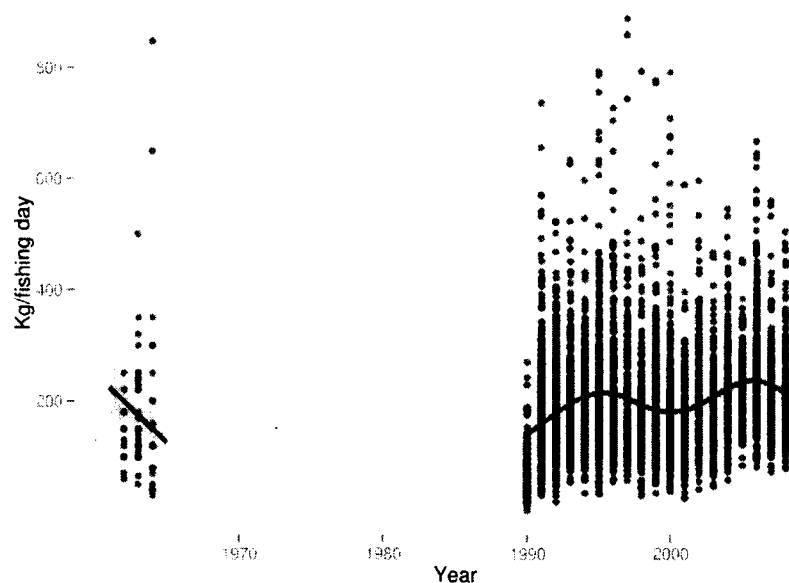

Figure 4-25. Daily LPUE (Kg/fishing day) for the Porto Santo Stefano and Castiglione della Pescaia (Tuscany- Italy) fishing grounds fitted with a simple smoother.

```

k=20; l=10;m=5;n=7;
pss.gamm1q<-bam( log(kg.day) ~ s(year, k=k)+ s(HP, by=dumn, k=1)+s(month, k=m)+s(day, k=n)+
  material*year.const+gear+dumn+length+area+s(vessel, bs="re", by=dum1), data=psstot3,
  family=gaussian, method="ML")
pss.gamm2q<-bam( log(kg.day) ~ s(year, k=k)+ s(HP, k=1)+s(month, k=m)+s(day, k=n)+ material
  *year.const+gear+dumn+length+area+s(vessel, bs="re", by=dum1), data=psstot3, family=
  gaussian, method="ML")
pss.gamm3q<-bam( log(kg.day) ~ s(year, k=k)+ s(HP, by=gear, k=1)+s(month, k=m)+s(day, k=n)
  +material*year.const +dumn+length+area+s(vessel, bs="re", by=dum1), data=psstot3,
  family=gaussian, method="ML")

```

```

pss.gamm4q<-bam( log(kg.day) ~ s(year, k=k)+ s(HP, by=gear, k=1)+s(month, k=m)+s(day, k=n)
)+ material+year.const+dumn+length+area+s(vessel, bs="re", by=dum1), data=psstot3,
family=gaussian, method="ML")
pss.gamm5q<-bam( log(kg.day) ~ s(year, k=k)+ s(HP, by=gear, k=1)+s(month, k=m)+s(day, k=n)+
material+year.const+length+dumn+area+s(vessel, bs="re", by=dum1), data=psstot3,
family=gaussian, method="ML")
pss.gamm6q<-bam( log(kg.day) ~ s(year, k=k)+ s(HP, by=gear, k=1)+s(month, k=m)+s(day, k=n)+
year.const+length+dumn+area+s(vessel, bs="re", by=dum1), data=psstot3, family=gaussian
, method="ML")
pss.gamm7q<-bam( log(kg.day) ~ s(year, k=k)+ s(HP, by=gear, k=1)+s(month, k=m)+s(day, k=n)+
year.const+dumn+area+s(vessel, bs="re", by=dum1), data=psstot3, family=gaussian,
method="ML")
pss.gamm8q<-bam( log(kg.day) ~ s(year, k=k)+ s(HP, by=gear, k=1)+s(month, k=m)+s(day, k=n)+
year.const+s(vessel, bs="re", by=dum1), data=psstot3, family=gaussian, method="ML")
pss.gamm9q<-bam( log(kg.day) ~ s(year, k=k)+ s(HP, by=gear, k=1)+s(month, k=m)+s(day, k=n)+
s(vessel, bs="re", by=dum1), data=psstot3, family=gaussian, method="ML")
pss.gamm10q<-bam( log(kg.day) ~ s(year, k=k)+ s(HP, by=gear, k=1)+s(month, k=1)+day+year.
const+s(vessel, bs="re", by=dum1), data=psstot3, family=gaussian, method="ML")
pss.gamm11q<-bam( log(kg.day) ~ s(year, k=k)+ s(HP, by=gear, k=1)+month+day+year.const+s(
vessel, bs="re", by=dum1), data=psstot3, family=gaussian, method="ML")

```

AIC scores are summarized in Table 4.6, best model is

Model	df	AIC
pss.gamm1q	68.28	3947.96
pss.gamm2q	71.59	3781.11
pss.gamm3q	71.90	3742.90
pss.gamm4q	71.61	3742.87
pss.gamm5q	69.15	3948.39
pss.gamm6q	71.46	3742.19
pss.gamm7q	69.24	3897.82
pss.gamm8q	69.83	3873.44
pss.gamm9q	92.87	4480.03
pss.gamm10q	68.34	3811.77
pss.gamm11q	63.26	3998.26

Table 4.6. AIC of different random effects models for Total Catch/Fishing Day in the Porto Santo Stefano (PSS) and Castiglione della Pescaia (CDP) series (Tuscany, Italy)

$\log(\text{kg.day}) \sim s(\text{year}, k = k) + s(\text{HP}, \text{by} = \text{gear}, k = 1) + s(\text{month}, k = m) + s(\text{day}, k = n) + \text{year.const} + \text{length} + \text{dumn} + \text{area} + s(\text{vessel}, \text{bs} = \text{"re"}, \text{by} = \text{dum1})$					
Parametric coefficients:					
	Estimate	Std. Error	t value	Pr(> t)	
(Intercept)	0.996060	4.494403	0.222	0.8246	
year.const	0.002033	0.002256	0.901	0.3675	
length	-0.006321	0.006781	-0.932	0.3513	
dumnc	0.094492	0.167692	0.563	0.5731	
areaPSS	0.215974	0.071936	3.002	0.0027	**
Signif. codes: 0 *** 0.001 ** 0.01 * 0.05 . 0.1 1					
Approximate significance of smooth terms:					
	edf	Ref.df	F	p-value	

s(year)	13.567	14.874	28.380	< 2e-16	***				
s(HP):gearSF	3.483	3.545	7.810	8.81e-06	***				
s(HP):gearST	2.937	2.936	8.559	1.38e-05	***				
s(month)	3.919	3.996	15.032	3.44e-12	***				
s(day)	5.165	5.501	9.274	1.86e-09	***				
s(vessel):dum1	35.514	39.587	12.894	< 2e-16	***				
Signif. codes:	0	***	0.001	**	0.01	*	0.05	.	0.1
R-sq.(adj) =	0.334	Deviance explained =	34.5%						
REML score =	1981.1	Scale est. =	0.14998	n =	4058				

Diagnostic plots (Figure 4-27) show acceptable residual patterns, QQ plot, histogram of residuals and QQ plot of random effect. Figure 4-26 displays the smoother and random effect of the best model selected. The year smoother (top left panel Figure 4-26 shows comparable LPUE levels at the end of the 1960s and in the last 20 years, which show a temporal increase. However the oldest year is higher than the first 4 years in the modern series. The HP smoother shows a different slope for gear SF and ST with the effect of HP being less important for the traditional low opening trawl gear (ST). In this case the offset parameter was not included due to the numerical instability and negative Deviances that it was generating. This means that the current yearly trend is not accounting for change in fishing power, other than accounting for vessel HP and dimensions. Therefore this is a particularly optimistic view. Additionally, in the old series generated from the captains logbook of one trawler, only fishing trips lasting one day were selected but these were a smaller subset of the whole. Fishing trips at the time had a variable duration of 1-5 days and one day was often associated to bad weather, which implied fishing locally in sub-optimal conditions [14, page 173].

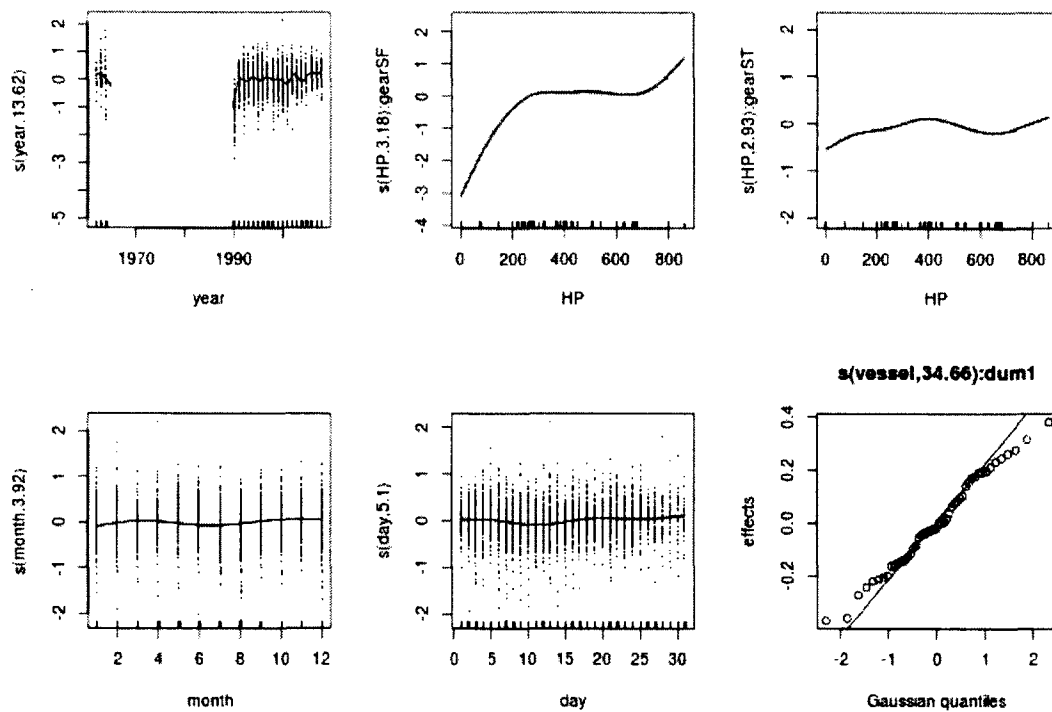

Figure 4-26. Estimated smoothing curves and random effects from the best GAMM for total catch/fishing day on the Porto Santo Stefano and Castiglione della Pescaia fishing grounds (Southern Tuscany, Italy), with 95% Confidence Intervals.

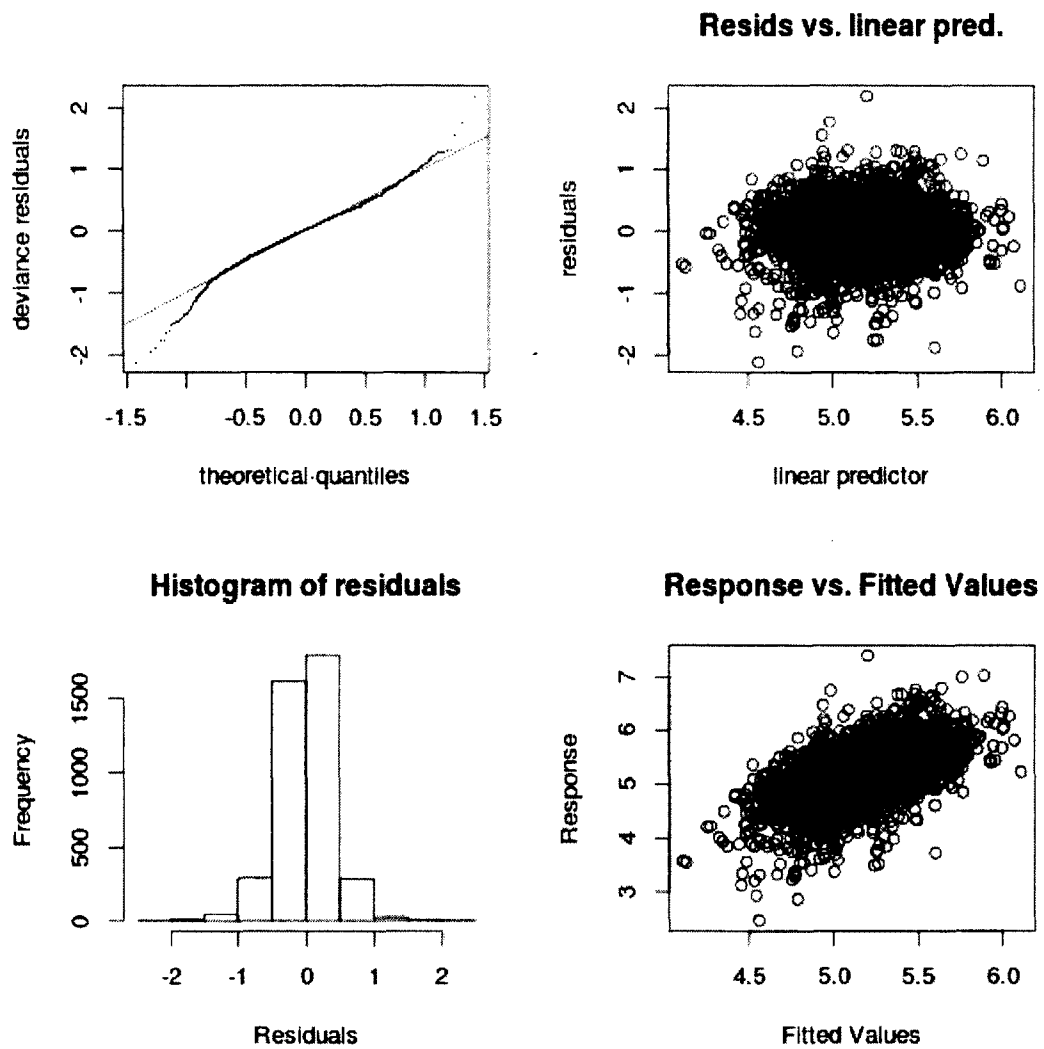

Figure 4-27. Model diagnostics for total catch/fishing day best model for the Porto Santo Stefano and Castiglione della Pescaia fishing grounds (Southern Tuscany, Italy)

4.5.3.4 Adriatic

A case study was built for the Adriatic Sea using commercial LPUE data from both the Italian and former Yugoslavian side. Available data are plotted in Figure 4-28 with a fitted line for each country (one for Italian data and one for the areas in former Yugoslavia (Jugo)). The trends between the two country are very different and, within former Yugoslavia, very distinct patterns can be seen between the area defined as Dalmatia and the Kvarner area.

We modeled the log of kg of total demersal catch per day as a function of Year, HP, dumn, type of trawler and country, and area as random effects. In this case the offset of A_1 was not included due to numerical instability. The full starting model includes a small number of covariates compared to prior models due to inclusion of historical data for which limited vessel information is available: Year, HP, type of trawler, area, country and number of fishing days. The model fitting procedure and models is shown in R code.

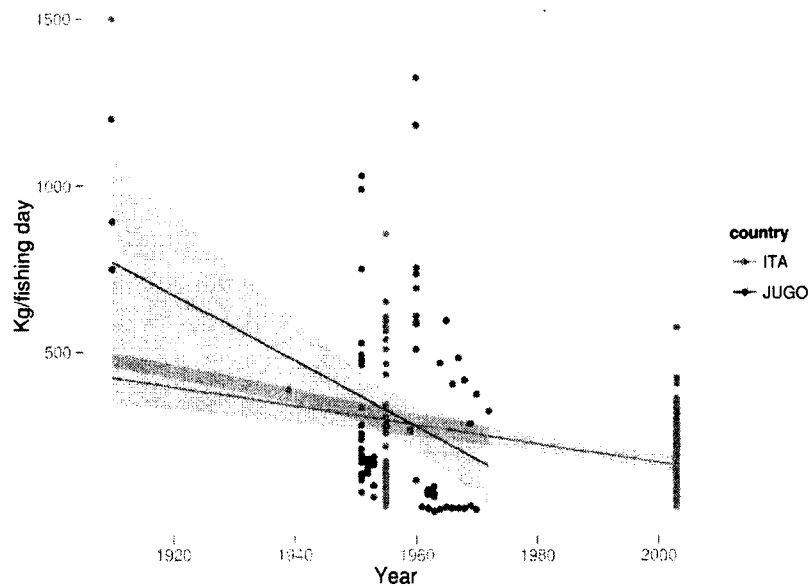

Figure 4-28. Daily LPUE (Kg/fishing day) for the Adriatic area with fitted lines for Year Kg per Fishing day.

k = 10; l = 8
k = 5; l = 5

```

adr.gamm1<-bam(log(kg.day)~s(year, k=k)+s(HP, by=dumn, k=1)+dumn+type_ trawler+s(country, bs="re", by=dum1)+s(area, bs="re", by=dum1), data=adr, weights=1/fishing_day, method="ML")
adr.gamm2<-bam(log(kg.day)~s(year, k=k)+s(HP, by=dumn, k=1)+dumn+type_ trawler+s(area, bs="re", by=dum1), data=adr, weights=1/fishing_day, method="ML")
adr.gamm3<-bam(log(kg.day)~s(year, k=k)+s(HP, by=dumn, k=1)+dumn+type_ trawler+s(country, bs="re", by=dum1), data=adr, weights=1/fishing_day, method="ML")
# drop area or country
adr.gamm4<-bam(log(kg.day)~s(year, k=k)+s(HP, by=dumn, k=1)+type_ trawler+s(area, bs="re", by=dum1), data=adr, weights=1/fishing_day, method="ML")
adr.gamm5<-bam(log(kg.day)~s(year, k=k)+s(HP, k=1)+dumn+s(area, bs="re", by=dum1), data=adr, weights=1/fishing_day, method="ML")
adr.gamm6<-bam(log(kg.day)~s(year, k=k)+HP+type_ trawler+dumn+s(area, bs="re", by=dum1), data=adr, weights=1/fishing_day, method="ML")
adr.gamm7<-bam(log(kg.day)~s(year, k=k)+HP+dumn+s(area, bs="re", by=dum1), data=adr, weights=1/fishing_day, method="ML")
adr.gamm8<-bam(log(kg.day)~s(year, k=k)+HP+s(area, bs="re", by=dum1), data=adr, weights=1/fishing_day, method="ML")

```

AIC scores are summarized in Table 4.7, the best model is *adr.gamm8*, however residual patterns (Figure 4-30) are not good and the model results should be taken carefully.

Model	df	AIC
adr.gamm1	7.82	808.95
adr.gamm2	7.82	808.95
adr.gamm3	7.82	808.95
adr.gamm4	7.82	808.95
adr.gamm44	9.73	808.20
adr.gamm5	5.63	801.74
adr.gamm6	5.00	810.69
adr.gamm7	4.92	805.18

Table 4.7. AIC of different random effects models for Total Catch/Fishing Day in the Adriatic Sea.

The final model is very simple but the low number of points and substantial unbalance contribute to a non-reliable model, despite the optimistic 57.1% deviance explained. Nevertheless the year trend is steeply declining over time (left panel Figure 4-29 and this is confirmed by the raw data plots)

```

Family: gaussian
Link function: identity

Formula:
log(kg.day) ~ s(year, k = k) + s(HP, k = 1) + s(area, bs = "re",
by = dum1)

Parametric coefficients:
Estimate Std. Error t value Pr(>|t|)
(Intercept) 5.7167 0.2378 24.04 <2e-16 ***

```

Signif. codes: 0 *** 0.001 ** 0.01 * 0.05 . 0.1 1									
Approximate significance of smooth terms:									
	edf	Ref.df	F	p-value					
s(year)	1.000	1.000	94.561	< 2e-16 ***					
s(HP)	2.116	2.526	10.529	7.54e-06 ***					
s(area):dum1	1.020	1.212	0.266	0.652					
Signif. codes: 0 *** 0.001 ** 0.01 * 0.05 . 0.1 1									
R-sq.(adj) = 0.979		Deviance explained = 58.2%							
REML score = 118.92		Scale est. = 0.15407		n = 230					

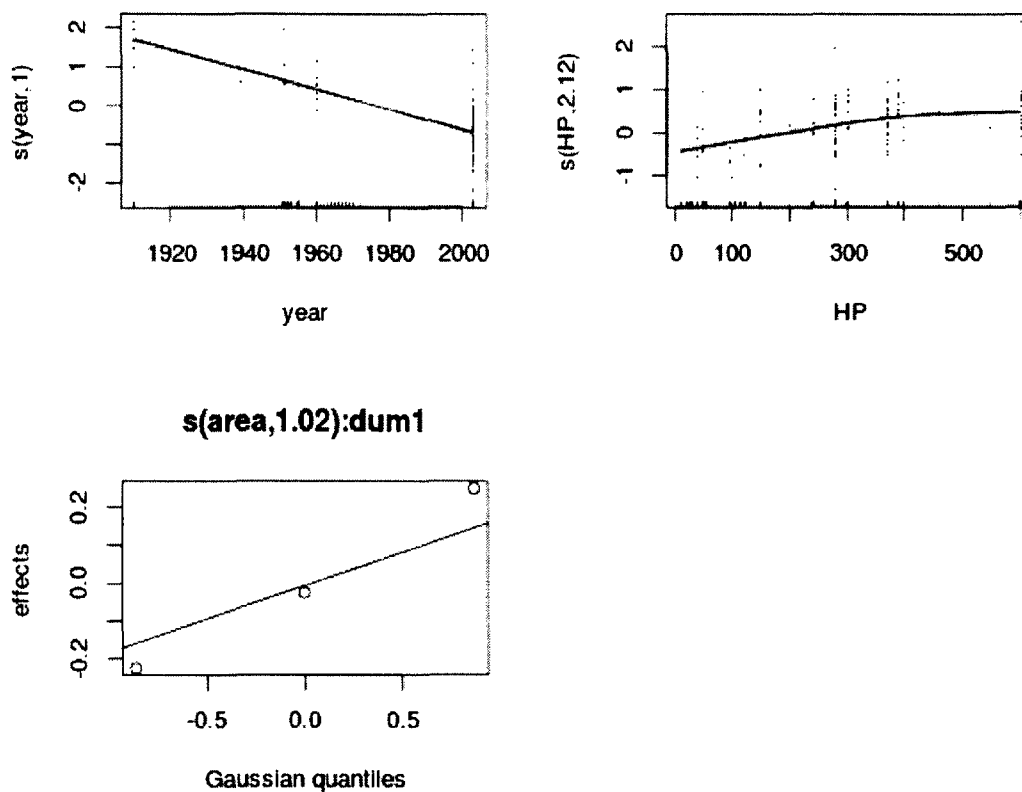

Figure 4-29. Estimated smoothing curves and random effects from the best GAMM for total catch/fishing day in the Adriatic Sea, with 95% Confidence Intervals.

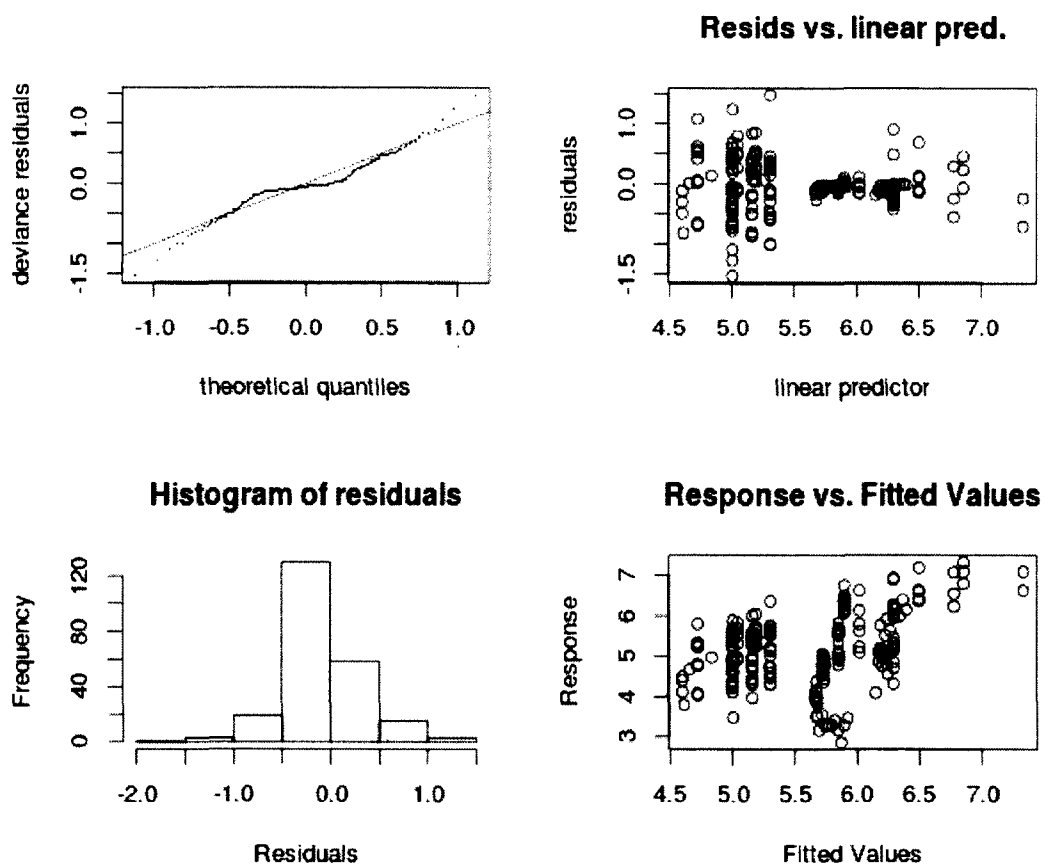

Figure 4-30. Model diagnostics for total catch/fishing day best model for the Adriatic Sea.

4.5.3.5 Sicilian Channel and Tunisia

A local analysis was built, including all information available and described before, comprising southern Sicily, all areas between Sicily and Tunisia (including Malta), Tunisia and Libya. The available data is poor, however, for the variable kg/fishing day (64 records) since in this area a more common unit to report data is kg/fishing hour. This is because we had to mainly rely on published LPUEs since, unlike in other NW Mediterranean areas, it was not possible to access any raw dataset.

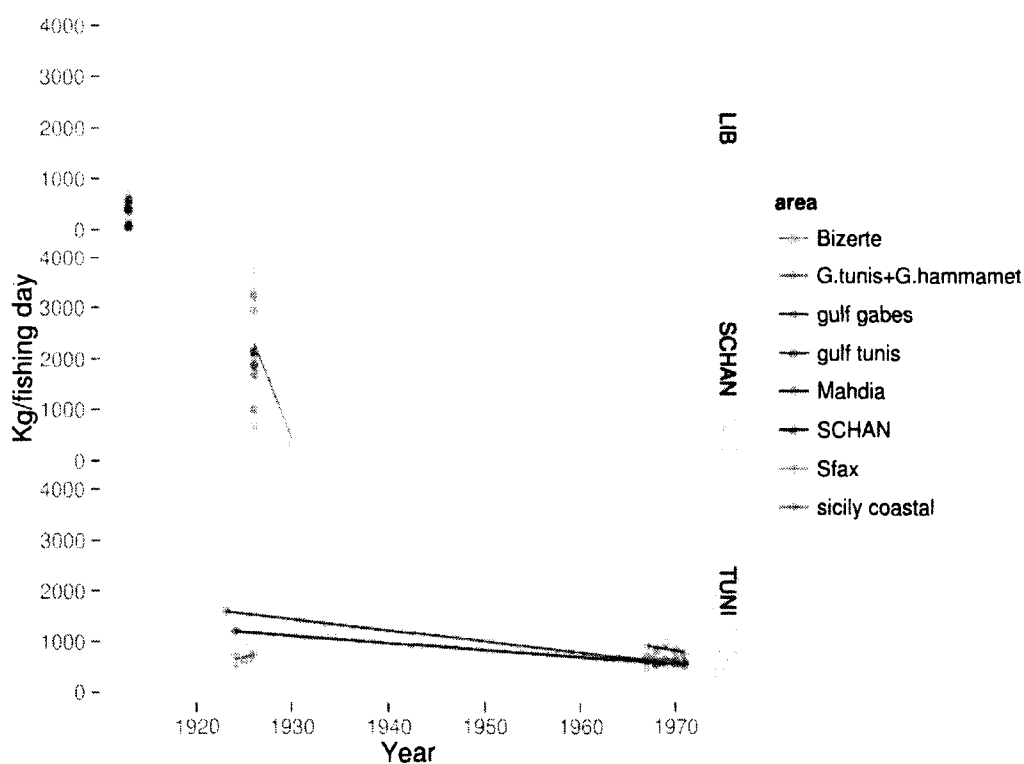

Figure 4-31. Daily LPUE (Kg/fishing day) for the Sicilian Channel fishing grounds fitted with a simple smoother.

The scarcity of data over a long time span in 3 different countries renders poorly fitting models, as can be seen. Results of best model fit should be taken very carefully since diagnostics plots show bad residual patterns and a poorly fitting model.

Link function: identity

Formula:

```
log(kg-day) ~ s(year, k = k) + HP + type-trawler + dumn + s(area,
  bs = "re", by = dum1)
```

Parametric coefficients:

	Estimate	Std. Error	t value	Pr(> t)
(Intercept)	7.88371	5.89873	1.337	0.1866
HP	-0.07380	0.06814	-1.083	0.2832
type_trawlerpair_motor	-2.41170	2.68670	-0.898	0.3731
type_trawlerpairsailtrawler	-2.04807	1.12587	-1.819	0.0741
type_trawlersteamtrawler	2.95762	3.54777	0.834	0.4079
dumnb	21.78344	16.91078	1.288	0.2028

Signif. codes: 0 *** 0.001 ** 0.01 * 0.05 . 0.1 1

Approximate significance of smooth terms:

	edf	Ref.df	F	p-value
s(year)	1.2274466	1.416659	0.662	0.47
s(area):dum1	0.0000615	0.000123	0.004	NA

R-sq.(adj) = 0.966 Deviance explained = 60.7%
REML score = 45.186 Scale est. = 0.27232 n = 65

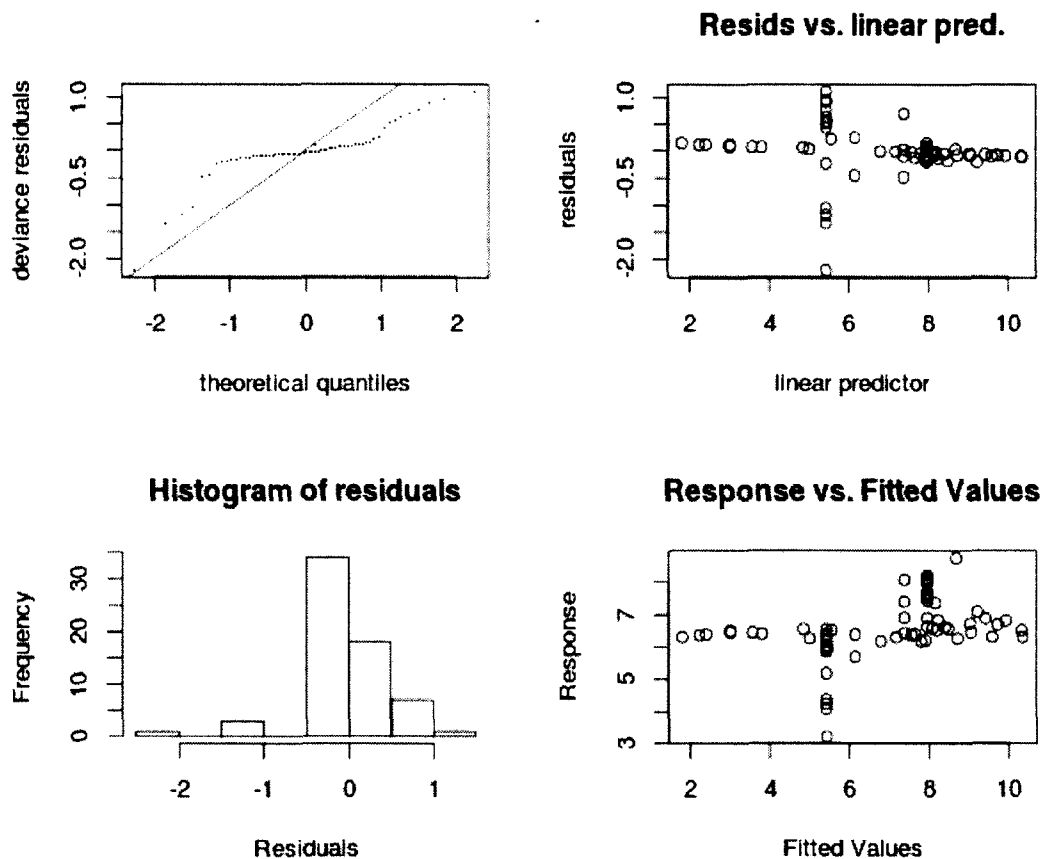

Figure 4-32. Estimated smoothing curves and random effects from the best GAMM for total catch/fishing day in the Sicilian Channel, with 95% Confidence Intervals.

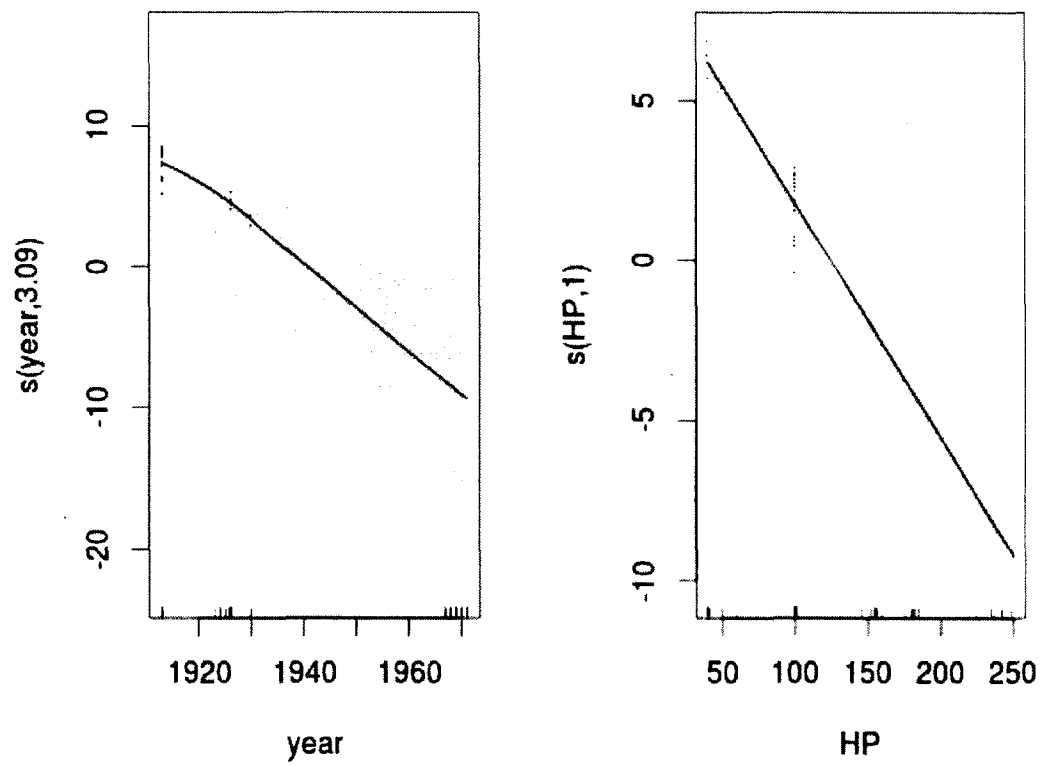

Figure 4-33. Model diagnostics for total catch/fishing day best model for the Sicilian Channel. The diagnostics plots show bad residual patterns and a poorly fitting model

4.6 LPUE analysis all areas Western Mediterranean

To investigate longer temporal and spatial trends in total demersal catch, two analyses are performed on the total catch rates of demersal species (fish, elasmobranchs, crustacean and mollusks), one on daily LPUE (kg/fishing day) and one on hourly LPUE (kg/fishing hour).

4.6.1 Total Catch (kg/fishing day)

Total catch per fishing day (here referred to as total commercial catch) is summarized by country in Figure 4-34 and joined together in Figure 4-35. The substantial spatio-temporal unbalance emerges from Figure 4-36 where the number of fishing days is plotted by area within country over years. The size of the bubbles is proportional to the fishing days and it shows the degree of aggregation present in the databases: thousands of fishing days were aggregated in both the Kvarner region and in Tunisia records, while in the majority of other areas, records are for each individual fishing trip.

As in previous examples the same modeling approach has been applied to the analysis for the entire western Mediterranean, including a dummy variable, A_1 , as an offset parameter and a weighting factor of the inverse of the number of fishing days ($1/N \text{ fishingDays}$). The dataset consists of 67416 records which, due to the aggregation of fishing days, originated in a much higher effective number of fishing trips. To date this dataset has been the first and only one constructed over such a large time span and geographical area. No prior information exists on historical commercial trawl LPUEs to give indications and help in the analysis. Additionally, the available data rarely came with metadata describing at least appropriately the data and their properties.

One of the main objectives of this analysis was to incorporate the maximum number of historical records (pre-1950) and whenever necessary make acceptable assumption about missing parameters. The lack of parameters has largely reduced the

```
k=8, l=5
allgam0<-bam(log(kg.day)~s(year, k=k)+s(HP,by=dum, k=1)+s(country,bs="re", by=dum1)+s(
  area, bs="re", by=dum1)+type.trawler*material+offset(log(A1)), weights= 1/fishing.day,
  data=oldcpue0, na.action=na.omit, method="ML")
allgam1<-bam(log(kg.day)~s(year, k=k)+s(HP,by=dum, k=1)+s(country,bs="re", by=dum1)+type.
  trawler*material+offset(log(A1)), weights= 1/fishing.day, data=oldcpue0, na.action=na.
  omit, method="ML")
```

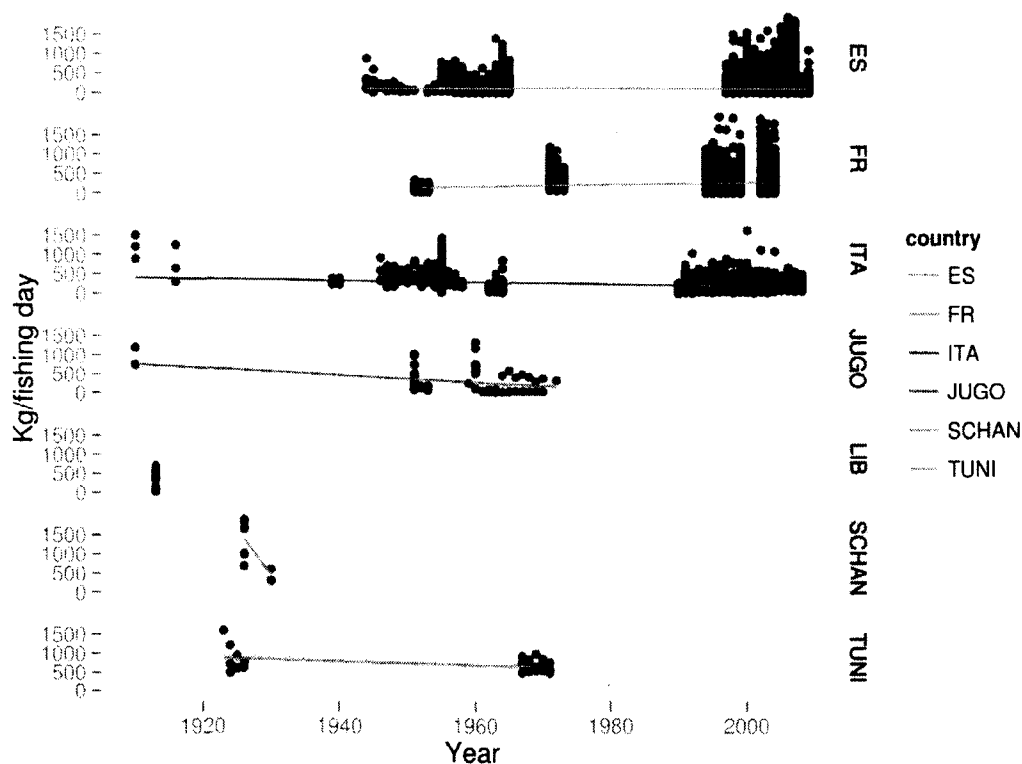



Figure 4-34. Daily LPUE (Kg/fishing day) for western Mediterranean countries fitted with a simple smoother.

```

allgamm3<-bam(log(kg.day)~s(year, k=k)+s(HP, k=1)+s(country, bs="re", by=dum1)+s(area, bs="
re", by=dum1)+type_trawler*material+offset(log(A1)), weights=1/fishing_day, data=
oldcpue0, na.action=na.omit, method="ML")
allgamm4<-bam(log(kg.day)~s(year, k=k)+s(HP, by=type_trawler, k=1)+s(country, bs="re", by=
dum1)+s(area, bs="re", by=dum1)+dum*material+offset(log(A1)), weights=1/fishing_day,
data=oldcpue0, na.action=na.exclude, method="ML")
allgamm5<-bam(log(kg.day)~s(year, k=k)+s(HP, by=dum, k=1)+s(country, bs="re", by=dum1)+s(
area, bs="re", by=dum1)+type_trawler+material+offset(log(A1)), weights= 1/fishing_day,
data=oldcpue0, na.action=na.omit, method="ML")
allgamm7<-bam(log(kg.day)~s(year, k=k)+s(HP, by=dum, k=1)+s(country, bs="re", by=dum1)+s(
area, bs="re", by=dum1)+material+offset(log(A1)), weights= 1/fishing_day, data=
oldcpue0, na.action=na.omit, method="ML")
allgamm9<-bam(log(kg.day)~s(year, k=k)+s(HP, k=1)+s(country, bs="re", by=dum1)+s(area, bs="
re", by=dum1)+dum+offset(log(A1)), weights= 1/fishing_day, data=oldcpue0, na.action=na
.omit, method="ML")
allgamm10<-bam(log(kg.day)~s(year, k=k)+s(HP, k=1)+s(country, bs="re", by=dum1)+s(area, bs=
"re", by=dum1)+offset(log(A1)), weights= 1/fishing_day, data=oldcpue0, na.action=na.
omit, method="ML")
allgamm11<-bam(log(kg.day)~s(year, k=k)+HP+s(country, bs="re", by=dum1)+s(area, bs="re", by
=dum1)+offset(log(A1)), weights= 1/fishing_day, data=oldcpue0, na.action=na.omit,
method="ML")
allgamm12<-bam(log(kg.day)~year+HP+s(country, bs="re", by=dum1)+s(area, bs="re", by=dum1)+
offset(log(A1)), weights= 1/fishing_day, data=oldcpue0, na.action=na.omit, method="ML"
)

```

k=8; l=5
Formula:

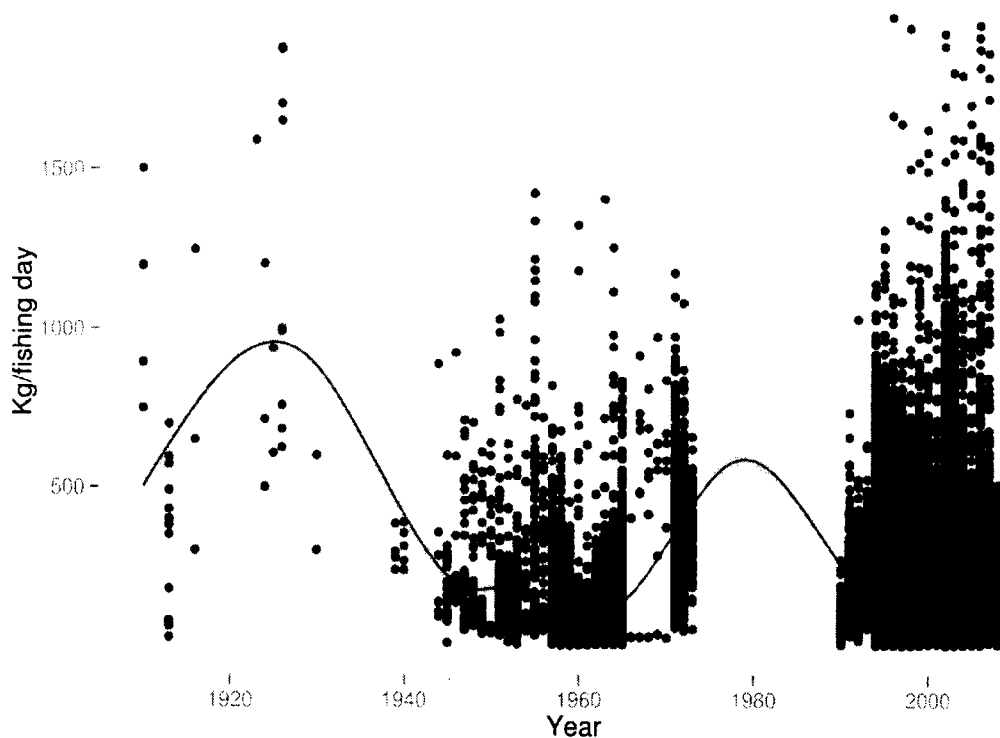

Figure 4-35. Daily LPUE (Kg/fishing day) for the western Mediterranean fishing grounds fitted with a simple smoother.

```
log(kg_day) ~ s(year, k = k) + s(HP, by = dum, k = l) + s(country,
  bs = "re", by = dum1) + s(area, bs = "re", by = dum1) + type_trawler +
  material + offset(log(A1))
```

Parametric coefficients:

	Estimate	Std. Error	t value	Pr(> t)
(Intercept)	4.62706	0.19922	23.226	< 2e-16 ***
type_trawlerpair_motor	-0.69750	0.77168	-0.904	0.3661
type_trawlerpairsailtrawler	1.29759	0.50834	2.553	0.0107 *
type_trawlersteamtrawler	1.54688	0.72140	2.144	0.0320 *
materialsteel	-0.28258	0.01868	-15.124	< 2e-16 ***
materialwood	0.06713	0.01015	6.612	3.82e-11 ***

Signif. codes: 0 *** 0.001 ** 0.01 * 0.05 . 0.1 1

Approximate significance of smooth terms:

	edf	Ref. df	F	p-value
s(year)	6.721519	6.883925	188.872	<2e-16 ***
s(HP):duma	3.046440	3.204241	225.572	<2e-16 ***
s(HP):dumb	3.677587	3.877857	283.770	<2e-16 ***
s(HP):dumc	3.992621	3.999965	1067.549	<2e-16 ***
s(country):dum1	0.005163	0.005803	0.002	NA
s(area):dum1	9.294977	10.388693	490.441	<2e-16 ***

Signif. codes: 0 *** 0.001 ** 0.01 * 0.05 . 0.1 1

R-sq.(adj) = 0.559 Deviance explained = 35.5%

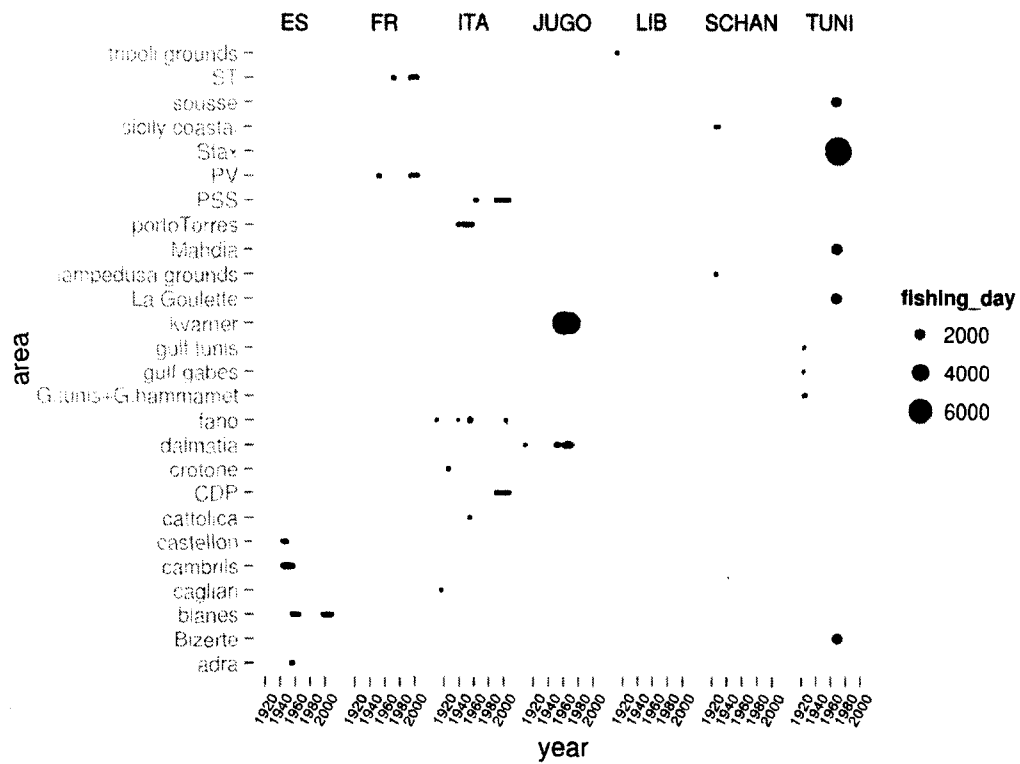

Figure 4-36. Number of fishing days available and modeled in the LPUE standardization for the western Mediterranean fishing grounds, plotting based on area, country and year.

REML score = 69138 Scale est. = 0.4541 n = 67416

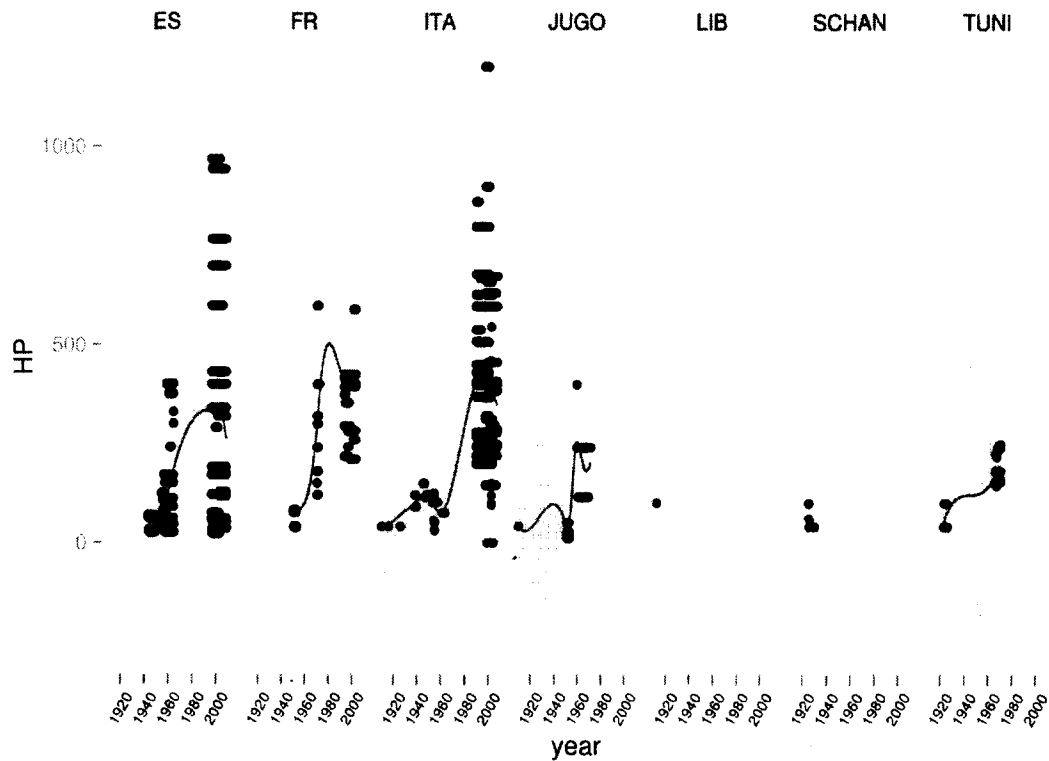

Figure 4-37. Vessel engine HP over time and by country used in the LPUE standardization for the western Mediterranean fitted with a loss smoother.

Model	df	AIC
allgamm0	33.40	142127.78
allgamm1	28.17	142315.73
allgamm3	27.56	143389.24
allgamm4	24.80	144162.50
allgamm5	33.40	142127.78
allgamm7	31.75	142137.75
allgamm9	25.02	143401.11
allgamm10	23.92	144100.46
allgamm11	20.95	145087.15
allgamm12	15.23	147656.34

Table 4.8. AIC of different random effects models for Total Catch/Fishing Day in the northwestern Mediterranean Sea.

tab:AICallMed

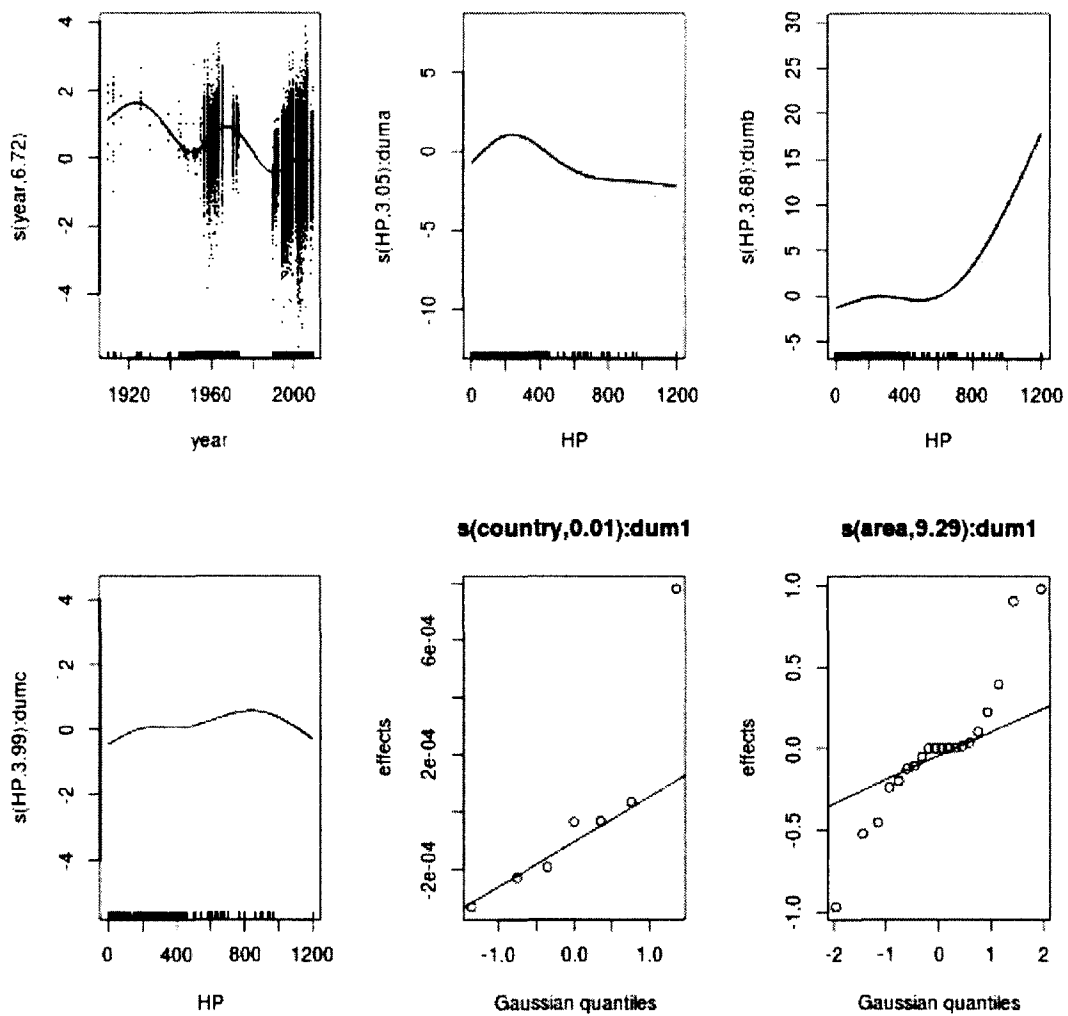

Figure 4-38. Estimated smoothing curves and random effects from the best GAMM for total catch/fishing day in the western Mediterranean (excluding Algeria and Morocco), with 95% confidence intervals.

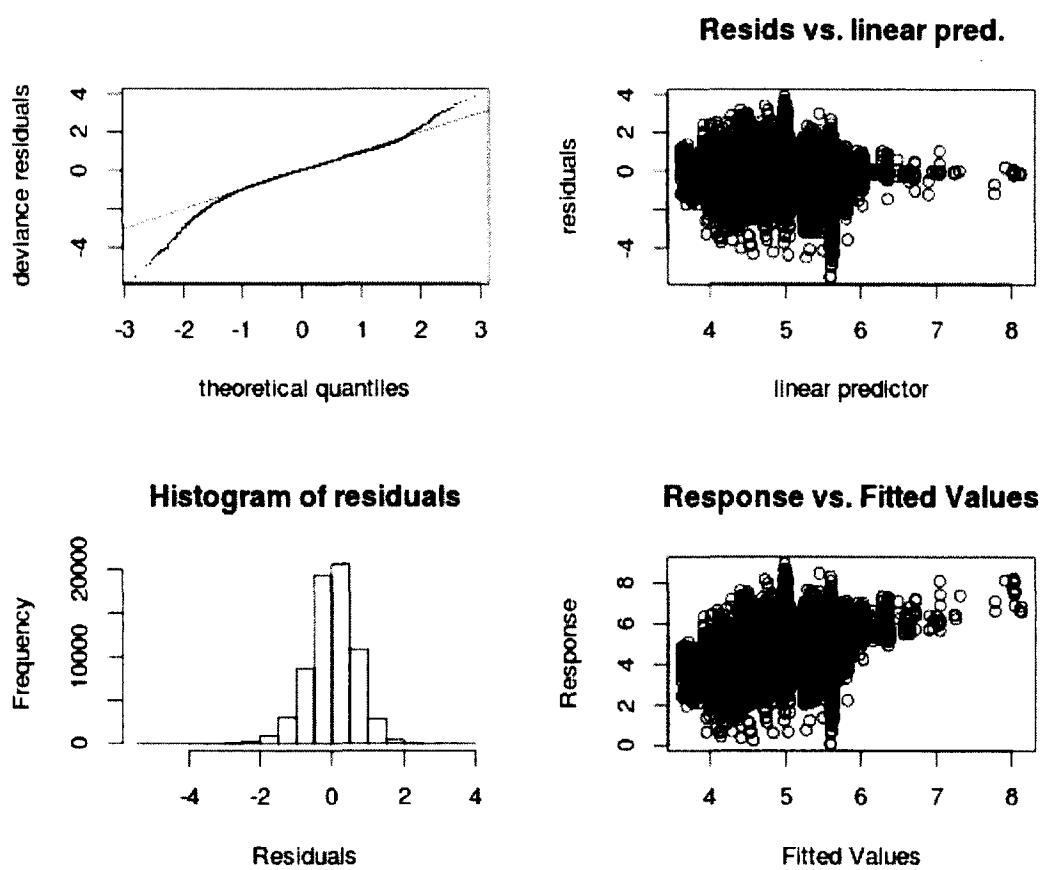

Figure 4-39. Model diagnostics for total catch/fishing day best model for the western Mediterranean (excluding Algeria and Morocco)

4.6.2 Total Catch (kg/60min)

In most commercial exploratory fishing, catch is reported on a hourly basis rather than by fishing trip. To avoid gross assumptions about how many hours of fishing occurred on an average day of a fishing trip (which indicatively is between 8-10 [ref]), a separate analysis is deemed necessary. While the dataset is smaller, there are different advantages: catch is standardized by a precise estimate of fishing time, gear failure is parsed out, hauling and cruise speed are not confoundings. This implies a lesser effect of technological creep bias: improvement in deck equipment, gear failure, change in navigation speed do not affect estimates of LPUE. Disadvantages are, more variability in the data since single hauls or few aggregated hauls are modeled, the spatial and depth effects are likely stronger.

Total catch per fishing hour (here referred to total commercial catch) is summarized by country in Figure 4-40.

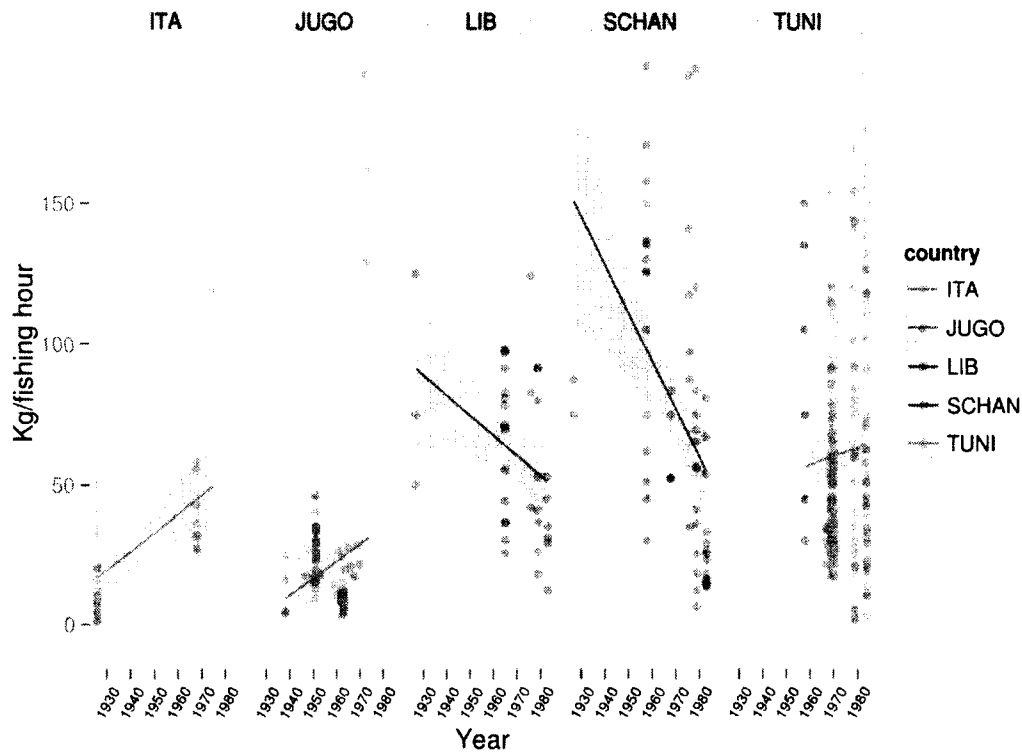

Figure 4-40. Daily LPUE (Kg/fishing hour) for western Mediterranean fishing grounds fitted with a simple smoother.

The same modeling approach is implemented for hourly catch rates, however with two differences: weighting factor is now number of fishing hours instead of fishing days and the offset of A_1 was dropped since it was causing numerical problems.

```

k=12 ; l=3
allhgamm0<-bam( log(kg.fishing.hour)~ s(year, k=k)+ s(HP,k=l,by=dum)+s(country,bs="re", by
=dum1)+s(area, bs="re", by=dum1), weights=1/fishing_hours, data=oldcpueh, method="ML")
allhgamm1<-bam( log(kg.fishing.hour)~ s(year, k=k)+ s(HP,k=l,by=dum)+s(country,bs="re", by
=dum1), weights=1/fishing_hours, data=oldcpueh, method="ML")
allhgamm2<-bam( log(kg.fishing.hour)~ s(year, k=k)+ s(HP,k=l,by=dum)+s(area, bs="re", by=
dum1), weights=1/fishing_hours, data=oldcpueh, method="ML")
allhgamm3<-bam( log(kg.fishing.hour)~ s(year, k=k)+ s(HP,k=l)+dum+s(area, bs="re", by=dum1
), weights=1/fishing_hours, data=oldcpueh, method="ML")
allhgamm4<-bam( log(kg.fishing.hour)~ s(year, k=k)+ s(HP,k=l)+s(area, bs="re", by=dum1),
weights=1/fishing_hours, data=oldcpueh, )
allhgamm5<-bam( log(kg.fishing.hour)~ s(year, k=k)+ HP*dum+s(area, bs="re", by=dum1),
weights=1/fishing_hours, data=oldcpueh, method="ML")
allhgamm6<-bam( log(kg.fishing.hour)~ s(year, k=k)+ HP+dum+s(area, bs="re", by=dum1),
weights=1/fishing_hours, data=oldcpueh, method="ML")
allhgamm7<-bam( log(kg.fishing.hour)~ s(year, k=k)+ s(HP, k=l)+s(area, bs="re", by=dum1) ,
weights=1/fishing_hours, data=oldcpueh, method="ML")
allhgamm9<-bam( log(kg.fishing.hour)~ s(year, k=k)+HP+s(area, bs="re", by=dum1), weights=1/
fishing_hours, data=oldcpueh, method="ML")
allhgamm10<-bam( log(kg.fishing.hour)~ s(year, k=k)+s(area, bs="re", by=dum1), weights=1/
fishing_hours, data=oldcpueh, method="ML")

```

Model	df	AIC
allhgamm0	8.30	939.22
allhgamm1	6.00	946.76
allhgamm2	8.30	939.22
allhgamm3	8.29	939.32
allhgamm4	7.68	937.93
allhgamm5	9.20	941.11
allhgamm6	8.29	939.32
allhgamm7	6.82	939.19
allhgamm9	6.82	939.19
allhgamm10	5.67	941.64

```

k=12; l=3
log(kg.fishing.hour) ~ s(year, k = k) + s(HP, k = l) + s(area,
bs = "re", by = dum1)

Parametric coefficients:
      Estimate Std. Error t value Pr(>|t|)
(Intercept)  4.0046     0.1011  39.62  <2e-16 ***
---
Signif. codes:  0  ***    0.001  **   0.01  *   0.05  .   0.1  1

Approximate significance of smooth terms:
      edf Ref.df    F p-value
s(year)  1.731  1.974  1.797  0.1680
s(HP)    1.000  1.000  0.709  0.4004
s(area):dum1 2.946  4.121  2.048  0.0856
---
Signif. codes:  0  ***    0.001  **   0.01  *   0.05  .   0.1  1

```

R-sq.(adj) = 0.92 Deviance explained = 10%
REML score = 293.06 Scale est. = 0.35528 n = 316

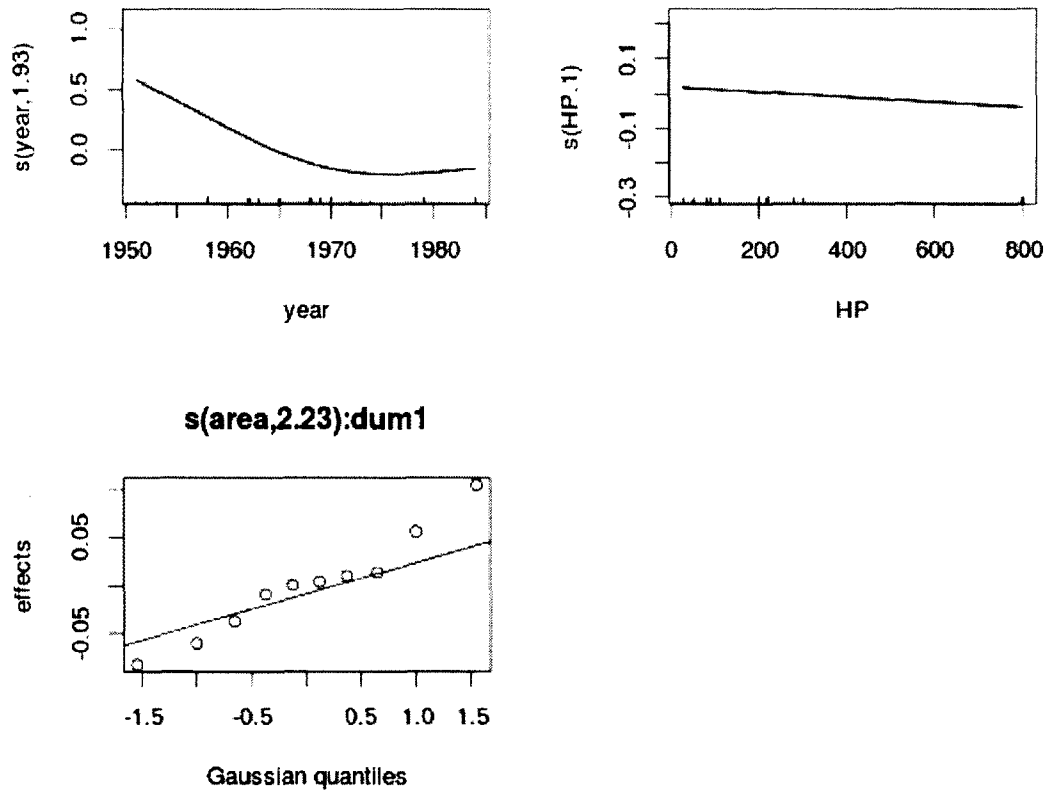

Figure 4-41. Estimated smoothing curves and random effects from the best GAMM for total catch/fishing day in the western Mediterranean (excluding Algeria and Morocco), with 95% confidence intervals.

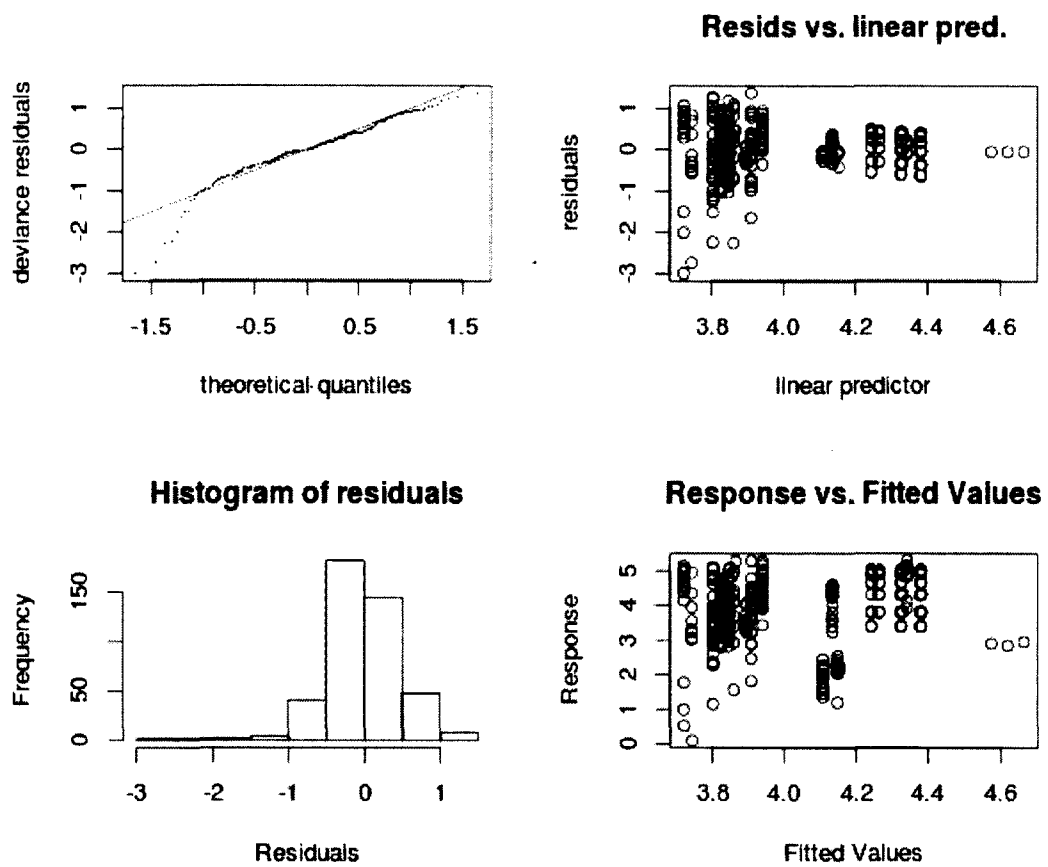

Figure 4-42. Model diagnostics for total catch/fishing hour best model for the western Mediterranean (excluding Algeria and Morocco)

4.6.3 Results

To give an overview of the results, yearly trends estimated by the smooth function $s(\textit{year})$ in the GAMMs, fitted for the different areas, have been extracted and plotted on a common time scale (1900-2020). The y axis is unscaled and in log space ($\log(\text{kg}/\text{day})$ and $\log(\text{kg}/\text{hour})$), therefore a decline from 2 to 0.5 is important. Yearly trends for the areas analyzed individually are the ones with greater confidence, in particular the Blanes and French cases where most data was disaggregated and given at high resolution (Figure 4-43). In particular, the rate of decline in total demersal relative abundance is comparable for Blanes and France; given the spatial proximity of the fishing grounds this result is coherent. For Tuscany, negative values in the smoother are caused by complete lack of data between 1969 and 1990. In this case no offset for fishing power correction was used and still the fit for the older period is slightly better than in the modern series. The rate of decline is marginal and a partial explanation could be that the area was under intense exploitation since before WW2 and even more afterwards, so that signs of overfishing were already apparent [118, 56, 233]. In the Sicilian Channel, although model fit is marginally acceptable, the trend is a steady decline over time. Unfortunately, no data from the last 30 years was accessible, so the most recent period remains unexplored. This is, however, a very productive area where, currently, the largest demersal fleet is concentrated in the Mediterranean (Figure 4, Chapter 2). Trends in fishing effort and capacity in the Sicilian Channel have not been explored in detail, but it is highly unlikely that a decline occurred before the mid 1990s. The Adriatic has also experienced a steady decline, although the model is not entirely robust.

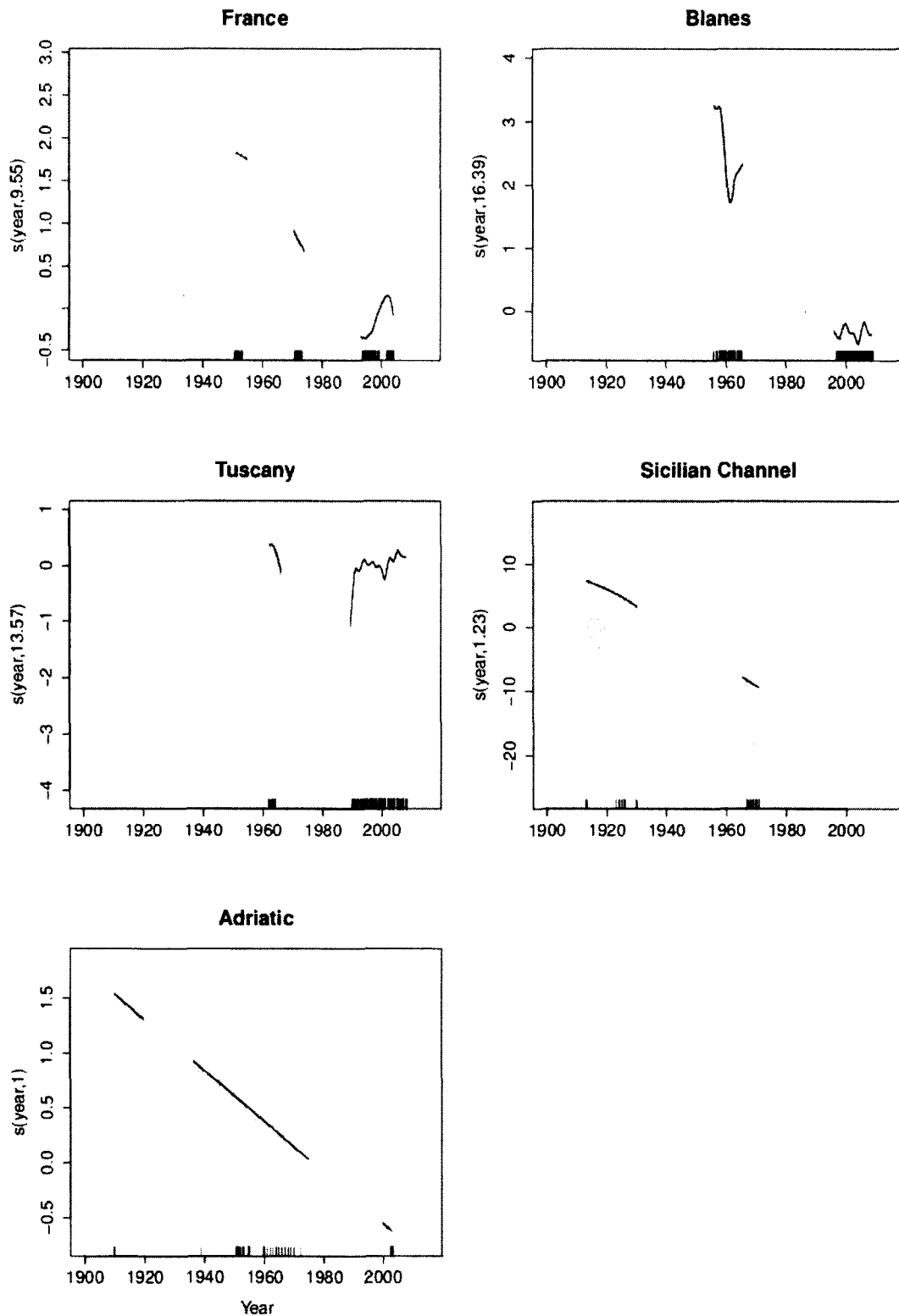

Figure 4-43. Summary of the estimated year smoother, with 95% confidence intervals, for the main areas analyzed for kg/hour LPUE. The x-axis shows the year and the rug (little vertical lines along the axis) the years in which data are available. The y-axis is the contribution of the smoother to the fitted values relabeled to show the unit of LPUE.

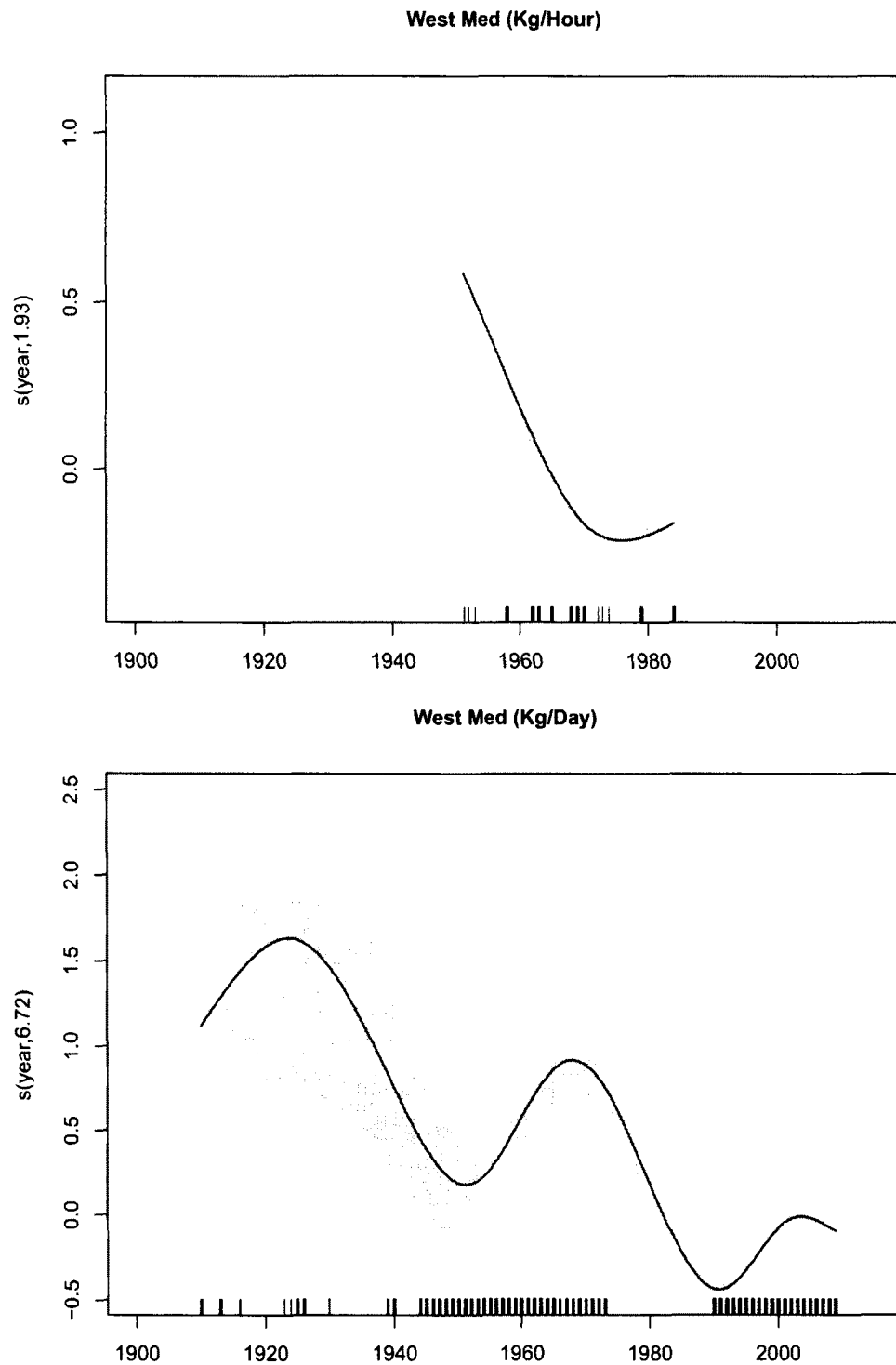

Figure 4-44. Summary of the estimated year smoother, with 95% confidence intervals, for the western Mediterranean for kg/hour and kg/day (excluding Algeria and Morocco). The x axis shows the year and the rug (little vertical lines along the axis) the years in which data are available. The y-axis is the contribution of the smoother to the fitted values relabeled to show the unit of the LPUE.

4.6.4 Discussion and Conclusions

The resulting trends in relative total demersal biomass with commercial value show a generally important decrease based on the GAMMs outputs, and most models are statistically robust. However, given the number and importance of some assumptions made about the data, there is a need to discuss the robustness of the assumptions and their implications for the results.

4.6.4.1 Effect of fishing power

In most models, $Kg/Fishing_{day}$ was the variable modeled, standardized to an effort of 1 fishing day: it represents the catch landed from a fishing trip of approximately 1 day. If fishing days were greater than one, LPUE was calculated over multiple days. Several technological improvements will directly affect the effective fishing time within one fishing day. Trawler cruise speed has improved, thus travel time to and from fishing grounds decreased meaning that, at equal time of departure and return to port, towing time increased.

Effective fishing time also increased thanks to faster hauling and shooting (up to a 225% increase) and less gear failure, as detailed in Chapter 1 and in EVOMED project [14]. Using the example in Chapter 1, hauling speed for 1100m of cables in past was approximately 34 min, while today its 14 min. If 4 hauls are performed in a fishing day a modern trawler will have gained approximately 80 minutes of fishing time thanks only to hydraulic drums. One fishing day is still the unit of effort, but in 1920 effective trawling hours could have been 8 per fishing day, while today it could be 10. In our models this trend is clear but not robustly quantifiable. Nor is the effect of underestimating modern effort accounted for. Thus it contributes to overestimating modern LPUEs. When LPUE is kg/fishing hour, this temporal bias should be less pronounced since hauling time doesn't enter in the estimation of effort.

Several assumptions had to be made concerning vessel engines horse power. Based on Chapter 1 and 2 we inferred that pair sail trawlers must have had, under good sailing conditions, propulsion equivalent of 40 HP. This value was assigned to all sail trawlers and

used in the GAMMs LPUE standarization. No alternative estimates are available, however, in the Blanes series, small trawlers exist with $HP < 30$ and this may indicate that assigning 40 HP to historical sail trawlers might be generous. Additionally it is well documented that the true HP of trawlers in Spain and France is under declared. There has been a legal limit in Spain since the 1980s and in France since the 1970s. The large spread of residuals around the legal limit of 436 HP is very clear in the French model smoother estimate for HP effect (top right panel in Figure 4-19) and could indicate that many trawlers declaring the legal limit are also fishing much more than the mean trawler of 430 HP. Local experts, in the case from Blanes, have suggested that a correction factor of 2x would be appropriate for HP of most recent trawlers (F. Maynou, personal communication) but also see Bas et al. (2003) [57]. Therefore in the models there is uncertainty about the inferred HP of sail trawlers but also about the HP of modern trawlers. Given the general slope of the relationship between LPUE and HP it is clear that an under declaration of HP is returning more optimistic standardized LPUEs in the modern data, at least for France at Spain.

Estimates of fishing power for Mediterranean trawlers don't exist to date, with the exception of the increase in swept area derived in Chapter 1. In a recent paper [234], based only on data from the last 10 years, the effect of the inclusion of vessel gear characteristics and vessel effect on catch rates was tested. It was found that in most cases HP is a weak predictor (ballard pull is considered better) while gear information (ground rope type and headline length) explain more residual deviance [234]. However no coefficients for gear parameters are reported in the paper and the inclusion of vessel effect as a fixed effect could not allow the estimation of parameters that are valid at population level.

In our analysis a proxy for fishing power was introduced as a model offset, this parameter, A_1 , represents the increase in trawl net horizontal opening by gear type and represents a good proxy for describing the effective trawl net size (Figure 4-14). In fisheries independent surveys similar parameters are used to standardize the CPUEs by assuming that catch is proportional to the net size times the swept path [235]. The trend in A_1 shows the effect of holding HP constant and changing the trawl and rigging material: effective swept area increased 2.34 times with the switch from hemp nets in the 1950s to polyammide nets in

the 1990s. Similar results and approaches have been applied in the Atlantic, but using only net dimension and not estimated gear performance. Eigaard-Muchncen Petersen proved a direct relationship between vessel HP and Pandulus net size [188].

Using A_1 as an offset is equivalent to dividing LPUE by swept area (A_1), not a minor assumption, however, such an approach has been used before by Bishop et al. [236]. Marchal et al. [139] concluded that adjusting fishing effort using gear descriptors may generally improve the relationship between fishing effort and fishing mortality. In our case parameters emerging from trawl gear are used to improve the precision of effective effort (fishing day + a proxy for gear size). Of course, one assumption is made when we use A_1 as an offset for hundreds of trawlers across the Mediterranean. That is, that the nets used to estimate A_1 are representative of the whole population of Mediterranean trawl gears. We used 141 dynamic gear performances from 11 different nets in different periods and argue that these are representative of the general evolution of trawl gear in the Mediterranean, throughout which, as shown in Chapter 1, there has been historically much exchange of technological improvements. The A_1 offset is derived from gear size but could be any parameter that corrects for fishing power. Figure 4-14 shows how A_1 was applied over time and what different scenarios would look like of yearly increments of fishing power (0%, 0.5%, 1% and 2% per year) having 1920 as a reference. We consider A_1 as a scenario comparable to a 1% yearly increase in fishing power, which is what was estimated in the Sète trawl fishery from 1985 to 1999 [223].

The literature returns estimates of fishing power increase in the demersal trawl fishery of 3% per year in the US Pacific coast ground fishery for 1982-1989 [237], and 4% for cod fishing efficiency in the North Sea from 1963 to 1973 [238]. These should probably be updated to make them compatible with trawlers after GPS was introduced at the end of the 1980s, since more precise navigation using GPS has been reported to positively affect catch rates [236]. Hvingel argues that, in the Canadian shrimp fishery, further improvements in catching power, although not quantified, derived from the introduction of trawls with reduced water resistance [239].

It was explicitly decided to not include estimates made in section on fishing power change as corrections for fishing efficiency, although it would have been acceptable [221]. In practice, irrespective of trawler type, the time series from 1900 to 1960 set catching power equal to 1. In practice, after accounting for HP, a pair sail trawler is considered like a post WWII motor trawler: no account is made for having to haul nets by hand on sail trawlers while motor trawlers employ mechanical winches. Additionally trawlers that can fish to a maximum depth of 100 m are treated the same as trawlers that can fish at least 3 times deeper. The decision not to use correcting factors was conservative so as not to include too many a priori offsets, even if reasonably grounded. It was estimated that a motor trawler catches 3.9 times more than a pair sail trawler with an auxiliary engine and that a sail trawler with engine catches approximately 1.4 more times than a pair sail trawler without an engine. Had these coefficients been applied, the historical LPUEs from sail trawlers should have been multiplied x5, making the decline since the beginning of the 20th Century much steeper than what is already estimated. In this perspective the use of A_1 as offset should be seen as very conservative and representative of the best, and smallest, case scenario of increasing catching power. The greatest increasing catching power scenario was not built since it would be almost speculative, but in the interpretation of these results, it should be considered.

4.6.4.2 Effect of fishing areas

The lack of detailed spatial data for the LPUEs, apart from landing port, can introduce important biases and is one of the biggest concerns in LPUE/CPUE standardization. For recent LPUEs (kg/hour) in the Sicilian Channel some tow positions are known but not for the oldest ones; thus models did not include a spatial structure. The problem of not having detailed information on fishing grounds introduces potential confounding. The main risk is interpreting upward spikes in LPUE as increases in demersal stock biomass when it actually results from the exploitation of new virgin grounds that yield high catches in the first phase. In the Figure 4-44 for the longest series there are two peaks, one in the 1920s and one at the beginning of the 1960s. These two periods correspond, at least temporally,

with the beginning of mechanized trawling (1920s) and the switch to synthetic netting material and the entrance of trawlers larger than 150 HP that were capable of reaching fishing grounds between 200-400 meters deep (1960s). It is likely that spikes in standardized LPUEs are related to new technological improvements. On the one hand, the new technologies increased fishing power and on the other hand, they allowed access to previously unexploited fishing grounds as described in the literature [225, 57, 226, 240, 241].

A well known property of commercial LPUEs and CPUEs is that of being biased when fishing grounds are under expansion [41, 242, 243], which is the case in the analysis of the 100 year data set from the western Mediterranean. Trawling capacity has been steadily increasing from 1900 to the early 1990s, with a temporary drop around WWII. From analysis of the fitted model emerge temporal increases in LPUE in the All Mediterranean, like the peaks in 1920 and 1960, that are difficult to justify with an increase in demersal stock size when fishing mortality was constantly increasing, as shown in Chapter 2. It is thus much more likely that all upward trends in LPUE were due to expansion of fishing grounds and improved technology. This hypothesis should be formally tested.

Surprisingly, a WWII effect is hard to detect from the all Western Mediterranean trend in LPUE (Figure 4-44). This effect has been well described in the North Atlantic and would be expected in the Mediterranean as well since it saw practically no trawling between 1940 and 1947 due to confiscation of trawlers for military operations and the danger of mine fields [244, 181]. One explanation comes from F. Doumenge and the way he collected the data from the period 1940-1955 [8]. He acknowledged the fact that in areas that had been closed to fishing for 5-7 years, catch rates would be unstable and declining. Thus he chose a time lag of 5-10 year after the war. This lag falls in different periods in Spain, where the civil war lasted until 1938-39 and fishing resumed in 1940 [12], and in Italy and France where fisheries resumed after 1946 [8]. Since most of the data around WWII come from Spain, this is what enters the model and this regional influence informs this part of the dataset. Concerning the WWII effect, some clear signals can be picked up from the Porto Torres LPUE (Figure 4-4) and in some LPUE data from the former Yugoslavia (Figure 4-7).

4.6.4.3 Effect of discard rates

Throughout this chapter we have modeled trawler LPUEs in time, assuming that the discard rate was constant over time. Since no studies are available, especially for the historical data, we rely on basic information gathered from interviews with old fishermen. In the EVOMED project [14] discarding practices were investigated through fishermen's interviews and cover a temporal period of 1950-present. We summarize the qualitative results by area. In Catalonia, according to fishermen, discarding commercial species increased over time mainly due to the low prices of some species, however no discard rate was given. Over time a shift in targeting from coastal to deeper water species occurred. In Tuscany, the main target species have been stable over the past 50 years, with the exception of blue whiting. Discard rates of commercial species were zero in the 1950s but increased with time due to low prices for some species or landing restrictions for undersized specimens. In the Adriatic the main target species remained overall the same, while targeting horse mackerel and cuttle fish decreased in favor of Norway lobster and mantis shrimps. The composition of the discarded species remained substantially the same over time.

The extent of discarding was not explicitly investigated in the EVOMED interviews, but rather the reason for discarding was explored. Discarding explicitly referred to marketable, not unmarketable species. This is important since what is considered marketable has been rather stable for the most important commercial species. While discarding has increased over time, albeit by an unknown amount, it should be kept in mind that discarding practices existed before WWII, and some early accounts were reported in the 18th and 19th centuries [168, 110]. Today discarding practices are still highly variable and affected by a multitude of factors.

Historical and contemporary discarding practices should be better investigated. It introduces additional uncertainty in the results of the current study, however if discarding has changed, it pertains to very few commercial species, thus its impact will not be on the orders of magnitude of the decline of LPUEs. Additionally, quantitative inspection of species composition in the French case study, where historical LPUEs are known, suggest that species landed in the past are still landed in the present. A notable exception are

some elasmobranchs, for which collapse [14, 195, 65] rather than discard is a better explanation.

4.6.4.4 Conclusions

These analyses were the first attempt in exploring modern and historical Mediterranean LPUEs in a systematic way. The first achievement has been the construction of a unique database covering a time span of more than a 100 years for the most important fishing areas in the Western Mediterranean. It has been an exploratory research with no prior study giving any guideline or insight into what has happened in the past. Modeling heterogeneous and unbalanced data presented multiple challenges, and some assumptions, all explicitly written out, had to be made.

Deriving some estimates of fishing power was key to understanding and being able to compare LPUEs from such different phases of the fisheries. When incorporating fishing power correction a conservative approach was taken, despite evidence that fishing power increased more than what was used in the models. The result is a steep and dramatic decline of commercial demersal species LPUEs. The farther back in time we went, the larger the decline, albeit with increasing uncertainty in our historical estimates. This is strong proof of the shifting baseline syndrome in the Mediterranean Sea and it shows a notable impact on demersal stock already before WWII. Additionally it proves how much we cannot rely on recent data to understand true ecosystem carrying capacity.

4.7 APPENDIX 4

Owner	Catch (<i>libbre</i>)	Kg(1 <i>libbra</i> =0.327 kg)
C. Antonucci	33630	10997
D. Fortunati	39234	12830
D. Tombolini	58631	19172
F. Moscone	31406	10270
Fantoni	59065	19314
Fantoni	42690	13960
Fantoni	55595	18180
Fantoni	69270	22651
G. Galli	37614	12300
G. Giostra	40375	13203
G. Tuda	40142	13126
G. Tuda	46984	15364
G. Tuda	55473	18140
L. Marchese	28772	9408
N. Pasqualini	30519	9980
P. Bazzani	31890	10428
P. Bazzani	25214	8245
Rocchetti	45464	14867
Rocchi	63722	20837
S. Accurti	26651	8715
S. Paoletti	32444	10609
S. Pericoli	18690	6112
V.Panfili	41761	13656

Table 4.9. Pair Sail Trawler catch in 1779 in Porto Fermo listed by owner, from [7]. The catch in *libbre* is converted to kg.

year	landings kg	landings <i>arrobas</i>	N. trawlers	months fishing	LPUE*
1792	265586.76	21213.00	16.00	6.00	2.77
1793	388468.06	31027.80	16.40	6.00	3.95
1794	327901.18	26190.19	16.81	6.00	3.25
1795	242589.15	19376.13	17.23	6.00	2.35
1796	347213.40	27732.70	17.66	6.00	3.28
1797	375663.85	30005.10	18.10	6.00	3.46
1798	390881.91	31220.60	18.56	6.00	3.51
1799	350398.99	27987.14	19.02	6.00	3.07
1800	460084.96	36748.00	19.49	6.00	3.93
1801	399558.27	31913.60	19.98	6.00	3.33
1802	357698.78	28570.19	20.48	6.00	2.91
1803	473132.05	37790.10	20.99	6.00	3.76
1804	506129.76	40425.70	21.52	9.00	2.61
1805	460498.12	36781.00	22.06	9.00	2.32
1806	480939.52	38413.70	22.61	9.00	2.36
1807	441056.31	35228.14	23.17	9.00	2.11
1808	522997.96	41773.00	23.75	9.00	2.45
1809	503566.92	40221.00	24.35	9.00	2.30
1810	424140.04	33877.00	24.95	9.00	1.89
1811	254231.12	20306.00	25.58	9.00	1.10
1812	432054.81	34509.17	26.22	9.00	1.83
1813	330617.77	26407.17	26.87	9.00	1.37
1814	196878.63	15725.13	27.55	9.00	0.79
1815	372582.68	29759.00	28.23	9.00	1.47
1816	458945.64	36657.00	28.94	9.00	1.76
1817	472306.86	37724.19	29.66	9.00	1.77
1818	189875.82	15165.80	31.00	9.00	0.68
1819	103127.24	8237.00	31.00	1.20	2.77

Table 4.10.

Maritime Province	Trawl Ban	Year	Catch (Kg)	Year	Catch (Kg)
Cadix	No	1831	1,095,225	1861	2,342,137
Sanlucar	No	1831	450,237	1861	1,070,050
Huelva	No	1831	896,475	1861	2,818,525
Malaga	Yes	1831	660,925	1861	7,778,162

Table 4.11. Comparison of fish landings in areas of Spain where trawling was banned over the period 1831-1861 (Malaga) with areas where trawling was not banned (Cadix, Sanlucar and Huelva)

Power	Name	NT	GRT	HP**	Owner	Port	N.FD	Kg	Kg/FD
Steam	Tempesta	45	104	244	Ricotti G.		16	34250	2140
Steam	Nanuk	32	102	244	Ing Ricotti		16	30077	1879
Steam	Giovanna	125	235	244	S. P. Italica	Genova	15	32600	2173
Steam	Claretta	57	118	244	M. De Santi	Roma	42	71563	1703
Steam	Messaggero	105	124	244	M. De Santi	Roma	36	67445	1873
Steam	S.Giuseppe	26	86	244	Del Gotto	Torre Greco	28	27800	992
Steam	Folgore	101	199	244	N.		10	37100	3710
Gasoline	Idria	90	104		Dott. Licciardelli	Catania	3	19000	6333
Steam	Costante	81	147	244	Severino	Catania	15	48000	3200
Steam	S.Romolo	65	150	244	Bonaccorso A.	Catania	22	45000	2045
Gasoline	M. Carmine	9	50		Facone V.	P.Empedocle	20	13675	683
Steam	Zara	79	145	244	D.Cappuccio	Siracusa	9	26500	2944

Table 4.12. Total catch of Italian trawlers fishing in the Sicilian Channel South of Lampedusa in the summer of 1926, according to Ermirio [6], NT= Net Tonnage, FD= fishing day

Month	Day	I Cat	II Cat	Total Kg
july	4	30	50	80
july	5	20	20	40
july	6	42	35	77
july	7	36	64	100
july	9	40	90	130
july	10	38	62	100
july	11	73	60	133
july	12	25	25	50
july	13	38	27	65
july	14	38	53	91
july	17	40	40	80
july	18	64	61	125
july	19	15	15	30
july	20	40	25	65
july	22	30	20	50
july	26	34	36	70
july	27	34	39	73
july	28	25	25	50
july	30	18	22	40
july	31	16	20	36
august	2	15	25	40
august	3	25	35	60
august	4	40	36	76
august	5	40	75	115
august	6	20	45	65
august	7	30	45	75
august	8	55	50	105
august	9	60	90	150
august	10	30	60	90
august	12	35	70	105
august	13	30	64	94
august	15	45	70	115
august	16	55	92	147
august	17	30	65	95
august	18	40	60	100
august	19	30	50	80
august	20	25	25	50
august	22	20	20	40
august	23	20	46	66
august	24	25	40	65
august	26	30	40	70
august	27	26	50	76
august	28	20	62	82
august	29	28	50	78
august	30	32	62	94
september	1	30	60	90
september	2	35	50	85
september	3	20	45	65
september	4	40	66	106

Vessel name	Length	HP	Fishing depth
La Gracieuse	18	120	150-180
Madeleine	13-15	75-90	30-100
Pierre Denise	13-15	75-90	30-100
Ideal	13-15	75-90	30-100
Gabriel Bertrand	13-15	75-90	30-100
Paul Alain	13-15	75-90	30-100
Fezzara	13	75	
Saint Francis	9-10	36-39	
Hirondelle	9-10	36-40	
Espadon	10	40	
Corsaire	10	40	
Hugette		120-150	
Marie-Yvonne Simone			
Zoriona	16	100	

Table 4.14. Characteristics of the Pt. Vendres trawlers in 1951-1952, from Doumenge [8, p.69]

HP	wing spread m	tow speed	tow duration(H)	number tows/day	swept area/day
25-30	4	1.5	1.3	2	33,335
50-60	6	2	2	2	88,901
90-100	9	2.5	2.3	2	208,350

Table 4.15. Characteristics of the Pt. Vendres trawlers in 1951, from Doumenge [8, p.71]

CHAPTER 5

LONG-TERM TRENDS IN ABUNDANCE OF DISAGGREGATED DEMERSAL SPECIES

5.0.1 Introduction

While most older LPUE data are aggregated by total catch per fishing day, there are exceptions where single species or species groups can be identified at the fishing trip level by individual boat. This is the case for data gathered between 1950 and the present in the ports of Blanes and Barcelona (Spain), Port Vendres and Sete (France) and Porto Santo Stefano (Italy). In this chapter we built a case study with the data from Catalonia alone, since they offer the best temporal span and species coverage. For Blanes one specific analysis was performed on each species of commercial importance such as Mediterranean hake (*Merluccius merluccius*), red shrimp (*Aristeus antennatus*), blue whiting (*Micromesistius poutassou*) and red mullets (*Mullus* sp.). An initial partitioning of the fishing trips identified relevant LPUE data, which was then standardized with GAMMs. Results show steep declines in the analyzed species that are comparable with the declines in total biomass from Chapter 3.

5.0.2 Metier and Clustering

Mediterranean trawl fisheries are by definition mixed species, where more than a hundred species have commercial value, both historically and at present. The fishery relies on nets with very small meshes (40-60 mm) that are highly indiscriminant and retain almost everything in the trawl path. Data are recorded at landing. Fishermens logbooks are only required to record individual species catches higher than 50 kg and they contain no spatial information about catch areas. Additionally VMS data are so sensitive that they are impossible to access for scientific research, but these would be unavailable for the historical

data in any case. Therefore, describing a skipper's fishing tactics is extremely difficult, past or present.

The lack of spatial information generates a particular set of problems. Most significant, a trawler can fish in deep waters or in shallow coastal waters and thus on two distinct habitats and fish assemblages. Having thousands of daily records of individual fishing vessels is a great opportunity to estimate trends in relative abundance, but first, understanding which data should be modeled is essential. A selection exercise needs to be made, as objectively as possible, to subset the LPUEs and retain a set that is homogeneous and coherent with the habitat for the species being analyzed. The goal is to capture similar clusters of fishing trips allocating a directed effort to a certain assemblage of species. As an example, if the LPUE of a deepwater shrimp is to be standardized, then only fishing trips with trawling on the slope and in deep waters should be retained, otherwise LPUEs from the shelf would return biased estimates. Bias would be caused by zero catches of deepwater shrimp on the shelf, the wrong habitat. These false absences are so called fake zeros [232]. LPUEs with many fake zeroes would not be informative on the abundance of a given species, nor be useful for deriving reliable standardized indexes.

A second motivation for clustering fishing trips is to identify the fishing strategy of a trawler and to select, for each individual species, the metier in which there was clear targeting so that effort would be accounted for correctly. The amount of effort allocated to a favorable habitat should be quantified, otherwise, if targeting varied on a year to year basis, spurious LPUEs could be derived [245]. Modeling a by-catch species could be risky as well: unaccounted shifts in targeting could change the LPUEs and, consequently, bias any estimation.

The goal here is sub-setting the LPUEs to separate comparable from non-comparable fishing trips [246].

Several methods for achieving data separation have been used ranging from subjective expert opinion to advanced models such as a logistic regression that predicts the probability of the presence of the target species based on the presence/absence of other species

[245]. Braccini et al. (2011) showed that the LPUE discriminating criterion directly affects the resulting standardized CPUEs [246], therefore this step is critical for the results.

In the Mediterranean, following the Braccini et al. [246] approach would be difficult due to the more than 50 potential target species, so it was not attempted. Instead we chose to rely on multivariate approaches like partitioning methods. The goal remains the same, but it relies on a different discriminating criterion. The identification of the habitat/fish assemblage and targeting relies on clustering and the goal is to identify different metiers. The term metier, popular in European data collection, is meant to essentially identify targeting specific habitat/assemblages with a specific gear [247, 248].

The discriminant analysis relies on the CLustering LARge Applications (CLARA) approach, in its R implementation via the *cluster* package [249] and *clara* function. The CLARA approach has been tested and routinely applied [250, 248, 251], and is considered to perform well [247].

Given the presence of two temporally segregated datasets for the same area (Blanes, Catalonia), separate discriminatory analyses were performed to avoid the confounding of a temporal gap. Once the appropriate level of clustering was decided for the species to be modeled, metiers were selected that were representative of the correct habitat and consistent with the mode of targeting. Here, selection consisted in sub-setting for the fishing trips falling within chosen clusters in both the old and modern periods. With the subsetted data, an LPUE standardization with GAMMs was performed similar to that in Chapter 3.

5.1 Data description

5.1.1 Blanes 1956-present

In the port of Blanes (Catalonia, Spain) detailed landing statistics from individual trawlers have been collected daily by boat for the historical period between 1956 and 1965 and for the modern period between 1997 and 2009. Historical data were registered by dock sampling by C. Bas, and both datasets were provided by F Maynou of ICM in Barcelona. The data distinguish 130 species or species groups overall, although each species is not always present in both periods. In the decade 1956-1965, 39 different trawlers operated as a group,

however never all at the same time. Vessels characteristics reported for both periods include year of construction, length, boat name, GRT, HP and type of gear. For some boats there are missing parameters and incorrect years of construction. In addition, since 1989 a legal limit exists on the maximum of 500 HP of trawl vessels.

In Barcelona, daily landings are available only for 1961 and 1962, the old period, and for 1992-2009, the modern period. Unfortunately, during the old period the large number of sales occurring at the same time made it impossible for the observer to record data for most individual species. The exceptions are Mediterranean hake, red shrimp and blue whiting. Historical data report the kg of catch sold and kg of catch unsold, without specifying species composition. The same parameters have been recorded for vessels and under-reported HP of boats built after 1989 is widespread. Because of low species resolution and short temporal span, the Barcelona data were not incorporated in this analysis.

Trawler characteristics for both periods are summarized in Figure 5-9-5-10. In the 1950s, nets were traditional Mediterranean trawls made of cotton with low openings at the mouth of the trawl (1m), for details see Chapter 1 and Bas (1955) [12]. While some vessels from the historic period still fish today, modern vessels have switched to high vertical opening (up to 4-6 m high headlines) trawl nets made with synthetic materials [57].

The fishing depth in 1955, according to the description of gear and fishing grounds by Bas [12], did not exceed 480 m but more commonly went down to 200 m given the limitations of the cable wheels.

Bas described the fishing grounds of Blanes in the 1950s: Vol de Tossa (≈ 30 m), Les Garotes (50-80m), Els Capets (≈ 80 m), Rocassa- Can Ferre- Turó (320-480m), La Planassa (88-144m), Sot de la Gamba (≈ 480 m), Penjant de fora de la Planassa, Le Creu (≈ 480 m), La Melica (isobaths of 480m). Modern fishing grounds are much deeper and tows can reach 800-900 m depth [57, 252, ?].

Vessel information was collected and cross-checked using two sources: Bas et al. (2003)[57] and the Spanish online vessel database (<http://www.mapa.es/es/pesca/pags/flota/censo.htm>). Vessel names were standardized and species names were checked and uniformed to a 7-digit code commonly used MEDITS encoding.

5.2 Methods

5.2.1 Identification of targeting, CLARA

Different methods for clustering and partitioning are available in the literature as well as from R packages. However data dimension can favor one method over the other: partitioning methods and principal components analysis are computationally intensive. This is particularly true when modeling raw LPUEs as the data matrices can be particularly large and needing a lot of RAM memory to allocate large vectors. For this analysis, data matrices of 150 species and 12279 fishing trips for the old period and 150 species and 50565 fishing trips for the modern period, would have crashed other R similar functions that don't subsample the data, like *hclust*, *dist*, even running on a 64-bit Linux machine. The choice of CLARA was obvious.

Kaufman and Rousseeuw (1990) [253] developed the CLARA algorithm explicitly for dealing with large datasets. It first clusters a sample of the data and then assigns all objects in the dataset (in this analysis, the fishing trips) to these clusters.

Separate partitioning was applied for old and modern data. Data were transposed so that each row represents one fishing trip of one vessel and each column is a species. NA cells were changed to zero and row-wise scaling was applied as recommend in combination with Euclidean distances. Different clustering (where K represents the number of clusters) were applied, $K = 4 : 13$ and selection of the most appropriate classification of clusters was based on silhouette profiles and maximum average silhouette widths (s_i). Since CLARA relies on subsampling, different levels of sampling and sample size were tested.

```
# CODE OF CLARA PARTITIONING IN MODERN BLANES SERIES
bnew # Dataset for the modern Blanes data.
bnew[is.na(bnew)==TRUE]=0
bnew$kgtot<-rowSums(bnew[,16:170]) # sum of the weight of all species in each fishing trip
bnew<-bnew[,16:170]/bnew$kgtot # Divide each cell weight by the total weight in %
bzeroN<-cbind(bnew1, bnew[,1:15]) # in % weight
bzeroNkg<- bnew[,1:170] # in raw untrasformed weight

#test different clusters and pick the best one OLD DATA with data SCALED TO %
bzeroclara4N<-clara(bzeroN[,1:155], 4, metric = "euclidean",stand = FALSE, medoids.x = F ,
  sample = 50, sampsize = 500,keep.data = F) #seems to be the best although silhouette
width is same to k=5 but cluster look better
bzeroclara5N<-clara(bzeroN[,1:155], 5, metric = "euclidean",stand = FALSE, medoids.x = F ,
  sample = 50, sampsize = 500,keep.data = F) #
bzeroclara6N<-clara(bzeroN[,1:155], 6, metric = "euclidean",stand = FALSE, medoids.x = F ,
  sample = 50, sampsize = 500,keep.data = F)
```

```

bzeroclara8N<-clara(bzeroN[,1:155], 8, metric = "euclidean",stand = FALSE, medoids.x = F ,
  sample = 50, sampsize = 500,keep.data = F)
bzeroclara10N<-clara(bzeroN[,1:155], 10, metric = "euclidean",stand = FALSE, medoids.x = F
  ,sample = 50, sampsize = 500,keep.data = F)
bzeroclara12N<- clara(bzeroN[,1:155], 12, metric = "euclidean",stand = FALSE, medoids.x = F
  ,sample = 50, sampsize = 500,keep.data = F)

#CHOSE THE BEST CLUSTERING
plot(bzeroclara5N) # is best one

# GET CLUSTERING VECTOR AND PASTE IT TO ORIGINAL DATA AND CHECK WHAT IS SPECIES PROFILE
clusteringN<-bzeroclara5N$clustering
bzeroclustNpercent<-cbind(bzeroN, clusteringN)
bzeroclustNkg<-cbind(bzeroNkg, clusteringN)

```

Once the best set of clusters was determined, based on individual species rankings, the most appropriate clusters were selected (thus a subset of fishing trips) and the LPUEs were standardized.

5.2.2 LPUE standardization with GAMMs

Standardization of commercial catch is important when relative indexes of abundance such as CPUEs are used as input to stock assessment. The goal is to standardize in order to reduce the confounding between change in stock abundance and change in fishing power [5].

Here, the goal of standardization is to obtain an appropriate LPUE estimator that is representative of fish population density and rate of change over time. A wrong standardization would yield spurious results in terms of assessment and management advice [5]. Fish stock decline risks being underestimated due to unaccounted increase in fishing power that makes the CPUEs hyperstable [41].

Historically, standardization approaches have been differentiated by basic decisions about whether to assume catchability is constant, or attempt to estimate it. The most recent methods for CPUE standardization consist of either correcting with fishing power coefficients the catch rates of the fleet by comparison with a standard vessel, or comparing CPUEs from multiple sources taking into account various factors affecting catch rates. The latter are statistical models such as GLMs, GAMs and mixed models effects. In recent years important advancements in the field of mixed models effects [156] have made them a very powerful tool that can be used for CPUE/LPUE standardization.

Mixed effects models offer important analytical options because they are flexible but at the same time have parameterization that is strongly controlled. Typically, a group of related parameters enters the model as a single random term. The model now focuses not on the separate parameters, as would be the case for the fixed effects model, but on the variance component, the variance of the distribution from which the parameters are assumed to come [242]. In mixed models, fixed effects could correspond to the effect of treatments, but more generally are parameters associated with the system under study (e.g. average density, growth rate, instantaneous rate of natural mortality). Mixed-effects models use the concept of random effects to emulate the randomness inherent in the data and can reduce the problem of pseudo replication caused by time series data [254].

Hesler *et al.* modeled survey and commercial CPUE using mixed models and argue that, in principle, vessel or the interaction *vessel x year* should be modeled as a random effect because not doing so would negatively bias the variances associated with the biomass index [230]. In their analysis the authors consequently pool CPUEs from the survey and from the commercial vessels arguing that vessel coefficients arose from the same common distribution of random effects.

LPUE data has been recorded by daily fishing trip. This data structure implies that within each boat there are correlated repeated measures. As this violates the regression model assumption of data independence we cannot use GLMs to estimate parameters this would result in potentially biased estimates [156]. GLM would increase the risk of Type I errors in particular when there is strong auto-correlation within the subject [232]. In the case of multiple vessels, considering vessels as a random effect saves many degrees of freedom that would be otherwise taken by the random effect of each individual vessel in a GLM. To account for within subject correlation it is necessary to use mixed effects models that allow a random slope and intercept, which take the correlation within boat into account.

The data are disaggregated at individual vessel, fishing day and species. Vessel parameters are known, although highly collinear, but gear and rigging are not known at vessel level. In general in the historical period (1940-1960), nets were of natural fibers with

low vertical openings [125, 20, 137, 123, 13]. Doors were made of wood with steel reinforcements and there were few navigation devices. In the modern period, nets are made of synthetic filaments, in some cases with high vertical opening, and the doors can be of polyvalent steel.

In R 2.15 [255] we used the *bam* function (package *MGCV*) to fit Generalized Additive Mixed Models (GAMMs) with a random intercept on vessels. Since vessel information available, such as HP, GRT and vessel length, are highly correlated, only HP was retained to avoid multi-collinearity and confounding [5]. Additionally several vessel lengths were missing. The weight in Kg of the species caught, the only information available, was modeled in log scale, plus a small amount to avoid negative values, using a Gaussian family distribution. Year, month, day, year of construction were used as covariates; HP was used as a continuous variable; boat material, a dummy variable (*dumn*) as in Chapter 3, and boat name were used as factors. The swept area coefficient, or catching power, A_1 , was used in log scale as a model offset as in Chapter 3. For detailed description of these assumptions and consequences, see the prior discussion.

Different models were fitted and selected in order to find the lowest AIC and the best residuals. Maximum likelihood (ML) estimation was used for model fitting and comparison with AIC and REML was used for parameter estimates of best candidate model. Different knots (k) were tested as well. In particular, whether random intercept, or random intercept and random slope had better AIC was not tested. It was deemed necessary to keep boat as a random effect as well as the offset parameter, unless this created numerical problems to the model fits.

5.3 Results

5.3.1 Partitioning

Fishing trips partitioning applied with CLARA to old and new data showed marginally different clustering. In the old data, a partitioning was chosen based on 5 clusters ($K = 5$) which displayed an average silhouette $s_i = 0.33$. With $K = 4$ average silhouette was slightly better, $s_i = 0.35$, but it was discarded since for cluster $j = 1$ $s_i = 0.11$, meaning a

bad identification of this cluster. With $K=5$ instead $j = 1$ $s_i = 0.24$. Silhouette plot of old Blanes data is summarized in Figure 5-1).

The modern data partitioning similarly shows the best silhouette $s_i = 0.31$ with $K=5$. Cluster $j = 2$ is poorly identified but the other 4 have good silhouettes, with few erroneous assignments of fishing trips ($s_i < 0$) (Figure 5-2).

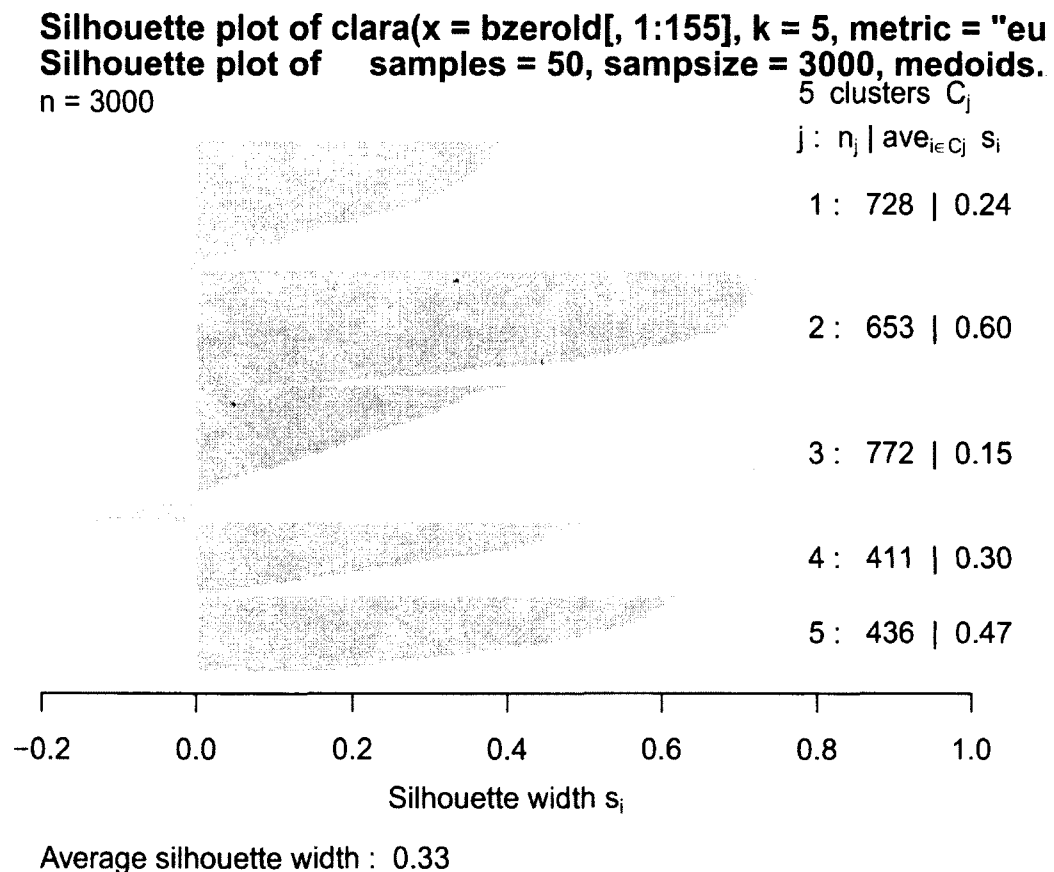
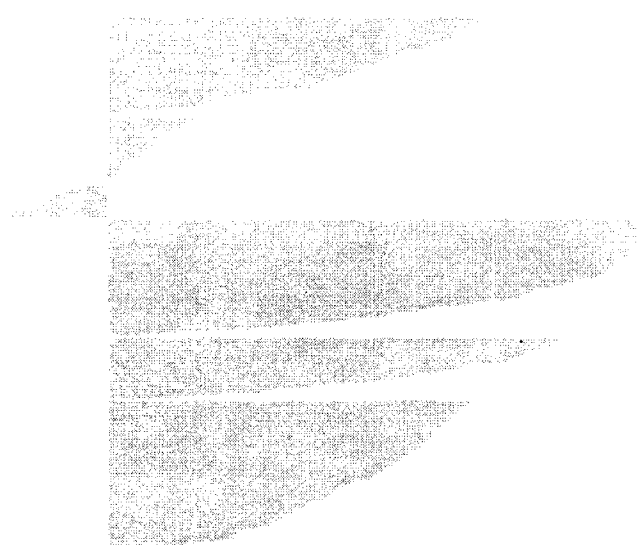

Figure 5-1. Silhouette plot old data Blanes (1956-1965)

To identify the species composition in the clusters/metiers for each species the cluster wide mean was calculated on scaled weights. The top ranking 10 species are summarized in Table 5.1-5.2 and can be more easily be compared in Figure 5-3- 5-4 where panels represent clusters. The bathymetric ranges of the top ranking species have been checked in Fishbase.org and in the Mediterranean literature from the Catalan-Balearic area [184, 226, 240]. The species bathymetric distribution was qualitatively used for checking the

Silhouette plot of clara(x = bzeroN[, 1:155], k = 5, metric = "euclidean",
 samples = 50, sampsize = 500, medoids.x = 1:155, medoids.y = 1:155)
 n = 500



5 clusters C_j
 $j : n_j \mid \text{ave}_{i \in C_j} s_i$
 1 : 93 | 0.30
 2 : 96 | 0.008
 3 : 111 | 0.53
 4 : 60 | 0.40
 5 : 140 | 0.32

0.0 0.2 0.4 0.6 0.8 1.0
 Silhouette width s_i

Average silhouette width : 0.31

Figure 5-2. Silhouette plot for CLARA partitioning of the Blanes fishing trips in the modern series (1997-2009).

consistency of the emerging clusters. Table 5.1 reports the top 10 species per cluster and we can describe emerging assemblages from the historical period as:

1. In the first metier, horned octopus *Eledone cirrhosa* (ELEDCIR), red mullets *Mullus* sp. (MULLBAR, MULLSUR, MULLSPP) and *Spicara*, with the exception of red shrimp *Aristeus antennatus* (ARITAN), denote a more coastal fishery (panel 1, Figure 5-3).
2. Metier 2 is clearly targeting *Aristeus antennatus* and other upper slope species in the bathymetric range 400-700 m (panel 2, Figure 5-3).
3. Metier 3 is composed of species belonging to the 250-700 m depth range and is not very different from metier 4 (panel 3, Figure 5-3).
4. In metier 4, catches are dominated by horse mackerel *Trachurus* sp. (TRACSPP), *Scomber scomber*, *Spicara* spp (SPICSPP) and *Boops boops*. The bathymetric ranges of these are, with the exception of some catches of *Aristeus antennatus*, within 100-250m (panel 4, Figure 5-3).
5. Metier 5 is characterized by catches of Blue whiting (*Micromesistius poutassou*, MICM-POU) and other species from the lower shelf and upper slope (panel 5, Figure 5-3).

In summary metiers 1 and 4 are the most coastal, 2 is the deepest one (upper slope) and 3 and 5 are of intermediate depths between 1,4 and 5.

The results of clustering for the modern period (Table 5.2) show the following patterns in species partitioning into the 5 selected clusters.

1. In cluster 1 (panel 1, Figure 5-4) the dominant species are *Micromesistius poutassou*, Norway lobster *Nephrops norvegicus* (NEPRNOR), Greater forkbeard *Phycis blennoides* (PHYBLE), *Merluccius merluccius* and anglerfish *Lophius piscatorius* (LOPHPIS). These species tend to have a wide bathymetric distribution (Hake and Greater forkbeard, in particular) and this cluster is compatible with a depth range of 200-400m.
2. Cluster 2 has many coastal species equally ranking and is representative of coastal fishing 50-150 m deep (panel 2, Figure 5-4); it matches metier 1 in the old series.

3. The species in Cluster 3 clearly identify it as an upper slope (400-800m) cluster where the main target species is *Aristeus antennatus* (panel 3, Figure 5-4). This cluster seems equivalent to Cluster 2 in the old series.
4. In cluster 4, the top ranking species is Blue whiting *Micromesistius poutassou* followed by *Nephrops*, *Lophius* and *Merluccius* (panel 4, Figure 5-4). In particular, extremely large catches of *Micromesistius poutassou* fall in this cluster, and also catches of swordfish (XIPHGAD). In fact, such large catches suggest that some boats may be mid-water trawling. Thus, this cluster will be treated with caution throughout the LPUE analyses of individual species.
5. Cluster 5 is clearly a coastal metier exhibiting targeting of a broad number of shallow water demersal species such as *Eledone cirrhosa*, other fish, *Eutrigla gurnardus* (EUTRGUR) and *Lophius budegassa* (LOPHBUD) (panel 5, Figure 5-4).

K	ELEDCIR	MULLBAR	SPICSPP	MERLMER	URANSCA	SEPIELE	TRISCAP	PLEURONE	LOPHPIS	SEPIORB
1	0.29	0.11	0.07	0.04	0.04	0.04	0.04	0.03	0.03	0.03
2	ARITANT	PHYIBLE	MICMPOU	MERLMER	NEPRNOR	MULLBAR	SPICSPP	ELEDCIR	TRACSP	CONGCCN
	0.75	0.10	0.05	0.01	0.01	0.01	0.01	0.01	0.01	0.01
3	PHYIBLE	MICMPOU	ARITANT	NEPRNOR	MERLMER	ELEDCIR	PLEURONE	SPICSPP	MULLBAR	TRACSP
	0.26	0.22	0.16	0.09	0.03	0.03	0.02	0.02	0.01	0.01
4	TRACSP	SPICSPP	ARITANT	SCOMSCO	BOOPBOO	MICMPOU	MULLBAR	SARDPIL	PHYIBLE	MERLMER
	0.38	0.10	0.09	0.06	0.06	0.06	0.05	0.04	0.03	0.02
5	MICMPOU	PHYIBLE	ARITANT	NEPRNOR	MERLMER	ELEDCIR	TRACSP	TODASAC	PLEURONE	SCYOCAN
	0.61	0.10	0.08	0.05	0.03	0.02	0.01	0.01	0.01	0.01

Table 5.1. Mean scaled weight (kg) per cluster (K=5) for top scoring 10 species from best CLARA partitioning for historical Blanes data (1956-1965).

K	NEPRNOR	PHYIBLE	MICMPOU	MERLMER	LOPHPIS	ARITANT	OTHEFIS	ELEDCIR	LEPMBOS	TRISSPP
1	0.28	0.15	0.14	0.08	0.04	0.04	0.04	0.03	0.03	0.02
2	SCOMSCO	TRACTRA	PAGEACA	OCTOVUL	MULLSUR	MERLMER	OTHEFIS	LOLVUL	MULLSPP	ARITANT
	0.08	0.08	0.07	0.06	0.06	0.06	0.05	0.05	0.04	0.03
3	ARITANT	PHYIBLE	OTHEFIS	MERLMER	MICMPOU	PENASPP	LOPHPIS	PASISPP	TRISSPP	PAPELON
	0.63	0.06	0.06	0.05	0.04	0.03	0.02	0.01	0.01	0.01
4	MICMPOU	NEPRNOR	PHYIBLE	MERLMER	ARITANT	ELEDCIR	OTHEFIS	LOPHPIS	TRISSPP	TODASAC
	0.53	0.07	0.06	0.06	0.04	0.03	0.03	0.02	0.01	0.01
5	ELEDCIR	OTHEFIS	LOPHBUD	TRAHDRA	EUTRGUR	LOPHPIS	MULLSUR	SEPIELE	OCTOVUL	MULLBAR
	0.29	0.12	0.10	0.04	0.04	0.03	0.03	0.03	0.03	0.02

Table 5.2. Mean scaled weight (kg) per cluster (K=5) for top scoring 10 species from best CLARA partitioning for modern Blanes data (1997-2009)

To further explore the consistency of the metiers/clusters and relating the metiers to temporal patterns and fleet components, the following steps were taken. We first explored

the number of fishing days allocated to each metier over the years (Figure 5-5). As number of fishing days is a measure of effective effort it can readily be appreciated that nominal effort has largely increased over time, and this not accounting for vessels HP increase. In the old period metiers 1, 2 and 3 increased over time, metier 1 in particular. Metier 4 declined since 1960 and metier 5 declined around the same period, then rebounded slightly. In the modern data, all metiers seem stable with the exception of metier 2, which halved over time.

Similarly we investigated the monthly distribution of fishing days by metiers (Figure 5-6). In the old series, metiers 3 and 4 seemed to exhibit opposite seasonal fishing patterns, while the others didn't fluctuate much during the year. Modern series fluctuation appeared in metier 2 with a peak in the fall, in metier 3 with a peak in the summer (similarly to metier 2 which is the corresponding *Aristeus antennatus* metier) and metiers 4 and 5, which seem more like spring metiers.

Engine HP of the vessels involved in each metier was plotted over time with a fitted smoother indicating the mean HP per year for each metier (Figure 5-7). In the old period, smaller (in HP terms) trawlers operated mostly in metier 1 (coastal metier), in metier 2, 4 and 5 the mean HP increased over time, indicating that newer and more powerful vessels fished mostly on these assemblages. In the modern period, the smallest vessels fished mostly in metier 5 (coastal assemblage). Metier 1 showed a decline in HP while metiers 2-4 presented no trend in HP.

One important aspect of working with commercial LPUEs is understanding of fishing effort, which is a good indicator of fishing mortality. We computed the classical indicator of nominal effort ($FishingDays * HP$) for the whole demersal fishery based on the available Blanes LPUE data. Additionally since we are adjusting for catching power in LPUE standardization, a corrected nominal effort is: $FishingDays * HP * A_1$ which not only takes into account days at sea and vessel engine power but also catching power (A_1). Figure 5-8 shows the difference between nominal effort and corrected nominal effort. When corrected by A_1 effort is much higher. Irrespective of the scenario of A_1 , effort in the last two decades is much higher than in the 1950s when LPUEs were already declining. Af-

ter 2002 it appears that effort started declining rapidly. However, we need to keep in mind that there is a bias in the effort indicator: number of fishing days is precise but HP is under-declared. Whether or not under-declaration increased after 2002 is unclear and needs to be investigated.

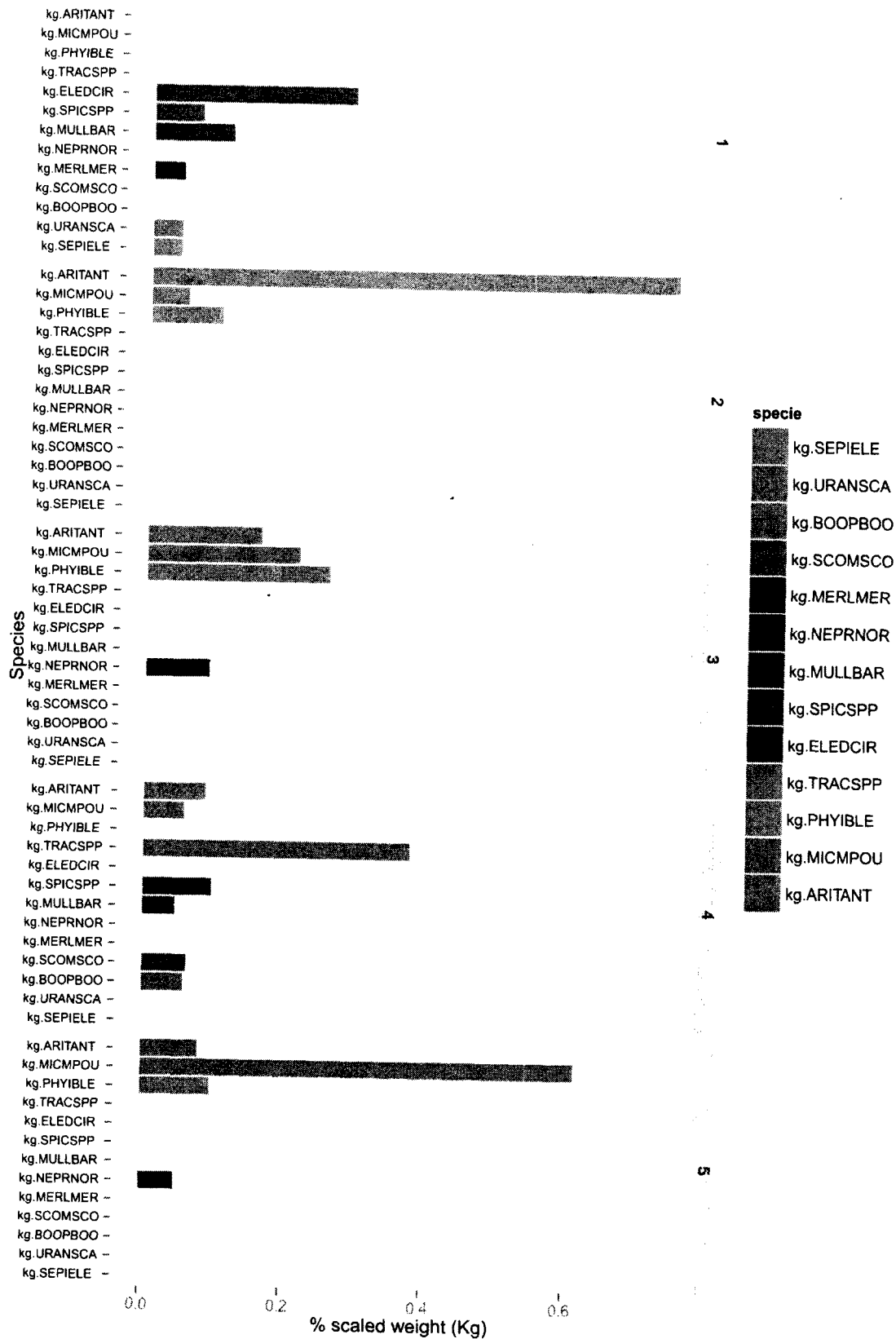

Figure 5-3. Species contribution to each cluster, after CLARA partitioning, given as scaled mean weight per cluster for historical Blanes data (1956-1965). Each panel (1 to 5) represents the corresponding cluster, for readability only top ranking species were plotted.

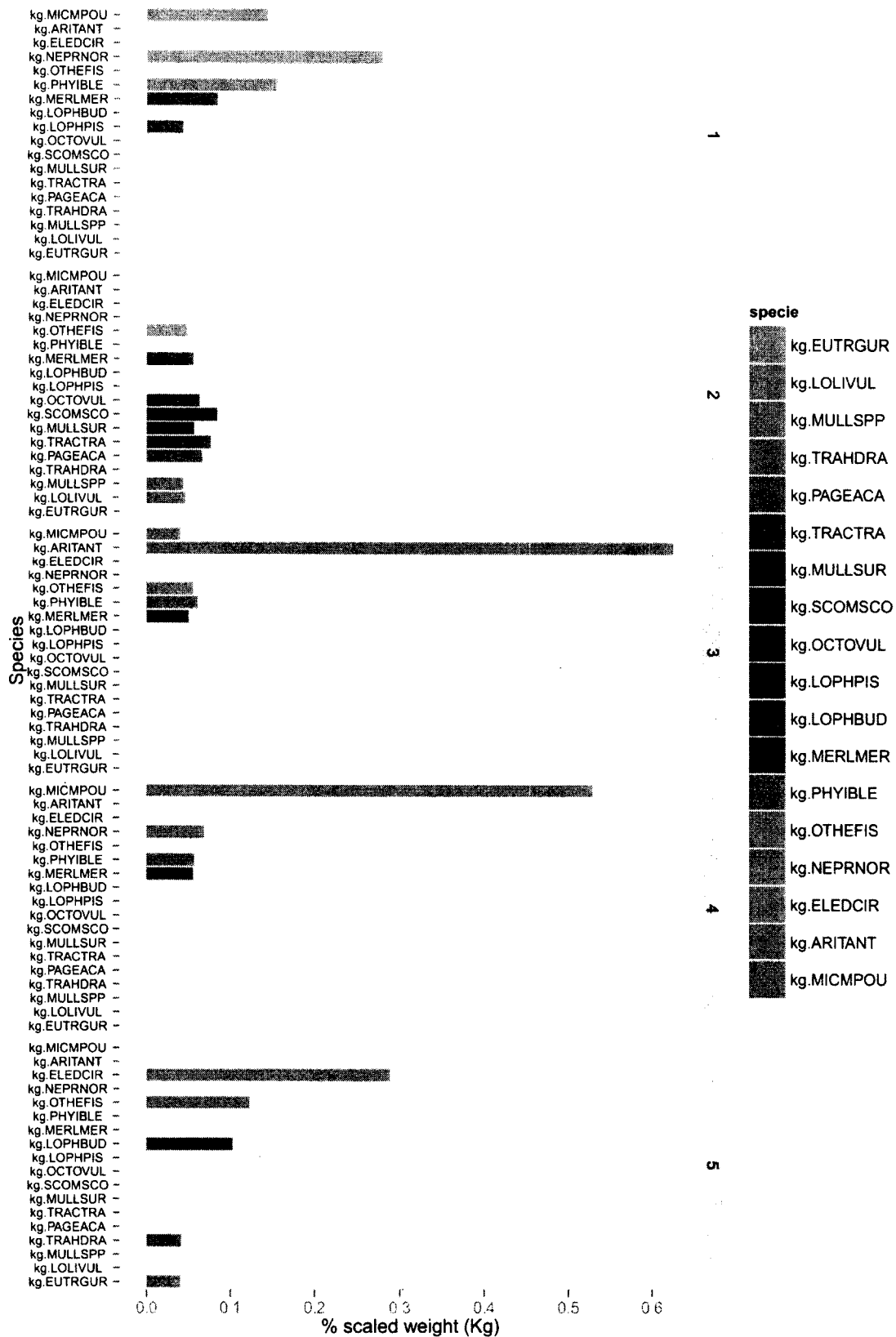

Figure 5-4. Species contribution to each cluster, after CLARA partitioning, given as scaled mean weight per cluster for modern Blanes data (1997-2009). Each panel (1 to 5) represents the corresponding cluster, for readability only top ranking species were plotted.

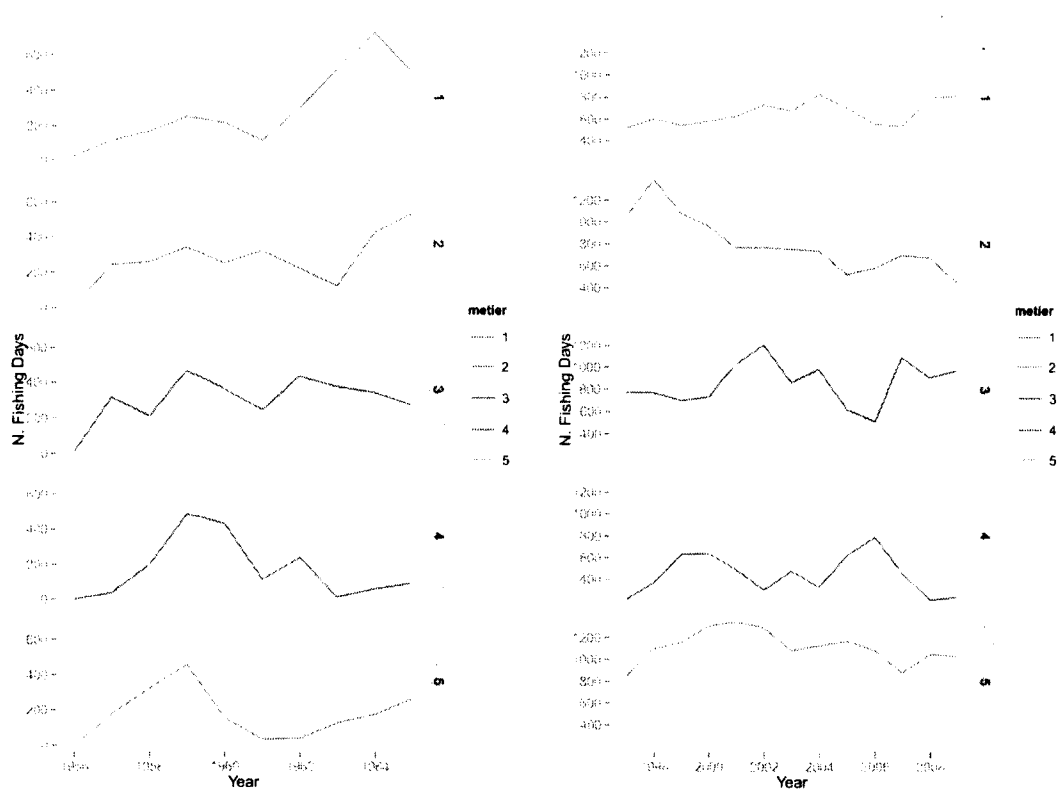

Figure 5-5. Sum of fishing days by metier/cluster per year in the Blanes trawl fishery in the old and new periods. The clusters (panels 1:5) don't match across periods, for approximate correspondence, see details in text.

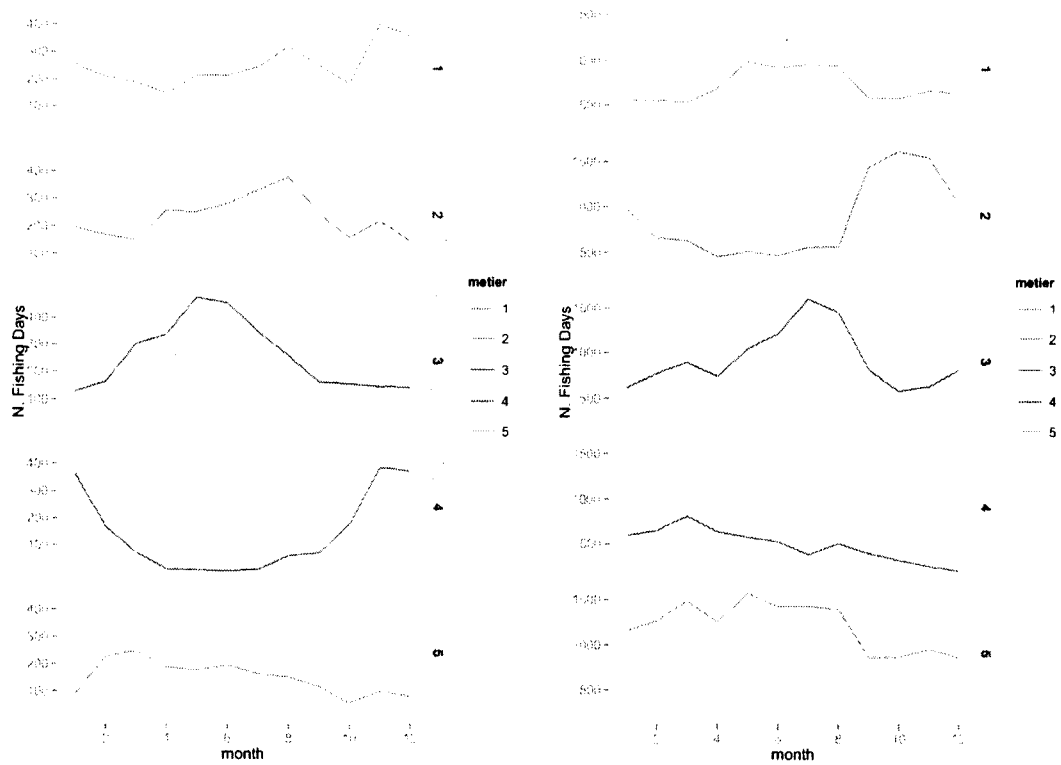

Figure 5-6. Sum of fishing days by metier/cluster per month in the Blanes trawl fishery in the old and new periods. The clusters (panels 1:5) don't match across periods, for approximate correspondence, see details in text.

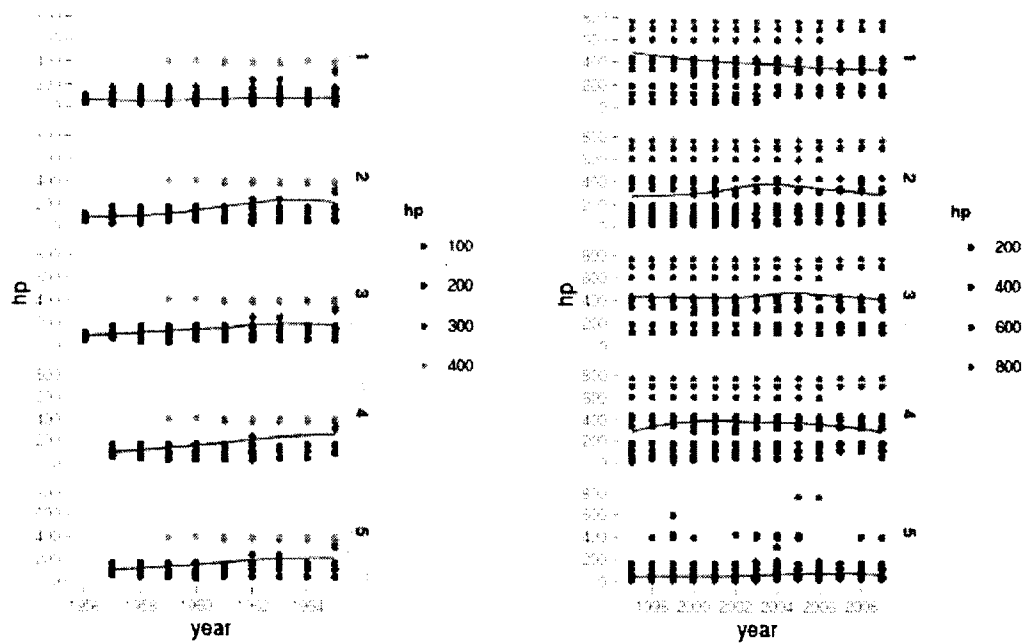

Figure 5-7. Trawler engine HP by metier/cluster in the Blanes fishery in the old and new periods. Clusters (panels 1:5) don't match across periods, for approximate correspondence, see details in text. Fitted smoother indicates the mean HP per year in each metier.

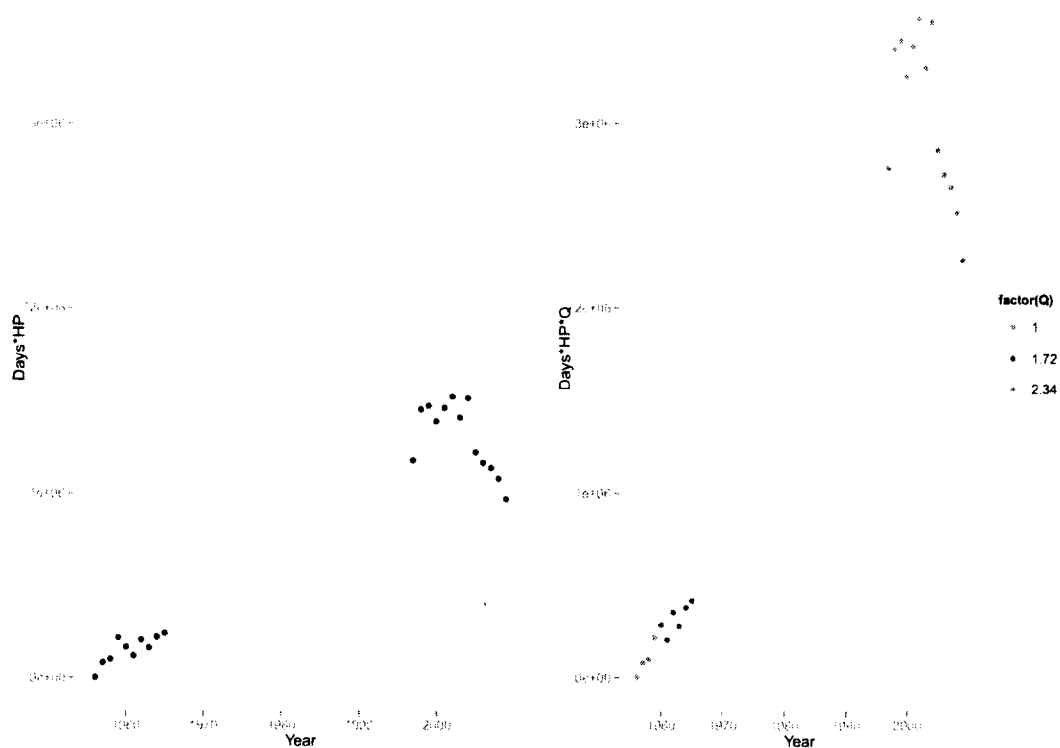

Figure 5-8. Calculation of nominal trawling fishing effort (Days at sea * vessel HP) and corrected nominal effort times catching power factor A_1 in Blanes (Catalonia).

5.3.2 Results LPUE standardization

The fishing vessels technical parameters (HP, GRT and Length) are highly correlated, however the correlation in the old and new period differ Figure 5-9, 5-10. For the old vessels many parameter are missing, with GRT being the most often reported measure. In the recent data, given a legal limit on engine HP of 500, we assume that the real HP is under-declared.

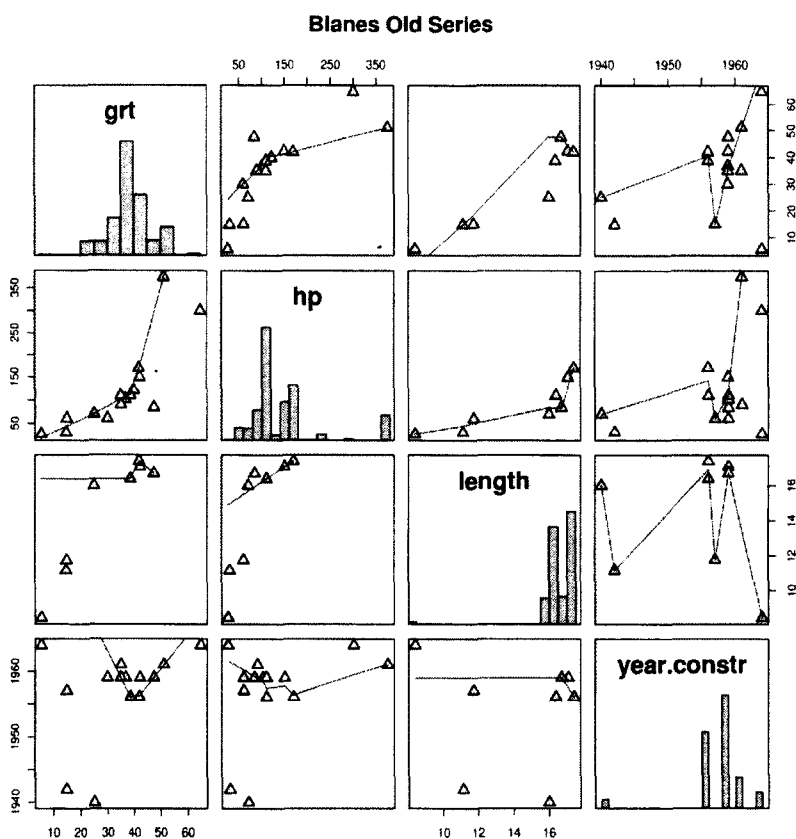

Figure 5-9. Correlation and histogram of vessels technical characteristics, in Blanes 1956-1965

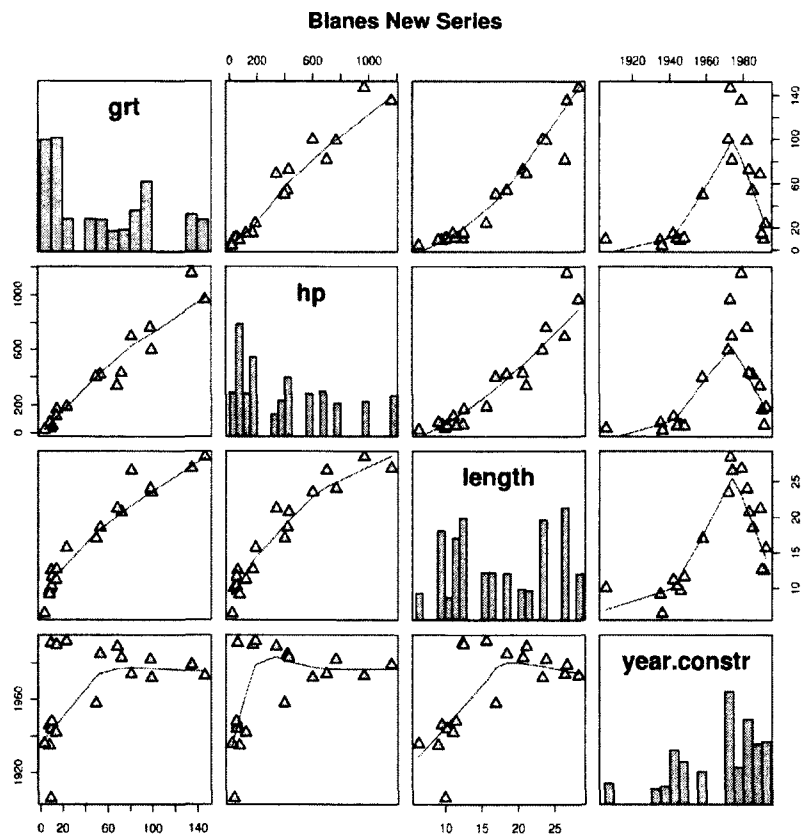

Figure 5-10. Correlation and histogram of vessels technical characteristics, in Blanes 1997-2004

5.3.2.1 Red Shrimp

Red shrimp *Aristeus antennatus* (ARITANT) is the most valuable deep water specie in Catalonia. It is fished by bottom trawling in depths between 600 and 800 m (continental slope) and near submarine canyons between 400 and 600 m deep , however the species distribution exceeds 2500 m depth.

Data were selected from cluster 2 in the old series and cluster 3 in the new one. These metiers are the most consistent in terms of targeting as well as associated species (Figure 5-11). However in the old data, *Aristeus* was also caught in other metiers (3,4,and 5) although in much smaller proportion. Because this may have indicated mixed deep and coastal strategies, only metier 2 was retained for analysis (Figure 5-3). Combined LPUEs from the two metiers are plotted with a smoother in Figure 5-12.

The set of models fitted is reported in R code, the AIC scores of the models are summarized in Table 5.3. The best model is *arit7*.

```

y=20; h=15; m=12; d=10
arit1<-bam(log(kg.ARITANT)~s(year, k=y)+s(hp, by=dumn, k=h)+s(month, k=m)+s(day, k=d)+
  material*year.constr+offset(log(A1))+s(boat, bs="re"), data=aristeus, family=gaussian,
  method="ML")
arit2<-bam(log(kg.ARITANT)~s(year, k=y)+s(hp, k=h)+s(month, k=m)+s(day, k=d)+dumn+
  material*year.constr+offset(log(A1))+s(boat, bs="re"), data=aristeus, family=gaussian,
  method="ML")
arit3<-bam(log(kg.ARITANT)~s(year, k=y)+s(hp, by=dumn, k=h)+s(month, k=m)+day+ material*
  year.constr+offset(log(A1))+s(boat, bs="re"), data=aristeus, family=gaussian, method="
  ML")
arit4<-bam(log(kg.ARITANT)~s(year, k=y)+s(hp, by=dumn, k=h)+month+s(day, k=d) + material*
  year.constr+offset(log(A1))+s(boat, bs="re"), data=aristeus, family=gaussian, method="
  ML")
arit5<-bam(log(kg.ARITANT)~s(year, k=y)+s(hp, by=dumn, k=h)+s(month, k=m)+day + material+
  year.constr+offset(log(A1))+s(boat, bs="re"), data=aristeus, family=gaussian, method="
  ML")
arit6<-bam(log(kg.ARITANT)~s(year, k=y)+s(hp, by=dumn, k=h)+s(month, k=m)+day+material+
  year.constr+offset(log(A1))+s(boat, bs="re"), data=aristeus, family=gaussian, method="
  ML")
arit7<-bam(log(kg.ARITANT)~s(year, k=y)+s(hp, by=dumn, k=h)+s(month, k=m)+day+year.constr+
  offset(log(A1))+s(boat, bs="re"), data=aristeus, family=gaussian, method="ML")
arit8<-bam(log(kg.ARITANT)~s(year, k=y)+s(hp, by=dumn, k=h)+s(month, k=m)+day+material+
  offset(log(A1))+s(boat, bs="re"), data=aristeus, family=gaussian, method="ML")
arit9<-bam(log(kg.ARITANT)~s(year, k=y)+s(hp, by=dumn, k=h)+s(month, k=m)+day+offset(log(
  A1))+s(boat, bs="re"), data=aristeus, family=gaussian, method="ML")
arit10<-bam(log(kg.ARITANT)~s(year, k=y)+s(hp, by=dumn, k=h)+s(month, k=m)+offset(log(A1))
  +s(boat, bs="re"), data=aristeus, family=gaussian, method="ML")

```

Model summary for model *aritrem1* shows a Deviance explained of 38.6%, model diagnostics don't show violation of heterogeneity. The deviance residuals vs. theoretical quantiles, despite a heavy tail, are acceptable, the residuals histogram is reasonably nor-

Model	df	AIC
arit1	65.94	18468.70
arit2	65.23	18539.61
arit3	65.94	18468.70
arit4	55.59	18832.66
arit5	66.12	18468.26
arit6	66.12	18468.26
arit7	66.26	18468.16
arit8	68.08	18549.35
arit9	68.02	18549.25
arit10	67.02	18554.32

Table 5.3. AIC of different random effects models for *Aristeus antennatus* standardization, Blanes (Catalonia, Spain).

mal (Figure 5-14) and the random term QQ plot is acceptable (bottom right panel, Figure 5-13).

```

Family: gaussian
Link function: identity

Formula:
log(kg.ARITANT) ~ s(year, k = y) + s(hp, by = dumn, k = h) +
  s(month, k = m) + day + year.constr + offset(log(A1)) + s(boat,
  bs = "re")

Parametric coefficients:
              Estimate Std. Error t value Pr(>|t|)
(Intercept) -7.389866   6.301042  -1.173  0.24090
day          -0.001218   0.000464  -2.626  0.00865 **
year.constr  0.005236    0.003176   1.649  0.09926 .
-----
Signif. codes:  0   ***    0.001   **    0.01   *    0.05   .    0.1    1

Approximate significance of smooth terms:
              edf Ref. df      F p-value
s(year)      18.121 18.776 137.428 < 2e-16 ***
s(hp):dumna  3.924  4.248   4.391 0.00117 **
s(hp):dumnb  3.177  3.408  12.068 1.15e-08 ***
s(hp):dumnc  1.007  1.008  24.994 5.37e-07 ***
s(month)     10.378 10.917  56.012 < 2e-16 ***
s(boat)      26.039 28.158  42.922 < 2e-16 ***
-----
Signif. codes:  0   ***    0.001   **    0.01   *    0.05   .    0.1    1

R-sq.(adj) = 0.383   Deviance explained = 38.6%
REML score = 9363.3  Scale est. = 0.22418   n = 13703

```

The fitted model year effect (top left panel in Figure 5-13) shows the smoother for year with over plotted residuals on log scale, and is representative of the trend of *Aristeus* over time. The decline in LPUE has been almost continuous from the 1950s to the mid-1990s,

despite an upward trend from 1962 and an apparent constant increase in the last 8 year years. Since year smoother is on a log scale, the drop of the standardized LPUE is large and high levels of fishing effort in the recent period support this decline.

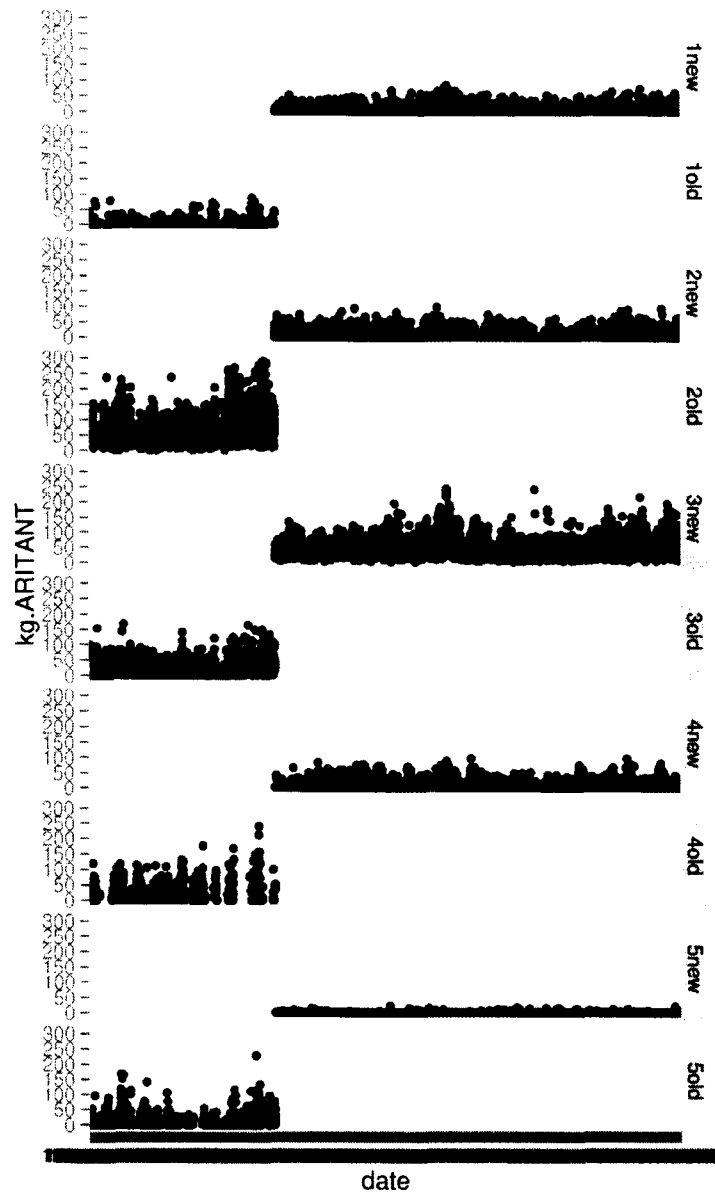

Figure 5-11. Raw LPUE for *Aristeus antennatus* in the Blanes (Catalonia) trawl fishery from all cluster old and new. Date go from 1955-1965 in the old clusters and from 1997-2009 in the new clusters.

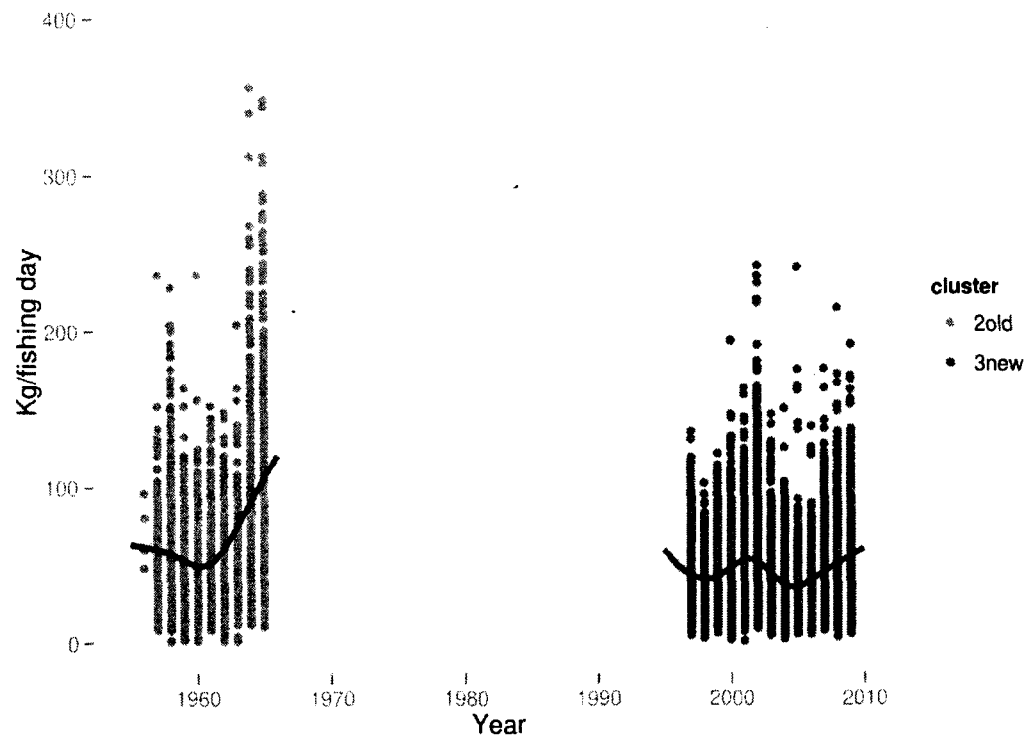

Figure 5-12. Raw LPUE for *Aristeus antennatus* in the Blanes (Catalonia) trawl fishery from cluster 2 in the old data and 3 in the new data, fitted with a simple smoother.

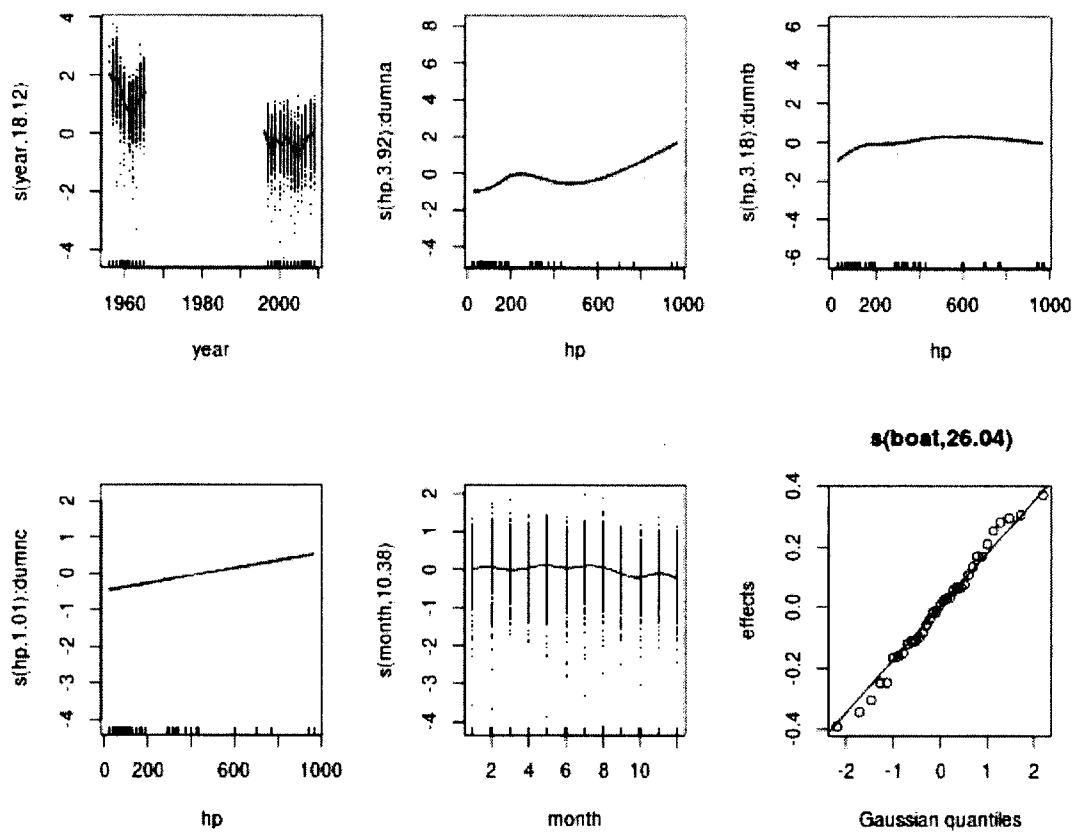

Figure 5-13. Estimated smoothing curves and random effects from the best GAMM model for *Aristeus antennatus* in the Blanes (Catalonia) trawl fishery, with 95% Confidence Intervals.

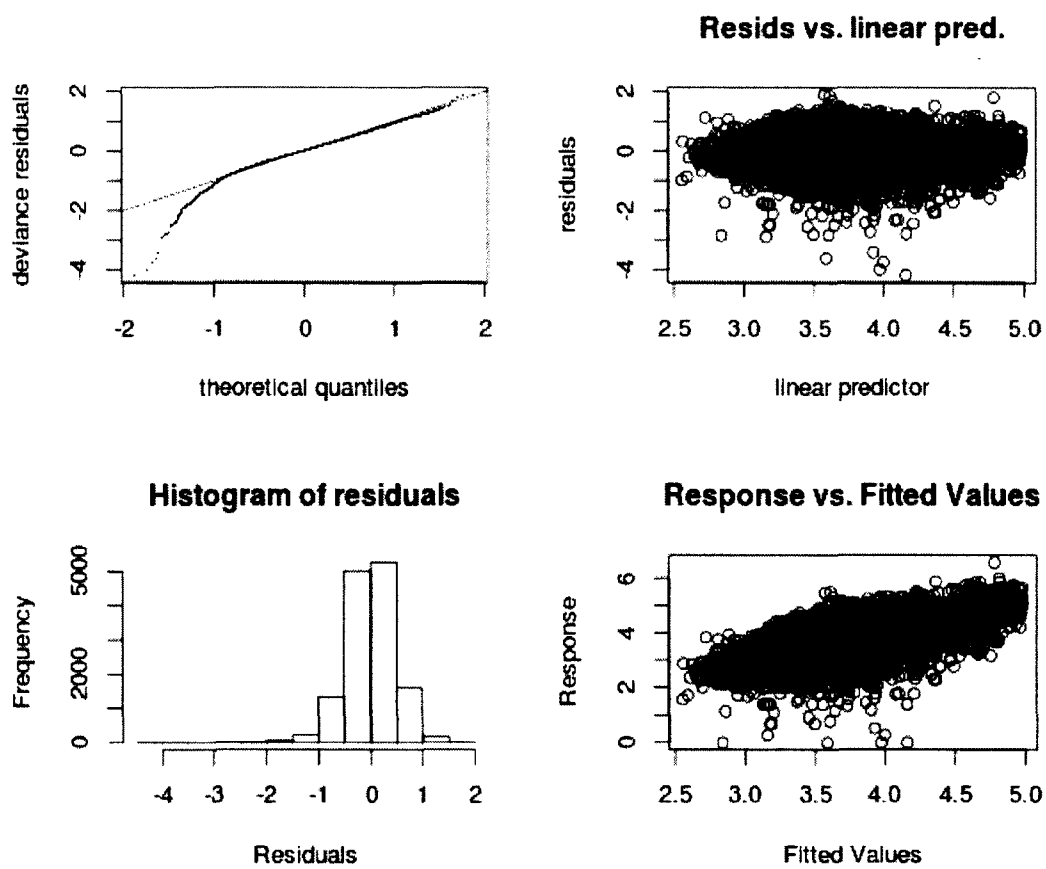

Figure 5-14. Model diagnostics for total model for *Aristeus antennatus* in the Blanes (Catalonia) trawl fishery, with 95% Confidence Intervals.

5.3.2.2 Mediterranean hake

Mediterranean hake (*Merluccius merluccius*, (MERLMER)) is a very important and common commercial species throughout the western Mediterranean. The Blanes series provides no detail about size or number of individuals, but only total weight in kg is reported. Hake has a very wide bathymetric distribution and appears in almost all clusters in both the old and new data. The most representative clusters, in terms of relative weight contribution, are 1, 3 and 5 in old data, and 1 and 2 in the modern data (Figur 5-15). Summarized LPUEs are in Figure 5-16

The set of models fitted is reported in R code, the AIC scores of the models are summarized in Table 5.4. The best model is *hke1*.

```
y=20; h=15; m=12; d=10
hke1<-bam(log(kg.MERLMER+1)~s(year, k=y)+s(hp, by=dumn, k=h)+s(month, k=m)+s(day, k=d)+
  material*year.constr+offset(log(A1))+s(boat, bs="re"), data=hake, family=gaussian,
  method="ML")
hke2<-bam(log(kg.MERLMER+1)~s(year, k=y)+s(hp, k=h)+s(month, k=m)+s(day, k=d)+dumn+
  material*year.constr+offset(log(A1))+s(boat, bs="re"), data=hake, family=gaussian,
  method="ML")
hke3<-bam(log(kg.MERLMER+1)~s(year, k=y)+s(hp, by=dumn, k=h)+s(month, k=m)+day+ material*
  year.constr+offset(log(A1))+s(boat, bs="re"), data=hake, family=gaussian, method="ML")
hke4<-bam(log(kg.MERLMER+1)~s(year, k=y)+s(hp, by=dumn, k=h)+month+s(day, k=d)+ material*
  year.constr+offset(log(A1))+s(boat, bs="re"), data=hake, family=gaussian, method="ML")
hke5<-bam(log(kg.MERLMER+1)~s(year, k=y)+s(hp, by=dumn, k=h)+s(month, k=m)+day + material+
  year.constr+offset(log(A1))+s(boat, bs="re"), data=hake, family=gaussian, method="ML")
hke6<-bam(log(kg.MERLMER+1)~s(year, k=y)+s(hp, by=dumn, k=h)+s(month, k=m)+day+material+
  year.constr+offset(log(A1))+s(boat, bs="re"), data=hake, family=gaussian, method="ML")
hke7<-bam(log(kg.MERLMER+1)~s(year, k=y)+s(hp, by=dumn, k=h)+s(month, k=m)+day+year.constr
  +offset(log(A1))+s(boat, bs="re"), data=hake, family=gaussian, method="ML")
hke8<-bam(log(kg.MERLMER+1)~s(year, k=y)+s(hp, by=dumn, k=h)+s(month, k=m)+day+material+
  offset(log(A1))+s(boat, bs="re"), data=hake, family=gaussian, method="ML")
hke9<-bam(log(kg.MERLMER+1)~s(year, k=y)+s(hp, by=dumn, k=h)+s(month, k=m)+day+offset(log(
  A1))+s(boat, bs="re"), data=hake, family=gaussian, method="ML")
hke10<-bam(log(kg.MERLMER+1)~s(year, k=y)+s(hp, by=dumn, k=h)+s(month, k=m)+offset(log(A1)
  )+s(boat, bs="re"), data=hake, family=gaussian, method="ML")
```

The model summary for model *hk1reml* shows a Deviance explained of 48.9%, model diagnostics don't show violation of heterogeneity. The deviance residuals vs. theoretical quantiles are acceptable, the residuals histogram is reasonably normal (Figure 5-18) and the random term QQ plot is acceptable, although it presents some non-optimal pattern (bottom left panel, Figure 5-17).

```
Family: gaussian
Link function: identity

Formula:
log(kg.MERLMER + 1) ~ s(year, k = y) + s(hp, by = dumn, k = h) +
  s(month, k = m) + s(day, k = d) + material * year.constr +
  offset(log(A1)) + s(boat, bs = "re")
```

Model	df	AIC
hke1	76.33	66078.99
hke2	75.64	66079.66
hke3	74.28	66089.93
hke4	67.46	66597.59
hke5	74.92	66088.98
hke6	74.92	66088.98
hke7	74.96	66088.02
hke8	76.67	66531.59
hke9	76.26	66530.38
hke10	75.28	66532.88

Table 5.4. AIC of different random effects models for *Merluccius merluccius* standardization, Blanes (Catalonia, Spain).

Parametric coefficients:					
	Estimate	Std. Error	t value	Pr(> t)	
(Intercept)	22.43117	27.58576	0.813	0.416	
materialsteel	207.81189	131.40226	1.581	0.114	
materialwood	-33.29410	29.41247	-1.132	0.258	
year.constr	-0.01071	0.01384	-0.774	0.439	
materialsteel:year.constr	-0.10533	0.06641	-1.586	0.113	
materialwood:year.constr	0.01662	0.01478	1.124	0.261	
Approximate significance of smooth terms:					
	edf	Ref. df	F	p-value	
s(year)	18.271	18.884	121.102	< 2e-16	***
s(hp):dumna	1.499	1.589	11.296	6.77e-05	***
s(hp):dumnb	3.396	3.865	4.939	0.000663	***
s(hp):dumnc	4.455	4.491	17.004	2.35e-15	***
s(month)	10.379	10.917	50.717	< 2e-16	***
s(day)	3.692	4.573	3.564	0.004327	**
s(boat)	29.089	31.059	17.514	< 2e-16	***
Signif. codes: 0 '***' 0.001 '**' 0.01 '*' 0.05 '.' 0.1 ' ' 1					
R-sq.(adj) = 0.487 Deviance explained = 48.9%					
REML score = 33182 Scale est. = 0.79331 n = 25322					

The fitted model year effect (top left panel in Figure 5-17) shows the smoother for year with over plotted residuals on a log scale and is representative of the trend of *Merluccius merluccius* over time. The decline in LPUE has been almost continuous from the 1950s to the mid-1990s, despite an upward trend in 1962. There seem to be a constant increase in the last 4 years. Overall, the decline in LPUE is significant over time, but not as steep as for red shrimp.

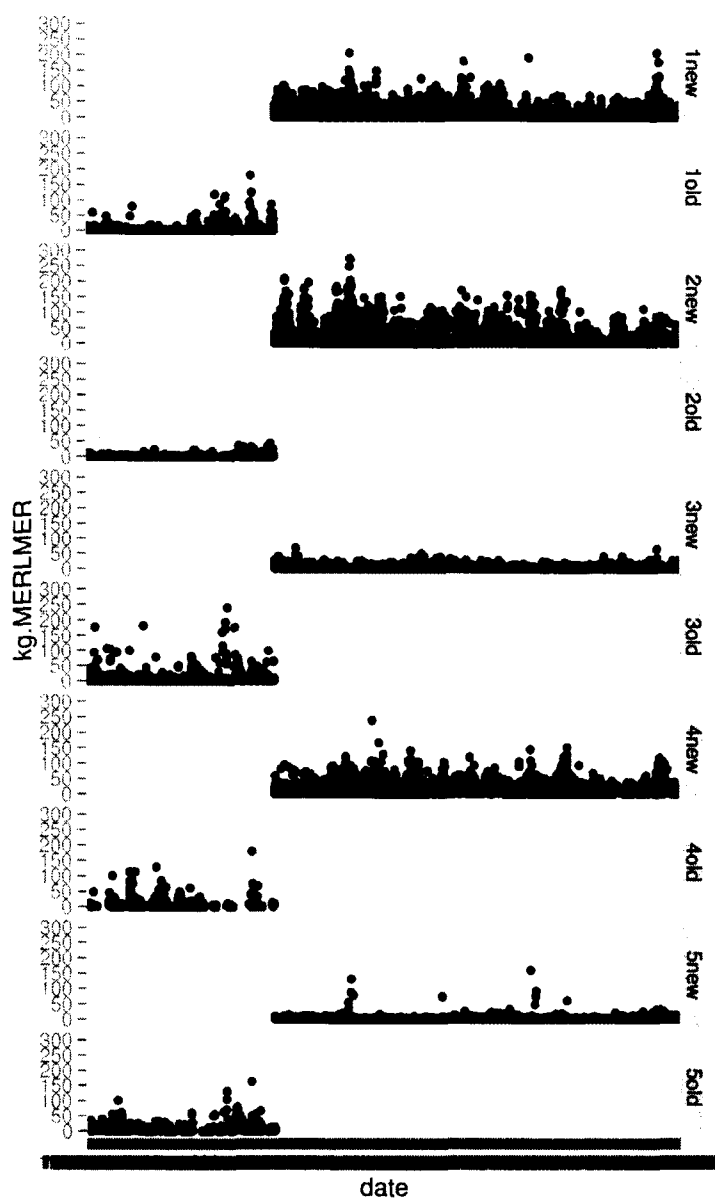

Figure 5-15. Raw LPUE for *Merluccius merluccius* in the Blanes (Catalonia) trawl fishery from all cluster old and new. Date goes from 1955-1965 in the old clusters and from 1997-2009 in the new clusters.

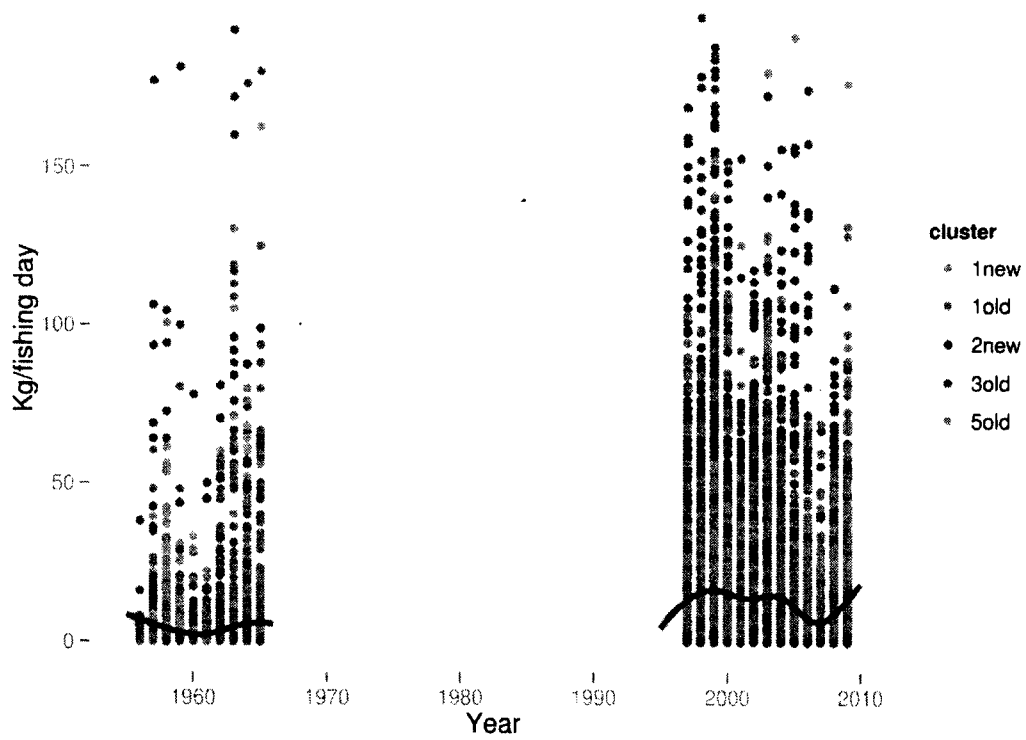

Figure 5-16. Raw LPUE for *Merluccius merluccius* in the Blanes (Catalonia) trawl fishery from cluster 1,3 and 5 in the old data and 1 and 2 in the modern data, fitted with a simple smoother.

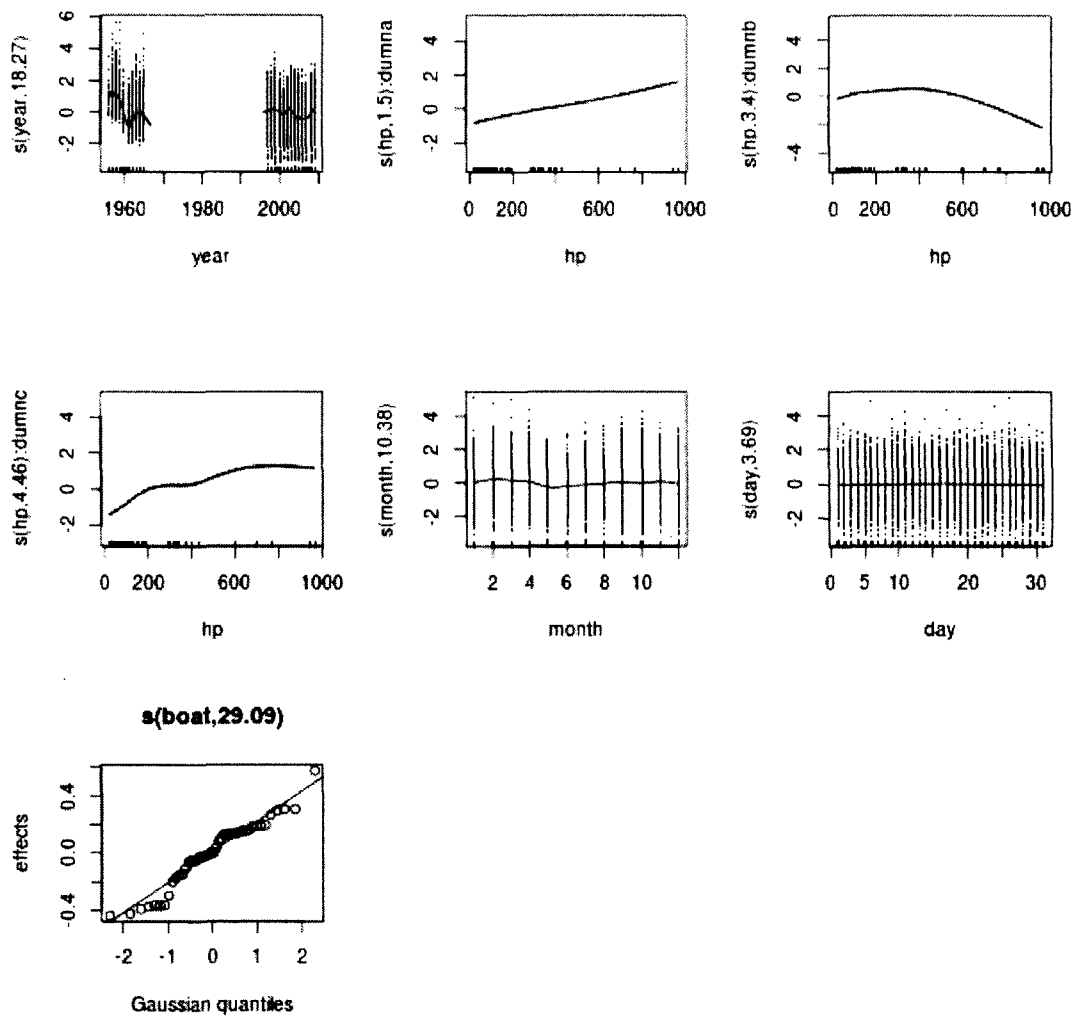

Figure 5-17. Estimated smoothing curves and random effects from the best GAMM model for *Merluccius merluccius* in the Blanes (Catalonia) trawl fishery, with 95% Confidence Intervals.

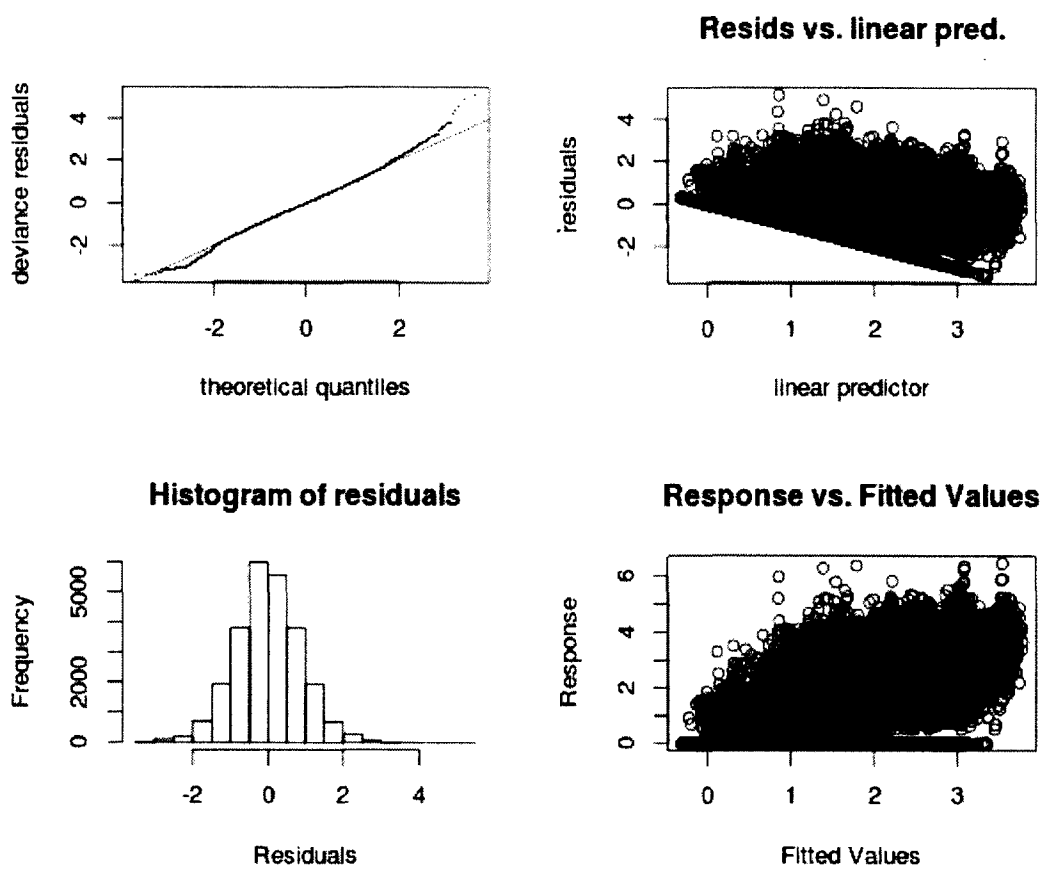

Figure 5-18. Model diagnostics for total model for *Merluccius merluccius* in the Blanes (Catalonia) trawl fishery, with 95% Confidence Intervals.

5.3.2.3 Blue whiting

Blue whiting (*Micromesistius poutassou*, MICMPOU) has a depth range of 250-700m and is commonly caught in Blanes new metier 4 as previously described. Before LPUE standardization, data from clusters 3 and 5 old and 1 and 4 new were selected (Figure 5-19-5-20). This species has experienced historically high fishing effort and mortality [256], although no formal stock assessment has been performed.

The set of models fitted is reported in R code, the AIC scores of the models are summarized in Table 5.5. The best model is *micm1*.

```
#y=20; h=15; m=12; d=10
y=10; h=8; m=6; d=5

micm1<-bam(log(kg.MICMPOU+1)^s(year, k=y)+s(hp, by=dumn, k=h)+s(month, k=m)+s(day, k=d)+
  material*year.constr+offset(log(A1))+s(boat, bs="re"), data=pout, family=gaussian,
  method="ML")
micm2<-bam(log(kg.MICMPOU+1)^s(year, k=y)+s(hp, k=h)+s(month, k=m)+s(day, k=d)+ material*
  year.constr+offset(log(A1))+s(boat, bs="re"), data=pout, family=gaussian, method="ML")
micm3<-bam(log(kg.MICMPOU+1)^s(year, k=y)+s(hp, by=dumn, k=h)+s(month, k=m)+day+ material*
  year.constr+offset(log(A1))+s(boat, bs="re"), data=pout, family=gaussian, method="ML")
micm4<-bam(log(kg.MICMPOU+1)^s(year, k=y)+s(hp, by=dumn, k=h)+month+s(day, k=d)+ material*
  year.constr+offset(log(A1))+s(boat, bs="re"), data=pout, family=gaussian, method="ML")
micm5<-bam(log(kg.MICMPOU+1)^s(year, k=y)+s(hp, by=dumn, k=h)+s(month, k=m)+day + material
  +year.constr+offset(log(A1))+s(boat, bs="re"), data=pout, family=gaussian, method="ML"
)
micm6<-bam(log(kg.MICMPOU+1)^s(year, k=y)+s(hp, by=dumn, k=h)+s(month, k=m)+day+material+
  year.constr+offset(log(A1))+s(boat, bs="re"), data=pout, family=gaussian, method="ML")
micm7<-bam(log(kg.MICMPOU+1)^s(year, k=y)+s(hp, by=dumn, k=h)+s(month, k=m)+day+year.
  constr+offset(log(A1))+s(boat, bs="re"), data=pout, family=gaussian, method="ML")
micm8<-bam(log(kg.MICMPOU+1)^s(year, k=y)+s(hp, by=dumn, k=h)+s(month, k=m)+day+material+
  offset(log(A1))+s(boat, bs="re"), data=pout, family=gaussian, method="ML")
micm9<-bam(log(kg.MICMPOU+1)^s(year, k=y)+s(hp, by=dumn, k=h)+s(month, k=m)+day+offset(log
  (A1))+s(boat, bs="re"), data=pout, family=gaussian, method="ML")
micm10<-bam(log(kg.MICMPOU+1)^s(year, k=y)+s(hp, by=dumn, k=h)+s(month, k=m)+day+year.
  constr+offset(log(A1))+s(boat, bs="re"), data=pout, family=gaussian, method="ML")
```

Model summary for model *micm1* shows a Deviance explained of 31.1%, model diagnostics don't show violation of heterogeneity. The deviance residuals vs. theoretical quantiles are acceptable, the residuals histogram is reasonably normal (Figure 5-22) and the random term QQ plot is good (bottom left panel, Figure 5-21).

```
Family: gaussian
Link function: identity

Formula:
log(kg.MICMPOU + 1) ~ s(year, k = y) + s(hp, by = dumn, k = h) +
  s(month, k = m) + day + year.constr + offset(log(A1)) + s(boat,
  bs = "re")

Parametric coefficients:
      Estimate Std. Error t value Pr(>|t|)
(Intercept) -9.005640  13.454595  -0.669   0.503
```

Model	df	AIC
micm1	55.73	61259.66
micm2	55.74	61260.60
micm3	55.73	61259.66
micm4	51.75	61608.99
micm5	59.02	61363.85
micm6	59.02	61363.85
micm7	56.19	61258.07
micm8	59.07	61835.84
micm9	57.91	61838.93
micm10	56.19	61258.07

Table 5.5. AIC of different random effects models for *Micromesistius poutassou* standardization, Blanes (Catalonia, Spain).

day	-0.004481	0.001049	-4.271	1.96e-05	***				
year.constr	0.006093	0.006817	0.894	0.371					
Signif. codes:	0	***	0.001	**	0.01	*	0.05	.	0.1
Approximate significance of smooth terms:									
	edf	Ref. df	F	p-value					
s(year)	8.962	8.997	197.528	< 2e-16	***				
s(hp):dumna	2.584	2.989	10.530	6.72e-07	***				
s(hp):dumnb	1.144	1.182	22.954	2.89e-07	***				
s(hp):dumnc	1.351	1.363	1.407	0.243					
s(month)	4.939	4.998	223.759	< 2e-16	***				
s(boat)	35.126	34.000	99.534	< 2e-16	***				
Signif. codes:	0	***	0.001	**	0.01	*	0.05	.	0.1
R-sq.(adj) =	0.311	Deviance explained = 31.3%							
REML score =	30743	Scale est. = 1.5462 n = 18693							

The fitted model year effect (top left panel in Figure 5-21) shows that LPUE has been almost continuously declining from the 1950s to the mid-1990s, despite a strong upward trend from 1962 to 1967 which is compatible with the effect of fishery expansion to new deeper grounds. In recent years there is a yearly cycle, and in the last 4-5 years LPUE is declining despite reduced overall effort. However, metier specific effort should be checked since it might not be decreasing. The overall drop in LPUE from the old to modern series is very steep.

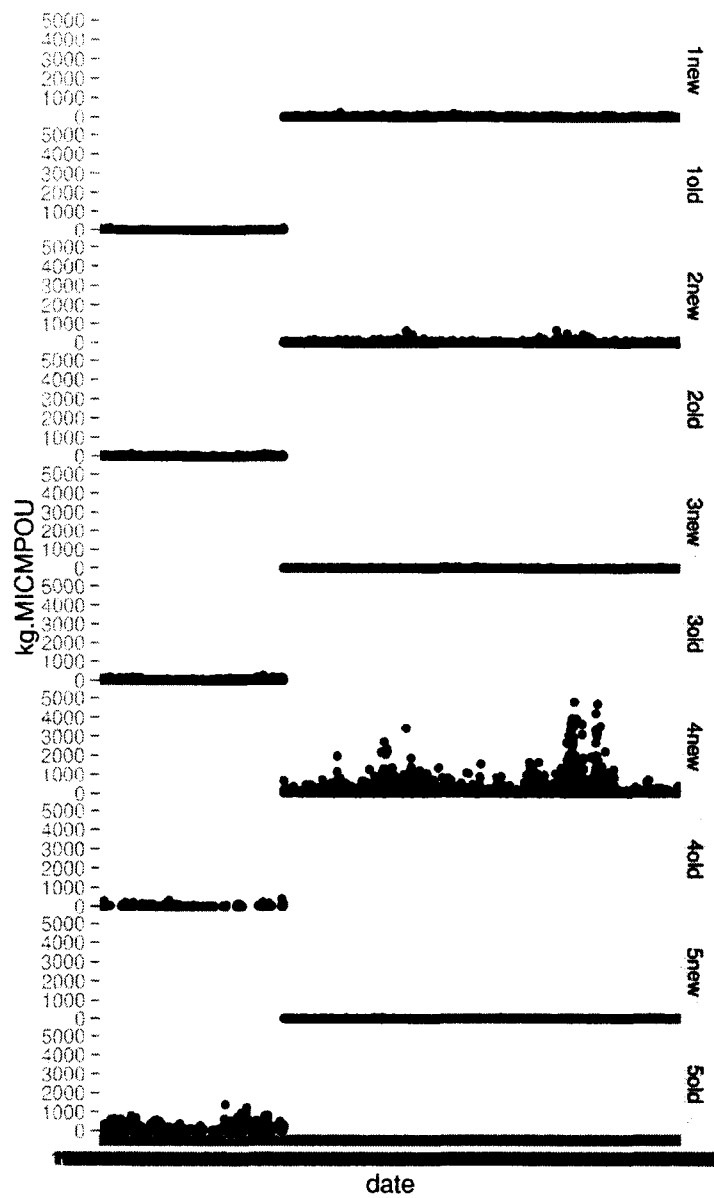

Figure 5-19. Raw LPUE for *Micromesistius poutassou* in the Blanes (Catalonia) trawl fishery from all clusters, old and new. Date go from 1955-1965 in the old clusters and from 1997-2009 in the new clusters.

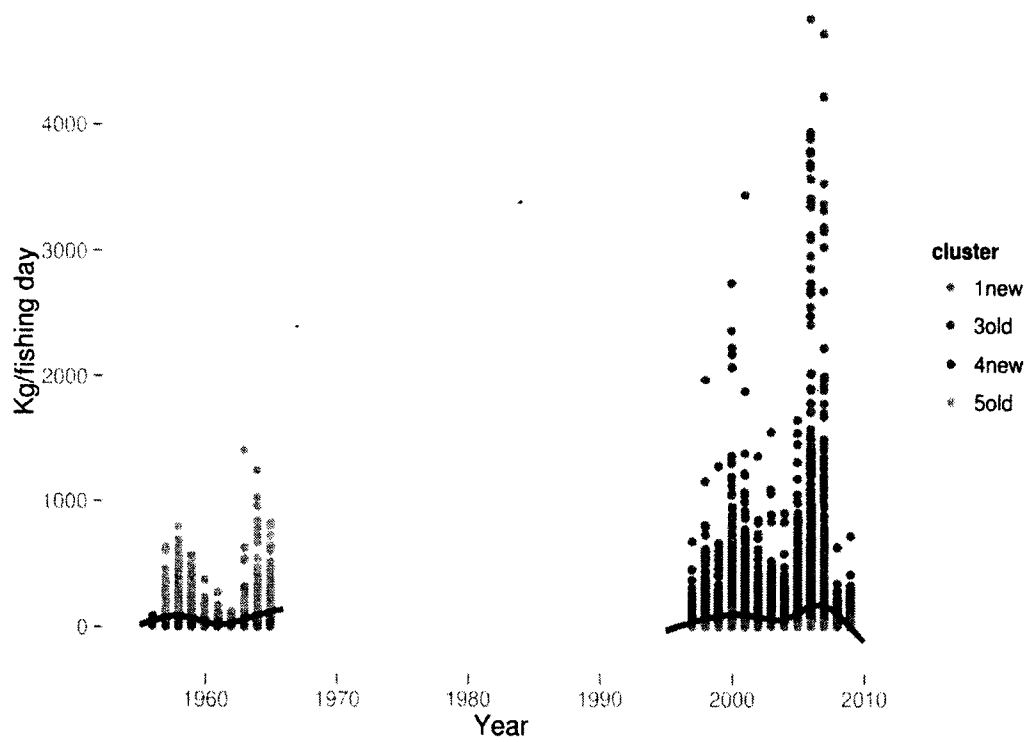

Figure 5-20. Raw LPUE for *Micromesistius poutassou* in the Blanes (Catalonia) trawl fishery from clusters 3 and 5 in the old data and 1 and 4 in the modern data, fitted with a simple smoother.

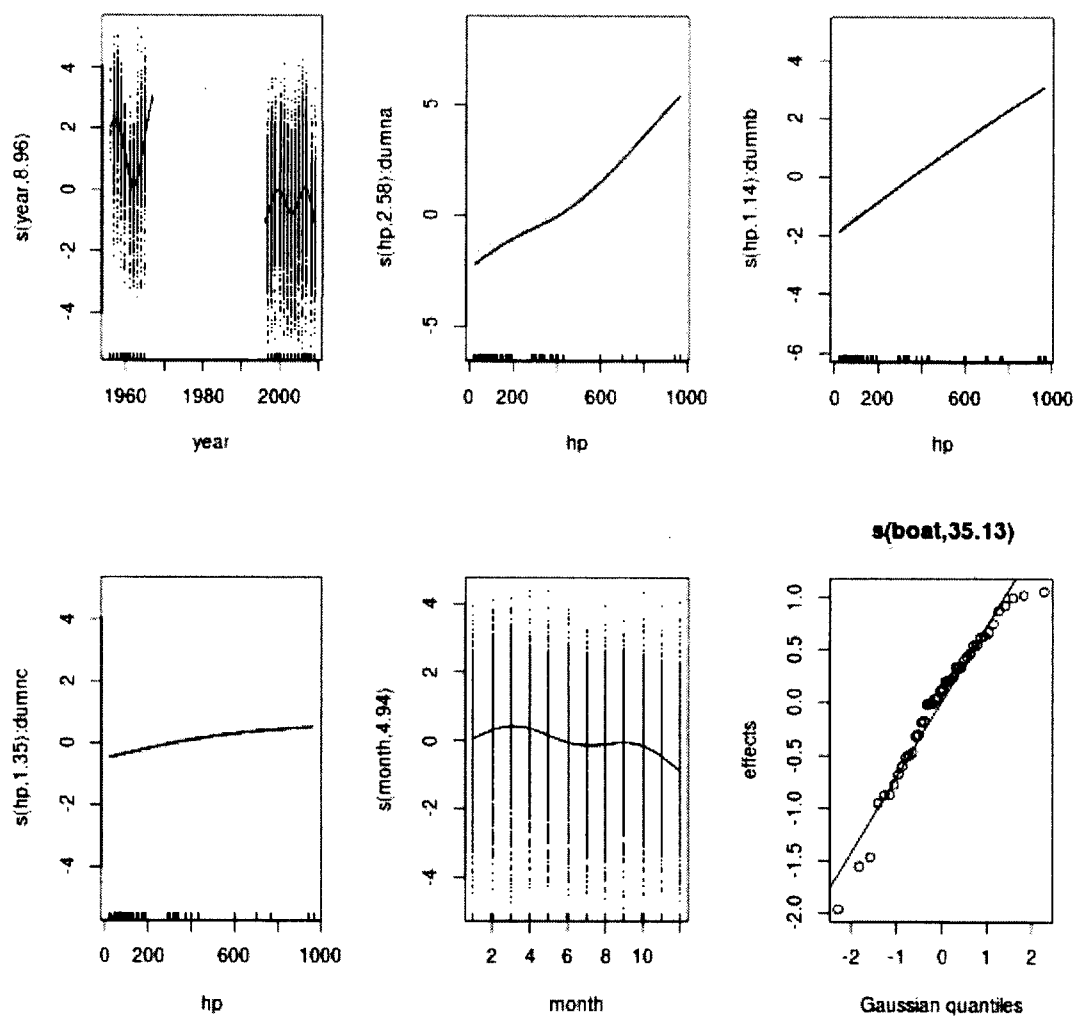

Figure 5-21. Estimated smoothing curves and random effects from the best GAMM model for *Micromesistius poutassou* in the Blanes (Catalonia) trawl fishery, with 95% Confidence Intervals.

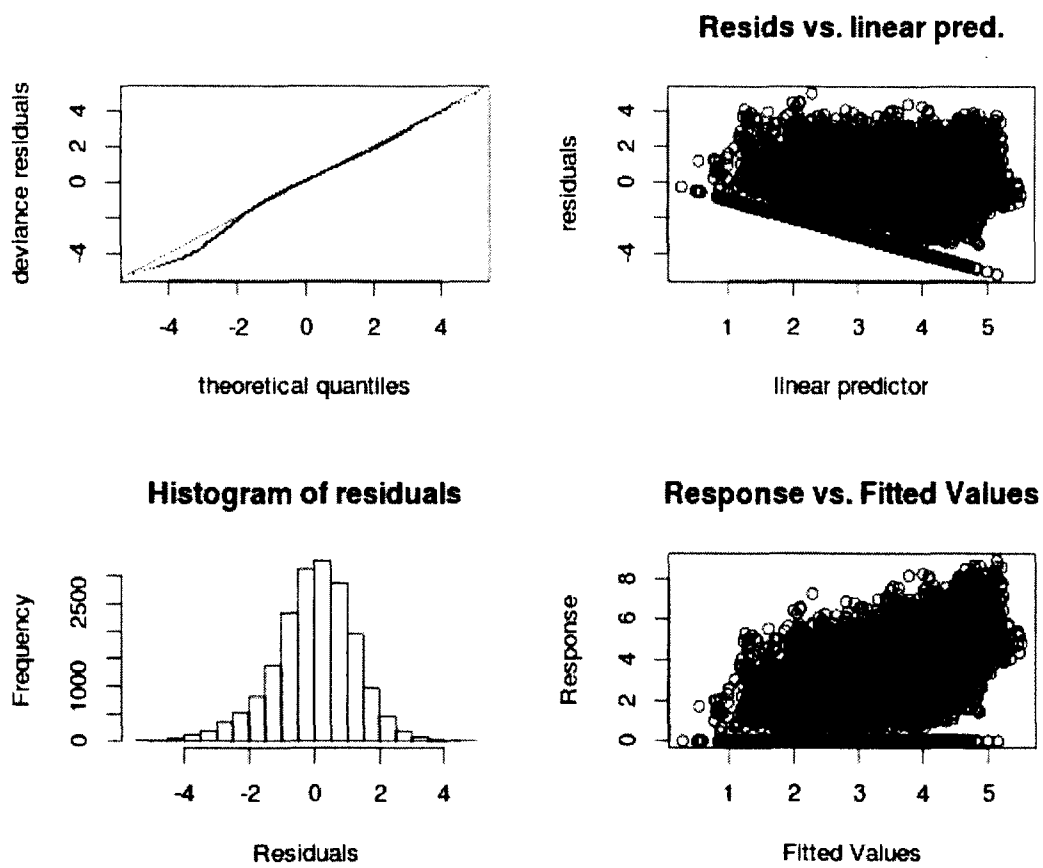

Figure 5-22. Model diagnostics for total model for *Micromesistius poutassou* in the Blanes (Catalonia) trawl fishery, with 95% Confidence Intervals.

5.3.2.4 Red mullets

In the case of red mullets (*Mullus* sp.), there are species identification inconsistencies. In the past only *Mullus* sp. was reported (although in the database it is labeled MULLBAR) while in the modern period *Mullus barbatus* (MULLBAR) and *Mullus surmuletus* (MULLSUR) are reported separately, Figures 5-23, 5-24 and 5-25. In modern data for the years 1997-1999, the two species are pooled in a *Mullus* sp. category (MULLSP). *Mullus surmuletus* has a shallower distribution (10-60 m) than *Mullus barbatus* (100-300 m). The only way of modeling these species was by pooling the two in one unique group. The following coastal clusters were chosen: 1 and 3 old series, 1 and 5 new series (Figure 5-26).

For red mullets the same set of models applied to previous species was fitted. Since there are problems with model fits and bad residual patterns, the models for this species group are more uncertain.

```
mulbest<-bam(log(MULLSPN+1)~s(year, k=y)+s(hp, by=dumn, k=h)+s(month, k=m)+s(day, k=d)+
  material*year.constr+offset(log(A1))+s(boat, bs="re"), data=mullus, family=gaussian,
  method="REML")
```

Model summary for model *mulbest* shows a Deviance explained of 40.2%, model diagnostics show violation of heterogeneity. The deviance residuals vs. theoretical quantiles show suspicious patterns, the residuals histogram is skewed to the left (Figure 5-18). The random term QQ plot presents some non optimal pattern with 4-8 vessels showing different behavior (bottom left panel, Figure 5-17).

```
Family: gaussian
Link function: identity

Formula:
log(MULLSPN + 1) ~ s(year, k = y) + s(hp, by = dumn, k = h) +
  s(month, k = m) + s(day, k = d) + material * year.constr +
  offset(log(A1)) + s(boat, bs = "re")

Parametric coefficients:
```

	Estimate	Std. Error	t value	Pr(> t)
(Intercept)	34.34566	51.26619	0.670	0.503
materialsteel	155.06211	191.80804	0.808	0.419
materialwood	-66.55503	55.63840	-1.196	0.232
year.constr	-0.01717	0.02570	-0.668	0.504
materialsteel:year.constr	-0.07801	0.09693	-0.805	0.421
materialwood:year.constr	0.03375	0.02796	1.207	0.227

```
Approximate significance of smooth terms:
```

	edf	Ref.df	F	p-value
s(year)	13.796	13.986	96.013	< 2e-16 ***
s(hp):dumna	1.004	1.008	1.642	0.200194
s(hp):dumb	1.000	1.001	3.125	0.077081

s(hp):dumnc	1.000	1.000	11.016	0.000904	***				
s(month)	8.675	8.970	150.247	< 2e-16	***				
s(day)	1.775	1.949	1.681	0.186974					
s(boat)	35.508	36.955	205.176	< 2e-16	***				

Signif. codes:	0	***	0.001	**	0.01	*	0.05	.	0.1
									1
R-sq.(adj) =	0.401	Deviance explained =		40.2%					
REML score =	38860	Scale est. =		0.8216	n =		29279		

The bad residual patterns are not surprising since the two species pooled together were modeled together after the CLARA analysis. There could also be issues related to selection of the metiers. Nevertheless, if we can still believe the model fit, the yearly trend in LPUE shows a decline over time that is coherent with the rest of the species modeled in previous sections (top left panel in Figure 5-27). However the modern standardized LPUE is higher than the lowest old points, indicating that red mullets, while still overexploited (STECF 2012), are sustaining high fishing mortality better than other demersal fish species which is also compatible to fast growth and early spawning.

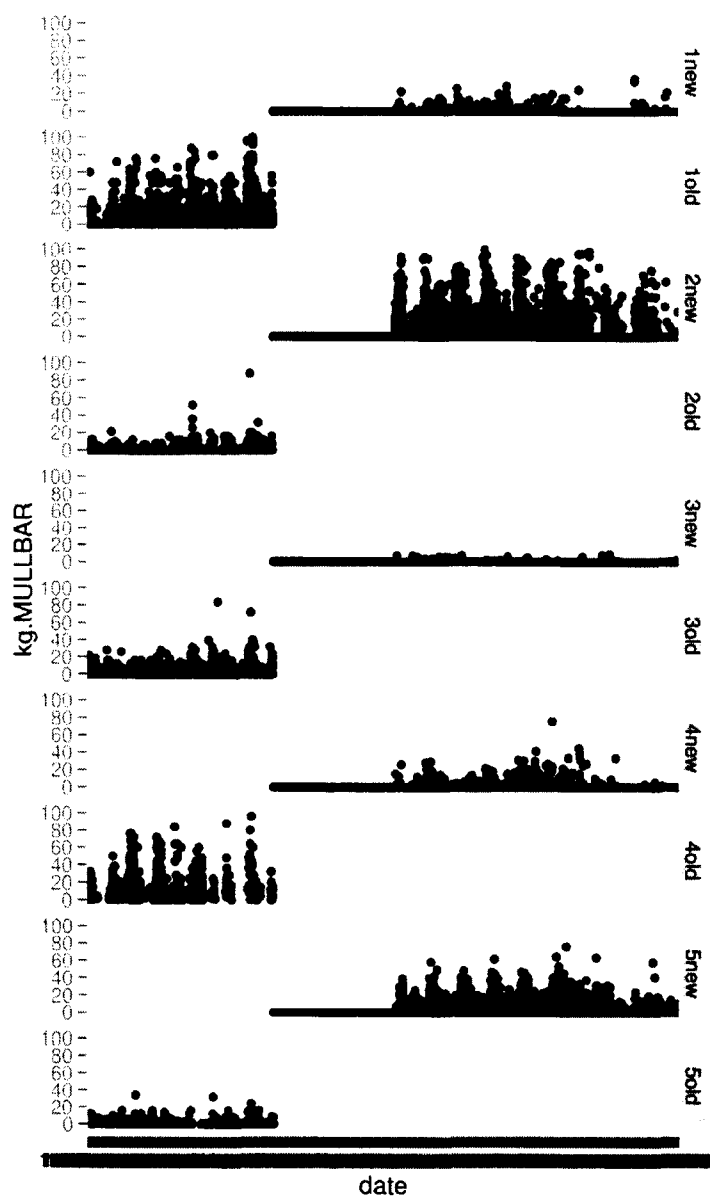

Figure 5-23. Raw LPUE for *Mullus barbatus* in the Blanes (Catalonia) trawl fishery from all clusters old and new. Date goes from 1955-1965 in the old clusters and from 1997-2009 in the new clusters.

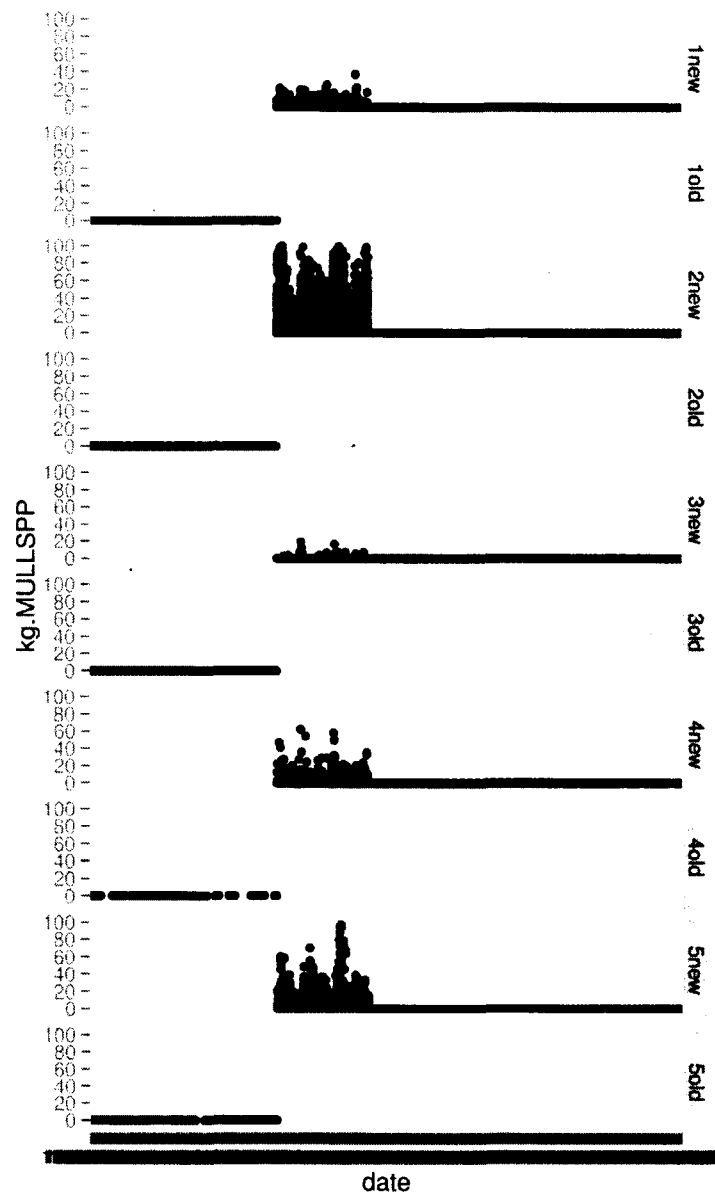

Figure 5-24. Raw LPUE for *Mullus* sp. in the Blanes (Catalonia) trawl fishery from all clusters old and new. Date goes from 1955-1965 in the old clusters and from 1997-2009 in the new clusters.

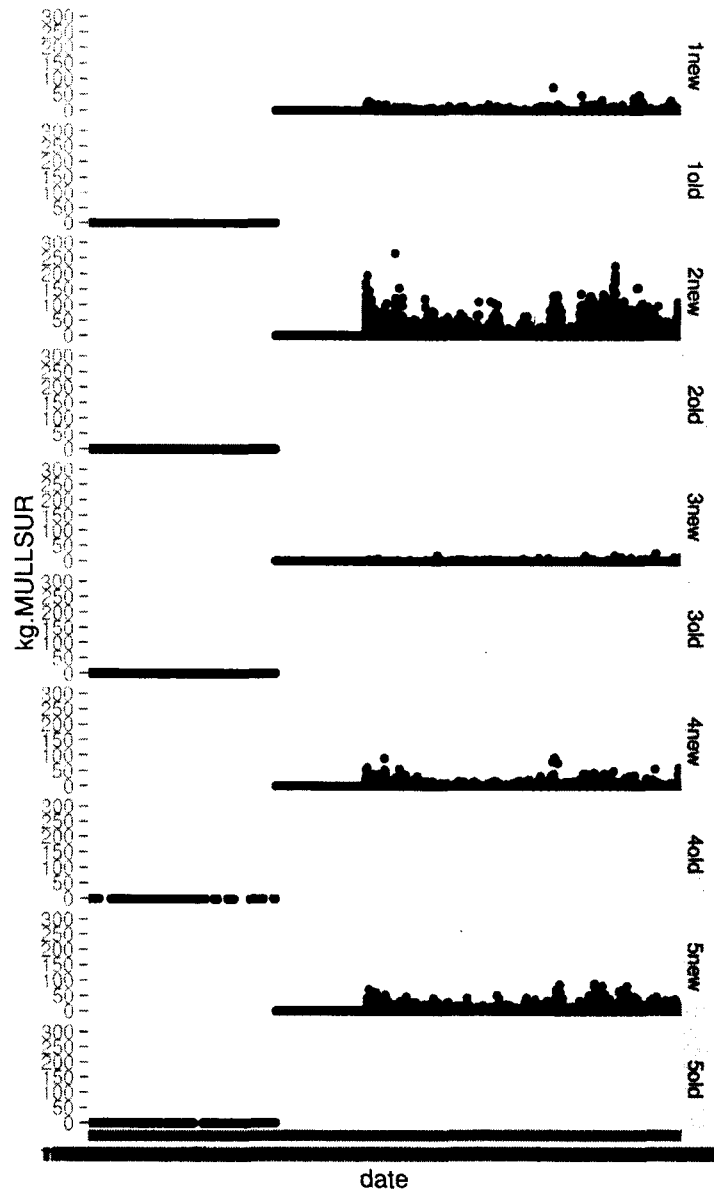

Figure 5-25. Raw LPUE for *Mullus surmuletus* in the Blanes (Catalonia) trawl fishery from all clusters old and new. Date goes from 1955-1965 in the old clusters and from 1997-2009 in the new clusters.

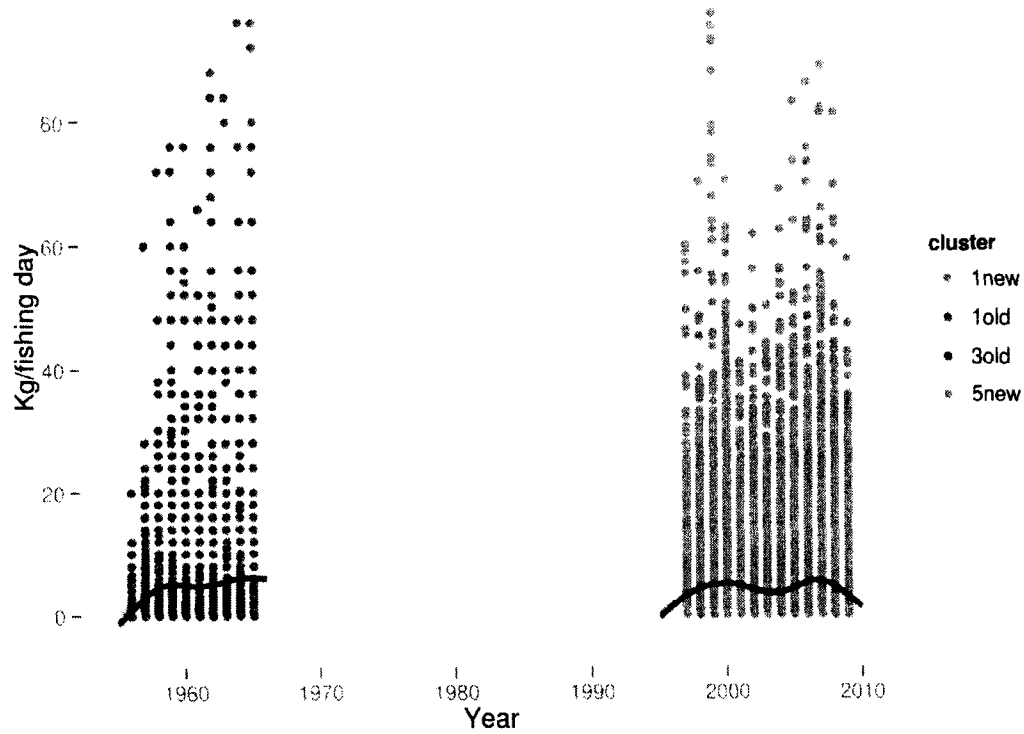

Figure 5-26. Raw LPUE for *Mullus* sp. in the Blanes (Catalonia) trawl fishery from clusters 3 and 5 in the old data and 1 and 4 in the modern data, fitted with a simple smoother.

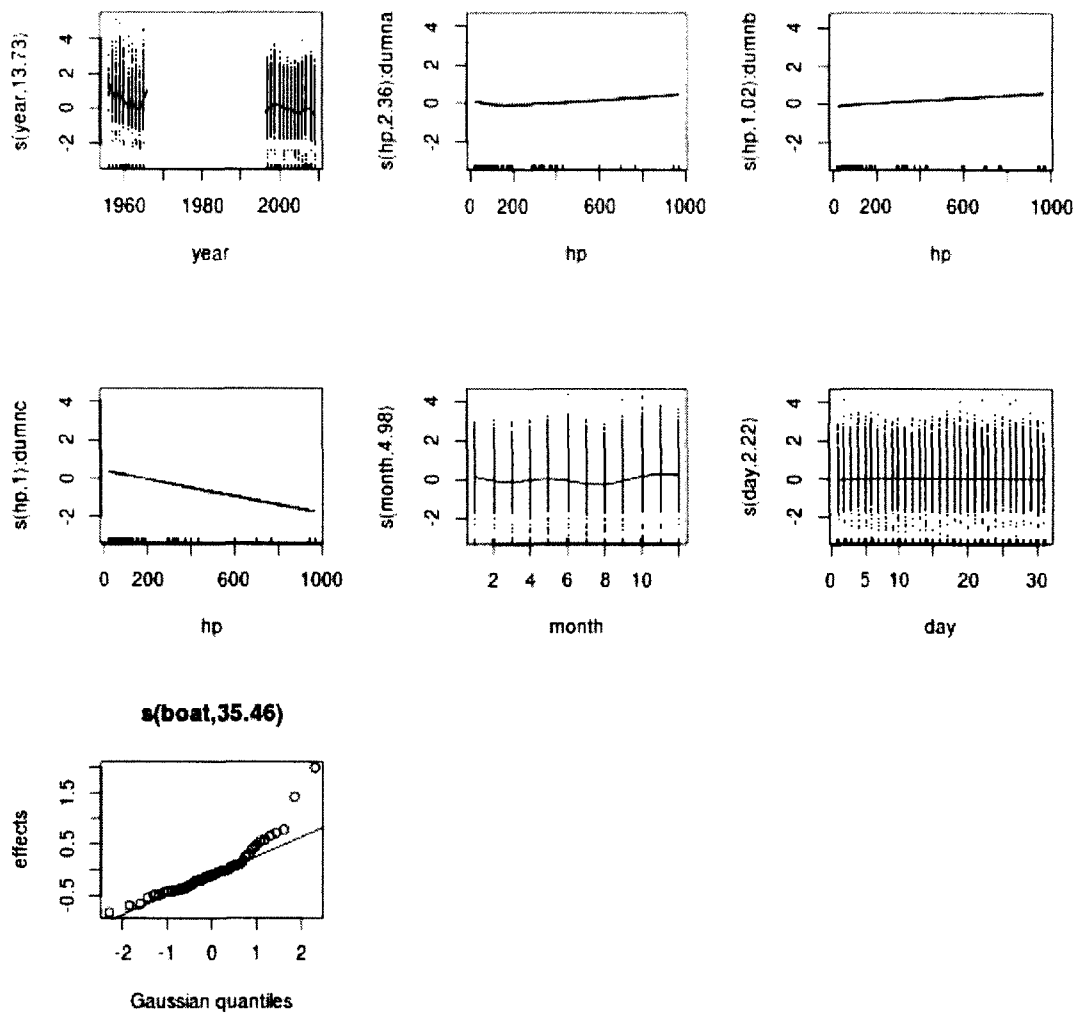

Figure 5-27. Estimated smoothing curves and random effects from the best GAMM model for *Mullus* sp. in the Blanes (Catalonia) trawl fishery, with 95% Confidence Intervals.

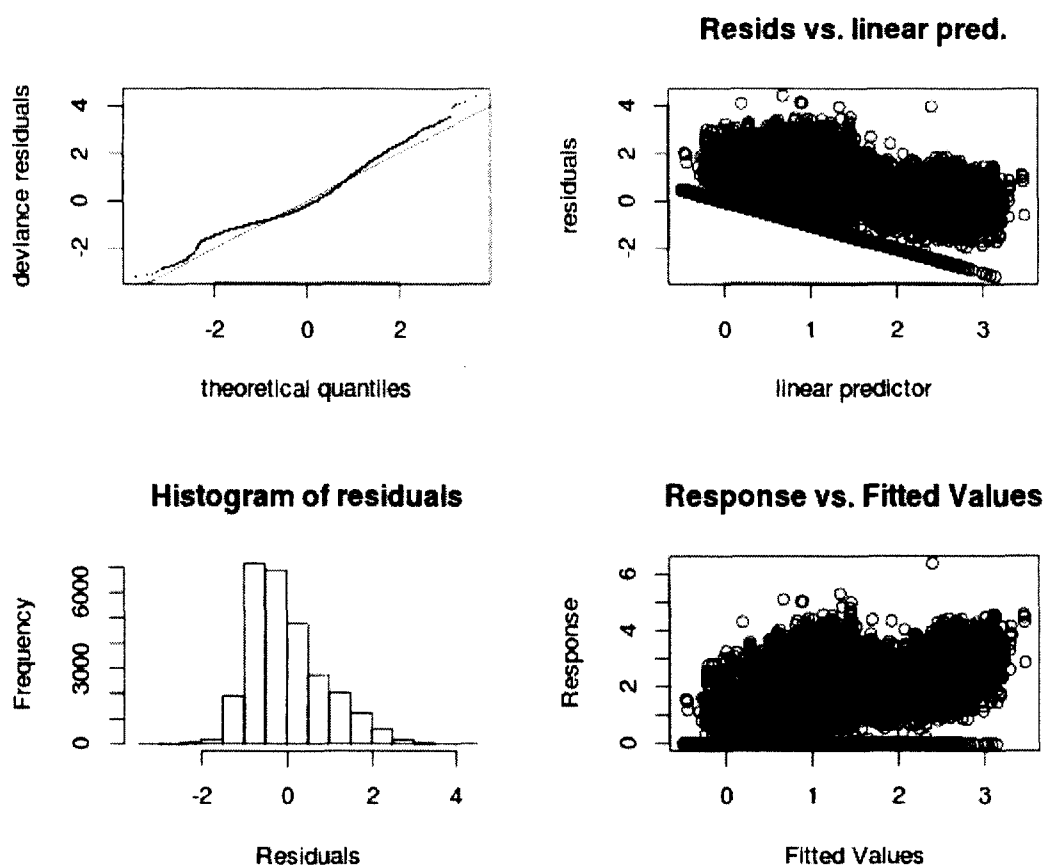

Figure 5-28. Model diagnostics for total model for *Mullus* sp. in the Blanes (Catalonia) trawl fishery, with 95% Confidence Intervals.

The summarized yearly trends for Mediterranean hake (*Merluccius merluccius*), red shrimp (*Aristeus antennatus*), blue whiting (*Micromesistius poutassou*) and red mullets (*Mullus* sp.) are plotted in Figure 5-29

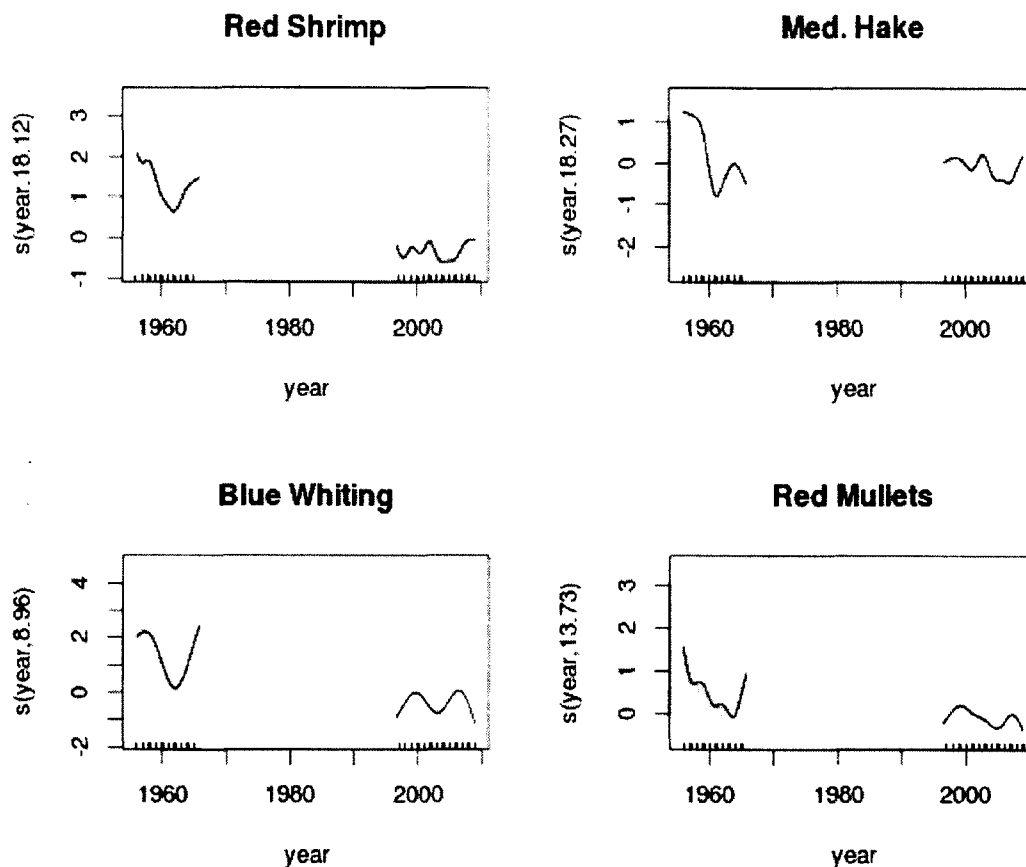

Figure 5-29. Standardized LPUE for Mediterranean hake, red shrimp, blue whiting and red mullets in the Blanes (Catalonia) trawl fishery, with 95% Confidence Intervals.

5.4 Discussion and Conclusion

5.4.1 Clustering of métiers

CLARA analysis identified a similar number of clusters in the modern and old periods, with most trips being identified in a clear way. Exceptions are some trips in clusters 1 and 3 in the old series (Figure 5-1) and a relevant number of trips in cluster 2 in the modern series (Figure 5-2). Inspection of the species composition returned a reasonable identification of

a coastal assemblage (50-200 m depth) and intermediate assemblage (150-300 m) and an upper slope assemblage (400-800m).

However, species composition in the clusters was not always coherent. In metier 1 in the historical data, one potential issue is the presence of *Aristeus* in what can be considered a coastal species assemblage metier. This is likely the effect of trawlers having a daily split strategy, i.e. some deep hauls (below 400 m where the *Aristeus* spatial distribution starts) and some coastal hauls. This is problematic since the catches appear on the same fishing day and, in clustering, the individual trip needs to be allocated to one cluster only. The high selling price of red shrimp could partially explain the interest of landing some on each fishing trip. In fact, Deporte and Ulrich (2012) [248] argue that true targeting is better identified if, instead of modeling weight, the value of a species is used. In our case daily landing prices were not available and this approach was not possible.

For the purpose of LPUE standardization, the higher the number of species and clusters, the higher the difficulty in selecting the number of comparable clusters, in particular if different and separate time periods are used, as in this analysis. This attempt at identifying contemporary and historical metiers is the first that we are aware of. In the EVOMED project a similar analysis was done on LPUE data from Tuscany and the number of clusters emerging was 8-10 [14]. In similar work in Greece it was found that the best clustering was with 13 metiers [257]. With such high numbers of metiers and temporal segregation, checking for coherence and comparable metiers becomes much more difficult and this approach might reach its limits.

An interesting application of this method is relating nominal fishing effort to different metiers. Thus it can give important insights on seasonal fishing patterns and yearly strategies as well as on effort partitioning across different assemblages, as applied here and by Castro et al. (2010) [250].

Deriving fishing effort for historical and contemporary data is extremely important for understanding and validating standardized LPUE trends and current exploitation levels estimated in the assessments. The results shown for Blanes harbor (Figure 5-8) are co-

herent and show the same pattern observed in the Catalonian fleet, as reconstructed in Chapter 2.

5.4.2 Trend standardization

Four commercially important demersal species were analyzed to reconstruct temporal trends in LPUE. These species have always had good market value, are rarely subject to discarding and have been consistently identified over time. All display large declines in relative biomass, although red shrimp and blue whiting display larger declines than Mediterranean hake and red mullets.

The use of a swept area factor as an offset has a relevant effect on the standardized trends. The justification for and the use of a correction factor for swept area (A_1) has already been discussed in Chapter 3. However, here species specific and other considerations can be addressed. The higher vertical spread of most modern trawl gears (2-6 m depending on the net and region) versus older nets ($< 1m$) [121] has been suggested to increase gear efficiency for species associated with the water column [128], i.e. for benthopelagics like Mediterranean hake and blue whiting, and less for bottom associated fish such as rays. Castro reports a similar case for blue whiting [250]. In the North Sea, the introduction of the Vigneron-Dahal net in 1923, which was the first high opening trawl (GOV), returned total catches that were 7% to 114% higher (with the exception of a -3% in one specific month) than the standard otter trawl deployed by the British fleet. These were due to a larger swept area and higher headline [258]. In particular for hake, increased efficiency was largely attributed to the higher headline [258]. In the Mediterranean, GOV nets were tested in the 1960s and introduced commercially in the 1970s [?]. GOVs were recognized to increase catch efficiency of species like hake. For example, Maurin conducted comparative trawl experiments with a traditional and GOV net and found that the latter could catch up to 10 times more hake [241], although this observation was not statistically tested. Bas et al., in considering the technological evolution of trawl nets in the Catalonia fishery, specifically mention net dimension doubling from the 1960s to the 1990s [57, p.180], along with an increase in headline height from less than 1 m to between 4.5-6 m.

Hypothetically, a modern trawler of equal HP to an old one, could tow a net twice as wide and four to six times higher, thus effective swept volume could be roughly 8 to 12 times greater. Of course, swept volume does not affect all species equally, as argued before, but certainly for those that don't live strictly on the bottom it can have a great impact. This shows again that the swept area correction factor of 2.3 used in these analyses, is very conservative in general as well as for most species standardized here, with the possible exception of *Mullus*.

While the use of more advanced statistical methods has helped to standardize catch rates against many explanatory variables, and to account for within vessel autocorrelation, the changing spatial characteristics of most fisheries (and data sets) is an additional challenge for constructing reliable indices of stock abundance [243]. For example two problems were not solved in the EVOMED (2010) and in prior Mediterranean LPUE standardizations [?] due to the lack of VMS data: the spatial origin of the catches was not modeled as no information was available, and the quantification of effort was potentially misspecified. Knowing the area fished is key to monitoring change in fishing grounds or the shrinkage/expansion of fished areas which, depending on density dependent CPUE behavior (hyperstability-hyperdepletion), can bias LPUE indexes [41]. With metier identification the lack of spatial data was partially substituted by the identification of broad fish assemblages which are associated with specific depth ranges, although some can be quite wide. This allows for selection of a coarse habitat, however change in fishing grounds within a given habitat might be harder to identify.

The analysis of individual vessel VMS data would return the fishing area of each trip with high resolution. It could also potentially provide effective fishing time by disclosing the number and duration of hauls. Standardization would be much more reliable if fishing area was used either as a second random effect or a simple factor, and if LPUE was estimated as kg/fishing hours instead of kg/fishing day. Of course VMS data are almost impossible to access for scientific purposes and thus metier identification is a method currently available that seems robust enough.

Demersal stocks in the Catalan Sea (GSA 6) are assessed under the premises of STECF or GFCM (Figure 5-30). Only a few demersal species are assessed routinely. Assessments rely only on landings, discards and effort data from the past 8 years (2002-2010) and MED-ITS experimental trawl survey since 1994. For the assessed species the F/F_{msy} ratios are extremely high indicating exploitation rates several fold above sustainable, and that effort should be largely reduced. This confirms the yearly trends of the standardized LPUEs, especially when observing the historical and contemporary levels of fishing effort (Figure 5-8).

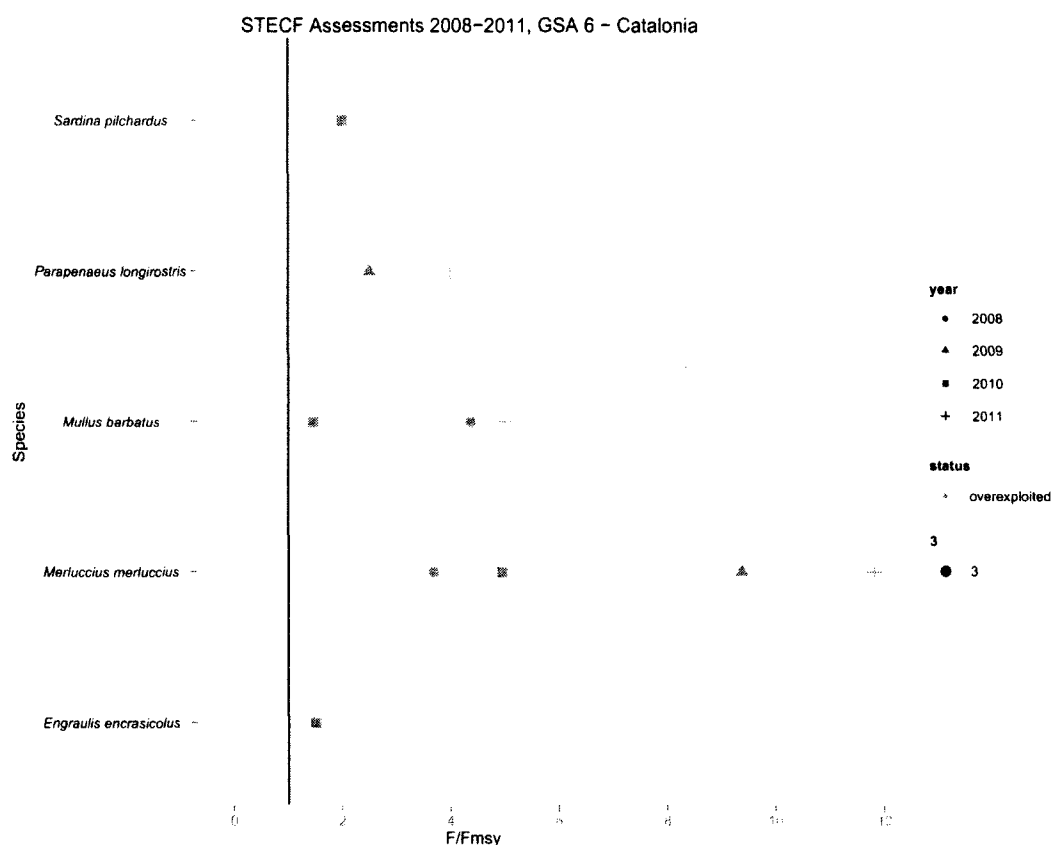

Figure 5-30. Summary of the exploitation levels of some stocks for which status was assessed by STECF working groups from 2008-2011. For the ratio F/F_{msy} on the x-axis, a value greater than 1 means the stock is overexploited.

STECF assessments rely on data from the past 15 years and correctly assess the exploitation level of demersal stocks in the Catalan Sea. However, with such a short time series it

is very difficult to make any robust estimate on how far the current stock biomass is from historical virgin biomass size, especially given the long fishing history in the area. The importance of analyzing historical data, as evinced here, is that trends in standardized LPUE can be a good proxy of a point intermediate to virgin biomass. Although fishing intermittently since 1956, the trawl fleet in Catalonia had been operating with motor trawlers since 1941. But before the interruption of the Spanish Civil War, motor trawlers had already been in service in the 1920s (see Chapter 2). And before that sail trawlers operated since the mid 18th Century. Having realistic estimates of stock biomass requires a long view. This is very important for estimating carrying capacity and, ultimately, the recovery potential of demersal Mediterranean fish stocks.

CHAPTER 6

CONCLUSIONS

6.1 Main Conclusions

Here we summarize the research presented in the previous chapters, discuss what it means and speculate about its implications for fisheries management and for the potential of recovery of demersal fish stocks.

6.1.1 Data mining and bibliography

An extensive search of historical data sources and publications has been carried out in different countries of the Mediterranean. This implied learning and understanding technical terminology in Spanish, Catalan, French, Italian, English and even Croatian. The libraries of most fisheries and marine biological laboratories, statistical institutes and general libraries have been researched and material acquired via digital photographs later assembled in PDF documents. Relevant data sources were transcribed and entered in digital databases.

An almost equivalent amount of time was dedicated to accessing current data sources from multiple countries. This required making contacts and creating new research collaborations. In a few cases, legal actions were necessary, as in Italy where the freedom of information law had to be used to access trawl survey data. To date we have built the largest compilation of historical fisheries information existing in the Mediterranean region, and one of its main strengths is the diversity of data types. The database includes fishing effort, landings, trawl survey and commercial LPUE data covering the western Mediterranean over time periods, albeit very heterogeneous, from 1700 to present. Trawl survey data and landings were not used for the research presented here, but were foundations

of the EVOMED project that has been frequently cited throughout these chapters. The assembled databases have an enormous potential for future research.

6.1.2 Evolution of trawl fishing gear and effort in NW Mediterranean

Understanding the duration and intensity of human exploitation of demersal marine resources is an important key to identifying when those resources were in a virgin and unexploited state. In addition, from the history of fisheries development, which is ultimately a proxy for fishing pressure and fishing mortality rates, and from fluctuations in the stocks we can infer past responses to human exploitation and the potential for recovery. The goal here was to quantify vessel growth rates, HP growth rates, and expansion of fishing grounds over the past 300 years to understand changes in fishing pressure. Different sources of historical data were collected for Italy, France, Spain and Tunisia with the first quantitative record of trawling dating as far back as 1634. Historical trawling effort shows that Mediterranean demersal communities underwent a much longer and more systematic exploitation than previously thought, very likely the longest known exploitation by means of trawls in Europe and North America. All fishing effort between 1600 and 1900 was in waters shallower than 100 m and the likely impact on nearshore fish communities was already high even before the development of motorized trawling: LPUE series, like the Valencia series in 1795, already showed declining LPUEs.

Our analysis, via modeling and by reconstruction of census statistics, has estimated the timeline of the development of the trawl fishery fleet in the NW Mediterranean. These estimates were challenging because of missing data for many ports and many years, especially before 1900. Yet the numbers are striking, with changes in the number of vessels of 2 or more orders of magnitude prior to the revolutionary shift from sail to motor vessels. When, as index of nominal fishing effort, we reconstructed the cumulative engine horsepower for the fleet, including an estimated HP of sail trawlers, the increase in fishing capacity was even larger than by accounting for vessels only, in particular after WWII.

In general, analysis of the data available for the Catalanian, Italian and French areas showed a clearly emerging pattern: fishing capacity increased in Mediterranean EU coun-

tries up to and through the 20th Century until the 1980s-1990s, depending on the area. From that period on, fleet size has been decreasing steadily as a result of different national and European decommissioning programs. However, it is unclear whether this decrease in vessel numbers in the last 20 years has been accompanied by a decrease in fishing power and fishing mortality on the stocks because engine power is usually underestimated in the entire region and fishing technology has much improved over the last decades. The reconstructed levels of fishing effort explain well why 100% of the assessed demersal stocks are overexploited [26].

To complement the analysis and gain insight about the technological impact on demersal catch rates, the evolution of trawl gear was reconstructed. Our goal was to derive qualitative and quantitative estimates of increase in fishing power and improved gear performance. The rate of adoption of new technology (synthetic nets, hydraulic winches, navigation equipment, etc.) was reconstructed by area and the effect of these improvements on catch rates was discussed. Analysis of the change in the horizontal opening in trawl nets over time, parameter A_1 , proved that, with the adoption of new net material and net rigging, the actual size of the net, for the same vessel HP, almost doubled over 40 years. The model accounted for increase in HP and used actual gear sea trials with nets from very different periods, which was never attempted before. This result is fundamental for subsequent LPUE standardization but also has direct implications for fisheries management. In the Mediterranean there are no catch quotas but management is regulated through effort control, which is based on the control of nominal effort ($Kw * Fishingdays$) by fleet segment and metier. While such an indicator can correctly represent fishing mortality over short time spans, over long periods it will fail to incorporate technological improvements of the nets and other gear. Thus, even if nominal effort stays constant, effective effort can go up. Our estimates show that, over 50 years, failing to account for technological improvement can yield a dangerous underestimation of true fishing effort, as exemplified in Chapter 3 for the Blanes fleet. Thus an effort based management needs to take technological improvements in nets and other gear into account, in addition to numbers of vessels, tonnage and HP when assessing sustainable levels of fishing effort.

The importance of having robust estimates of change in fishing power is clear since the early work of Garstang in 1900 [222]. Almost no estimate was available in the Mediterranean region even for relatively recent times. This is the key information for a robust standardization of commercial LPUEs/CPUEs. We derived some catching power coefficients among sail trawlers, steam and motor trawlers in historical period, although we conservatively decided not to use them in the LPUE standardization of total commercial catch. Instead, as a catching power correction we used the increase in horizontal opening, A_1 , in which there was more confidence. Applying A_1 as a model offset parameter in LPUE standardization is equivalent to using a correcting factor for fishing power of approximately 1% per year over 80 years, or to 2% over 50 years. The literature returns correcting factors similar to these, corroborating our correction for fishing power increase.

6.1.3 Trends in total demersal commercial biomass LPUE

Reconstructing relative trends in demersal species abundance was one of the primary goals of this project and the intention was to go as far back in time as possible. Since experimental trawl surveys did not start until the late 1940s it was decided to use commercial LPUE data that were available starting in the 18th century. LPUE can be useful when trawl survey data are not available although the analysis can be difficult as trends in fish stock abundance tend to be confounded by change in fishing power of the trawl fleets, as well as by changes in fishing strategies and grounds. One drawback of the available LPUE is that all the historical data are aggregated to total commercial catch, thus shifts in species assemblages were not detectable.

To analyze LPUE data the main assumptions were: HP of a sail trawler is equivalent to 40 HP, for this we relied on calculations in Chapters 1 and 2. Discard rates were considered comparable in time. Catching power/swept area, A_1 , was included in the models as an offset. A first set of analyses was carried out by individual fishing areas/countries with consistent data going back only to 1950. In Blanes, France, the Adriatic Sea and the Sicilian Channel, the drop in biomass was extremely large, although the latter two model areas did not display optimal residual patterns. In Tuscany the temporal trend since the mid

1960s appears flat but in this analysis the historical data are likely underestimates and a fishing power correction was not used. The second set of analyses pooled all available data together, including LPUEs from sail and steam trawlers from the beginning of the 20th Century and covered the entire western Mediterranean. When LPUE kg/fishing day was modeled, the highest relative biomass was identified in the 1920s with a second lower peak in the 1960s and contemporary biomass even lower.

Assuming that LPUE is proportional to abundance, results show that demersal stocks have greatly declined over time. The further back the series was reconstructed, the larger the decline in demersal biomass. This is a quantification of the shifting baseline syndrome: today we are assessing stock solely based on data from the past 20 years, which correspond to the lower part of the trends in all models, so that we have no knowledge of the extent of the decline.

Apart from a historical decline in elasmobranchs identified in the EVOMED project, it does not appear that compensatory mechanisms operating on a 50-100 year scale were sufficient to mask the steep decline in demersal biomass even if a shift in demersal assemblage composition occurred.

Finally, analysis of total biomass in addition to some individual species biomass seems to show that, in some cases, the decline in standardized LPUE stopped in the last decade, and there are tentative signs of an incipient rebound. Whether this is a consequence of the effective reduction in fishing mortality or of a new increase in fishing power is unclear.

6.1.4 Individual species Blanes

Individual species LPUEs were available over 50 year time spans, in only few cases. Therefore a case study was built with data from Blanes (Catalonia). The lack of information on catch location and on the populations fishermen targeted, in a mixed fisheries context, required particular caution when standardizing LPUEs. A two-step analysis implied, first, a clustering analysis with CLARA to identify fishing assemblages and fishermens targeting strategies. Clusters were used for identifying fishing behavior and for discarding non-relevant fishing trips from the standardization of individual species. The second step

entailed fitting GAMMs in an analysis similar to that for total demersal catch, with only the incorporation of a catching power correction as an assumption. Standardization was done on selected clusters of fishing trips for 4 important commercial species: red shrimp, Mediterranean hake, blue whiting and red mullets. Results showed steep declines for red shrimp and blue whiting and important declines for hake and mullets, although for the latter, residual patterns are not optimal. Where possible results were checked against nominal fishing effort and stock assessment results, and there is agreement. For example, based on exploitation indicators for hake from STECF assessment, to reach F_{msy} fishing effort should be reduced by 85%.

6.1.5 Current demersal resource status

Currently, two international bodies perform stock assessment routinely in the Mediterranean: GFCM (under FAO), comprising all basin countries, and SGMED/STECF, which provides scientific and policy advice to the EC, however, only for EC member states. There is a fair overlap between the two organizations and, while a good number of stocks is assessed every few years, a lot of effort goes into assessing species based on each of the 27 geographical unit areas (GSA) that divide the Mediterranean Sea. While many stocks are assessed, very few species have a proper stock assessment. For example, only one elasmobranch is under evaluation and only some of the main commercially targeted demersal species are assessed: Mediterranean hake, red mullets, pink and red shrimp, Norway lobster, rarely common Pandora and few other species only for some local GSAs.

Stock assessment information has been extracted from assessment documents published by SGMED and GFCM. GFCM assessment documents give limit reference points ($F_{0.1}$, F_{max}) but don't report current levels of fishing mortality ($F_{current}$). SGMED reports deal mainly with the assessment of historic and recent trends in stock parameters (stock size, recruitment and exploitation) and relevant scientific advice. Reference points were given in terms of both exploitation rates and biomass for all the stocks concerned. SGMED recommended the application of $F_{0.1}$ derived from Yield per Recruit analysis as the appropriate proxy for F_{msy} (maximum sustainable yield) in case of lack of data or uncertainty

[259]. On the other hand, state indicators of stock size in terms of biomass are difficult to interpret as changes in biomass in relation to reference levels such as B_{lim} and B_{pa} . Also, the short time series for most Mediterranean stocks, the fact that landings are regarded as uncertain and also the lack of historical data impede the establishment of such biomass reference points [260].

According to STECF SGMED there is no evidence of a general decline in fishing capacity of the Mediterranean fleets although this might be also the result of changes in the classification system (i.e., from polyvalent to a specific gear type)[26]. SGMED stressed multiple times that recovery plans should be developed and established with urgency in order to achieve advised effort reductions and those recovery plans should be enforced until the stocks are proved to be exploited consistently within the sustainability targets.

Reference points extracted from the last assessment (SGMED 11-02) are summarized in Figure 6-1 where each plot represents the Mediterranean statistical areas. Species for which assessments are performed are on y-axis, and the x-axis, in *log* scale, reports the ratio of F/F_{MSY} , where, as proxy for F_{MSY} , $F_{0.1}$ is used.

Table 6.1.5 summarizes mortality reference points for Mediterranean demersal stocks assessed by SGMED and GFCM and the reduction in F needed to achieve sustainable exploitation.

The few demersal species under assessment, in almost all cases, show overexploitation. Overall, current levels of fishing mortality are unsustainable throughout most of the EC Mediterranean countries and, to achieve sustainable yields, fishing effort should be reduced approximately between 20 and 85% depending on the stock. What should be further considered is that the species assessed are among those with the highest productivity and resilience, meaning that they are the most fit to sustain moderate and high exploitation rates. If elasmobranchs with low fecundity and slow growth are taken into consideration, it is clear that depletion levels must be much higher than those evaluated in stock assessments of bony demersal fish.

Changes in species assemblages can be the consequence of important fishing impacts that go undetected when working with fish landings where species are grouped at high

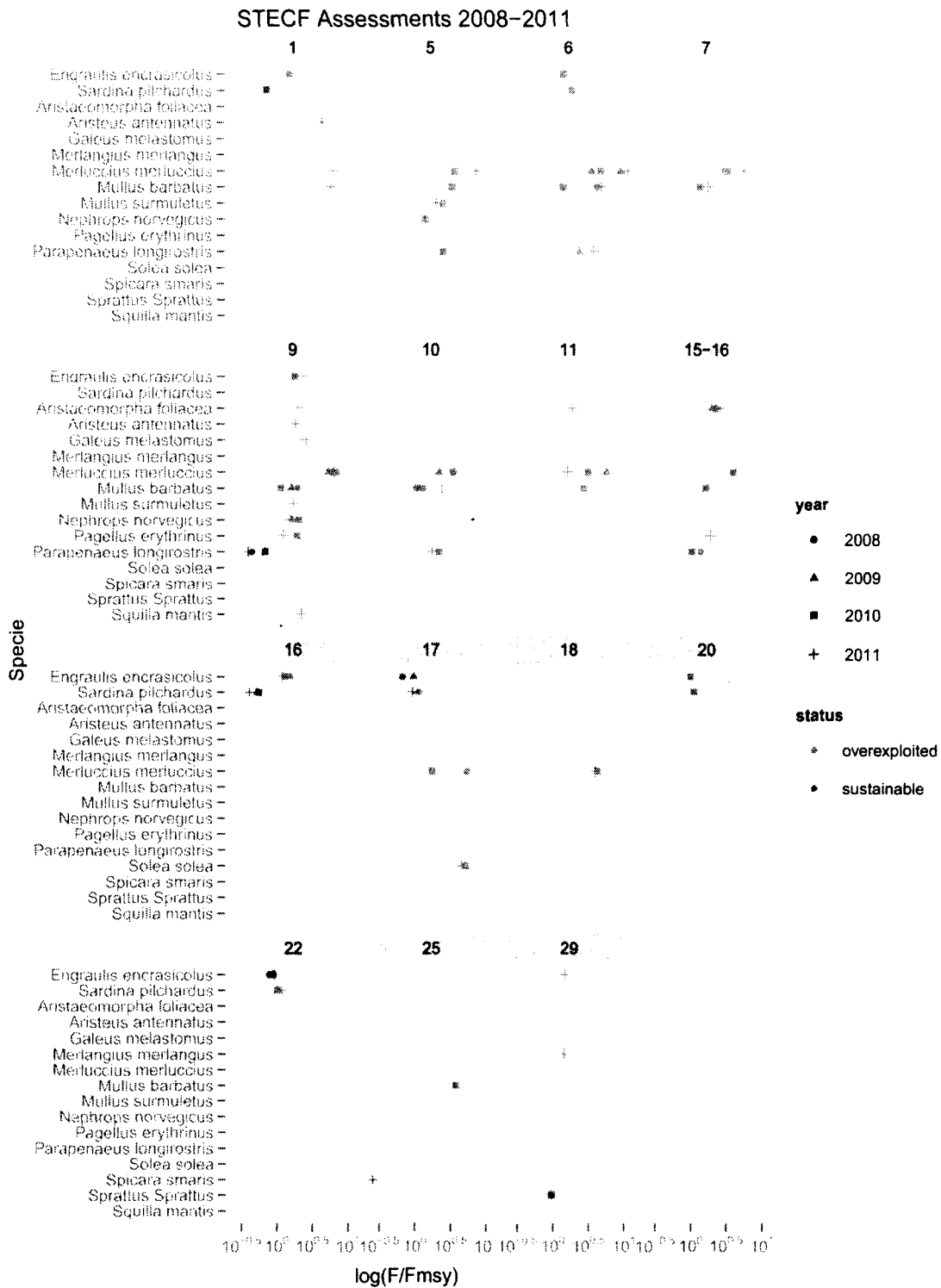

Figure 6-1. Summary of the stock assessed by STECF in the Mediterranean Sea over the period 2008-2012. The fishing mortality reference point is the ratio between $\log(F/F_{MSY})$, where $F_{0.1}$ is used as a proxy for F_{MSY} . Stocks > 10 are considered overexploited and < 10 are sustainable. For small pelagics, the reference point is $E = 0.4$

Area	Specie	$F_{0.1}$	F_{max}	$F_{ref,2009}$	% Reduction in F	Source
GSA5	Hake	0.22	0.37	0.84	-74	SGMED 02-10
GSA6	Hake	0.17	0.25	1.12	-85	SGMED 02-10
GSA7	Hake	0.27	0.40	0.92	-71	SGMED 02-10
GSA9	Hake	0.22	0.35	0.22	0	SGMED 02-10
GSA10	Hake	0.17	0.23	0.61	-72	SGMED 02-10
GSA11	Hake	0.19	0.28	0.26	-27	SGMED 02-10
GSA15-16	Hake	0.26	0.32	1.01	-74	SGMED 02-10
GSA17	Hake	0.32	0.65	0.69	-55	SGMED 02-10
GSA5	Red Mullet	0.32	0.81	1.08	-70	SGMED 02-10
GSA6	Red Mullet	0.74		1.08	-31	SGMED 02-10
GSA7	Red Mullet	0.49	0.71	0.69	-29	SGMED 02-10
GSA9	Red Mullet	0.49		0.73	-33	SGMED 02-10
GSA10	Red Mullet	0.41	0.81	0.77	-47	SGMED 02-10
GSA11	Red Mullet	0.32	0.50	0.47	-32	SGMED 02-10
GSA5	Pink shrimp	0.31	2.22	1.11	-72	SGMED 02-10
GSA9	Pink shrimp	0.70		0.58	21	SGMED 02-10
GSA10	Pink shrimp	0.54	0.71	1.16	-53	SGMED 02-10
GSA16+15	Pink shrimp	0.72	1.50	1.49	-52	SGMED 02-10
GSA15	Striped Red Mullet	0.33	0.66	0.31	6	GFCM SCSA 2009
GSA05	Norway lobster	0.42		0.62	-32	SGMED 10-02
GSA09	Norway lobster	0.21	0.36	0.30	-30	SGMED 10-02
GSA05	Striped Red Mullet	0.29	0.76	0.76	-62	SGMED 10-02
GSA09	Common Pandora	0.13	0.17		-50	SGMED 10-02
GSA03	Bougue	0.36	0.62			GFCM SCSA 2009
GSA05	Red Shrimp	0.57	1.24			GFCM SCSA 2008
GSA09	Thornback ray	0.23	0.33			GFCM SCSA 2008
GSA09	Thornback ray	0.06	0.09			GFCM SCSA 2008

aggregation levels. Shifts in assemblage can indicate ecosystem changes and are important to investigate for ecological and management reasons. In the analysis of total biomass in Chapter 3, no specific analysis of fish assemblage was possible due to high aggregation of the data. In the EVOMED project demersal species composition was investigated using the best available historical and contemporary trawl survey data in the northwestern Mediterranean, correcting for area swept by the sampling net, as these are not biased by species aggregation, discard or differential targeting by fishermen [14]. The results, although qualitative, show that, in surveys traced back to the 1950s and 1960s elasmobranchs represented a much higher percentage (30-40%) of the assemblage than in recent times (less than 10%), as is the case in the Adriatic and Gulf of Lions. Elasmobranchs show no clear trend from the '60s to recent times in Corsica, varying between 20-30%, while in the Catalan Sea there seems to be a recent increase. These results are confirmed by recent

papers [195, 65, 261]. Relative composition in the French LPUEs also confirms the decline of elasmobranchs: sharks in the 1950s represented 11% and rays 17%. In the 1970s, although disaggregated, sharks and ray dropped to less than 8% and in modern catch are at much lower levels since, by individual species, none exceeds 0.4% of LPUE (Figure 4-15). Demersal fish have generally maintained or slightly increased their assemblage share through time, with a clear exception of the Catalan Sea where in the deep stratum there has been a sharp increase [14]. Pelagic and Nektobenthic fish don't show a clear trend, also with the exception of the deep stratum in the Catalan Sea that has had a lower contribution in recent times [14]. Cephalopod percentage contribution is higher or equivalent in recent times to that in the historical surveys. Crustaceans were more abundant in the 1970s in Catalonia and are more abundant today in the other areas investigated [14].

Overall, the decline of Elasmobranchs is the most dramatic, except in Corsica where trawl fishing effort has been historically low if not negligible. The loss of top predators has very likely led to top down effects (predator release) on species with high reproduction and fast growth potential such as cephalopods as well as some species of shrimp (like *Parapaeneus longirostris* as in the case of GSA9) and red mullets (GSA 9 and 6). The apparent stability or increase of demersal fish might be largely driven by species like mullets and the stability of some species which have long been overfished and are now at low but stable levels.

6.2 Fisheries Recovery

From stock assessment and even more from the results of this research, the urgency of implementing recovery plans for demersal fish stock in the western Mediterranean emerges clear and strong. Action should and must follow. We now outline some concepts pertaining to rebuilding fish stock. The concept of recovery is likely a consequence of acknowledging impacts caused by anthropogenic activities. The idea of recovery stems from the will to return to a previous congenial state that was either pristine or sustainable. While generically there is agreement on the fact that recovering entails going back to some state in past, there are different views on the subject of recovery.

Recovery can be seen differently from the perspectives of a fisheries scientist/manager and an ecologist. Fisheries scientists and managers come from a background of specialized attention to single species stocks. Traditionally in this field, recovery is considered for one stock at a time [43, 262, 263]. Ecologists used to studying and approaching ecosystems from a community level have a more holistic approach to recovery. Much attention is given to habitat, biodiversity, food web dynamics and species interactions [264, 265, 40, 25]. These separate approaches are increasingly mixing as the failure of many stocks to recover force scientists to think about ecosystem effects and/or species effects.

Clearly stock recovery can be initiated only with awareness and scientific evidence of a change or degradation in a stock, or overfishing. Shifting baselines in fisheries management cause slow but continuous declines in resources that scientists cant measure [22]. Once a baseline is identified and the need to implement a successful recovery acknowledged, there needs to be: (1) a set of controlling factors in the political and policy framework (e.g. the part of the system that we can control). (2) a set of factors in the biological and environmental domain (e.g. the part we can't control).

6.2.1 Metrics and stock properties for recovery

Specific metrics are used to measure stock decline and recovery (reference points) and different properties of fish stocks that have an impact on recovery. Reference points stem from the fundamental relations in surplus production models, where the concept of MSY first developed. Most reference points revolve around fishing mortality (F), biomass (B) and yield (Y). F is the only parameter that can be actively regulated while B and Y are used as targets. We can distinguish between Target Reference Points (TRP) and Limit Reference Points (LRP). TRPs have been traditionally considered the target that management wants to achieve. LRPs may correspond to some minimum threshold that, if passed, would put the stock at risk. These are the criteria most widely used to regulate a fishery, to set targets for recovery, and to measure performance over time. The best known reference point is Maximum Sustainable Yield (MSY) which corresponds to the peak of the curve of the relationship between the annual standard total fishing effort and the yield at equilibrium[42].

MSY has historically been the main TRP and is still the main reference point in the UN Law of the Sea and in the EU CFP. MSY, however, can be estimated only after it has been exceeded and overfishing initiated. As initial yield are high, the tendency is to overshoot MSY [41] and for this it is heavily criticized [266]. In addition MSY cannot be measured exactly and is estimated at equilibrium, which is a rare state of affairs [267]. Using MSY has proved risky from a management point of view and more “safe” reference points have been developed. The mortality equivalent to MSY is F_{MSY} and if catchability is known this can be converted to fishing effort f_{MSY} .

An alternative reference point commonly used is the Yield per Recruit Criteria and is based on age and size at recruitment. F_{max} is the level of fishing mortality for a given size at first capture, which maximizes the average yield from each recruit entering the fishery [43]. These criteria, like MSY, failed in different contexts as they don't account for reduced spawning potential when older and larger spawners are removed. Caddy (1995) [43] argues that F_{MSY} and F_{max} should be used only as LRPs.

The $F_{0.1}$ criteria was developed to be more conservative than F_{max} . $F_{0.1}$ is the fishing mortality rate at which the slope of the yield per recruit curve, as a function of fishing mortality, is 10% of its value at the origin. Although this is an arbitrary criteria, $F_{0.1}$ has been and is still very commonly used, for example, in the Mediterranean STECF assessment [26] or in ICES. This TRP is sensitive to the accuracy of commercial reporting and other sources of bias and it is criticized by some authors [43, 268]. In addition, both F_{max} and $F_{0.1}$ are sensitive to assumptions about M which can be assumed to be high or too low. Assumptions about M are often taken without a full realization of the impact they can have on assessment and in many cases it is a well-known fact that catches, even in modern data, can be unreliable.

The above TRPs do not take into account spawner-recruitment (S-R) effects and, given the difficulty of determining the exact S-R relation, in data poor situations B_{max} is often uncertain [42]. In the STECF Mediterranean assessments both considerations apply. In conjunction with the use of only very recent data very far from a virgin status, TRPs can return estimates that are not entirely reliable. The incorporation of historical data in stock

assessment is thus particularly important for the Mediterranean even if it will present analytical challenges.

Life history traits of individual species can play an important role on a populations capacity to recover. Hutchings and Reynolds (2004) [269] showed that age at maturity is negatively associated with maximum population growth and potential recovery rate. Fecundity, if not very low, is unrelated to recovery. Thus, large maturing species recover slower than fast maturing ones and fast growing species recover faster than slow growing ones. If the same applies in the Mediterranean, fast growing species such as mullets, hake, cephalopods and shrimps will recover rapidly if the fishing mortality drops enough.

Evolutionary response to selective sustained fishing can affect size and age at maturity and negatively influence recovery chances [197]. We have shown how the historical developments of trawl fisheries have exercised an increasingly strong pressure on demersal stock. This must have had evolutionary effects on the life history traits of species that were not eradicated, like several elasmobranchs [195, 65]. No research has been done in this sense in the Mediterranean, but certainly it would be a very good test case.

There loss of genetic variability when stocks reach very low population levels can be detrimental to recovery [?, 199]. Based on life history traits and low population abundance, recovering elasmobranch populations in the Mediterranean will be much harder, especially in the context of a mixed trawl fishery. Sustainable mortality levels for elasmobranchs would very likely cause the fisheries to shut down and this is one of likely reasons why they are often neglected in stock assessments.

6.2.2 Policy framework to recovery

Policy frameworks, and mostly politics, are essential in determining and implementing recovery plans, and on their success.

In the United States, a very strong statutory mandate to end overfishing and rebuild depleted fishery resources came into effect with the Magnuson-Stevens Fishery Conservation and Management Act of 1996. The law sets out specific timelines for action to rebuild depleted fisheries, establishes requirements for recovery management plans, and

requires accountability for implementing plans in a timely manner [270]. Recovery must be achieved within 10 years and the recovery is set to reduce fishing mortality at F_{MSY} and to achieve the equivalent biomass B_{MSY} .

In Australia a policy for Fisheries Harvest Strategy was implemented in 2007 [271]. Under this policy is a provision that, when a stock is below B_{LIM} , a rebuilding strategy needs to be implemented to rebuild to B_{TARG} . Stock above B_{LIM} but below B_{MSY} must reach B_{MSY} . In addition if a stock is below B_{LIM} further conservation measures can be implemented if risk to the stock is considered too high. Here B_{LIM} is the equivalent of the status of overfishing and when a stock is below this level a harvest control rule automatically halts any fishing and implements a recovery plan.

In Europe, no policy framework automatically mandates recovery plans. For example, in the North Sea, an assessment by ICES is needed that determines overfishing and calls for recovery. Then the European Commission should put in place measures that will aid recovery [262], but these need the approval of the European Council [Verify], which operates in the political arena and where plans and quotas can dramatically deviate from scientific advice.

While Europe does not yet have a clear policy, the US and Australian policies are recent, comparable in their goals and have automatic provisions that explicitly call for recovery plans. The process of defining recovery targets and time-frames is a lengthy and confrontational process that involves scientists, managers and stakeholders. Once a recovery plan is proposed three aspects influence the outcome: timing, targets and implementation.

Timely implementation of a rebuilding plan is essential as delayed action will allow high fishing mortality to further decrease the stock. Shertzer and Prager (2007) [272] examined the biological consequences of management delay. They found that increased delay required larger reductions of TACs, for more years, to recover to desired stock levels. In contrast, timely management resulted in quicker recoveries and higher cumulative yields in simulated fisheries. Rosenberg *et al.* [270] attributes part of the failure of many US rebuilding plans to long time frames that result in delays in reducing overfishing.

Explicit targets must be set in recovery plans, for example, the time frame for achieving B_{MSY} or the protocol for progressively reducing F . If much procrastination accompanies setting TAC, reducing F , or if TAC is set too high because of industry lobbying, there is an elevated risk of not achieving recovery. For example in the ICCAT Bluefin recovery plan the TAC is set so high that under various scenarios it would allow fishing the entire spawning biomass [273]. Rosenberg [270, 274] argues that many US recovery plans did not reduce F to F_{MSY} and this was the main cause of failure to recover to target levels.

Other important aspects of recovery plans are how much uncertainty there is in scientific assessments. Enforcing TACs or controlling discards and illegal fishing are also crucial for the success of a recovery plan, and, again, a master example of the three is the rebuilding plan of Atlantic Bluefin tuna [273, 275]. In addition, revisions of recovery plans often tend to allow for higher TAC or fishing possibilities, thus moving away from F_{max} [270, 262].

Hutchings (2000) [276] draws 3 main conclusions from his study of the collapse and recovery of fish stocks: (1) the rate of population decline is a predictor of its recovery. (2) if there was a decline of more than 60% in 15 years it is unlikely that there will be recovery after 15 years even at reduced fishing mortality. (3) the relation between collapse and recovery is species dependent. In a later study Hutchings and Reynolds (2004) [269] showed how the extent of reduced fishing rates (comparing exploitation 5 years before and after collapse), while necessary, did not always have an effect on recovery. There are stock, like cod, that even at reduced mortality (although insufficient), can't recover while species like haddock in the Gulf of Maine have almost recovered to B_{MSY} [277].

A few lessons can be learned from the examples above. It is clear that the more a population is fished down, the longer the recovery will take, if it happens at all. This is clear even though no case of 300 years of exploitation history like in the Mediterranean has been studied before. Controlling fishing mortality is necessary but not always sufficient as other factor can interfere with recovery. For example habitat loss, particularly the loss of nursery areas, changes in carrying capacity of the ecosystem, species interactions and ecosystem effect. All these lead to an increasing uncertainty about recovery prospects under strict

single species perspectives. Colloca et al. (2011) argue, specifically to the Mediterranean situation where there is high exploitation and a dramatic demographic truncation, that moving toward F_{MSY} for some species will be hard to achieve. In the case of hake they show that a strong change in trawl net selectivity is need other ways the reductions in F , as we discussed before, need to be so high that managers will never implement them.

We have described some of the limitations to single species recovery. For these reasons there is increasing interest and need for integrated approaches. Mangel and Levin (2005) [278] criticized single species stock assessments for their lack of capacity to integrate ecosystem effects and community responses with fishing mortality. They suggest that in many cases it is this limit in single species science that makes recoveries fail. They specifically suggest to move towards a community ecology approach for forecasting future recoveries.

Marine protected areas (MPAs) are increasingly seen as potential tools to integrate fisheries management [279, 280] and support recovery. It has been largely proved that once an area is declared an MPA, and protections actually enforced, fish increases in the range from 5 to 497 fold depending on the species[281, 282]. However, such increases are in the MPA, often only in CPUE terms, and unless there is migration and spillover of larvae, the biomass contribution to the fishery might not be large. There is wide debate on this issue. Worm et al. (2006) [72] found that, in MPAs, increases in biodiversity were associated with large increases in fisheries productivity, as seen in the fourfold average increase in catch per unit of effort in fished areas around the reserves. The difference in total catches was probably less pronounced because of restrictions on fishing effort around many reserves [72]. MPAs are not a silver bullet against overfishing, but will work as a buffer to fisheries management uncertainty. MPAs will increase biodiversity and biomass if integrated with fishing mortality control [279, 280, 283].

Stefansson and Rosenberg (2005) [283] found via simulation that combining catch quota control with a large closed area is a most effective system for reducing the risk of stock collapse and maintaining both short and long-term economic performance. The authors recommend that multiple control methods be used wherever possible and that closed ar-

areas should be used to buffer uncertainty. To be effective, these closed areas must be large and exclude all principal gears to provide real protection from fishing mortality.

From a broader perspective, some important ecosystem components can reduce the recovery potential of certain stocks. The first account of the effects of fishing on species interaction was given by D'Ancona in 1929 and 1949 [284, 203]. His early theory of predator-prey interaction actually inspired Volterra and the predator-prey equation. D'Ancona observed in the Northern Adriatic that, before WWI and WWII, the percentage of elasmobranchs was declining while teleosts were increasing under increasing fishing effort. After each war, during which fishing declined dramatically, he noticed that the percentage of predators (elasmobranchs) increased again and prey (teleosts) declined. He attributed these effects to fishing and stated that intermediate levels of fishing should be exerted to keep equilibrium in the ecosystem.

D'Ancona perhaps witnessed early replicated recovery experiments (WWI and WWII) and observed the importance of species interactions and vulnerability. As these two aspects are partially lacking in single species assessments there has been increasing interest in looking at broader ecosystem effects. This approach has direct implications for recovery. Ecosystem recovery is much more difficult to define than fisheries recovery, as the variables at stake are many more than B_{MSY} or F_{med} of a given species, the all-inclusive terms that measure recovery. There are different definitions of ecosystem recovery that derive from different fields and have their own metrics. However, all definitions and metrics can be grouped under the wide definition of Ecosystem Based Management (EBM). EBM can be tailored at fisheries [285] or general in approach. EBM is the way to account for uncertainty in the system and in management and correct implementation will allow for sustained socio-economic benefits without damaging the ecosystem. There is general consensus on the difficulties to implement EBM. It is difficult from a scientific point of view, as data requirements can be large, and from a policy point of view as integrated solutions are needed across different management agencies.

6.2.3 Recovery perspectives in the Northwest Mediterranean

In the northwest Mediterranean fisheries management is regulated partially by Member States and partially by the EC. The overarching fisheries policy are the EC Common Fisheries Policy (CFP) and the Mediterranean Action Plan (Council Regulation (EC) No 1967/2006). However, the latter mandates the states to write management plans and implement scientific advice (Article 18 [286]) and in principle all stocks should be managed at MSY by 2015, although discussion is underway for shifting the deadline to 2019. The EC has the right to review and amend proposed plans and does this via the technical consultancy of STECF. The EC funds survey and catch monitoring by ~ 50% (the rest is matched by States). In addition to STECF, newly implemented regional advisory committees (RAC) are called to provide stakeholder feedback. The General Fisheries Commission for the Mediterranean (GFCM) has the authority to adopt binding recommendations for fisheries conservation and management. It should play a critical role in fisheries governance but so far no major management measures have been implemented. One further complication in the Mediterranean Sea is that national waters only extend up to 12 nautical miles. From there on is international waters. No Mediterranean state has declared an EEZ with the exception of Spain that declared an Exclusive Fishing Zone. This implies that many coastal stocks are shared because they fall in international waters, and partially explains why regulating Mediterranean fisheries is so difficult. In addition there is no structural equivalent to the US NOAA NMFS, an inclusive governmental organization that performs research, assessments and regulations. So individual Member States can be strong advocates for national fishing interests and data collection is made at the national level. Fisheries science is scattered in multiple institutions, and the few assessments are done mostly on a local, small-scale basis despite the fact that most stock are likely shared across national boundaries [287]. STECF is now filling this gap.

From a policy point of view, all fisheries have been regulated so far on an effort control and technical measures basis. Effort it is intended to mean the number of vessels, and in some areas a month of biological rest is mandatory (no fishing). The trawl fishery is a multi-species fishery [59] where the legal mesh size of 40mm is hardly respected.

Such nets have virtually zero selectivity and juveniles make up a large fraction of the catch [287]. The main problem is that, while increased effort might have been prevented, the CFP failed to reduce effort (Green Paper on CFP (COM(2009)163 final)) and current effort levels are between 20-80% over a sustainable level, depending on species and area. In practice, Mediterranean stocks are not really managed. In fact there are no management plans in place, with the exception of the Spanish Mediterranean, a plan universally recognized for having entirely failed its goals [260]. A common misconception in the Mediterranean is that technical measures can drastically reduce fishing mortality. For example, monthly trawling closures are thought to be very beneficial when in reality they only allow fast growing fish to grow for an extra month, and landed soon after. Slight enlargement of mesh size and the transition to diamond mesh in trawl cod-ends can also improve selectivity patterns, but cannot realistically decrease F to sustainable levels. Reluctance to implement serious reductions in fishing effort often falls back on the disingenuous argument that technical measures are sufficient to achieve F_{msy} paired with keeping fishing effort at *status quo*.

As for the North Sea, no policy explicitly mandates recovery plans. If the Member States or STECF declare some stock overfished, the EC will mandate implementation of management plans that will recover the stocks to sustainable levels. So far in the Mediterranean there have been some proposals of management plans but none (with the exception of Spain) improved the status of the stocks.

The EC Mediterranean action plan has two strong points that might help achieve recovery, besides the effective implementation of realistic management plans with adequate reductions in effort. Articles 4 and 5 [286] explicitly call for habitat protection and for the establishment of MPAs. Both these tools can be key to help recovery and reduce F . The fact that a legal framework supports their implementation is an advantage. According to the regulation, habitat and MPAs should have been designed by Member States by December 2007 but so far only some zones of vulnerable habitats (maerl beds and seagrass meadows) are being designed. Protection, at least nominally, should be achieved soon, but

it will mainly pertain to small coastal areas. No large areas acting as fisheries closures are foreseen on the continental shelves.

Biodiversity in Mediterranean marine ecosystems is high [59] and it might play a role in the apparent resilience of some parts of the fish communities. Yet, overall biodiversity and its functional role are degrading and this can also have an impact in reducing recovery potential. Worm et al. (2006) [72] found that fished taxa richness was negatively related to the variation in catch from year to year and positively correlated with the total production of catch per year. This increased stability and productivity are likely due to the portfolio effect, whereby a more diverse array of species provides a larger number of ecological functions and economic opportunities, leading to a more stable trajectory and better performance over time [72]. In particular, a sensible hypothesis is that the widespread dramatic decline of marine predators such as elasmobranchs has reduced natural predation rates on prey species and, thus, natural mortality. These findings might explain the apparent resilience of some commercial stock in the Mediterranean and also give an insight in how marine communities may have a high chance at recovering and continuing to provide goods and services. In fact, in the few cases where fishing pressure from demersal trawling has been removed, the results have been remarkable. The Gulf of Castellammare, along with few other areas, shows the recovery potential that can be achieved by just establishing MPAs [288, 282]. If it could be supported with appropriate fishing mortality levels, the achievable results could be potentially greater. The effects of this closure on biodiversity have not yet been assessed. This will have to be done, as well as assessing the effects on vulnerable species such as elasmobranchs.

Recovery could be achieved in the northwest Mediterranean. The high biodiversity of this Sea supports it and most resilient species could rebound quickly thanks to their favorable life history parameters, fast growth and early spawning. Recovery can be achieved with a reduction in fishing effort and with a dramatic change in gear selectivity. Colloca et al (2011) [266] have shown the importance of the latter in particular.

It will be important to implement credible recovery plans for most demersal stock via adequate reductions of F paired with the establishment of large MPAs. The latter will

allow the recovery of vulnerable species that have life history traits that would not be unresponsive compatible with even reduced fishing mortality levels. As these stocks are rarely assessed and often data deficient a valid approach would be estimating the extinction fishing mortality $F_{extinct}$ [289] and adopting it as a precautionary approach. Fisheries management should reach F_{MSY} or F_{Lopt} as argued by Colloca et al. [266], as a first target but then move to safer target reference points like biomass reference points. The availability of historical data for total commercial catch could be used as a proxy for demersal assemblage productivity as a multispecies indicator. Where species specific commercial or trawl survey data is available, these can be valid proxies for estimating virgin biomass and carrying capacity and should be incorporated into stock assessments with the use of surplus production models that could return more realistic estimates on how far we are from virgin biomass. The historical decline in demersal biomass shows what the Mediterranean has been capable of producing in terms of productivity and, perhaps, where it could go in the future if proper political decisions were to be taken and fishing mortality reduced accordingly.

Unfortunately the current economic crisis will not facilitate drastic reductions in trawl fleet fishing effort as it would increase unemployment in the fishing sector in the short term. In the current economic environment, this will not happen easily even if fisheries yields will grow much higher in the long term. Likely the reduction of effort can only come from sustained high prices of fuel and depressed demand of fish, which in the Mediterranean is expensive. While we detected slight signs of increase in demersal stocks in the past few years, achieving full recovery will take much more drastic reductions in effort. At the moment this seems unlikely without a strong political will from Member States or serious mandatory policies from the EC to force the implementation of strong management plans.

BIBLIOGRAPHY

BIBLIOGRAPHY

- [1] Anon, "Statistiche del Regno d'Italia, navigazione nei porti del Regno," tech. rep., Ministero di Agricoltura, Industria e Commercio, Ufficio Centrale di Statistica, 1863-1948.
- [2] Anon, "Censimento della pesca in acque marine, pesca da terra e con naviglio, allevamenti (10 maggio 1937-xv), tonnare (25 giugno- 15 settembre 1937-xv)," tech. rep., Istituto Centrale di Statistica del Regno d'Italia, 1937.
- [3] M. Aparici-Fraticola, "Evolution et bilan de la pêche maritime a Sète." Universite Paul Valery Montpellier, 1975.
- [4] D. Maupoint de Vandeul, *Perspectives Setoises de la peche en mer*. PhD thesis, Universite Paul Valery Montpellier, 1979.
- [5] J. Bishop, "Standardizing fishery-dependent catch and effort data in complex fisheries with technology change," *Rev Fish Biol Fisheries*, vol. 16, pp. 21-38, 2006.
- [6] D. Ermirio, "Relazione sulla campagna di pesca eseguita dalla regia nave Tritone nel 1927 (Pantelleria, Lampedusa, Canale di Tunisi e costa sud Sicilia)," *Memorie Scientifiche Lab Centrale di Idrobiologia applicata alla Pesca*, vol. 6, 1932.
- [7] M. Ciotti, *La pesca nel medio Adriatico nel settecento tra innovazione delle tecniche e conservazione delle risorse*. EUM, 2006.
- [8] F. Doumenge, *Recherches sur les influences de la pêche dans l'évolution du peuplement des eaux littorales de certains secteurs de la Méditerranée occidentale*. PhD thesis, Faculté de Lettres de Montpellier, 1966.
- [9] P. Coccoluto Ferrigni, *La piccola pesca e le paranzelle*. 1866.
- [10] G. Faber, *The Fisheries of the Adriatic Sea*. London: Quaritch, B., 1883.
- [11] C. Paolucci, "Il primo esperimento governativo di pesca con battelli a vapore nell'adriatico," ?, pp. 33-70, 1913.
- [12] C. Bas, E. Morales, and M. Rubis, "La pesca en España y Cataluña." *Institut d'Investigacions Pesqueres*, 1955.
- [13] L. Farina, "New type of trawl," *Proc.gen.Fish.Coun.Medit*, vol. 5, pp. 135-139, 1959.
- [14] Anon, "Evomed project, the 20th century evolution of mediterranean exploited demersal resources under increasing fishing disturbance and environmental change," tech. rep., CIBM, HCMR, CSIC, UNIMAR, 2010.

- [15] Anon, "Mediterranean trawling second and third report," *Stud. Rev gen Fish. Coun. Medits.*, vol. 6, 1959.
- [16] U. Ferretti, "L'industria della pesca nella marina di Fano," *Rivista mensile di Pesca e Idrobiologia*, vol. XIII, Gennaio-Marzo 1911.
- [17] J. Coronas, *Observaciones sobre la pesca llamada de Parejas de bou; utilidad y necesidad de su uso en el golfo de Valencia.*, vol. 2. Valencia, Imprenta de Jose, Rius, 1866.
- [18] v. Županović, "Statistical analysis of catches by trawling in the fishing regions of the Eastern Adriatic in 1951," *Acta Adriatica*, vol. V, no. 8, pp. 1–53, 1953.
- [19] v. Županović, "Prilog analizi lovina tartanama na sjevernodalmatinskom podruckeckju 1951-1953. contribution a l'analyse de la peche a la tartane dans la dalmatie septentrionale 1951-1953," *Acta Adriatica*, vol. VIII, no. 1, pp. 1–16, 1956.
- [20] J. Sharfe, "Mediterranean trawling fifth report," *Stud. Rev gen Fish. Coun. Medits.*, vol. 14, 1961.
- [21] M. Bohulal, "Recolte et analyse des donnes de peche aux chalut pendant le dernier 25 annes (1946-1971)," *Bull Inst Oceanogr Peche Salamboo*, vol. 2, no. 2, 1972.
- [22] D. Pauly, "Anecdotes and the shifting baseline syndrome of fisheries," *TREE*, vol. 10, pp. 430–430, Oct. 1995.
- [23] J. B. C. Jackson, "Reefs since columbus," *Coral Reefs*, vol. 16, pp. S23–S32, 1999.
- [24] J. B. C. Jackson, M. X. Kirby, W. H. Berger, K. A. Bjorndal, L. W. Botsford, B. J. Bourque, R. H. Bradbury, R. Cooke, J. Erlandson, J. A. Estes, T. P. Hughes, S. Kidwell, C. B. Lange, H. S. Lenihan, J. M. Pandolfi, C. H. Peterson, R. S. Steneck, M. J. Tegner, , and R. R. Warner, "Historical overfishing and the recent collapse of coastal ecosystem," *Science*, vol. 293, no. 5530, pp. 629–638, 2001.
- [25] H. K. Lotze, H. S. Lenihan, B. J. Bourque, R. H. Bradbury, R. G. Cooke, M. C. Kay, S. M. Kidwell, M. X. Kirby, C. H. Peterson, and J. B. C. Jackson, "Depletion, degradation, and recovery potential of estuaries and coastal seas," *Science*, vol. 312, 2006.
- [26] STECF, "Sgmed-08-04: Mediterranean iv - assessments of demersal and small pelagic stocks," tech. rep., STECF, 2008.
- [27] J. Bertrand, L. Gil de Sola, C. Papaconstantinou, G. Relini, and A. Souplet, "Campagne internationale de chalutage démersal en Méditerranée (MEDITS 1995). campagne 1995," *Rapport général (vol. I) et manuel des protocoles (vol. II), Rapport de contrat CEE-IFREMER-IEO-SIBM-NCMR (Étude 94/047, 011, 057, 051)*, pp. –, 1996.
- [28] F. M. Sarimiento, "De los atunes y sus transmigraciones y conjeturas sobre la decadencia de las almadrabas y sobre los medios para restituirlas.," *Caixa de pontevedra, Madrid.*, 1757.

- [29] A. Marion, "Exploitation methodique des fonds maritimes littoraux," *Annales du musee d'histoire naturelle de Marseilles*, vol. 4, no. 1, 1891.
- [30] N. M. Zei, "Raziskovanje s travlom na ribolovnem prodrocju vzhodnega Jadrana (Investigation with trawl in the north eastern part of the Adriatic. Contribution to the knowledge of the biology and ecology of the benthonic fishes of eastern Adriatic)," *Slov. Akad. Ljubljana*, vol. IV, p. 89, 1949.
- [31] R. Myers and B. Worm, "Rapid worldwide depletion of predatory fish communities," *Nature*, vol. 423, pp. 280–283, 2003.
- [32] W. M. Johnson, *Monk seals in post-classical history. The role of the Mediterranean monk seal (Monachus monachus) in European history and culture, from the fall of Rome to the 20th century*. Leiden: Mededelingen 39. Netherlands Commission for International Nature Protection, 2004.
- [33] A. Marion, "Esquisse d'une topographie zoologique du Gulf de Marseilles," *Annales du musee d'histoire naturelle de Marseilles*, vol. 1, 1883.
- [34] O. Karlovac, "Exploration of fish stocks and edible invertebrata carried out by trawling in open adriatic. istrazivanja naselja riba i jestivih beskraljesnjaka vo?um u otvorenom jadrannu.," *Izvejava - Reports. The M.V. "Hvar" cruises-researches into fisheries biology 1948-1949. Svz. Inst. Oceanogr. Ribarst., Split*, vol. V, no. 1, 1959.
- [35] R. Del Rosso, "Pesche e pescherie antiche e moderne nell'etruria marittima," *Oswaldo Paggi: Firenze (2 vols)*, 1905.
- [36] W. M. Johnson and D. M. Lavigne, *Monk seals in antiquity: the Mediterranean monk seal (Monachus monachus) in ancient history and literature*. Leiden: Netherlands Commission for International Nature Protection, 1999.
- [37] G. Bearzi, E. Politi, S. Agazzi, and A. Azzellino, "Prey depletion caused by overfishing and the decline of marine megafauna in eastern ionian sea coastal waters (central mediterranean)," *Biological Conservation*, vol. 127, pp. 373–382, 2006.
- [38] S. D. Newsome, M. A. Etnie, D. Gifford-Gonzalez, D. L. Phillips, M. van Tuine, E. A. Hadly, D. P. Costa, D. J. Kennett, T. P. Guilderson, and P. L. Koch, "The shifting baseline of northern fur seal ecology in the northeast pacific ocean," *PNAS*, vol. 104, pp. 9709–9714, 2007.
- [39] L. McClenachan and A. Cooper, "Extinction rate, historical population structure and ecological role of the caribbean monk seal," *Proc Biol Sci.*, vol. 275, pp. 1351–1358, 2008.
- [40] H. K. Lotze and I. Milewski, "Two centuries of multiple human impacts and successive changes in a north atlantic food web," *Ecological Application*, vol. 14(5), pp. 1428–1447, 2004.
- [41] R. Hilborn and C. Walters, *Quantitative Fisheries Stock Assessment, Choice, Dynamics and Uncertainty*. Kluwer Academic Publishers, 1992.
- [42] T. J. Quinn II and R. B. Deriso, *Quantitative Fish Dynamics*. Oxford University Press, 1999.

- [43] J. Caddy and R. Mahon, "Reference points for fisheries management," *Fisheries Technical Papers* 347, FAO, 1995.
- [44] S. Calvert, B. Nielsen, and M. Fontugne, "Evidence from nitrogen isotope ratios for enhanced productivity during formation of eastern Mediterranean sapropels," *Nature*, vol. 359, pp. 223–225, 1992.
- [45] J. Bethoux and P. Gentili, "The Mediterranean Sea, coastal and deep-sea signatures of climatic and environmental changes," *Journal of Marine Systems*, vol. 7, pp. 383–394, 1996.
- [46] G. Chiaudiani, M. Gerletti, R. Marchetti, A. Provini, and M. Vighi, "Il problema dell'eutrofizzazione in Italia," *Quaderni* 42, CNR, Istituto di Ricerca sulle Acque, 1978.
- [47] D. Degobbins, R. Precali, I. Ivancic, N. Smoldaka, D. Fuks, and S. Kveder, "Long-term changes in the northern Adriatic ecosystem related to anthropogenic eutrophication," *Int. J. Environment and Pollution*, vol. 13, 2000.
- [48] Anon, "White paper: Coastal zone management in the mediterranean," tech. rep., UNEP/MAP/PAP, 2001.
- [49] EEA, "The changing faces of Europe's coastal areas," tech. rep., Luxembourg: OPOCE, 6 2006.
- [50] L. Airoidi and M. Beck, "Loss, status and trends for coastal marine habitats of Europe," *Oceanography and Marine Biology: An Annual Review*, vol. 45, pp. 345–405, 2007.
- [51] R. de Wit, L. J. Stal, B. A. Lomstein, R. A. Herbert, H. van Gemerden, P. Viaroli, V.-U. Cecherelli, F. Rodriguez-Valera, M. Bartoli, G. Giordani, R. Azzoni, B. Schaub, D. T. Welsh, A. Donnelly, A. Cifuentes, J. Antn, K. Finster, L. B. Nielsen, A.-G. U. Pedersen, A. T. Neubauer, M. A. Colangelo, and S. K. Heijs, "Robust: The role of buffering capacities in stabilising coastal lagoon ecosystems," *Continental Shelf Research*, vol. 21, pp. 2021–2041, Dec. 2001.
- [52] S. Jørgensen, *Integration of Ecosystem Theories: A Pattern*. Dordrecht: Kluwer, 1997.
- [53] P. Hordan and N. Purcell, *The Corrupting Sea: a Study of Mediterranean History*. Wiley-Blackwell, new edition ed., February 2000.
- [54] C. Roberts, *The unnatural history of the sea*. Island Press, 2007.
- [55] A. Solari, "Relazione sulla campagna di pesca eseguita dalla regia nave "Tritone" nel 1927 Malta e Tripolina," *Memorie Scientifiche Lab Centrale di Idrobiologia applicata alla Pesca*, vol. 5, 1931.
- [56] F. Matta, "La Pesca a Strascico Nell'Arcipelago Toscano," *Boll. Pesca. Pisc. Idrobiol.*, vol. XXXIV, no. 1-2, 1958.
- [57] C. Bas, F. Maynou, F. Sarda, and J. Lleonart, *Variacions demografiques a les poblacions d'especies demersals explotades-Els darrers quaranta anys a Blanes i Barcelona*. Institut d'estudis Catalans, 2003.

- [58] R. Sará, "La pesca a strascico sui fondali della scarpata continentale (settori Levanzo e di Pantelleria)," Tech. Rep. Memoria n. 21, Ministero della Marina mercantile, 1969.
- [59] H. Farrugio, P. Oliver, and F. Biagi, "An overview of the history, knowledge, recent and future research trend in Mediterranean fisheries," *Scientia Marina*, vol. 57, no. 2-3, pp. 105–119, 1993.
- [60] F. Doumenge, "L'histoire des pêches thonieres," *Col.Vol.Sci.Pap. ICCAT*, vol. 50 (2), pp. 753–803, 1998.
- [61] C. Ravier-Mailly, *Fluctuations á long terme du thon rouge - validité, origines et conséquences*. PhD thesis, L'Ecole Nationale Supérieure Agronomique de Rennes, 2003.
- [62] d. F. Gaetani, "Il corallo nella provincia di Reggio Calabria." Tipografia di D'Adamo D'Andrea, Reggio, 1867.
- [63] Anon, *La pesca nei mari e nelle acque interne d'Italia*, vol. II. Istituto Poligrafico dello Stato, Roma, 1931.
- [64] Y. Aldebert, "Demersal resources of the gulf of Lions (NW Mediterranean). Impact of exploitation on fish diversity," *Vie et Milieu*, vol. 47, no. 4, pp. 275–285, 1997.
- [65] F. Ferretti, R. Myers, F. Serena, and H. Lotze, "Loss of large predatory sharks from the mediterranean sea," *Conservation Biology*, vol. 22, no. 4, pp. 952–964, 2008.
- [66] J. F. Caddy, R. Refk, and T. Do-Chi, "Productivity estimates for the Mediterranean: evidence of accelerating ecological change," *Ocean & Coastal Management*, vol. 26, pp. 1–18, 1995.
- [67] J. Caddy and P. Rodhouse, "Cephalopod and groundfish landings: evidence for ecological change in global fisheries?," *Reviews in Fish Biology and Fisheries*, vol. 8, pp. 431–444, 1998.
- [68] B. Worm, E. B. Barbier, N. Beaumont, J. E. Duffy, C. Folke, B. S. Halpern, J. B. C. Jackson, H. K. Lotze, F. Micheli, S. R. Palumbi, E. Sala, K. A. Selkoe, J. J. Stachowicz, and R. Watson, "Response to Comments on "Impacts of Biodiversity Loss on Ocean Ecosystem Services"," *Science*, vol. 316, no. 5829, pp. 1285d–, 2007.
- [69] S. Murawski, R. Methot, G. Tromble, R. W. Hilborn, J. C. Briggs, B. Worm, E. B. Barbier, N. Beaumont, J. E. Duffy, C. Folke, B. S. Halpern, J. B. C. Jackson, H. K. Lotze, F. Micheli, S. R. Palumbi, E. Sala, K. A. Selkoe, J. J. Stachowicz, and R. Watson, "Biodiversity Loss in the Ocean: How Bad Is It?," *Science*, vol. 316, no. 5829, pp. 1281b–1284, 2007.
- [70] K. de Mutsert, J. James H. Cowan, T. E. Essington, and R. Hilborn, "Re-analyses of gulf of mexico fisheries data: Landings can be misleading in assessments of fisheries and fisheries ecosystems," *Proceedings of the National Academy of Sciences*, vol. 105, pp. 2740–2744, 2008.
- [71] A. A. Rosenberg, W. Bolster, K. Alexander, W. Leavenworth, A. Cooper, and M. McKenzie, "The history of ocean resources: modeling cod

- biomass using historical records," *Front. Ecol. Environ.*, vol. 3, no. 2, pp. 84–90, 2005.
- [72] B. Worm, E. B. Barbier, N. Beaumont, J. E. Duffy, C. Folke, B. S. Halpern, J. B. C. Jackson, H. K. Lotze, F. Micheli, S. R. Palumbi, E. Sala, K. A. Selkoe, J. J. Stachowicz, and R. Watson, "Impacts of Biodiversity Loss on Ocean Ecosystem Services," *Science*, vol. 314, no. 5800, pp. 787–790, 2006.
- [73] Anon, "Movimento della navigazione nei porti del Regno," tech. rep., Ministero delle Finanze-Direzione Generale delle Gabelle, 1881-1895.
- [74] Anon, "Statistiche della pesca e della caccia negli anni 1949 e 1950," tech. rep., Repubblica italiana, Istituto Centrale di Statistica, 1950.
- [75] Anon, "Notizie sulla pesca in Italia (1907-1908)," *Rivista mensile di pesca e idrobiologia*, 1907-1908.
- [76] S. Coppola and N. Cingolani, "Assessment of catch and effort of Italian fleet by fishing areas based on PESTAT data.," *Fish. Rep.* 468: 36-68., FAO, 1992. PESTAT.
- [77] R. Mancini, "La Sardegna, Prima crociera di pesca marittima," tech. rep., Ministero per l'Agricoltura-Ispettorato generale della pesca- Squadriglia sperimentale di pesca della R.Marina, 1921.
- [78] C. Parona, "La pesca marittima in Liguria," *Att. Soc. Lig. Sci. Nat.*, vol. IX, 1898.
- [79] P. Pasquini, "Per una maggior conoscenza della pesca adriatica ed insulare- Risultati di ricerche talasso-biologiche eseguite durante la campagna della R. Nave Tritone in alto, medio e basso Adriatico e nel mare della Sicilia Orientale e Meridionale (1924)," *Provveditorato generale dello Stato, Libreria, Roma*, no. II, p. 64, 1926.
- [80] M. Pedrotti, "La pesca nell'isola d'Elba," *Bull. Pesca Piscic. Idrobiol.*, vol. 14, 1959.
- [81] Pierleoni, "Relazione sulla campagna di pesca eseguita dalla regia nave "Tritone" nel 1926 (Lagosta, Pealagosa e costa calabra)," *Memorie Scientifiche Lab Centrale di Idrobiologia applicata alla Pesca*, vol. 4, 1930.
- [82] G. Police, "La pesca nei mari di Calabria," *Boll. Pesca Piscic. Idrobiol*, vol. 6, no. 6, 1930.
- [83] R. Santucci, "La pesca dell'aragosta in Sardegna," *R.Comitato Talassografico Italiano*, 1928.
- [84] A. Scaccini and C. Piccinetti, "Il fondo del mare da Falconara a Tortoreto con annessa carta di pesca," tech. rep., CNR- Programma particolare per le risorse marine e del fondo marino, 1969.
- [85] G. Zolezzi, "La pesca in Istria," *Archivio di Oceanografia e Limnologia*, vol. 1-3, 1944-47.
- [86] G. Bazigos, N. Cingolani, S. Coppola, D. Levi, J. Mortera, and G. Bombace, "A qualitative assessment of the Italian fisheries statistical system," *Quaderni dell'Istituto Picerche Pesca Marittima* 4 (1 suppl), CNR-Ancona, 1984.

- [87] Anon, "Statistiques des pêches maritimes année 1908," tech. rep., Ministère de la Marine, Paris, 1911.
- [88] Anon, "Statistiques des Pêches Maritimes," tech. rep., Secrétariat General de la Marine Marchande- Direction Generale des Pêches Maritimes, 1958-81.
- [89] A. Marion, "Travaux de zoologie applique a l'industrie des pêches," *Annales du Musee d'histoire naturelle de Marseilles*, vol. 5, 1897-1899.
- [90] A. Marion, "Exploitation methodique des fonds maritimes littoraux," *Annales du musee d'histoire naturelle de Marseilles*, vol. 4, no. 2, 1892.
- [91] E. Meuriot, "Fishing fleet replacement, the French policy from 1945 to 1983," *MARINE POLICY*, 1986.
- [92] E. Meuriot and P. Drémiere, "L'impact d'une politique de limitation de l'effort de pêche. Les chalutiers méditerranéens et le système des licences," *Economie Meridionale*, vol. 133-134, pp. 27-39, 1986.
- [93] E. Meuriot and P. Drémiere, "Evolution economiques du chalutage en Méditerranée, le cas du port de sète (1970-1974)," tech. rep., Drv/Sa and DIT/ICPM, 1986.
- [94] E. Meuriot and P. Y. Dreisième, "Licences de pêche et chalutage de fond en Méditerranée française," 1987.
- [95] A. Garrido and J. Alegret, *HMAP Dataset 10: Catalanian Coast*. M.G Barnard & J.H Nicholls, 2006.
- [96] Anon, "Estatistica de pesca año 1892," tech. rep., Revista de Pesca Maritima, 1894.
- [97] F. De Buen, "Investigation realizadas en aguas mediterraneas de Marruecos antes de la campana del Xauen," *Boletin de Oceanografia y Pesca*, no. 164, pp. 98-124, 1930.
- [98] A. Miranda y Riveira, "La pesca maritima en España en 1920." Boletin de Pesca publicado par la Direction General de Navegacion y pesca maritima del Ministerio de Marina, con el concurso del Instituto Espanol de Oceanografia, 1923.
- [99] Anon, "Tableaux statistiques - peches maritimes," tech. rep., Regence de Tunis-Protectorat Francais- Direction des Travaux Publicques, 1934-37.
- [100] G. Darboux, P. Stephan, J. Cotte, and F. Van Gaver, *L'industrie des pêches aux colonies*. Marseille, Barletier, Imprimeur-Editeur, 1906.
- [101] Giudicelli, "Simulated commercial trawling and scouting operations in the Central Mediterranean," fi:mat/75/001/1, FAO, May 1978.
- [102] P. Arena and F. Li Greci, "Indagini sulle condizioni faunistiche e sui rendimenti di pesca dei fondali della Sicilia occidentale e della bordura settentrionale dei banchi della soglia siculo-tunisina.," *Quad. Lab. Tecnol. Pesca Ancona*, vol. 1, no. 5, pp. 157-201, 1973.
- [103] F. Ktari-Chakroun and A. Azouz, "Les fonds chalutables du Sud-Est du de la region de la Tunisie (Golfe de Gabes)," *Bull. Inst. Oceanogr. Peche, Salamboo*, vol. 2, no. 1, 1971.

- [104] F. Bourgois and L. Farina, "Les essais de chalutage au large des cotes tunisiennes," Programme Elargi d'assistance technique F107 392, FAO, Rome, 1961.
- [105] A. Thomazi, *Histoire de la peche des ages de la pierre a nos jours*. Paris, 106, Boulevard St-Germain: Payot, 1947.
- [106] M. L. De Nicol'o, *Microcosmi Mediterranei- La comunita'a dei pescatori nell'et'a moderna*. Bologna: CLUEB, 2004.
- [107] N. Fourquin and P. Rigaud, *De la nave a pointu. Glossaire nautique de la langue d'oc (Provence, Languedoc), des origines 'a nos jours*. 1993.
- [108] A. Sanez Reguart, *Diccionario historico de los artes de la pesca nacional*, vol. 5. Impr. de la viuda de Don J. Ibarra, 1795.
- [109] M. D. du Monceau, *Traité général des Pêches, et histoire des poissons qu'elles fournissent, tant pour la subsistance des hommes que pour plusieurs autres usages qui ont rapport aux artes et au commerce*, vol. V. Paris: Sayllant & Nyon et Desaint, 1769.
- [110] S. Berthelot, *Etude sur les peches maritimes dans la Mediterranee et l'ocean*. 1868.
- [111] Anon, "Atti del i congresso nazionale di pesca industriale tenutosi in milano nei giorni 24-25 giugno 1922," (Varese), 24-25 Giugno 1923.
- [112] R. Mancini, "L'Arcipelago Toscano. Seconda crociera di pesca marittima. Ministero per L'Agricoltura. Ispettorato generale della pesca." Regia Marina Militare, 1922.
- [113] L. Mancini, "Crociera di pesca per lo studio del fondo marino- Golfo di Trieste e Costa Occidentale Istriana." Ministero dell'Industria-Memorie scientifiche- Supplemento al Boll Pesca Pisc. Idrobiol., 1927.
- [114] G. Mazzarelli, "Osservazioni eseguite durante la campagna della R.N. "Tritone" nei mesi di agosto-ottobre 1925," *Boll. Pesca Pisc. Idrobiol.*, 1926.
- [115] D. Ermirio, "Relazione della campagna di pesca eseguita dalla Regia Nave "Tritone" nell'anno 1928," *Memorie Scientifiche supplemento Boll. Pesca Pisc. Idrobiol.*, no. memoria n.7, 1931.
- [116] G. Mazzarelli, "I campi di pesca delle acque della libia esplorati con la r. nave "tritone"," *Memorie di biologia marina e di oceanografia*, vol. 4, 1936.
- [117] G. Mazzarelli, "Osservazioni eseguite durante la campagna della R.N. "Tritone" nei mesi luglio-settembre 1926," *Boll. Pesca Pisc. Idrobiol.*, 19xx.
- [118] U. D'Ancona and A. Razzauti, "Pesci e pesca nelle acque dell'Arcipelago Toscano," *Rapp. Comm. Int. Expl. Medit.*, p. 15, 1937.
- [119] J. Galea, "The use of knotless webbing as a method of improving the mediterranean trawl," *Proc.gen.Fish.Coun.Medit*, vol. 7, pp. 31-34, 1963.
- [120] Z. Fried, "Underwater study of the italian type trawl gear," *Proc.gen.Fish.Coun.Medit*, pp. 363-369, 1963.
- [121] M. Ben-Yami, "Preliminary report of experimental fishing net with and improved type of trawl-net," *Proc.gen.Fish.Coun.Medit*, 1963.

- [122] B. Ben-Yami, "The use of machine-made net webbing for mediterranean trawl nets," *Proc.gen.Fish.Coun.Medit*, vol. 6, pp. 129–135, 1961.
- [123] Anon, "Mediterranean trawling second and third report," *Stud. Rev gen Fish. Coun. Medits.*, vol. 6, 1959.
- [124] T. Soljan, "The M.V. "Hvar" cruises researches into fisheries biology in the open Adriatic (1948-1949)," *Report of the Istituzna oceanografiju y ribastovo-Split SFR Jugoslavica*, vol. 1, no. 1-2, pp. 1–13, 1977.
- [125] M. Bilio, "Fishing spread and towing velocity of the Italian otter trawl," *Archivio Limnologia e Oceanografia*, vol. 18, no. 2, pp. 1–87, 1974.
- [126] S. Jukić, "Koćarska područja u srednjem jadraniu- trawl fishing grounds in the central adriatic," *Jadraniu. Acta Adriat.*, vol. 17, pp. 1–86, 1975.
- [127] L. Fiorentini and G. Cosmi, "Some remarks on the italian bottom trawl," *GFCM fisheries reports*, vol. 253, 1981.
- [128] L. Fiorentini, P. Dremiere, I. Leonori, A. Sala, and V. Palumbo, "Efficiency of the bottom trawl used for the mediterranean international trawl survey (medits): Efficacite du chalut de fond utilise pour le programme international d'evaluation des ressources halieutiques de mediterranee (medits)," *Aquatic Living Resources*, vol. 12, no. 3, pp. 187–205, 1999.
- [129] L. Fiorentini, G. Cosimi, I. Leonori, A. Sala, and V. Palumbo, "Comparison of the Performances of some Italian Bottom Trawls," *Biol. Mar. Medit.*, vol. 5, no. 3, pp. 802–812, 1998.
- [130] L. Fiorentini, G. Cosimi, A. Sala, I. Leonori, and V. Palumbo, "Further Observations on the Performance of the Fishing Gears Used for Demersal Stock Assessment in Italy," *Biol. Mar. Medit.*, vol. 5, no. 3, pp. 792–801, 1998.
- [131] A. Sala, A. Lucchetti, M. Ferretti, A. Mariani, and S. Serra, "Indagine preliminare dell'impatto sul fondale marino esercitato dalla pesca con reti a strascico gemelle e prime valutazioni dellefficienza di pesca," tech. rep., CNR-ISMAR. UNIMAR, 2009.
- [132] O. R. Eigaard, D. Rihan, N. Graham, A. Sala, and K. Zachariassen, "Improving fishing effort descriptors: Modelling engine power and gear-size relations of five european trawl fleets," *Fisheries Research*, vol. 110, no. 1, pp. 39 – 46, 2011.
- [133] Anon, "Modern fishing gear of the world," tech. rep., FAO World Fishing Gear Congress, 1964.
- [134] G. Klust, *Netting materials for fishing gear*. FAO fishing manuals, Published by arrangement with the Food and Agriculture Organization of the United Nations by Fishing News Books Ltd., 1982.
- [135] J. Prado and P. Y. Dremière, *Fisherman's workbook*. FAO, 1990.
- [136] D. Wileman, "Project oilfish. investigation of the resistance of trawl gear," tech. rep., The Danish Institute of Fisheries Technology, 1984.
- [137] J. Sharfe, "Mediterranean trawling fourth report," *Stud. Rev gen Fish. Coun. Medits.*, vol. 10, 1960.

- [138] F. A. S. A. L. A. S. F. M. A. Prat J, Antonijuan J, "A simplified model of the interaction of the trawl warps, the otterboards and netting drag.," 2008, vol. 94, pp. 109–117, Fisheries Research.
- [139] P. Marchal, B. Andersen, B. Caillart, O. Eigaard, O. Guyader, H. Hovgaard, A. Iriondo, F. L. Fur, J. Sacchi, and M. Santurtun, "Impact of technological creep on fishing effort and fishing mortality, for a selection of european fleets," *ICES Journal of Marine Science*, vol. 64, pp. 192–209, 2007.
- [140] D. J. I. Somerton, S. Walsh, S. Smith, O. R. Godo, and D. Ramm, "Incorporating experimentally derived estimates of survey trawl efficiency into the stock assessment process: a discussion," *ICES Journal of Marine Science*, vol. 56, pp. 299–302, 1999.
- [141] D. Somerton, "Estimating trawl catchability," tech. rep., AFSC Quarterly Report, 1996.
- [142] M. Rahikainen and S. Kuikka, "Fleet dynamics of herring trawlers change in gear size and implications for interpretation of catch per unit efforts.," *Canadian Journal of Fisheries & Aquatic Sciences*, vol. 59, no. 3, p. 531, 2002.
- [143] Anon, "Mediterranean trawling, preliminary observations in the study of italian trawl nets," tech. rep., FAO, 1957. FAO/57/8/5662.
- [144] v. Županović and F. Grubisic, "Fishing effectiveness of trawl nets as resulting from experiments with wire cable bridles and with manilla covered bridles," *Acta Adriatica*, vol. VIII, 1958.
- [145] E. Gottlieb and O. H. Oren, "Savings gear experiments with trawl nets in israel waters," *Proc.gen.Fish.Coun.Medit*, pp. 281–287, 1963.
- [146] E. Gilat, "On the selection of upenelus molluccensis and mullus barbatus by trawl cod-ends in the israeli fisheries," *Proc.gen.Fish.Coun.Medit*, vol. 6, pp. 93–106, 1961.
- [147] F. Vives and P. Suau, "On the restocking of fishing grounds off the east coast of spain," *Proc.gen.Fish.Coun.Medit*, 1963.
- [148] P. Suau, M. Larraneta, and J. San Feliu, "Improvement trials of a trawl fishing ground," *Proc.gen.Fish.Coun. Medit*, vol. 8, pp. 333–340, 1965.
- [149] M. G. Larraneta, P. Suau, and J. M. San Feliu, "Selectividad de artes de arrastre en pesquerias del levante español," *Publicaciones Tecnicas de la Junta de Estudios de Pesca*, vol. 7, pp. 57–74, 1968.
- [150] M. G. Larrañeta, P. Suau, and J. M. S. Feliu, "Experiencias de selectividad en la pesqueira de arrastre en el levante español," *Inv. Pesq.*, vol. 33, pp. 15–53, 1969.
- [151] L. A. Sala A, "Effect of mesh size and codend circumference on selectivity in the mediterranean demersal trawl fisheries.," *Fisheries Research*, vol. 110, pp. 252–258, 2011.
- [152] J. Prat, J. Antonijuan, A. Folch, A. Sala, A. Lucchetti, F. Sardà, and A. M̀manuel, "A simplified model of the interaction of the trawl warps, the otterboards and netting drag," *Fisheries Research*, vol. 94(1), pp. 109–117, 2008.

- [153] L. Catasta, "Primi studi e ricerche per migliorare il rendimento della rete a strascico," 1960.
- [154] I. Leonori, P. S, and C. G, "Sampling trawls used for demersal resource assessment in the mediterranean," *FAO MEDSUDMED*, 2002.
- [155] R. D. C. Team, *R: A language and environment for statistical computing*. R Foundation for Statistical Computing, Vienna, Austria, 2005. ISBN 3-900051-07-0.
- [156] J. Pinheiro and D. Bates, *Mixed-Effects models in S and S Plus*. Springer, 2000.
- [157] P. McCullagh and J. Nelder, *Generalized Linear Models*. Chapman & Hall/CRC, second ed., 1989.
- [158] H. Akaike, "A new look at the statistical model identification.," *IEEE Transactions on Automatic Control*, vol. 19(6), pp. 716–723, 1974.
- [159] H. Akaike, "Information theory as an extension of the maximum likelihood principle. in: Second international symposium on information theory. petrov, b.n., csaki, f., eds, akademiai kiado, budapest.," pp. 267–281, 1973.
- [160] S. Wood, *gamm4: Generalized additive mixed models using mgcv and lme4*, 2011. R package version 0.1-5.
- [161] S. Wood, *Generalized Additive Models: An Introduction with R*. Ch, 2006.
- [162] C. M. Hurvich and C.-L. Tsai, "Regression and time series model selection in small samples," *Biometrika*, vol. 76, pp. 297–307, 1989.
- [163] K. P. Burnham and D. Anderson, *Model Selection and Multimodel Inference: A Practical Information-Theoretic Approach*. 2002.
- [164] G. Stefánsson, "Comparing different information sources in a multi-species context. in fishery stock assessment models.," (15th Lowell Wakefield Fisheries Symposium, 811 Oct. 1997, Anchorage, Alaska. 5410 Grosvenor Ln. Ste. 110, Bethesda, Md.), p. 741758, American Fisheries Society, 1988.
- [165] J. Dalmendray Gómez and J. R. Valdés Jiménez, "Methods for the theoretical calculation of wing and door spread of bottom trawls," *J. Northw. Atl. Fish. Sci.*, vol. 16, p. 4148, 1994.
- [166] C. Wardle, *Fish behaviour and fishing gear*, in *Behavior of Teleost Fishes*. Champman and Hall, London,, 1993.
- [167] D. G. Reid, V. J. Allen, D. J. Bova, E. G. Jones, R. J. Kynoch, K. J. Peach, P. G. Fernandes, and W. R. Turrell, "Anglerfish catchability for swept-area abundance estimates in a new survey trawl," *ICES Journal of Marine Science*, vol. 64, pp. 1503–1511, 2007.
- [168] M. D. du Monceau, *Traité général des Pêches, et histoire des poissons , ou des animaux qui vivent dans l'eau*, vol. III. Paris: Sayllant & Nyon et Desaint, 1769.
- [169] M. Marzari, *Il bragozzo: storia e tradizioni della tipica barca da pesca dell'Adriatico*. Biblioteca del mare, Mursia, 1982.

- [170] P. Madoz, *Dictionario geografico-estadistico-historico de España y su posesiones de ultramar*. 1849. info on bous in valencia page 422.
- [171] T. Tozzetti, "La pesca in italia," *Annali del Ministero di agricoltura, industria e commercio*, vol. I, parte I, 1871.
- [172] A. Zuccagni-Orlandini, "Ricerche statistiche sul granducato di toscana," tech. rep., Sezione Ministeriale dello Stato Civile e della Statistica Generale, 1850.
- [173] A. Errera, *L'Italia industriale con particolare riguardo all'Adriatico superiore (Regno d'Italia e Impero Austro-Ungarico)*. 1873.
- [174] P. Maestri, *L'Italia economica nel 1868*. 1868.
- [175] T. Tozzetti, "La pesca in italia," *Annali del Ministero di agricoltura, industria e commercio*, vol. I, parte II, 1872.
- [176] Anon in *Rivista Marittima*, no. XIII, Roma: Tipografia Barbera, Quarto Trimestre 1880.
- [177] Anon., *Raccolta delle leggi Toscane delle quali fu ordinata la pubblicazione nella città e territorio di Lucca col R. Decreto del 26 Febbraio 1848*. 1848.
- [178] B. Salvemini, "Comunità separate e trasformazioni strutturali. i pescatori pugliesi fra metà settecento e gli anni trenta del novecento," *Mélanges de l'Ecole française de Rome. Moyen-Age, Temps modernes*, vol. 97, no. 1, pp. 441–488, 1985.
- [179] Anon, *Collezione delle leggi e de' decreti reali nel Regno delle Due Sicilie*. 1835.
- [180] R. De Angelis, *Porti pescherecci*. Piccola Biblioteca di Pesca, 1939.
- [181] I. Mengaroni, *L'Azienda ittica nell'economia corporativa, il motopeschereccio*. 1941.
- [182] Anon, "Statistiques des peches maritimes année 1912," tech. rep., Ministère de la Marine, Paris, 1915.
- [183] J. Giffard, "L'economie des peches en Bas-Languedoc." Faculte des Lettres et Sciences Humanes , Universite de Montpellier, 1967.
- [184] C. Maurin, "The development of fisheries in the gulf of lion," *Proc.gen.Fish.Coun.Medit*, vol. 7, pp. 365–370, 1963.
- [185] P. Berthou, F. Daurés, O. Guyader, C. Merrien, and M. Jezequel, "Synthèse des pêcheries 2001 Flotte Méditerranée : PACA et Languedoc-Roussillon," tech. rep., Ifremer, 2002.
- [186] J.-B. Prodou and J. Andrianavaly, "Puissance de peche et relations avec les caractristiques techniques des navires. exemple de flottilles pratiquant le chalutage en mditerrane," tech. rep., IFREMER, 1999.
- [187] E. P. 98-053, "Factors affecting catch rates of nw mediterranean trawl fleets and derivation of standardised abundance indeces," tech. rep., 2001.
- [188] O. R. Eigaard and S. Munch-Petersen, "Influence of fleet renewal and trawl development on landings per unit effort of the danish northern shrimp (*pandalus borealis*) fishery.," *ICES Journal of Marine Science*, vol. 68, p. 2631, 2011.

- [189] J. F. Caddy and O. P., "Some future perspectives for assessment and management of mediterranean fisheries for demersal and shellfish resources, and small pelagic fish.," tech. rep., General Fisheries Council for the Mediterranean, Rome, 1996.
- [190] O. Kastriot, D. Pirro, C. Luca, U. Nicola, and M. Piero, "Assessment of demersal resources exploited by the albanian trawl fishery: the case studies hake and red mullet," Tech. Rep. GCP/RER/010/ITA, AdriaMed, 2003.
- [191] J. Lleonart and J. Camarasa, *La pesca a Catalunya el 1722- Segons un manuscrit de Joan Salvador I Riera*. Museu Maritim, Disputaci'o de Barcelona, 1987.
- [192] H. Pascal, "Situation actuelle et essai de modernization de l'industrie des peches en tunisie," tech. rep., GFCM, 1954.
- [193] Anon, "Tableaux Statistiques - Pêches maritimes," tech. rep., Regence de Tunis-Protectorat Francais- Direction des Travaux Publiques, 1937.
- [194] J. Pinheiro, D. Bates, S. DebRoy, D. Sarkar, and R Development Core Team, *nlme: Linear and Nonlinear Mixed Effects Models*, 2012. R package version 3.1-103.
- [195] F. Ferretti, R. Myers, P. Sartor, and F. Serena, "Long term dynamics of the chondrichthyan fish community in the upper tyrrhenian sea," in *ICES. 2005. Theme session on elasmobranch fisheries science (N).ICES Document CM 2005/N:25. 25 pp.*, 2005.
- [196] E. Edeline, S. M. Carlson, L. C. Stige, I. J. Winfield, J. M. Fletcher, J. B. James, T. O. Haugen, L. A. V?llestad, and N. C. Stenseth, "Trait changes in a harvested population are driven by a dynamic tug-of-war between natural and harvest selection," *Proceedings of the National Academy of Sciences*, vol. 104, no. 40, pp. 15799–15804, 2007.
- [197] B. Ernande, U. Dieckmann, and M. Heino, "Adaptive changes in harvested populations: plasticity and evolution of age and size at maturation," *Proc. R. Soc. Lond. B*, vol. 271, pp. 415–423, 2004.
- [198] M. R. Walsh, S. B. Munch, S. Chiba, and D. O. Conover, "Maladaptive changes in multiple traits caused by fishing: impediments to population recovery," *Ecology Letters*, vol. 9, pp. 142–148, 2006.
- [199] P. A. Biro and J. R. Post, "Rapid depletion of genotypes with fast growth and bold personality traits from harvested fish populations," *PNAS*, vol. 105, pp. 2919–2922, 2008.
- [200] D. O. Conover, S. A. Arnott, M. R. Walsh, and S. B. Munch, "Darwinian fishery science: lessons from the atlantic silverside (*menidia menidia*).," *Canadian Journal of Fisheries & Aquatic Sciences*, vol. 62, no. 4, pp. p730 – 737, 2005.
- [201] E. Meuriot, P. Drémère, and J. Capelle, "Le chatalutage en Méditerranée: le port de Sète. evolution economique 1970-1984.," Tech. Rep. 3: 147 pp., 1987.
- [202] G. Faber, *The fisheries of the Adriatic and the fish thereof*. 1883.

- [203] U. D'Ancona, "Dell'influenza della stasi peschereccia del periodo 1914-1918 sul patrimonio ittico dell'Alto Adriatico," Memoria CXXVI, R. Comitato Talassografico Italiano, 1926.
- [204] A. Campillo, "Les pêcheries francaises de méditerranée: synthèse des connaissances," tech. rep., IFREMER, 1992.
- [205] E. Massuti, O. Renones, A. Carbonell, and P. Olivier, "Demersal fish communities exploited on the continental shelf and slope off majorca (Balearic Islands, NW Mediterranean)," *Vie Milieu*, vol. 46, no. 1, pp. 45-55, 1996.
- [206] M. Chudeau, "Les conditions de la pêche en algerie," p. 37, 1905.
- [207] C. Fernandez, "Estudies sobre la pesca con el arte denominado parejas del bou, y reglamento pera su regimen por la comision permanente de pesca por su vocal-secretario cesareo fernandez, aprobado real orden de 9 de diciembre de 1865," tech. rep., 1866.
- [208] P. Monconduit, "Situation de la pêche maritime en tunisie au 1er janvier 1927," tech. rep., Station Océanographique de Salammbô, Tunis, Imprimerie Albert Guénard, 82 rue du Pacha, 1927.
- [209] B. Andreu and J. Rodriguez-Roda, "La pesca maritima en Castellon.- Rendimiento por unidad de esfuerzo (1945-1949) y consideracione biometricas de las especies de interes comercial," *P. Inst. Biol.Apl.*, vol. VIII, pp. 223-277, 1951.
- [210] M. Zei and I. Sabioncello, "Prilog poznavanju naselja bentoskih riba u kanalima srednje dalmacije," *God. Oceanogr. inst. Kralj. Jugosl.*, vol. 2, pp. 103-115, 1940.
- [211] D. Crnković, "Prilog biološkoj i ekonomskoj problematici kočarenja u kanalskom području sjeveroistočnog jadrana.," *Thalassia Jugosl.*, vol. 6, pp. 5-90, 1970.
- [212] S. Jukić, "The jugoslav nephrops fishery," *Acta Adriatica*, vol. 15, no. 179 No.8, 1974.
- [213] S. Jukić and C. Piccinetti, "Standing stock estimation and yield per exploitable biomass (yeb) forecast of the adriatic edible demersal resources.," *Inv. Pesq.*, vol. 43, no. 1, pp. 273-288, 1979.
- [214] A. Ligas, S. De Ranieri, D. Micheli, B. Reale, P. Sartor, M. Sbrana, and P. Belcari, "Analysis of the landings and trawl survey time series from the tyrrhenian sea (nw mediterranean)," *Fisheries Research*, vol. 105, pp. 46-56, 2010.
- [215] Anon, "Relazione sul primo esperimento di pesca nella tripolitania," tech. rep., Ministero delle Colonie- Ufficio Marina, 1913.
- [216] F. Bourgis and L. Farina, "Rapport au gouvernement de la tunisie concernant les essais de chalutage au large des cotes tunisiennes," Tech. Rep. FAO 61/1/12987, FAO, 1961.
- [217] B. Moustapha, "Campagne du dauphin dans les eaux libiennes," *Bull Inst Ocean Peches Salamboo*, vol. 1, no. 2, pp. 43-65, 1965.

- [218] M. Bonnet, "Contribution a l'inventaire des ressources chalutables au large de la tunisie- campagne de prospection de "la pelagia" (26 avril au 1er juin 1979)," *Science et Peche*, 1979.
- [219] P. Arena, "Indagine quantitative e qualitative sui materiali di scarto della pesca in sicilia e sulle possibilita' di una loro conveniente utilizzazione- quantitative and qualitative analysis on sicily fishery by-catch for a study of their possibilities of a suitable utilization," tech. rep., ESPI-Sezione di Ricerca per la Pesca ed i Prodotti del Mare- Messina, 1980.
- [220] A.-B. Z. Y. Gharbi, H., "Resultats des campagnes de prospection par chalutage dans la region nord de la tunisie (janvier-juin 1984)," *Bull. Inst. natn. scient. tech. Oceanogr. Peche Salamboo*, vol. 13, pp. 123-139, 1986.
- [221] R. H. Thurstan, S. Brockington, and C. M. Roberts, "The effects of 118 years of industrial fishing on uk bottom trawl fisheries," *nature*, 2010.
- [222] W. Garstang, "The impoverishment of the sea," *J. Mar. Biol. Assoc. UK.*, vol. 6, p. 1-69, 1900.
- [223] J. Kirkley, C. J. Morrison Paul, S. Cunningham, and J. Catanzano, "Embodied and disembodied technical change in fisheries: An analysis of the sete trawl fishery, 1985-1999," *Environmental and Resource Economics*, vol. 29, pp. 191-217, 2004. 10.1023/B:EARE.0000044603.62123.1d.
- [224] G. H. Engelhard, *Advances in Fisheries Science 50 years on from Beverton and Holt (eds), 1-25 (, 2008)*, ch. 1, pp. 1-25. Blackwell Publishing, 2008.
- [225] M. Massuti, "Evaluation de la peche sur le talus du plateau continental des iles baleares entre 1940 et 1969," tech. rep., FAO GFCM, 1971.
- [226] C. Maurin, "Etude des fonds chalutables de la mediterranee occidentale (ecologie et peche)," *Rev. Trav. Inst. P?ches marit.*, vol. 26 (2), pp. 1-56, 1962.
- [227] S. Jukić and C. Piccinetti, "Quantitative and qualitative characteristics of demersal resources in the adriatic sea with some population dynamic estimates.," *Fish. Rep.* 253: 73-91, FAO, 1981.
- [228] P. Arena, "Studio sulle possibilita' di razionalizzare e rendere piu' produttiva la pesca a strascico nel canale di sicilia e nel mediterraneo centro-meridionale," tech. rep., ESPI, 1985.
- [229] H. K. C. G. P. V. Fiorentini L, Sala A, "Comparison between model testing and full-scale trials of new trawl design for italian bottom fisheries," *Fisheries Science*, vol. 70, pp. 349-359, 2004.
- [230] T. Helser, A. Punt, and R. Methot, "A generalized linear mixed model analysis of a multi-vessel fishery resource survey," *Fish. Res.*, vol. 70, pp. 251-264, 2004.
- [231] A. Cooper, A. Rosenberg, G. Stefánsson, and M. Mangel, "Examining the importance of consistency in multi-vessel trawl survey design based on the U.S. west coast groundfish bottom trawl survey," *Fish. Res.*, vol. 70, p. 239-250, 2004.

- [232] A. F. Zuur, N. I. Ieno, N. J. Walker, A. A. Saveliev, and G. M. Smith, *Mixed Effect Models and Extensions in Ecology with R*. Springer, 2008.
- [233] G. Bini, "Ricerche sulla pesca a strascico nelle acque tirreniche dell'arcipelago toscano, delle coste laziali, del golfo dell'asinara e al largo della corsica," *Boll. Pesca Pisc. Idrobiol.*, vol. XXV, no. 2, pp. 250–271, 1970. C'e' anche il file con Lumare sui cefalopodi tirrenici.
- [234] S. Mahevas, Y. Vermard, T. Hutton, A. Iriondo, A. Jadaud, C. D. Maravelias, A. Punzon, J. Sacchi, A. Tidd, E. Tsitsika, P. Marchal, N. Goascoz, S. Mortreux, and D. Roos, "An investigation of human vs. technology-induced variation in catchability for a selection of european fishing fleets," *ICES Journal of Marine Science: Journal du Conseil*, vol. 68, no. 10, pp. 2252–2263, 2011.
- [235] O. R. Godo and A. Engas, "Swept area variation with depth and its influence on abundance indices of groundfish from trawl surveys," *J. North. Atl. Fish. Sci.*, vol. 9, pp. 133–139, 1989.
- [236] J. Bishop, W. N. Venables, C. M. Dichmont, and D. J. Sterling, "Standardizing catch rates: is logbook information by itself enough?," *ICES Journal of Marine Science: Journal du Conseil*, vol. 65, no. 2, pp. 255–266, 2008.
- [237] D. Squires, "Sources of growth in marine fishing industries," *Marine Policy*, vol. 18, no. 1, pp. 5 – 18, 1994.
- [238] N. Daan, H. J. L. Heessen, and J. G. Pope, "Changes in the north sea cod stock during the twentieth century," *ICE*, vol. 198, pp. 229–243, 1994.
- [239] C. Hvingel, H. Lassen, and D. G. Parsons, "A biomass index for northern shrimp (*Pandalus borealis*) in davis strait based on multiplicative modelling of commercial catch-per-unit-effort data (197697)," *J. Northw. Atl. Fish. Sci.*, vol. 26, pp. 25–36, 2000.
- [240] C. Maurin and H. Scoffoni, "Etude des fonds de peche des iles balerares," *France peche*, no. 102, 1966.
- [241] C. Maurin and M. Bonnet, "Nouvelle etude sur les fonds de peche de la corse et sur leur rentabilite," *Science et Peche Boll.Inform. Document. Inst. Peches marit.*, vol. 122, 1964.
- [242] W. Venables and C. Dichmont, "GLMs, GAMs and GLMMs: an overview of theory for applications in fisheries research," *Fish. Res.*, vol. 70, p. 319?337, 2004.
- [243] R. A. Campbell, "CPUE standardisation and the construction of indices of stock abundance in a spatially varying fishery using general linear models," *Fisheries Research*, vol. 70, pp. 209–227, 2004.
- [244] O. Karlovac, "Station list of the M.V. "HVAR" Fishery-Biological cruises 1948-1949," *Report of the Istituzna oceanografiju y ribastovo-Split SFR Jugoslavica*, vol. 1, no. 3, pp. 1–177, 1956.
- [245] A. Stephens and A. MacCall, "A multispecies approach to subsetting logbook data for purposes of estimating cpue," *Fish. Res.*, vol. 70, p. 299?310, 2004.

- [246] E. M.-P. Braccini, J. M. and S. J. D. Martell, "Subjective judgement in data subsetting: implications for cpue standardisation and stock assessment of non-target chondrichthyans," *Marine and Freshwater Research*, vol. 62, pp. 734–743, 2011.
- [247] B. S. Andersen, C. Ulrich, O. R. Eigaard, and A.-S. Christensen, "Short-term choice behaviour in a mixed fishery: investigating metier selection in the danish gillnet fishery," *ICES Journal of Marine Science: Journal du Conseil*, vol. 69, no. 1, pp. 131–143, 2012.
- [248] N. Deporte, C. Ulrich, S. Mahevas, S. Demaneche, and F. Bastardie, "Regional metier definition: a comparative investigation of statistical methods using a workflow applied to international otter trawl fisheries in the north sea," *ICES Journal of Marine Science: Journal du Conseil*, vol. 69, no. 2, pp. 331–342, 2012.
- [249] M. Maechler, P. Rousseeuw, A. Struyf, M. Hubert, and K. Hornik, *cluster: Cluster Analysis Basics and Extensions*, 2012. R package version 1.14.2 — For new features, see the 'Changelog' file (in the package source).
- [250] J. Castro, A. Punzon, G. J. Pierce, M. Marin, and E. Abad, "Identification of métiers of the northern spanish coastal bottom pair trawl fleet by using the partitioning method clara," *Fisheries Research*, vol. 102, no. 12, pp. 184 – 190, 2010.
- [251] A. Punzon, C. Hernandez, E. Abad, J. Castro, N. Perez, and V. Trujillo, "Spanish otter trawl fisheries in the cantabrian sea," *ICES Journal of Marine Science: Journal du Conseil*, vol. 67, no. 8, pp. 1604–1616, 2010.
- [252] J. Cartes, F. Maynou, E. Fanelli, V. Papiol, and D. Lloris, "Long-term changes in the composition and diversity of deep-slope megabenthos and trophic webs off catalonia (western mediterranean): Are trends related to climatic oscillations?," *Progress In Oceanography*, vol. 82, no. 1, pp. 32 – 46, 2009.
- [253] L. Kaufman and P. J. Rousseeuw, "Clustering large datasets," *Pattern Recognition in Practice II*, 1986.
- [254] R. Millar and M. Anderson, "Remedies for pseudoreplication," *Fish.Res.*, vol. 70, pp. 397–407, 2004.
- [255] R Core Team, *R: A Language and Environment for Statistical Computing*. R Foundation for Statistical Computing, Vienna, Austria, 2012. ISBN 3-900051-07-0.
- [256] C. Bas and L. Calderon-Aguilera, "Effect of anthropogenic and environmental factors on the blue whiting micromesistius poutassou off the catalonian coast, 1950-1982," *Marine ecology progress series*, vol. 54, pp. 221–228, 1989.
- [257] S. Katsanevakis, C. D. Maravelias, and L. T. Kell, "Landings profiles and potential metiers in greek set longliners," *ICES Journal of Marine Science: Journal du Conseil*, vol. 67, no. 4, pp. 646–656, 2010.

- [258] C. F. Hickling, "A comparison of the vigneron-dahal trawling gear with the steam otter trawl in the hake fishery," *Journal du Conseil International pour l'Exploration de la mer*, vol. 6, no. 3, pp. 421–431, 1931.
- [259] L. T. Kell and J.-M. Fromentin, "Evaluation of the robustness of maximum sustainable yield based management strategies to variations in carrying capacity or migration pattern of atlantic bluefin tuna (*thunnus thynnus*)," *Can. J. Fish. Aquat. Sci.*, vol. 64, pp. 837–847, 2007.
- [260] STECF, "Sgmed-12-03: Mediterranean stock assessments," tech. rep., STECF, 2012.
- [261] F. Maynou, M. Sbrana, P. Sartor, C. Maravelias, S. Kavadas, D. Damalas, F. Colloca, J. E. Cartes, and G. C. Osio, "Estimating trends of population decline in vulnerable marine species in the mediterranean sea through fishermen perception.," *PLOS One*, vol. in Press, 2011. ¹
- [262] C. J. Kelly, E. A. Codling, and E. Rogan, "The irish sea cod recovery plan: some lessons learned," *ICES Journal of Marine Science*, vol. 63, pp. 600–610, 2006.
- [263] T. J. Quinn II and J. S. Collie, "Sustainability in single-species population models," *Phil. Trans. R. Soc. B*, vol. 360, pp. 147–162, 2005.
- [264] B. R. MacKenzie, J. Alheit, D. J. Conley, P. Holm, and C. C. Kinze, "Ecological hypotheses for a historical reconstruction of upper trophic level biomass in the baltic sea and skagerrak," *Can. J. Fish. Aquat. Sci.*, vol. 59, pp. 173–190, 2002.
- [265] T. J. Pitcher, "Fisheries managed to rebuild ecosystems: reconstructing the past to salvage the future," *Ecological Applications*, vol. 11, pp. 601–617, 2001.
- [266] F. Colloca, M. Cardinale, F. Maynou, M. Giannoulaki, G. Scarcella, K. Jenko, J. M. Bellido, and F. Fiorentino, "Rebuilding mediterranean fisheries: a new paradigm for ecological sustainability," *Fish and Fisheries*, pp. no–no, 2011.
- [267] M. Mangel, M. B., P. C., and C. D., "Requiem for ricker: unpacking msy," *Bulletting of Marine Science*, vol. 70(2), pp. 763–781, 2002.
- [268] R. Hilborn, "The dark side of reference points," *Bulletin of Marine Science*, vol. 70, p. 403?408, 2002.
- [269] J. Hutchings and J. Reynolds, "Marine fish population collapses: Consequences for recovery and extinction risk," *BioScience*, vol. 054, pp. 297–309, 2004.
- [270] A. A. Rosenberg, J. H. Swasey, and M. Bowman, "Rebuilding us fisheries: progress and problems," *Front Ecol Environ*, vol. 4, no. 7, 2006.
- [271] Anon, "Commonwealth fisheries harvest strategy," tech. rep., Australian Department of Agriculture, Fisheries and Forestry, 2007.
- [272] K. W. Shertzer and M. H. Prager, "Delay in fishery management: diminished yield, longer rebuilding, and increased probability of stock collapse," *ICES Journal of Marine Science*, vol. 64, pp. 149–159, 2007.

- [273] B. R. MacKenzie, H. Mosegaard, and A. A. Rosenberg, "Impending collapse of bluefin tuna in the northeast atlantic and mediterranean," *Conservation Letters*, vol. accepted article, 2008.
- [274] A. Rosenberg, "Managing to the margins: the overexploitation of fisheries," *Front Ecol Environm*, vol. 1, pp. 102–106, 2003.
- [275] T. Economist, "Tuna in trouble," *The Economist*, November 2008.
- [276] J. Hutchings, "Collapse and recovery of marine fishes," *Nature*, vol. 406, pp. 882–885, 2000.
- [277] J. Brodziak, M. L. Traver, and L. A. Col, "The nascent recovery of the georges bank haddock stock," *Fisheries Research*, vol. 94, pp. 123–132, 2008.
- [278] M. Mangel and P. S. Levin, "Regime, phase and paradigm shifts: making community ecology the basic science for fisheries," *Phil. Trans. R. Soc. B*, vol. 360, pp. 95–105, 2005.
- [279] S. A. Murawski, "Definitions of overfishing from an ecosystem perspective," *ICES Journal of Marine Science*, vol. 57, p. 649–658, 2000.
- [280] R. Hilborn, K. Stokes, J.-J. Maguire, T. Smith, L. W. Botsford, M. Mangel, J. Orensanz, A. Parma, J. Rice, J. Bell, K. L. Cochrane, S. Garcia, S. J. Hall, G. P. Kirkwood, K. Sainsbury, G. Stefansson, and C. Walters, "When can marine reserves improve fisheries management?," *Ocean & Coastal Management*, vol. 47, no. 3-4, pp. 197 – 205, 2004.
- [281] B. Halpern and R. Warner, "Marine reserves have rapid and long lasting effects," *Ecological Letters*, vol. 5, pp. 361–6, 2002.
- [282] C. Pipitone, F. Badalamenti, G. D'Anna, and B. Patti, "Fish biomass increase after a four-year trawl ban in the Gulf of castellammare (NW Sicily, Mediterranean Sea)," *Fish. Res.*, vol. 48, pp. 23–30, 2000.
- [283] G. Stefansson and A. A. Rosenberg, "Combining control measures for more effective management of fisheries under uncertainty: quotas, effort limitation and protected areas," *Phil. Trans. R. Soc. B*, vol. 360, pp. 133–146, 2005.
- [284] U. D'Ancona, "Rilievi statistici sulla pesca nell'alto Adriatico," *Atti dell'Istituto Veneto di Scienze, Lettere ed Arti*, vol. CVIII, 1949.
- [285] E. K. Pikitch, C. Santora, E. A. Babcock, A. Bakun, R. Bonfil, D. O. Conover, P. Dayton, P. Doukakis, D. Fluharty, B. Heneman, E. D. Houde, J. Link, P. A. Livingston, M. Mangel, M. K. McAllister, J. Pope, and K. J. Sainsbury, "Ecosystem-based fishery management," *Science*, vol. 305, 2004.
- [286] EC, "Council regulation (ec) no 1967/2006," 21 December 2006.
- [287] J. Leonardt and F. Maynou, "Fish stock assessments in the Mediterranean: state of the art," *Scientia Marina*, vol. 67, pp. 37–49, 2003.
- [288] F. a. B. Fiorentino, G. D'Anna, G. Garofalo, P. Gianguzza, M. Gristina, C. P. and P. Rizzo, and T. Fortibuoni, "Changes in spawning-stock structure and recruitment pattern of red mullet, *Mullus barbatus*, after a trawl

ban in the gulf of castellammare (central mediterranean sea)," *ICES Journal of Marine Science*, vol. accepted for publication, 2008.

- [289] R. Myers and B. Worm, "Extinction, Survival or Recovery of Large Predatory Fishes," *Phil. Trans. R. Soc. B*, 2005. in Press.