



FULL CAR ACTIVE DAMPING SYSTEM FOR VIBRATION CONTROL

G. Yakubu¹, G. Sani¹, S. B. Abdulkadir², A. A. Jimoh², M. Francis³

¹ PG Student, Department of Mechatronics and Systems Engineering, Abubakar Tafawa Balewa University, Bauchi, Bauchi State, Nigeria.

² Department of Electrical Engineering Technology, Abubakar Tatari Ali Polytechnic Bauchi, Bauchi State, Nigeria.

³ PG Student (PhD) Department of Mechanical Engineering, University of Maiduguri, Borno State, Nigeria

Abstract:

Full car passive and active damping system mathematical model was developed. Computer simulation using MATLAB was performed and analyzed. Two different road profile were used to check the performance of the passive and active damping using Linear Quadratic Regulator controller (LQR) Road profile 1 has three bumps with amplitude of 0.05m, 0.025 m and 0.05 m. Road profile 2 has a bump with amplitude of 0.05 m and a hole of -0.025 m. For all the road profiles, there were 100% amplitude reduction in Wheel displacement, Wheel deflection, Suspension travel and body displacement, and 97.5% amplitude reduction in body acceleration for active damping with LQR controller as compared to the road profile and 54.0% amplitude reduction in body acceleration as compared to the passive damping system. For the two road profiles, the settling time for all the observed parameters was less than two (2) seconds. The present work gave faster settling time for mass displacement, body acceleration and wheel displacement.

Keywords: Damping; Vibration; Full Car; Amplitude; LQR Controller; Simulation.

Cite This Article: G. Yakubu, G. Sani, S. B. Abdulkadir, A. A. Jimoh, and M. Francis. (2019). "FULL CAR ACTIVE DAMPING SYSTEM FOR VIBRATION CONTROL." *International Journal of Engineering Technologies and Management Research*, 6(4), 1-17. DOI: 10.5281/zenodo.2653079.

1. Introduction

Effective control vibration usually requires several techniques, each of which contributes to a quieter environment [1]. For most applications, vibration can be controlled using four methods, namely Absorption, Use of barriers and enclosures, Structural damping and Vibration isolation/suspension [1]. Although there is a certain degree of overlap in these classes, each method may yield a significant reduction in vibration and noise by proper analysis of the problem and application of the technique. The principles behind the use of absorption materials and heavy mass barrier layers are generally understood, so this thesis will focus on active damping/suspension, which deal with reducing vehicle vibration.

The implementation of control systems can improve a vehicle performance by reducing the vibration levels to acceptable values, defined for each case [2]. This can be achieved by several control devices that can be used to apply forces to the vehicle, calculated by a specific control algorithm.

[3] Defines vibration as a repetitive motion of an object in alternatively opposite direction from the equilibrium position when that equilibrium has been disturbed, which occurs in machines, structures, and dynamic systems leading to unwanted consequences. [3] describes vibration as a problem due to unwanted motion, noise and stresses that may lead to failure and /or fatigue of a machines or structures, losses in energy, reliability decreased and low performance below expectation.

According to [4] there are three types of damping system namely, passive damping, semi-active damping and active damping system.

‘Active damping control’ is realized by regarding the piezos as either sensors or actuators, to be used within a control loop, Contrary to passive vibration control. For active vibration control, two situations are often distinguished: collocation and non-collocation.

2. Vehicle Model Review

A Quarter-car model (Figure 1) is usually used for the analysis of suspension, because of its simplicity and can take the significant features of the full car model [5] & [6]. According to [7] the equation for the model motions are found by adding upward and downward (vertical) forces on the car body (sprung mass) and the wheel and axle (unsprung mass). According to [7] the car body or sprung mass is represented by M_1 while the tyre and axle or unsprung mass is represented by M_2 , what make up the damping system are the spring, damper, and a force-generating element that is variable and is positioned between the car body and the tyre and axle. Generally, the roll and pitch angle can be obtained from the connection between the car body and the wheel and axle masses.

From [7], the quarter car and full car model are the same, just that there is other additional consideration that must be added when dealing with full car. These are; Rolling, Pitching and Bouncing which are represented in the X, Y and Z axis respectively.

Figure 1 to figure 3 as described by [7], [8] and [9] shows the quarter, half and full car model respectively.

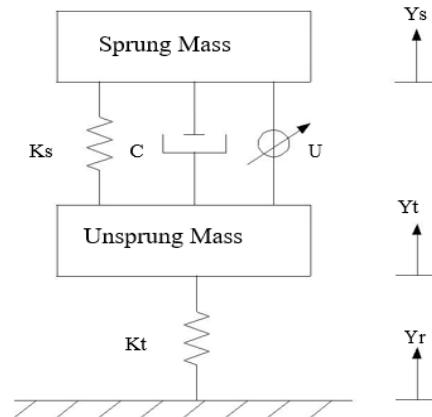

Figure 1: Quarter Car Model [10]

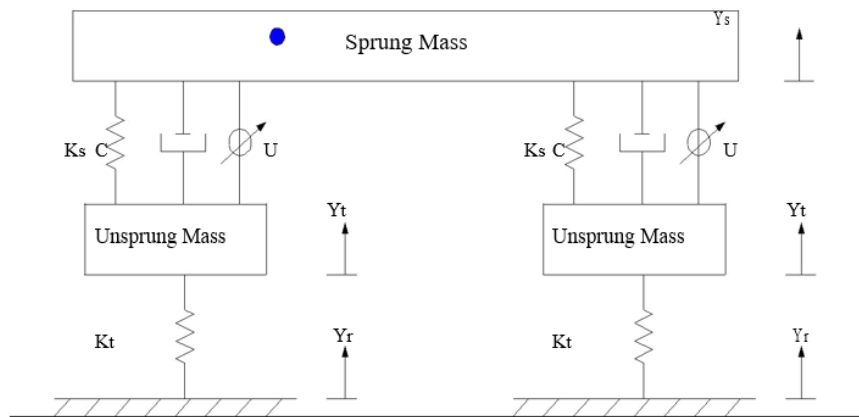

Figure 2: Half Car Model [11]

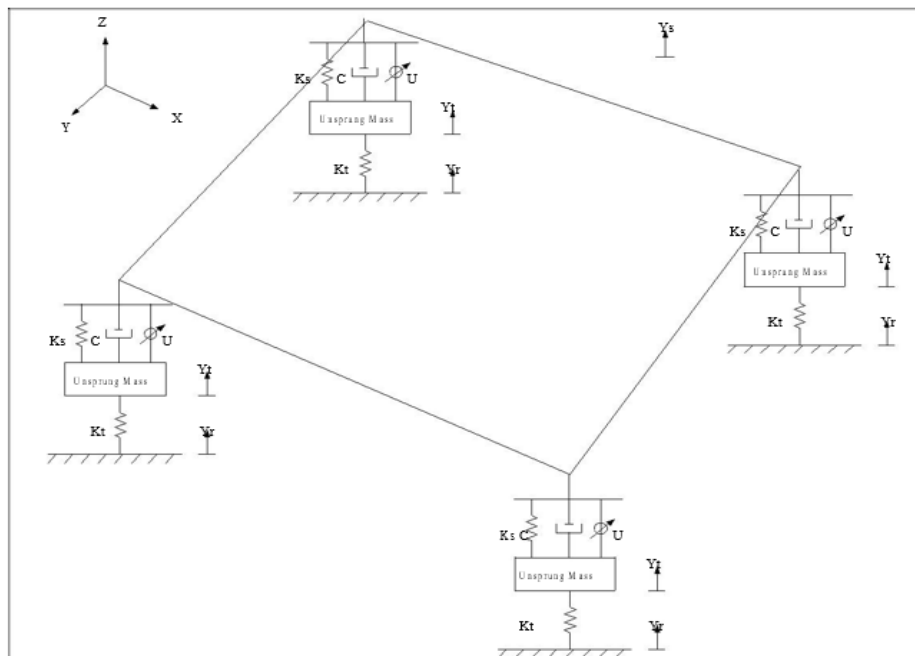

Figure 3: Full Car Model[12]

3. Mathematical Modeling; Passive Damping

According to [7], the vehicle body or sprung mass is free to bounce, roll and pitch. The damping system connects the vehicle body to the four wheel and axle masses, these are the front-right, front-left, rear right and rear left wheels. From [7] and [9], all the wheel and axle masses are free to bounce vertically with respect to the car body.

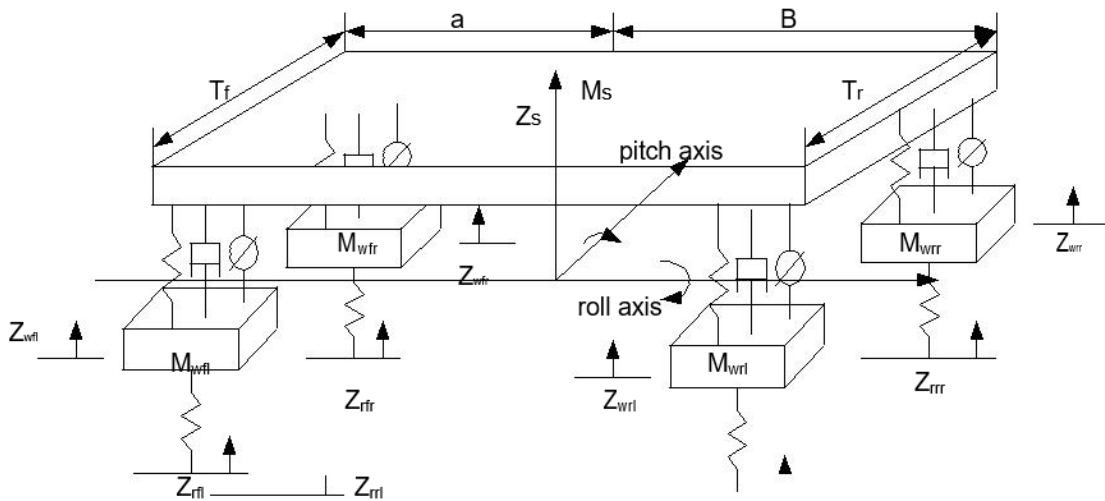

Figure 4: for Full Car Model for Passive and Active Damping

Rolling Motion; Sprung Mass

$$\begin{aligned}
 I_r \ddot{\phi}_s = & -d_f T_f [(T_f \dot{\phi}_s + a \dot{\phi}_s + \dot{Z}_s) - \dot{Z}_{wfr}] + d_f T_f [(-T_f \dot{\phi}_s + a \dot{\phi}_s + \dot{Z}_s) - \dot{Z}_{wfl}] - d_r T_r [(T_r \dot{\phi}_s - \\
 & b \dot{\phi}_s + \dot{Z}_s) - \dot{Z}_{wrr}] \\
 & + d_r T_r [(-T_r \dot{\phi}_s - b \dot{\phi}_s + \dot{Z}_s) - \dot{Z}_{wrl}] - k_f T_f [(T_f \phi_s + a \phi_s + Z_s) - Z_{wfr}] + k_f T_f [(-T_f \phi_s + \\
 & a \phi_s + Z_s) - Z_{wfl}] \\
 & - k_r T_r [(T_r \phi_s - b \phi_s + Z_s) - Z_{wrr}] + k_r T_r [(-T_r \phi_s - b \phi_s + Z_s) - Z_{wrl}] \dots \dots \dots \quad (1)
 \end{aligned}$$

Pitching Motion; Sprung Mass

$$\begin{aligned}
 I_p \ddot{\theta}_s = & -d_f a [(T_f \dot{\phi}_s + a \dot{\phi}_s + \dot{Z}_s) - \dot{Z}_{wfr}] - d_f a [(-T_f \dot{\phi}_s + a \dot{\phi}_s + \dot{Z}_s) - \dot{Z}_{wfl}] \\
 & + d_r b [(T_r \dot{\phi}_s - b \dot{\phi}_s + \dot{Z}_s) - \dot{Z}_{wrr}] \\
 & + d_r b [(-T_r \dot{\phi}_s - b \dot{\phi}_s + \dot{Z}_s) - \dot{Z}_{wrl}] - k_f a [(T_f \phi_s + a \phi_s + Z_s) - Z_{wfr}] - k_f a [(-T_f \phi_s + \\
 & a \phi_s + Z_s) - Z_{wfl}] + k_r b [(T_r \phi_s - b \phi_s + Z_s) - Z_{wrr}] + k_r b [(-T_r \phi_s - b \phi_s + Z_s) - Z_{wrl}] \dots \dots \dots \quad (2)
 \end{aligned}$$

Bouncing; Sprung Mass

$$\begin{aligned}
 M_s \ddot{Z}_s = & -d_f[(T_f \dot{\phi}_s + a\dot{\phi}_s + \dot{Z}_s) - \dot{Z}_{wfr}] - d_r[(-T_r \dot{\phi}_s + a\dot{\phi}_s + \dot{Z}_s) - \dot{Z}_{wfl}] - d_r[(T_r \dot{\phi}_s - \\
 & b\dot{\phi}_s + \dot{Z}_s) - \dot{Z}_{wrr}] \\
 & - d_r[(-T_r \dot{\phi}_s - b\dot{\phi}_s + \dot{Z}_s) - \dot{Z}_{wrl}] - k_f[(T_f \phi_s + a\phi_s + Z_s) - Z_{wfr}] - k_f[(-T_f \phi_s + a\phi_s + \\
 & Z_s) - Z_{wfl}] - k_r[(T_r \phi_s - b\phi_s + Z_s) - Z_{wrr}] - k_r[(-T_r \phi_s - b\phi_s + Z_s) - Z_{wrl}] \text{-----} \\
 & \text{-----} \tag{3}
 \end{aligned}$$

For each side of Wheel Motion (Vertical Direction)

$$\begin{aligned}
 M_{wfr} \ddot{Z}_{wfr} = & d_f [(T_f \dot{\phi}_s + a\dot{\phi}_s + \dot{Z}_s) - \dot{Z}_{wfr}] + K_f [(T_f \phi_s + a\phi_s + Z_s) - Z_{wfr}] - K_{tf} Z_{wfr} + \\
 & K_{tr} Z_{rfr} \text{-----} \tag{4}
 \end{aligned}$$

$$\begin{aligned}
 M_{wfl} \ddot{Z}_{wfl} = & d_f [(-T_f \dot{\phi}_s + a\dot{\phi}_s + \dot{Z}_s) - \dot{Z}_{wfl}] + K_f [(-T_f \phi_s + a\phi_s + Z_s) - Z_{wfl}] \\
 & - K_{tf} Z_{wfl} + K_{tr} Z_{rfl} \text{-----} \tag{5}
 \end{aligned}$$

$$\begin{aligned}
 M_{wrr} \ddot{Z}_{wrr} = & d_r [(T_r \dot{\phi}_s - b\dot{\phi}_s + \dot{Z}_s) - \dot{Z}_{wrr}] + K_r [(T_r \phi_s - b\phi_s + Z_s) - Z_{wrr}] - K_{tr} Z_{wrr} + \\
 & K_{tr} Z_{rrr} \text{-----} \tag{6}
 \end{aligned}$$

$$\begin{aligned}
 M_{wrl} \ddot{Z}_{wrl} = & d_r [(-T_r \dot{\phi}_s - b\dot{\phi}_s + \dot{Z}_s) - \dot{Z}_{wrl}] + K_r [(-T_r \phi_s - b\phi_s + Z_s) - Z_{wrl}] - K_{tr} Z_{wrl} + \\
 & K_{tr} Z_{rrl} \text{-----} \tag{7}
 \end{aligned}$$

Where

- M_s = mass of the car body or sprung mass (kg)
- M_{uf} and M_{ur} = front and rear mass of the wheel or unsprung mass (kg)
- I_p and I_r = pitch and roll of moment of inertia (kg m²)
- Z_s = car body displacement (m)
- Z_{fr}, Z_{fl}, Z_{rr} and Z_{rl} = car body displacement for each corner (m)
- Z_{wfr}, Z_{wfl}, Z_{wrr} and Z_{wrl} = wheel displacement (m)
- T_f and T_r = track (m) front and rear
- a = distance from centre of car body mass to front wheel (m)
- b = distance from centre of sprung mass to rear wheel (m)
- d_f and d_r = front and rear damping (Nm/s)
- k_f and k_r = stiffness of car body spring for front and rear (N/m)
- k_{tf} and k_{tr} = stiffness of tire for front and rear (N/m)

The state variables of the system are shown in Table 1 and the definition of each state variables are given in Table 2.

Table 1: Full Car Model State Variable

| | |
|------------------|------------------------|
| $\varphi_s = X1$ | $\dot{\varphi}_s = X8$ |
| $\theta_s = X2$ | $\dot{\theta}_s = X9$ |
| $Z_s = X3$ | $\dot{Z}_s = X10$ |
| $Z_{wfr} = X4$ | $\dot{Z}_{wfr} = X11$ |
| $Z_{wfl} = X5$ | $\dot{Z}_{wfl} = X12$ |
| $Z_{wrr} = X6$ | $\dot{Z}_{wrr} = X13$ |
| $Z_{wrl} = X7$ | $\dot{Z}_{wrl} = X14$ |

Table 2: Variables Definitions

| Variables | Definitions |
|-------------------|--|
| φ_s | Roll angle |
| $\dot{\varphi}_s$ | Roll rate |
| θ_s | Pitch angle |
| $\dot{\theta}_s$ | Pitch rate |
| Z_s | Vertical displacement |
| \dot{Z}_s | Vertical velocity |
| Z_{wfr} | Vertical displacement of front right wheel |
| \dot{Z}_{wfr} | Vertical velocity of front right wheel |
| Z_{wfl} | Vertical displacement of front left wheel |
| \dot{Z}_{wfl} | Vertical velocity of front left wheel |
| Z_{wrr} | Vertical displacement of rear right wheel |
| \dot{Z}_{wrr} | Vertical velocity of rear right wheel |
| Z_{wrl} | Vertical displacement of rear left wheel |
| \dot{Z}_{wrl} | Vertical velocity of rear left wheel |

Equations (1) ~ (7) is written instate space form as below

$$\begin{aligned} \dot{\varphi}_s &= \dot{X}_1 \approx X8 \\ \dot{\theta}_s &= \dot{X}_2 \approx X9 \\ \dot{Z}_s &= \dot{X}_3 \approx X10 \\ \dot{Z}_{wfr} &= \dot{X}_4 \approx X11 \\ \dot{Z}_{wfl} &= \dot{X}_5 \approx X12 \\ \dot{Z}_{wrr} &= \dot{X}_6 \approx X13 \\ \dot{Z}_{wrl} &= \dot{X}_7 \approx X14 \end{aligned}$$

$$\begin{aligned} \dot{X}_8 = \dot{\phi}_s &\approx [-d_f T_f ((T_f X_8 + aX_9 + X_{10}) - X_{11}) + d_f T_f ((-T_f X_8 + aX_9 + X_{10}) - X_{12}) \\ &- d_r T_r ((T_r X_8 - bX_9 + X_{10}) - X_{13}) \\ &+ d_r T_r ((-T_r X_8 - bX_9 + X_{10}) - X_{14}) - K_f T_f ((T_f X_1 + aX_2 + X_3) - X_4) + \\ &K_f T_f ((-T_f X_1 + aX_2 + X_3) - X_5) \\ &- K_r T_r ((T_r X_1 - bX_2 + X_3) - X_6) + K_r T_r ((-T_r X_1 - bX_2 + X_3) - X_7)]/I_r \\ \dot{X}_9 = \dot{\theta}_s &\approx [-d_f a ((T_f X_8 + aX_9 + X_{10}) - X_{11}) + d_f a ((-T_f X_8 + aX_9 + X_{10}) - X_{12}) \\ &+ d_r b ((T_r X_8 - bX_9 + X_{10}) - X_{13}) \\ &+ d_r b ((-T_r X_8 - bX_9 + X_{10}) - X_{14}) - K_f a ((T_f X_1 + aX_2 + X_3) - X_4) - K_f a ((-T_f X_1 + \\ &aX_2 + X_3) - X_5) \\ &+ K_r b ((T_r X_1 - bX_2 + X_3) - X_6) + K_r b ((-T_r X_1 - bX_2 + X_3) - X_7)]/I_p \end{aligned}$$

$$\begin{aligned} \dot{X}_{10} = \dot{Z}_s &\approx [-d_f ((T_f X_8 + aX_9 + X_{10}) - X_{11}) + d_f ((-T_f X_8 + aX_9 + X_{10}) - X_{12}) - d_r ((T_r X_8 - \\ &bX_9 + X_{10}) - X_{13}) \\ &- d_r ((-T_r X_8 - bX_9 + X_{10}) - X_{14}) - K_f ((T_f X_1 + aX_2 + X_3) - X_4) - K_f ((-T_f X_1 + aX_2 \\ &+ X_3) - X_5) \\ &- K_r ((T_r X_1 - bX_2 + X_3) - X_6) - K_r ((-T_r X_1 - bX_2 + X_3) - X_7)]/M_s \end{aligned}$$

$$\dot{X}_{11} = \ddot{Z}_{wfr} \approx [d_f ((T_f X_8 + aX_9 + X_{10}) - X_{11}) + K_f ((T_f X_1 + aX_2 + X_3) - X_4) - K_{tf} X_4 + K_{tf} Z_{rfr}]/M_{uf}$$

$$\dot{X}_{12} = \ddot{Z}_{wfl} \approx [d_f ((-T_f X_8 + aX_9 + X_{10}) - X_{12}) + K_f ((-T_f X_1 + aX_2 + X_3) - X_5) - K_{tf} X_5 + K_{tf} Z_{rfl}]/M_{uf}$$

$$\dot{X}_{13} = \ddot{Z}_{wrr} \approx [d_f ((T_f X_8 - bX_9 + X_{10}) - X_{13}) + K_r ((T_r X_1 - bX_2 + X_3) - X_6) - K_{tr} X_6 + K_{tr} Z_{rrr}]/M_{ur}$$

$$\dot{X}_{14} = \ddot{Z}_{wrl} \approx [d_r ((-T_r X_8 - bX_9 + X_{10}) - X_{14}) + K_r ((-T_r X_1 - bX_2 + X_3) - X_7) - K_{tr} X_7 + K_{tr} Z_{rrr}]/M_{ur}$$

Followed by, covert equation into the matrix yield

$$\dot{X}(t) = \begin{bmatrix} A_{11} & A_{12} \\ A_{21} & A_{22} \end{bmatrix} [X(t)] + f(t) \quad \text{-----} \quad (8)$$

Where,

$$\begin{aligned} \dot{X}(t) &= [\dot{X}_1 \dot{X}_2 \dot{X}_3 \dot{X}_4 \dot{X}_5 \dot{X}_6 \dot{X}_7 \dot{X}_8 \dot{X}_9 \dot{X}_{10} \dot{X}_{11} \dot{X}_{12} \dot{X}_{13} \dot{X}_{14}]^T \\ \dot{X}(t) &\approx [\dot{\phi}_s \dot{\theta}_s \dot{Z}_s \dot{Z}_{wfr} \dot{Z}_{wfl} \dot{Z}_{wrr} \dot{Z}_{wrl} \dot{\phi}_s \dot{\theta}_s \dot{Z}_s \dot{Z}_{wfr} \dot{Z}_{wfl} \dot{Z}_{wrr} \dot{Z}_{wrl}]^T \\ X(t) &= [X_1 X_2 X_3 X_4 X_5 X_6 X_7 X_8 X_9 X_{10} X_{11} X_{12} X_{13} X_{14}]^T \\ X(t) &\approx [\phi_s \theta_s Z_s Z_{wfr} Z_{wfl} Z_{wrr} Z_{wrl} \phi_s \theta_s Z_s Z_{wfr} Z_{wfl} Z_{wrr} Z_{wrl}]^T \end{aligned}$$

3.1. Mathematical Modeling; Active Damping

Mathematical modeling of active damping is derived from Figure 4. [7] The equations of motion for full car model can be derived as follows.

equation (9) ~ equation (15) shows the equation of rolling, pitching and bouncing motion of the sprung mass and wheel motion.

Rolling Motion; Sprung Mass

$$\begin{aligned}
 I_r \ddot{\phi}_s = & -d_f T_f [(T_f \dot{\phi}_s + a\dot{\phi}_s + \dot{Z}_s) - \dot{Z}_{wfr}] + d_f T_f [(-T_f \dot{\phi}_s + a\dot{\phi}_s + \dot{Z}_s) - \dot{Z}_{wfl}] - d_r T_r [(T_r \dot{\phi}_s - \\
 & b\dot{\phi}_s + \dot{Z}_s) - \dot{Z}_{wrr}] \\
 & + d_r T_r [(-T_r \dot{\phi}_s - b\dot{\phi}_s + \dot{Z}_s) - \dot{Z}_{wrl}] - k_f T_f [(T_f \phi_s + a\phi_s + Z_s) - Z_{wfr}] + k_f T_f [(-T_f \phi_s + a\phi_s + \\
 & Z_s) - Z_{wfl}] \\
 & - k_r T_r [(T_r \phi_s - b\phi_s + Z_s) - Z_{wrr}] + k_r T_r [(-T_r \phi_s - b\phi_s + Z_s) - Z_{wrl}] + T_f u_{fr} - T_f u_{fl} + \\
 & T_r u_{rr} - T_r u_{rl} \text{-----} \tag{9}
 \end{aligned}$$

Pitching motion; Sprung Mass

$$\begin{aligned}
 I_p \ddot{\theta}_s = & -d_f a [(T_f \dot{\phi}_s + a\dot{\phi}_s + \dot{Z}_s) - \dot{Z}_{wfr}] - d_f a [(-T_f \dot{\phi}_s + a\dot{\phi}_s + \dot{Z}_s) - \dot{Z}_{wfl}] + d_r b [(T_r \dot{\phi}_s - \\
 & b\dot{\phi}_s + \dot{Z}_s) - \dot{Z}_{wrr}] \\
 & + d_r b [(-T_r \dot{\phi}_s - b\dot{\phi}_s + \dot{Z}_s) - \dot{Z}_{wrl}] - k_f a [(T_f \phi_s + a\phi_s + Z_s) - Z_{wfr}] - k_f a [(-T_f \phi_s + a\phi_s + \\
 & Z_s) - Z_{wfl}] \\
 & + k_r b [(T_r \phi_s - b\phi_s + Z_s) - Z_{wrr}] + k_r b [(-T_r \phi_s - b\phi_s + Z_s) - Z_{wrl}] + a u_{fr} + a u_{fl} - b u_{rr} - \\
 & b u_{rl} \text{-----} \tag{10}
 \end{aligned}$$

Bouncing; Sprung Mass

$$\begin{aligned}
 M_s \ddot{Z}_s = & -d_f [(T_f \dot{\phi}_s + a\dot{\phi}_s + \dot{Z}_s) - \dot{Z}_{wfr}] - d_f [(-T_f \dot{\phi}_s + a\dot{\phi}_s + \dot{Z}_s) - \dot{Z}_{wfl}] - d_r [(T_r \dot{\phi}_s - b\dot{\phi}_s + \\
 & \dot{Z}_s) - \dot{Z}_{wrr}] \\
 & - d_r [(-T_r \dot{\phi}_s - b\dot{\phi}_s + \dot{Z}_s) - \dot{Z}_{wrl}] - k_f [(T_f \phi_s + a\phi_s + Z_s) - Z_{wfr}] - k_f [(-T_f \phi_s + a\phi_s + \\
 & Z_s) - Z_{wfl}] - k_r [(T_r \phi_s - b\phi_s + Z_s) - Z_{wrr}] - k_r [(-T_r \phi_s - b\phi_s + Z_s) - Z_{wrl}] + u_{fr} + u_{fl} + \\
 & u_{rr} + u_{rl} \text{-----} \tag{11}
 \end{aligned}$$

For each side of Wheel Motion (Vertical Direction)

$$M_{uf} \ddot{Z}_{wfr} = d_f [(T_f \dot{\phi}_s + a\dot{\phi}_s + \dot{Z}_s) - \dot{Z}_{wfr}] + K_f [(T_f \phi_s + a\phi_s + Z_s) - Z_{wfr}] - K_{tf} Z_{wfr} - u_{fr} + K_{tr} Z_{rfr} \text{-----} \tag{12}$$

$$M_{uf} \ddot{Z}_{wfl} = d_f [(-T_f \dot{\phi}_s + a\dot{\phi}_s + \dot{Z}_s) - \dot{Z}_{wfl}] + K_f [(-T_f \phi_s + a\phi_s + Z_s) - Z_{wfl}] - K_{tf} Z_{wfl} - u_{fl} + K_{tr} Z_{rfl} \text{-----} \tag{13}$$

$$M_{ur} \ddot{Z}_{wrr} = d_r [(T_r \dot{\phi}_s - b\dot{\phi}_s + \dot{Z}_s) - \dot{Z}_{wrr}] + K_r [(T_r \phi_s - b\phi_s + Z_s) - Z_{wrr}] - K_{tr} Z_{wrr} - u_{rr} + K_{tr} Z_{rrr} \text{-----} \tag{14}$$

$$M_{ur} \ddot{Z}_{wrl} = d_r [(-T_r \dot{\phi}_s - b\dot{\phi}_s + \dot{Z}_s) - \dot{Z}_{wrl}] + K_r [(-T_r \phi_s - b\phi_s + Z_s) - Z_{wrl}] - K_{tr} Z_{wrl} - u_{rl} + K_{tr} Z_{rrl} \text{-----} \tag{15}$$

Where

M_s = mass of the car body or sprung mass (kg)

M_{uf} and M_{ur} = front and rear mass of the wheel or unsprung mass (kg)

I_p and I_r = pitch and roll of moment of inertia (kg m²)

Z_s = car body displacement (m)

Z_{fr} , Z_{fl} , Z_{rr} and Z_{rl} = car body displacement for each corner (m)

Z_{wfr} , Z_{wfl} , Z_{wrr} and Z_{wrl} = wheel displacement (m)

T_f and T_r = front and rear treat (m)

a = distance from centre of sprung mass to front wheel (m)

b = distance from centre of sprung mass to rear wheel (m)

d_f and d_r = front and rear damping (Nm/s)

k_f and k_r = stiffness of car body spring for front and rear(N/m)

k_{tf} and k_{tr} = stiffness of tire for front and rear (N/m)

u_{fr} and u_{fl} = front right and left force actuators

u_{rr} and u_{rl} = rear right and left force actuators

Equations (9) ~equations (15) can be written instate space form as below

$$\dot{\varphi}_s = \dot{X}_1 \approx X_8$$

$$\dot{\theta}_s = \dot{X}_2 \approx X_9$$

$$\dot{Z}_s = \dot{X}_3 \approx X_{10}$$

$$\dot{Z}_{wfr} = \dot{X}_4 \approx X_{11}$$

$$\dot{Z}_{wfl} = \dot{X}_5 \approx X_{12}$$

$$\dot{Z}_{wrr} = \dot{X}_6 \approx X_{13}$$

$$\dot{Z}_{wrl} = \dot{X}_7 \approx X_{14}$$

$$\begin{aligned} \ddot{X}_8 = \dot{\varphi}_s \approx & [-d_f T_f ((T_f X_8 + aX_9 + X_{10}) - X_{11}) + d_f T_f ((-T_f X_8 + aX_9 + X_{10}) - X_{12}) \\ & - d_r T_r ((T_r X_8 - bX_9 + X_{10}) - X_{13}) \\ & + d_r T_r ((-T_r X_8 - bX_9 + X_{10}) - X_{14}) - K_f T_f ((T_f X_1 + aX_2 + X_3) - X_4) + \\ & K_f T_f ((-T_f X_1 + aX_2 + X_3) - X_5) \\ & - K_r T_r ((T_r X_1 - bX_2 + X_3) - X_6) + K_r T_r ((-T_r X_1 - bX_2 + X_3) - X_7) + T_f u_{fr} - T_f u_{fl} + \\ & T_r u_{rr} - T_r u_{rl}] / I_r \end{aligned}$$

$$\begin{aligned} \ddot{X}_9 = \dot{\theta}_s \approx & [-d_f a ((T_f X_8 + aX_9 + X_{10}) - X_{11}) + d_f a ((-T_f X_8 + aX_9 + X_{10}) - X_{12}) \\ & + d_r b ((T_r X_8 - bX_9 + X_{10}) - X_{13}) \\ & + d_r b ((-T_r X_8 - bX_9 + X_{10}) - X_{14}) - K_f a ((T_f X_1 + aX_2 + X_3) - X_4) \\ & - K_f a ((-T_f X_1 + aX_2 + X_3) - X_5) \\ & + K_r b ((T_r X_1 - bX_2 + X_3) - X_6) + K_r b ((-T_r X_1 - bX_2 + X_3) - X_7) + a u_{fr} + a u_{fl} - b u_{rr} - \\ & b u_{rl}] / I_p \end{aligned}$$

$$\begin{aligned} \ddot{X}_{10} = \dot{Z}_s \approx & [-d_f ((T_f X_8 + aX_9 + X_{10}) - X_{11}) + d_f ((-T_f X_8 + aX_9 + X_{10}) - X_{12}) - d_r ((T_r X_8 - \\ & bX_9 + X_{10}) - X_{13}) \\ & - d_r ((-T_r X_8 - bX_9 + X_{10}) - X_{14}) - K_f ((T_f X_1 + aX_2 + X_3) - X_4) - K_f ((-T_f X_1 + aX_2 \\ & + X_3) - X_5) \end{aligned}$$

$$-K_r((T_r X_1 - bX_2 + X_3) - X_6) - K_r((-T_r X_1 - bX_2 + X_3) - X_7) + u_{fr} + u_{fl} + u_{rr} + u_{rl}]/M_s$$

$$\dot{X}_{11} = \ddot{Z}_{wfr} \approx [d_f((T_f X_8 + aX_9 + X_{10}) - X_{11}) + K_f((T_f X_1 + aX_2 + X_3) - X_4) - K_{tf}X_4 - u_{fr} + K_{tf}Z_{rfr}]/M_{uf}$$

$$\dot{X}_{12} = \ddot{Z}_{wfl} \approx [d_f((-T_f X_8 + aX_9 + X_{10}) - X_{12}) + K_f((-T_f X_1 + aX_2 + X_3) - X_5) - K_{tf}X_5 - u_{fl} + K_{tf}Z_{rfl}]/M_{uf}$$

$$\dot{X}_{13} = \ddot{Z}_{wrr} \approx [d_f((T_f X_8 - bX_9 + X_{10}) - X_{13}) + K_r((T_r X_1 - bX_2 + X_3) - X_6) - K_{tr}X_6 - u_{rr} + K_{tr}Z_{rrr}]/M_{ur}$$

$$\dot{X}_{14} = \ddot{Z}_{wrl} \approx [d_r((-T_r X_8 - [bX]_9 + X_{10}) - X_{14}) + K_r((-T_r X_1 - [bX]_2 + X_3) - X_7) - K_{tr}X_7 - u_{rl} + K_{tr}Z_{rrr}]/M_{ur}$$

Followed by, covert equation into the matrix yield

$$\dot{X}(t) = \begin{bmatrix} A_{11} & A_{12} \\ A_{21} & A_{22} \end{bmatrix} [x(t)] + Bu(t) + f(t) \text{-----} \tag{16}$$

Where,

$$\begin{aligned} \dot{X}(t) &= [\dot{X}_1 \dot{X}_2 \dot{X}_3 \dot{X}_4 \dot{X}_5 \dot{X}_6 \dot{X}_7 \dot{X}_8 \dot{X}_9 \dot{X}_{10} \dot{X}_{11} \dot{X}_{12} \dot{X}_{13} \dot{X}_{14}]^T \\ \dot{X}(t) &\approx [\dot{\varphi}_s \dot{\theta}_s \dot{Z}_s \dot{Z}_{wfr} \dot{Z}_{wfl} \dot{Z}_{wrr} \dot{Z}_{wrl} \dot{\varphi}_s \dot{\theta}_s \dot{Z}_s \dot{Z}_{wfr} \dot{Z}_{wfl} \dot{Z}_{wrr} \dot{Z}_{wrl}]^T \\ X(t) &= [X_1 X_2 X_3 X_4 X_5 X_6 X_7 X_8 X_9 X_{10} X_{11} X_{12} X_{13} X_{14}]^T \\ X(t) &\approx [\varphi_s \theta_s Z_s Z_{wfr} Z_{wfl} Z_{wrr} Z_{wrl} \varphi_s \theta_s Z_s Z_{wfr} Z_{wfl} Z_{wrr} Z_{wrl}] \end{aligned}$$

3.2. Parameters Used

The full car mathematical model was based on [10] and [15]. The parameters were obtained from [10] and [16]. From [16], spring stiffness is 55000 N/mand damping coefficient 4000 Nm/s, 1000 Nm/s respectively. The fixed parameters of full car model are;

Sprung mass = mass of vehicle body = 1200kg = M_s

Wheel mass of front right and left = 60kg = M_{uf}

Wheel mass of rear right and left = 60kg = M_{ur}

Spring stiffness of front right and left tyre = 30000N/m = k_{tf} and k_{tr}

Spring stiffness of rear right and left tyre = 30000N/m = k_{tf} and k_{tr}

Pitch moment of inertia = 4000kg-m² = I_p

Roll moment of inertia = 952kg-m² = I_r

Distance from CG to front and rear wheel = 1.5m = a

Distance from CG to left and right wheel = 1.0m = b

Front and rear treat = T_f and T_r = 0.507m and 0.559m

The fixed parameters for fullcar model are; [3]

Unsprung mass = mass of the wheel/tyre = 59kg = M_1

Sprung mass = mass of vehicle body = 290kg = M_2

Stiffness of the wheel/tyre = 190000N/m

3.3. Linear Quadratic Regulator (LQR) Controller Design

The LQR control approaches in controlling a linear active damping system was presented by [16]. [7] concluded that the LQR control approach will give a better performance in terms of ride comfort.

This study considered the following state variable feedback regulator.

$$u = -kx \text{ -----} \tag{17}$$

Where k is the state feedback gain matrix.

Optimization of control system consists of determining the control input u , which minimizes the performance index (J), which represents the performance characteristics requirement as well as controller input limitations [16].

The performance index

$$J = \frac{1}{2} \int_0^t (x'Qx + u'Ru)dt \text{ -----} \tag{18}$$

Where u = actuator force (N)

Q and R are positive definite weighting matrices [17].

Linear optimal control theory provides the solution of equation (18) in the form of equation (17)

$$k = R^{-1}B'P \text{ -----} \tag{19}$$

Where matrix P must satisfy the reduced – matrix Riccati equation

$$A'P + PA - PBR^{-1}B'P + Q = 0 \text{ -----} \tag{20}$$

Then the feedback regulator u is given by

$$u(t) = -(R^{-1}B')(t) \\ = -kx(t)$$

4. Result Analysis

The computer simulation work based on equation (1) ~ (16) has been performed. Comparison between passive and active suspension for full car model was observed. For the LQR controller, the weighing matrix Q and weighing matrix R are set to obtain suitable feedback gain k .

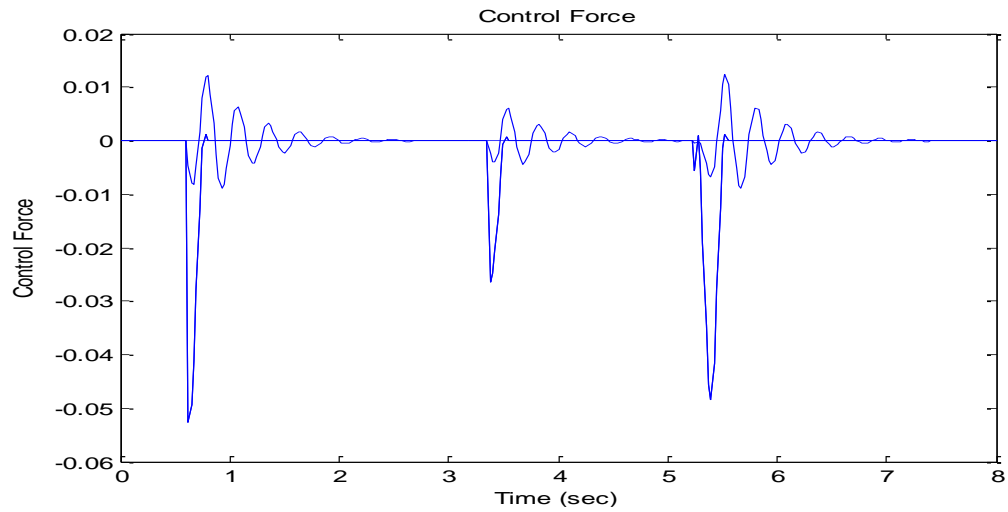

Figure 5: Force Generated using LQR Controller with Road Profile 1

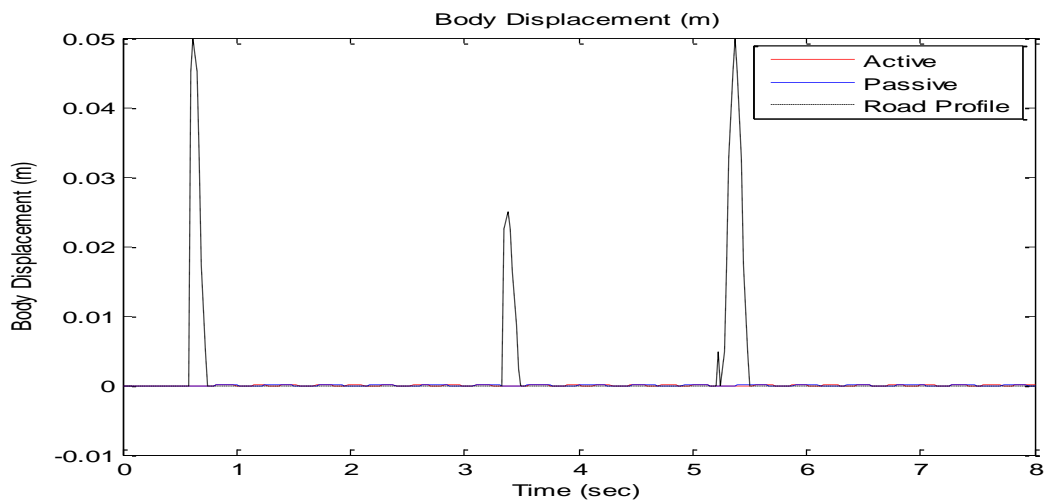

Figure 6: Body Displacement with Road Profile 1

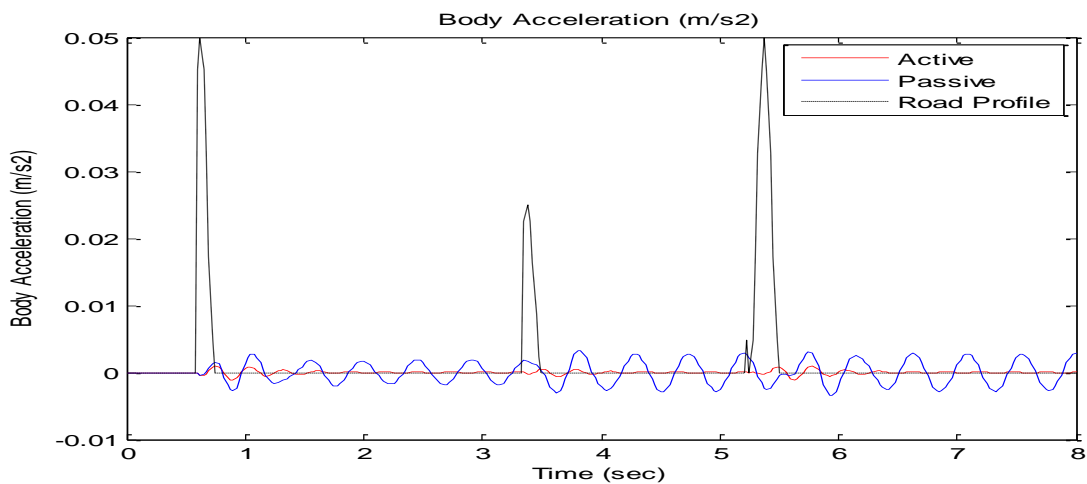

Figure 7: Body Acceleration with Road Profile 1

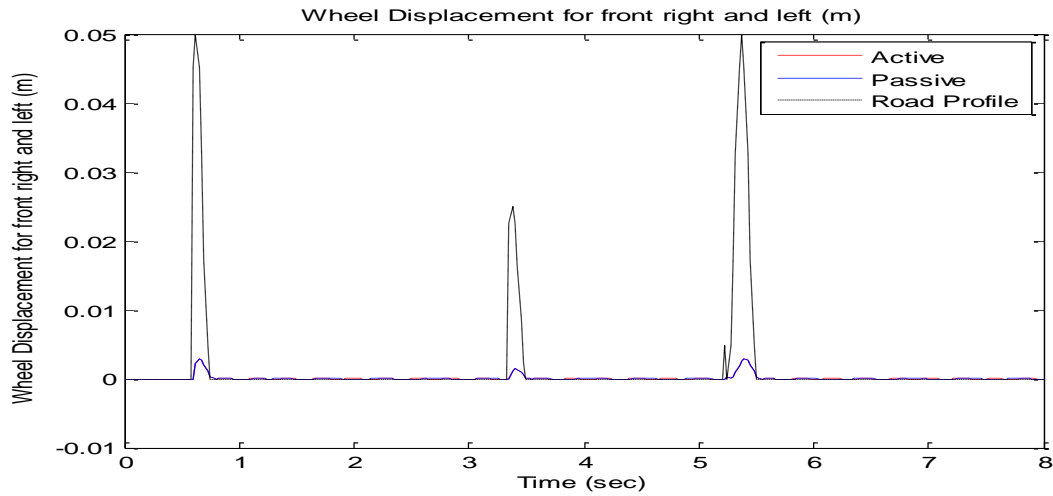

Figure 8: Wheel Displacement for Front/Rear Right and Left with Road Profile 1

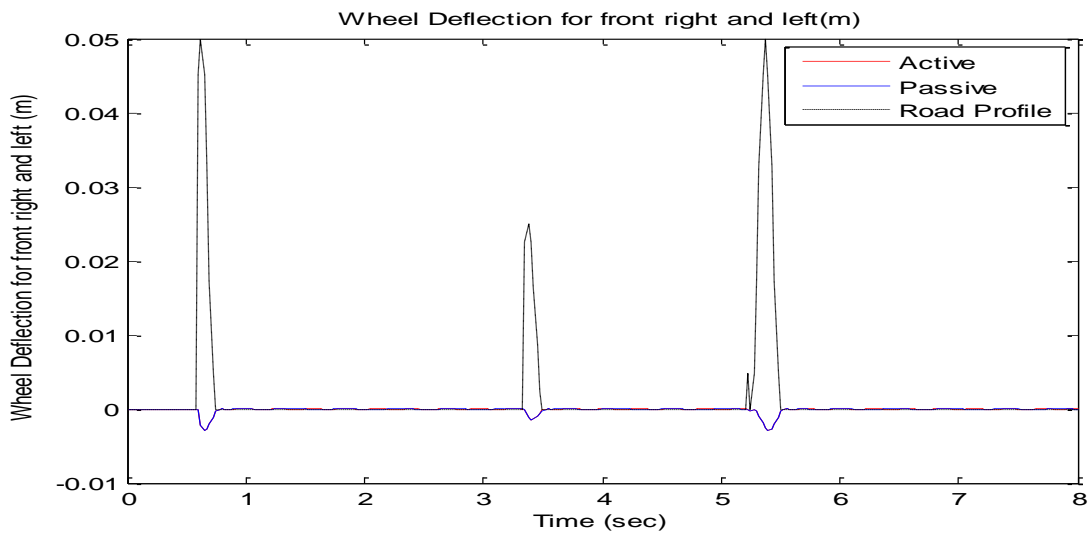

Figure 9: Wheel Deflection for Front/Rear Right and Left with Road Profile 1

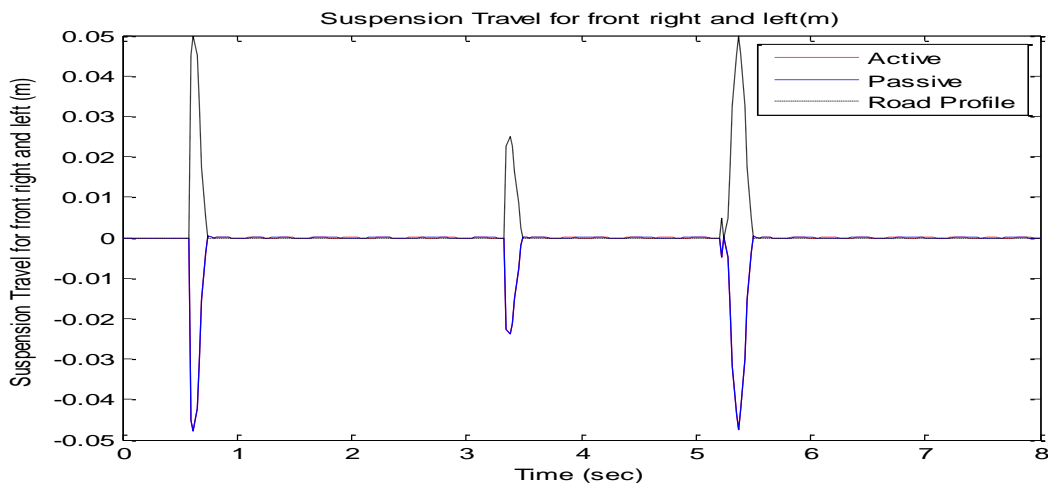

Figure 10: Suspension Travel for Front/Rear Right and Left with Road Profile 1

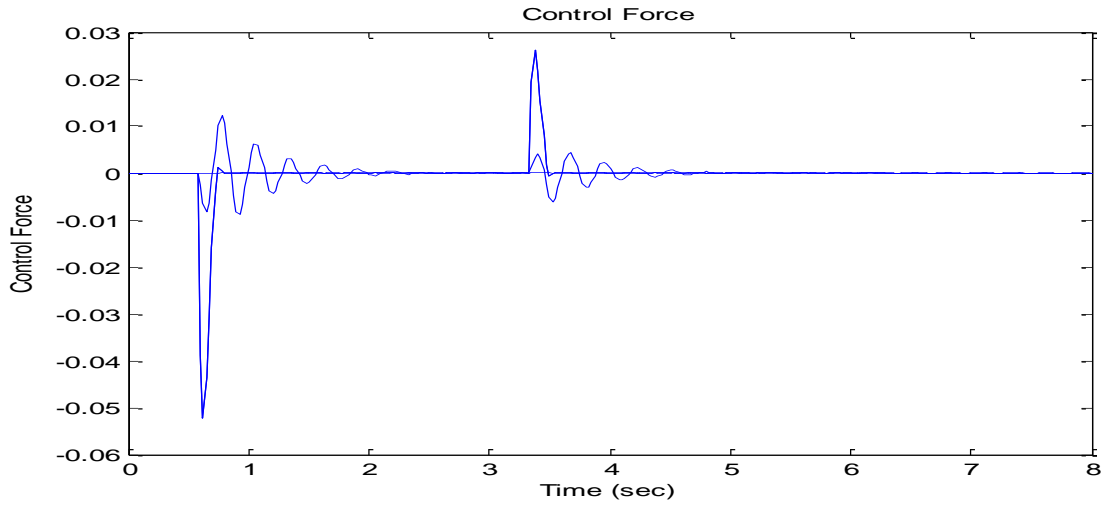

Figure 11: Force generated using LQR Controller with Road Profile 2

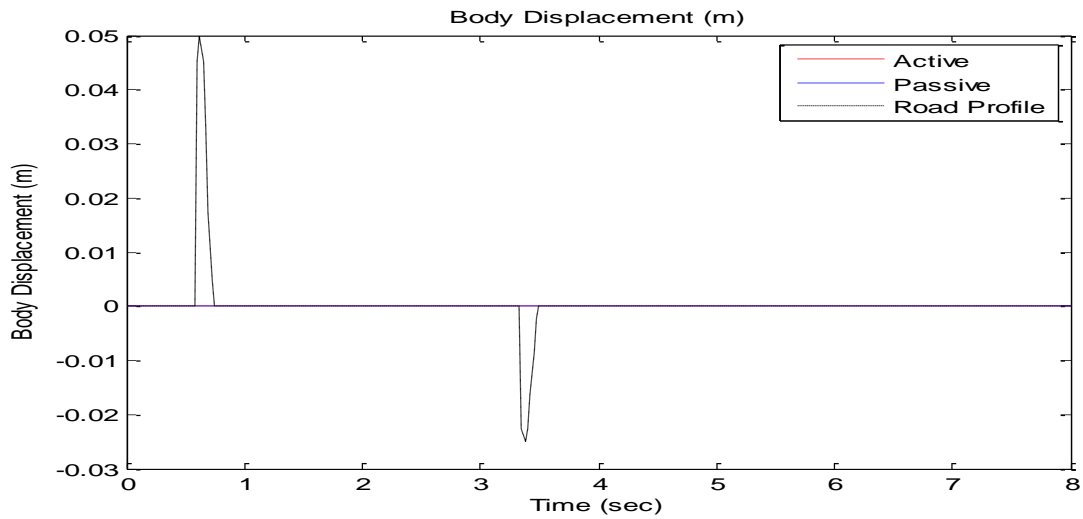

Figure 12: Body Displacement with Road Profile 2

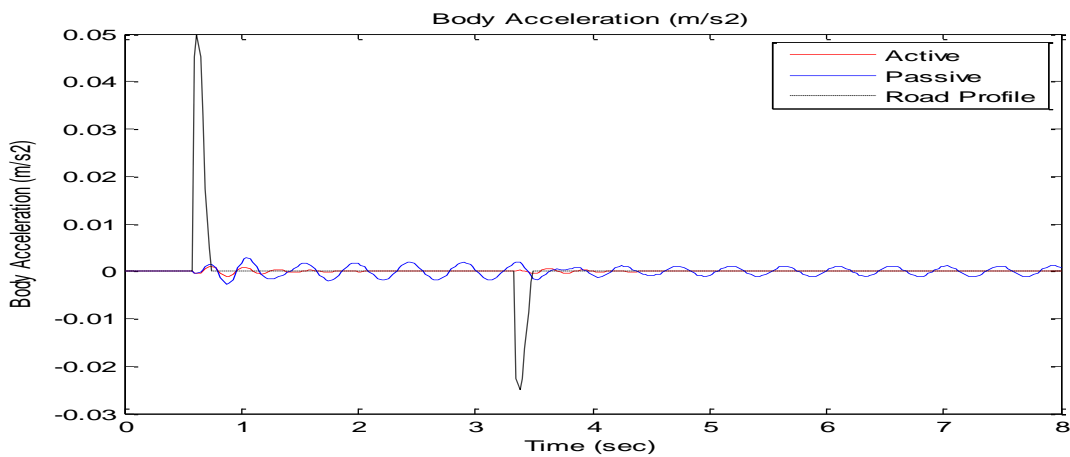

Figure 13: Body Acceleration with Road Profile 2

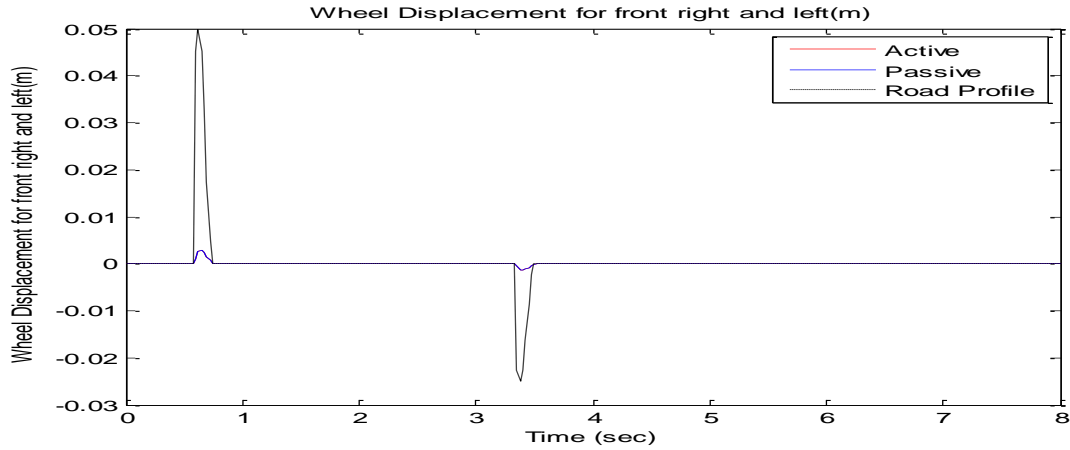

Figure 14: Wheel Displacement for Front/Rear Right and Left with Road Profile 2



Figure 15: Wheel Deflection for Front/Rear Right and Left with Road Profile 2

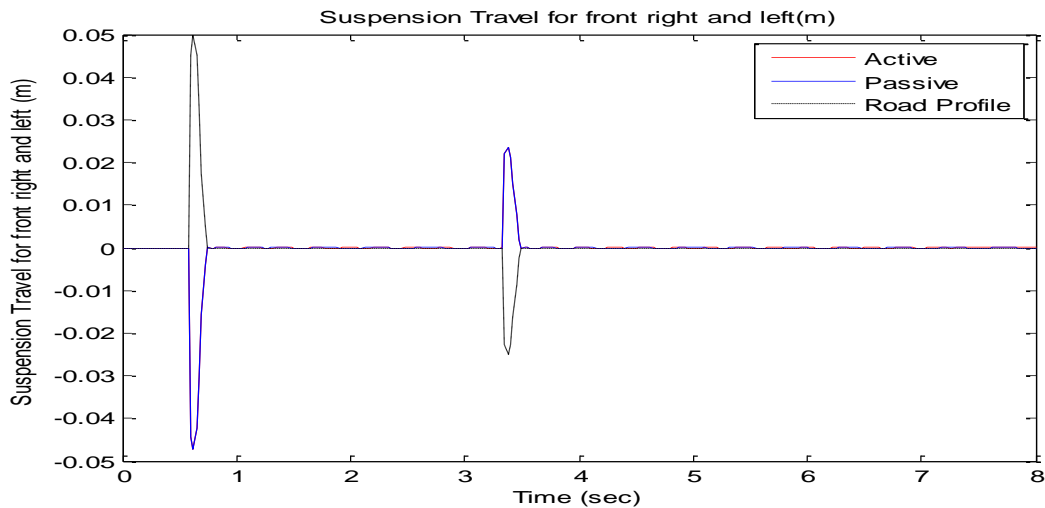

Figure 16: Suspension Travel for Front/Rear Right and Left with Road Profile 2

4.1. Discussion of Result

The control force generated by the actuator for road profiles 1 and 2 are shown in Figure 5, and Figure 14. The body displacement which represents the ride quality for both Passive and Active damping with LQR have very low amplitude with very fast settling time for road profiles 1 and 2 as can be seen in Figure 6 and Figure 12. The Suspension Travel for the two road profiles (Figure 10 and Figure 16), the active damping system shows very lower amplitude and very fast settling time. Wheel Displacement with road profiles 1 and 2 (Figure 9 and Figure 14), also shows a balance in the amplitude, that is, no amplitude rises. The wheel displacement represents the car handling performance. For the Body Acceleration, for active damping, there is amplitude that makes few oscillations (Figure 7 and Figure 13) but, it settles faster with a settling time of less than 2 seconds. While that of the passive damping generates a continuous harmonic. Therefore, more modification is required on the passive damping system in regard to Body Acceleration. The Body Displacement which represents the ride quality shows a balance using active damping with LQR controller for the three road profiles. The Active damping with LQR controller gives lower amplitude and fast settling time for all the parameters compared to passive damping system. The output performance is the same because each pairs of wheel set have the same output performance due to the mathematical modeling; this shows that there is relationship between these wheels that is, front wheel right and left and rear wheel right and left receives same types of disturbance.

The table below shows the amplitude reduction in all parameters by passive and active damping as compared to the road profile with amplitude of 0.05m. The amplitude reduction for the active is given by:

$$\frac{\text{peak value of passive} - \text{peak value of active}}{\text{peak value of passive}} \times 100 \text{ for all parameters.}$$

Table 3: Percentage Reduction in Amplitude Value for Passive and Active Damping for Full Car Model

| Parameters | Maximum Overshoot | | | Amplitude Reduction (%) | | |
|---|-------------------|----------|----------|-------------------------|-------------------|-------------------|
| | Profile | Passive | Active | Profile Vs Passive | Profile Vs Active | Passive Vs Active |
| Wheel displacement for front right and left (m) | 0.05 | 0.00296 | 0.000 | 94.1 | 100 | 100 |
| Wheel displacement for rear right and left (m) | 0.05 | 0.00296 | 0.000 | 94.1 | 100 | 100 |
| Wheel deflection for front right and left (m) | 0.05 | 0.002867 | 0.000 | 94.3 | 100 | 100 |
| Wheel deflection for front right and left (m) | 0.05 | 0.002867 | 0.000 | 94.3 | 100 | 100 |
| Suspension travel for front right and left (m) | 0.05 | 0.04782 | 0.000 | 4.40 | 100 | 100 |
| Suspension travel for rear right and left (m) | 0.05 | 0.04782 | 0.000 | 4.40 | 100 | 100 |
| Body displacement (m) | 0.05 | 0.0000 | 0.000 | 100 | 100 | 100 |
| Body Acceleration (m/s ²) | 0.05 | 0.002773 | 0.001277 | 94.5 | 97.5 | 54.0 |

5. Conclusion

Mathematical model for Passive and Active damping system for a full car were derived and validated. Simulation of the Passive and Active damping system with LQR controller was performed and comparison were made between the Passive and Active damping system. The Active damping with LQR gives lower amplitude and faster settling time of less than 2 seconds as compared to the Passive damping and other controllers (e.g. PID) that have been used in Active damping system.

References

- [1] Preumont, A. (2011). Vibration control of active structures. Kluwer Academic Publishers
- [2] Ayman A. A. & Farhan A. S. (2013). Vehicle Suspension Systems Control: A Review. International Journal of Control, Automation and Systems Vol.2 No.2 pp.126-134
- [3] [ajer.org/paper/v6\(11\)/E06112938.pdf](http://ajer.org/paper/v6(11)/E06112938.pdf)
- [4] aircase.org/journal/ijaia/papers/0411ijaia03.pdf
- [5] Thite, A. N. (2012). Development of a Refined Quarter Car Model for the Analysis of Discomfort due to Vibration. Advances in Acoustics and Vibration, Hindawi Publishing Corporation, Article ID 863061, doi:10.1155/2012/863061.
- [6] Yoshimura, T., Kume, A., Kurimoto, M. & Hino, J. (2000). Construction of an Active Suspension System of a Quarter-Car Model Using the Concept of Sliding Mode Control. Journal of Sound and Vibration, 239: pp. 187-199.
- [7] <https://www.researchgate.net/profile/Yah...Ocf23da6cb5b9058.pdf>
- [8] Pable, M. J. & Seshu, P. (2007). Design of Passive Suspensions to Reduce Actuator Control Effort. 12th IFToMM World Congress, Besançon (France).
- [9] Mitra, A., Benerjee, N., Khalane, H. A., Sonawane, M. A., Joshi, D. R. & Bagul, G. R. (2014). Simulation and analysis of full car model for various Road profile on an analytically validated MATLAB/SIMULINK Model. IOSR Journal of Mechanical and Civil Engineering (IOSR-JMCE) ISSN(e): 2278-1684. www.iosrjournals.org
- [10] Hrovat, D. & Tseng, T. (1990). Some Characteristics of Optimal Vehicle Suspensions Based on Quarter Car Model. IEEE Proceedings of the 29th Conferences on Decision and Control, December, Honolulu, Hawaii: IEEE. pp. 2232-2237
- [11] Wu, S. J., Chiang, H. H., Chen, J. H. & Lee, T. T. (2004). Optimal Fuzzy Control Design for Half-Car Active Suspension Systems. IEEE Proceeding of the International Conference on Networking, Sensing and Control. March, Taipei, Taiwan: IEEE. pp. 21-23
- [12] Aldair, A & Wang, W. J. (2011). Design of an Intelligent Controller for Full Vehicle Nonlinear Active Suspension Systems. International Journal on Smart Sensing and Intelligent Systems, vol. 4, no. 2, pp. 224-243
- [13] Robert, L. W. & Kent, L. L. (1997). Modeling and Simulation of Dynamic System. Second Edition, Prentice-Hall.
- [14] srjournal.org/iosr-jmce/papers/RDME-Volume1/RDME-4.pdf
- [15] William, D. L. & Hadad, W. M. (1997). Active Suspension Control to Improve Vehicle Ride and Handling. Vehicle System Dynamic. 1997. 28: 1-24 70
- [16] Sam, Y. M., Ghani, M. R. A. & Ahmad, N. (2000). LQR Controller for Active Car Suspension. IEEE Control System 2000 I441-I444
- [17] Hespanhna, J. P. (2007). Undergraduate Lecture Note on LQG/LGR controller Design. University of California Santa Barbara;

*Corresponding author.

E-mail address: godiesluv@yahoo.com