

CHAPTER 1

Solar, wind and geothermal energy applications in agriculture: back to the future?

Jochen Bundschuh, Guangnan Chen, Barbara Tomaszewska, Noredine Ghaffour, Shahbaz Mushtaq, Ihsan Hamawand, Kathryn Reardon-Smith, Tek Maraseni, Thomas Banhazi, Hacene Mahmoudi, Mattheus Goosen & Diogenes L. Antille

1.1 INTRODUCTION

The agri-food chain consumes about one third of the world's energy production with about 12% for crop production and nearly 80% for processing, distribution, retail, preparation and cooking (Fig. 1.1) (FAO, 2011b). The agri-food chain also accounts for 80–90% of total global freshwater use (Hoff, 2011) where 70% is for irrigation alone. Additionally, on a global scale, freshwater production consumes nearly 15% of the entire energy production (IEA, 2012). It can therefore be argued that making agriculture and the agri-food supply chain independent from fossil fuel use has huge potential to contribute to global food security and climate protection not only for the next decades, but also for the coming century. Provision of secure, accessible and environmentally sustainable supplies of water, energy and food must thus be a priority.

One of the major objectives of the world's scientists, farmers, decision-makers and industrialists is to overcome the present dependence on fossil fuels in the agri-food sector. This dependency increases the volatility of food prices and affects economic access to sustenance. For example, Figure 1.2 shows the close interrelationship between the crude oil price index and the cereals price index. An increasing energy demand for cultivation is particularly important in regions

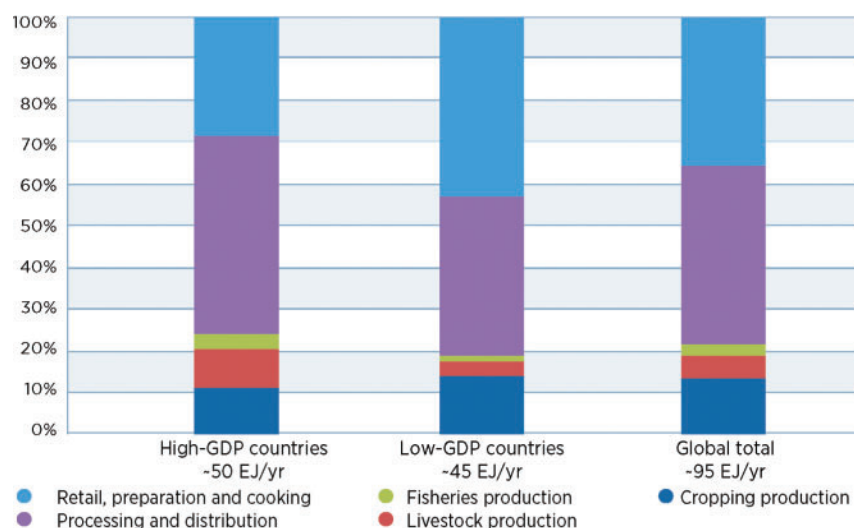

Figure 1.1. Direct and indirect energy inputs in the food sector (FAO, 2011b).

2 J. Bundschuh et al.

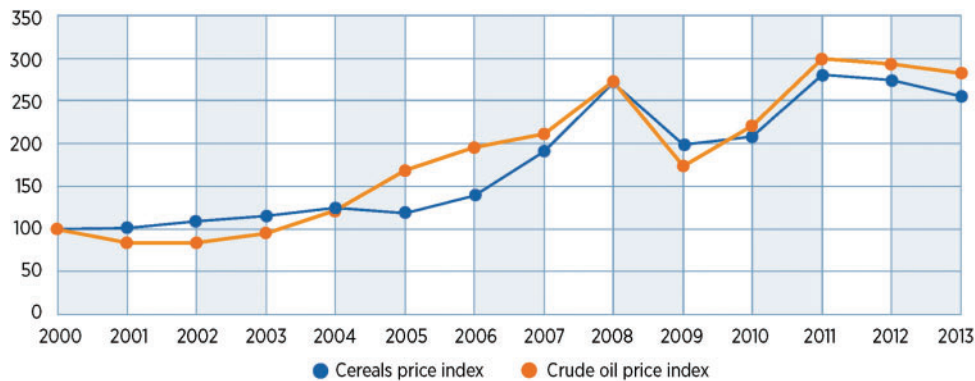

Figure 1.2. Dependence of fossil fuel price index and the cereal price index for the period 2000–2013 (IRENA, 2015, based on FAO Food Price Index and BP Statistics Review of World Energy; base 2000 = 100).

with expanding irrigated agriculture using pumped water. This translates to a food-related risk to energy security.

The development and commercialization of renewable energy sources such as solar, wind and geothermal provides great potential to reduce costs in the agri-food sector. For instance, in addition to power generation, the main uses of geothermal waters are for space heating, district heating, spas balneology, aquaculture and greenhouse heating (Lund and Boyd, 2015). However, much work remains to be done to make better use of renewable energy in the agri-food sector.

The aim of this introductory chapter is to critically review recent developments in solar, wind and geothermal energy applications in agriculture and the agri-food sector such as processing, distribution, retail, preparation and cooking.

1.2 ENERGY DEMANDS IN AGRICULTURE

1.2.1 Energy use in agriculture

Agriculture and food systems rely on a variety of energy sources, including renewable and non-renewable resources—such as fossil fuels—as well as human and animal labor. At present, fossil fuels, in their various forms, supply most of the energy required by agriculture that feeds the world (Maraseni et al., 2015). Food production is an increasingly energy-demanding sector and is needed in all stages of the agri-food chain. In many cases, energy costs may represent a significant proportion of the total agricultural production input cost, including the price of irrigation, as well as the outlay of manufacturing and transportation of various chemicals and fertilizers.

Energy is used both on-farm and off-farm. It can be further divided into direct energy used, i.e. the fuel and electricity consumed, and the indirect energy (embodied energy) involved in the manufacturing of all other inputs, such as equipment and agro-chemicals (Chen et al., 2010). Direct energy may be consumed in three major forms on farms: (i) general electricity usage for lighting, appliances, irrigation; (ii) fuel use for machinery, tractors and vehicles; and (iii) heating/cooling for industries such as dairy, horticulture, piggeries and poultry. In field crops, irrigation energy may account for up to 85% of total direct energy use (Maraseni et al., 2015). With the new technologies currently under development, Renewable Energy (RE) with its rapidly falling costs, is being increasingly employed in agriculture.

1.2.2 The energy management process

Energy audits are a crucial part of farm energy management (Chen and Baillie, 2009a). This type of audit refers to the systematic examination of a farm, facility or site, to determine whether, and to

what extent, it has used energy efficiently. An energy review determines how efficiently it is being used. It also identifies energy cost-saving opportunities and highlights potential improvements in productivity and quality. An energy check may also assess potential savings through strategies such as fuel switching, tariff negotiation and demand-side management (e.g., by changing to alternative farming systems and farm layouts). An energy assessment may be undertaken as part of a broader plan to manage production inputs on-farm (Chen and Baillie, 2009a). The objectives of energy audits include:

- Conserve energy inputs.
- Reduce greenhouse gas emissions.
- Achieve operational and cost efficiencies with improved productivity and profitability.

Extensive research has been conducted on both energy use and conservation in agriculture. Recent results of energy efficiency programs have shown considerable variation in energy use between different crops as well as different farms of similar production systems (Chen et al., 2015). Pellizzi et al. (1988) found that in Europe, the range of field energy consumption for wheat-like cereals varied from 2.5–4.3 GJ ha⁻¹. For cotton, a study by Chen and Baillie (2009b) showed that the direct energy inputs for cotton production in Australia ranged from 3.7–15.2 GJ ha⁻¹. Diesel energy inputs ranged from 95–365 L ha⁻¹, with most farms using between 120–180 L ha⁻¹. Dry land cotton was at the lower end of this range. The direct on-farm energy use of some nurseries may be up to 20,000 GJ ha⁻¹ (Chen et al., 2015).

1.3 THE WATER-ENERGY-FOOD-CLIMATE NEXUS

Agricultural productivity largely depends on the availability of water, energy and land resources. In the past, the agriculture sector enjoyed increasing productivity and was thus able to feed the growing world population. For example, in 2016, the world cereal production was 2,526 Mt (million metric tons) compared with 2000 Mt in 2006 (FAO, 2016). However, the agriculture industry in the 21st century faces numerous challenges. It must feed a rapidly increasing population with a depleting availability of resources (FAO, 2013; Haddeland et al., 2014). At the same time it needs to adapt to a changing climate and reduce greenhouse gas (GHG) emissions (Kulak et al., 2013). Therefore, acclimatizing to climate transformation and the necessity to increase agricultural productivity with minimum use of these resources is a major requirement of the 21st century (Jackson et al., 2010).

It can be argued that the irrigation industry is a significant contributor to the global economy. However, the industry is currently under pressure to cut water use as an adaptation to a reduction in water availability owing to climate variability and change, and competition from other sectors including demands for environmental water (Ward et al., 2006). The conversion of less efficient flood irrigation systems to more efficient pressurized irrigation systems has been heralded as one way of increasing water use efficiency and creating water savings (Mushtaq et al., 2013). However, pressurized irrigation systems may alter patterns of on-farm energy consumption and may increase cropping intensity. More intensive land use might involve more fuel, farm machinery and agrochemicals, and the production, packaging, transportation and application of these also requires significant energy resources, leading to an increase in GHG emissions (Maraseni and Cockfield, 2011a,b; 2012; Maraseni et al., 2012a; 2012b).

This suggests that there is a potential conflict in terms of mitigation and adaptation policies, and thus warrants a comprehensive and robust investigation. There is very little research in this important policy area. Topak et al. (2005) and Baillie (2009) have compared the energy consumption of various irrigation systems, but these studies failed to provide a complete picture as they did not analyze soil carbon, GHG emissions associated with the use of primary farm inputs, or water consumption and GHG implications of more intensive cropping systems. Similarly, Maraseni et al. (2012a; 2012b) tried to assess GHGs and water saving implications of converting flood irrigation systems into pressurized irrigation systems through five case studies (three cotton,

one lettuce and one lucerne) in southern Queensland, Australia. Yet, these studies considered only one crop and did not assess all crops in a rotation. Even within the same irrigation technology, the level of farm inputs (i.e. fuels, agrochemicals, machinery) and thus the energy consumption and GHG emissions due to production, consumption and use of those farm inputs, could vary significantly between crops in a rotation. A farmer may employ more agrochemicals in a first crop with the intention to use less in the following crop. Therefore, comprehensive studies of water and energy consumption, across full cropping rotations covering a wide geographical area, are necessary.

1.4 GREENHOUSE GAS EMISSIONS AND CARBON FOOTPRINT OF AGRICULTURE

1.4.1 *Sources of greenhouse gas emissions from agriculture*

Agriculture and food systems play an important role in climate change because of their significant energy use and also as a potential source for RE such as bio-ethanol and bio-diesel. Overall, the main sources of emissions in agricultural production are (Chen et al., 2010):

- Emissions from energy used to power various machinery and processes which may include both the on-farm and post-farm activities.
- Emissions from energy used to produce agricultural inputs such as fertilizers and pesticides (i.e. pre-farm).
- Direct soil emissions or sequestration in soil (on-farm).
- Soil nitrous oxide (N₂O) emissions from the application of nitrogen fertilizer and manures (on-farm).
- Methane (CH₄) emissions from prolonged water-logging or from the digestion systems of livestock (on-farm).

With current technology, burning one liter of petrol or diesel would, on average, emit 2.3 and 2.7 kg CO₂, respectively. It is also noted that for the same power output, greenhouse gas emissions from electricity would vary considerably if different fuels were used to generate it. Furthermore, it is estimated that with the current manufacturing technology, the production of one kg of nitrogen fertilizer would require the energy input equivalent to 1.5–2 kg of fuel, while 1 kg of pesticides would require the energy input equivalent to up to 5 kg of fuel.

Finally, carbon emissions & sequestration in soil, as well as soil nitrous oxide (N₂O) emissions from the application of nitrogen fertilizer and manure, are also more difficult and expensive to measure accurately because their annual fluxes are often small, variable and distributed over large areas. Methane and N₂O have global warming potentials 25 and 298 times that of CO₂ respectively, over a 100-year time period (IPCC, 2007).

1.4.2 *Overview of global agricultural emissions*

There were approximately 50.1 GtCO₂e greenhouse gas (GHG) emissions from anthropogenic sources in 2010 (IPCC, 2014). Agriculture shares about 11% of these emissions (Tubiello et al., 2015). This percentage relates to direct sources only. If emissions from indirect sources are considered, a further 3–6% of global emissions (Vermuelen et al., 2012) are accounted for. Approximately 60% of all N₂O and 50% of all CH₄ emissions originate in the agricultural sector (Smith et al., 2007).

Similarly, about 38% of direct agricultural emissions are attributed to N₂O from soils, 32% to CH₄ from ruminants, 12% to biomass burning, 11% to CH₄ from rice production and 7% to manure management (Bellarby et al., 2008). There is evidence of an upsurge in GHG emissions with rising farm inputs, due to growing mechanization and modernization (Graham and Williams, 2003; Maraseni, 2007; Maraseni and Cockfield, 2011a; Mushtaq et al., 2013). For example, during the period 1990–2005, global agriculture emissions increased by 14%, an average rate of

Solar, wind and geothermal energy applications in agriculture: back to the future? 5

49 MtCO₂-e year⁻¹ (USEPA, 2006). Therefore, meeting the proposed 2°C climate stabilization target is not possible without reducing agrarian discharges.

Agricultural emission from developing countries is much higher than that of developed nations. For example, in 2005, developing countries were responsible for 74% of global agricultural emissions, whereas developed states were accountable for only 26% (Smith et al., 2007). The proportional contribution of agricultural emissions for developing countries has been increasing faster due to rapid increases in farm inputs to feed growing populations with limited farming areas (Tubiello et al., 2015). Therefore, without developing countries shouldering responsibility, a reduction in global agricultural emissions is not possible.

FAO (2014) predicts that there will be over 9 billion people globally by 2050. In order to feed them, agricultural production should increase by 60% by 2050. About 80% of the yield rise will come from intensification (i.e. higher yields with more fertilizer, pesticide and water inputs, multiple cropping, shorter fallow periods and improved seed varieties) and another 20% will come from extensification (Johnson et al., 2014). The ratio will be 70:30 in developing countries. Both these intensification and extensification processes will increase the share of agricultural emissions. However, research by Johnson et al. (2014) showed that the selective extensification of agriculture could save some 22 GtCO₂e emissions by 2050, compared with a business-as-usual approach. Consequently, a wise land-use planning and coordinated approach between government departments is necessary for reducing agricultural emissions.

1.4.3 *Life cycle assessment (LCA)*

To achieve sustainable development, the first step would be to understand and identify where the environmental impacts and damages actually occur so that targeted remedy actions can be taken. To determine the carbon footprint of agricultural products, it is necessary to identify and consider the full life cycle of the products, from growing to harvesting, as well as their waste management and finally disposal or recycling of the packaging (Klöpffer, 2012). Life cycle assessment (LCA) is a cradle to grave analysis. It examines a system performance starting with the extraction of raw materials from the earth followed by the operations, until the final disposal of the material as waste. This provides the knowledge of how much energy and raw materials are used at each stage of the product life and how much different types of waste are generated. LCA thus helps to analyze the process involved, and allows the consumer more information on the choices of the product. In particular, compared with other methods LCA analysis has the advantage of being able to quantify the magnitude of the potential environmental saving in each environmental category, and to avoid the pitfall of just shifting the environmental impacts from one category to another. An LCA project should comply with the international standards ISO 14040–14044 (Klöpffer, 2012).

Generally, an LCA analysis consists of the following four steps:

- Initiation (goal and scope definition, project planning).
- Inventory analysis (data collection, identifying all relevant input and output items).
- Impact assessment (analysis, quantification and evaluation of impacts on ecosystems, human beings and resources use).
- Interpretation and improvement assessment (sensitivity study, evaluation of options to reduce environmental loads).

Overall, LCA is often a computer-based data-intensive operation. It requires time, skill, a large amount of data and software to manipulate the data. Particularly, industry and region specific Life Cycle Inventory (LCI) is essential to undertake a proper LCA project, as differences in the input data as well as project methodologies can significantly affect results and lead to highly variable conclusions. Furthermore, international standardization is likewise necessary (Roy et al., 2009). Decision support tools for best practices and most cost-effective designs and management must be developed. In addition to energy and greenhouse gas emissions, the quantification of the impacts of water and land footprints, and the effects of pesticides and biodiversity are also receiving increasing attention.

1.4.4 *Comparison of environmental impact of different foods*

LCA has now been widely used for process improvements and optimization, including in agriculture and in the food industry (Roy et al., 2009; Chen et al., 2010). For example, it has been estimated that to produce 1 kg of grain in Australia, overall 0.1 kg of fuel may be consumed and 0.3 kg of greenhouse gases emitted. However, the total emissions can be significantly influenced by the management and operation methods used and also the product types. Biswas et al. (2010) showed that the life cycle GHG emissions for 1 kg of wool is significantly higher than that for wheat and sheep meat. It was also identified that the on-farm stage contributed the most significant portion of total GHG emissions from the production of wheat, sheep meat and wool. It was further established that CH₄ emissions from enteric methane production and from the decomposition of manure accounted for a significant portion of the total emissions from sub-clover and mixed pasture production, while N₂O emissions from the soil under wheat production have been found to be the major source of GHG emissions. Use of RE may also have a significant benefit. With the advent of eco-labeling, LCA is being increasingly used as a reporting mechanism. It has been, however, argued by some, that carbon labeling may also have unintended consequences as a “green barrier” for international trade.

1.5 MERGING RENEWABLES WITH AGRICULTURE: THE SUSTAINABILITY APPROACH

A way to overcome the present dependence on fossil fuels is the integration of energy efficiency and particularly RE, the prices of which are—due to improved technologies, but especially due to increasing mass production—continuously decreasing into the agri-food chain sectors. Substituting fossil fuel energy resources with renewables becomes progressively important as agricultural intensity is always growing; i.e., increasing mechanization, expansion of irrigated land, fertilizer production and transportation require more and more energy (IRENA, 2015). Overcoming risks of future fossil fuel availability, fluctuating prices—often making them unavailable for the poor—and their contribution to global warming requires a decoupling of the agricultural sector from fossil fuels. This can be achieved by increasing energy efficiency and the introduction of Renewable Energy Sources (RES) providing mechanical energy, heat, and electricity as outlined in the FAO Energy-Smart Food Program (FAO, 2011a) (Fig. 1.3). Integration of RES, especially if they are available locally, into the food chain, i.e., integrated food-energy systems, can directly save the farmers’ money, but most importantly, it can indirectly significantly contribute to creation of local development by creating jobs, poverty reduction, improved gender equity and food security and at the same time contribute to global food security and global climate protection. Renewable energy can be used either directly (on-site), or indirectly integrating RE into the existing conventional energy supply chain (Fig. 1.4).

1.5.1 *Solar photovoltaic energy applications*

Solar energy in the form of photovoltaic (PV)-produced electricity can supply and/or supplement many energy requirements both on the farm and the entire agri-food chain. All that is now powered by electricity (produced from fossil fuels) can be adapted to be powered by PV modules. These can be grid-connected PV systems, which allow the farmers to sell their not-used solar power to the electricity utility, or a stand-alone system which, if electricity is continuously used for a specific process, needs a storage system as solar is an intermittent available energy source. However, many electricity-driven processes can be performed during the day when solar power is available such as water pumping, and shearing of sheep. Depending on the distance to the grid and its voltage, PV systems could be much cheaper and of less maintenance needs in remote areas, than installing power lines for connecting to the grid, which further may include the need of installing step down transformers. Solar PV applications in agriculture are comprised of: (i) remote electricity supply,

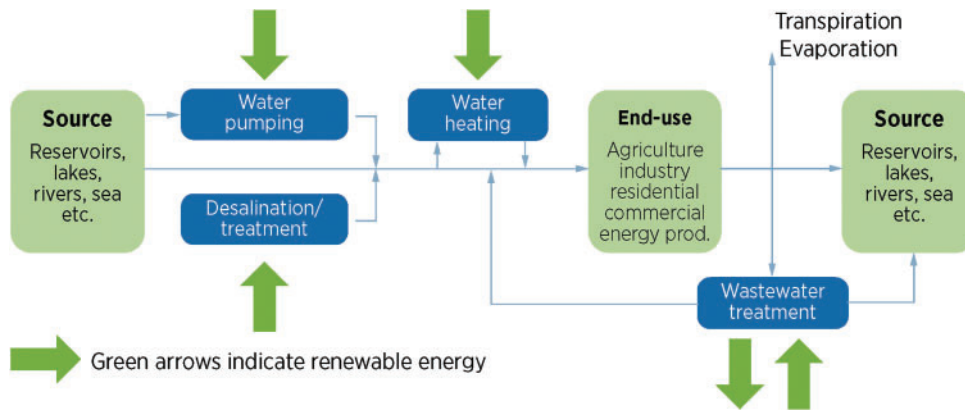

Figure 1.3. Renewable energy applications of the water supply chain (IRENA, 2015).

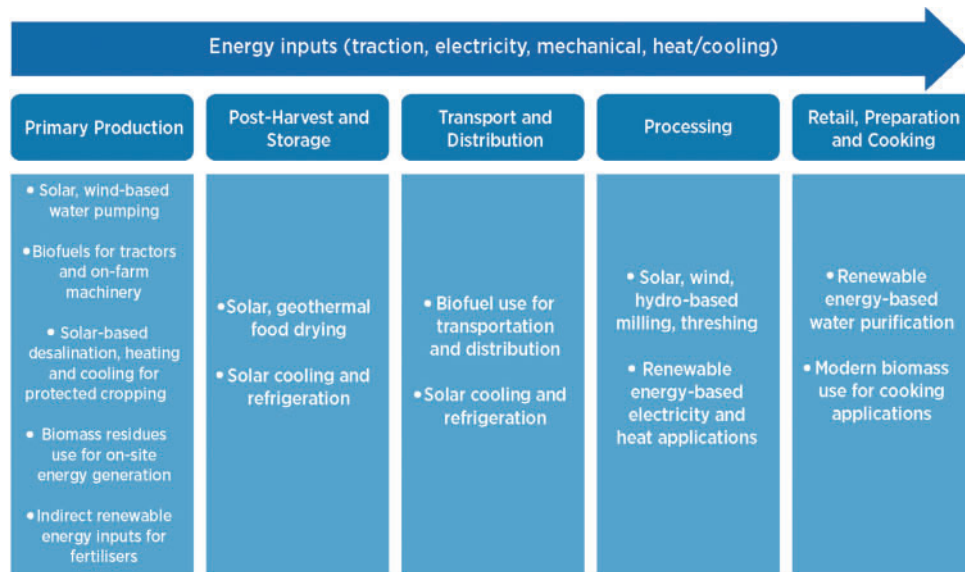

Figure 1.4. Directly (on-site) or indirectly integrating of renewable energy into the existing conventional energy supply chain (IRENA, 2015, based on FAO, 2011b Practical Action 2012).

electric fencing and water pumping, and (ii) general applications, which are presently powered by electricity produced from fossil fuels.

1.5.1.1 *Water pumping*

In agriculture and the agri-food chain in general, PV can be employed for water pumping in different applications. Pumping from groundwater and surface water bodies, is a principal energy consumer and therefore a principal target for implementing RE technologies to substitute the electricity produced from the fossil fuels and diesel fuel commonly used for water pumping.

Even though solar water pumping is no novelty—it has existed since the early 1980s—it is not until recent decades that it has been accepted as an easy-to-install sustainable solution for different scales and for being environmentally friendly. Reasons for this were technical improvements, but especially the mass production of solar panels and their respective price drop (Varardi, 2014).

Table 1.1. Global use of geothermal heat in agriculture by application category (after Lund and Boyd, 2015).

Category		1995	2000	2005	2010	2015
Greenhouse heating	Capacity [MWt]	1085	1246	1404	1544	1830
	Utilization [TJ year ⁻¹]	15742	17864	20661	23264	26662
	Capacity factor	0.46	0.45	0.47	0.48	0.462
Aquaculture pond heating	Capacity [MWt]	1097	605	616	653	695
	Utilization [TJ year ⁻¹]	13493	11733	10976	11521	11958
	Capacity factor	0.39	0.61	0.57	0.56	0.546
Agriculture drying	Capacity [MWt]	67	74	157	125	161
	Utilization [TJ year ⁻¹]	1124	1038	2013	1635	2030
	Capacity factor	0.53	0.44	0.41	0.41	0.400

Most solar water pumps have a power between 0.15–21 kW, with lifts of up to 350 m and flow rates of up to 130 m³ h⁻¹ (Varardi, 2014). PV water pumping systems are very reliable and generally the most cost-effective solution in locations where the electricity grid is non-existent or far away; in these areas, it has, when compared to diesel-powered pumps, the additional benefit of much less maintenance needs compared to the diesel option.

In Chapter 9 of this book, solar water pumping is described in more detail, and compared with diesel and grid-electricity-powered pumping in regard to its technical setup and suitability for different situations (e.g. economic, social, geographic, hydrogeological) and case studies with experiences from USA, New York state (NYSERDA, 2005), India (Casey, 2013; GIZ, 2013; IRENA, 2015) and Morocco (Lorentz GmbH, 2013; IFC, 2014) are presented.

1.5.2 *Solar and geothermal direct heat applications*

Since solar and geothermal heat can be generally used for the same applications, they will be discussed together. Solar and geothermal heat can be employed for: (i) heating/cooling of spaces, buildings, soil and water (including water for aquaculture), (ii) drying of crops and grains, and (iii) heating of greenhouses. The use of geothermal energy, which is a constant heat source, available 24 hours a day, 365 days a year, is often underestimated. The fact that this resource is practically limitless and renewable, together with—in contrast to the solar option—its independence of changing climate and weather conditions, presents clear advantages in favor of its extended utilization. Irrespective of the obvious climate protection benefits, the direct and indirect development of these resources for heating, agriculture and horticulture, should also respect other elements of the natural environment (Tomaszewska et al., 2016). Table 1.1 shows global installed thermal capacities, thermal energy utilization and capacity factors for different applications in agriculture and the agri-food chain using geothermal resources and their change from 1995–2015. Integrated configurations for using geothermal heat for multiple use applications are presented separately in Section 1.5.5.

1.5.2.1 *Heating/cooling of spaces, buildings, soil and water*

Space heating (but also cooling using heat in mechanical or evaporative cooling cycles) is an important energy consumer in many applications, especially in pig and poultry production, which is mostly carried out in closed buildings and thus requires constant temperature and air quality conditions for the animals' well-being to optimize growth. Much energy is needed for replacing contaminated (moisture, gases, odor, dust, etc.) indoor air through ventilation and heating. A large part of this energy can be covered by RE using, e.g. solar or geothermal heat-driven air/space heaters/coolers/dehumidifier.

Heating and cooling of water (but also milk and agricultural products) for use in the agri-food chain is energy-intensive and an economic burden, especially in developing countries and areas

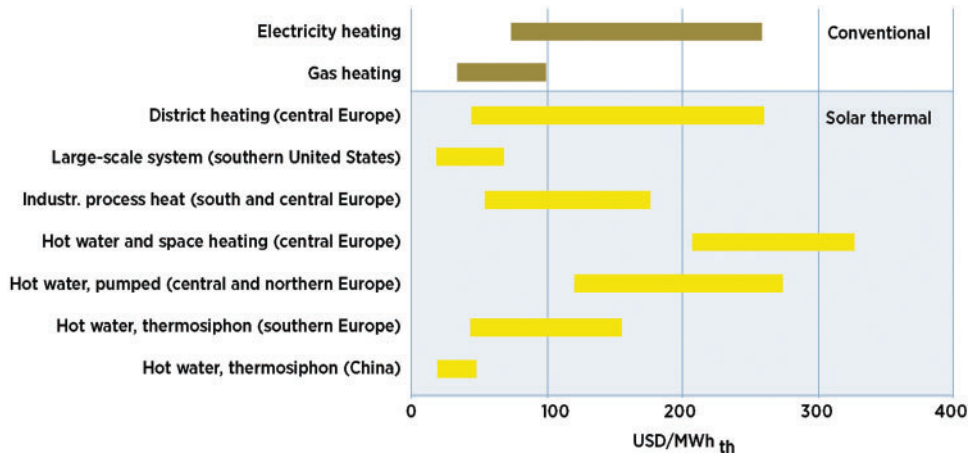

Figure 1.5. Thermal solar water heating costs compared to conventional heating (IEA, 2014).

which are remote from electric power plants (as many agricultural areas are) which leads to further distribution losses in the electricity grid. Locally available RES, such as solar and geothermal, are economically and environmentally sustainable energy sources that are increasingly used to replace fossil fuels through electricity or—wherever possible as it has in many cases lower cost—directly to heat water. An example of high energy demands are commercial dairy farms where solar heat is used to heat water for cleaning equipment, warming and stimulating the cows’ udders but also for cooling milk; these processes account for up to 40% of farms’ total energy demand (IRENA, 2015). Considering all applications, the global capacity of solar water heating increased from 65 GWt (gigawatts-thermal) in 2000 to 326 GWt in 2013 (REN21, 2014). Considering further technological improvements and increasing mass production will result in a further increase in many areas, including different applications in the agri-food chain where water heating is required. As Figure 1.5 shows, water heating costs derived from different applications expand over large ranges and can economically compete with those using fossil fuels, either directly or through electricity for water heating. The same can be expected from applications within the agri-food chain industries.

1.5.2.2 *Drying of crops, fruits, grains and animal products*

There are many options for using heat from sun and geothermal sources for drying crops and grain, ranging from very simple and cheap to sophisticated and expensive. The sun has been employed for thousands of years for drying crops directly on the field or drying fruits on or in special devices after being harvested. Today’s industrial-scale demands require generally fast and uniform drying to obtain high quality products suitable for the world market; however, for local or regional markets, in particular in developing countries, less sophisticated, cheaper drying designs are often more suitable.

Where geothermal sources are naturally available and accessible (at shallow depth, springs, etc.) geothermal drying is an excellent option. In contrast to solar, geothermal drying is also suitable in areas with little solar radiation such as colder climates. Fifteen countries report the use of geothermal energy for drying various grains, milk, vegetables and fruit crops. Examples include: seaweed (Iceland; Ragnarsson, 2015), onions (USA; Boyd et al., 2015), wheat and other cereals (Serbia; Oudech and Djokic, 2015), fruit (El Salvador, Guatemala and Mexico; Montalvo and Gutierrez, 2015; Lund and Boyd, 2015; Gutiérrez-Negrin et al., 2015), Lucerne or alfalfa (New Zealand; Carey et al., 2015), coconut meat (Philippines; Fronda et al., 2015), and timber

(Mexico, New Zealand and Romania; Gutiérrez-Negrin et al., 2015; Carey et al., 2015; Bendea et al., 2015). The largest uses are in China, USA and Hungary (Lund and Boyd, 2015). By the end of 2014, a total of 161 MWt and 2030 TJ year⁻¹ were being utilized, which is an increase of 28.8 and 24.2%, respectively, compared to 2010. Globally, 4.5% thermal energy is used for greenhouses and open ground heating, 2.0% for aquaculture pond and raceway heating, 1.8% for industrial process heating and 0.4% for agricultural drying (Lund and Boyd, 2015). An example is Iceland, where geothermal energy has been utilized for about 35 years for drying fish. Nowadays, about 15,000 metric tons of cod heads are annually dried using geothermal heat before exporting them to Nigeria (IRENA, 2015). Furthermore, in Nigeria pyrethrum drying is still being carried out at a plant constructed in the 1920s near Ebburu estimated at 1.0 MWt and 10 TJ year⁻¹. In Vietnam, the drying of bananas, coconuts and medicinal herbs occurs using 11.83 TJ year⁻¹ (capacity: at 0.5 MWt) (Lund and Boyd, 2015).

Most solar dryers are small to middle scale in size. Large solar crop driers are in the minority as the example of the USA shows; the reason seems to be the high cost of the solar collector and since—in contrast to gas dryers—drying rates cannot be controlled (IRENA, 2015). However, it should be considered that these solar collectors could be used, in the non-harvesting period for other purposes, reducing the overall costs (IRENA, 2015). However, in hot arid and semi-arid climates, smaller sized dryers may not need a sophisticated collector (just using the glazed box of the system itself), and very low-cost dryers can be constructed using simple design and low-cost materials; such systems are very suitable for drying vegetables, fruits and animal products for home use (IRENA, 2015).

1.5.2.3 *Heating of greenhouses*

Solar and geothermal heat can be ideal and cost-effective energy sources for heating greenhouses. The heat can be employed to heat air and soil thus replacing or adapting heaters which are powered by fossil fuels or electricity produced from non-renewable conventional energy resources. The related cost-reduction of geothermal or solar-heated greenhouses is, in particular, high in remote areas without electricity access. Hence, the geothermal or solar option allows the installation and their economic operation in remote areas and production throughout the whole year.

The leading countries in the use of annual thermal energy being: Turkey, Russia, Hungary, China and The Netherlands (Lund and Boyd, 2015). The main crops grown in greenhouses are vegetables and flowers; however, tree seedlings (USA) and fruit such as bananas (Iceland) are also grown. Despite that the numbers with reported geothermal greenhouses decreased from 34 in 2010 to 31 in 2015, the worldwide use of geothermal energy utilized for greenhouses and covered ground heating increased from 2010 to 2015 by 19% in installed capacity and 16% in annual thermal energy use. The installed capacity was 1830 MWt and energy use was 26,662 TJ year⁻¹ (Lund and Boyd, 2015). In Turkey, greenhouse applications have reached 3 million m² (612 MWt) due to the great success. Tomatoes are mostly grown in these greenhouses with the major markets of Russia (60%), Europe 20%, around 10% elsewhere internationally, and the remaining 10% sold domestically (Mertoglu et al., 2015, Lund and Boyd, 2015).

Integrated operation and case studies of greenhouses using RE for geothermal and solar greenhouse heating/cooling, humidification, ventilation and water desalination for irrigation will be treated separately in Section 1.5.7.1. In Chapter 5 of this book, the energy usage patterns in the nursery industry in Queensland, Australia are examined. The opportunities of adopting renewable energy are also evaluated.

1.5.3 *Wind power applications*

Today, wind energy applications for sole agricultural applications are of reduced importance on a global scale, whereas in the past wind power was used for groundwater pumping. However, the mechanical sensitivity and respective maintenance needs of wind wheels today make diesel or—much better where possible—solar pumping the better option. In contrast, a combination

of pumping using wind energy together with wind farming, i.e. selling energy to electricity companies or lease the land for installing their large-scale wind turbines is an increasing trend as outlined in Section 1.5.4.

1.5.4 *Multi-use of agricultural land for food and electric power production*

Agricultural areas can be used for multipurpose, i.e. food and energy production, where, for example, solar and wind energy are produced together with agricultural products on the same land; all in all being a winning combination by adding electricity generation—a long-term, stable, source of income—to the farmers' incomes from agricultural production. There are different options: (i) the farmers purchase wind turbines/solar panels, (ii) the farmers form wind/solar power cooperatives, and (iii) electricity utilities/developers install/operate the equipment and make payments to the farmers according to different criteria, such as generated electricity, impact on farming activities. According to an estimate by the US Department of Energy in the USA, wind energy alone could provide 80,000 new jobs for rural areas and US\$ 1.2 billion in new income for farmers by 2020 (Cassaday, 2003). In areas with good wind conditions, electricity producers may pay US\$ 2,000–5,000 per year for each wind turbine installed (USA example). Hence, such multi-use of agricultural land could be very attractive for farmers (Cassaday, 2003).

The concept of coproduction of electricity and food was first developed in Japan in 2004, where solar panels were installed in such a way that they did not significantly obstruct agricultural management, such as access of crops to sunlight, or movement of agricultural machinery (IRENA, 2015). In a similar way, wind turbines can be integrated into farming and grazing areas. Another interesting application is the installation of PV panels over irrigation canals to simultaneously produce electricity and reduce evaporative water losses. In an example from India, a 1 MW solar power plant was installed over a 750 m length of a canal system. In one year it produced 1.53 GWh of electricity while at the same time hindered the evaporation of about 3,300 million of water, which can be used for irrigation (IRENA, 2015). It has been estimated that using the area of a 19,000 km canal network could save 20 billion liters of water per year (IRENA, 2015). Such multi-use of agricultural land for food and power production is becoming increasingly more common (IPCC, 2011). Multi-use could significantly increase the income for farmers as an example from Germany proves, where 11% of the installed RE capacity is in the ownership of farmers (2012).

1.5.5 *Agriculture within the cascade system of geothermal direct heat utilization*

When temperatures of geothermal sources are below 100°C, the warm water can be first run through a space heating installation and then cascaded to swimming pools, greenhouses and/or aquaculture pond heating, before being injected back into the aquifer. These kinds of projects maximize the use of the resource as well as improving the economics. An example of the use of geothermal energy in a cascade use is described by Bujakowski (2007). In 1993, The Mineral and Energy Economy Research Institute of the Polish Academy of Sciences (PAS MEERI) in Bańska Niżna (southern Poland, Podhale Basin) built and put into operation the first geothermal plant in Poland (Bujakowski, 2007; Bujakowski and Tomaszewska, 2012). During the 1995–98 period the installation has been developed and nowadays (2016) the cascaded heat supply includes five stages of heat distribution based upon a secondary circulation loop. These are: geothermal space heating system (85–65°C), timber drying building (60°C), parapet greenhouse (45°C), thermophilus fish farm (35°C), and finally, foil tunnels with ground heating (30°C) (Fig. 1.6). This setup enables studies on the multidirectional development of geothermal energy.

Gude (2016) suggested that in many cases the cascade system of geothermal energy use can also include desalination plants (see also Section 1.5.6). Figure 1.7 presents a conceptional example for an integrated configuration to produce power, followed by desalination using both thermal and membrane processes, then for applications in food processing, refrigeration plants and district heating or cooling systems, heating of building spaces, greenhouses and soil heating, industrial process heat and agricultural drying and fish farming. As shown in Figures 1.6 and 1.7, agricultural

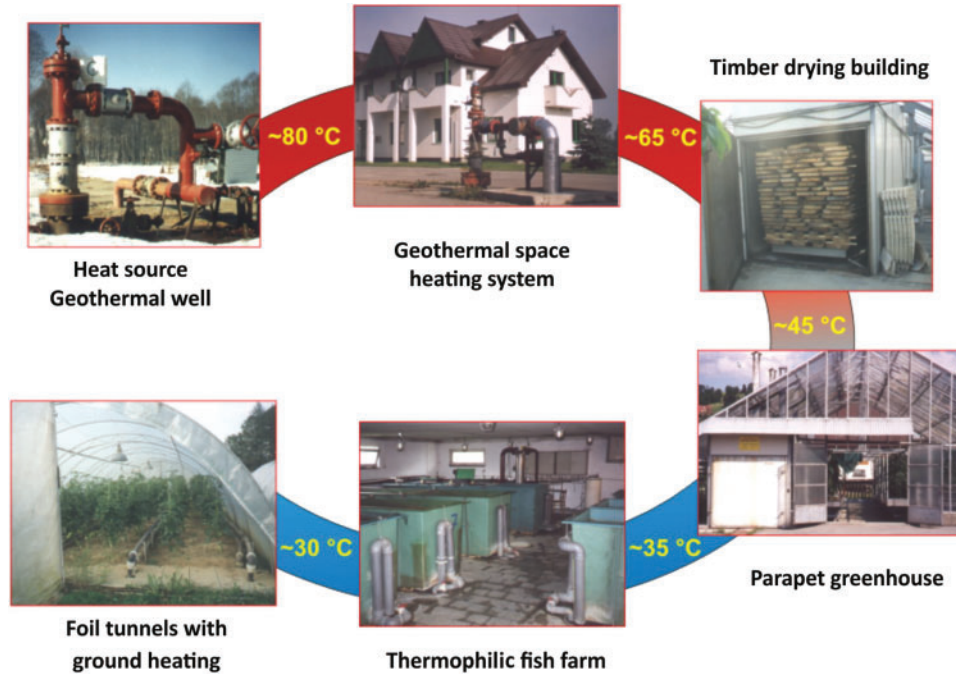

Figure 1.6. The cascade system of geothermal energy utilization in PAS MEERI in Poland (based on Bujakowski, 2007).

and aquacultural uses require the lowest temperatures, with values from 25–90°C. Space heating requires temperatures in the range of 50–100°C, with 40°C useful in some marginal cases and ground-source heat pumps extending the range down to 5°C. Cooling and industrial processing normally require temperatures over 100°C (Gude, 2016; Lund, 2010).

1.5.6 Renewables for water desalination and food security: decoupling freshwater production from fossil fuel supply

As natural availability of freshwater is limited and unevenly distributed in space and time, energy-intensive desalination technologies are playing an increasing role in providing water and food security for future generations. At present, 70 million m³ of freshwater are produced each day from the globally existing 16,000 desalination plants (IRENA, 2015). According to UN Water (2014), desalination annually consumes at least 75.2 TWh of electricity, which corresponds to about 0.4% of global electricity consumption (UN Water, 2014).

Conventional technologies for desalination of salt and brackish water are still limited since they have a high demand for energy, which is mostly provided by expensive fossil fuel, whereas less than 1% of the desalination capacity depends on renewables (IRENA, 2012). Energy costs represent as much as half of the production cost of desalination plants (Herndon, 2013). However, the upsurge in desalination capacity and the proportional energy demand rise make further use of fossil fuels increasingly economically and environmentally unsustainable. A massive shift from desalination powered by fossil fuel to RE-powered technologies will be essential to meet the growing demand for freshwater production by desalination. Decoupling freshwater production costs from the ever-increasing prices of fossil fuels is essential if freshwater is to be provided for agricultural purposes, such as irrigation where water is demanded in large quantities but at lowest possible cost.

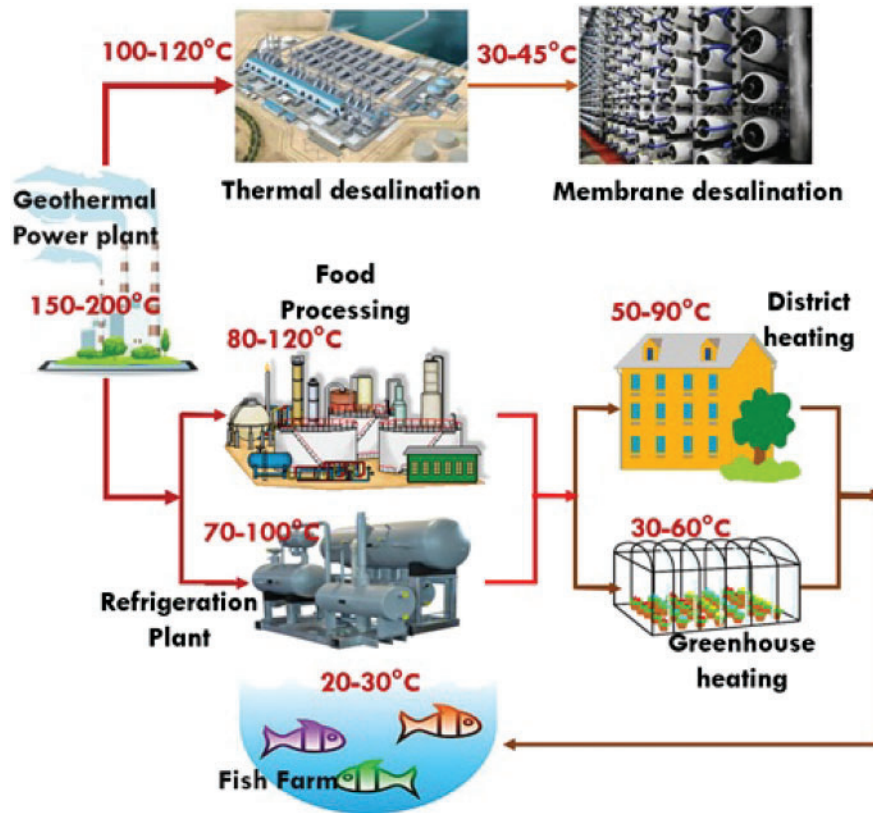

Figure 1.7. Integrated configurations for geothermal energy sources – polygeneration for multiple benefits (after Gude, 2016).

There exist different desalination technologies which can be powered by RES (Ghaffour et al., 2015; Goosen et al., 2014). They comprise mature thermal technologies (multi-stage flash (MSF), multi-effect distillation (MED)), and mature membrane technologies (reverse osmosis (RO), electrodialysis (ED), and electrodialysis reversal (EDR)), as well as emerging technologies which are in their early stage and which require further research and development, such as membrane distillation (MD), vapor compression (VC), adsorption desalination (AD) (Ghaffour et al., 2014) and others (Figs. 1.8 and 1.9).

Significant efforts for adapting conventional desalination technologies so that they can be powered by renewable energy sources (RES) have been made in the last two decades; however, the upscaling to larger sized plants has been hampered by technological, economic and political/regulatory (e.g. subsidies for fossil fuels) challenges. In the last few years, several medium-scale RE-driven desalination plants have been installed worldwide. However, most of them are powered by electricity produced from solar PV and wind—commercial units which are available on the market (IRENA and IEA-ETSAP, 2012)—rather than solar or geothermal heat directly, which can provide more sustainable desalination processes. These electricity-powered desalination units are commonly deployed at the community level. However, they are increasingly being installed on a larger scale as the grid-connected desalination plants from Sydney and Perth demonstrate. Solar thermal desalination, which combines solar heat with desalination technologies such as MSF, MED, VC and MD, is obviously most suited for areas with high solar irradiation (e.g. northern Africa, Middle East, i.e. the MENA region, as well as parts of

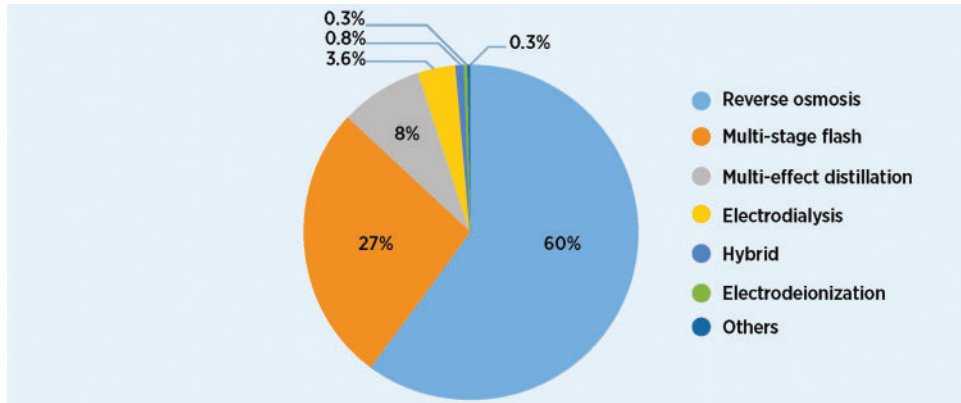

Figure 1.8. Capacities for different technologies for desalination (Koschikowski, 2011).

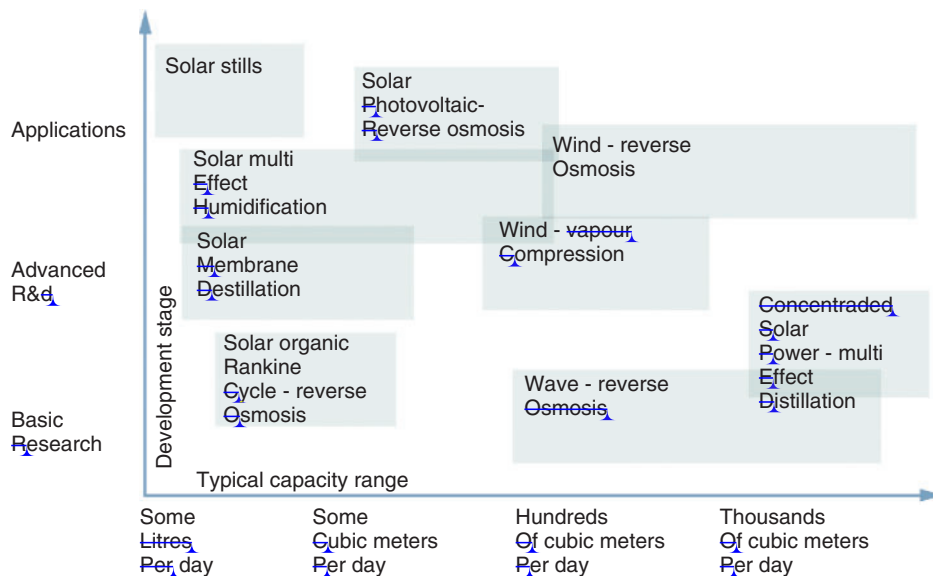

Figure 1.9. Principal renewable energy powered desalination technologies and their development state (Papapetrou et al., 2010).

Australia: 2200–2400 kWh m⁻² year and other world regions) (Zaragoza et al., 2014; Ghaffour et al., 2014). Table 1.2 shows a list of relevant solar thermal plants implemented.

Energy requirements for desalination vary from process to process (Ghaffour et al., 2013). Thermal desalination practices require both thermal and electrical energy for evaporation, process hydraulic flow and transport of the feed and product water. Pressure-driven membrane desalination processes necessitate electrical energy to supply the mechanical energy for membrane separation and pre-treatment, and pumping in and distribution out of the plant (Gude, 2016). Gude (2016) in his review, presented the specific energy consumption for thermal and membrane desalination processes in terms of kJ of energy required for producing one unit of freshwater in kilograms (Fig. 1.10; Table 1.3).

Solar, wind and geothermal energy applications in agriculture: back to the future? 15

Table 1.2. Summary of solar thermal desalination plants in the world.

Project	Capacity [m ³ day ⁻¹]	Process
Margarita de Savoya, Italy [1]	50–60	MSF
Islands of Cape Verde [2]	300	Atlantis ‘Autoflash’
Tunisia [3]	0.2	MSF
El Paso, Texas, USA [4]	19	MSF
University of Ancona, Italy [5]	30	MEB
Dead Sea, Jordan [6]	3000	MEB
Safat, Kuwait [6]	10	MSF
Takami Island, Japan [1]	16	ME-16 effects
Abu Dhabi, UAE [7]	120	ME-18 effects
Al-Ain, UAE [8]	500	ME-55 stages, MSF-75 stages
Arabian Gulf [9]	6000	MEB
Al Azhar University, Palestine [10]	0.2	MSF 4 stages
Almeria, Spain [11]	72	MED-TVC 14 effects
Berken, Germany [12]	10	MSF
Hzag, Tunisia [6]	0.1–0.35	Distillation
Gran Canaria, Spain [13]	10	MSF
La Desired Island, France [14]	40	ME-14 effects
Lampedusa Island, Italy [15]	0.3	MSF
Kuwait [1]	100	MSF
La Paz, Mexico [16]	10	MSF 10-stages

[1] Delyannis (1987); [2] Szacsvey et al. (1999); [3] Safi (1998); [4] Lu et al. (2000); [5] Caruso and Naviglio (1999); [6] El-Nashar (1985); [7] Hanafi (1991); [8] Abu-Jabal et al. (2001); [9] Borsani and Rebagliati (2005); [10] Zarza Moya (1991); [11] Kyritsis (1996); [12] Valverde Muela (1982); [13] Madani (1990); [14] Palma (1991); [15] Manjares and Galvan (1979); [16] Delgado-Torres and García-Rodríguez (2007).

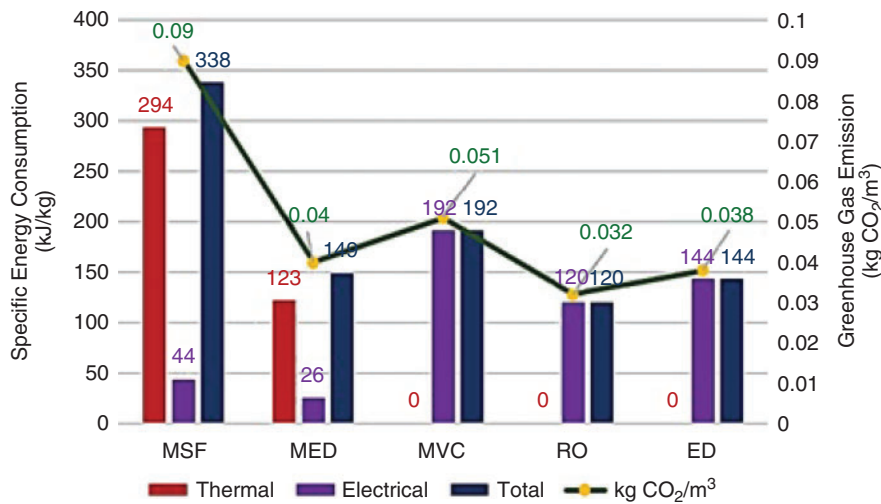

Figure 1.10. Specific energy consumption for thermal and membrane desalination processes and greenhouse gas emissions for unit freshwater production (after Gude, 2016).

The MSF process has the highest specific energy consumption while the seawater reverse osmosis (SWRO) process has the lowest, followed by multi-effect distillation technology. For this reason, there is an increasing trend to replace thermal technologies with membrane methods, primarily reverse osmosis (RO) in cases where no cheap waste heat is available.

Table 1.3. Typical capacity, energy demand and cost for some combinations of solar and desalination technologies (Ghaffour et al., 2015 and references as specified).

	Typical capacity [m ³ day ⁻¹]	Energy demand [kWh m ⁻³]	Water cost [US\$ m ⁻³]
Solar still	<0.1	Solar passive	1.3–6.5
Solar (MEH)	1–100	Ther: 100 Elec: 1.5	2.6–6.5
Solar MSF	1	Ther: 81–144 ¹⁾	1–5 ¹⁾
Solar tower MSF	1	T: 53.7 ²⁾	–
Solar/CSP MED	>5000	Ther: 60–70; Elec: 1.5–2 ³⁾ T: 50–94 ¹⁾	2.3–2.8 ³⁾ (prospective cost) 2–9 ¹⁾
Solar tower MED	1	T: 42.4 ²⁾	–
Solar tower VC	1	Elec: 55.5	–
PV-RO	<100	Elec: BW: 0.5–1.5; SW: 4–5 ³⁾ ; BW-SW: 1.2–19 ¹⁾	BW: 6.5–9.1; SW: 11.7–15.6 ³⁾ ; 3–27 ¹⁾
Solar tower RO	1	Elec: 41–45 ²⁾	–
PV-EDR	<100	Elec: BW: 3–4 ³⁾ BW: 0.6–1 ¹⁾	10.4–11.7 ³⁾ 3–16 ¹⁾
Solar MD	0.15–10	Ther: 150–200 ³⁾ ; 100–600 ¹⁾ ; 436 ⁴⁾ ; 180–2200 ⁵⁾	10.4–19.5 ³⁾ 13–18 ¹⁾
Solar AD	8	Elec: 1.38 T: 39.8 ⁶⁾	0.7 (electrical cost only) ⁶⁾

Elec: BW: Brackish water; Electrical; SW: Seawater; T: Total; Ther: Thermal.

AD: adsorption desalination; CSP: concentrated solar power; ED: electrodialysis; EDR: electrodialysis reversal; MD: membrane distillation; MED: multi-effect distillation; MEH: multiple-effect humidification; MSF: multi-stage flash; PV: photovoltaic; RO: reverse osmosis; VC: vapor compression. ¹⁾Ali et al. (2011); ²⁾Ahmad and Schmid (2002); ³⁾Paparetrou et al. (2010); ⁴⁾Kim et al. (2013); ⁵⁾Saffarini et al. (2012); ⁶⁾Ng et al. (2013).

The range of RE desalination technologies is large and each technology has particular characteristics which would need to be matched to a market analysis to enable investment decisions to be made; this level of detailed analysis is still missing as already mentioned earlier (Paparetrou et al., 2010). On average, RE-based desalination is still expensive when compared to conventional desalination but numbers vary widely based on location and situation. Table 1.3 provides an overview of energy demand and water production costs for some possible combinations of solar and desalination technologies. A detailed assessment of the benefits of these technologies and their limitations are discussed in Tzen et al. (2012) using wind energy, Bundschuh et al. (2015) and Gude (2016) using geothermal heat, and by Ghaffour et al. (2015) for solar and geothermal.

Tzen (2012) provided a detailed review of usage of wind energy for freshwater production, the technology of which is mature and market available. The main problem in utilizing wind power in desalination applications is (i) the variable nature of the resource since storage wind energy as electricity is not sustainable at larger scale and (ii) the variable power input force to the desalination plant which may cause operational problems. Wind-powered desalination systems can be stand-alone or grid-connected. Most of the installed plants utilize the reverse osmosis desalination process. Their freshwater production capacity, electricity supply and year of installation are listed in Table 1.4. Other desalination technologies comprise vapor compression distillation and wind electrodialysis systems.

Figure 1.11 shows several possible combinations of solar and geothermal powered desalination, the individual suitability of which depends on specific site conditions (plant scale, feed water salinity, remoteness, electricity access or not, technical infrastructure, RES and its availability,

Table 1.4. Wind reverse osmosis applications (modified from Tzen et al., 2012).

Location	RO capacity [m ³ h ⁻¹]	Electricity supply	Year of installation
Ile du Planier, France	0.5	4 kW W/T	1982
Island of Suderoog, Germany	0.25–0.37	6 kW W/T	1983
Island of Helgoland, Germany	40	1.2 MW W/T + diesel	1988
Fuerteventura, Spain	2.3	225 kW W/T + 160 kVA diesel, flywheel	1995
Pozo Izquierdo, Gran Canaria, Spain, SDAWES	8 × 1.0	2 × 230 kW W/T	1995
Therasia Island, Greece, APAS	0.2	15 kW W/T, 440 Ah batteries	1995/1996
Syros Island, Greece, JOULE	2.5–37.5	500 kW W/T, stand-alone + grid-connected	1998
Keratea, Greece, PAVET	0.13	900 W W/T, 4 kW _p PV, batteries	2001/2002
Pozo Izquierdo, Gran Canaria, Spain, AEROGEDESA	0.80	15 kW W/T, 190 Ah batteries	2003/2004
Loughborough Univ., U.K.	0.5	2.5 kW, no battery	2001/2002
Milos Island, Greece, OPC Program	6 × 600	850 kW W/T, grid-connected	2007/2008
Heraklia Island, Greece	3.3	30 kW W/T, floating system, batteries	2007
Delft Univ., The Netherlands	0.2–0.4	Windmill, no battery	2007/2008
Perth (Kwinana Desalination Plant)	~140,000 extended: ~250,000	80 MW, W/T, grid-connected	2006
Sydney Desalination Plant	~250,000 extended: ~500,000	140 MW, W/T, grid-connected	2010

W/T: Wind turbines; PV: Photovoltaic.

potential and exploitation cost). Table 1.5 provides an overview of the fresh water productivity for different desalination technologies per square meter of solar collector area.

Ghaffour et al. (2015) provided a critical review of the status of RE-powered desalination technologies, highlighting integrated systems and potential applications together with current technological and economic limitations and challenges. Tzen (2012) and Ghaffour et al. (2015) concluded that the matching of the desalination process with a renewable energy source (RES) is technically feasible. However the problem lies in continuous versus non-continuous operation; desalination processes are best suited to continuous operation, whereas the principal renewable energy sources such as wind and solar are non-continuous. Thus matching a desalination system with an RES source requires special design and operation which increases complexity and cost. At present, technological and economic constraints hinder large-scale applications. Despite that, renewables and desalinations as individual technologies are mature and are produced in mass.

Geothermal energy can be an attractive option if low-cost, low-enthalpy geothermal sources are available. These include geothermal resources at shallow depth, water coproduced from onshore and offshore hydrocarbon wells or from already existing deep wells, and residual heat from geothermal power plants (Bundschuh et al., 2015). Geothermal energy is accessible day and night every day of the year and can thus serve as an add-on to energy sources which are only available intermittently (Goosen et al., 2010). However, the application of geothermal energy in desalination is still a relatively unexplored technical concept (Davies and Orfi, 2014). Some experiments have been described: (i) electricity and freshwater production from geothermal brines using MSF unit (Awerbuch et al., 1976); (ii) a case study of a low-enthalpy geothermal energy-driven MED unit on Milos Island in Greece (Karytsas, 1996); and (iii) one of the latest projects from USA, the VTE Geothermal Desalination Pilot, where geothermal steam will provide the thermal energy

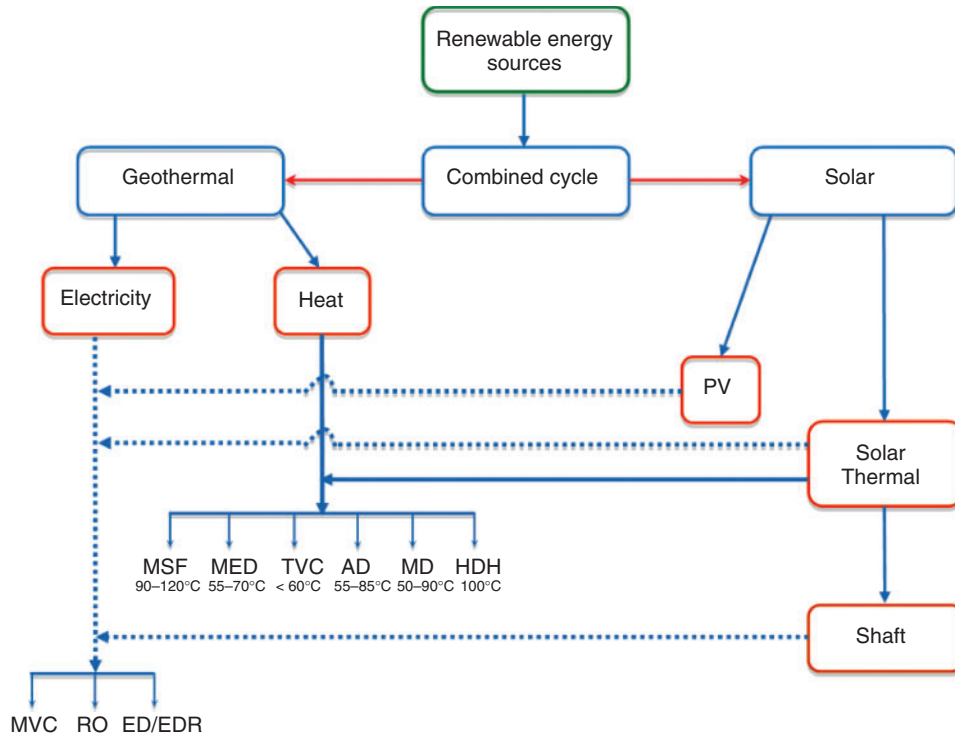

Figure 1.11. Possible combinations of integrated systems: RES with conventional and innovative desalination processes (Ghaffour et al., 2015). AD: Adsorption desalination; ED: Electrodialysis; EDR: Electrodialysis reversal; HDH: Humidification-dehumidification; MD: Membrane distillation; MED: Multi-effect distillation; MSF: Multi-stage flash; MVC: Mechanical vapor compression; PV: Photovoltaic; RO: Reverse osmosis; TVC: Thermal vapor compression.

Table 1.5. Productivity of different desalination processes per square meter of solar collector area (Ghaffour et al., 2015).

Desalination process	Water produced per solar collector area [L day ⁻¹ m ⁻²]
Simple solar still	4–5
H/D process – medium temperature solar thermal collector	12
MSF, MED with thermal storage – medium temperature solar thermal collector	40
SWRO-PV	200
VARI-RO DDE–Dish Sterling solar collector (only in concept stage)	1200

source for the pilot VTE distillation (vertical tube evaporation) process, as the process applied to an MED plant design with low cost (Sephton Water Technology, 2012).

Taking into account a significant increase in global electricity production (Bertani, 2015), between 2015 and 2030, rapid expansion of geothermal electricity and heat production will take place, but be limited to areas where such resources are available. Gude (2016) suggested that high-enthalpy geothermal sources can be utilized in cogeneration schemes for simultaneous power and freshwater production using MSF and MED technologies. Low temperature desalination processes

can be coupled with low-enthalpy geothermal sources. Low temperature desalination processes have lower specific energy requirements and a higher thermodynamic efficiency.

One should notice that geothermal systems not only provide a valuable RES, but can also be considered as the source and solution for freshwater production, including irrigation water being the main freshwater consumer. The desalination of geothermal waters used for energy purposes could be seen as one of the methods for securing high quality water for various purposes. In countries with warm climates it is mainly used for the irrigation of agricultural crops (Kabay et al., 2004a, 2004b, 2009; 2013; Koseoglu et al., 2010; Tomaszewska et al., 2016). Given the increasing deficit of fresh water worldwide, the possibilities for desalinating and treating geothermal waters for drinking and household purposes should be considered (Gallup 2007; Tomaszewska and Bodzek, 2013a, 2013b; Tomaszewska et al., 2014; 2016; Gude, 2016). Alternative solutions such as using cooled water directly for drinking or household purposes are advantageous ones in certain cases as confirmed by the activities of Geotermia Mazowiecka S.A. (Mszczonów, central Poland). Water with a low mineral content (ca. 0.5 g L^{-1}) and with an intake temperature of 42°C has been extracted since 2000 from the Mszczonów IG-1 well—from a Lower Cretaceous horizon composed of sandstone interbedded with mudstone and claystone. These are high quality $\text{Cl-HCO}_3\text{-Na-Ca}$ waters that are fed to the municipal water supply network as drinking water following cooling and simple treatment. The extraction of these waters in an open system with a maximum capacity of $60 \text{ m}^3 \text{ h}^{-1}$ (without re-injecting cooled water into the formation) has significantly improved the economic performance of the project and the utilization of cooled water as drinking water has additionally enhanced the management of ordinary water resources (Tomaszewska and Szczepański, 2014). Applications for agriculture can be similarly developed.

Freshwater production by RE-powered desalination is a technological-sound option at a small- or medium-scale and economically viable for water supply in remote areas. However, upscaling to a large size is still hindered, due to the intermittent availability of wind and solar energy, a disadvantage which geothermal does not have. This also suggests the implementation of a combined-cycle solar and geothermal powered desalination process without the need for energy storage. Also, the development and improvement of innovative desalination technologies which do not need continuous operation such as AD and MD, and which consequently are more suitable for RE use can be utilized to overcome this limitation.

Ongoing research and development of concentrated solar power (CSP) based desalination is also promising. CSP with thermal energy storage shows a large potential for powering large-scale desalination plants and simultaneously producing electricity for other purposes (Ghaffour et al., 2015; Goosen et al., 2014; IRENA, 2015). According to Trieb et al. (2011), CSP-based desalination could produce a major part of the freshwater in the MENA region amounting to about 16% of its total water production in 2030 and 22% in 2050.

1.5.7 *Geothermal and solar greenhouse heating/cooling, ventilation, humidification, desalination*

1.5.7.1 *Solar and geothermal based greenhouse development*

Several recent reviews have appeared on the state-of-the-art solar and geothermal technology in agricultural greenhouse development (Mahmoudi et al., 2010, Hassanien et al., 2016; Harjunowibowo et al., 2016; Lund and Boyd, 2016). The integration of thin film solar PV panels into the roof area of glass greenhouses was one of the advances reported by Hassanien et al. (2016). The authors noted that while there was some loss in the availability of solar radiation inside the greenhouse it was more than offset by electrical power generation (Fig. 1.12). The conversion of agricultural land into PV plants can cause friction between farmers and energy producers. By combining PV panels and crops on the same area of land the increasing competition for land between food and energy production can be alleviated.

Harjunowibowo et al. (2016) presented the latest technological developments used in greenhouses to control the microclimate by focusing on passive techniques. For example, heat can be



Figure 1.12. Thin film PV solar glass greenhouse (adapted from Hassanien et al., 2016).

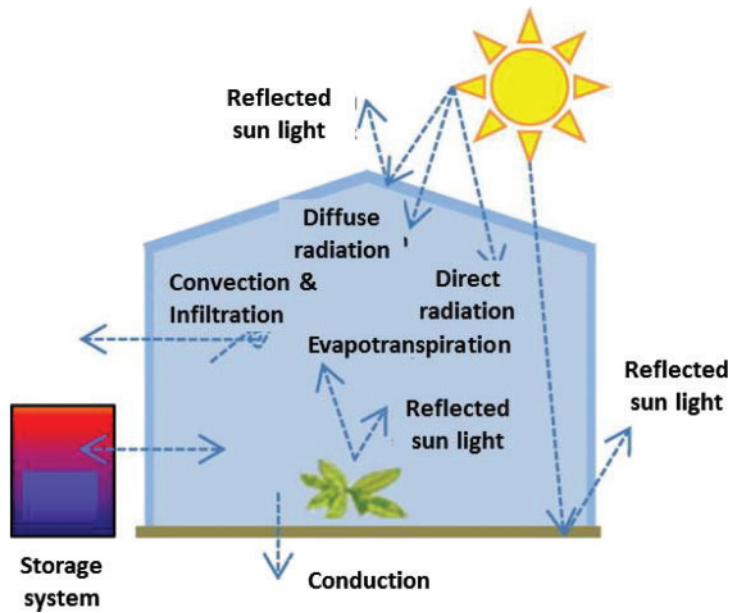

Figure 1.13. Closed greenhouse thermal flow with heat storage system (adapted from Harjunowibowo et al., 2016; Vadiie and Martin 2013).

taken from the greenhouse during the day and deposited in a thermal storage system. This heat is then used at night in accordance with the required heat in the greenhouse (Fig. 1.13). The storage system can use, for instance, water, rocks, phase-change material and soil water collectors. Harjunowibowo et al. (2016) found that heat storage systems containing phase-change materials (PCM) could provide both heating and cooling for closed greenhouses. For greenhouses in northern climates, the authors claimed a reduction in energy demands by 80% with a potential payback of six years. In a related study by Bouadila et al. (2014) the excess heat in the greenhouse was stored in a packed bed through the daytime period and extracted at night. Additionally, Çakır and

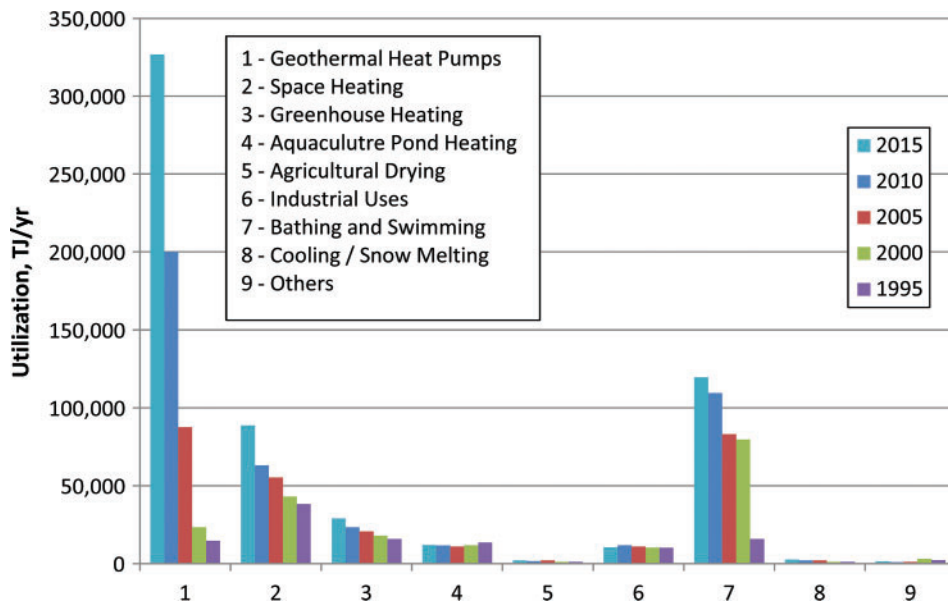

Figure 1.14. Comparison of worldwide direct-use geothermal energy in TJ year⁻¹ from 1995, 2000, 2005, 2010 and 2015 (Lund and Boyd, 2016).

Şahin (2015) assessing solar greenhouses in cold climates, evaluated the optimum type according to sizing, position and location. They concluded that one of the chief operational parameters for solar energy acquisition rates of greenhouses is the roof shape. Elliptic greenhouses were preferred (at least for cold climates).

Global consumption of geothermal energy for greenhouses and covered ground heating has increased by 28% in installed capacity and 25% in annual energy use over the past decade (Lund and Boyd, 2016). As already mentioned, the leading countries in annual energy use being: Turkey, Russia, Hungary, China and The Netherlands. The authors noted that most countries do not distinguish between covered greenhouses versus uncovered ground heating, and only a few reported the actual area heated. The main crops grown in greenhouses were vegetables and flowers. However, tree seedlings (USA) and fruit such as bananas (Iceland) were also grown. Not surprisingly, developed countries experience competition from developing countries due to lower labor costs for the latter. Over a 20-year period, from 1995–2015, greenhouse heating using geothermal energy has seen about a 50% increase (Fig. 1.14).

Improved greenhouse heating by coupling of geothermal heat pumps with solar collectors has been described (Awani et al., 2015; Ghosal and Tiwari, 2004; Kondili and Kaldellis, 2006; Ozgener, 2010). In many cases modeling was employed to try and optimize the performance. Ozgener (2010), for example, reported on the use of solar-assisted geothermal heat pump and small wind turbine systems for heating agricultural and residential buildings. The main objectives of their study were to analyze thermal loads of geothermally and passively heated solar greenhouses and to investigate wind energy utilization in greenhouse heating which was modeled as a hybrid solar-assisted geothermal heat pump, and a small wind turbine system which was separately installed. The main conclusion of the investigation was that a modeled passive solar pre-heating technique, combined with a geothermal heat pump system and a small wind turbine system could be economically superior to conventional space heating/cooling systems used in agricultural and residential building heating applications if these buildings are installed in a region which has a good wind resource. Additionally, Chinese et al. (2005) developed technical and economic optimization models in order to exploit a renewable energy source represented by

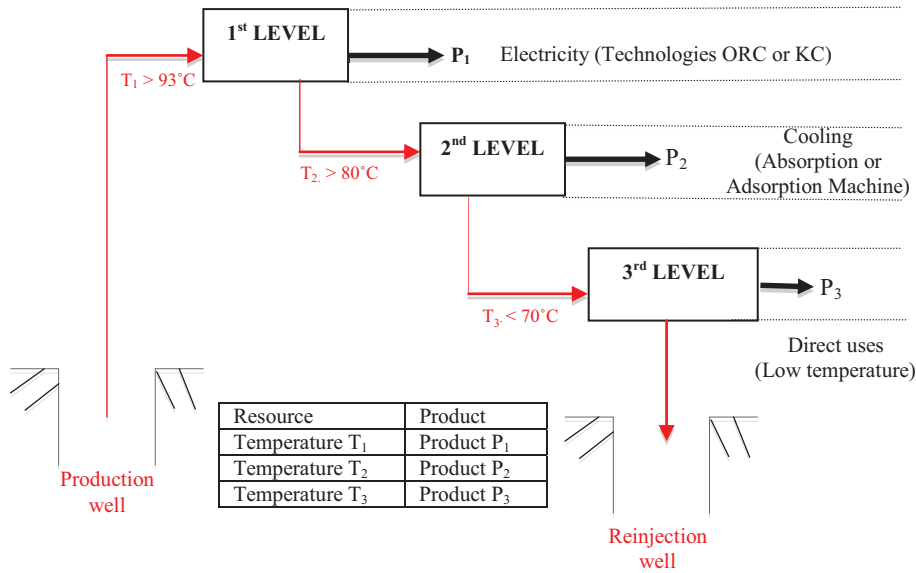

Figure 1.15. Conceptual diagram of the cascade utilization of geothermal energy (Adapted from Rubio-Maya et al., 2015).

waste heat coming from the condenser of a waste-to-energy plant built to convert wood scraps from a chair manufacturing industrial district in North-Eastern Italy. The authors argued that coupling a greenhouse with a waste-to-energy plant could represent an important step towards sustainable development of such industrial structures, since it encourages both business diversification and full exploitation of internal resources.

The concept and application of cascade utilization of low and medium enthalpy geothermal resources have been described previously in Bujakowski (2007). It can be argued that this is a crucial idea that essentially couples different technologies and applications in order to utilize all the available geothermal heat by integrating different technologies for electricity generation, distribution and use of thermal energy, drying and dehydration processes, recreational uses, and any other direct use of geothermal heat (Fig. 1.15). For greenhouse systems geothermal cascade technology can combine electricity production for running pumps and providing lighting, along with direct heating of the greenhouse. Rubio-Maya et al. (2015) presented a comprehensive review of different regions around the world employing geothermal resources of medium and lowenthalpy in a cascade manner. It is possible that the fluid temperature at the outlet of the generation process has sufficient thermodynamic quality and can be useful at a sequential process in a second or third level of temperature. Such processes or direct uses are, for instance: heating systems, hot water supply, intermediate drying processes of food or wood, and other direct uses of geothermal heat for aquaculture and greenhouses.

Figure 1.15 is presented in order to describe better the concept of cascade utilization of geothermal resource. This particular system is a three-level cascade with electricity production and some thermal applications. In this example, the geothermal resource of medium enthalpy is utilized in the first level of the cascade for the production of electricity. Afterwards, the geothermal resource which is derived from this process feeds the second level of the cascade for freezing or cooling purposes using thermally activated technologies, such as absorption or adsorption effect machines. After this second use, the fluid can be employed further for additional purposes with lower temperature requirements to form the third level of the cascade. Such application might be dehydration processes and greenhouses. Rubio-Maya et al. (2015) concluded that the main benefits are an increased profitability of the facility, maximized use of geothermal resources of

Solar, wind and geothermal energy applications in agriculture: back to the future? 23

Table 1.6. Profitability analysis data of various applications of renewable energies in greenhouses in Crete-Greece (Vourdoubas, 2015).

Type of renewable energy	Energy generated	Operating period [years]	Initial investment [€]	Payback period [years]	NPV [€]
Solar PV	Electricity	20	13062	16.98 12.30*	1622 6030*
Solid biomass	Heat	15	14864	2.95	53880
Direct heating with geothermal fluid	Heat	20	12500	1.25	129268
Geothermal heat pumps	Heat (and cooling)	20	122130	—	−19116

Note. *In the case of 30% higher than current electricity prices.

Table 1.7. Environmental benefits due to renewable energy use in greenhouses (Vourdoubas, 2015).

Type of renewable energy used	Energy used initially	Energy generated	Initial CO ₂ emissions [tons year ⁻¹ × 10 ³ m ²]	CO ₂ emissions due to renewables [tons year ⁻¹ × 10 ⁻³ m ²]	Reduction of CO ₂ emissions [tons year ⁻¹ × 10 ⁻³ m ²]
Solar PV	Grid electricity	Electricity	13.85	0	13.85
Solid biomass	Fuel oil	Heat	85.60	0	85.60
Direct heating with geothermal fluid	Fuel oil	Heat	85.60	0	85.60
Geothermal heat pumps	Fuel oil	Heat (and cooling)	85.60	62.17	23.43

medium and low-enthalpy, local development of communities and cities, as well as social and environmental benefits.

Lastly, economic and environmental assessments of solar-geothermal greenhouse systems are critical in their effective development and commercialization (Vourdoubas, 2015; Russo et al., 2014; Ozgener and Hepbasli, 2006). In a case study of Crete-Greece by Vourdoubas (2015), cost analysis of the use of solid biomass and geothermal energy for direct heating and cooling greenhouses showed that these investments are very profitable and attractive (Tables 1.6 and 1.7). However, the author reported that the use of geothermal heat pumps for heating and cooling them was not cost-effective. Furthermore, the use of solar photovoltaic cells for power generation was also not cost-effective, particularly when electricity generation in greenhouses was subsidized by the government. On the positive side the decrease of CO₂ emissions due to the use of renewables in the greenhouses was considered as an additional benefit.

Profitability analysis data of various applications of renewable energies in greenhouses in Crete-Greece by Vourdoubas (2015) are presented in Table 1.6. Direct heating with geothermal fluid was found to be the most profitable. The net present value (NPV) was the highest at €129,268. In finance, the NPV or net present worth (NPW) is a measurement of the profitability of an undertaking that is calculated by subtracting the present value (PV) of cash outflows (including initial cost) from the present values of cash inflows over a period of time. Similarly, the environmental benefits, due to the use of renewable energy sources in agricultural greenhouses are presented in Table 1.7. Use of the renewable energy systems for heat and power generation in greenhouses will result in a reduction of greenhouse gases emitted due to energy use in them. The reductions were estimated by Vourdoubas (2015) as the difference of the emissions due to fossil fuels use

minus the emissions due to renewable energy use. In the case of using PV cells, CO₂ emissions were zero when using direct heating with geothermal fluids and heating with solid biomass. In the case of employing a geothermal heat pump the emissions were estimated from the consumption of grid electricity for the operation of the heat pump.

1.5.7.2 *Closed seawater greenhouses for meeting water, energy and food security*

In contrast to the natural environment where growing conditions may not be optimum for a given crop, glasshouses—when appropriately managed—provide optimal growth conditions and all-year-round operation since parameters such as air temperature, relative humidity, carbon dioxide concentration, soil temperature and soil moisture can be controlled (Cooper and Fuller, 1983). In particular in arid areas, closed seawater greenhouses which use only 10% of the water that open farming requires for obtaining the same yield (Masudi, 2014) provide excellent opportunities to supply food to the domestic market and to produce high-priced export products throughout the year (IRENA, 2015).

If the required solar/geothermal sources are available, it is a feasible solution for providing food, and freshwater to a large part of global inhabitants given the fact that over 70% of the population lives within a distance of less than 70 km (El-Dessouky and Ettouney, 2002), or 80% within 100 km (Ghaffour, 2009) from the seashore.

Due to high freshwater and energy demands, solar or geothermal heat can be employed for heating/cooling/humidification and for freshwater production through desalination of saline or brackish water, as well as producing PV energy for other purposes. A promising example for such a completely solar power operated greenhouse is the Sundrop System, which harnesses solar thermal energy to desalinate seawater to produce fresh water for irrigation (Saumweber, 2013). According to Saumweber (2013), the upfront costs of solar-based greenhouses are lower than the present-value annual cost of fossil fuels for traditional greenhouses in the same location (Saumweber, 2013). In Port Augusta (Australia), a pilot greenhouse was upgraded to a 20-hectare facility with a capacity of producing daily 10,000 L desalinated water, and more than 15,000 t of vegetables per year (WWF and CEEW, 2014).

Using hydroponics that utilize nutrient-laden water, no fertile soil is required and the facilities can also be installed in areas otherwise not suitable for cultivation (e.g. deserts, arctic regions). Since the nutrients can be well-dosed, and subsequently the nutrients not consumed by the crops can be reused, this eliminates the negative impacts on surface water resources such as eutrophication and contamination of land and water resources, which are disadvantages of conventional agriculture. Additionally, both, aeroponic and hydroponic systems (i) require much less space and water than conventional farming methods, and (ii) do not require pesticides to make them a true renewable and sustainable farming system. Finally, by applying vertical farming (Growing Power, 2011) and providing artificial light, space demands can be further reduced thus making them ideal horticulture systems for cities or small islands. The electricity demand of aeroponic and hydroponic cultivations can be provided from renewable energy systems.

1.5.8 *The present market of renewable energy technologies*

Integrating RES in agriculture and the wider agri-food chain is a key goal to assuring food security and protecting the earth's climate. Use of RES for freshwater production is essential since crop irrigation consumes about 70% of all produced freshwater.

Renewable energy technologies, suitable for direct agricultural purposes and within the wider area of the agri-food chain, are mature technologies. Mass production has resulted in massive price drops and it can be expected that prices will further decrease as the technologies are further improved. Solar energy can provide electricity, heat and shaft energy; wind can provide electricity and shaft energy, and geothermal can provide electricity and heat energy (Fig. 1.16). For all of these RES, there exist mature technologies and mature markets.

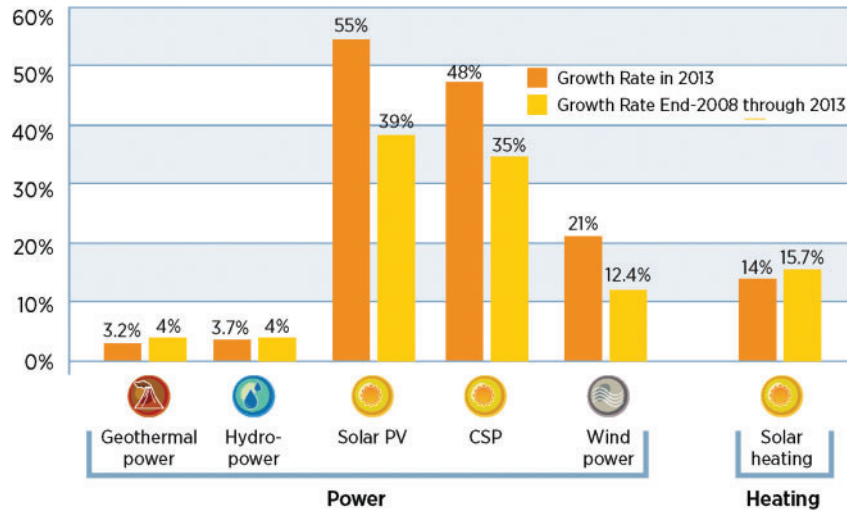

Figure 1.16. Average annual growth of installed geothermal, hydro, wind and solar (thermal and photovoltaic) capacity of the end-users of the power and heating sectors (modified from REN21, 2014).

1.6 CONCLUSIONS

Globally, the agri-food chain in the world today consumes about one-third of the total global energy production, with about 12% for crop production and nearly 80% for post-harvest related activities. Overall, agriculture and agri-food industry is often highly energy-intensive, particularly in developed countries, due to the reliance on fossil fuels that are employed, for example, for running farm equipment, generation of electricity for powering fans and pumps, and for refrigeration of food supplies. Currently, conventional fossil fuel sources, however, are being depleted at a progressively rapid rate not only due to global population growth, but also owing to the growing energy demands in the agri-food production chain in general. The highest share of on-farm energy for instance, is required for irrigation by groundwater pumping. As a solution to this problem, the use of locally available renewable energy sources, together with energy-efficient technologies, has become increasingly attractive for minimizing the impacts of rising energy costs on agri-food profitability and competitiveness as well as contributing to climate protection. Renewable energy includes solar, wind and geothermal sources. These renewable energy sources can be utilized through a number of well-proven established and new technologies, depending on the site-specific conditions and needs. Such technologies can be either integrated into existing agricultural operations or designed in the planning phase of innovative projects.

On a global scale a number of successful examples already exist where solar, wind and geothermal energy sources have been used either directly or indirectly for electricity generation in agriculture. Their economic viability and competitiveness against fossil fuels has been demonstrated. The financial benefits are highest in cases where costly electricity generation by diesel or petrol generators is replaced by renewable energy sources. Furthermore, solar or geothermal direct heat applications can be employed for heating/cooling of spaces, buildings, soil and water; drying of crops and grains; and heating/cooling during food processing; and ventilation and humidification of greenhouses. In addition, multi-use of agricultural land for food and electric power production also constitutes an attractive way for farmers as it could significantly increase their income. Another promising option is a cascade system, where solar-heated water or geothermal water is utilized stepwise for applications requiring temperature gradients. For example, from a space heating system installation the residual water is cascaded to swimming pools, to

greenhouses and/or to aquaculture ponds. This maximizes the use of the hot water resource as well as improving the economics. Finally, the use of solar, geothermal and wind energy for water desalination has also received considerable attention since it decouples freshwater production from the fossil fuel supply and therefore is an attractive alternative to guarantee future irrigation water demands and thus improve food security.

Despite these encouraging examples, it can be argued that further research is required on the impacts of renewable energy sources on the Life Cycle Assessment (LCA) of agricultural products. This is essential in order to profile the economic and environmental performance as well as identify the added improvement opportunities. LCA is a particularly pronounced profiling tool for finding 'hot spots' to prioritize action. The results of such analyses have been used by industry to validate its environmental efforts, allow for informed decisions about product diversification and change, and take advantage of emerging carbon and environmental markets. Finally, LCAs will help to identify suitable pathways, policy frameworks and convince farmers and other stakeholders of the benefits of renewable energy applications in agriculture and the entire agri-food chain. With these advancements, the global agri-food supply chain can be decoupled from its dependency on fossil fuels in order to meet future food demands.

REFERENCES

- Abu-Jabal, M.S., Kamiya, I. & Narasaki, Y. (2001) Proving test for a solar-powered desalination system in Gaza-Palestine. *Desalination*, 137, 1–6.
- Ahmad, G.E. & Schmid, J. (2002) Feasibility study of brackish water desalination in the Egyptian deserts and rural regions using PV systems. *Energy Conversion and Management*, 43, 2641–2649.
- Ali, M.T., Fath, H.E.S. & Armstrong, P.R. (2011) A comprehensive techno-economical review of indirect solar desalination. *Renewable and Sustainable Energy Reviews*, 15, 4187–4199.
- Awani, S., Chargui, R., Kooli, S., Farhat, A. & Guizani, A. (2015) Performance of the coupling of the flat plate collector and a heat pump system associated with a vertical heat exchanger for heating of the two types of greenhouses system. *Energy Conversion and Management*, 103, 266–275.
- Awerbuch, L., Lindemuth, T.E., May, S.C. & Rogers, A.N. (1976) Geothermal energy recovery process. *Desalination*, 19(1), 325–336.
- Baillie, C. (2009) Energy and carbon accounting case study on Keytah. Project report for the Cotton Research and Development Corporation (CRDC). University of Southern Queensland, Toowoomba, QLD, Australia.
- Bellarby, J., Foereid, B., Hastings, A. & Smith, P. (2008) Cool farming: climate impacts of agriculture and mitigation potential. Greenpeace International, Amsterdam, The Netherlands.
- Bendea, C., Antal, C. & Rosca, M. (2015) Geothermal energy in Romania: country update 2010–2014. *Proceedings World Geothermal Congress 2015, 19–25 April 2015, Melbourne, Australia*. Paper 1013.
- Bertani, R. (2015) Geothermal power generation in the world 2010–2014 update report. *Proceedings World Geothermal Congress 2015, 19–25 April 2015, Melbourne, Australia*. Paper 1001.
- Biswas, W.K., Graham, J., Kelly, K. & John, M.B. (2010) Global warming contributions from wheat, sheep meat and wool production in Victoria, Australia – a life cycle assessment. *Journal of Cleaner Production*, 18, 1386–1392.
- Borsani, R. & Rebagliati, S. (2005) Fundamentals and costing of MSF desalination plants and comparison with other technologies. *Desalination*, 182, 29–37.
- Bouadila, S., Lazaar, M., Skouri, S., Kooli, S. & Farhat, A. (2014) Assessment of the greenhouse climate with a new packed-bed solar air heater at night, in Tunisia. *Renewable and Sustainable Energy Reviews*, 35, 31–41.
- Boyd, T.L., Sifford, A. & Lund, J.W. (2015) The United States of America country update 2015. *Proceedings World Geothermal Congress 2015, 19–25 April 2015, Melbourne, Australia*. Paper 1009.
- Bujakowski, W. (2007) Energia geotermalna [Geothermal energy]. In: Sapinska-Śliwa, A. (ed.) *Odnawialne źródła energii w Małopolsce [Renewable Energy Sources in Małopolska]*. Wyd. Stowarzyszenie Gmin Polska Sieć „Energie Cités” [The Association of Municipalities Polish Network „Energy Cities”]. Kraków, Poland.
- Bujakowski, W. & Tomaszewska, B. (2012) Geothermal energy used in Podhale region. *Technologia Wody*, 5(19), 30–36.

Solar, wind and geothermal energy applications in agriculture: back to the future? 27

- Bundschuh, J., Ghaffour, N., Mahmoudi, H., Goosen, M., Mushtaq, S. & Hoinkis, J. (2015) Low-cost low-enthalpy geothermal heat for freshwater production: innovative applications using thermal desalination processes. *Renewable and Sustainable Energy Reviews*, 43, 196–206.
- Çakır, U. & Şahin, E. (2015) Using solar greenhouses in cold climates and evaluating optimum type according to sizing, position and location: a case study. *Computers and Electronics in Agriculture*, 117, 245–257.
- Carey, B., Dunstall, M., McClintock, S., White, B., Bignall, G., Luketina, K., Robson, B., Zarrouk, S. & Seward, A. (2015) 2010–2015 New Zealand Country Update. *Proceedings World Geothermal Congress 2015, 19–25 April 2015, Melbourne, Australia*. Paper 1052.
- Caruso, G. & Naviglio, A. (1999) A desalination plant using solar heat as a heat supply, not affecting the environment with chemicals. *Desalination*, 122, 225–234.
- Casey, A. (2013) Reforming energy subsidies could curb India's water stress. Worldwatch Institute, Washington, DC. Available from: <http://www.worldwatch.org/reforming-energy-subsidies-could-curb-india's-water-stress-0> [accessed October 2016].
- Cassaday, A. (2003) USPIRG renewables.report. U.S. PIRG Education Fund. Available from: https://www.hks.harvard.edu/hepg/Papers/Cassaday_USPIRG_renewables.report_4-03.pdf [accessed October 2016].
- Chen, G. & Baillie, C. (2009a) Agricultural applications: energy uses and audits. In: Capehart, B. (ed.) *Encyclopedia of Energy Engineering and Technology*, 1(1), 1–5. Taylor & Francis Books, London, UK.
- Chen, G. & Baillie, C. (2009b) Development of a framework and tool to assess on-farm energy uses of cotton production. *Energy Conversion and Management*, 50(5), 1256–1263.
- Chen, G., Maraseni, T.N. & Yang, Z. (2010) Life-cycle energy and carbon footprint assessments: agricultural and food products. In: Capehart, B. (ed.) *Encyclopedia of Energy Engineering and Technology*, 1(1), 1–5. Taylor & Francis Books, London, UK.
- Chen, G., Maraseni, T.N., Banhazi, T. & Bundschuh, J. (2015) Benchmarking energy use on farm. Publication No. 15/059, Rural Industries Research and Development Corporation, Canberra, ACT, Australia.
- Chinese, D., Meneghetti, A. & Nardin, G. (2005) Waste-to-energy based greenhouse heating: exploring viability conditions through optimization models. *Renewable Energy*, 30(10), 1573–1586.
- Cooper, P.I. & Fuller, R.J. (1983) A transient model of the interaction between crop, environment and greenhouse structure for predicting crop yield and energy consumption. *Journal of Agricultural Research*, 28, 401–417.
- Davies, P.A. & Orfi, J. (2014) Self-powered desalination of geothermal saline groundwater: technical feasibility. *Water*, 6(11), 3409–3432.
- Delgado-Torres, A.M. & García-Rodríguez, L. (2007) Status of solar thermal-driven reverse osmosis desalination. *Desalination*, 216, 242–251.
- Delyannis, E.E. (1987) Status of solar-assisted desalination: a review. *Desalination*, 67, 3–19.
- El-Dessouky, H.T. & Ettouney, H.M. (2002) *Fundamentals of Salt Water Desalination*. Elsevier Science, Amsterdam, The Netherlands and New York, NY.
- El-Nashar, A.M. (1985) Abu Dhabi solar distillation plant. *Desalination*, 52, 217–234.
- FAO (2011a) Energy-smart food for people and climate. Issue paper, Food and Agriculture Organization of the United Nations, Rome, Italy. Available from: <http://www.fao.org/docrep/014/i2454e/i2454e00.pdf> [accessed October 2016].
- FAO (2011b) The state of the world's land and water resources for food and agriculture (SOLAW) – managing systems at risk. Food and Agriculture Organization of the United Nations, Rome, Italy and Earthscan, London, UK.
- FAO (2013) Global forest resources assessment: forests future. Food and Agriculture Organization of the United Nations, Rome, Italy. Available from: <http://www.fao.org/forestry/fra/85504/en/> [accessed October 2016].
- FAO (2014) Walking the nexus talk: assessing the water-energy-food nexus in the context of the Sustainable Energy for All Initiative. Food and Agriculture Organization of the United Nations, Rome, Italy. Available from: <http://www.fao.org/3/a-i3959e.pdf> [accessed October 2016].
- FAO (2016) World food situation. FAO cereal supply and demand brief. New season production prospects improve, stocks to remain high. Food and Agriculture Organization of the United Nations, Rome, Italy. Available from: <http://www.fao.org/worldfoodsituation/csdb/en/> [accessed October 2016].
- Fronza, A.D., Marasigan, M.C. & Lazaro, V.S. (2015) Geothermal development in the Philippines: the country update. *Proceedings World Geothermal Congress 2015, 19–25 April 2015, Melbourne, Australia*. Paper 1053.

- Gallup, D.L. (2007) Treatment of geothermal waters for production of industrial, agricultural or drinking water. *Geothermics*, 36, 473–483.
- Ghaffour, N. (2009) The challenge of capacity building strategies and perspectives for desalination for sustainable water use in MENA. *Desalination & Water Treatment*, 5, 48–53.
- Ghaffour, N., Missimer, T.M. & Amy, G.L. (2013) Technical review and evaluation of the economics of water desalination: current and future challenges for better water supply sustainability. *Desalination*, 309, 197–207.
- Ghaffour, N., Lattemann, S., Missimer, T.M., Ng, K.C., Sinha, S. & Amy, G. (2014) Renewable energy-driven innovative energy-efficient desalination technologies. *Applied Energy*, 136, 1155–1165.
- Ghaffour, N., Bundschuh, J., Mahmoudi, H. & Goosen, M.F.A. (2015) Renewable energy-driven desalination technologies: a comprehensive review on challenges and potential applications of integrated systems. *Desalination*, 356, 94–114.
- Ghosal, M.K. & Tiwari, G.N. (2004) Mathematical modeling for greenhouse heating by using thermal curtain and geothermal energy. *Solar Energy*, 76(5), 603–613.
- GIZ (2013) Solar water pumping for irrigation: potential and barriers in Bihar, India. Deutsche Gesellschaft für Internationale Zusammenarbeit (GIZ) GmbH, Indo-German Energy Programme (IGEN), New Delhi, India, In cooperation with the Ministry of New and Renewable Energy (MNRE), New Delhi, India. Available from: http://www.igen-re.in/files/giz_2013_factsheet_solar_water_pumping_for_irrigation_in_bihar.pdf [accessed October 2016].
- Goosen, M., Mahmoudi, H. & Ghaffour, N. (2010) Water desalination using geothermal energy. *Energies*, 3, 1423–1442.
- Goosen, M.F., Mahmoudi, H. & Ghaffour, N. (2014) Today's and future challenges in applications of renewable energy technologies for desalination. *Critical Reviews in Environmental Science and Technology*, 44(9), 929–999.
- Graham, P.W. & Williams, D.J. (2003) Optimal technological choices in meeting Australian energy policy goals. *Energy Economics*, 25(6), 691–712.
- Growing Power (2011) Growing power vertical farm. Available from: <http://www.tkwa.com/growing-power-vertical-farm/> [accessed August 2016].
- Gude, V.G. (2016) Geothermal source potential for water desalination – current status and future perspective. *Renewable and Sustainable Energy Reviews*, 57, 1038–1065.
- Gutiérrez-Negrin, L., Maya-González, R. & Quijano-León, J.L. (2015) Present situation and perspectives of geothermal in Mexico. *Proceedings World Geothermal Congress 2015, 19–25 April 2015, Melbourne, Australia*. Paper 1002.
- Haddeland, I., Heinke, J., Biemans, H., Eisner, S., Flörke, M., Hanasaki, N., Konzmann, M., Ludwig, F., Masaki, Y., Schewe, J., Stacke, T., Tessler, Z.D., Wada, Y. & Wisser, D. (2014) Global water resources affected by human interventions and climate change. *PNAS*, 111(9), 3251–3256.
- Hanafı, A. (1991) Design and performance of solar MSF desalination system. *Desalination*, 82, 165–174.
- Harjunowibowo, D., Erdem, C.U.C.E., Omer, S. & Riffat, S.B. (2016) Recent passive technologies of greenhouse systems: a review. *Proceedings of the fifteenth International Conference on Sustainable Energy Technologies*. pp. 19–22.
- Hassanien, R.H.E., Li, M. & Lin, W.D. (2016) Advanced applications of solar energy in agricultural greenhouses. *Renewable and Sustainable Energy Reviews*, 54, 989–1001.
- Herdon, A. (2013) Energy makes up half of desalination plant costs. Bloomberg. Available from: <http://www.bloomberg.com/news/articles/2013-05-01/energy-makes-up-half-of-desalination-plant-costs-study> [accessed December 2016].
- Hoff, H. (2011) Understanding the nexus. Stockholm Environment Institute (SEI), Stockholm, Sweden. Available from: http://www.water-energy-food.org/documents/understanding_the_nexus.pdf [accessed August 2016].
- IEA (2012) World Energy Outlook 2012. International Energy Agency, Paris, France. Available from: <http://www.worldenergyoutlook.org/publications/weo-2012/> [accessed August 2016].
- IEA (2014) Heating without global warming. International Energy Agency, Paris, France. Available from: http://www.iea.org/publications/freepublications/publication/FeaturedInsight_HeatingWithoutGlobalWarming_FINAL.pdf [accessed August 2016].
- IFC (2014) Scaling up opportunities for solar-powered irrigation pumps. World Water Week, Stockholm, Sweden. International Finance Corporation. Available from: http://programme.worldwaterweek.org/sites/default/files/colback_stockholm_presentation.pdf [accessed August 2016].

- IPCC (2007) Climate change 2007: the physical science basis. Contribution of Working Group I to the Fourth Assessment Report of the Intergovernmental Panel on Climate Change. Cambridge University Press, Cambridge, UK and New York, NY.
- IPCC (2011) Renewable energy sources and climate change mitigation: summary for policy makers and technical summary. Intergovernmental Panel on Climate Change. Cambridge University Press, Cambridge, UK and New York, NY. Available from: www.ipcc.ch/pdf/special-reports/srren/SRREN_FD_SPM_final.pdf [accessed October 2016].
- IPCC (2014) Technical summary of climate change 2014: mitigation of climate change, Working Group III Contribution to the IPCC Fifth Assessment Report (AR5). Intergovernmental Panel on Climate Change, Cambridge University Press, Cambridge, UK and New York, NY.
- IRENA (2012) Key findings and recommendations. *International Off-grid Renewable Energy Conference 2012, 1–2 November 2012, Accra, Ghana*. International Renewable Energy Agency, Masdar City, UAE. Available from: http://www.irena.org/DocumentDownloads/Publications/IOREC_Key%20Findings%20and%20Recommendations.pdf [accessed August 2016].
- IRENA (2015) Renewable energy in the water, energy & food nexus. International Renewable Energy Agency, Masdar City, UAE.
- IRENA and IEA-ETSAP (2012) Water desalination using renewable energy: technology brief. Available from: www.irena.org/DocumentDownloads/Publications/IRENA-ETSAP%20Tech%20Brief%20I12%20Water-Desalination.pdf [accessed October 2016].
- Jackson, T.M., Khan, S. & Hafeez, M. (2010) A comparative analysis of water application and energy consumption at the irrigated field level. *Agricultural Water Management*, 97, 1477–1485.
- Johnson, J.A., Runge, C.F., Senauer, B., Forley, J. & Polasky, S. (2014) Global agriculture and carbon trade-offs. *PNAS*, 111(34), 12,342–12,347.
- Kabay, N., Yilmaz, I., Yamac, S., Samatya, S., Yuksel, M., Yuksel, U., Arda, M., Sađlam, M., Iwanaga, T. & Hirowatari, K. (2004a) Removal and recovery of boron from geothermal wastewater by selective ion exchange resins. I. Laboratory tests. *Reactive and Functional Polymers*, 60, 163–170.
- Kabay, N., Yilmaz, I., Yamac, S., Samatya, S., Yuksel, M., Yuksel, U., Arda, M., Sađlam, M., Iwanaga, T. & Hirowatari, K. (2004b) Removal and recovery of boron from geothermal wastewater by selective ion-exchange resins. II. Field tests. *Desalination*, 167, 427–438.
- Kabay, N., Yilmaz-Ipek, I., Soroko, I., Makowski, M., Kirmizisakal, O., Yag, S., Bryjak, M. & Yuksel, M. (2009) Removal of boron from Balcova geothermal water by ion exchange-microfiltration hybrid process. *Desalination*, 241, 167–173.
- Kabay, N., Köseođlu, P., Yavuz, E., Yuksel, U. & Yuksel, M. (2013) An innovative integrated system for boron removal from geothermal water using RO process and ion exchange-ultrafiltration hybrid method. *Desalination*, 316, 1–7.
- Karytsas, C. (1996) Low-enthalpy geothermal energy-driven sea-water desalination plant on Milos island – a case study. *Proceedings of Mediterranean Conference on Renewable Energy Sources for Water Production, 10–12 June 1996, Santorini, Greece*. pp. 128–131.
- Kim, Y.D., Thu, K., Ghaffour, N. & Ng, K.C. (2013) Performance investigation of solar-assisted hollow fiber DCMD desalination system. *Journal of Membrane Science*, 427, 345–364.
- Klöpffer, W. (2012) The critical review of life cycle assessment studies according to ISO 14040, and 14044. *International Journal of Life Cycle Assessment*, 17(9), 1087–1093.
- Kondili, E. & Kaldellis, J.K. (2006) Optimal design of geothermal-solar greenhouses for the minimisation of fossil fuel consumption. *Applied Thermal Engineering*, 26(8), 905–915.
- Koschikowski, J. (2011) Water desalination: when and where will it make sense. Presentation at the 2011 Annual Meeting of the American Association for the Advancement of Science, Fraunhofer ISE (Institute for Solar Energy Systems), Freiburg, Germany.
- Koseoglu, H., Harman, B.I., Yigit, N.O., Guler, E., Kabay, N. & Kitis, M. (2010) The effects of operating conditions on boron removal from geothermal waters by membrane processes. *Desalination*, 258, 72–78.
- Kulak, M., Graves, A. & Chatterton, J. (2013) Reducing greenhouse gas emissions with urban agriculture: a life cycle assessment perspective. *Landscape and Urban Planning*, 111, 68–78.
- Kyritsis, S. (1996) *Proceedings of the Mediterranean Conference on Renewable Energy Sources for Water Production, European Commission, EURORED Network, CRES, EDS, 10–12 June 1996, Santorini, Greece*. pp. 265–270.
- Lorentz GmbH (2013) Solar water pumping for irrigation in Oujda, Morocco. Bernt Lorentz GmbH & Co. KG, Henstedt-Ulzburg, Germany. Available from: http://www.lorentz.de/pdf/lorentz_casestudy_irrigation_morocco_en-en.pdf [accessed August 2016].

- Lu, H., Walton, J.C. & Swift, A.H.P. (2010) Zero discharge desalination.. *International Desalination and Water Reuse Quarterly*, 3, 35–43.
- Lund, J.W. (2010) Direct utilization of geothermal energy. *Energies*, 3(8), 1443–1471.
- Lund, J.W. & Boyd, T.L. (2015) Direct utilization of geothermal energy 2015: worldwide review. *Proceedings World Geothermal Congress 2015, 19–25 April 2015, Melbourne, Australia*. Paper 1000.
- Lund, J.W. & Boyd, T.L. (2016) Direct utilization of geothermal energy 2015 worldwide review. *Geothermics*, 60, 66–93.
- Madani, A.A. (1990) Economics of desalination systems. *Desalination*, 78, 187–200.
- Mahmoudi, H., Spahis, N., Goosen, M.F., Ghaffour, N., Drouiche, N. & Ouagued, A. (2010) Application of geothermal energy for heating and fresh water production in a brackish water greenhouse desalination unit: a case study from Algeria. *Renewable and Sustainable Energy Reviews*, 14(1), 512–517.
- Manjares, R. & Galvan, M. (1979) Solarmultistage flash evaporation (SMSF) as a solar energy application on desalination processes, description of one demonstration project. *Desalination*, 31, 545–554.
- Maraseni, T.N. (2007) *Re-Evaluating Land Use Choices to incorporate Carbon Values: a Case Study in the South Burnett Region of Queensland*. PhD Thesis, University of Southern Queensland, Toowoomba, QLD, Australia.
- Maraseni, T.N. & Cockfield, G. (2011a) Crops, cows or timber? Including carbon values in land use choices. *Agriculture Ecosystems & Environment*, 140, 280–288.
- Maraseni, T.N. & Cockfield, G. (2011b) Does the adoption of zero tillage reduce greenhouse gas emissions? An assessment for the grains industry in Australia. *Agricultural Systems*, 104, 451–458.
- Maraseni, T.N. & Cockfield, G. (2012) Including the costs of water and greenhouse gas emissions in a reassessment of the profitability of irrigation. *Agricultural Water Management*, 103, 25–32.
- Maraseni, T.N., Mushtaq, S. & Reardon-Smith, K. (2012a) Integrated analysis for a carbon- and water-constrained future: an assessment of drip irrigation in a lettuce production system in eastern Australia. *Journal of Environmental Management*, 111, 220–226.
- Maraseni, T.N., Mushtaq, S. & Reardon-Smith, K. (2012b) Climate change, water security and the need for integrated policy development: the case of on-farm infrastructure investment in the Australian irrigation sector. *Environmental Research Letters*, 7, 1–12.
- Maraseni, T.N., Chen, G., Banhazi, T., Bundschuh, J. & Yusaf, T. (2015) An assessment of direct on-farm energy use for high value grain crops grown under different farming practices in Australia. *Energies*, 8, 13,033–13,046.
- Masudi, F. (2014) Greenhouses key to water and food security in UAE, expert says. Gulf News, <http://gulfnews.com/news/uae/environment/greenhouses-key-to-water-and-food-security-in-uae-expert-says-1.1349562> [accessed October 2016].
- Mertoglu, O., Simsek, S. & Basarir, N. (2015) Geothermal country update report of Turkey (2010–2015). *Proceedings World Geothermal Congress 2015, 19–25 April 2015, Melbourne, Australia*. Paper No 1046.
- Montalvo, F. & Gutierrez, H. (2015) El Salvador country update. *Proceedings World Geothermal Congress 2015, 19–25 April 2015, Melbourne, Australia*. Paper 108.
- Mushtaq, S., Maraseni, T.N. & Reardon-Smith, K. (2013) Climate change and water security: estimating the greenhouse gas costs of achieving water security through investments in modern irrigation technology. *Agricultural Systems*, 117, 78–89.
- Ng, K.C., Thu, K., Kim, Y.D., Chakraborty, A. & Amy, G. (2013) Adsorption desalination: an emerging low-cost thermal desalination method. *Desalination*, 308, 161–179.
- NYSERDA (2005) Guide to solar-powered water pumping systems in New York State. New York State Energy Research and Development Authority (NYSERDA), Albany, NY. Available from: http://water.epa.gov/infrastructure/sustain/upload/2005_1_27_publications_solarpumpingguide.pdf [accessed August 2016].
- Oudech, S. & Djokic, I. (2015) Geothermal energy use, country update for Serbia. *Proceedings World Geothermal Congress 2015, 19–25 April 2015, Melbourne, Australia*. Paper 1041.
- Ozgener, O. (2010) Use of solar assisted geothermal heat pump and small wind turbine systems for heating agricultural and residential buildings. *Energy*, 35(1), 262–268.
- Ozgener, O. & Hepbasli, A. (2006) An economical analysis on a solar greenhouse integrated solar assisted geothermal heat pump system. *Journal of Energy Resources Technology*, 128(1), 28–34.
- Palma, F. (1991) Seminar on new technologies for the use of renewable energies in water desalination. 26–28 September, Athens, Greece. Commission of the European Communities, DG XVII for Energy, Centre for Renewable Energy Sources (CRES).

- Papapetrou, M., Wieghaus, M. & Biercamp, Ch. (eds.) (2010) Roadmap for development of desalination powered by renewable energy, promotion of renewable energy for water production through desalination. Fraunhofer Verlag, Stuttgart, Germany. Available from: http://www.prodes-project.org/fileadmin/Files/ProDes_Road_map_on_line_version.pdf [accessed August 2016].
- Pellizzi, G., Cavalchini, A.G. & Lazzari, M. (1988) *Energy Savings in Agricultural Machinery and Mechanization*. Elsevier Science Publishing Co. New York, NY.
- Ragnarsson, A. (2015) Geothermal development in Iceland 2010–2014. *Proceedings World Geothermal Congress 2015, 19–25 April 2015, Melbourne, Australia*. Paper 1077.
- REN21 (2013) Renewables 2013: Global status report. Renewable Energy Policy Network for 21st Century, Paris, France. Available from: www.ren21.net/Portals/0/documents/Resources/GSR/2013/GSR2013_lowres.pdf [accessed August 2016].
- REN21 (2014) Renewables 2014: Global status report. Renewable Energy Policy Network for 21st Century, Paris, France. Available from: www.ren21.net/Portals/0/documents/Resources/GSR/2014/GSR2014_full%20report_low%20res.pdf [accessed October 2016].
- Roy, P., Nei, R., Orikasa, T., Xu, Q., Okadome, H., Nakamura, N. & Shiina, T. (2009) A review of life cycle assessment (LCA) on some food products. *Journal of Food Engineering*, 90, 1–10.
- Rubio-Maya, C., Díaz, V.A., Martínez, E.P. & Belman-Flores, J.M. (2015) Cascade utilization of low and medium enthalpy geothermal resources – a review. *Renewable and Sustainable Energy Reviews*, 52, 689–716.
- Russo, G., Anifantisi, A.S., Verdiani, G. & Mugnozza, G.S. (2014) Environmental analysis of geothermal heat pump and LPG greenhouse heating systems. *Biosystems Engineering*, 127, 11–23.
- Saffarini, R.B., Summers, E.K., Arafat, H.A. & Lienhard, J.H. (2012) Technical evaluation of stand-alone solar powered membrane distillation systems. *Desalination*, 286, 332–341.
- Safi, M.J. (1998) Performance of a flash desalination unit intended to be coupled to a solar pond. *Renewable Energy*, 14, 339–343.
- Saumweber, P. (2013) Farming sustainability Part III: Sundrop farms – growing with seawater and sunlight. Available from: <http://www.futuredirections.org.au/publications/food-and-water-crises/1337-sundrop-farmsgrowing-with-seawater-and-sunlight-2.html> [accessed October 2016].
- Sephton Water Technology (2012) VTE geothermal desalination pilot/demonstration project. Project summary. Kensington, CA. Available from: http://sephtonwatertech.com/DocumentsPDF/VTE_Geothermal_Desalination_Project_Summary_2012_02_05.pdf [accessed August 2016].
- Smith, P., Martino, D., Cai, Z., Gwary, D., Janzen, H., Kumar, P., McCarl, B., Ogle, S., Mara, F., Rice, C., Scholes, B., Sirotenko, O., Howden, M., McAllister, T., Pan, G., Romanenkov, V., Schneider, U. & Towprayoon, S. (2007) Policy and technological constraints to implementation of greenhouse gas mitigation options in agriculture. *Agriculture Ecosystems & Environment*, 118, 6–28.
- Szacsvay, T., Hofer-Noser, P. & Posnansky, M. (1999) Technical and economic aspects of small-scale solar-pond-powered seawater desalination systems. *Desalination*, 122, 185–193.
- Tomaszewska, B. & Bodzek, M. (2013a) Desalination of geothermal waters using a hybrid UF-RO process. I. Boron removal in pilot-scale tests. *Desalination*, 319, 99–106.
- Tomaszewska, B. & Bodzek, M. (2013b) The removal of radionuclides during desalination of geothermal waters containing boron using the BWRO system. *Desalination*, 309, 284–290.
- Tomaszewska, B. & Szczepański, A. (2014) Possibilities for the efficient utilisation of spent geothermal waters. *Environmental Science and Pollution Research*, 21, 11,409–11,417.
- Tomaszewska, B., Pająk, L. & Bodzek, M. (2014) Application of a hybrid UF-RO process to geothermal water desalination. Concentrate disposal and costs analysis. *Archives of Environmental Protection*, 40(3), 137–151.
- Tomaszewska, B., Rajca, M., Kmiecik, E., Bodzek, M., Bujakowski, W., Wator, K. & Tyszer, M. (2016) The influence of selected factors on the effectiveness of pre-treatment of geothermal water during the nanofiltration process. *Desalination*, 406, 74–82.
- Topak, R., Suheri, M. & Calisir, S. (2005) Investigation of the energy efficiency for raising crops under sprinkler irrigation in a semi-arid area. *Applied Engineering in Agriculture*, 21(5), 761–767.
- Trieb, F., Moser, M. & Fichter, T. (2011) MENA Regional Water Outlook – desalination using renewable energy. Overview of DLR work within the MENA Regional Water Outlook study. Workshop, 22–23 February 2011, Muscat. German Aerospace Center (DLR), Köln, Germany. Available from: http://elib.dlr.de/72591/1/Workshop_Oman_Final_DLR.pdf [accessed October 2016].
- Tubiello, F.N., Córdor-Golec, R.D., Salvatore, M., Piersante, A., Federici, S., Ferrara, A., Rossi, S., Flammini, A., Cardenas, C., Biancalani, R., Jacobs, H., Prasula, P. & Prospero, P. (2015) Estimating greenhouse gas

- emissions in agriculture: a manual to address data requirements for developing countries. Food and Agriculture Organization of the United Nations, Rome, Italy.
- Tzen, E. (2012) Wind energy powered technologies for freshwater production: fundamentals and case studies. In: Bundschuh, J. & Hoinkis, J. (eds.) *Renewable Energy Applications for Freshwater Production*. CRC Press, Boca Raton and IWA, London, UK. pp. 161–180.
- UN Water (2014) Statistics detail. Available from: <http://www.unwater.org/statistics/statistics-detail/pt/c/211827/> [accessed October 2016].
- USEPA (2006) Global anthropogenic non-CO₂ greenhouse gas emissions: 1990–2020. EPA 430-R-06-003, United States Environmental Protection Agency, Washington, DC.
- Vadiee, A. & Martin, V. (2013) Energy analysis and thermoeconomic assessment of the closed greenhouse – the largest commercial solar building. *Applied Energy*, 102, 1256–1266.
- Valverde Muela, V. (1982) Planta desaladora con energía solar de Arinaga (Las Palmas de Gran Canaria) [The solar desalination plant of Arinaga (Las Palmas, Gran Canaria)]. Departamento de Investigación y Nuevas Fuentes, Centro de Estudios de la Energía, Las Palmas de Gran Canaria, Spain.
- Varadi, P.F. (2014) *Sun above the Horizon: Meteoric Rise of the Solar Industry*. Pan Stanford Series on Renewable Energy, Pan Stanford, Singapore.
- Vermuelen, S.J., Campbell, B.M. & Ingram, J.S.I. (2012) Climate change and food systems. *Annual Review of Environment and Resources*, 37, 195–222.
- Vourdoubas, J. (2015) Economic and environmental assessment of the use of renewable energies in greenhouses: a case study in Crete-Greece. *Journal of Agricultural Science*, 7(10), 48–57.
- Ward, F.A., Booker, J.F. & Michelsen, A.M. (2006) Integrated economic, hydrologic, and institutional analysis of policy responses to mitigate drought impacts in the Rio Grande Basin. *Journal of Water Resources and Planning and Management* – ASCE, 132, 488–502.
- WWF and CEEW (2014) Renewables beyond electricity: solar air conditioning and desalination in India. Available from: http://awsassets.wwfindia.org/downloads/solar_air_conditioning_desalination_in_india.pdf [accessed October 2016].
- Zaragoza, G., Ruiz-Aguirre, A. & Guillén-Burrieza, E. (2014) Efficiency in the use of solar thermal energy of small membrane desalination systems for decentralized water production. *Applied Energy*, 130, 491–499.
- Zarza Moya, E. (1991) Solar thermal desalination project: first phase and results and second phase description. Secretaría General Técnica del CIEMAT, Madrid, Spain.