

CFD Analysis in Advance of the NASA Juncture Flow Experiment



June 8, 2017

Henry Lee
Science and Technology Corp.
Thomas Pulliam
NASA Ames Research Center

Dan Neuhart
Mike Kegerise
NASA Langley Research Center

Outline



- Experiment Motivation, Goals, Model Design
- Wing Candidates
- Risk reduction experiments
 - NASA Ames Test Cell 2 (TC2) 32"x48" 3% semispan
 - Virginia Tech Stability Tunnel 6' 2.5% fullspan
 - NASA Langley 14- by 22-Foot Subsonic Tunnel (14x22) 6% fullspan
- Results from 14x22 6% risk reduction
 - CFD Free Air
 - CFD with 14x22 WT walls
 - Risk Reduction Experiment: oil flow
- Observations and Upcoming Experiment

Juncture Flow

Sponsored by NASA's Transformative Aeronautics Concepts Program's Transformational Tools and Technologies (T³) project

- Substantial effort to investigate the origin of separation bubbles found in wing-body juncture zones
- Primary goal is to gather validation level data, for future CFD code & turbulence model development
- Multi-year effort including several large-scale wind tunnel tests
- Computational Fluid Dynamics (CFD) used in both design and support of risk reduction experiment

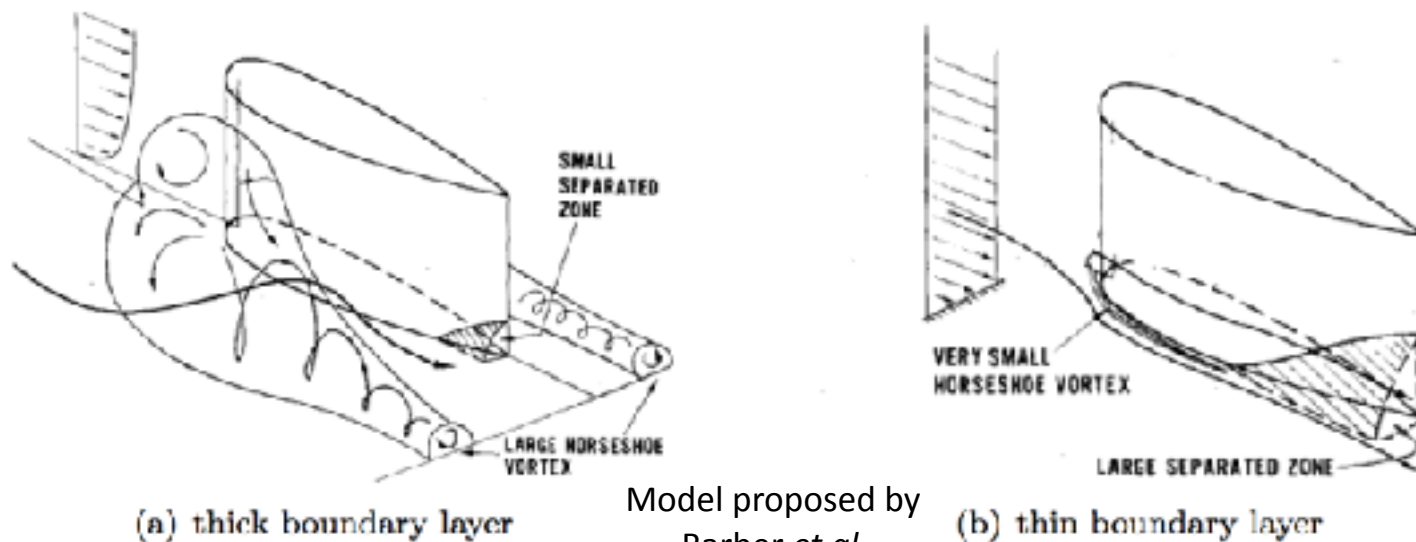

Juncture Flow Experiment



- Design Goals
 - Observe onset and growth of side of body separation
 - Separation: None → small separation → large separation
 - Collect validation quality data: improve turbulence models, etc
- LDV system placed inside fuselage: closer measurements
- Planar fuselage side wall
- 8% model (~16 ft long, 11 ft wide), based on CRM full scale

Juncture Flow Model Design



- Preliminary model design done with CFD
 - Overflow 2.2L: SARC-QCR2000
 - FUN3D: SARC-QCR2000
- Evaluated 20+ wing candidates
- Committee down-selected the wing candidates
- Selected 6 wing candidates that combined satisfied the goals
- Risk reduction experiment tests proposed: further evaluate 6 wing candidates

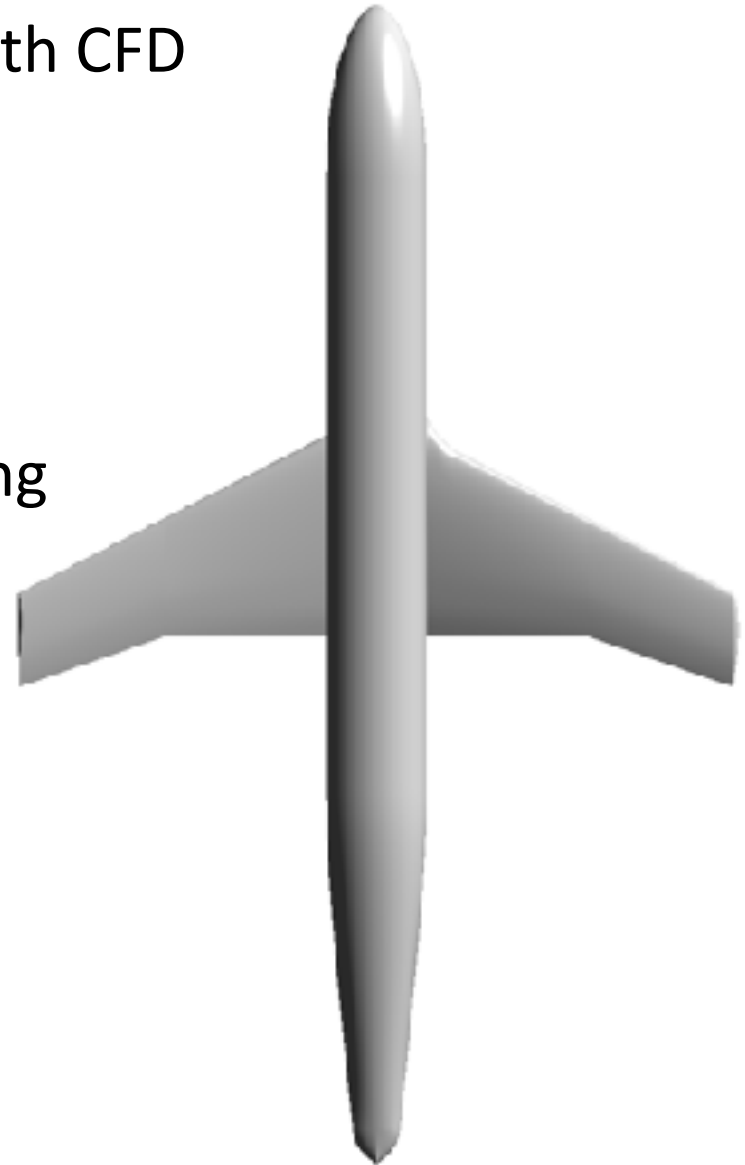

Wing Candidates



6 Wing candidates

- DLR-F6 no horn
 - Used in DPW3
 - Showed side of body separation
- DLR-F6: with LE horn
- NACA 0015 with horn: symmetric wing
- NACA 0015mod: slightly steeper pressure recovery
- F6S12: symmetric F6 variant
- COCA
 - Coder-Campbell design
 - CDISC/skin-friction constraints

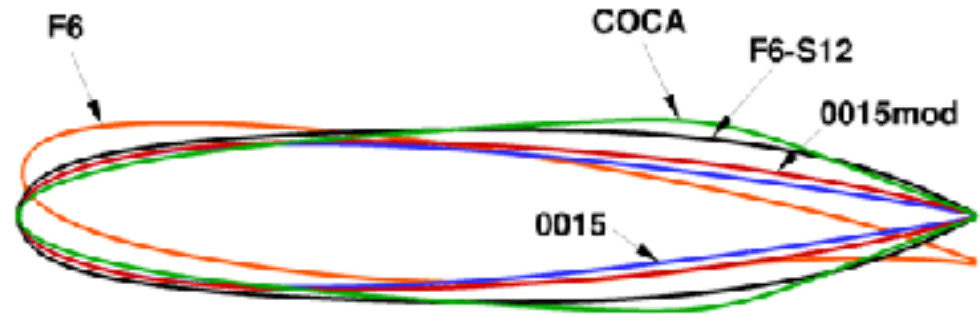

DLR-F6

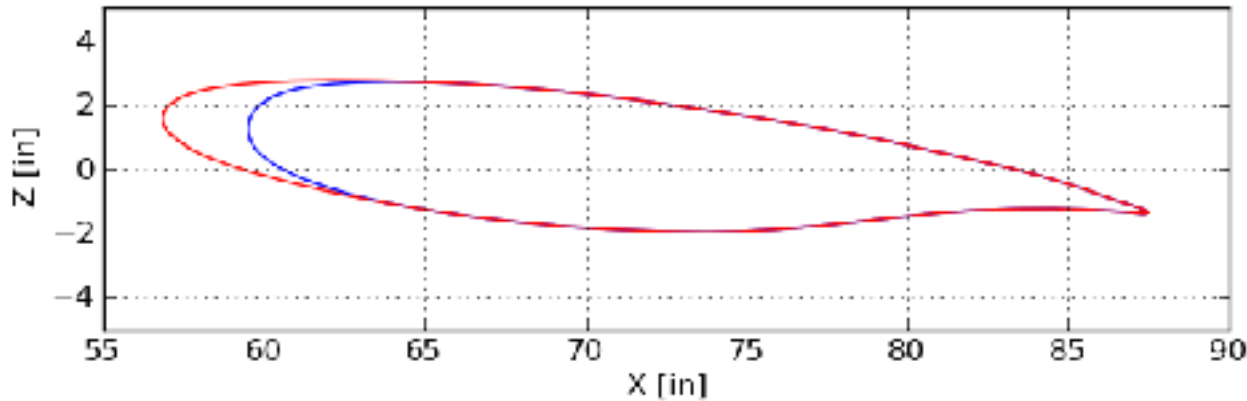

Blue: F6 without horn, Red: F6 with horn

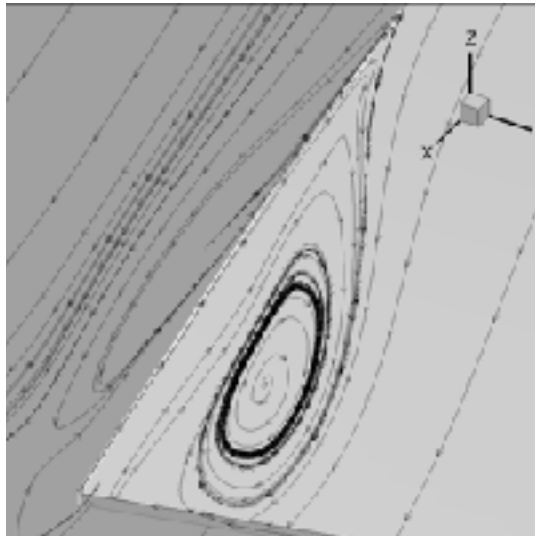

Side of Body Separation

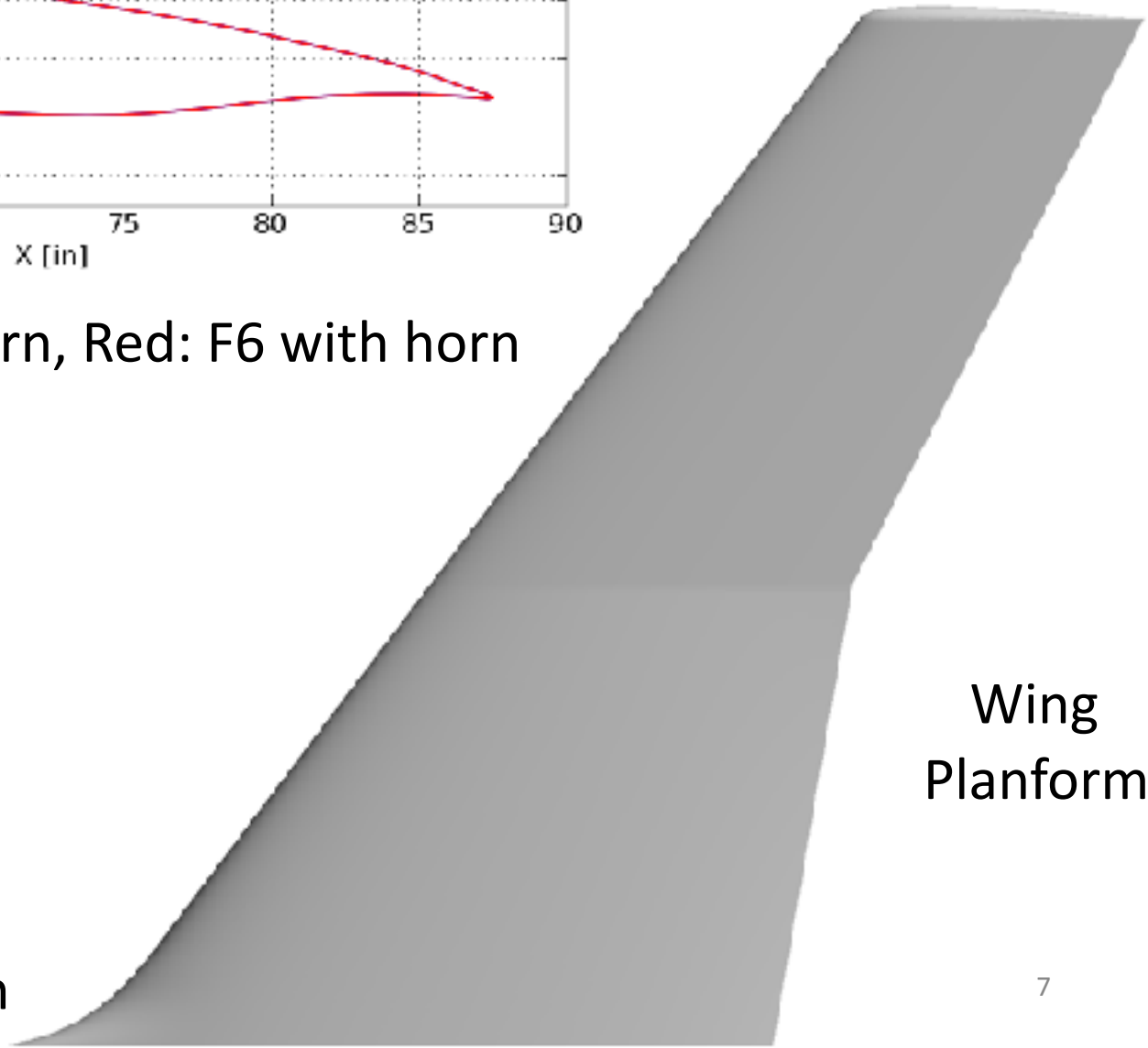

Wing
Platform



NACA 0015 — NACA 0015mod

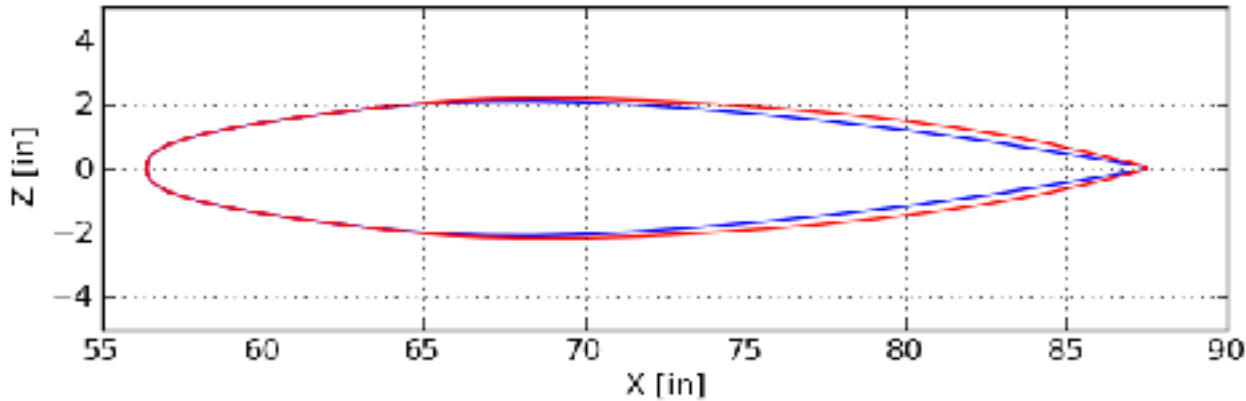

Blue: NACA 0015 w/horn,
Red: NACA 0015mod with horn

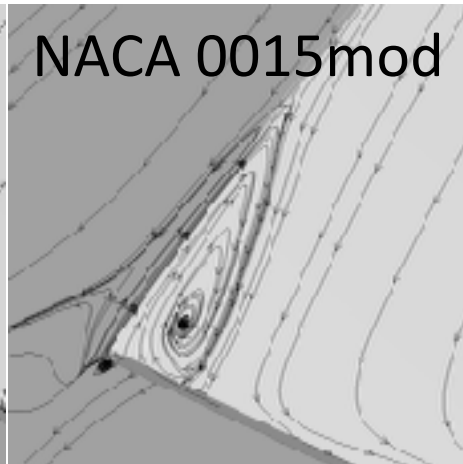
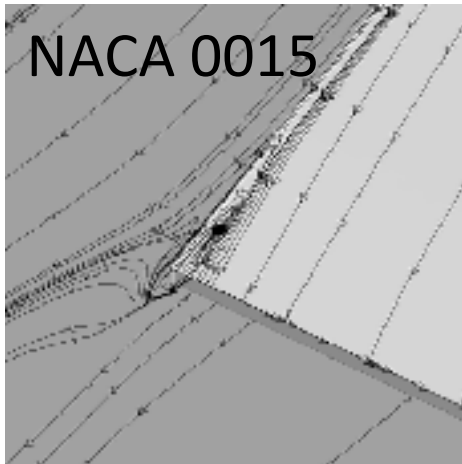

Side of Body Separation

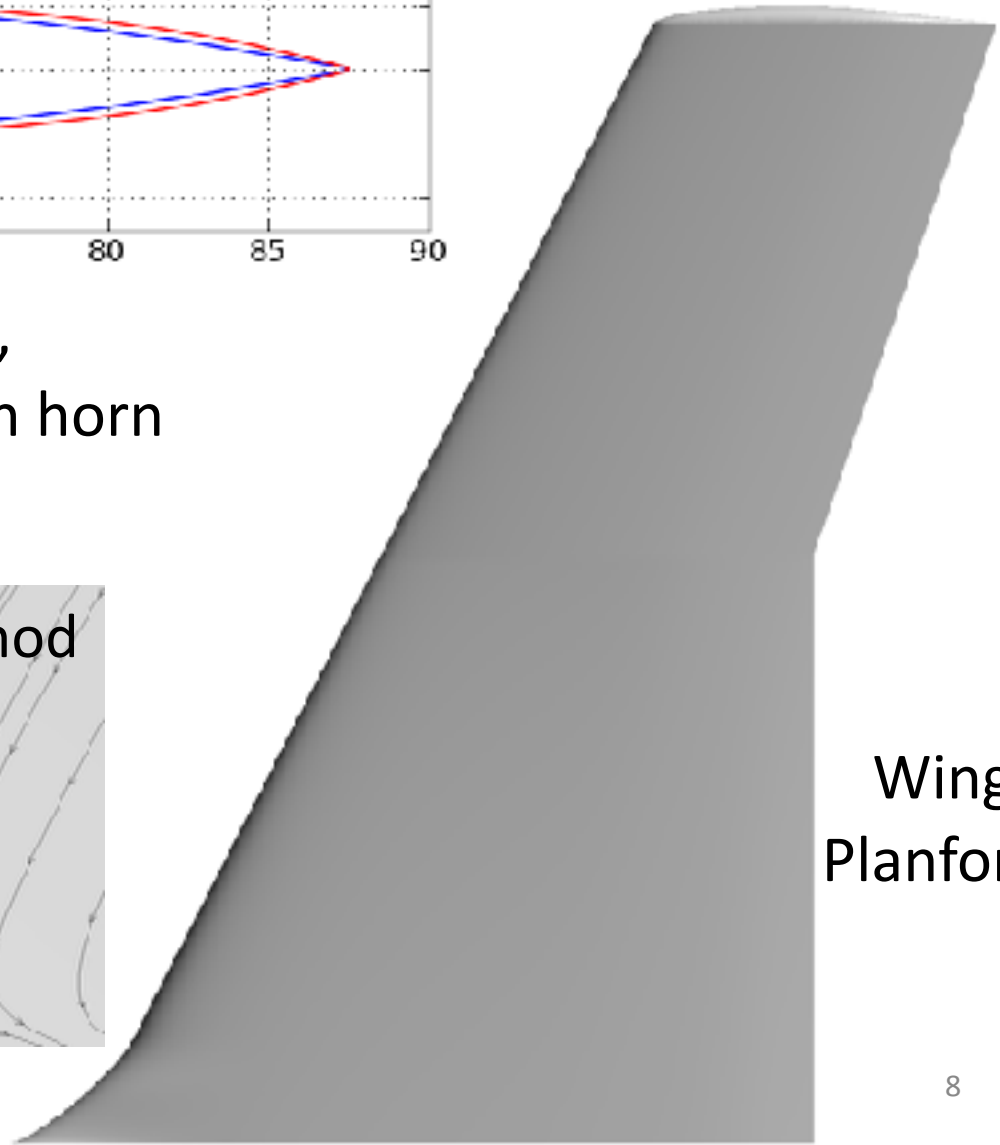

Wing
Planform

F6S12 — COCA

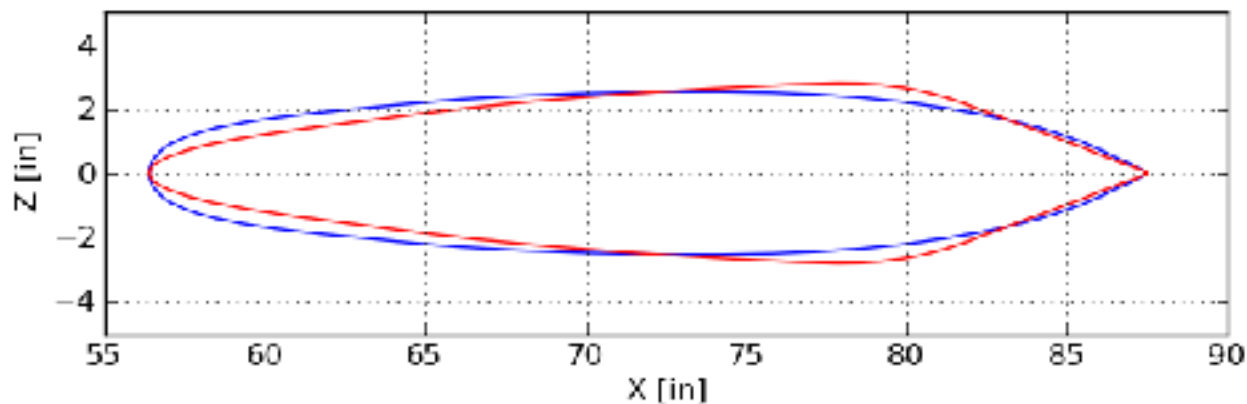

Blue: F6S12 w/horn, Red: COCA w/horn

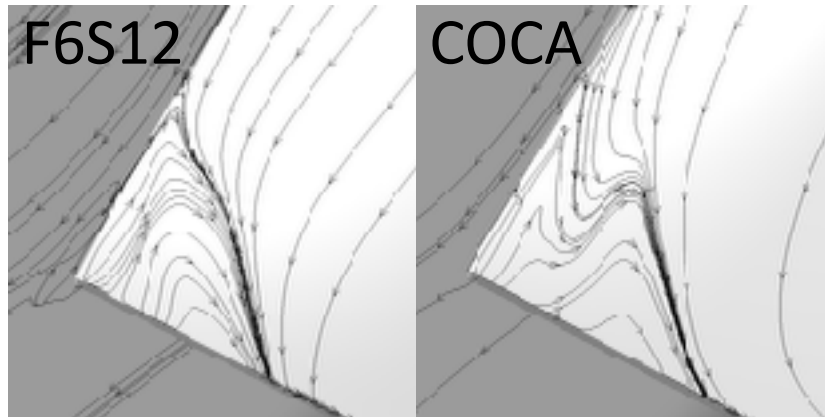

Side of Body Separation

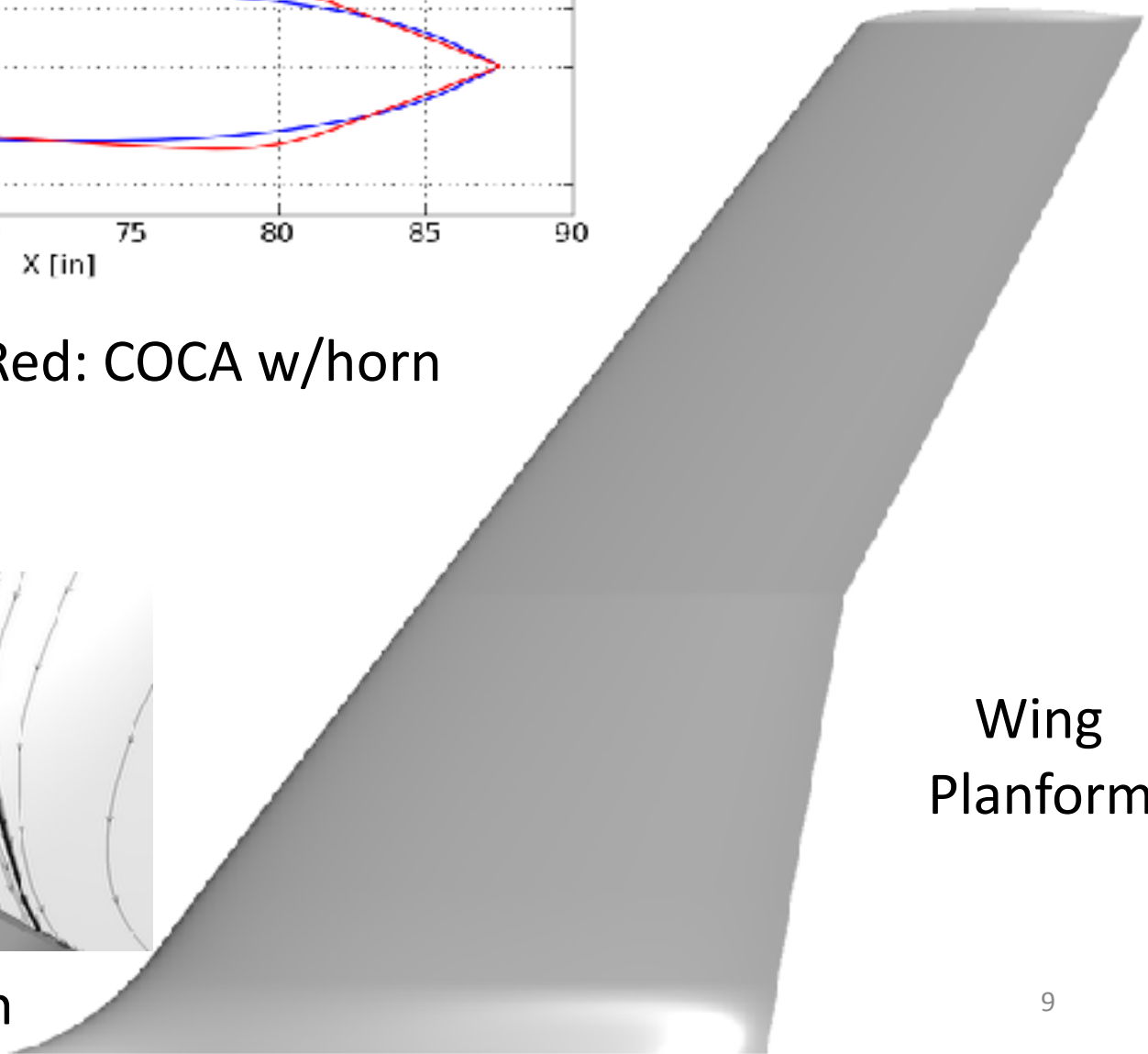

Wing
Planform

Risk Reduction Tests



- Series of risk reduction tests
 - Ames TC2 3% wall mounted model, low RE
 - Virginia Tech 2.5% fullspan low RE
 - Langley 14x22 6% fullspan high RE
- CFD solutions were run concurrently with all tests

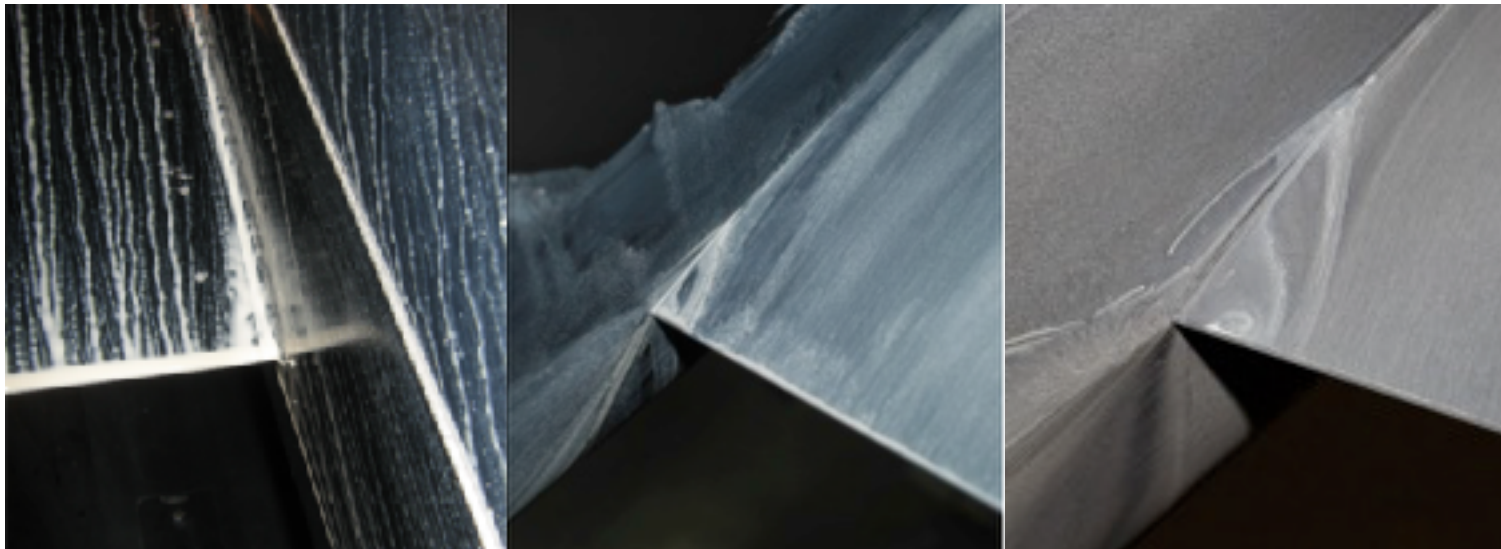

TC2

VA Tech

14x22



Model in TC2 and CFD Geometry

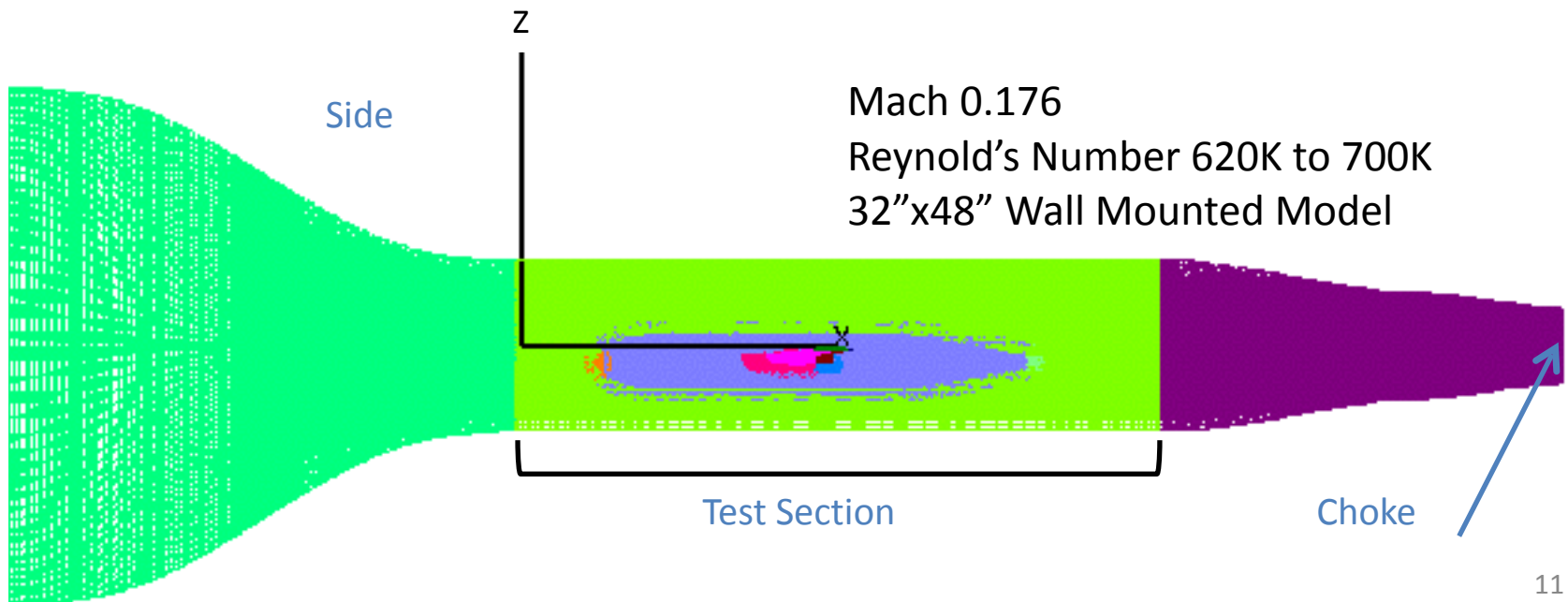
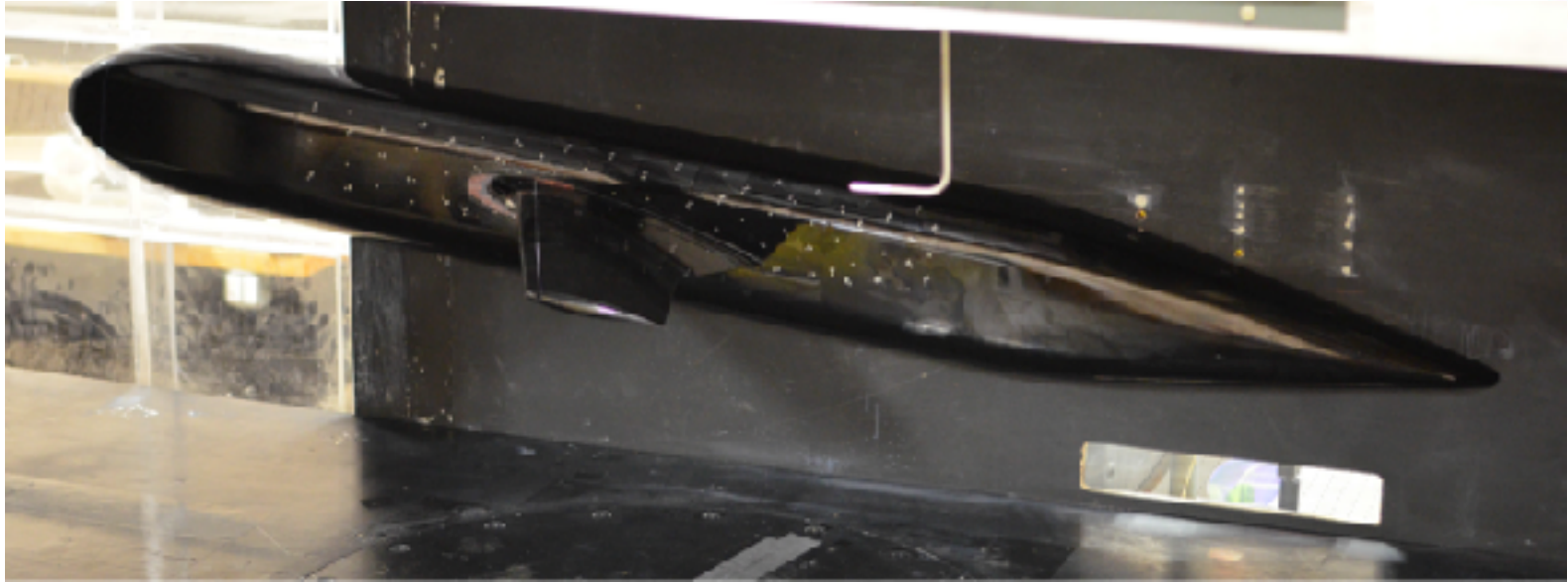

TC2 Risk Reduction

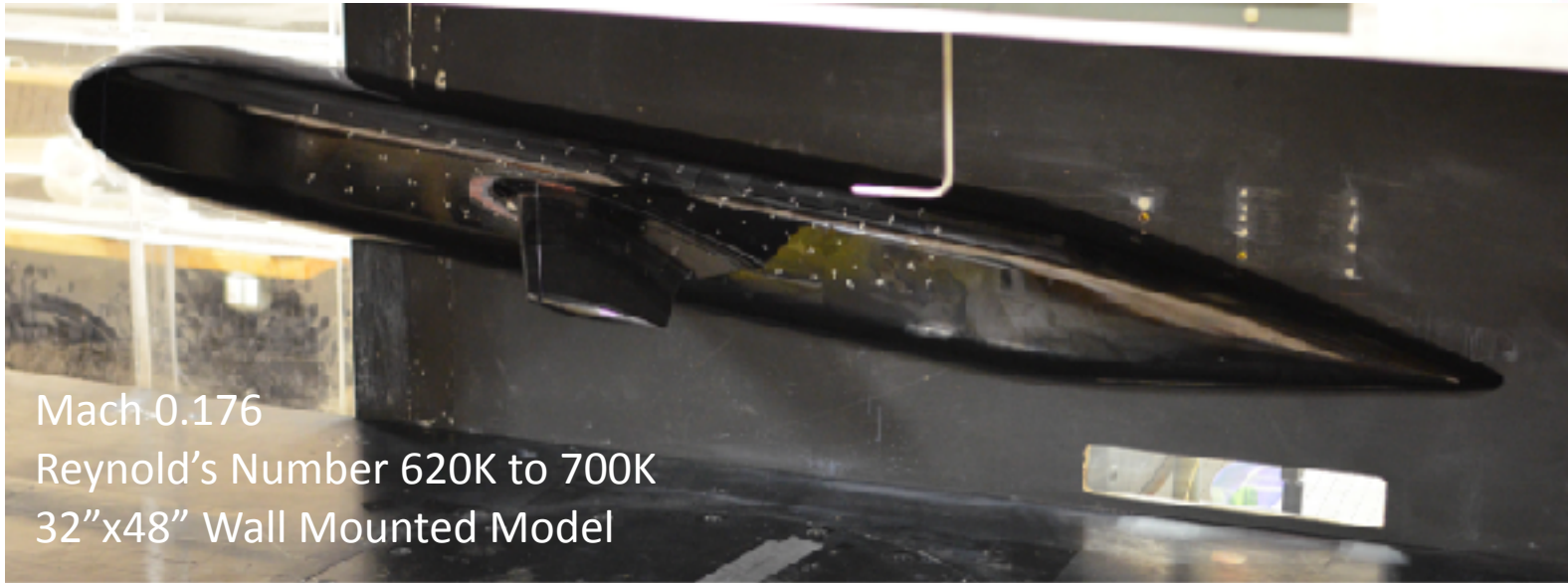

Mach-0.176
Reynold's Number 620K to 700K
32"x48" Wall Mounted Model

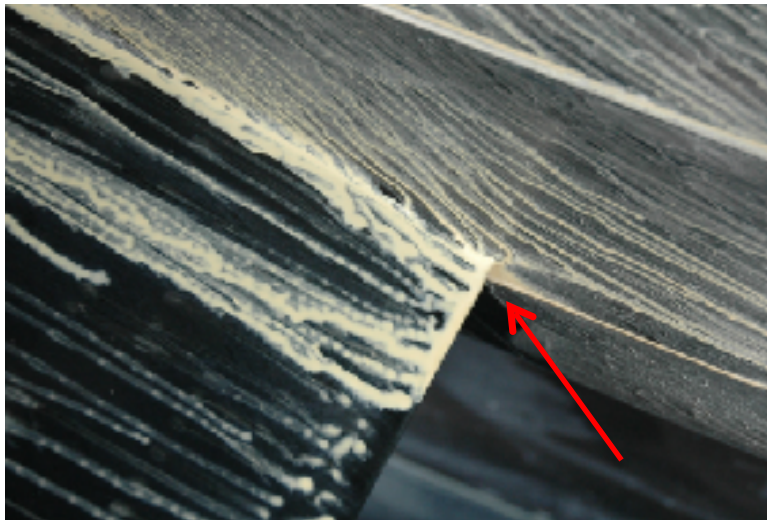

Small hint of separation

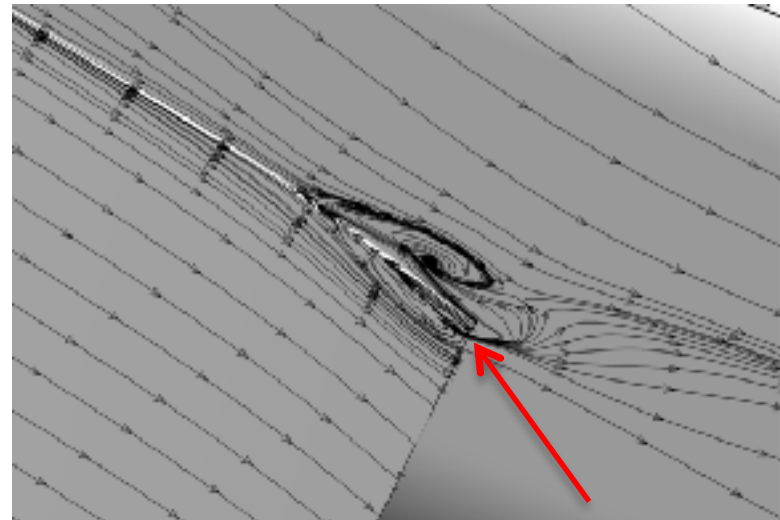

Clear evidence separation

Determined Wall Mounted model is not ideal for this test

Results published in AIAA Paper 2016-1558

Virginia Tech 2.5% Full Span Test



Mach 0.176, Reynolds Number of 620K, 6' Test Section

VT Tunnel Risk Reduction



F6 w/horn

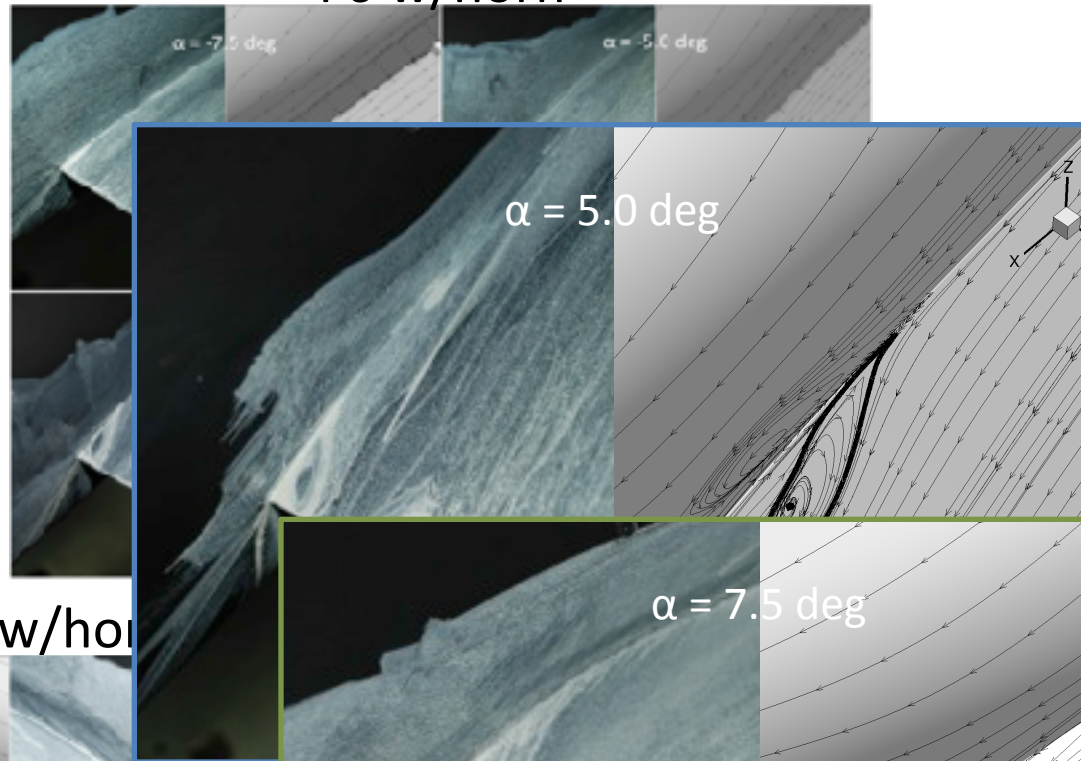

F6S12 w/horn



14x22 6% Risk Reduction Test

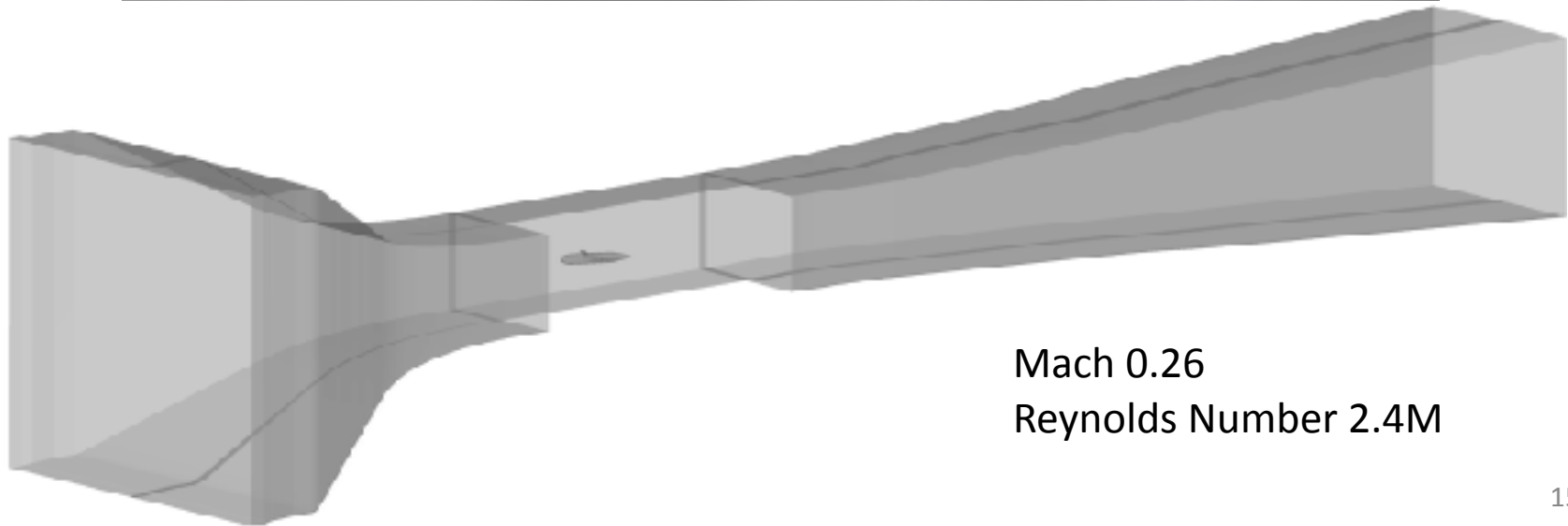
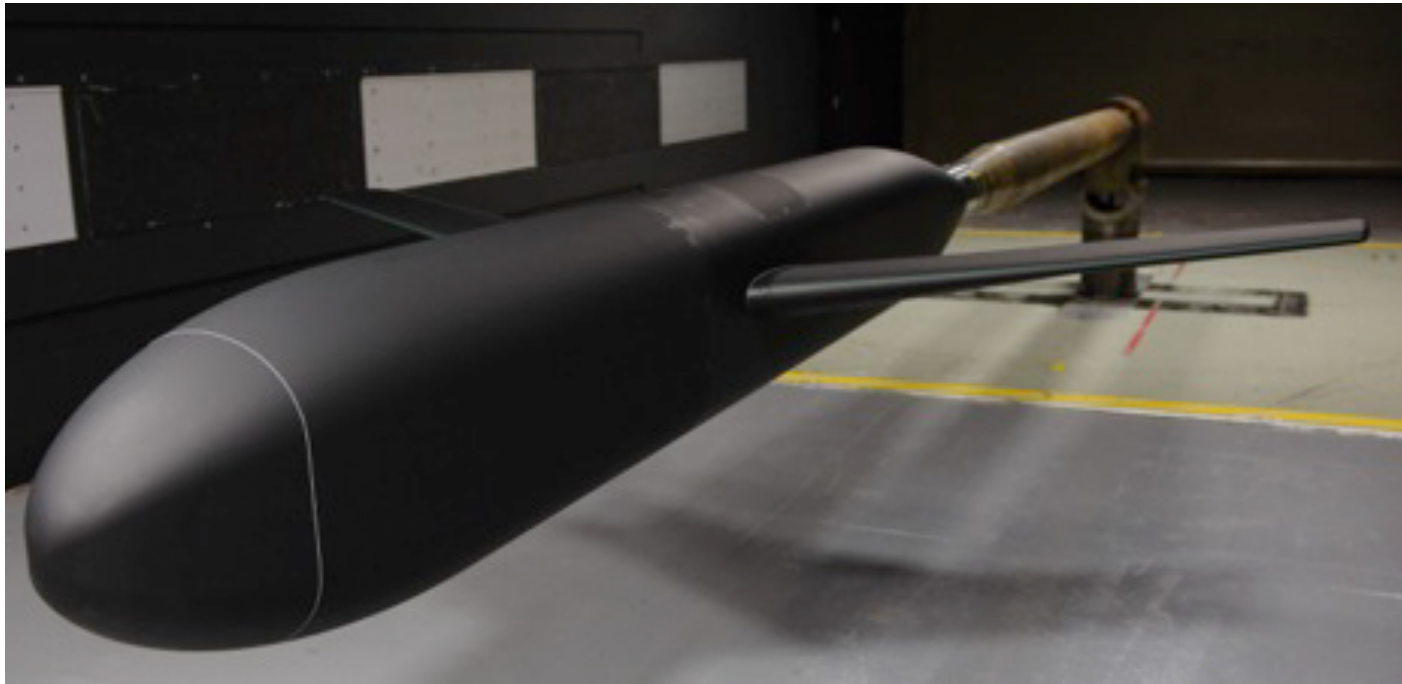

Mach 0.26
Reynolds Number 2.4M

14x22 6% Risk Reduction Setup



- Three data sources
 - Experiment
 - CFD in Free Air
 - CFD with 14x22 wind tunnel walls
- Comparisons: oil flow vs streamlines
- Additional results for $\alpha = -10.0 - 10.0$ degrees in paper
- Additional experimental results in NASA TM-219348



NASA Langley 14- by 22-Foot Subsonic Tunnel

- 14.5 ft high by 21.75 ft wide test section
- Closed-circuit wind tunnel
- Blue box represents high speed leg
- $RE = 2.4$ million, Mach 0.26

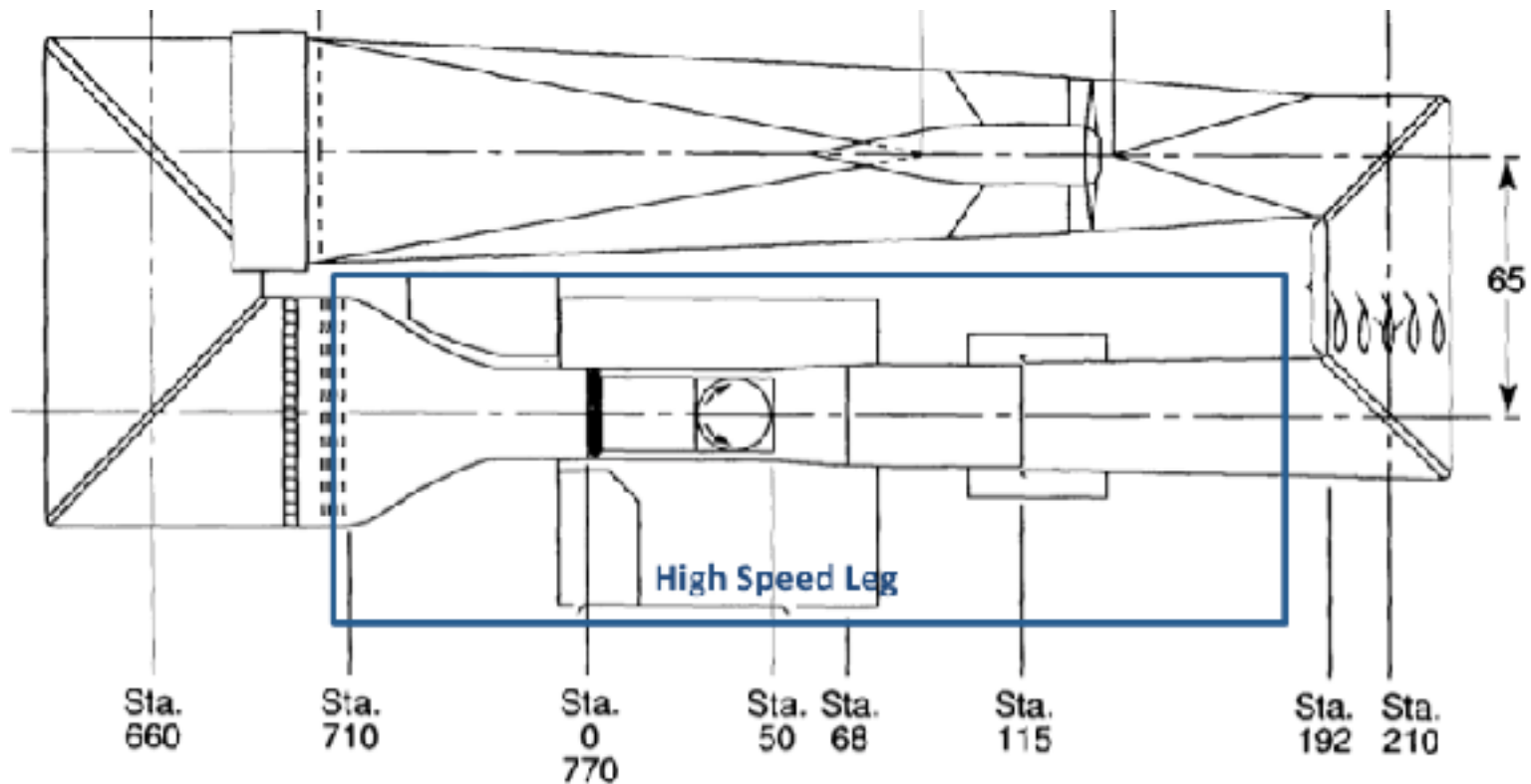

Juncture Flow Model Grids

- Grids created based on best practices, as defined by AIAA workshops (DPW, HiLift, etc)
- Grid resolution study was performed early on to establish grid guidelines for all cases

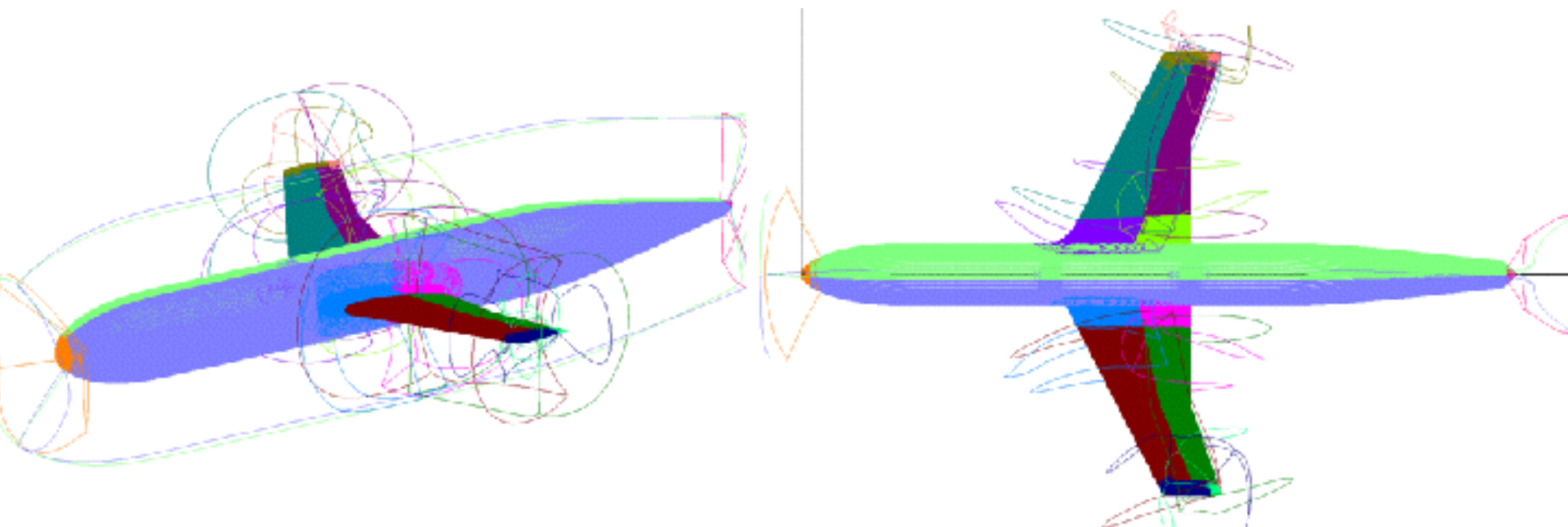

JFM Grids ISO-view

JFM Grids Top-view

JFM Free Air Cases



- JFM grids, imbedded in Overflow's off body grids
- Fairfield at 100 chord lengths away
- 108 Million grid points
- 420 Intel Broadwell cores, 12 hours wall time (NASA Pleiades)

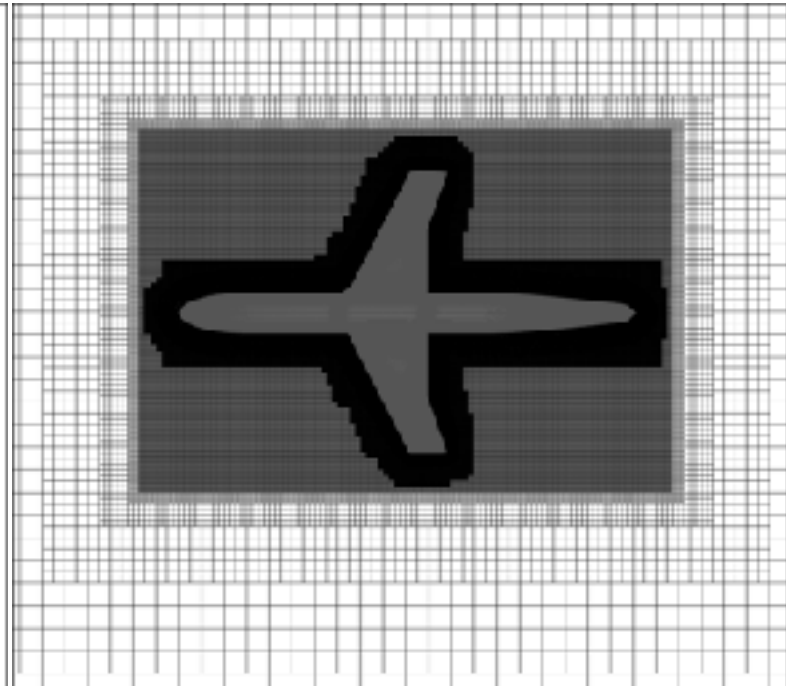
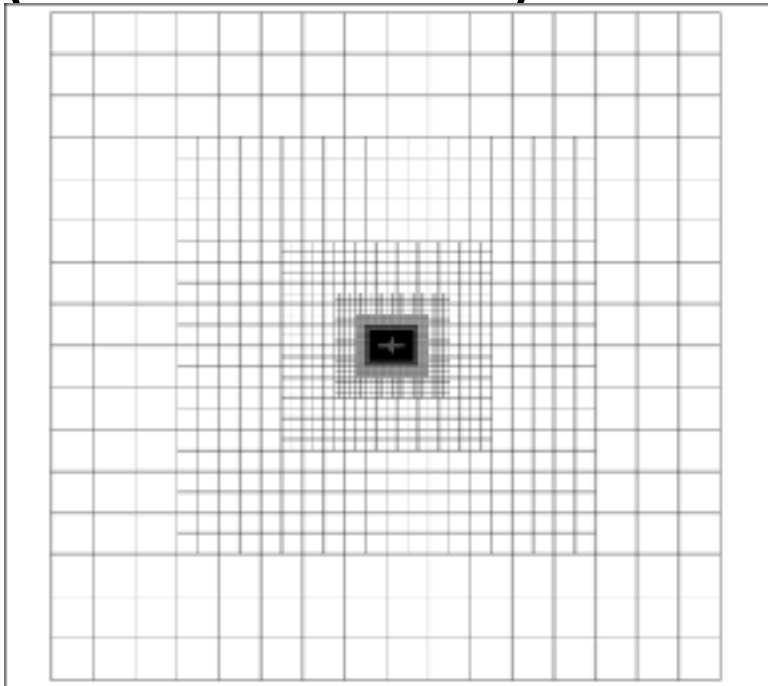

JFM Wind Tunnel Cases



- JFM grids, installed in the 14x22 wind tunnel grids
- Inflow BC: Stagnation pressure/temperature
- Outflow BC: Back pressure iterated to match tunnel speed.
- 1200 Intel Ivy Bridge cores, 60-120 hours wall time (NASA Pleiades)
- 117 million grid points

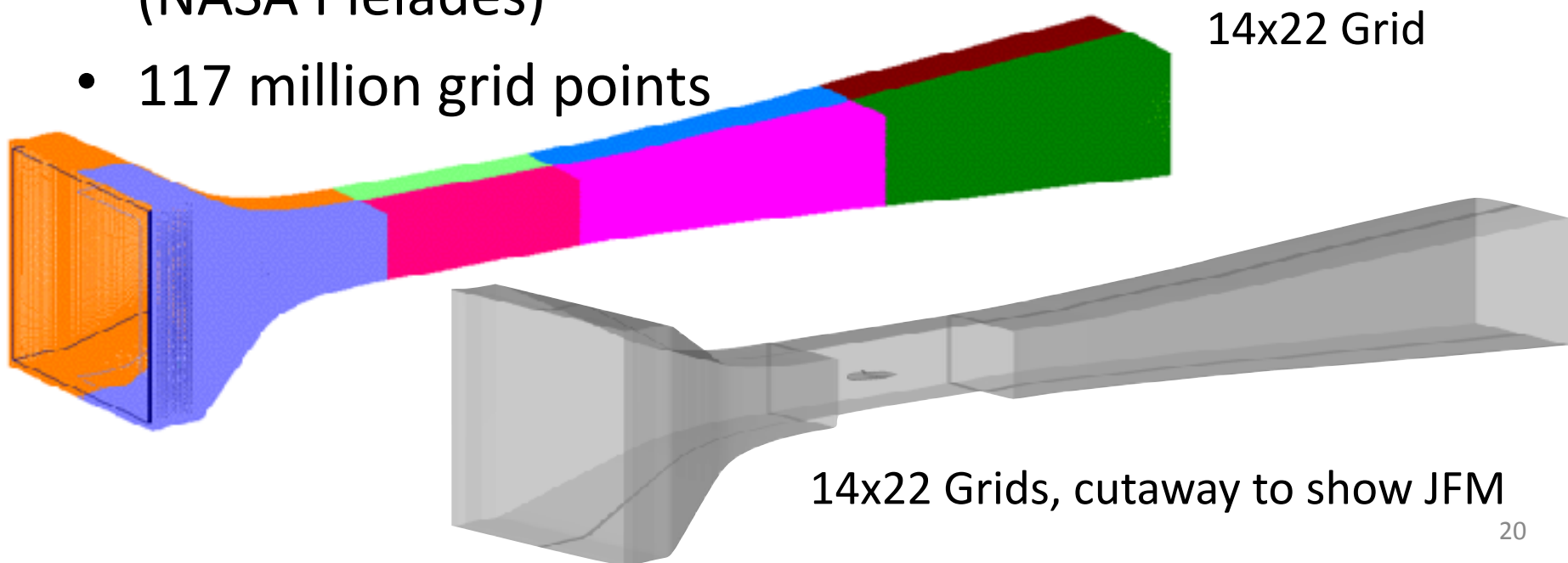

SOB Bubble Size Definitions



Experiment Oil Flow

CFD Surface Streamlines

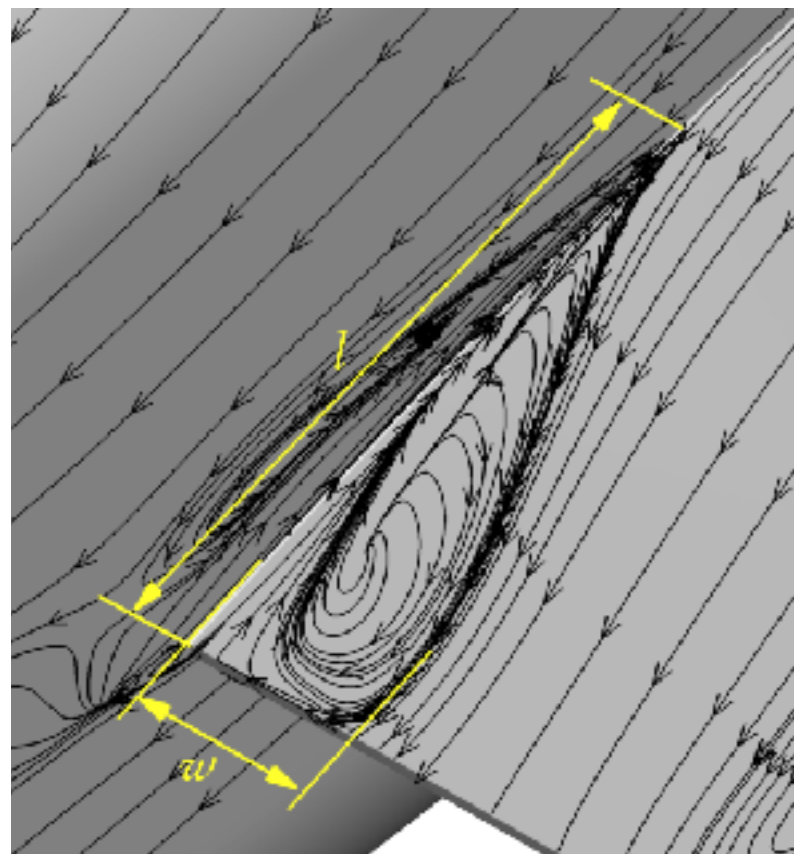
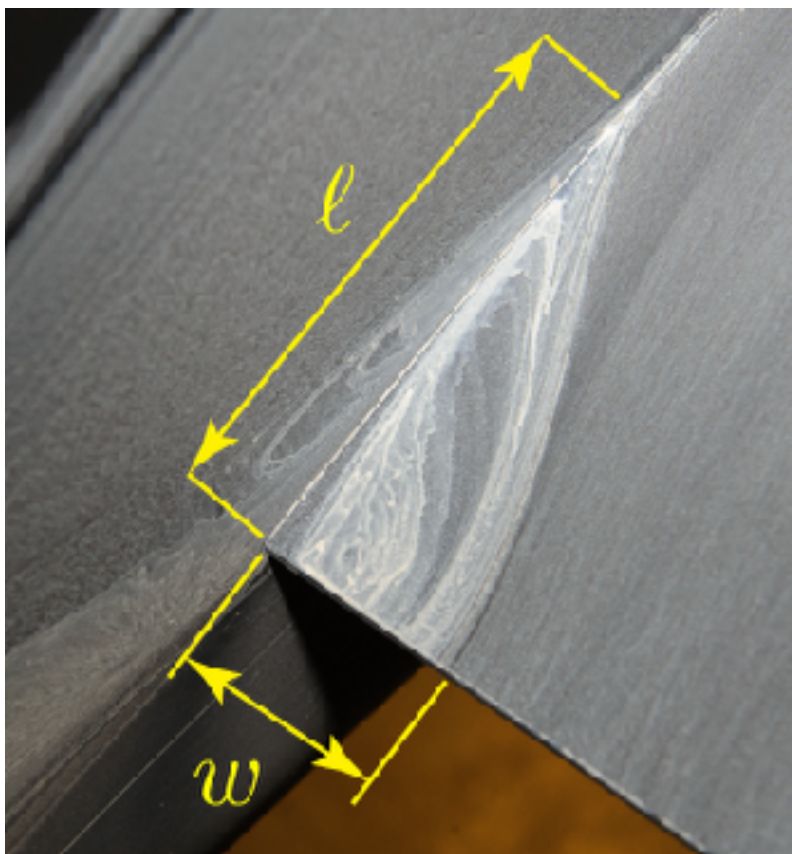

length l and width w bubble size definitions

Wing Configurations



Configuration	Port Wing	Starboard Wing	Data
1	F6 no horn	F6 w/horn	Exp, CFD Free Air, CFD WT
2	NACA 0015 w/horn	NACA 0015mod w/horn	Exp, CFD Free Air, CFD WT
3	F6S12 w/horn	COCA w/horn	Exp, CFD Free Air

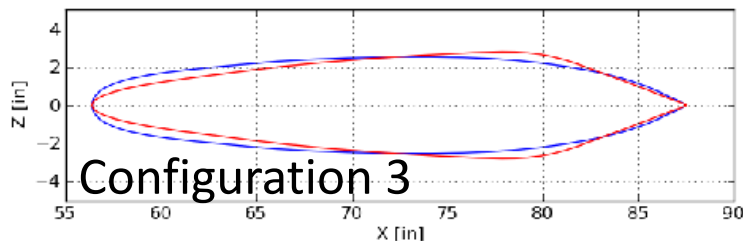
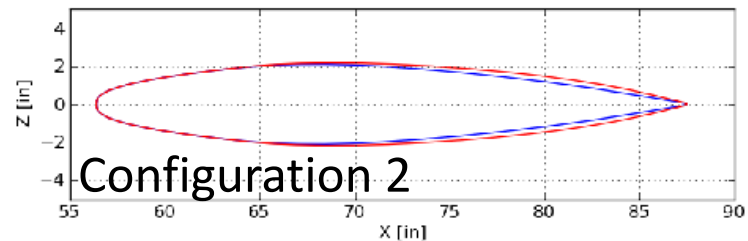
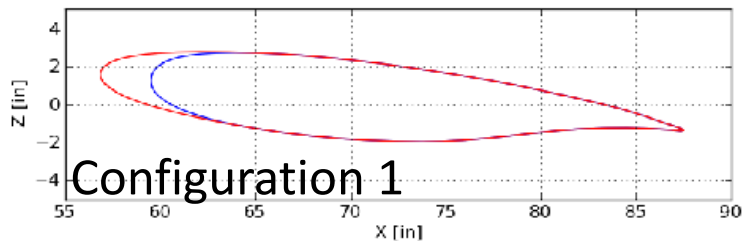

— Port Wing (blue)
— Starboard Wing (red)



Configuration 1: F6 no horn—F6 w/horn, $\alpha=5.0^\circ$

Port Wing: F6 no horn

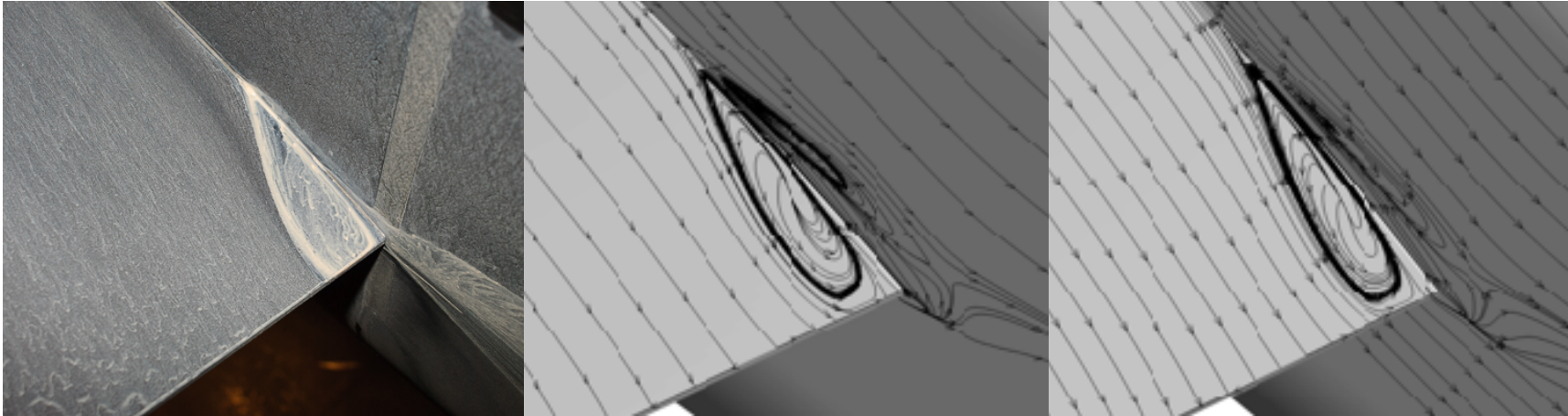

Starboard Wing: F6 w/horn

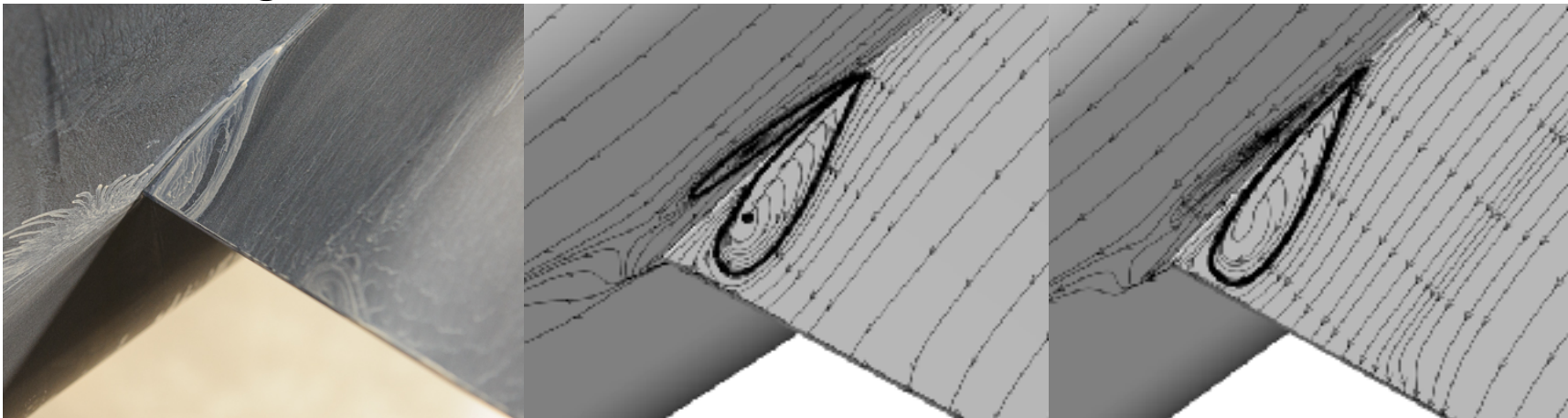

Experiment

CFD Free Air

CFD WT



Configuration 1: F6 no horn—F6 w/horn

Bubble Length Comparison

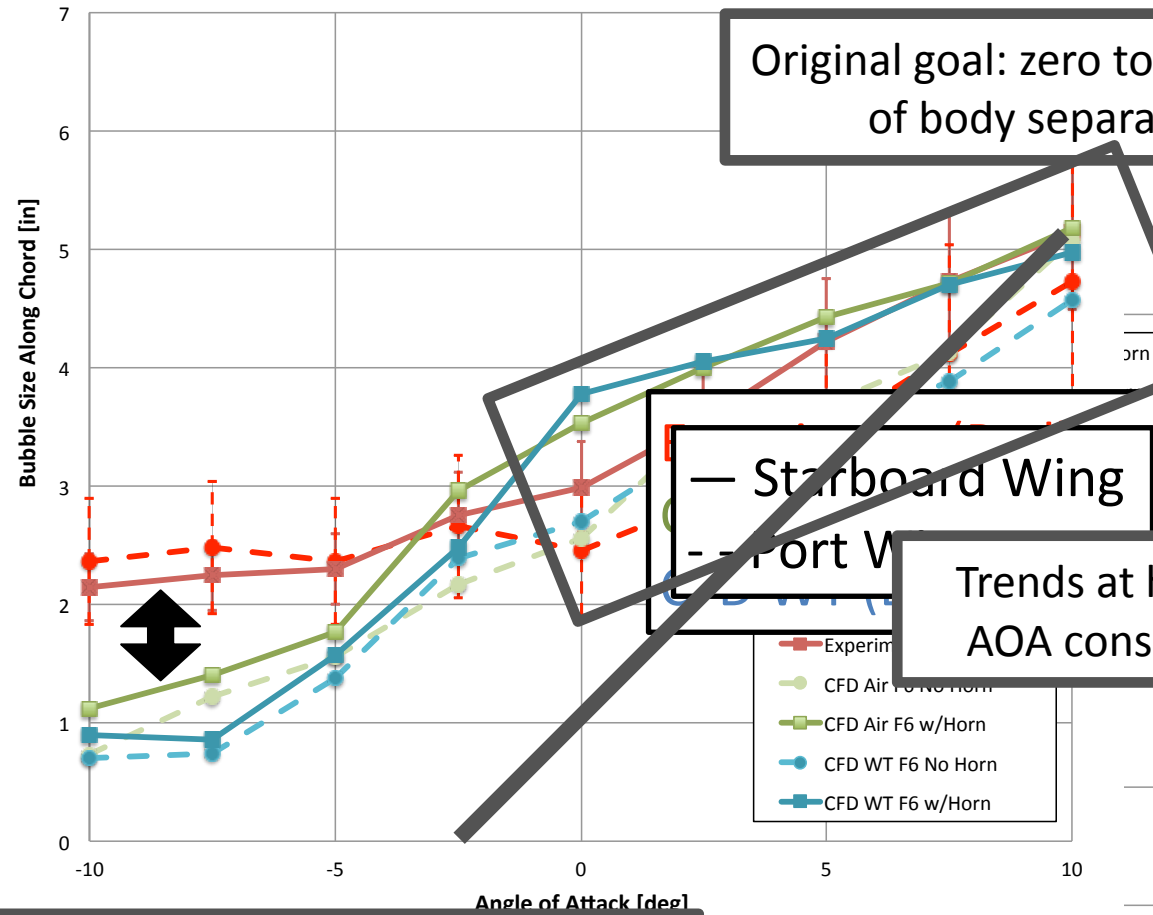

Bubble Width Comparison

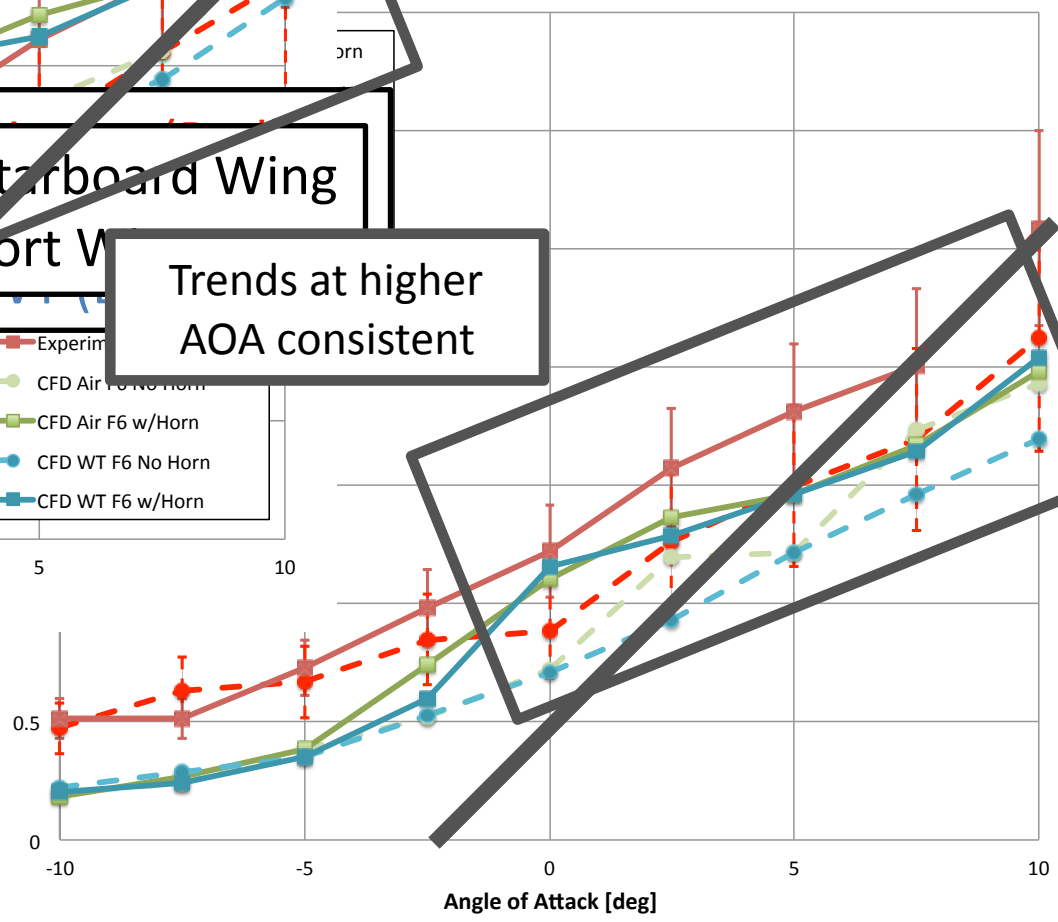



Configuration 1: F6 no horn—F6 w/horn, $\alpha=5.0^\circ$ LE

Port Wing: F6 no horn

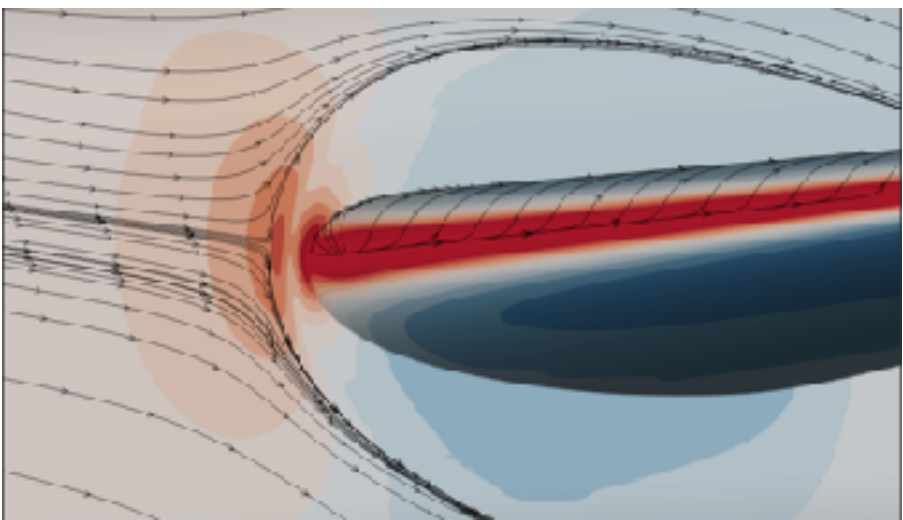

Starboard Wing: F6 w/horn

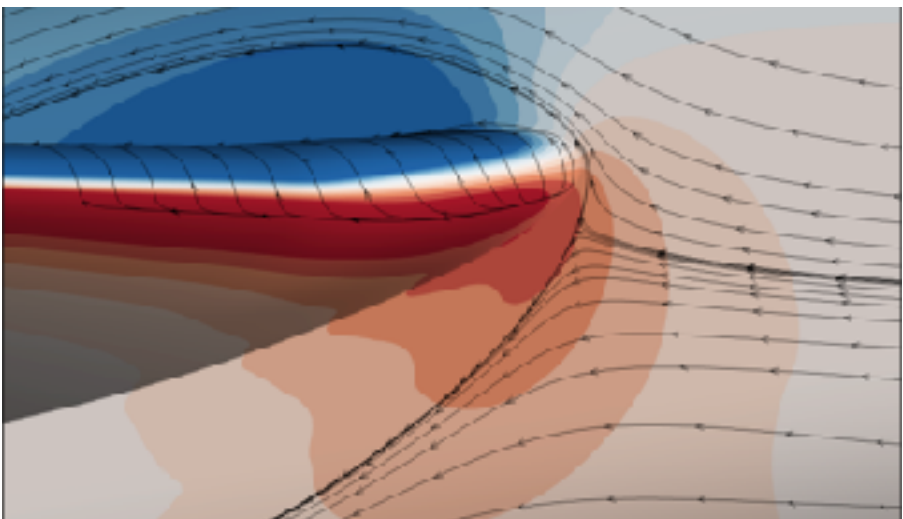
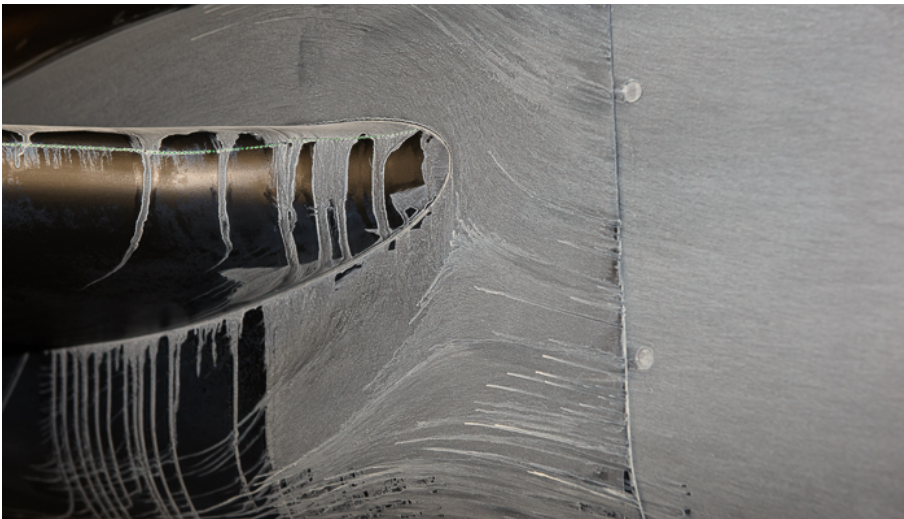

Experiment

CFD WT



Configuration 2: NACA 0015—NACA 0015mod, $\alpha=5.0^\circ$

Port Wing: NACA 0015 w/horn

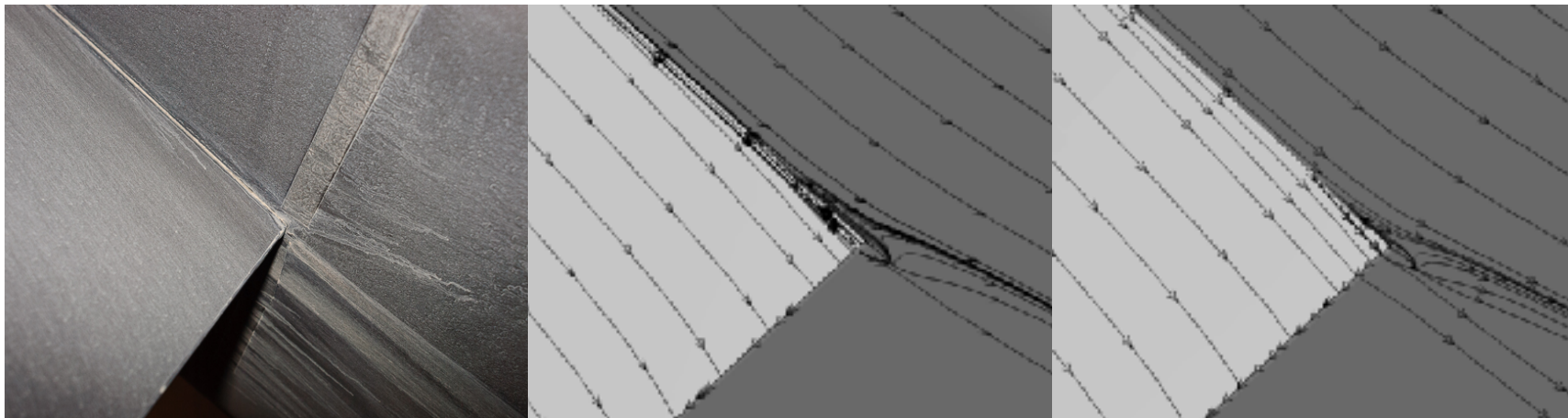

*Was run without horn

Starboard Wing: NACA 0015mod w/horn

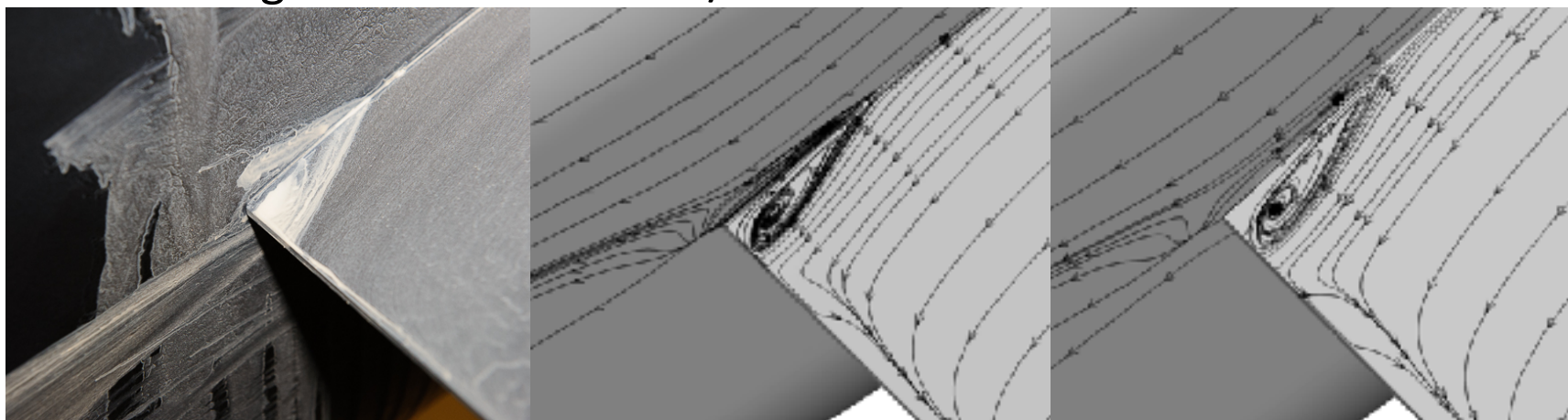

Experiment

CFD Free Air

CFD WT



Configuration 2: NACA0015—NACA0015mod

Bubble Length Comparison

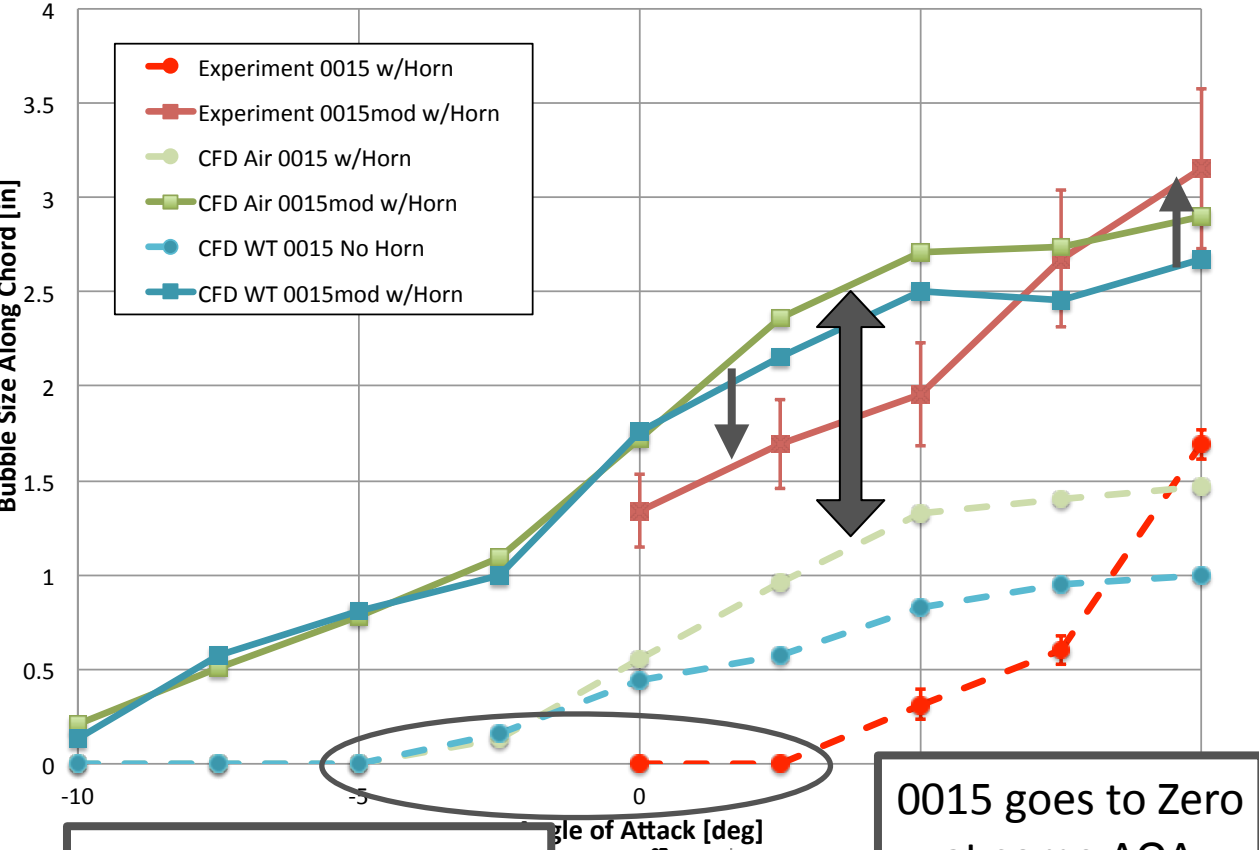

Bubble Width Comparison

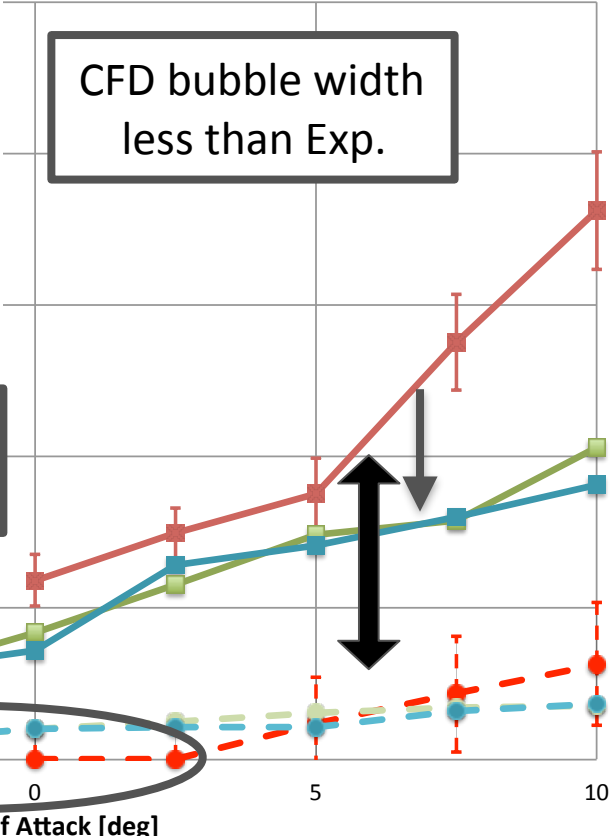

CFD Bubble Length slightly larger than Exp. at lower alpha, under predicts at high alpha

0015 goes to Zero at some AOA

CFD bubble width less than Exp.

CFD Air 0015mod w/Horn predicts better than WT 0015mod w/Horn at high alpha

Configuration 3: F6S12—COCA, $\alpha=5.0^\circ$



Port Wing: F6S12 w/horn

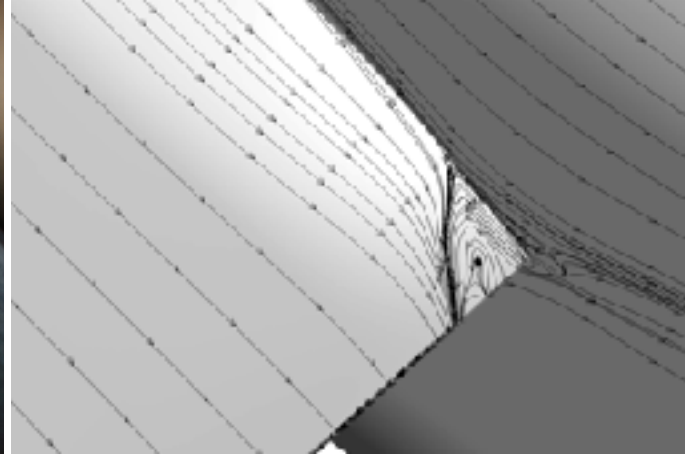

Starboard Wing: COCA w/horn

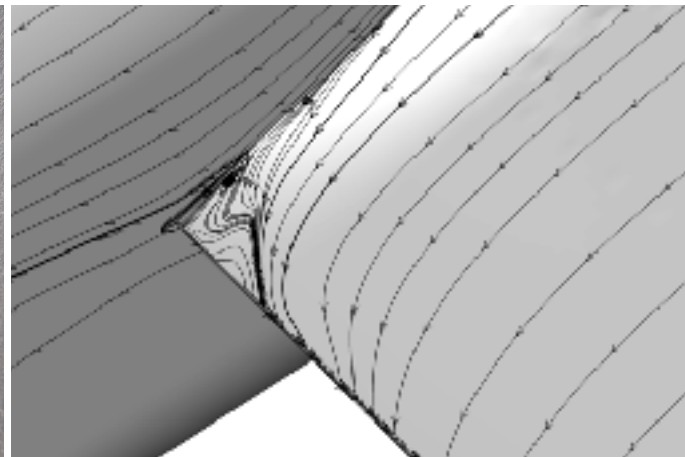

Experiment

CFD Free Air

Wing Evaluations



- Trends between CFD and Experiment are very good
- F6 showed medium to large side of body separations
- NACA 0015 showed none to small separation
- NACA 0015mod showed small to medium separation
- COCA wing and F6S12 ruled out
- LE-horn indicates smaller LE horseshoe vortex

Conclusions and Upcoming



- Performed wing design evaluations with CFD
- Performed companion CFD risk assessments with the risk reduction experiments
- CFD design and analysis, combined with experimental risk assessment experiments, results in high confidence in selecting the final models
- Committee used all the data to select the final configurations:
 - F6 (primary)
 - 0015 (secondary)
- Fuselage Model & Wing models delivered May 2017
- Tunnel entry 1: November 2017
- Tunnel entry 2: March 2018

Acknowledgements



NASA's Transformational Tools and Technologies (T³)

Chris Rumsey and the Juncture Flow committee:

NASA Langley: P. Balakumar, Mark Cagle, Dick Campbell, Jan-Renee Carlson, Andy Davenport, Kevin Distill, Judy Hannon, Luther Jenkins, Bil Kleb, Mujeeb Malik, Cathy McGinley, Joe Morrison, Frank Quinto, Don Smith, Sandy Webb

NASA Ames: James Bell, Nettie Roozeboom, Laura Simurda, Greg Zilliac

Boeing: Mike Beyer, Neal Harrison, Peter Hartwich, Philippe Spalart, Tony Sclafani, John Vassberg

AUR: Gwibo Byun and Roger Simpson

Virginia Tech: Aurelien Borgoltz and Todd Lowe

University of Kentucky: Jim Coder

Bill Oberkampf