



Thank you for downloading this document from the RMIT Research Repository.

The RMIT Research Repository is an open access database showcasing the research outputs of RMIT University researchers.

RMIT Research Repository: <http://researchbank.rmit.edu.au/>

Citation:

Deivasigamani, A, Daliri, A, Wang, C and John, S 2013, 'A review of passive wireless sensors for structural health monitoring', *Modern Applied Science*, vol. 7, no. 2, pp. 57-76.

See this record in the RMIT Research Repository at:

<https://researchbank.rmit.edu.au/view/rmit:23983>

Version: Published Version

Copyright Statement: © Canadian Center of Science and Education

Link to Published Version:

<http://dx.doi.org/10.5539/mas.v7n2p57>

PLEASE DO NOT REMOVE THIS PAGE

This work is available via a creative commons attribution 3.0 license. For the terms of the license, please go to: <http://creativecommons.org/licenses/by/3.0/>

A Review of Passive Wireless Sensors for Structural Health Monitoring

Arvind Deivasigamani¹, Ali Daliri¹, Chun H. Wang¹ & Sabu John¹

¹ School of Aerospace, Mechanical & Manufacturing Engineering, RMIT University, Melbourne, Australia

Correspondence: Arvind Deivasigamani, School of Aerospace, Mechanical & Manufacturing Engineering, RMIT University, GPO Box 71, Bundoora, Melbourne, Victoria 3083, Australia. Tel: 61-425-564-825. E-mail: arvind.deivasigamani@student.rmit.edu.au

Received: July 9, 2012 Accepted: January 16, 2013 Online Published: January 29, 2013

doi:10.5539/mas.v7n2p57

URL: <http://dx.doi.org/10.5539/mas.v7n2p57>

Abstract

Wireless sensors for Structural Health Monitoring (SHM) is an emerging new technology that promises to overcome many disadvantages pertinent to conventional, wired sensors. The broad field of SHM has experienced significant growth over the past two decades, with several notable developments in the area of sensors such as piezoelectric sensors and optical fibre sensors. Although significant improvements have been made on damage monitoring techniques using these smart sensors, wiring remains a significant challenge to the practical implementation of these technologies. Wireless SHM has recently attracted the attention of researchers towards un-powered and more effective passive wireless sensors. This article presents a review of some of the underlying technologies in the field of wireless sensors for SHM - with a focus on the research progress towards the development of simple, powerless, yet effective and robust wireless damage detection sensors. This review examines the development of passive wireless sensors in two different categories: (1) use of oscillating circuits with the help of inductors, capacitors and resistors for damage detection; and (2) use of antennas, Radio Frequency Identification (RFID) tags and metamaterial resonators as strain sensors for wireless damage monitoring. An assessment of these electromagnetic techniques is presented and the key issues involved in their respective design configurations are discussed.

Keywords: structural health monitoring, wireless sensors, damage monitoring, oscillating circuits, metamaterial resonators, RFID

1. Introduction

Over the past few decades, the field of Structural Health Monitoring (SHM) has attracted considerable research. Several effective damage monitoring techniques like strain measurement, electro-mechanical impedance, scattering of guided waves, acoustic emissions, dynamic response and optical techniques have been developed. Several sensors like strain gauges, piezoelectric sensors and optical fibre sensors have been employed (Housner et al., 1997; Chang, 2002; Auweraer & Peeters, 2003; Chang, Flatau, & Liu, 2003; Wang & Rose, 2003; Wang & Chang, 2005).

The above mentioned sensors are extensively used for damage monitoring; however, they do present certain limitations. Most of the existing sensors require an input power supply. When the sensors detect any change in strain or stress, they need to transfer the information, for signal processing and analysis, to the data acquisition system which may be located at the base station far away from the structure being monitored. The necessary connection of sensors by wires for power and data transmission often renders the SHM system complex to implement and difficult to maintain. The whole structure sometimes needs to be redesigned to accommodate the connections among these sensor networks; therefore, increasing the cost of manufacture. The technical difficulties of designing sensor systems along with their connections become more pronounced when the structure under investigation contains moving parts, such as a helicopter rotor. Furthermore, wiring between sensors and base-stations increases the cost of replacing damaged or degraded sensors.

In order to tackle these challenges, researchers have started investigating options which could result in wireless SHM. By making the sensors wireless through the incorporation of energy coupling and communication functionalities, it is possible to integrate the data acquisition and signal processing system in the same sensor unit.

One example is the use of microwave antennas along with the application of Micro Electro-Mechanical System (MEMS) technology, which could be integrated with the sensor nodes to communicate with the base station.

Although the above mentioned research contributed substantially to the development of wireless SHM, significant gaps still remain. In many of aforementioned cases, the power supply to the sensors and the signal conditioning system require wires or cables. Sometimes, the electronic chips in MEMS sensors contain integrated solid state batteries to supply power (Lynch & Loh, 2006). Recharging or replacing these batteries remains a major issue, particularly when the sensors are embedded in composite structures.

Recently, researchers have begun investigating alternative techniques to enable the sensor system to become completely wireless and passive; where the power is supplied by external sources wirelessly and the sensor transmits the signals wirelessly back to the base station (Spencer, Ruiz-Sandoval, & Kurata, 2004). In this regard, researchers have demonstrated sensor systems which can detect damage and monitor the structure effectively with less power consumption or completely wireless. Therefore, to address the issue of power supply to the sensors and signal conditioning system, several developments have been reported where the electromagnetic resonators could receive power wirelessly through Radio Frequency (RF) signals and utilize them to measure the strain in the structure (Chaimanonart & Young, 2006). The measured strain can be wirelessly transmitted to the base station for data analysis. Alternatively, on-chip energy harvesting systems have been reported as a means to solve the power requirement issue (Anton & Sodano, 2007).

This article presents a review of pertinent work in the field of wireless SHM, with a focus on the electromagnetic techniques. This article groups the use of electromagnetics in development of passive wireless sensors into two sections: (1) use of oscillating circuits with the help of inductors, capacitors and resistors for damage detection; and (2) use of antennas, Radio Frequency Identification (RFID) tags and metamaterial resonators as strain sensors for wireless damage monitoring. This article aims to review the current state of the art and progress towards the development of effective and simple passive wireless damage monitoring techniques.

2. Use of Oscillating Circuits and Wireless Interrogation

Although the work mentioned in the previous section contributes significantly to the development of wireless SHM, they still have certain limitations. In most of the above cases, the power input to the sensors and the signal conditioning system are given using wires or cables. Sometimes, these chips are integrated with solid state batteries to supply power. It is however, important to ensure that the charge in the batteries is sufficient for the useful life of these systems. This becomes even more important when the sensors are embedded in the host materials. This provides the need for developing a sensor system that could be completely wireless in terms of power supply and data transmission. Therefore, researchers started investigating the application of oscillating circuits in strain monitoring. Their objective was to transform the strain in the structure into the change in the frequency of the oscillating circuits in order to read the values wirelessly. Several RC and LC tank circuits are used in this regard which could transform the strain in the structure to the change in inductance, capacitance or resistance which in turn changes the resonant frequency of the circuit. Several researchers have reported developments in the use of oscillating circuits for wireless SHM and this section reviews this body of work.

Watters, Jayaweera, Bahr, and Huestis (2001) suggested a very effective wireless sensor for structural health monitoring. In this technique, a sensor was integrated with a passive RFID chip. The chip receives the RF power wirelessly and converts it to DC power. The received power is utilized by the sensor and the signals are sent back to the receiver which makes the system completely wireless. This system requires the integration of the chip with the signal conditioning unit and the sensor. The diagram of the RFID/sensor is shown in Figure 1.

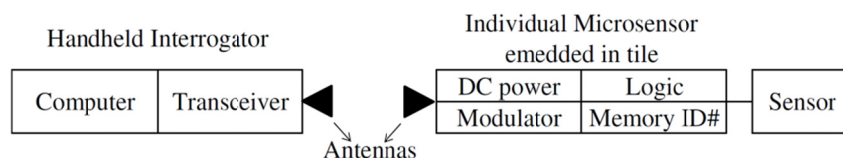

Figure 1. Principle of operation of an RFID/sensor hybrid (Watters et al., 2001)

Butler, Viglio, Vendi, and Walsh (2002) developed a strain sensor with an inductively coupled resonant circuit (LC tank circuit) for wireless damage detection. The governing equation for the resonant frequency of the circuit is,

$$f = 1/(2\pi\sqrt{LC}) \quad (1)$$

Where f is the natural frequency; L is the inductance; and C is the capacitance. The inductance of the solenoid can be calculated by,

$$L = k\mu N^2 A/l_0 \quad (2)$$

Where k is the form factor; μ is the permeability; N is the number of turns; A is the cross sectional area; and l_0 is the solenoid height.

Thus,

$$f = (1/2\pi)\sqrt{l_0/Ck\mu N^2 A} \quad (3)$$

By applying strain the cross sectional area of the solenoid changes and from Equation 3 its resonant frequency changes accordingly. A high frequency oscillator was used to measure the resonant frequency of the solenoid. The dip in the RF power is measured to find the frequency of the sensor and thus the applied strain. The experimental setup of this concept is illustrated in Figures 2 and 3.

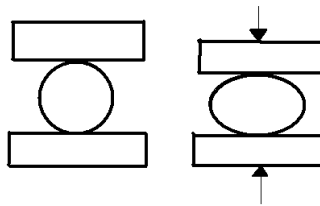

Figure 2. Schematic of guillotine compressing non-embedded sensor coil (Butler et al., 2002)

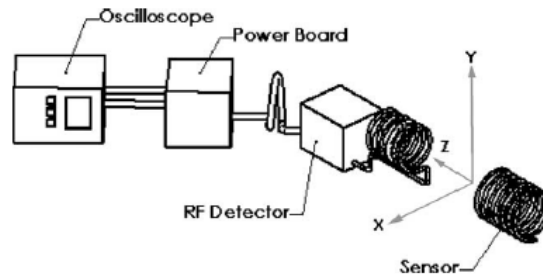

Figure 3. Illustration of experimental setup (Butler et al., 2002)

Chuang, Thomson, and Bridges (2005) developed an embeddable wireless strain sensor which works with the same principle as the previous case. The difference is that instead of a solenoid a coaxial resonant RF cavity was used as the sensor (Figure 4). The cavity length changes under the applied load thereby changing its resonant frequency. The shift in the resonant frequency with respect to the applied strain is shown in Figure 5. This sensor was shown to be linear up to $130 \mu\epsilon$. The shift in the frequency was about 2.42 kHz per $\mu\epsilon$. The relationship between the applied strain and the resonant frequency of the cavity was derived using the following equations.

$$f_{str} = \frac{C}{2(l + \Delta l)} = \frac{C}{2l} \left(\frac{1}{1 + \epsilon} \right) \approx f_{unstr} (1 - \epsilon) \quad (4)$$

$$\Delta f_r = f_{str} - f_{unstr} \approx -f_{unstr} \epsilon \quad (5)$$

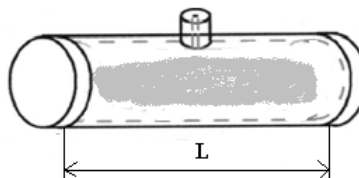

Figure 4. Electromagnetic coaxial cavity sensor. The dominant TEM001 resonant mode is shown (Chuang et al., 2005)

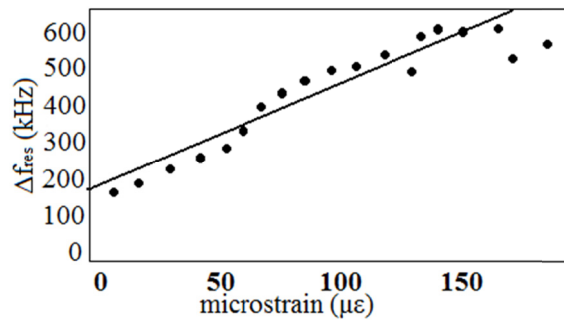

Figure 5. Change in Δf_r as a function of the strain applied to a concrete block (Chuang et al., 2005)

Umbrecht, Wendlandt, Juncker, Hierold, and Neuenschwander (2005) developed a wireless passive strain sensor for bio-medical applications. This sensor uses an incompressible liquid for strain measurement. As the load is applied, the liquid moves outward through a capillary tube proportional to the amount of load applied. This change in the liquid level is read wirelessly using an ultrasound imaging technique (Figure 6).

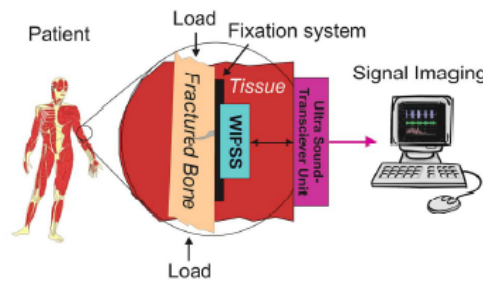

Figure 6. Typical application of a wireless implantable passive strain sensor system (Umbrecht et al., 2005)

Matsuzaki and Todoroki (2005) extended the use of wireless strain sensors to the automotive sector. A strain monitoring system was developed to measure and monitor the strain induced in an automotive tire by using the electrical capacitance variations within an oscillating circuit. The steel wires between the tread and the carcass were used as capacitors along with the resistors to form a RC oscillating circuit with a specific resonant frequency. When the tire is strained between the wires is altered; hence, the resultant resonant frequency of the circuit shifts. These frequency signals were read wirelessly by inductive coupling using an external antenna. The schematic of the strain monitoring system using an oscillating circuit is shown in Figure 7.

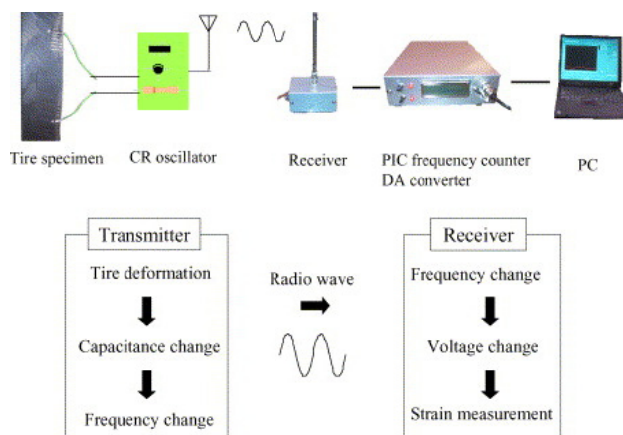

Figure 7. Schema of the strain monitoring system using an oscillating circuit (Matsuzaki & Todoroki, 2005)

Matsuzaki and Todoroki (2006) developed a wireless detection technique for internal delaminations/cracks in Carbon Fibre Reinforced Polymer (CFRP) laminates using frequency changes of an oscillating circuit. The CFRP laminate was itself used as the sensor because the electric current can flow through the conductive carbon

fibres. Two electrodes were attached to two sides of the laminate and were connected to an oscillating circuit. Presence of a crack/delamination in the laminate changes the resistance of the material and therefore shifts the frequency of the oscillating circuit. The resonant frequency of the circuit can be read wirelessly through an external antenna. The schematic of a CFRP laminate and the electrical current flow are shown in Figure 8.

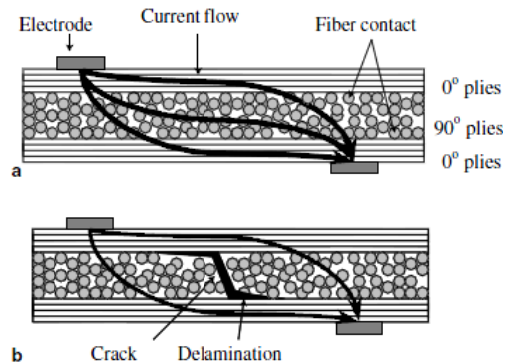

Figure 8. (a) Electrical network structure of the fibres in a CFRP laminate; (b) The electrical network is broken with a delamination (Matsuzaki & Todoroki, 2006)

Jia, Sun, Agosto, and Quinones (2006a) designed a passive wireless strain sensor for structural health monitoring. A plane spiral inductor as shown in Figure 9 was coupled with an interdigital capacitor to form a LC oscillating circuit which acts as a strain sensor as well as an antenna. The capacitance value is dependent on the distance between the fingers of the interdigital capacitor and hence it changes when there is a strain. The inductor receives the electromagnetic (EM) waves and sends the energy to the capacitor. This energy is then received back by the inductor and the signals are transmitted. This sensor was tested under load when attached to a cantilever beam showing acceptable linearity and sensitivity.

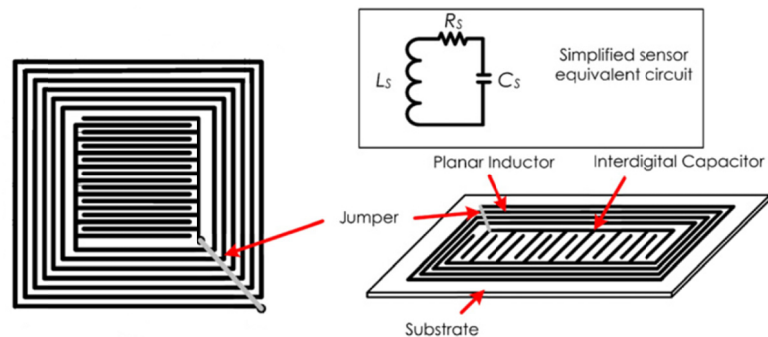

Figure 9. Sensor unit with a laminated sandwich structure (Jia et al., 2006a)

Jia and Sun (2006b) presented a novel wireless and powerless strain sensor with a multilayer thick film structure. The sensor consists of a planar inductor (L), a capacitive transducer (C), and a strain sensitive polarized polyvinylidene fluoride (PVDF) piezoelectric thick film. The resonant circuit was used to realize the wireless strain sensing through strain-to-frequency conversion and also by receiving radio frequency electromagnetic energy for powering the sensor. The results of the calibration on a strain constant cantilever beam showed marked linearity and the sensitivity of 0.0013 in the strain range of 0 to 0.018.

Tan, Pereles, Shao, J. Ong, and K. Ong (2008) developed a wireless passive strain sensor based on the harmonic response of magnetically soft materials. The sensor includes a deformable layer between a magnetically soft ferromagnetic alloy (sensing element) and a permanent magnet (biasing element) (Figure 10). The magnetic harmonic spectrum changes under the applied load which can be measured wirelessly when the sensor is under an AC magnetic field. The shifts in the magnetic harmonic spectrum of the sensor were linearly correlated with the mechanical strain. This sensor demonstrated good stability, linearity and repeatability. This passive wireless sensor is useful for long-term detection of mechanical loading from within an object such as inside a concrete structure or a human body.

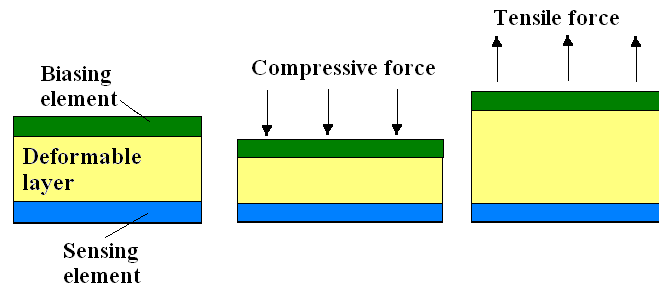

Figure 10. The biasing and sensing elements of the sensor are separated by a flexible layer to provide proper strain for a given compressive force (Tan et al., 2008)

In this section, several wireless strain sensing techniques utilising LC or RC oscillating circuits are discussed. The summary of the most important techniques are presented in Table 1. For these circuits to resonate at a specific frequency, power has to be supplied to the circuits. Some of these techniques employed external frequency oscillators and hand interrogators to provide power to the LC/RC circuits wirelessly. Thus, it is important to ensure an efficient energy coupling between the transmitter and the receiver. In SHM in order to determine and predict the crack propagation, it is essential to measure the strain in the structural member and to determine its spatial distribution. The work reviewed in this section does not refer primarily to the strain spatial distribution which is a major concern for researchers. Although these techniques are shown to be linear, it is important to ensure an acceptable reliability and repeatability for practical applications. These limitations provided the direction for further research, leading to the development of techniques discussed in the next section.

Table 1. Various techniques employed using oscillator circuits for wireless strain measurement

Authors	Technique
Butler et al., 2002	The strain changes the dimensions of the inductor and hence the inductance in the LC circuit, thus changing the resonant frequency.
Chuang et al., 2005	The strain changes the cavity length of the coaxial RF cavity thereby changing the resonant frequency.
Umbrecht et al., 2005	The strain moves the incompressible liquid through the capillary which is wirelessly read using ultrasound imaging technique.
Matsuzaki & Todoroki, 2005	The strain changes the capacitance of the RC oscillating circuit and hence changes the resonant frequency.
Jia et al., 2006a	The strain changes the capacitance of the interdigital capacitor coupled with the spiral inductor thereby changing the frequency of the LC circuit.
Tan et al., 2008	The strain deforms the flexible layer between the magnetically soft material and the permanent magnet hence changing the harmonic spectrum.

3. Use of Resonators and Antennas as Strain Sensors

The works discussed in the previous section are fairly simple and effective; however, researchers started to develop sensors which could directly convert strain into frequency shifts that could be read wirelessly. Antennas and electromagnetic resonators are passive devices which could be illuminated by incident electromagnetic waves and the backscattered signals could be received wirelessly using other antennas. Researchers have further tried to determine the direction of the strain induced in the structure. However, at present, it seems the work in this field is just starting. This section presents the recent techniques employed for wireless strain and damage monitoring which utilise resonators or antennas as strain sensors.

Das, Khorrani, and Nourbakhsh (1998) designed a novel sensor/actuator system which utilizes a patch antenna with a multilayer substrate (Figure 11). The multilayer consists of a dielectric layer and a piezoelectric layer. The piezoelectric layer is the sensing unit which converts the measured strain/vibration into voltage. The antenna receives wireless EM signal from the base station and generates a voltage which gets added up to the

piezoelectric voltage and this modulated signal is transmitted back to the base station. This antenna can also be used for actuating the piezoelectric layer by supplying the required voltage to the piezoelectric by receiving wireless electromagnetic power. Das et al. (1998) developed a dielectric-piezoelectric grating technique to distinguish sensing and actuating activities. Due to this grating technique, the sensing and actuating functions are activated separately using orthogonal polarization orientation techniques. It is also feasible to stack such microstrip patch antennas with dimensions to operate at different frequencies. This sensor integrates wireless power reception, sensing and data communication in one simple unit. However, this sensor could function well only when it is interrogated from a very close distance.

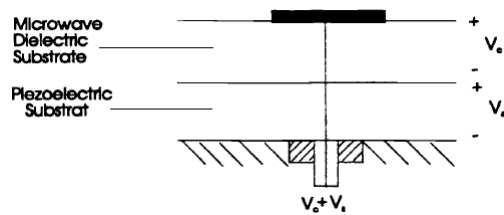

Figure 11. Microstrip antenna with Dielectric-Piezoelectric multilayer substrate (Das et al., 1998)

Loh, Lynch, and Kotov (2007) developed a wireless RFID based sensor by incorporating the field of nanotechnology. They utilized a layer by layer fabrication technique of Single Walled carbon Nano-Tube (SWNT) films. These films could act as a strain or a pH sensor because their capacitance or resistance changes accordingly. When these films are integrated with a coil antenna, they could be inductively coupled using a RFID reader and thus rendering the sensor completely wireless. Because these sensors act as a RLC oscillating circuit, the resonant frequency changes with the change in mechanical behaviour of the structure. Use of conducting carbon nanotube-gold nanocomposites as an inductor for wireless coupling was also investigated. However, the inductance was shown to be low, thereby limiting its wireless range to a very small distance. The size of the film sensor is $2.5 \text{ cm} \times 2.5 \text{ cm}$ and is stated to be sensitive and linear. Although this technique might be useful, it is believed that the manufacturing of such film nanocomposites could be expensive.

Matsuzaki, Melnykowycz, and Todoroki (2009) developed a very innovative technique for wireless detection of damage in CFRP. The CFRP structure (e.g. the wing structure) can be modeled as a half-wavelength dipole antenna (Figures 12 and 13). The resonant frequency of the antenna is dependent on the length of the structure. When there is a crack perpendicular to the fibre direction, the dipole length decreases and hence the resonant frequency increases. Therefore, by measuring the frequency, the length of the dipole could be back calculated. With the length value, the crack location could be precisely identified. This method can only be used in structures with a specific geometry and it can only detect the crack when the crack reaches its critical length.

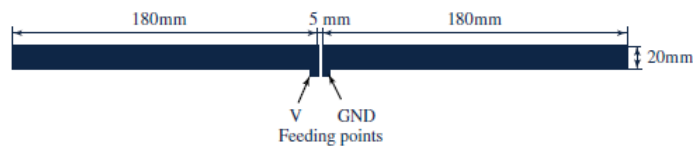

Figure 12. Simulation model of a rectangular dipole antenna (Matsuzaki et al., 2009)

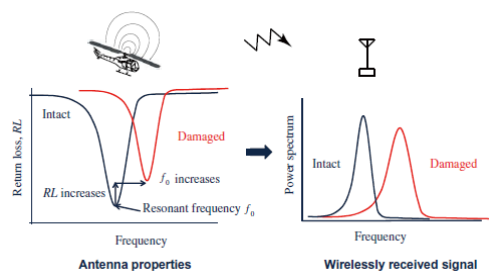

Figure 13. Schematic of the wireless crack detection mechanism (Matsuzaki et al., 2009)

Bhattacharyya, Floerkemeier, and Sarma (2009) investigated a RFID tag antenna sensor for displacement measurement (Figure 14). A simple RFID tag was kept at a very close distance to a metal surface which was attached to the structure. As the structure deforms, the metal surface comes closer to the RFID tag which affects the antenna's impedance and hence changes the backscattered power. It also affects the threshold power required to turn the RFID tag 'on'. This RFID tag can be queried wirelessly from a convenient location using an RFID tag reader/transmitter. By processing the backscattering from the RFID tag, the displacement of the structure could be evaluated. Although this sensor is very cheap and simple to design, there are certain challenges associated with this design. Obtaining the displacement data from backscattering becomes difficult if there are other metallic elements in the host structure. Due to the randomly moving metallic components, the sensor might give false positive results. Moreover, the sensor is sensitive to the displacements of the structure only in one direction. However, it is mentioned that this sensing technique could be optimized and utilized for an effective passive wireless displacement sensing system.

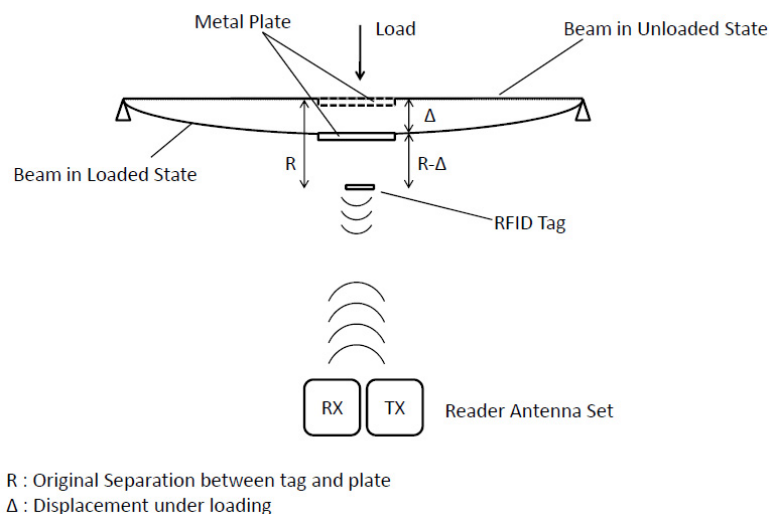

Figure 14. RFID sensor setup (Bhattacharyya et al., 2009)

Occhiuzzi, Paggi, and Marrocco (2011) proposed a meandered RFID tag sensor. This sensor can measure strain based on the change in the impedance and gain of the tag as a result of the deformation in the meandered line. This RFID tag requires an IC chip which increases the complexity of the structure. The shift in the power level as a result of the applied strain cannot be distinguished from the shift caused by other parameters that may influence the power transmitted (i.e. propagation path-loss, reflection, diffraction etc.). Caizzone and Marrocco (2012) further studied the application of this sensor in a RFID network grid to monitor the deformation of the structure. Their study shows that increasing the number of RFID tags does not further improve the sensitivity of the grid when the spacing between the sensors becomes lower than an optimum threshold.

Mandel, Schussler, and Jakoby (2011) proposed another concept for wireless passive strain measurement based on RFID tags principles. The proposed structure is composed of two layers of metal divided by a dielectric layer. The two metal layers are connected through the dielectric using an interconnecting via. This “mushroom structure” can be considered as a special case of a short-circuited microstrip patch antenna. One sensor structure comprised different elements, which were separated by gaps in the top metal layer and the substrate. The resonance frequency of each element is determined by the gap capacitance and the via inductance. Different fixed resonant frequencies can be used for identification purposes. The performance of this sensor was investigated using numerical simulations and experimental measurements. However, the linearity of sensor with applied strain is not discussed and further studies are required to quantify its performance.

Another recent study on RFID tags for passive wireless strain measurement was presented by Yi et al. (2011a). The sensor consists of a folded rectangular microstrip patch antenna with an IC chip. This passive wireless strain sensor operates based on a change in the impedance of the patch antenna as a result of the applied strain, which introduces a mismatch between the antenna and the IC package. When the EM power is sent wirelessly from a remote interrogator, the patch antenna receives the power and transfers it to the chip. This transfer from the tag to the chip is maxima when the interrogation frequency matches with the resonance frequency of the patch

antenna. The effect of changes in the impedance of the microstrip line between the rectangular patch and the IC was not considered in the model. The strain measurement was based on the change in the transmitted power which could also be affected by other factors. Due to the lack of sharpness in the transmitted power trace the exact resonant frequency of the RFID tag was difficult to ascertain. Hence, the resonant frequency of the tag was extracted using curve fitting techniques for the wireless strain measurements. Effect of antenna substrate thickness on the interrogation distance and strain transfer rate is further studied by Yi et al. (2011b).

Further investigations by Yi et al. (2012a) show that the shift in the resonant frequency of this sensor can be identified without the need for curve fitting for higher strain values ($>4997 \mu\epsilon$). Also, this sensor can be used for monitoring crack growth when the crack propagates in one direction through the sensor. Yi et al. (2012b) implemented this sensor in an array to measure strain in different locations wirelessly. It is shown that, using the RFID tag protocols, different sensors in the array can be activated individually with minimum interference with other neighbouring sensors.

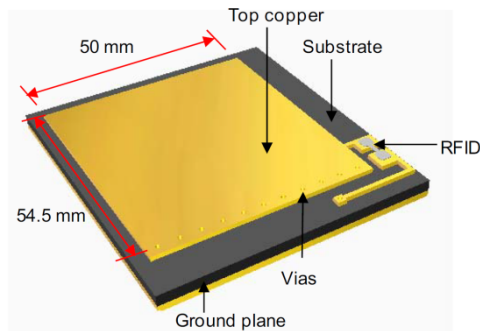

Figure 15. The RFID folded patch antenna strain sensor (Yi et al., 2012a)

Melik, Pergoz, Unal, Puttlitz, and Demir (2008) developed a passive on-chip RF-MEMS strain sensor for bio medical applications. As the material is stressed, the area of the sensor (spiral resonator) decreases thus its resonant frequency shifts. To make it completely wireless, two antennas of the same configuration were used for receiving and transmitting the signals. The micrograph of the fabricated sensor system is shown in Figure 16. This system is very small in size and has a very high quality factor.

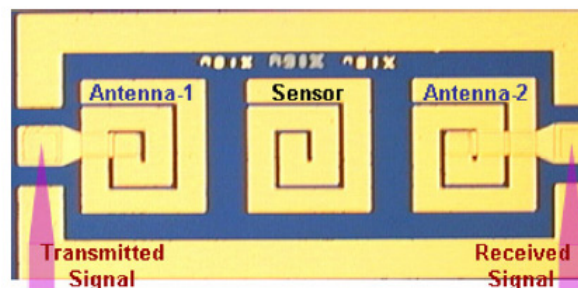

Figure 16. A plan-view micrograph of $270 \mu\text{m} \times 270 \mu\text{m}$ on-chip sensor along with the on-chip antennas for communication (Melik et al., 2008)

Melik, Unal, Perkgoz, Puttlitz, and Demir (2009a) published another paper which demonstrated the use of a metamaterial-based wireless strain sensor for bio-medical applications. Metamaterials are artificial materials engineered to provide properties which may not be readily available in nature. Since metamaterials are fabricated for specific requirements, they could have extremely useful electromagnetic properties. Split Ring Resonator (SRR) is one of the geometrical configurations used in the fabrication of metamaterials. Melik et al. (2009a) used SRRs instead of the spiral case (Melik et al., 2008) because they have more gaps between the rings. These gaps reduce during compression and increase during tension both changing the capacitance and thus shifting the resonant frequency. This sensor was designed to be used for monitoring fracture healing and other biomedical applications. Figure 17 shows the shift in the resonant frequency of the SRR sensor under compressive strain.

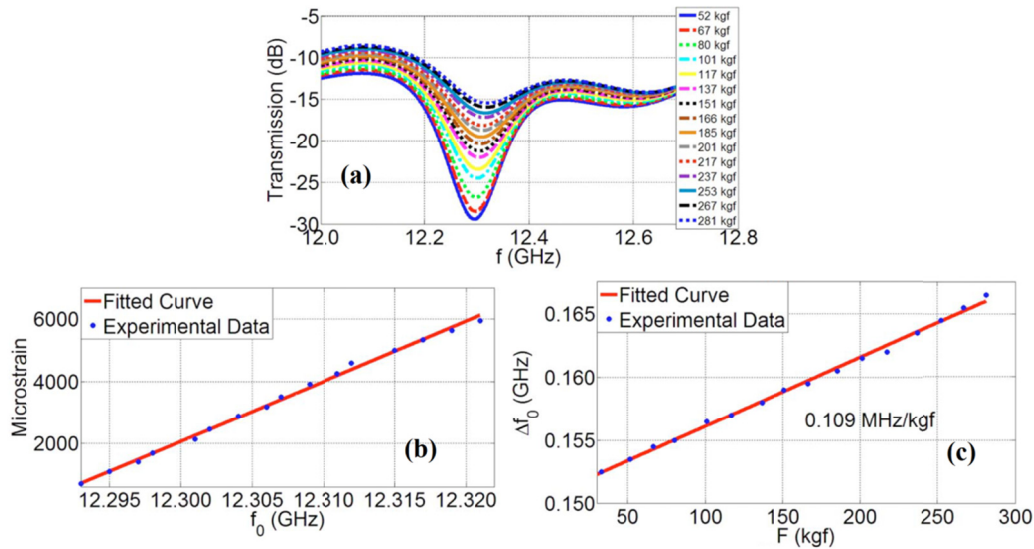

Figure 17. (a) Transmission spectra of the metamaterial strain sensor parameterized with respect to the external force, (b) the strain vs. the resonance frequency and (c) the resonance frequency shift vs. the applied force (Melik et al., 2009a)

Melik, Pergoz, Unal, Puttlitz, and Demir (2009b) reported that a flexible metamaterial sensor can be employed for effective strain measurement which could deliver greater sensitivity. These tape-based flexible SRR sensors also helped in reducing the non-linearity error. Figure 18 shows the step wise fabrication of this sensor. These tape-based flexible SRR sensors exhibit a significantly improved sensitivity level of 0.292 MHz/kgf with a substantially reduced nonlinearity error of 3% for externally applied mechanical loads up to 250 kgf. These resonators are very thin and hence could be bonded to the structure as a tape resulting in a very simple installation process.

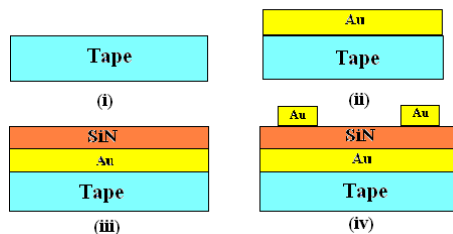

Figure 18. Fabrication procedure of the tape-based flexible sensor. 0.1 μm thick Au and Si3N4 deposited using lithography and lift off techniques (Melik et al., 2009b)

Melik, Unal, Pergoz, Puttlitz, and Demir (2010) presented telemetric sensing of surface strains on different industrial materials using SRR based metamaterials. For wireless strain sensing, they utilized metamaterial array architectures for high sensitivity and low nonlinearity errors. Telemetric strain measurements were performed by observing operating frequency shift under mechanical deformation and these data were compared with commercially-available wired strain gauges. It was shown that hard material (cast polyamide) show low slope in the frequency shift vs. applied load curve (corresponding to high Young's modulus), whilst soft material (polyamide) exhibit high slope (corresponding to low Young's modulus). Figure 19 compares the change in the resistance of a conventional strain gauge compared to the change in the resonant frequency of the SRR array for the same applied load. This figure shows the low non-linearity error in the SRR strain sensor.

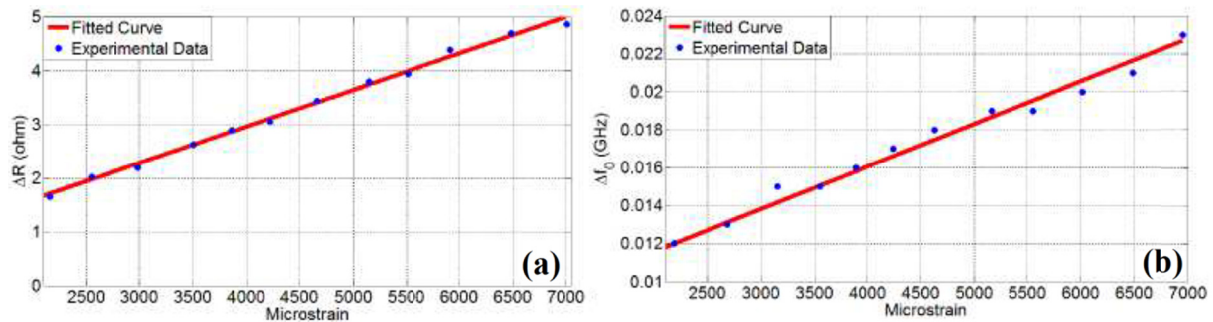

Figure 19. (a) Resistance change of the strain gauge and (b) Frequency change of the resonator with respect to the applied strain (Melik et al., 2010)

Other metamaterial resonator structures were also studied in the last few years, which follow the work by Melik and his colleagues. Ekmekci and Turhan-Sayan (2011) investigated the BC-SRR structure using numerical simulations. They suggested this sensor structure for applications such as pressure, temperature and humidity measurement. Li, Withayachumnankul, Chang, and Abbott (2011) extended this topic to terahertz frequencies. Again, the proposed resonator structures (I-shaped and crossed-I-shaped) were investigated using numerical simulations. Although these structures showed promising features, their performance has not yet been investigated using experimental measurements.

Naqui, Duran-Sindreu, and Martin (2011) introduced a resonator structure for position sensing applications. This structure consists of a SRR resonator at one side of a substrate material and a coplanar waveguide at the other side of the substrate. The principle of operation of this sensor is based on the symmetry of the resonator. When two rings of the resonator are rotated relative to each other, the resonance of the structure changes accordingly. This phenomenon was investigated theoretically and validated experimentally by fabrication and measurement of different SRR structures. However, in practice the sensor structure must be fabricated in a way to allow relative movement of two rings.

In a more recent study, Albishi, Boybay, and Ramahi (2012) proposed another metamaterial inspired resonator, Complementary-SRR (CSRR), as a sensor for crack detection. The structure of the proposed CSRR sensor is shown in Figure 20. The CSRR can be etched on a normal RF substrate and can be fed using a microstrip line behind the substrate. The CSRR has a stop band resonance which creates a strong electromagnetic field in the near field of the resonator. This resonant frequency shifts when the sensor is placed near a metallic structure with micro millimetre size surface crack compared to the same structure without any defects. Therefore, the resonant frequency of the CSRR can be used as an indicator for detection of crack in the structure. Experimental results from (Albishi et al., 2012) show the feasibility of crack detection using this sensor with high sensitivity. However, this sensor can only be used for near field measurements and required to be moved over the surface of the structure.

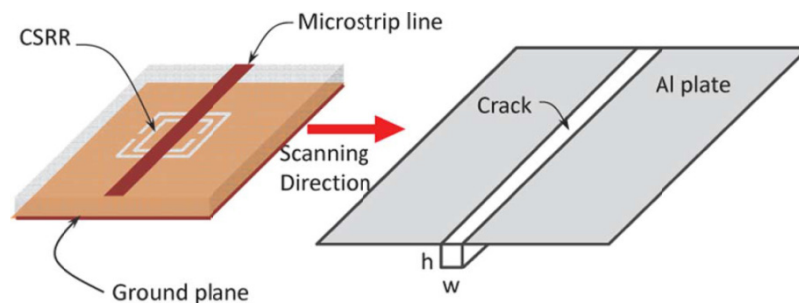

Figure 20. Schematic of the CSRR sensor and crack detection method (Albishi et al., 2012)

Tata, Huang, Carter, and Chiao (2009a) exploited a rectangular microstrip patch antenna for strain measurement. A rectangular patch antenna has the ability to resonate at two distinct frequencies, i.e. along its length and width. Thus it has the resonant frequencies f_{l0} and f_{w0} along its length and width, respectively (Figure 21). The resonant frequency is dependent on the electrical path length of the antenna. When the antenna is strained this length

changes and hence shifts the corresponding frequency (length or width depending on the direction of strain). The resonant frequency of the rectangular patch antenna can be derived as,

$$f_0 = C_1 / (L_{e0} + C_2 h_0) \quad (6)$$

Where f_0 is the unstrained resonant frequency; L_{e0} is electrical length; h_0 is height of the patch; and C_1 and C_2 are antenna constants. After applying strain,

$$f_\varepsilon = \frac{C_1}{L_{e0}(1 + \varepsilon_L) + C_2 h_0(1 - \vartheta \varepsilon_L)} \quad (7)$$

Where f_ε is the strained resonant frequency; ε_L is the applied strain; and ϑ is the antenna substrate Poisson's ratio.

Therefore, strain is derived as,

$$\varepsilon_L = C \frac{\Delta f}{f_\varepsilon} \quad (8)$$

The strain values can be calculated from the change in the resonant frequency. This sensor antenna was tested for a cantilever beam and the results were compared with analytical values. The resonant frequency of this antenna sensor was measured by connecting the antenna to a Vector Network Analyser (VNA) through a SMA connector and a coaxial cable.

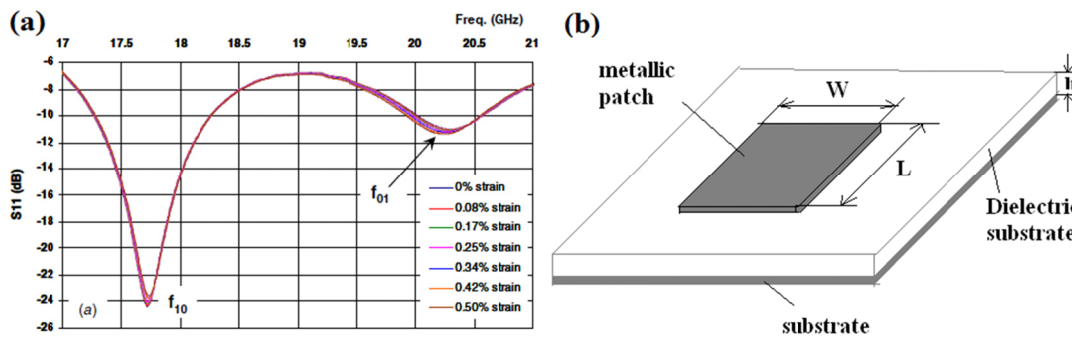

Figure 21. Rectangular microstrip patch antenna and its frequencies f_{10} and f_{01} (Tata et al., 2009a)

The technique required for wireless interrogation of microstrip patch antennas was introduced by Tata, Deshmukh, Chiao, Carter, and Huang (2009b) and Deshmukh, Mohammed, Tentzeris, Wu, and Huang (2009). In Tata et al. (2009b), the antenna sensor was excited by a dual polarized horn antenna which has polarizations along the length and width of the patch antenna to read both frequencies. Because the metallic host material also scatters the EM signals there are two scattering modes, namely the antenna and structural mode. A microwave switch was used which produced a phase shift of 180° to the antenna mode thereby normalizing and subtracting the structural mode for analysis. The experimental setup is illustrated in the Figure 22.

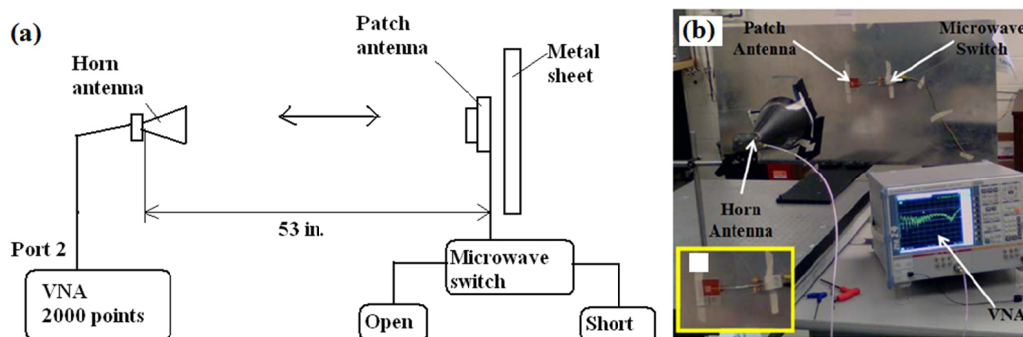

Figure 22. (a) Experimental setup diagram; (b) experimental setup (Deshmukh et al., 2009)

Deshmukh and Huang (2010) extended the previous work by utilizing a light activated microwave switch consisting of a pHEMT (pseudomorphic High Electron Mobility Transistor) and a photo cell to change the

terminating impedance of the antenna from open to short circuit. This change in circuit provides a 180° phase change and thereby helps in distinguishing the antenna backscattering mode from the structural backscattering mode. When the backscattering is measured using a horn antenna, a light beam is also sent to activate the switch in order to implement a phase change.

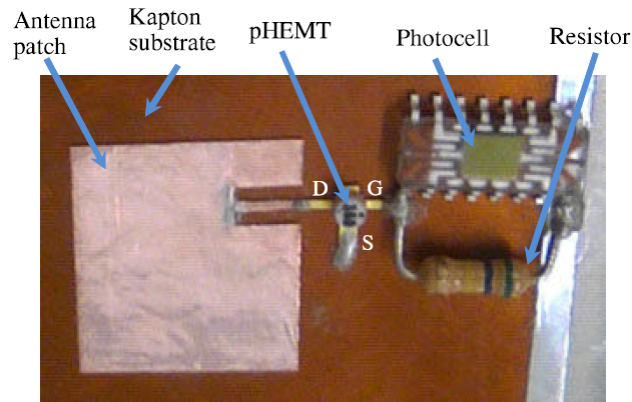

Figure 23. Passive antenna sensor with a light activated RF switch (Deshmukh & Huang, 2010)

Deshmukh and Huang (2010) studied the theoretical wireless interrogation range using the power budget model. The interrogation distance is,

$$R_{\max} = \frac{c}{4\pi f} \left[\frac{(D_{sd}D_{ds} + S_{11})P_t G_h^2 G_s^2}{NF \times SNR} \right] \quad (9)$$

Where c is the speed of light; f is the frequency; D_{sd} and D_{ds} are insertion losses due to the switch; $|S_{11}|$ is the scattering parameter; P_t is the transmitted power; NF is the noise factor; SNR is the signal to noise ratio; and G_h and G_s are gains of the horn and antenna sensor, respectively. This formula gives a good idea about the factors that affect the wireless interrogation range. The wireless range could be increased by increasing the transmitted power, antennas' gain, and reducing the SNR . It is mentioned that by increasing the interrogation power to 30 dBm and gain of the horn antenna to 20 dB, the interrogation distance could be up to 3.5 m.

Deshmukh et al. (2009), Erdmann, Deshmukh, and Huang (2010) and Mohammad and Huang (2010) tried to employ the rectangular patch antenna for sensing of fatigue crack growth. The patch antenna was placed on the crack in a lap joint structure and the shift in the resonant frequency with respect to crack growth was investigated (Figure 24). The effect of the resonant frequency due to the plate on top of the antenna sensor was also studied.

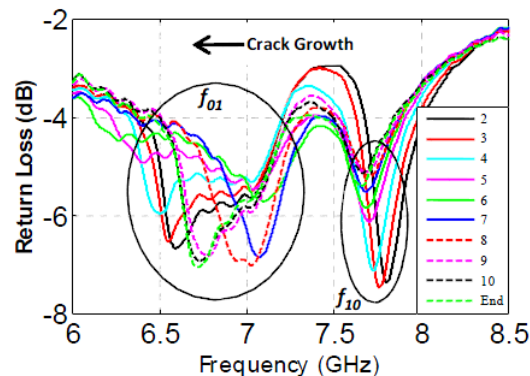

Figure 24. Shift of $|S_{11}|$ curves with crack growth (Erdmann et al., 2010)

The concept of crack detection using microstrip patch antennas was followed by Mohammad, Gowda, Zhai, and Huang (2012). Numerical simulations and experimental measurements were employed to detect the direction of the crack in the structure in addition of its presence. It was shown that a normalized frequency ratio (ratio of

frequencies of two modes of rectangular patch antenna) can represent a unique indication for crack orientation. However, cracks that are symmetric about the centre line of the patch antenna cannot be differentiated. Xu and Huang (2012) introduced multiplexing of dual-antenna arrays to cover a larger area of the structure for crack monitoring. A two-antenna array has two different frequencies and monitoring both antennas at the same time provides more information about the structure. However, the illuminating light must activate one antenna array each time to read the antenna information.

Daliri, Galehdar, John, Rowe, and Ghorbani (2010a) and Daliri, John, Galehdar, Rowe, and Ghorbani (2010b) developed a circular microstrip patch antenna (CMPA) strain sensor. It was shown that the resonant frequency of the CMPA is dependent on the radius of the patch antenna regardless of the material used as the substrate. Thus, as the material is strained, the resonant frequency shifts due to the change in the radius. The CMPA sensor was trialed on three different materials; namely aluminium, CFRP and glass fibre reinforced polymer (GFRP). The system was tested for different bending angles to determine the direction of strain. It was noted that depending on the strain along the magnetic or electrical plane of the antenna, the frequency shift was positive or negative. When the bending was in 45°, there was not much shift in the frequency. It was also interesting to note that in a GFRP plate, the frequency shift was not significant compared to aluminium and CFRP plates. The results showed that the antenna sensor is linear and effective in strain measurement. Computer simulations were carried out for 3-point bending of the antenna sensor on an aluminium plate and the shift in the frequency due to strain was determined. These values were compared with the experimental values and it was shown that these patch antennas could be employed as wireless strain sensors. The results showing the strain frequency shift relationship and the shift in the resonant frequency are shown in Figures 25, 26 and 27.

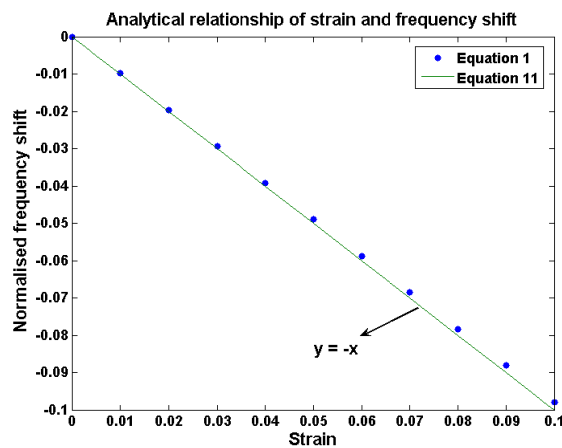

Figure 25. Linear (theoretical) relationship between strain and frequency shift (Daliri et al., 2010b)

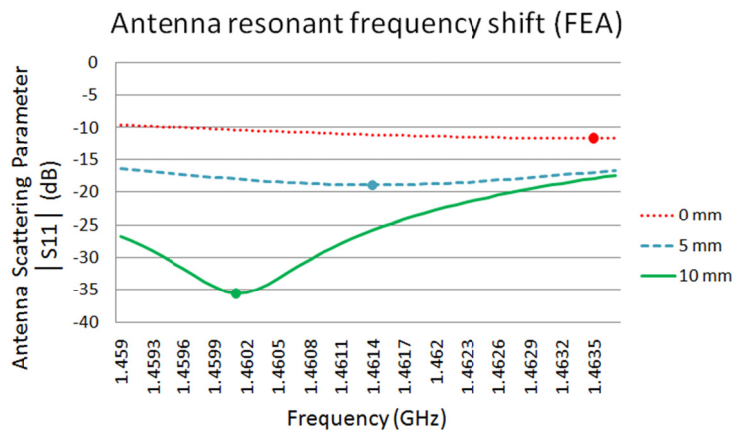

Figure 26. Simulation results of the antenna behaviour with 5 mm steps of bending (Daliri et al., 2010b)

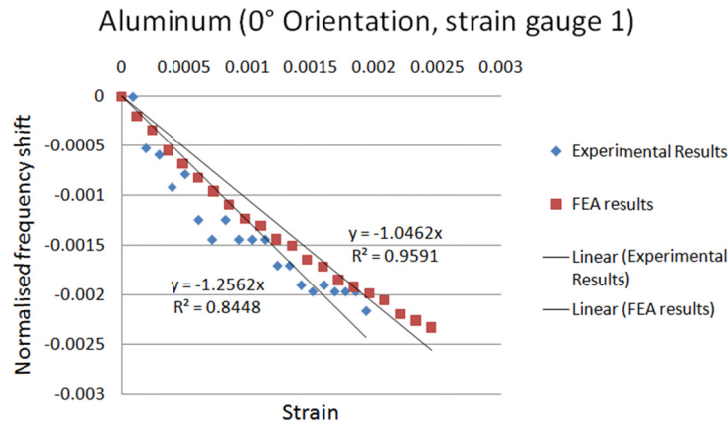

Figure 27. Comparison of measured and simulation results of strain and frequency shift for aluminium plate at 0° orientation (Daliri et al., 2010b)

Daliri, Galehdar, John, Rowe, and Ghorbani (2011a) studied the effect of slots in the CMPA on its directional capability and sensitivity. It was shown that introducing a slot in the CMPA introduces another resonant frequency which can help detect strain in two perpendicular directions. Also, this new sensor is more sensitive compared to a normal CMPA. To further tackle the directional problem of a normal CMPA, Daliri et al. (2011b) developed an omnidirectional CMPA strain sensor by introducing several slits on the edges of the CMPA. The resultant strain sensor is capable of measuring strain in all directions and it exhibits a five-fold reduction in the size of the antenna sensor and a three-fold increase in its sensitivity. A more comprehensive study on circular microstrip patch antennas is presented in (Daliri, Galehdar, Rowe, Ghorbani, & John, 2012a).

A slotted rectangular microstrip patch antenna (Salmani, Xie, Zheng, Zhang, & Zhang, 2011) and a rectangular microstrip patch antenna (Qian, Tang, Li, Zhao, & Zhang, 2012) have also been proposed to address sensitivity concerns in antenna strain sensors. Thai et al. (2011) introduced a novel idea to increase the sensitivity of microstrip patch antennas by adding an open loop to non-fed end of a rectangular microstrip patch antenna (Figure 28). The resonant frequency of the patch antenna depends on the impedance of the open loop, which can be altered by the loop length. However, the interference between the loop frequency and the antenna frequency may cause major problems. The manufacturing of this sensor requires special care.

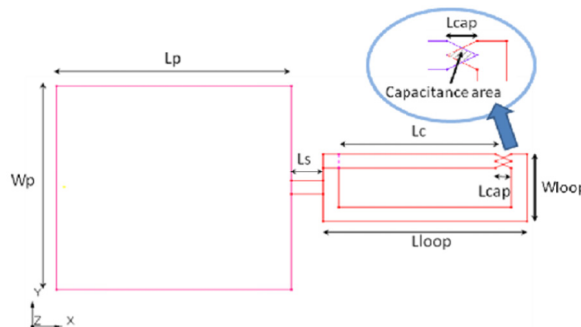

Figure 28. Details of the rectangular patch antenna design with an open loop (Thai et al., 2011)

Another example of using microstrip patch antennas for strain measurement is the application of multi-layer micro-fluidic stretchable radiofrequency electronics for wireless strain sensing (Cheng & Wu, 2011). A rectangular microstrip patch antenna fabricated using this technique was shown to be capable of measuring strain of up to 15% repeatedly based on the change in the strength of radio frequency (RF) signals emitted by the proposed antenna when connected to an RF transmitter. The RF transmitter is composed of miniaturized rigid active integrated circuits (ICs) and discrete passive components. This, with the addition of two AA batteries as a power source, increases the complexity and weight of the sensor unit, whilst decreasing its durability. Other concepts for strain measurement including printed dipole antennas (Jang & Kim, 2012) and dual-band microstrip patch antennas (Ahbe, Beer, Zwick, Wang, & Tentzeris, 2012) have also been proposed recently.

None of the above work on microstrip patch antenna strain sensors provided the answer for a passive wireless strain sensor which does not require additional integrated circuit units for wireless interrogation of the sensor. In the work by Deshmukh et al. (2009) and Tata et al. (2009a) the wireless interrogation of the rectangular patch antenna was achieved using an additional switch which requires wires or batteries. In the study of Deshmukh (2010) this switch was activated using a photo cell which further increases the complexity of the sensor unit and also requires a direct light source to activate the switch. In these works the resonant frequency of the patch antenna was read wirelessly; however, the strain was not measured. In other works on microstrip patch antennas a SMA connector was used to read the resonant frequency of the antenna sensor.

Daliri et al. (2012b) developed a method for wireless interrogation of CMPA strain sensors without the need for additional circuit elements. The CMPA was excited using a linearly polarised double ridged horn antenna to read its resonant frequency. This concept was studied using computational simulations and experimental measurements. The strain in aluminium and CFRP panels was measured wirelessly using this technique. However, the interrogation distance was limited to 5 cm. This technique also enables measuring strain in any desired direction because the linear horn antenna excites the CMPA in the direction of its polarization. By rotating the horn antenna the strain can be measured in the corresponding direction. Daliri et al. (2012c) further increased the interrogation distance of the CMPA sensor up to 20 cm by using a high quality factor CMPA. The high quality factor CMPA was developed using a substrate with low loss and high permittivity.

Regardless of the novelty and promising future of the discussed antenna sensor structures, there are certain key issues which have to be addressed to make these aforementioned works suitable for practical applications. Metamaterial sensors are very small and sensitive; however, they have not been employed to detect cracks till date and have practical limitations for monitoring strain in metallic structures. Moreover, there is not much information about the distance up to which these sensors could be wirelessly read. The work of Matsuzaki et al. (2009) involves the use of CFRP due to its good electrical conductivity. This technique cannot be extended to GFRP and other non-conducting structures.

Microstrip patch antenna sensors have been very useful in predicting the strain along with its direction. However, it is essential to design the antenna to be very sensitive to strain such that the shift in the frequency is more detectable. The wireless interrogation distance of these sensors needs to be improved significantly in order to make these sensors suitable for practical applications. Once these issues are addressed, these sensors could be installed in an array on the host structure for wireless SHM. Table 2 summarizes the important techniques that are provided in this section. Table 3 compares the various techniques covered in this article in general and in terms of important design parameters based on the authors' understanding of the sensor types. It is clearly evident from this table that each sensor type has its own advantages and limitations and no single technique has all the desirable properties.

Table 2. Various techniques investigated for use of resonators as strain sensors

Authors	Technique
Melik et al., 2009 a & b, 2010	Use of split rings, spirals and metamaterial based strain sensors whose resonant frequency changes due to the change in their dimensions.
Matsuzaki et al., 2009	Use of carbon fibres in the structure as a dipole antenna. The crack reduces the length of the dipole thereby shifting its frequency.
Tata et al., 2009 a & b; Deshmukh & Huang, 2010	Use of rectangular microstrip patch antennas whose resonant frequency changes with change in its dimension due to strain.
Daliri et al., 2010 a & b; 2011 a & b; 2012 a & b	Use of circular microstrip patch antennas whose resonant frequency changes with change in its dimension due to strain.
Yi et al., 2011 a & b; 2012 a & b	Use of rectangular microstrip patch antennas in combination with IC chips to form a RFID strain sensor whose resonant frequency changes with change in its dimension due to strain.

Table 3. Comparison of various types of sensors based on design parameters

Parameter	MEMS sensors	LC/RC circuit sensors	Antenna sensors
Power supply	Need battery for wireless monitoring.	LC circuits could receive power wirelessly. RC circuits need cables/wires.	Can receive power wirelessly from a transmitter antenna.
Active/Passive	Could be active and passive.	Could be active and passive	Passive.
Ability to detect strain direction	Could be designed to detect strain in any direction.	Generally unidirectional.	Could be designed to detect strain in any direction.
Wireless range	Can transmit signals over long distances.	Can transmit signals and receive power effectively only over few centimetres.	Has a small wireless range (< 1m).
Design complexity	Highly complex due to integration of various components.	Complex due to presence of inductor and capacitor integration.	Simple design due to the presence of only the antenna.
Size and weight	Large in size and heavy due to presence of battery and antenna.	Moderately large in size and less heavy compared to MEMS.	Smaller in size and much lighter compared to other sensors.

4. Conclusion

Structural health monitoring has been an important research area for the last few decades. The cumbersome use of wires to connect sensors with base stations has prompted researchers to investigate the feasibility of wireless SHM by incorporating various electromagnetic theories to overcome the limitations of the wired sensors.

Significant amount of research has been done in the field of MEMS systems and their application to SHM. Several different types of architectures with different specifications of microprocessors have been investigated. In order to address the power requirements of these sensing systems, few power harvesting techniques have also been investigated for effective functioning of these sensor systems. However, the design of such sensor units are relatively more complicated due to the incorporation of the sensing unit, signal conditioning unit, antennas and power harvesting devices. Thus, these sensors become expensive and the performance of these sensors has to be monitored regularly. In recent years, researchers have started using resonators and antennas as strain sensors where the resonant frequency of the resonator shifts due to the change in their dimensions during a structural deformation. These devices could be made small and simple which becomes elegant to install and read wirelessly. Moreover, the use of metamaterial based resonators could make these sensors very small thereby providing the feasibility for an array of sensors for damage monitoring.

In the use of patch antennas, along with the strain, the spatial orientation of the strain could also be wirelessly estimated which becomes crucial in terms of crack direction and growth prediction. However, the work on the use of resonators and antennas as sensors in SHM is presently at the embryonic stage. More effort towards these sensors could prove fruitful, especially work directed towards effective wireless SHM with good damage discrimination, sensitivity and linearity. It is envisaged that once these resonators or antennas can be designed to exhibit linear frequency shifts with strain, its utility can be extended to assess damage in structures, irrespective of the dielectric properties of the host structure. Given the comparative parameter-based assessment of the technologies discussed in this paper (in Table 3), it might be that the way ahead in wireless SHM should consist of a combination of the technologies discussed in this paper, since no single technique had all the desirable properties.

References

- Ahbe, D., Beer, S., Zwick, T., Wang, Y., & Tentzeris, M. M. (2012). Dual-band antennas for frequency-doubler-based wireless strain sensing. *IEEE Antennas and Wireless Propagation Letters, 11*, 216-219. <http://dx.doi.org/10.1109/LAWP.2012.2188014>

- Albishi, A. M., Boybay, M. S., & Ramahi, O. M. (2012). Complementary split-ring resonator for crack detection in metallic surfaces. *IEEE Microwave and Wireless Components Letters*, 22, 330-332. <http://dx.doi.org/10.1109/LMWC.2012.2197384>
- Anton, S. R., & Sodano, H. A. (2007). A review of power harvesting using piezoelectric materials. *Smart Materials and Structures*, 16, R1-R21. <http://dx.doi.org/10.1088/0964-1726/16/3/R01>
- Auwerker, H., & Peeters, B. (2003). International research projects on structural health monitoring: an overview. *Structural Health Monitoring*, 2(4), 341-358. <http://dx.doi.org/10.1177/147592103039836>
- Bhattacharyya, R., Floerkemeier, C., & Sarma S. (2009). Towards tag antenna based sensing – an RFID displacement sensor. *IEEE International Conference on RFID*. <http://dx.doi.org/10.1109/RFID.2009.4911195>
- Butler, J. C., Viglio, A. J., Vendi, F. W., & Walsh, S. M. (2002). Wireless passive resonant-circuit, inductively coupled, inductive strain sensor. *Sensors and Actuators A: Physical*, 102, 61-66. [http://dx.doi.org/10.1016/S0924-4247\(02\)00342-4](http://dx.doi.org/10.1016/S0924-4247(02)00342-4)
- Caizzone, S., & Marrocco, G. (2012). RFID-grids for deformation sensing. *IEEE International Conference on RFID*, 130-134. <http://dx.doi.org/10.1109/RFID.2012.6193040>
- Chang, F. K. (2002). *Structural Health Monitoring-the Demands and Challenges*. Boca Raton: CRC Press.
- Chang, P. C., Flatau, A., & Liu, S. C. (2003). Review paper: health monitoring of civil infrastructure. *Structural Health Monitoring*, 2(3), 257-267. <http://dx.doi.org/10.1177/1475921703036169>
- Cheng, S., & Wu, Z. (2011). A microfluidic, reversibly stretchable, large-area wireless strain sensor. *Advanced Functional Materials*, 21(12), 2282-90. <http://dx.doi.org/10.1002/adfm.201002508>
- Chuang, J., Thomson, D. J., & Bridges, G. E. (2005). Embeddable wireless strain sensor based on resonant RF cavities. *Review of Scientific Instruments*, 76, 094703-7. <http://dx.doi.org/10.1063/1.2051808>
- Daliri, A., Galehdar, A., John, S., Rowe, W. S. T., & Ghorbani, K. (2010a). Circular microstrip patch antenna strain sensor for wireless structural health monitoring. *World Congress of Engineering 2010*, London, U.K, 1173-1178.
- Daliri, A., Galehdar, A., John, S., Rowe, W. S. T., & Ghorbani, K. (2011a). Slotted circular microstrip patch antenna application in strain based structural health monitoring. *7th DSTO International Conference on Health & Usage Monitoring (HUMS 2011)*, Melbourne, Australia.
- Daliri, A., Galehdar, A., John, S., Rowe, W. S. T., Ghorbani, K., & Wang, C. H. (2011b). Multidirectional circular microstrip patch antenna strain sensor. *ASME Conference on Smart Materials, Adaptive Structures and Intelligent Systems (SMASIS2011)*. <http://dx.doi.org/10.1115/SMASIS2011-5065>
- Daliri, A., Galehdar, A., John, S., Wang, C. H., Rowe, W. S. T., & Ghorbani, K. (2012b). Wireless strain measurement using circular microstrip patch antennas. *Sensors and Actuators A: Physical*, 184, 86-92. <http://dx.doi.org/10.1016/j.sna.2012.07.003>
- Daliri, A., Galehdar, A., John, S., Wang, C. H., Rowe, W. S. T., & Ghorbani, K. (2012c). Wireless strain sensors using electromagnetic resonators, ASME Conference on Smart Materials. *Adaptive Structures and Intelligent Systems (SMASIS2012)*.
- Daliri, A., Galehdar, A., Rowe, W. S. T., Ghorbani, K., & John, S. (2012a). Utilising microstrip patch antenna strain sensors for structural health monitoring. *Journal of Intelligent Material Systems and Structures*, 23(2), 169-82. <http://dx.doi.org/10.1177/1045389X11432655>
- Daliri, A., John, S., Galehdar, A., Rowe, W. S. T., & Ghorbani, K. (2010b). Strain measurement in composite materials using microstrip patch antennas. *ASME Conference on Smart Materials, Adaptive Structures and Intelligent Systems (SMASIS2010)*. pp. 591-598. <http://dx.doi.org/10.1115/SMASIS2010-3703>
- Das, N. K., Khorrami, F., & Nourbakhsh, S. (1998). A new integrated piezoelectric-dielectric microstrip antenna for dual wireless actuation and sensing functions. *SPIE conference on Smart Electronics and MEMS*, San Diego, California. <http://dx.doi.org/10.1117/12.320163>
- Deshmukh, S., & Huang, H. (2010). Wireless interrogation of passive antenna sensors. *Measurement Science and Technology*, 21, 035201. <http://dx.doi.org/10.1088/0957-0233/21/3/035201>
- Deshmukh, S., Mohammed, I., Tentzeris, M., Wu, T., & Huang, H. (2009). Crack detection and monitoring using passive wireless sensor. *ASME conference on Smart Materials, Adaptive Structures and Intelligent Systems*,

- pp. 511-516. <http://dx.doi.org/10.1115/SMASIS2009-1326>
- Ekmekci, E., & Turhan-Sayan, G. (2011). Metamaterial sensor applications based on broadside-coupled SRR and V-Shaped resonator structures. *IEEE International Symposium on Antennas and Propagation (APSURSI)*, USA, 1170-1172. <http://dx.doi.org/10.1109/APS.2011.5996492>
- Erdmann, J., Deshmukh, S., & Huang, H. (2010). Microwave antenna sensors for fatigue crack monitoring under lap joints. *ASME conference on Smart Materials, Adaptive Structures and Intelligent Systems (SMASIS)*. <http://dx.doi.org/10.1115/SMASIS2010-3744>
- Housner, G. W., Bergman, L. A., Caughey, T. K., Chassiakos, A. G., Claus, R. O., Masri, S. F., ... Yao, J. T. P. (1997). Structural control: past, present and future. *Journal of Engineering Mechanics*, 897-971. [http://dx.doi.org/10.1061/\(ASCE\)0733-9399\(1997\)123:9\(897\)](http://dx.doi.org/10.1061/(ASCE)0733-9399(1997)123:9(897))
- Jang, S. D., & Kim J. (2012). Passive wireless structural health monitoring sensor made with a flexible planar dipole antenna. *Smart Materials and Structures*, 21, 027001. <http://dx.doi.org/10.1088/0964-1726/21/2/027001>
- Jia, Y., & Sun, K. (2006b). Thick film wireless and powerless strain sensor. *SPIE Smart Structures and Materials*, 6174, 1-11. <http://dx.doi.org/10.1117/12.660365>
- Jia, Y., Sun, K., Agosto, F. J., & Quinones, M. T. (2006a). Design and characterization of a passive wireless strain sensor. *Measurement Science and Technology*, 17, 2869-2876. <http://dx.doi.org/10.1088/0957-0233/17/11/002>
- Li, J., Withayachumnankul, W., Chang, S., & Abbott, D. (2011). Metamaterial-based strain sensors. *Proceedings of the 7th International Conference on Intelligent Sensors, Sensor Networks and Information Processing (ISSNIP)*, Australia, 30-32. <http://dx.doi.org/10.1109/ISSNIP.2011.6146571>
- Loh, K. J., Lynch, J. P., & Kotov, N. A. (2007). Passive wireless strain and pH sensing using carbon nanotube-gold nanocomposite thin films. *Proceedings of SPIE*, 6529. <http://dx.doi.org/10.1117/12.715826>
- Lynch, J. P., & Loh, K. J. (2006). A summary review of wireless sensors and sensor networks for structural health monitoring. *The Shock and Vibration Digest*, 38(91). <http://dx.doi.org/10.1177/0583102406061499>
- Mandel, C., Schussler, M., & Jakoby, R. (2011). A wireless passive strain sensor. *IEEE Sensors*, 207-210. <http://dx.doi.org/10.1109/ICSENS.2011.6126942>
- Matsuzaki, R., Melnykowycz, M., & Todoroki, A. (2009). Antenna/sensor multifunctional composites for the wireless detection of damage. *Composites Science and Technology*, 69, 2507-2513. <http://dx.doi.org/10.1016/j.compscitech.2009.07.002>
- Matsuzaki, R., & Todoroki, A. (2005). Wireless strain monitoring of tires using electrical capacitance changes with an oscillating circuit. *Sensors and Actuators A: Physical*, 119, 323-331. <http://dx.doi.org/10.1016/j.sna.2004.10.014>
- Matsuzaki, R., & Todoroki, A. (2006). Wireless detection of internal delamination cracks in CFRP laminates using oscillating frequency changes. *Composites Science and Technology*, 66, 407-416. <http://dx.doi.org/10.1016/j.compscitech.2005.07.016>
- Melik, R., Pergoz, N. K., Unal, E., Puttlitz, C., & Demir, H. V. (2008). Bio implantable passive on-chip RF-MEMS strain sensing resonators for orthopedic applications. *Journal of Micromechanics and Microengineering*, 18, 115017. <http://dx.doi.org/10.1088/0960-1317/18/11/115017>
- Melik, R., Pergoz, N. K., Unal, E., Puttlitz, C., & Demir, H. V. (2009b). Flexible metamaterials for wireless strain sensing. *Applied Physics Letters*, 95, 181105. <http://dx.doi.org/10.1063/1.3250175>
- Melik, R., Unal, E., Perkgoz, N. K., Puttlitz, C., & Demir, H. V. (2009a). Metamaterial-based wireless strain sensors. *Applied Physics Letters*, 95, 011106. <http://dx.doi.org/10.1063/1.3162336>
- Melik, R., Unal, E., Perkgoz, N. K., Puttlitz, C., & Demir, H. V. (2010). Metamaterial based telemetric strain sensing in different materials. *Optics Express*, 18(5). <http://dx.doi.org/10.1364/OE.18.005000>
- Mohammad, I., Gowda, V., Zhai, H., & Huang H. (2012). Detecting crack orientation using patch antenna sensors. *Measurement Science and Technology*, 23, 015102. <http://dx.doi.org/10.1088/0957-0233/23/1/015102>
- Mohammad, I., & Huang, H. (2010). Monitoring fatigue crack growth and opening using antenna sensors. *Smart Materials and Structures*, 19, 055023. <http://dx.doi.org/10.1088/0964-1726/19/5/055023>

- Naqui, J., Duran-Sindreu, M., & Martin, F. (2011). Novel sensors based on the symmetry properties of split ring resonators (SRRs). *Sensors*, 11(8), 7545-7553. <http://dx.doi.org/10.3390/s110807545>
- Occhiuzzi, C., Paggi, C., & Marrocco G. (2011). Passive RFID strain-sensor based on meander-line antennas. *IEEE Transactions on Antennas and Propagation*, 59(12), 4836-4840. <http://dx.doi.org/10.1109/TAP.2011.2165517>
- Qian, Z., Tang, Q., Li, J., Zhao, H., & Zhang, W. (2012). Analysis and design of a strain sensor based on a microstrip patch antenna. *International Conference on Microwave and Millimetre Wave Technology (ICMMT)*. <http://dx.doi.org/10.1109/ICMMT.2012.6230473>
- Salmani, Z., Xie, Y., Zheng, G., Zhang, H., & Zhang, H. (2011). Application of antenna in strain measurement. *International Workshop on Antenna Technology (iWAT): Small Antenna, Novel Structures and Innovative Metamaterials, Hong Kong: IEEE*, 336-339. <http://dx.doi.org/10.1109/IWAT.2011.5752311>
- Spencer, Jr. B. F., Ruiz-Sandoval, M. E., & Kurata, N. (2004). Smart sensing technologies: opportunities and challenges. *Structural Control and Health Monitoring*, 11(4), 349-368. <http://dx.doi.org/10.1002/stc.48>
- Tan, L. E., Pereles, B. D., Shao, R., Ong, J., & Ong, K. G. (2008). A wireless, passive strain sensor based on the harmonic response of magnetically soft materials. *Smart Materials and Structures*, 17(2), 025015. <http://dx.doi.org/10.1088/0964-1726/17/2/025015>
- Tata, U., Deshmukh, S., Chiao, J. C., Carter, R., & Huang, H. (2009b). Bio-inspired sensor skins for structural health monitoring. *Smart Materials and Structures*, 18(10), 104026. <http://dx.doi.org/10.1088/0964-1726/18/10/104026>
- Tata, U., Huang, H., Carter, R. L., & Chiao, J. C. (2009a). Exploiting a patch antenna for strain measurements. *Measurement Science and Technology*, 20, 015201. <http://dx.doi.org/10.1088/0957-0233/20/1/015201>
- Thai, T. T., Aubert, H., Pons, P., Plana, R., Tentzeris, M. M., & DeJean, G. R. (2011). A newly developed radio frequency wireless passive highly sensitive strain transducer. *IEEE Sensors*, 211-214. <http://dx.doi.org/10.1109/ICSENS.2011.6127239>
- Umbrecht, F., Wendlandt, M., Juncker, D., Hierold, C., & Neuenschwander, J. (2005). A wireless implantable passive strain sensor system. *IEEE Sensors*. <http://dx.doi.org/10.1109/ICSENS.2005.1597627>
- Wang, C. H., & Chang, F. K. (2005). Scattering of plane waves by a cylindrical inhomogeneity. *Journal of Sound and Vibration*, 282, 429-451. <http://dx.doi.org/10.1016/j.jsv.2004.02.023>
- Wang, C. H., & Rose, L. R. F. (2003). Wave reflection and transmission in beams containing delamination and inhomogeneity. *Journal of Sound and Vibration*, 264, 851-872. [http://dx.doi.org/10.1016/S0022-460X\(02\)01193-8](http://dx.doi.org/10.1016/S0022-460X(02)01193-8)
- Watters, D. G., Jayaweera, P., Bahr, A. J., & Huestis, D. L. (2001). Design and performance of wireless sensors for structural health monitoring. *Proceedings of Review of Progress in Quantitative Nondestructive Evaluation*, 21A, 969-976. <http://dx.doi.org/10.1063/1.1472901>
- Xu, X., & Huang, H. (2012). Multiplexing passive wireless antenna sensors for multi-site crack detection and monitoring. *Smart Materials and Structures*, 21, 015004. <http://dx.doi.org/10.1088/0964-1726/21/1/015004>
- Yi, X., Cho, C., Fang, C. H., Cooper, J., Lakafosis, V., Vyas, R., ... Tentzeris, M. M. (2012a). Wireless strain and crack sensing using a folded patch antenna. *6th European Conference on Antennas and Propagation (EUCAP)*, 1678-1681. <http://dx.doi.org/10.1109/EuCAP.2012.6206690>
- Yi, X., Fang, C. H., Cooper, J., Cho, C., Vyas, R., Wang, Y., ... Tentzeris, M. M. (2012b). Strain sensing through a passive wireless sensor array. *20th Analysis and Computation Specialty Conference*, 117-126. <http://dx.doi.org/10.1061/9780784412374.011>
- Yi, X., Wu, T., Lantz, G., Wang, Y., Leon, R. T., & Tentzeris, M. M. (2011b). Thickness variation study of RFID-based folded patch antennas for strain sensing. *Proceedings of SPIE Sensors and Smart Structures Technologies for Civil, Mechanical, and Aerospace Systems*. <http://dx.doi.org/10.1117/12.879868>
- Yi, X., Wu, T., Wang, Y., Leon, R. T., Tentzeris, M. M., & Lantz, G. (2011a). Passive wireless smart-skin sensor using RFID-based folded patch antennas. *International Journal of Smart and Nano Materials*, 2(1), 22-38. <http://dx.doi.org/10.1080/19475411.2010.545450>