

Review on thermal energy storage with phase change materials (PCMs) in building applications

D. Zhou¹, C. Y. Zhao^{1,2*}, Y. Tian¹,

¹School of Engineering, University of Warwick, CV4 7AL, UK

²School of Mechanical Engineering, Shanghai Jiaotong University, 200240, China

*corresponding author, c.y.zhao@warwick.ac.uk; changying.zhao@sjtu.edu.cn

Tel: +44(0)2476522339; +86 (0)21 34204541

ABSTRACT

Thermal energy storage with phase change materials (PCMs) offers a high thermal storage density with a moderate temperature variation, and has attracted growing attention due to its important role in achieving energy conservation in buildings with thermal comfort. Various methods have been investigated by previous researchers to incorporate PCMs into the building structures, and it has been found that with the help of PCMs the indoor temperature fluctuations can be reduced significantly whilst maintaining desirable thermal comfort. This paper summarises previous works on latent thermal energy storage in building applications, covering PCMs, the impregnation methods, current building applications and their thermal performance analyses, as well as numerical simulation of buildings with PCMs. Over 100 references are included in this paper.

Key words: Thermal energy storage; PCM; Thermal comfort; Building applications; Thermal performance

Published in: *Applied Energy* **92** (2012), pp. 593–605.

Doi: <http://dx.doi.org/10.1016/j.apenergy.2011.08.025>

D. Zhou, C.Y. Zhao, Y. Tian, “Review on Thermal Energy Storage with Phase Change Materials (PCMs) in Building Applications”, *Applied Energy* **92**, 2012, pp. 593–605

1. Introduction

Energy and environment are the two major issues facing human beings nowadays. Industrial developments and population boom in the past few centuries have resulted in an enormous increase in energy demand with an annual increasing rate at about 2.3%. Fig.1a and b, respectively, show the energy production from the year 1949 to 2009 and primary energy flow for the year 2009 in the United States [1]. From which we can see that on average, fossil fuels account for almost 80% of the total energy production. However the burning of fossil fuels brought the largest environmental issue ever, which is climate change caused by CO₂ emission. Still taking the United States as an example, the combustion of fossil fuels is responsible for more than 90% of all greenhouse gas emissions [2]. On this occasion, scientists had begun to research in renewable energy technologies in order to turn the tide of climate change and achieve a sustainable development for human beings.

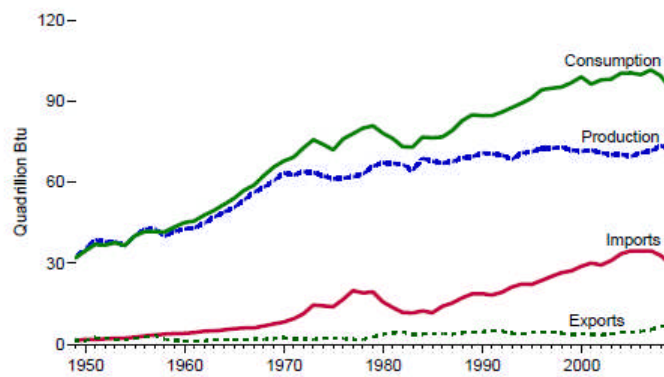

(a)

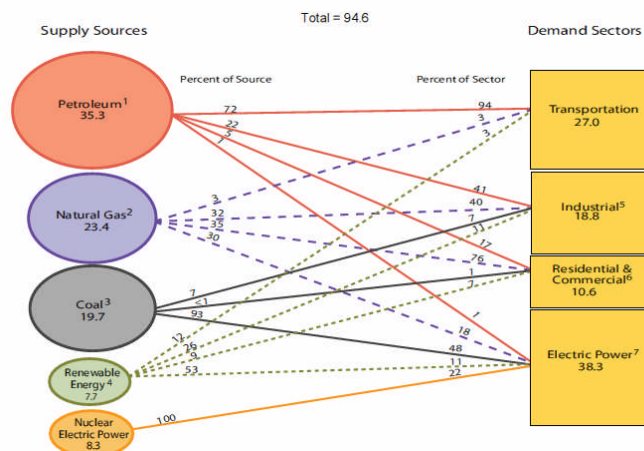

(b)

Fig. 1 (a) Primary energy production by sources of the United States; (b) Primary Energy Flow by Source and Sector for the year 2009 [2]

Building is one of the leading sectors of the energy consumption. In the year of 2009, around 40% of the total fossil energy was consumed in building sector in the United States and European Union [1]. Furthermore the energy consumption of heating, ventilation and air conditioning systems is still increasing with the increasing demand for thermal comfort. Under this circumstance, thermal energy storage systems with high potential to save energy in buildings have gained more and more attention. Thermal energy storage can be generally classified as sensible heat storage and latent heat storage according to the heat storage media. In sensible heat storage, the heat is stored or released accompanied with temperature change of the storage media, whereas in the latent heat storage the heat is stored or released as heat of fusion/solidification during phase change processes of the storage media. By contrast, latent heat storage with phase change materials (PCMs) provides a high heat storage density and has the capability of storing a large amount of heat during the phase change process with a small variation of PCM volume and temperature.

Using latent heat storage in the buildings can meet the demand for thermal comfort and energy conservation purpose. This review paper mainly focuses on latent thermal energy storage in building applications with Section 2 on the catalog of previous resources, Section 3 on PCMs, Section 4 on impregnation PCMs into conventional construction materials, Section 5 on the current building applications and thermal performance, as well as Section 6 on the numerical simulation for passive solar heating buildings with PCMs.

2. Summary of resources

Since the importance of sustainable energy has been noticed, many books on energy storage have been appeared; among of them few books [3-7] are mainly on low-temperature latent thermal energy storage. Dincer and Rosen [7] gave a general description of thermal energy storage, from the definition of fundamental parameters, thermal energy storage methods, energy and exergy analyses as well as numerical model and simulation of thermal energy storage. But in these books, the PCMs in building applications were not mentioned or were just apart of them.

In 1983, Abhat [8] first wrote a review on the low temperature latent heat storage systems, which gave a useful classification of PCMs. Following, more comprehensive reviews of latent heat storage systems and their applications have been made. Table 1 gives the relative reviews on the latent heat storage systems up to the present. Most reviews [8, 10, 11, 14, 17] mainly focused on the PCMs rather than the building applications. Hariri and Ward [9] presented the first review paper of using thermal storage system in building applications, which mainly from the theoretical aspects of sensible and latent heat storage. From 2007, some reviews on possible current building applications of thermal energy storage have been carried out [15, 16, 18, 19]. It is

apparently that there are a little of reviews on this topic in these two years, one about enhanced gypsum wallboard and enhance concrete technique [19] and one about the PCMs used for building applications [20]. However, during these two years many relative papers of using PCMs in buildings have been published and the technique of incorporation of PCMs with conventional materials has been improved a lot especially due to the development of microencapsulated PCMs. Furthermore, the thermal performance analysis from the simulation aspect, which is very crucial to the buildings design, was hardly to find out from the previous reviews.

Table 1 Catalog of Reviews on latent heat storage systems relative to building applications

Ref.	Journal	Year	Contents
[8]	Solar Energy	1983	Latent heat storage in temperature range 0-120°C was reviewed from the aspects of thermal properties and long term stability of different kinds of PCMs as well as corrosion problems.
[9]	Building and Environment	1988	Thermal storage system used in building applications was reviewed including sensible heat storage and latent heat storage, mainly from the theoretical aspect.
[10]	Applied Thermal Engineering	2003	A review on thermal energy storage was given from materials to applications. The numerical solutions considering conduction and convection were also involved.
[11]	Energy Conversion and Management	2004	The materials in general for thermal energy storage and main applications of PCMs were presented.
[12]	Energy Conversion and Management	2004	They gave a summary for the previous researches on incorporating PCMs into construction materials, such as concrete, gypsum wallboard, ceiling and floor.
[13]	Renewable and Sustainable Energy Reviews	2007	They summarized various methods of heating and cooling in buildings and latent heat storage applications for passive and active energy storage.
[14]	Renewable and Sustainable Energy Reviews	2007	Applications of solar energy were introduced from the following aspects: passive and active solar heating system, solar green house and solar cookers, They gave some operative principles of applying PCMs into the buildings, such as building envelops, under-floor electric heating and night ventilation. They also summarized current PCM applications in buildings. Most important, they gave a future outlook for this project.
[15]	Building and Environment	2007	
[16]	Renewable and Sustainable Energy Reviews	2008	They presented a detailed review on PCM incorporation in buildings for space heating and space cooling.

[17]	Renewable and Sustainable Energy Reviews	2009	They reviewed thermal energy storage from theoretical and numerical aspects and also gave the main applications of thermal energy storage.
[18]	Energy Conversion and Management	2009	The dynamic characteristics and thermal performance of the active and passive building applications were reviewed.
[19]	Energy and Buildings	2010	They reviewed the PCMs used for buildings and outlined the building applications such as enhanced gypsum wallboards, enhanced concrete and enhanced insulated materials.
[20]	Renewable and Sustainable Energy Reviews	2011	They gave a comprehensive review on the PCMs used in energy storage in the buildings, including thermophysical properties, long term stability, encapsulated technique and fire risk.

3. Phase change materials

3.1. Classification

Based on phase change state, PCMs fall into three groups: solid-solid PCMs, solid-liquid PCMs and liquid-gas PCMs. Among them the solid-liquid PCMs are most suitable for thermal energy storage. The solid-liquid PCMs comprise organic PCMs, inorganic PCMs and eutectics, seen in Fig. 2. A comparison of these different kinds of PCMs is listed in Table 2.

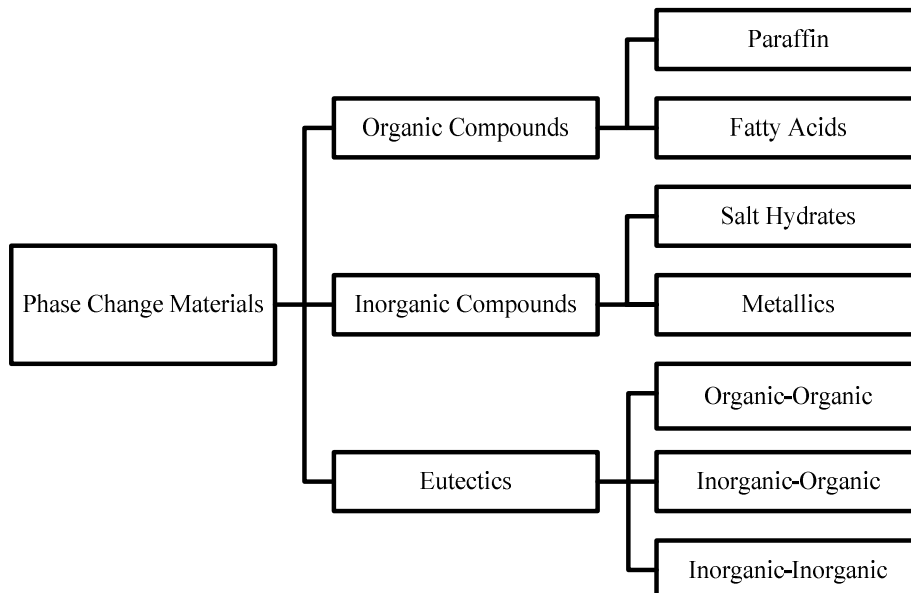

Fig.2 PCMs classification

Table 2 Comparison of different kinds of PCMs

Classification	Advantages	Disadvantages
Organic PCMs	<ol style="list-style-type: none"> 1. Availability in a large temperature range 2. High heat of fusion 3. No supercooling, 4. Chemically stable and recyclable 5. Good compatibility with other materials 	<ol style="list-style-type: none"> 1. Low thermal conductivity 2. Relative large volume change 3. Flammability
Inorganic PCMs	<ol style="list-style-type: none"> 1. High heat of fusion 2. High thermal conductivity 3. Low volume change 4. Availability in low cost 	<ol style="list-style-type: none"> 1. Supercooling 2. Corrosion
Eutectics	<ol style="list-style-type: none"> 1. Sharp melting temperature 2. High volumetric thermal storage density 	Lack of currently available test data of thermo-physical properties

3.2. Criteria of PCMs selection

The melting temperature and phase change enthalpy of existing PCMs are shown in Fig. 3 [21]. From the point of melting temperature it can be seen that for latent heat storage in building applications, the potential PCMs are paraffin, fatty acids, salt hydrates and eutectic mixtures.

To be a desirable material used in latent heat storage systems, the following criteria need to be met: thermodynamic, kinetic, chemical and economic properties, which are shown in Table 3 [8].

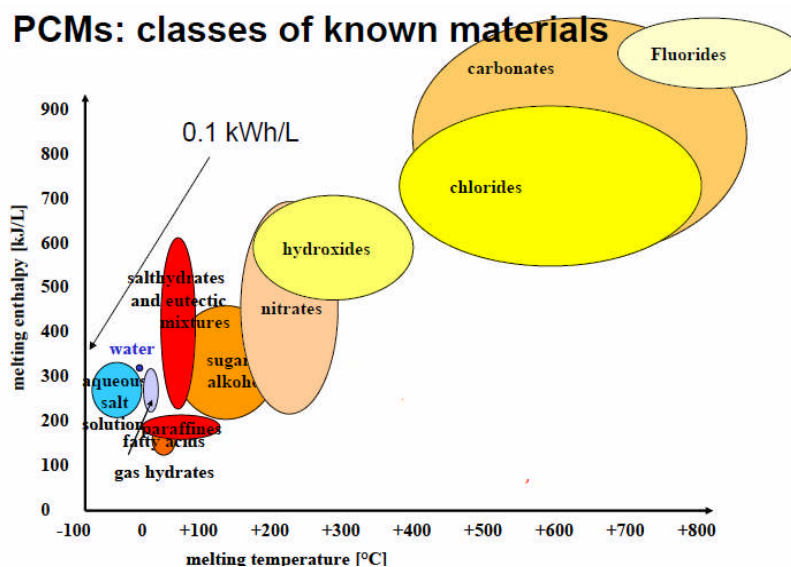

Fig. 3 Melting temperature and phase change enthalpy for existing PCMs [21]

Table 3 Selection criteria [8]

Thermodynamic Properties	① Melting temperature in desired range
	② High latent heat of fusion per unit volume
	③ High thermal conductivity
	④ High specific heat and high density
	⑤ Small volume changes on phase transformation and small vapor pressure at operating temperatures to reduce the containment problems
	⑥ Congruent melting
Kinetic Properties	① High nucleation rate to avoid super cooling
	② High rate of crystal growth to meet demands of heat recovery from the storage system
Chemical Properties	① Complete reversible freezing/melting cycle
	② Chemical stability
	③ No degradation after a large number of freezing/melting cycle
	④ No corrosiveness
	⑤ No toxic, no flammable and no explosive material
Economic Properties	① Effective cost
	② Large-scale availabilities

3.3. Measurement of thermal properties of PCMs

The process of selecting a suitable PCM is very complicated but crucial for thermal energy storage. The potential PCM should have a suitable melting temperature, desirable heat of fusion and thermal conductivity specified by the practical application. Thus, the methods of measuring the thermal properties of PCMs are very important. There are many existing measurement techniques, among which differential scanning calorimetry (DSC) and differential thermal analysis (DTA) are most commonly used.

3.3.1. Differential scanning calorimetry (DSC)

In DSC test, the sample and the reference (with known thermal properties) are maintained at the almost same temperature throughout measurement process, and by measuring the difference of heat added between the sample and the reference, many thermal properties of the sample can be obtained, such as heat of fusion, heat capacity and melting/solidification temperature.

The DSC method can also be used for analysing the thermal properties of PCM-wallboards. Through DSC test, not only can the melting temperature and heat of fusion of PCM be obtained, but also the distribution of PCM in wallboard, the heat storage capacity of PCM-wallboard and the effect of multiple thermal cycling on thermal properties of PCMs can be tested.

3.3.2. Differential thermal analysis (DTA)

In DTA test, the heat applied to the sample and the reference remains the same (rather than the temperature in DSC test). The phase change and other thermal properties can then be tested through the temperature difference between the sample

and the reference.

3.3.3. T-history method

Zhang et al. [22] analysed the limitations of conventional methods including conventional calorimetry, DSC and DTA, and then put forward a new method called T-history method to determine the melting temperature, degree of supercooling, heat of fusion, specific heat and thermal conductivity of PCMs. They made the measurement of some PCMs through this method and found a desirable agreement between their test results and experimental data available in literatures. Hong et al. [23] modified T-history method by improving some improper assumptions in the method by Zhang et al. [22]. Peck et al. [24] also improved this measurement method by setting the test tube horizontally which can minimise the temperature difference along the longitudinal direction of the test tube to get more accurate data from T-history method.

3.4. Thermal stability of PCMs

The long term stability of the PCMs is required by the practical applications of latent heat storage, and therefore there should not be major changes in thermal properties of PCMs after undergoing a great number of thermal cycles. Thermal cycling tests to check the stability of PCMs in latent heat storage systems were carried out for organics, salt hydrates and salt hydrates mixtures by many researchers [25-29]. Some potential PCMs were identified to have good stability and thermo-physical properties. Recently, Shukla et al. [30] carried out the thermal cycling tests for some organic and inorganic PCMs selected based on thermal, chemical and kinetic criteria shown in Table 1, and their results showed that organic PCMs tend to have better thermal stabilities than inorganic PCMs. Tyagi and Buddhi [31] conducted the thermal cycling test for calcium chloride hexahydrate and found minor changes in the melting temperature and heat of fusion, only about 1-1.5°C and 4% average variation respectively during the 1000 thermal cycles. They recommend the calcium chloride hexahydrate be a promising PCM for applications.

3.5. Potential PCMs for building applications

Thermal comfort can be defined by the operating temperature that varies by the time of the year. The ASHRAE (American Society of Heating, Refrigerating and Air-Conditioning Engineers) have listed suggested temperatures and air flow rates in different types of buildings and environmental circumstances. Normally, the suggested room temperature is 23.5°C- 25.5°C in the summer and 21.0°C-23.0°C in the winter. In the building applications, the PCMs with a phase change temperature (18-30°C) are preferred to meet the need of thermal comfort. Some potential PCMs are listed here, including organic PCMs, salt hydrates and eutectics, as well as commercial PCMs, seen as Table 4 and Table 5.

Table 4 Thermal properties of potential PCMs

PCMs	Type	Melting Temperature (°C)	Heat of fusion (kJ / kg)	Specific Heat (kJ / kg · K)	Thermal Conductivity (W / m · K)	Ref.
Paraffin C ₁₆ -C ₁₈	Organic	20-22	152	----	----	[6,10,13]
Paraffin C ₁₃ -C ₂₄	Organic	22-24	189	2.1	0.21	[6,10,13]
Paraffin C ₁₈	Organic	28	244	2.16	0.15	[6,10,13,17]
Butyl stearate	Organic	19	140	----	----	[6,10,13]
1-Dodecanol	Organic	26	200	----	----	[10,13]
n-Octadecane	Organic	28	200	----	----	[10]
Vinyl stearate	Organic	27-29	122	----	----	[6,10,13]
Dimethyl sabacate	Organic	21	120-135	----	----	[6,10,13]
Polyglycol E600	Organic	22	127.2	----	0.1897 (l)	[6,10,13]
45/55 capric + lauric acid	Organic eutectic	21	143	----	----	[6,10,13]
Propyl palmitate	Organic	19	186	----	----	[6,13]
Octadecyl						
3-mencaptopropylate	Organic	21	143	----	----	[6]
$KF \cdot 4H_2O$	Hydrate salts	18.5	231	1.84 (s) 2.39 (l)	----	[8,13]
$Mn(NO_3) \cdot 6H_2O$	Hydrate salts	25.8	125.9	----	----	[6,10]
$CaCl_2 \cdot 6H_2O$	Hydrate salts	29.7	171	1.45 (s)	----	[6,10,12]
$CaCl_2 \cdot 6H_2O + Nucleat + MgCl_2 \cdot 6H_2O(2:1)$	Inorganic eutectics	25	127	----	----	[6,10,13]
48% $CaCl_2$ + 4.3% $NaCl$ + 0.4% KCl + 47.3% H_2O	Inorganic eutectics	26.8	188	----	----	[6,10,13]

Table 5 Thermal properties of commercial PCMs [13, 16]

PCMs	Melting Temperature (°C)	Heat of fusion (kJ / kg)	Specific Heat (kJ / kg · K)	Thermal Conductivity (W / m · K)	source
RT 20	22	172	----	----	Rubitherm GmbH
RT 25	25	147	2.9(s) 2.1(l)	1.02(s) 0.56(l)	Rubitherm GmbH
RT 27	26-28	179	1.8 (s) 2.4 (l)	0.2	Rubitherm GmbH
STL 27	27	213	----	----	Mitsubishi Chemicals
Climsel C23	23	148	----	----	Climator
Climsel C24	24	216	----	----	Climator
S 27	27	190	1.5 (s) 2.22 (l)	0.79 (s) 0.48 (l)	Cristopia
TH 29	29	188	----	----	TEAP
SP 22 A 17	22	150	----	0.6	Rubitherm GmbH
SP 25 A 8	25	180	2.5	0.6	Rubitherm GmbH
SP 29	29	157	----	0.6	Rubitherm GmbH

3.6. Heat transfer enhancement

Most PCMs suffer from the common problem of low thermal conductivities, being around $0.2 \text{ W/m}\cdot\text{K}$ for paraffin wax and $0.5 \text{ W/m}\cdot\text{K}$ for hydrated salts and eutectics, which prolong the charging and discharging periods. Various techniques have been proposed to enhance the thermal conductivities of the PCMs, such as filling high-conductivity particles into PCMs [32], incorporating porous matrix materials into PCMs [33-38], inserting fibrous materials [39], as well as macro and micro encapsulating the PCMs [40, 41]

Bugaje [32] reported that the phase change time is one of the most important design parameters in latent heat storage systems and found adding aluminum additives into paraffin wax can significantly reduce the phase change time in heating and cooling processes. However, this method results in weight increasing and high cost of the system. Metal foams manufactured by sintering method, have many desirable characteristics such as low density, large specific surface area, high specific strength-to-density ratio as well as high thermal conductivity. All these desirable properties offered by metal foams make them to be promising in heat transfer enhancement for PCMs. Boomsma et al. [33] found using open-cell metal foams in compact heat exchangers generated thermal resistances twice and three times lower than the best commercially available heat exchanger tested. Thermal transport in high porosity open-cell metal foams was experimentally and numerically investigated in Ref. [34, 35], in which it is found that the effective thermal conductivity increases rapidly

as temperature increases and porosity decreases. Tian and Zhao [36] conducted a numerical and experimental investigation of heat transfer in PCMs enhanced by metal foams, and their experiment showed a significant increase of heat transfer rate. Their numerical simulations employed two-equation non-thermal equilibrium model to account for coupled heat conduction and natural convection, and a good agreement with experimental data was achieved. They reported that metal foams suppress natural convection whilst promoting heat conduction significantly, with the overall heat transfer rate still being higher than the pure PCMs. Py et al. [38] impregnated paraffin wax in a graphite matrix by employing capillary forces, and a high thermal conductivity and stable power output were observed. Fukai et al. [39] found carbon fibers improved the heat exchange rate during the charge and discharge processes even when the volume fractions of carbon fibers were only about 1%. Zhou et al. [42] carried out relevant experiments to compare the effects of metal foams and graphite materials on heat transfer enhancement, and the results indicate that both metal foams and expanded graphite can enhance heat transfer rate in thermal storage system, with metal foams showing a much better performance than expanded graphite.

4. Impregnation of PCMs into construction materials

4.1. Incorporation methods

4.1.1. Traditional methods

Hawes et al. [43] reported that the three most promising methods of PCMs to be incorporated in the conventional construction materials were direct incorporation, immersion and encapsulation. They also found that the melting and freezing temperatures of PCMs varied slightly when being incorporated in building materials.

(1) Direct incorporation: It is the simplest method in which liquid or powdered PCMs are directly added to building materials such as gypsum, concrete or plaster during production. No extra equipment is needed in this method but leakage and incompatibility with construction materials may be the biggest problems.

(2) Immersion: It is a technology in which the building structure components, such as gypsum, brick or concrete, are dipped into melted PCMs and then absorb PCMs into their internal pores with the help of capillary elevation. While some researchers pointed out this method may have a leakage problem which is not good for long-term use. Directly incorporation and immersion have different operation processes, but they both incorporate PCMs directly in conventional construction materials.

(3) Macroencapsulation: The technology with PCMs encapsulated in a container, for example, tubes, spheres or panels, is called macroencapsulation. The RUBITHERM[®] produces a kind of PCM panels called CSM modules which were made from aluminum with an efficient anti-corrosion coating, shown in Fig. 4 [44]. They can fit many commercial PCMs. With macroencapsulated PCMs, the leakage problem can be avoided and the function of the construction structure can be less affected. It has the disadvantages of poor thermal conductivity, tendency of solidification at the edges and complicated integration to the building materials.

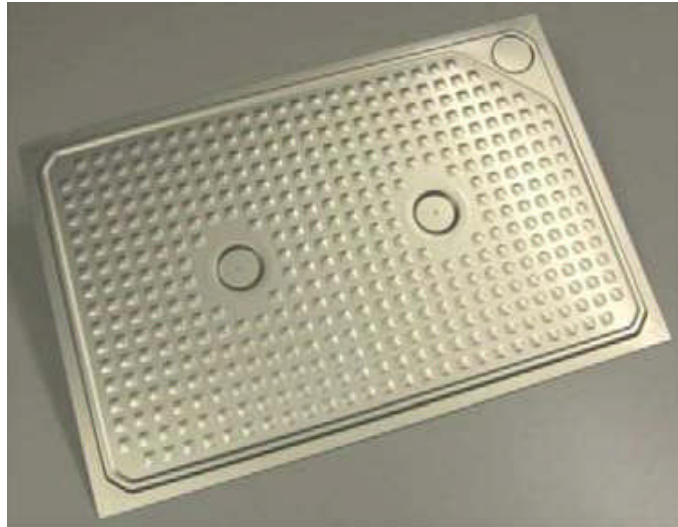

Fig. 4 CSM panel containing the PCM [44]

4.1.2. Microencapsulation

Nowadays, microencapsulated PCMs have been used in thermal energy storage of buildings. Microencapsulation is a technology in which PCM particles are enclosed in a thin, sealed and high molecular weight polymeric film maintaining the shape and preventing PCM from leakage during the phase change process. It is much easier and more economic to incorporate the microencapsulated PCMs into construction materials.

Hawllader et al. [45] conducted thermal analyses and thermal cycle tests on microencapsulated paraffin and found that the microencapsulated paraffin still kept its geometrical profile and heat capacity after 1000 cycles. Some researchers think that the microencapsulated PCMs incorporated in the buildings structures may affect the mechanical strength of the structure. Cabeza et al. [46] designed two concrete cubicles with the same shape and size, one with microencapsulated PCMs called Mopcon concrete and the other one without PCMs respectively, in order to find the possibility of using microencapsulated PCMs in construction materials to achieve sizable energy conservation without significantly decreasing the mechanical strength of the concrete structures at the same time. They found Mopcon concrete reached a compressive strength over 25MPa and a tensile splitting strength over 6MPa which had already met the requirements in general structural purpose. However, the applications of microencapsulated PCMs still need further investigation in the aspect of safety, such as fire retardation capability etc. Recently, National Gypsum produced a kind of wallboard panels with Mirconal PCM produced by BASF. This kind of panels is called National Gypsum ThermalCORE Panel, shown in Fig. 5. The melting point and latent capacity are 23 °C and 22 BTU/ft², respectively.

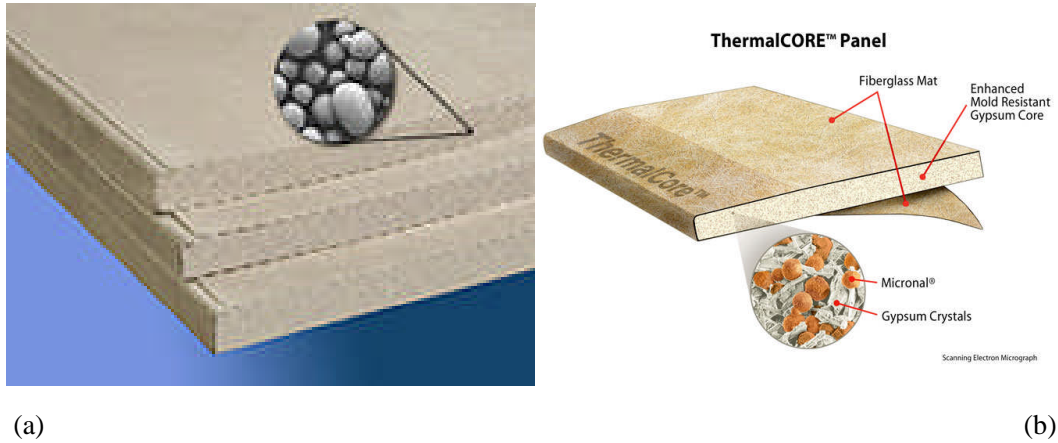

Fig. 5 (a) Gypsum wall board with Micronal® PCM (from BASF);
 (b) ThermalCORE phase-change drywall (from National Gypsum)

4.1.3. Shape-stabilised PCMs

Shape-stabilised PCMs, in which the PCM (like paraffin) is dispersed in another phase of supporting material (high density polyethylene etc.) to form a stable composite material., are attracting increasing attention due to their large apparent specific heat, suitable thermal conductivity, the ability to keep the shape of PCM stabilised in phase change process, as well as a good performance of multiple thermal cycles over a long period [47-49]. Zhang et al. [50] considered the shape-stabilised PCM, which is shown in Fig. 6, and found that it can make the thermal storage system simpler as it does not need special devices or containers to encapsulate the PCM. Based on the above benefits of this shape-stabilised PCM, they also proposed its potential application in efficient buildings used as inner linings, such as inner wall, ceiling and floor. Zhou et al. [51] simulated the thermal performance of a middle direct-gain room with the shape-stabilised PCM plates as inner linings and examined several influencing factors to thermal performance such as melting temperature, heat of fusion, location and board thickness of the shape-stabilised PCM. Their results indicated the PCM plates were advantageous in direct-gain passive solar houses.

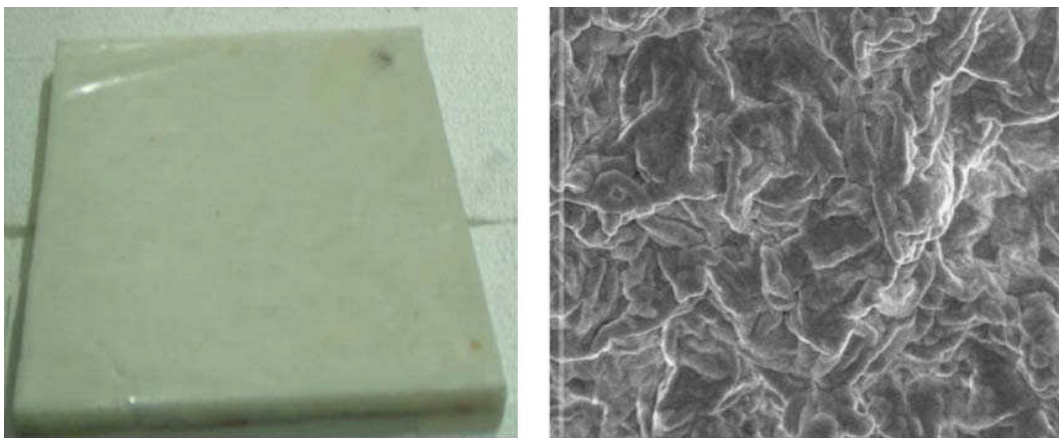

Fig. 6 Shape-stabilised PCM plate [50]

4.2. Containers

The conventional construction materials, such as gypsum board, concrete, brick and plaster, can be used to hold the PCMs. Some other panels, such as PVC panels, CSM panels, plastic and aluminium foils can also be used to encapsulated PCMs. Table 6 lists some containers for impregnating PCMs and the relative PCMs in literature.

Table 6 Materials for impregnating PCMs and the relative PCMs in literature

Ref.	Containers	PCMs	Percentage of PCMs
[52]	Gypsum board	Butyl Stearate	~ 25%
[53-55]	Gypsum board	Mixture of Butyl Stearate-Palmitate	~ 20%
[56, 57]	Gypsum board	Eutectic mixtures of capric acid and lauric acid	26%
[58]	PVC panel	Polyethylene glycol	----
[46]	Concrete	Micronal1PCM (from BASF)	----
[59]	Stainless steel panel	(48% CaCl ₂ + 4.3% NaCl + 0.4% KCl + 47.3% H ₂ O	----
[60,61]	Copolymer	Paraffin wax	60%
[44]	CSM panel with brick	RT27; SP 25 A 8	----
[62]	Gypsum board	MPCM 28D	23%, 30% 40%
[63]	Aluminium	Paraffin A22; Paraffin A26	----
[64]	Honeycomb panel	Mixture of Tetradecane and Octadecane	----
[65]	Concrete (Regular block; Autoclaved block)	Butyl stearate (Autoclaved block)	5.6%
		Unicere 55 (Autoclaved block)	8.6%
		Unicere 55 (Regular block)	3.9%

5. Current applications and thermal performance

5.1. PCM wallboard

PCM wallboard is considered to be an effective and less costly replacement of standard thermal mass to store solar heat in buildings, in which the PCM is imbedded into a gypsum board, plaster or other building structures. The thermal characteristics of PCM wallboard are very close to those of PCMs alone, and when a PCM wallboard is cut, a greater concentration of PCM lies in the outer third of the wallboard thickness near each face due to the diffusion process [52].

Scalat et al. [55] considered that using PCM wallboard could maintain room temperature within the human comfort zone for longer periods of time after the heating or cooling system was shut off. Athienitis et al. [52] used a gypsum board impregnated with a PCM in a direct-gain outdoor test room to investigate the thermal performance of PCM gypsum board used in a passive solar building. The results showed that the room temperature can be reduced by a maximum 4°C during the daytime. Neepser [66]

impregnated fatty acid and paraffin waxes into the gypsum wallboard and examined the thermal dynamics under the diurnal variation of room temperature (the radiation absorbed was not considered) with the PCM on interior partition and exterior partition respectively. Their investigation indicated that when the PCM's melting temperature was close to the average room temperature the maximum diurnal energy storage occurred and diurnal energy storage decreased if the phase change transition occurred over a range of temperature.

In order to evaluate the capacity of PCM to stabilise the internal environment when there were external temperature changes and solar radiations, Kuznik et al. [60] designed an experimental test room MINIBAT using a battery of 12 spotlights to simulate an artificial sunning and they got the results that the PCM wallboard can reduce the air temperature fluctuations in the room and enhance the natural convection mixing of the air, avoiding uncomfortable thermal stratifications. Kuznik and Virgone [61] also tested two identical test cells under two kinds of external temperature evolutions, heating and cooling steps with various slopes and sinusoidal temperature evolution with 24h period. They found there was time lag between indoor and outdoor temperature evolutions and the external temperature amplitude in the cell was reduced.

Lv et al. [57] built an ordinary room as well as a room using PCM gypsum wallboard in the northeast of China and they found that the PCM wallboards can attenuate indoor air fluctuation, reduce the heat transfer to outdoor air and have the function to keep warm. Recently, Kuznik [67] used Dupont de Nemours PCM wallboards for the renovation of a tertiary building and found they were really efficient if the outside temperature was varying in melting temperature by monitoring the building for a whole year.

Some researchers reported that using a vacuum isolation panel (VIP) in a wallboard can reduce the thermal loss and improve efficiency for lightweight buildings. Two test cells were designed by Ahmad et al. [58] and each cell consisted of one glazed face and five opaque faces insulated with VIPs. One of the cells was equipped with five PCM panels. The cross structure with PCM wallboard and VIP is shown in Fig. 7. The amplitude of temperature variation inside the cell with PCM panels was decreased by 20°C. So in the winter it helped to prevent negative indoor temperature efficiently. The PCM panels still showed a good thermal storage capability even after more than 480 thermal cycles.

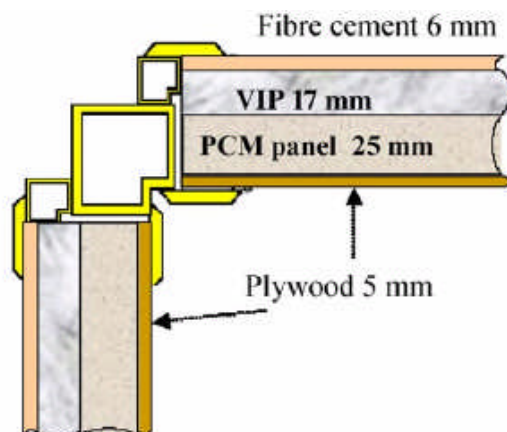

Fig. 7 Cross structure of PCM wallboard with VIP [58]

5.2. PCM walls

Another method of applying PCMs into building structures is to incorporate PCMs into concrete matrix or open cell cements. This composite is called thermocrete. Hawes et al. [68, 69] reported that concrete modification and PCM incorporation techniques greatly affected the thermal storage capacity after studying the thermal performance of PCMs in different types of concrete blocks. However, concrete strength was significantly reduced by application of PCMs [70]. Cabeza et al. [46] studied a new innovative concrete with PCM on thermal aspects in order to develop a product which would not affect the mechanical strength of the concrete wall. They set up two real size concrete cubicles to demonstrate the possibility of using microencapsulated PCM in concrete. They found that the concrete reached a compressive strength over 25 MPa and a tensile splitting strength over 6 MPa and no difference occurred in the effects of the PCM after 6 months of operation. Baetens et al. [71] reported that enhancing thermal mass of concrete buildings seemed better than the use of PCM wallboards; however, the high cost of PCMs was the biggest concern.

5.3. Floors and ceilings for passive solar heating

Investigations on PCM floors and PCM ceilings for passive solar heating have been carried out during past few years. Xu et al. [72] used shape-stabilised PCM floor in passive solar buildings and developed a model to analyse how various factors influence the thermal performance, such as, thickness of PCM layer, melting temperature, heat of fusion and thermal conductivity of PCM. They indicated that the heat of fusion and thermal conductivity of PCM should be larger than 120 kJ/kg and $0.5 \text{ W} / \text{m} \cdot \text{K}$ and thickness of shape-stabilized PCM plate should not be larger than 20mm.

Pasupathy and Velraj [73] studied the effect of the building with PCM panel on the roof from the aspect of the location and thickness. They recommended a double layer PCM to be incorporated in the roof to narrow indoor air temperature variation and to better suit for all seasons.

5.4. Shutters

Mehling [74] firstly presented his report at 8th Expert Meeting and Work Shop on the “Innovative PCM-technologies”. He recommended that the maximum shading temperature be delayed by 3 hours and room temperature be reduced by 2°C with the application of the PCM shutter. The photograph of PCM shutter is shown in Fig. 8.



Fig. 8 PCM shutter [74]

Active heating and night cooling use electrical or mechanical equipment to store heat for future use or cause air-movement for ventilation or cooling. In building applications, PCMs are often incorporated into the building envelopes such as wallboards, walls, floors, ceilings and shutters.

5.5. PCM ceilings for active heating and cooling

Ceiling boards incorporated with PCMs for air conditioning systems play an effective role on the peak shaving control. A research team working in the University of South Australia [75] have developed a roof-integrated solar air heating storage system in 1997, shown as Fig. 9. The latent heat storage unit, in which an existing corrugated iron roof sheet is used as solar collector, is to store heat during the day and supply the heat at night or when sunshine is unavailable.

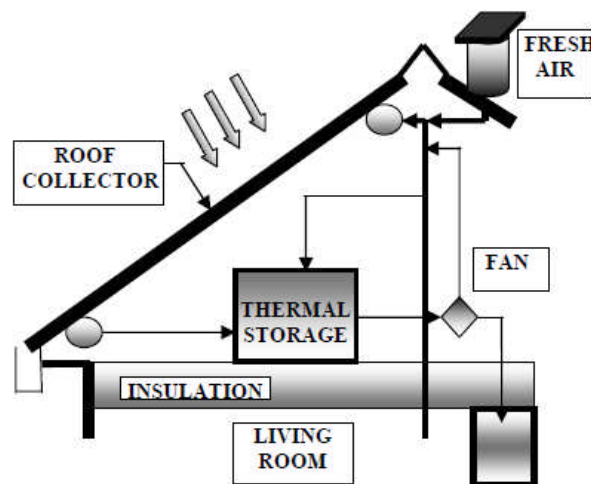

Fig. 9 Outline of a solar air heating storage system [75]

Kondo and Iwamoto [76] designed a rock wool PCM ceiling board with microcapsule PCMs for an office building. The outline of this system is pictured in Fig. 10. During the overnight thermal storage, the cool air from the AHU using cut-rate electricity flows into the ceiling chamber space and chills the PCM ceiling board.

During the normal cooling time, the cool air from the AHU flows directly into the room. During the peak shaving time, the air from the room returns to the AHU via the ceiling chamber space. When it passes through the PCM ceiling board, the warm air returning from the room is pre-cooled on its way back to the AHU. They found the load on air-handling unit (AHU) reduced during the peak shaving control period and also suggested the ceiling board needed improvement because of the flammability. Besides experimental analysis, many numerical works were also carried out on the thermal performance analyses of this system [77, 78].

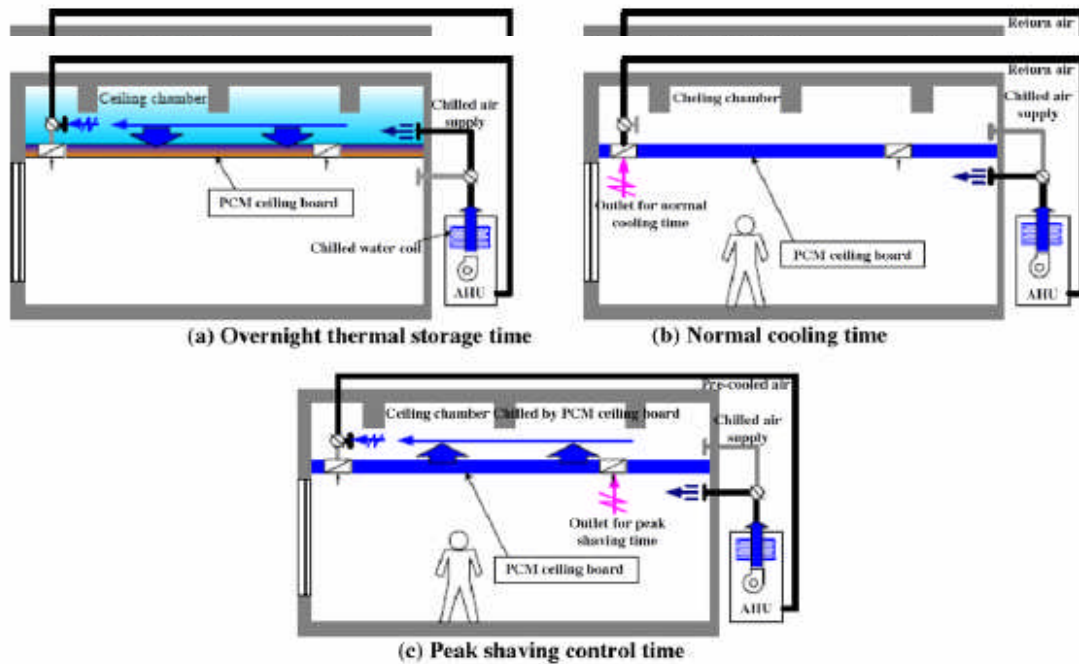

Fig. 10 Outline of the ceiling board system [76]

Koschenz and Lehmann [79] put forward a new concept of thermally activated ceiling panel for refurbished buildings. In this system, the mixture of microencapsulated PCM and gypsum was poured into a sheet steel tray which was used as a support for maintaining the mechanical stability of the panels. A capillary water tube system was applied to control the thermal mass. They tested the thermal performance of this system and indicated that only a 5cm layer of microencapsulated PCM and gypsum was enough for a standard office to keep within comfortable temperatures.

Another new approach proposed was that applying microencapsulated PCM slurry in cooled ceiling system. MPCM slurry worked as heat transfer and heat storage media. The flow and heat transfer characteristics of MPCM slurries have been investigated in recent years [80-84]. Wang and Niu [85] designed a combining system of cooled ceiling and MPCM slurry storage (Fig. 11) which was considered as the best one among three different systems: cooled ceiling combined with MPCM slurry storage, cooled ceiling with ice storage and cooled ceiling without thermal storage from both energy saving and cooling demand shifting aspects.

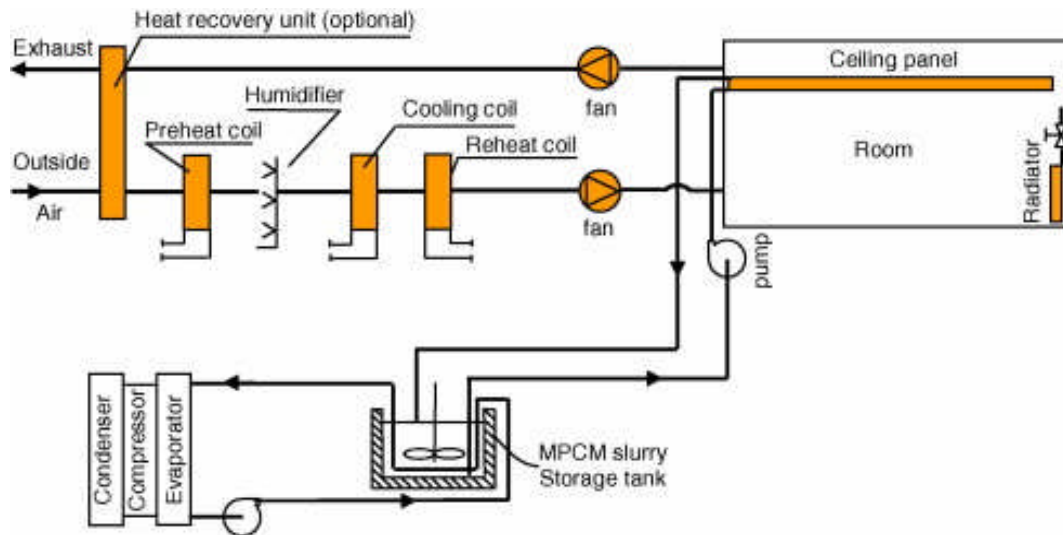

Fig. 11 Schematic diagram of cooled-ceiling integrated with MPCM slurry tank [85]

5.6. Under floor electric heating system with PCMs

Floor heating systems can be charged by using cheap night-time electricity and discharge the heat stored at the daytime. The shift of electricity consumption from peak periods to off-peak periods would provide significant economic benefits. Lin et al. [86] introduced an under-floor electric heating system with shape-stabilised PCM plates and ductless air supply, which really has good application feasibility. For the following work, they also built a model to analyse the thermal performance of this heating system as well as several influencing factors to the thermal performance in the system [87].

5.7. Night cooling

Free cooling is a concept developed for air conditioning applications, in which coolness is collected from ambient air during night and is released into the room during the hottest hours of the day. Vakilatojjar and Saman [88] developed a model to analyse the phase change storage system for air conditioning applications. They found smaller air gaps and thinner PCM slabs could deliver better thermal performance. Kang et al. [89] proposed a new kind of Night Ventilation with PCM Packed Bed Storage (NVP) system, shown in Fig. 12. At night, the outdoor air was blown through the latent heat thermal storage system to charge coolness to PCMs, whilst in the daytime the coolness was stored by PCMs at night.

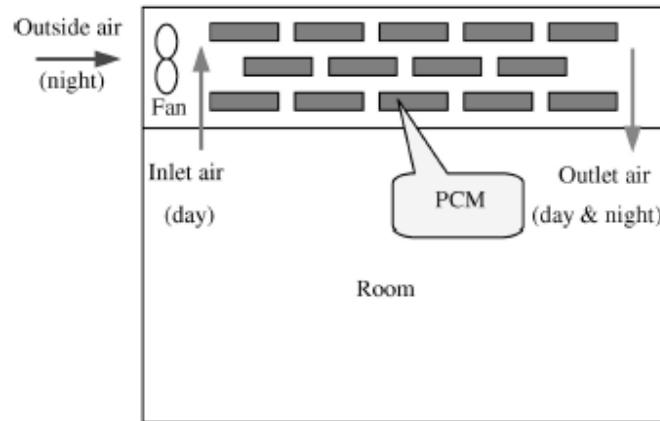

Fig. 12 Schematic diagram of NVP system [89]

6. Numerical simulation of buildings with PCMs

6.1 Parameters for evaluation

Thermal resistance R , heat storage coefficient S and index of thermal inertia D are considered to be the most commonly used parameters to evaluate the thermal performance of the buildings.

6.1.1. 'Time lag' and 'decrement factor'

For a passive solar heating buildings, the temperature variation at the inside surface is caused by the daily variation of outdoor temperature. The heat wave flows slowly through the wall causing a 'time lag' of the peak temperatures of outdoor surface and indoor surface. The decreasing rate of the heat wave amplitude is called 'decrement factor'. The 'time lag' and 'decrement factor', representing the thermal inertia, are of practical for the wall design [90]. Asan and Sancaktar [91] gave the schematics of 'time lag' and 'decrement factor', seen as Fig. 13 and also determined the detailed effects of thermal conductivity, heat capacity and wall thickness on them. Ulgen [92] found many parameters such as wall formations, positions and thermal behaviors can affect the 'time lag' and 'decrement factor' through lots of experiments and simulations. Kontoleon and Eumorfopoulou [93] made an investigation on the effect of wall orientation and solar absorptivity on 'time lag' and 'decrement factor' for different wall formations under the Mediterranean climate. The results showed that the optimum of wall thermal formations depended on the type and operation of the building, the desired comfort level, the presence or absence of air-conditioning units, the existing glazing surfaces as well as the outdoor environment

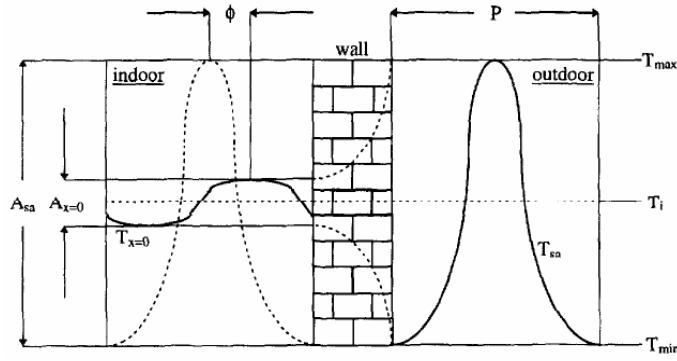

Fig. 13 The schematics of ‘time lag’ and ‘decrement factor’ [91]

6.1.2. Equivalent temperature difference

The total equivalent temperature difference (TETD), the function of the time lag, decrement factor and sol-air temperature, is a method for calculating cooling load due to heat gain from the walls or flat roofs. Kaşka et al. [94, 95] experimentally and numerically studied the ‘time lag’, ‘decrement factor’ and TETD of eight types of walls and two types of flat roofs in Turkey. They found the highest TETD values were obtained for the west direction due to the high outside air temperature and high solar radiation flux in the afternoon which is revealed in Fig.14. Antonopoulos and Koronaki [96, 97] considered that the effective thermal capacitance, the time constant and the thermal delay are the key parameters controlling the dynamic thermal behaviors of the buildings. They calculated them by using many numerical simulations, and also developed the correlations of these important parameters, in term of the thickness of the exterior wall layers, the surface percentage of brickworks or reinforced concrete parts.

6.1.3. U-value and R-value

The U -value, thermal transmittance, which is the inverse of R -value, can be obtained from handbooks and engineering calculations. Feuermann [98] thought the calculated values had a large uncertainty due to many assumptions made in the simulation and experimental determination of thermal transmittance might be needed. It is important to define some simple but effective models to estimate the actual U -value under certain condition. Detecting the wall thermal resistance is affected by actual conditions, such as solar radiation, wind speed, rainwater and wall humidity.

6.2. PCM walls design methodology

Peippo et al. [99] optimized the PCM in Finland and Wisconsin, based on the researches by Charach et al. [100] and Drake [101]. They found a phase change temperature of 1-3°C higher than the average room temperature can get optimal diurnal heat storage results. The optimal phase change temperature and thickness of the PCM panel are presented as following [100, 101]:

$$T_{m,opt} = \bar{T}_r + \frac{Q}{ht_{stor}} \quad (1)$$

$$D_{opt} = \frac{t_n h}{\rho \Delta H} (T_{m,opt} - T_n) \quad (2)$$

$$\bar{T}_r = \frac{t_d T_d + t_n T_n}{t_d + t_n} \quad (3)$$

Where $T_{m,opt}$ is optimal phase change temperature and D_{opt} is optimal thickness of the wall; Q is heat absorbed by unit area of the room surface; \bar{T}_r is the average room temperature; h is average heat transfer coefficient between wall surface and surroundings; ρ is the density of PCMs; ΔH is latent heat of fusion; T is the temperature and t is the time; the subscripts n and d represent night and daytime respectively.

A numerical process for the optimal thickness of PCM wallboard was performed by Kuznik et al. [102]. The work was based on a test case of a light-weight wall and a 24h period for temperature evolutions, with an optimal thickness of 1cm was presented. They also indicated the optimization should be made with considering the thermal dynamics of an entire room. Zhang and Xu [72] found the optimal phase change temperature was roughly equal to the average indoor air temperature of sunny winter days after studying the thermal performance of SSPCM floor. Neeper [66] also concluded the optimal phase change temperature equalled the average room temperature can achieve the maximum diurnal energy storage. Xiao et al. [103] presented the optimal phase change temperature not only depends on the indoor air temperature but also on the radiation absorbed by the PCM panels.

6.3. Numerical simulation for passive solar heating

Passive solar heating with PCMs is quite easy to realise with integrating the PCMs into the construction materials as part of building envelopes thus is the most widely used method to meet the thermal comfort. The simulations on thermal performance of the PCM walls were carried out in a number of studies [51, 58, 59, 99, 102, 104-111]. Table 7 is listed some simulation works on the PCM walls.

Table 7 Simulation works on the PCM walls

Ref.	PCM wallboards	Location	Modelling	Target
[99]	Plasterboard with 30% fatty-acid	Inside surface of south-facing room	A building energy simulation code FHOUSE	Optimal phase change temperature
[58]	Plasterboard with PEG 600	Wall	A numerical simulation with the TRNSYS software	Evaluating the efficiency of PCM wallboard with a vacuum insulation panel
[102]	Wallboard with 60% of micro-encapsulated	Wall of a lightweight building	In-house software CODYMUR	Optimization of PCM thickness

	paraffin			
[104]	Concrete with 25 wt% inorganic PCMs	Trombe wall	A CFD code 'SCIENCE'	Evaluating energy consumption
[105]	Gypsum compounds with fatty acids	Internal room lining	ESP-r program	Evaluating energy consumption.
[106]	Sandwich panels with PCMs	Prefabricated walls	A finite element numerical algorithm	Evaluating the energy performances of the panels
[107]	A kind of eutectic salts	Wall	VAR model	Estimation of the energetic improvements of using PCM dry walls
[108]	Randomly-mixed and laminated PCM drywalls	Wall	An implicit finite difference method based on the fixed mesh method	Assessing the thermal effectiveness of phase change drywalls
[59]	A stainless steel panel filled with PCM	Roof	Finite volume method is used in a mathematic model	Analysing the thermal performance of the roof of a building incorporating PCM
[51]	SSPCM	Inner surfaces and ceiling	An enthalpy model	Analysing thermal performance
[109]	----	Internal and external of the wall	A quasi-steady state method was used and two new parameters 'a' and 'Dt' were put forward	Analysing and evaluating the energy-efficient effects
[110]	ENERGAIN	Inside surface of an external wall	A new TRNSYS Type, Type 260	Evaluating thermal performance
[111]	Gypsum wallboard with RT 27	Wall	A mathematical model based on the Fourier heat conduction equation	Investigating the effect of different PCMs content to the thermal performance

7. Conclusion

In this paper, previous research works on thermal energy storage with PCMs for building applications have been reviewed. The PCMs to be used in buildings need to meet thermal comfort criteria, meaning the phase change temperature of PCMs should be between 18°C to 30 °C. In addition, the properties such as chemical stability, fire characteristics and compatibility with constructional materials also need to be considered in the PCMs selections. Latent heat storage with PCMs has been used in the walls, ceilings and floors, showing a significant impact on reducing the temperature fluctuation by storing the solar energy during the sunlight hours for passive solar

heating. It is also useful for off-peak thermal storage, ventilation and cooling. Some simulation works are also reviewed which can give guidance for PCM- buildings design. No matter from the experimental works or simulation works, it is clearly that incorporating PCMs into the building structures can significantly reduce the indoor temperature fluctuations. However further investigations still need to be carried out on the incorporation methods for PCMs to be embedded in existing building structures, long-term stability and any other problems which may affect the safety, reliability and practicability of the thermal energy storage used in buildings.

Acknowledgements

This work is supported by the UK Engineering and Physical Sciences Research Council (EPSRC grant number: EP/F061439/1) and National Natural Science Foundation of China (Grant No: 51071184).

References

- [1] U.S., Energy Information Administration, Office of Energy Markets and End Use, U.S., Department of Energy, Annual Energy Review 2009, August 2010.
- [2] U.S., Environmental Protection Agency. Inventory of U.S. Greenhouse Gas Emissions and Sinks: 1990-2008, U.S. EPA # 430-R-10-006, Washington DC, U.S.A., <http://www.epa.gov/globalwarming>.
- [3] Hadorn JC. Thermal energy storage for solar and low energy buildings. Universitat de Lleida; 2005.
- [4] Tom P. Hough. Solar energy: new research. Nova Science Publishers; 2006
- [5] Paksoy HO. Thermal energy storage for sustainable energy consumption: fundamentals, case studies and design. Kluwer Academic Publishers Group; 2007.
- [6] Mehling H, Cabeza LF. Heat and cold storage with PCM. An up to date introduction into basics and applications. Springer; 2008.
- [7] Dincer I, Rosen MA. Thermal energy storage: Systems and applications. John Wiley & Sons; 2010.
- [8] Abhat A. Low temperature latent heat thermal energy storage: heat storage materials. Solar Energy 1983; 30: 313-332.
- [9] Hariri AS, Ward IC. A review of thermal storage systems used in building applications. Building and Environment 1988, 23: 1-10.
- [10] Zalba B, Marin JM, Cabeza LF, Mehling H. Review on thermal energy storage with phase change: materials, heat transfer analysis and applications. Applied Thermal Engineering 2003; 23: 251-283.
- [11] Farid MM, Khudhair AM, Razack SAK, Al-Hallaj S. A review on phase change energy storage: materials and applications. Energy and Management 2004; 45: 1597-1615.
- [12] Kludhair AM, Farid MM. A review on energy conservation in building applications with thermal storage by latent heat using phase change materials. Energy

and Management 2004; 45: 263-275.

[13] Tyagi VV, Buddhi D. PCM thermal energy storage in buildings: A state of art. *Renewable and Sustainable Energy Review* 2007; 11: 1146-1166.

[14] Kenisarin M, Mahkamov K. Solar energy storage using phase change materials. *Renewable and Sustainable Energy Review* 2007; 11: 1913-1965.

[15] Zhang YP, Zhou GB, Lin KP, Zhang QL, Di HF. Application of latent heat thermal energy storage in buildings: State-of-the-art and outlook. *Building and Environment* 2007; 42: 2197-2209.

[16] Pasupathy A, Velraj R, Seeniraj RV. Phase change material- based building architecture for thermal management in residential and commercial establishments. *Renewable and Sustainable Energy Reviews* 2008; 12: 39-64.

[17] Sharma Atul, Tyagi VV, Chen CR, Buddhi D. Review on thermal energy storage with phase change materials and applications. *Renewable and Sustainable Energy Reviews* 2009; 13 (3): 318-345

[18] Zhu N, Ma Z, Wang S. Dynamic characteristics and energy performance of buildings using phase change materials: a review. *Energy Conversion and Management* 2009; 50: 3169-81.

[19] Baetens R, Jelle BP, Gustavsen A. Phase change materials for building applications: A state-of-the art review. *Energy and Buildings* 2010; 42: 1361-1368.

[20] Cabeza LF, Castell A, Barreneche C, de Gracia A, Fernandez AI. Materials used as PCM in thermal energy storage in buildings: A review. *Renewable and Sustainable Energy Review* 2011; 15: 1675-1695.

[21] Dipl.-Ing. Jens H. Dieckmann. Latent heat storage in concrete. University of Kaiserslautern, Germany, <http://www.eurosolar.de/>, 2006.

[22] Zhang YP, Jiang Y. A simple method, the T-history method, of determining the heat of fusion, specific heat and thermal conductivity of phase-change materials. *Measurement Sci. Technol.* 1999; 10: 201-205.

[23] Hong Hiki, Kim Sun Kuk, Kim Yong-Shik. Accuracy improvement of T-history method for measuring heat of fusion of various materials. *International Journal of Refrigeration* 2004; 27: 360-366.

[24] Peck Jong Hyeon, Kim Jae-Jun, Kang Chaedong, Hong Hiki. A study of accurate latent heat measurement for a PCM with a low melting temperature using T-history method. *International Journal of Refrigeration* 2006; 29: 1225-1232.

[25] Ting KC, Giannakakos PN, Gilbert SG. Durability of latent heat storage tube sheets. *Solar Energy* 1987; 39 (2): 79-85.

[26] Fernanda PG. Salt hydrate used for latent heat storage: corrosion metals and reliability of thermal performance. *Solar Energy* 1988; 41 (2): 193-197.

[27] Sharma SD, Buddhi D, Sawhney RL. Accelerated thermal cycle test of latent-heat storage materials. *Solar Energy* 1999; 66 (6): 483-490.

[28] Sharma A, Sharma SD, Buddhi D. Accelerated thermal cycle test of acetamide, stearic acid and paraffin wax for solar thermal latent heat storage applications. *Energy Convers Manage* 2002; 43 (14): 1923-1930.

[29] Kimura H, Junjiro K. Mixture of calcium chloride hexahydrate with salt hydrate or anhydrous salts as latent heat storage materials. *Energy Conversion and*

Management 1988; 28 (3): 197-200.

[30] Shukla A, Buddhi D, Sawhney RL. Thermal cycling test of few selected inorganic and organic phase change materials. *Renewable Energy* 2008; 33: 2606-2614.

[31] Tyagi VV, Buddi D. Thermal cycling testing of calcium chloride hexahydrate as a possible PCM for latent heat storage. *Solar Energy Materials & Solar Cell* 2008; 92: 891-899.

[32] Bugaje IM. Enhancing the thermal response of latent heat storage systems. *Int. J Energy Res* 1997; 21: 759-766.

[33] Boomsma K, Poulidakos D, Zwick F. Metal foams as compact high performance heat exchangers. *Mechanics of materials* 2003; 35: 1161-1176.

[34] Tian Y, Zhao CY. Heat Transfer Analysis for Phase Change Materials (PCMs). The 11th International Conference on Energy Storage (Effstock 2009), Stockholm, June 2009.

[35] Zhao CY, Lu W, Tian Y. Heat transfer enhancement for thermal energy storage using metal foams embedded within phase change materials (PCMs). *Solar Energy*, 2010, 84 (8): 1402-1412.

[36] Tian Y, Zhao CY. Thermal Analysis in Phase Change Materials (PCMs) Embedded with Metal Foams. International Heat Transfer Conference-14, 8-13 August, Washington, D. C., USA, 2010.

[37] Zhao CY, Zhou D, Wu ZG. Heat Transfer Enhancement of Phase Change Materials (PCMs) in Low and High Temperature Thermal Storage by Using Porous Materials. International Heat Transfer Conference-14, 8-13 August, Washington, D. C., USA, 2010.

[38] Py X, Olives R, Mauran S. Paraffin/porous graphite-matrix composite as a high and constant power thermal storage material. *International Journal of Heat Mass Transfer* 2001, 44: 2727-2737.

[39] Fukai J, Hamada Y, Morozumi Y, Miyatake O. Improvement of thermal characteristics of latent heat thermal energy storage units using carbon-fiber brushes: experiments and modeling. *International Journal of Heat and Mass Transfer* 2003; 46: 4513-4525.

[40] Chow LC, Zhong JK, Beam JE. Thermal conductivity enhancement for phase change storage media. *International Communications in Heat and Mass Transfer* 1996; 23 (1): 91-100.

[41] Sari A, Alkan C, Karaipekli A, Uzun O. Microencapsulated *n*-octacosane as phase change material for thermal energy storage. *Solar Energy* 2009; 83: 1757-1763.

[42] Zhou D, Zhao CY. Experimental Investigations on Heat Transfer in Phase Change Materials (PCMs) Embedded with Porous Materials. *Applied Thermal Engineering* 2011, 31: 970-977.

[43] Hawes DW, Feldman D, Banu D. Latent heat storage in building materials. *Energy and Buildings* 1993; 20: 77-86.

[44] Castell A, Martorell I, Medrano M, Perez G, Cabeza LF. Experimental study of using PCM in brick constructive solutions for passive cooling. *Energy and Buildings* 2010; 42: 534-540.

[45] Hawlader MN, Uddin MS, Zhu HJ. Encapsulated phase change materials for thermal energy storage: experiments and simulation. *International Journal of Energy Research* 2002; 26: 159-171.

[46] Cabeza LF, Castellon C, Nogues M, Medrano M, Leppers R, Zubillaga O. Use of

microencapsulated PCM in concrete walls for energy savings. *Energy and Buildings* 2007; 39: 113-119.

[47] Inaba H, Tu P. Evaluation of thermophysical characteristics on shape-stabilized paraffin as a solid-liquid phase change material. *Heat and Mass Transfer* 1997; 32 (4): 307-312.

[48] Xiao M, Feng B, Gong K. Preparation and performance of shape stabilizes phase change thermal storage materials with high thermal conductivity, *Energy Conversion and Management* 2002; 43: 103-108.

[49] Sari A. Form-stable paraffin/high density polyethylene composites as a solid-liquid phase change material for thermal energy storage: preparation and thermal properties. *Energy Conversion and Management* 2004; 45: 2033-2042.

[50] Zhang YP, Lin KP, Yang R, Di HF, Jiang Y. Preparation, thermal performance and application of shape-stabilized PCM in energy efficient buildings. *Energy and Buildings* 2006; 38: 1262-1269.

[51] Zhou GB, Zhang YP, Lin KP, Xiao W. Thermal analysis of a direct-gain room with shape-stabilized PCM plates. *Renewable Energy* 2008; 33: 1228-1236.

[52] Athienitis AK, Liu C, Hawes D, Banu D, Feldman D. Investigation of the thermal performance of a passive solar test-room with wall latent heat storage. *Building and Environment* 1997; 2 (5): 3405-410.

[53] Banu D, Feldman D, Hawes D. Evaluation of thermal storage as latent heat in phase change material wallboard by different scanning calorimetry and large scale thermal testing. *Thermochimica Acta* 1998; 317: 39-45.

[54] Feldman D, Banu D. DSC analysis for the evaluation of an energy storing wallboard. *Thermochimica Acta* 1996; 272: 243-251.

[55] Scalat S, Banu D, Hawes D, Paris J, Haghghata F, Feldman D. Full scale thermal testing of latent heat storage in wallboard. *Solar Energy Materials and Solar Cells* 1996; 44: 49-61.

[56] Lv SL, Zhu N, Feng GH. Eutectic mixture of capric acid and lauric acid applied in building wallboards for heat energy storage. *Energy and Buildings* 2006; 38: 708-711.

[57] Lv SL, Zhu N, Feng GH. Impact of phase change wall room on indoor thermal environment in winter. *Energy and Buildings* 2006; 38: 18-24.

[58] Ahmad M, Bontemps A, Sallée H, Quenard D. Thermal testing and numerical simulation of a prototype cell using light wallboards coupling vacuum isolation panels and phase change material. *Energy and Buildings* 2006; 38: 673-681.

[59] Pasupathy A, Athanasius L, Velraj R, Seeniraj RV. Experimental investigation and numerical simulation analysis on the thermal performance of a building roof incorporating phase change material (PCM) for thermal management. *Applied Thermal Engineering* 2008; 28: 556-565.

[60] Kuznik F, Virgone J, Roux JJ. Energetic efficiency of room wall containing PCM wallboard: A full-scale experimental investigation. *Energy and Buildings* 2008; 40: 148-156.

[61] Kuznik F, Virgone J. Experimental investigation of wallboard containing phase change material: Data for validation of numerical modeling. *Energy and Buildings* 2009; 41: 561-570.

[62] Lai CM, Chen RH, Lin CY. Heat transfer and thermal storage behaviour of

gypsum boards incorporating micro-encapsulated PCM. *Energy and Buildings* 2010; 42: 1259-1266.

[63] Gideon Susman, Zahir Dehouche, Tanawat Cheechern, Salmaan Craig. Test of prototype PCM 'sails' for office cooling. *Applied Thermal Engineering* 2011; 31: 717-726.

[64] Hasse C, Grenet M, Bontemps A, Dendievel R, Sallée H. Realization, test and modelling of honeycomb wallboards containing a phase change material. *Energy and Buildings* 2011; 43: 232-238.

[65] Lee T, Hawes DW, Banu D, Feldman D. Control aspects of latent heat storage and recovery in concrete. *Solar Energy Materials and Solar Cells* 2000; 62: 217-237.

[66] Neeper DA. Thermal dynamics of wallboard with latent heat storage. *Solar Energy* 2000; 68 (5): 393-403.

[67] Kuznik F, Virgone J, Johannes K. In-situ study of thermal comfort enhancement in a renovated building equipped with phase change material wallboard. *Renewable Energy* 2011; 36: 1458-1462

[68] Hawes DW, Banu D, Feldman D. Latent heat storage in concrete II. *Solar Energy Material* 1990; 21: 61-80.

[69] Hawes DW, Feldman D. Absorption of phase change materials in concrete. *Solar Energy Materials and Solar Cells* 1992; 27: 91-101.

[70] Bentz DP, Turpin R. Potential application of phase change materials in concrete technology. *Cement & Concrete Composites* 2007; 29: 527-532.

[71] Baetens R, Jelle BP, Gustavsen A. Phase change materials for building applications: A state-of-the-art review. *Energy and Buildings* 2010; 42: 1361-1368.

[72] Xu X, Zhang YP, Lin KP, Di HF, Yang R. Modeling and simulation on the thermal performance of shape-stabilized phase change material floor used in passive solar buildings. *Energy and Buildings* 2005; 37: 1084-1091.

[73] Pasupathy A, Velraj R. Effect of double layer phase change material in building roof for year round thermal management. *Energy and Buildings* 2008; 40: 193-203.

[74] Mehling Harald. Strategic project "Innovative PCM-Technology"---results and future perspectives, 8th expert meeting and work shop, Kizkalesi, Turkey, April 18-24, 2004.

[75] Saman WY, Belusko M. Roof integrated unglazed transpired solar air heater. Proc. of the 1997 Australian and New Zealand Solar Energy Society, Lee T. (ED). Paper 66, Canberra, Australia, 1997.

[76] Kondo T, Iwamoto T. Research on using the PCM for ceiling board. IEA ECESIA, Annex 17, 3rd workshop, Tokyo, Japan, 2002.

[77] Wakilaltojjar SM, Saman W. Analysis and modeling of a phase change storage system for air conditioning applications. *Applied Thermal Engineering* 2001; 21: 249-263.

[78] Saman W, Bruno F, Halawa E. Thermal performance of PCM thermal storage unit for a roof integrated solar heating system. *Solar Energy* 2005; 78: 341-349.

[79] Koschenz M, Lehmann B. Development of a thermally actived ceiling panel with PCM for application in lightweight and retrofitted buildings. *Energy and Buildings* 2004; 36: 567-578.

[80] Charunyakorn P, Sengupta S, Roy SK. Forced convection heat transfer in

microencapsulated phase change material slurries: flow in circular ducts. *Int. J. Heat Mass Transfer* 1991; 34 (3): 819-833.

[81] Hu XX, Zhang YP. Novel insight and numerical analysis of convective heat transfer enhancement with microencapsulated phase change material slurries: laminar flow in a circular tube with constant heat flux. *International Journal of Heat and Mass Transfer* 2002; 45: 3163-3172.

[82] Inaba H, Dai C, Horibe A. Natural convection heat transfer of microemulsion phase-change-material slurry in rectangular cavities heated from below and cooled from above. *International Journal of Heat and Mass Transfer* 2003; 46: 4427-4438.

[83] Zeng RL, Wang X, Chen BJ, Zhang YP, Niu JL, Wang XC, Di HF. Heat transfer characteristics of microencapsulated phase change material slurry in laminar flow under constant heat flux. *Applied Energy* 2009; 86: 2661-2670.

[84] Zhang GH, Zhao CY. Thermal and rheological property characteristics of PCM microcapsule slurry. 5th International Renewable Energy Storage Conference IRES 2010, Invited Keynote paper, Berlin, Germany.

[85] Wang XC, Niu JL. Performance of cooled-ceiling operating with MPCM slurry. *Energy Conversion and Management* 2009; 50: 583-591.

[86] Lin KP, Zhang YP, Di HF, Yang R. Study of an electrical heating system with ductless air supply and shape-stabilized PCM for thermal storage. *Energy Conversion and Management* 2007; 48: 2016-2024.

[87] Lin KP, Zhang YP, Xu X, Di HF, Yang R, Qin PH. Modeling and simulation of under-floor electric heating system with shape-stabilized PCM plates. *Building and Environment* 2004; 39 (12): 1427-1434.

[88] Vakilatogjar SM, Saman W. Analysis and modeling of a phase change storage system for air conditioning applications. *Applied Thermal Engineering* 2001; 21: 249-263.

[89] Kang YB, Jiang Y, Zhang YP. Modeling and experimental study on an innovative passive cooling system – NVP system. *Energy and Building* 2003; 35 (4): 417-425.

[90] Duffin RJ, Knowles G. A passive wall design to minimize building temperature swing. *Solar Energy* 1984; 33: 337-342.

[91] Asan H, Sancaktar YS. Effects of wall's thermophysical properties on time lag and decrement factor. *Energy and Buildings* 1998; 28: 159-166.

[92] Ulgen Koray. Experimental and theoretical investigation of effects of wall's thermophysical properties on time lag and decrement factor. *Energy and Buildings* 2002; 34: 273-278.

[93] Kontoleon KJ, Eumorfopoulou EA. The influence of wall orientation and exterior surface solar absorptivity on time lag and decrement factor in the Greek region. *Renewable Energy* 2008; 33: 1652-1664.

[94] Kaşka Önder, Yumrutaş Recep, Arpa Orhan. Theoretical and experimental investigation of total equivalent temperature difference (TETD) values for building walls and flat roofs in Turkey. *Applied Energy* 2009; 86: 737-747.

[95] Kaşka Önder, Yumrutaş Recep. Experimental investigation for total equivalent temperature difference (TETD) values of building walls and flat roofs. *Energy Conversion and Management* 2009; 50: 2818-2825.

- [96] Antonopoulos KA, Koronaki E. Envelope and indoor thermal capacitance of buildings. *Applied Thermal Engineering* 2000; 19: 743-756.
- [97] Antonopoulos KA, Koronaki E. Thermal parameter components of building envelop. *Applied Thermal Engineering* 2000; 20: 1193-1211.
- [98] Feuermann D. Measurement of envelope thermal transmittances in multifamily buildings. *Energy and Buildings* 1989; 13: 139-148.
- [99] Peippo K, Kauranen P, Lund PD. A multicomponent PCM wall optimized for passive solar heating. *Energy and Buildings* 1991; 17: 259-270.
- [100] Charach C, Zarmi Y, Zemel A. Simple method for assessing the thermal performance of PCM panels. *Proc. ISES Solar World Congress, Hamburg, 1987*; 1212-1216.
- [101] Drake JB. A study of the optimal transition temperature of PCM wallboard for solar energy storage. Report ORNL/TM-10210, Oak Ridge National Laboratory, 1987.
- [102] Kuznik F, Virgone J, Noel J. Optimization of a phase change material wallboard for building use. *Applied Thermal Engineering* 2008; 28: 1291-1298.
- [103] Xiao W, Wang X, Zhang YP. Analytical optimization of interior PCM for energy storage in a lightweight passive solar room. *Applied Energy* 2009; 86: 2013-2018.
- [104] Onishi J, Soeda H, Mizuno M. Numerical study on a low energy architecture based upon distributed heat storage system. *Renewable Energy* 2001; 22: 61-66.
- [105] Heim D, Clarke JA. Numerical modelling and thermal simulation of PCM-gypsum composites with ESP-r. *Energy and Buildings* 2004; 36: 795-805.
- [106] Carbonari A, Grassi MD, Perna CD, Principi P. Numerical and experimental analyses of PCM containing sandwich panels for prefabricated walls. *Energy and Buildings* 2006; 38: 472-483.
- [107] Grassi MD, Carbonari A, Palomba G. A statistical approach for the evaluation of the thermal behavior of dry assembled PCM containing walls. *Building and Environment* 2006; 41: 448-485.
- [108] Darkwa K, O'Callaghan PW. Simulation of phase change drywalls in a passive solar building. *Applied Thermal Engineering* 2006; 26: 853-858.
- [109] Zhang YP, Lin KP, Jiang Y, Zhou GB. Thermal storage and nonlinear heat transfer characteristics of PCM wallboard. *Energy and Buildings* 2008; 40: 1771-1779.
- [110] Kuznik F, Virgone J, Johannes K. Development and validation of a new TRNSYS type for the simulation of external building walls containing PCM. *Energy and Buildings* 2010, 42: 1004-1009.
- [111] Borreguero AM, Sánchez ML, Valverde JL, Carmona M, Rodríguez JF. Thermal testing and numerical simulation of gypsum wallboards incorporated with different PCMs content. *Applied Energy* 2011; 88:930-937.