

# Harmonic Analysis of Input Current of Single-Phase Controlled Bridge Rectifier

Michael McCarty      Taufik Taufik      Andre Pratama      Makbul Anwari  
 Electrical Engr. Dept.      Electrical Engr. Dept.      Electrical Engr. Dept.      Faculty of Electrical Engr.  
 Cal Poly State University      Cal Poly State University      Cal Poly State University      Univ. Teknologi Malaysia  
 San Luis Obispo, USA      San Luis Obispo, USA      San Luis Obispo, USA      81310 UTM, Malaysia

**Abstract**—Harmonic analysis of input current of single phase uncontrolled rectifier is widely known. However, little has been known about harmonic of the input current of single phase controlled or thyristor rectifier. This paper presents such an analysis using the bridge configuration for the controlled rectifier circuit. Results obtained from mathematical derivation, computer simulation, and hardware measurements will also be discussed.

**Keywords**—Harmonics; Rectifier; Power Quality

## I. INTRODUCTION

While the use of uncontrolled rectifier circuits remains prominent, for some applications, more control and efficiency is necessary. This can be accomplished through the use of a controlled rectifier circuit in which thyristors connected in a full-bridge configuration adjust the average voltage. Each thyristor has a gate that controls when it turns on. With control circuitry these devices can be operated with a controllable firing angle ( $\alpha$ ) that can vary the average and rms of output voltage. Devices that use this technology include Uninterruptable Power Supplies (UPS), low-power DC motor drives [1], as well as cycloconverter [2].

The ability to control the output voltage through the use of thyristors does not come without a cost. As the firing angle ( $\alpha$ ) increases, the non-linearity of the rectifier circuit does as well. This means that the shapes of the output voltage and input current waveforms become less sinusoidal. Consequently, this increases the harmonic content of the device both at the input and at the output. At the input of the rectifier, the voltage supplied by the grid is relatively stable and the physics of the device allow the input voltage to remain sinusoidal with minimal harmonic distortion. On the contrary, the input current's behavior depends on how long the thyristors conduct inside the rectifier circuit. The less the conduction time of the thyristors, the more harmonics will be drawn from the source which may affect neighboring loads and power system equipment up the stream. The adverse effects of the harmonic distortion in the input current come in many forms. One detrimental effect is that input current harmonic distortion can lead to voltage distortion further up the line due to the line impedance. This harmonics may reach the distribution transformers which are not rated to handle large amounts of harmonics. Therefore,

despite their increased cost of approximately twice as much as and weight 115% more than the standard transformer, the k-rated transformers would sometimes be necessary [3]. Additionally, these higher frequencies of harmonics can increase the eddy currents and hysteresis losses and heat up the transformer. Lastly, these effects can add up and cause larger issues to the entire power system [4][5].

While the analysis of input current harmonics of uncontrolled or diode rectifier has been widely conducted and published as in [6][7][8][9], little has been known on the analysis of input current harmonics of single phase controlled rectifier. Also, many power electronic textbooks have a rather detailed study of the harmonics at the output of controlled rectifiers, but a similar study of the input current is lacking, especially from the empirical aspect of the issue. This paper hence presents the results of study on the effects of the input current harmonics to controlled rectifier circuit using theoretical, simulation, and experimental methods.

The study starts with the mathematical analysis of the harmonic distortion at the input current of controlled rectifier circuit. OrCAD PSpice simulation is then used to verify the total harmonic distortion (THD) as predicted from the mathematical analysis. To further verify the THD level of the input current, a laboratory setup is being used and tested to obtain actual hardware measurements.

## II. FOURIER ANALYSIS INPUT CURRENT HARMONICS

This investigation into the harmonic distortion begins with a Fourier analysis of the fundamental component of the input current. Figure 1 shows a simplified schematic of the controlled rectifier circuit. In it four thyristors are connected in a full bridge configuration with an AC input and a resistive load output. The firing angle ( $\alpha$ ) of the thyristors can be controlled through their gates to chop the input current on the positive and negative cycles.

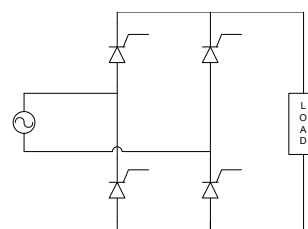

Figure 1. A simplified schematic of the Thyristor controlled circuit

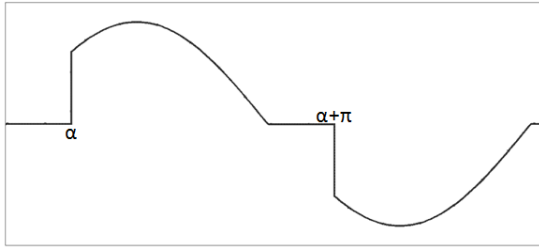

Figure 2. Input current waveform used for Fourier Analysis

Using Figure 2, which shows the input current waveform, the Fourier series component can be expressed as:

$$a_n = \frac{1}{\pi} \int_0^{2\pi} f(\omega t) \cos(n\omega t) d(\omega t) \quad (1)$$

$$b_n = \frac{1}{\pi} \int_0^{2\pi} f(\omega t) \sin(n\omega t) d(\omega t)$$

Since in determining the THD this analysis is only concerned with the fundamental component ( $n = 1$ ), the above equations must only be used for  $n$  equal to one. The derivation of  $a_1$  and  $b_1$  is summarized below.

$$\begin{aligned} \pi a_1 &= \int_{\alpha}^{\pi} \sin(\omega t) \cos(\omega t) d(\omega t) \\ &\quad + \int_{\pi+\alpha}^{2\pi} \sin(\omega t) \cos(\omega t) d(\omega t) \\ &= \frac{\sin^2(\omega t)}{2} \Big|_{\alpha}^{\pi} + \frac{\sin^2(\omega t)}{2} \Big|_{\pi+\alpha}^{2\pi} \end{aligned}$$

$$2\pi a_1 = -2\sin^2(\alpha)$$

$$\boxed{a_1 = -\frac{1}{\pi} \sin^2(\alpha)}$$

$$\begin{aligned} \pi b_1 &= \int_{\alpha}^{\pi} \sin(\omega t) \sin(\omega t) d(\omega t) \\ &\quad + \int_{\pi+\alpha}^{2\pi} \sin(\omega t) \sin(\omega t) d(\omega t) \end{aligned}$$

$$\begin{aligned} 2\pi b_1 &= \int_{\alpha}^{\pi} (1 - \cos(2\omega t)) d(\omega t) \\ &\quad + \int_{\pi+\alpha}^{2\pi} (1 - \cos(2\omega t)) d(\omega t) \end{aligned}$$

$$= t - \frac{\sin(2\omega t)}{2} \Big|_{\alpha}^{\pi} + t - \frac{\sin(2\omega t)}{2} \Big|_{\pi+\alpha}^{2\pi}$$

$$\begin{aligned} &= \pi - \alpha - \frac{\sin(2\pi)}{2} + \frac{\sin(2\alpha)}{2} + 2\pi - \pi - \alpha \\ &\quad - \frac{\sin(4\pi)}{2} + \frac{\sin(2\pi + 2\alpha)}{2} \end{aligned}$$

$$\boxed{b_1 = 1 - \frac{\alpha}{\pi} + \frac{\sin(2\alpha)}{2\pi}}$$

Since both  $a_1$  and  $b_1$  are magnitudes and at the same frequency they must be changes to rms values and their geometric mean must be calculated.

$$f_{1(rms)} = \sqrt{\frac{a_1^2 + b_1^2}{2}}$$

The total rms value is calculated from:

$$f_{tot(rms)} = \sqrt{1 - \frac{\alpha}{\pi} + \frac{\sin(2\alpha)}{2\pi}} \frac{1}{\sqrt{2}}$$

while the THD can be shown as

$$THD = \frac{\sqrt{f_{tot(rms)}^2 - f_{1(rms)}^2}}{f_{1(rms)}}$$

A summary of the theoretical THD at different firing angles ( $\alpha$ ) is shown in Table 1 of Section IV.

### III. COMPUTER SIMULATION

Following the Fourier series analysis is a computer simulation using OrCAD PSpice. Figure 3 depicts the schematic used in simulating the controlled rectifier circuit. The schematic models the actual full bridge rectifier circuit as will be built in the lab used for hardware measurements. However, rather than using the actual thyristors with their firing controller circuit, the model uses diodes in conjunction with the switch Sbreak to model the thyristors and controller. While this model does not use thyristors, the use of the diodes in conjunction with the switch Sbreak will produce identical results at the input and output to what would be obtained otherwise. Figure 4 illustrates the input current and output voltage waveforms when the firing angle is set at  $45^\circ$ . As expected both waveforms are distorted due to the delay of the conduction of the current into the load.

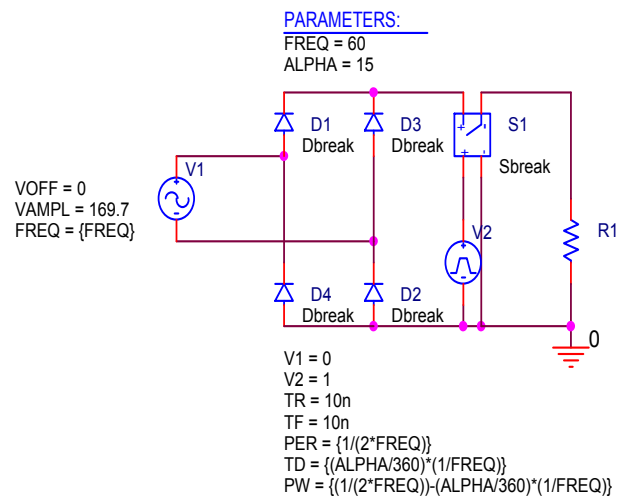

Figure 3. OrCAD PSpice schematic of controlled rectifier circuit

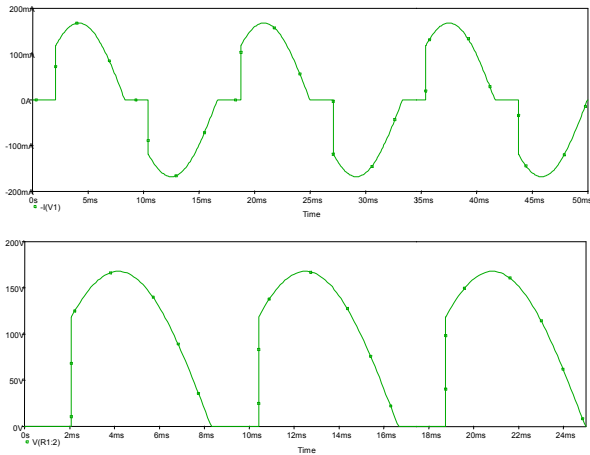

Figure 4. Input current (top) and output voltage (bottom) waveforms at 45° firing angle

The harmonic content of each waveform is obtained through the FFT feature of OrCAD Pspice as depicted in Figure 5 for the input current, again when 45° firing angle is applied.

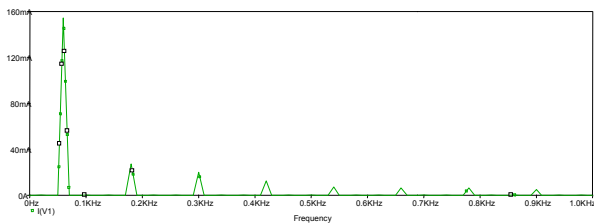

Figure 5. Frequency spectrum of input current at 45° firing angle

A Fourier series analysis of the input current at the fundamental 60 Hz frequency was performed up to 50 harmonics. The THD results of this simulation can also be seen in Table 1 in Section V.

#### IV. HARDWARE MEASUREMENT

The circuit of Figure 1 was configured using a power thyristor module and Enerpro's firing board as illustrated in Figures 6 and 7. A potentiometer was used to control the firing angle on the Enerpro's firing board and a PowerSight 3000 power meter was used to measure the input current and its harmonics. The PowerSight Manager software was used to collect the input current waveform and calculate the THD.



Figure 6. Power thyristor module



Figure 7. Enerpro's Thyristor Firing board

Figure 8 shows the captured input current waveform from the PowerSight Manager software. It can be seen that this waveform resembles the chopped waveform of Figure 2. Table 1 shows a summary of the magnitudes of the harmonic components as well as the THD of the input current.

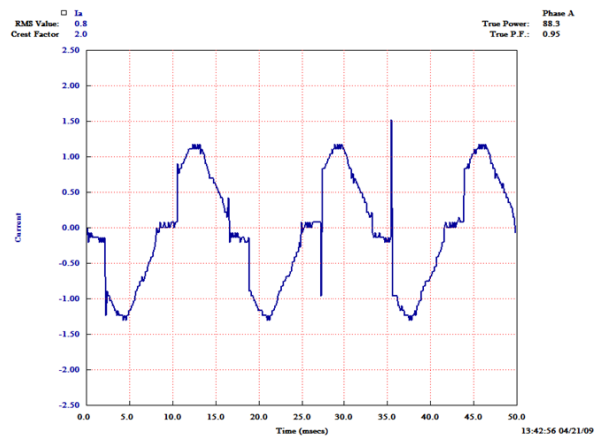

Figure 8. Input Current Waveform for a 45° Firing Angle

Table 1. Summary of Total Harmonic Distortion Analysis

Firing Angle	Input Current THD (%)		
	Fourier Analysis	Simulated	Experimental
5.14	1.21	1.54	8.24
10	3.21	3.34	9.81
15	5.75	5.52	11.24
30	15.11	14.76	15.59
45	25.93	25.6	25.27
60	37.74	37.59	34.03
75	50.63	50.6	49.03
90	65.05	65.18	62.93
105	81.86	82.18	64.74
120	102.63	103.24	116.89
135	130.58	131.73	143.1
150	173.92	168.27	179.05

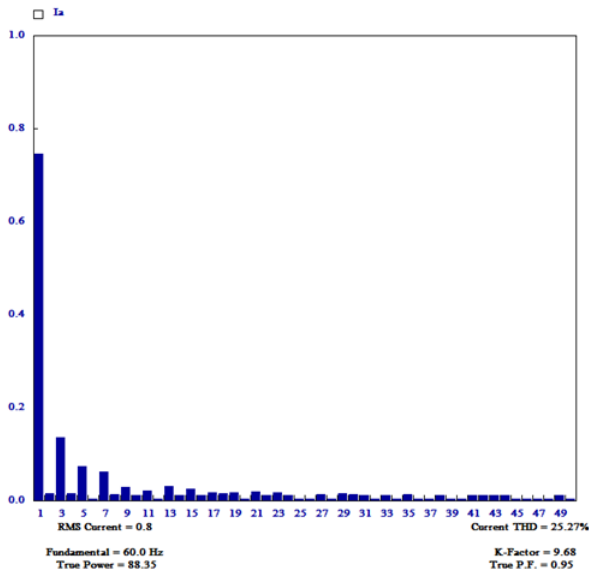

Figure 9. Input Current Harmonics for a 45° Firing Angle

Figure 9 shows that for a 45° firing angle the THD is 25.27%. This analysis was repeated in 15° intervals from 5° to 150°. The firing angle was limited by the operation of the firing board. The results of the experiment can be seen in Table 1.

### V. DISCUSSION

Table 1 shows a summary of the results from mathematical analysis, computer simulation, and hardware measurement. First, the table shows that, with the exception of 150°, the Fourier series analysis and simulated results never differ by greater than 1.2 %THD. Secondly, we can observe that the experimental results closely relate with the simulated results from 30° to 90°. Outside of this range there is a larger deviation in which the experimental results show greater THD value. This is mainly caused by the amount of spikes on the current waveform that worsens as firing angle exceeds 90° or when the firing angle is small, see Figure 10.

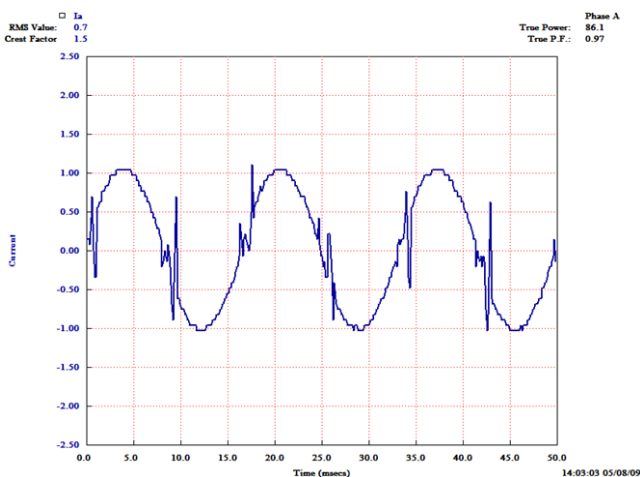

Figure 10. Input Current Waveform for a 5.14° Firing Angle

Figure 10 shows the input current waveform for the smallest firing angle of 5.14°. The waveform shows that even though only a small firing angle exists there are large current spikes when the thyristors are turned on. These current spikes affect the THD and cause it to have a different value than expected mathematically and through simulation. This is the same case at larger firing angles above 90°. There the fundamental component has an even smaller value causing the THD to be more sensitive to these spikes.

Figure 11 shows a graph of the THD from the three different forms of analysis. It shows that all three follow each other relatively closely and thus verify the validity of the mathematical analysis, as well as the model used in the computer simulation.

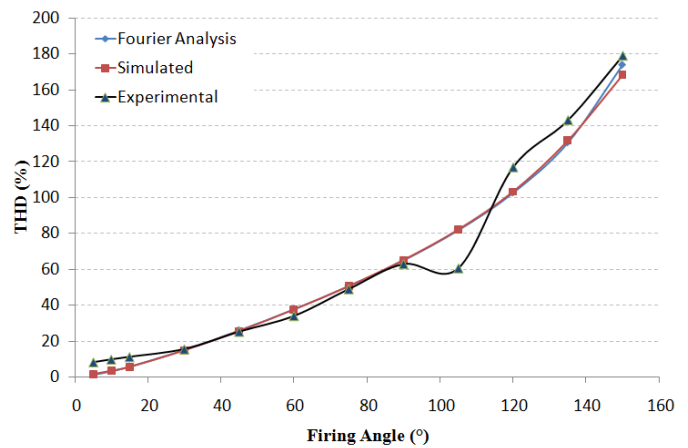

Figure 11. THD as a Function of Firing Angle

### VI. CONCLUSION

In this paper the total harmonic distortion (THD) of a controlled rectifier was investigated. The investigation began with a mathematical derivation of the fundamental component of the Fourier series of the input current waveform. This result was used to determine the rms value of the fundamental component of the input current and the corresponding THD. This was followed by a computer simulation using OrCAD PSpice. A Fourier series analysis was performed in the simulation. Lastly, a hardware experiment was conducted and a PowerSight 3000 power meter and PowerSight manager computer software was used to determine the THD.

The three different analyses showed that as firing increased so did harmonic distortion. This is an important quality to note. If a large device or a large number of small devices pulled current at a frequency other than the fundamental component devices could be harmed. It is important to note that k-rated transformers and harmonic filters may be necessary to protect the overall system from such damaging frequencies. This paper effectively demonstrates the impact of harmonic distortion at the input of such devices, and provides the necessary theoretical equations for predicting the THD of input current of a single-phase controlled rectifier.

#### ACKNOWLEDGMENT

We wish to acknowledge Enerpro, Inc. of Goleta, California for their generous donation of their thyristor firing boards to the Power Electronics lab at Cal Poly State University in San Luis Obispo, California.

#### REFERENCES

- [1] Rashid, M., *Power Electronics: Circuits, Devices, and Applications*, 3<sup>rd</sup> Edition, New Jersey: Prentice Hall 2004.
- [2] Dubey, G. K., Doradia S. R., Joshi, A., *Thyristorised Power Controllers*, 2<sup>nd</sup> Edition, New Age International, 1986.
- [3] Kennedy, B. W., *Energy Efficient Transformers*, McGraw-Hill Professional, 1997.
- [4] Barnes, R., "Harmonics in power systems", *Power Engineering Journal*, Volume 3, Issue 1, pp 11 – 15, January 1989.
- [5] Maslowski, W. A., "Harmonics in power systems", *Proc. IEEE 1992 Annual Textile, Fiber and Film Industry Technical Conference*, pp. 11/1 – 1110, 1993.
- [6] Stratford, P. R., "Rectifier harmonics in power systems", *IEEE Trans. On Industry Applications*, Volume IA-16, Issue 2, pp. 271 – 276, March 1980.
- [7] Szabados, B., "On the interaction between power system configuration and industrial rectifier harmonic interference: a practical case study", *IEEE Trans. on Power Apparatus and Systems*, Volume PAS-101, Issue 8, pp. 2762 – 2769, August 1982.
- [8] Tzeng, Y. S., "Harmonic analysis of parallel-connected 12-pulse uncontrolled rectifier without an interphase transformer", *Electric Power Applications*, IEE Proceedings, Volume 145, Issue 3, pp. 253 – 260, May 1998.
- [9] Fukuda, S., Ohta, M., and Iwaji, Y., "An auxiliary-supply-assisted harmonic reduction scheme for 12-Pulse diode rectifiers", *IEEE Trans. On Power Electronics*, Volume 23, Issue 3, pp. 1270 – 1277, May 2008.