

## INTRODUCTION

A unique challenge in the development of a deep space optical software defined radio (SDR) transmitter is the optimization of the extinction ratio (ER). For a Mars to Earth optical link, an ER approaching 40dB may be necessary. However, a high ER can be difficult to achieve at the low Pulse Position Modulation (PPM) orders and narrow slot widths required for high data rates.

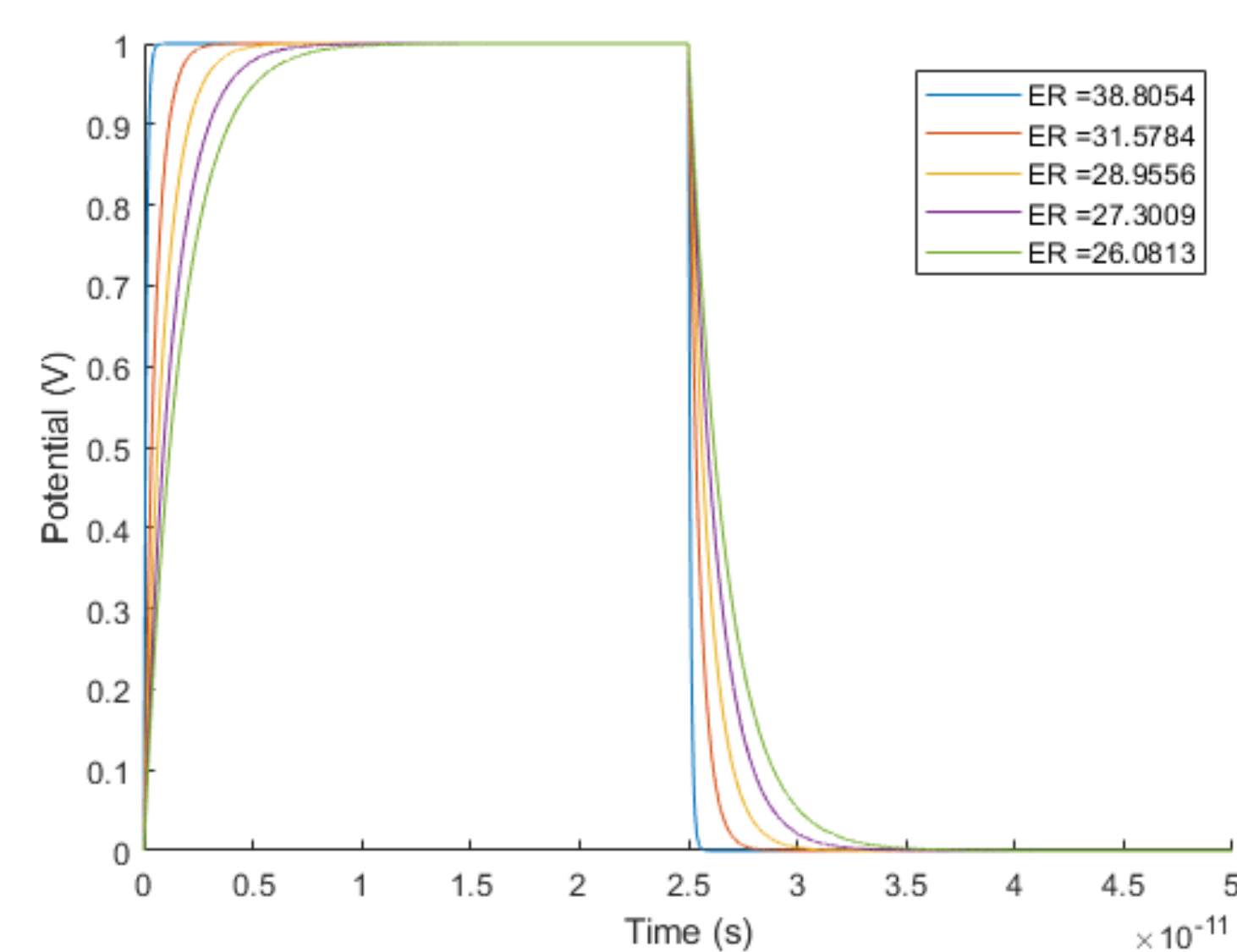
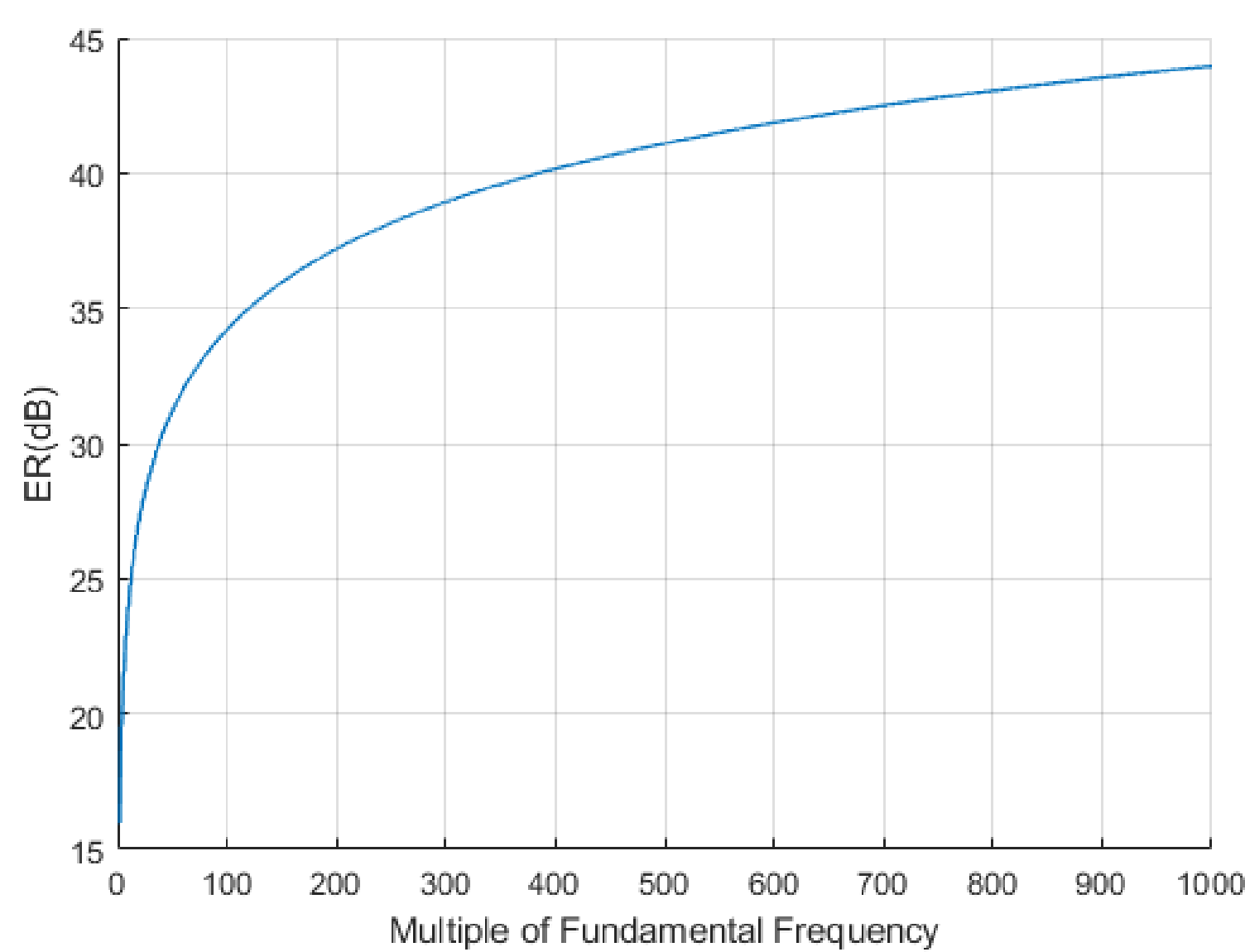

A very high bandwidth is required to achieve high Extinction Ratio in a system where the pulse width is equal to the slot width .

## ARCHETECTURE

The purpose of the proposed optical modulation subsystem is to relieve the SDR of the high signal quality requirements imposed by the use of an MZM. With the addition of a second MZM and a variable time delay, all of the non-idealities in the electrical signal can be compensated for.

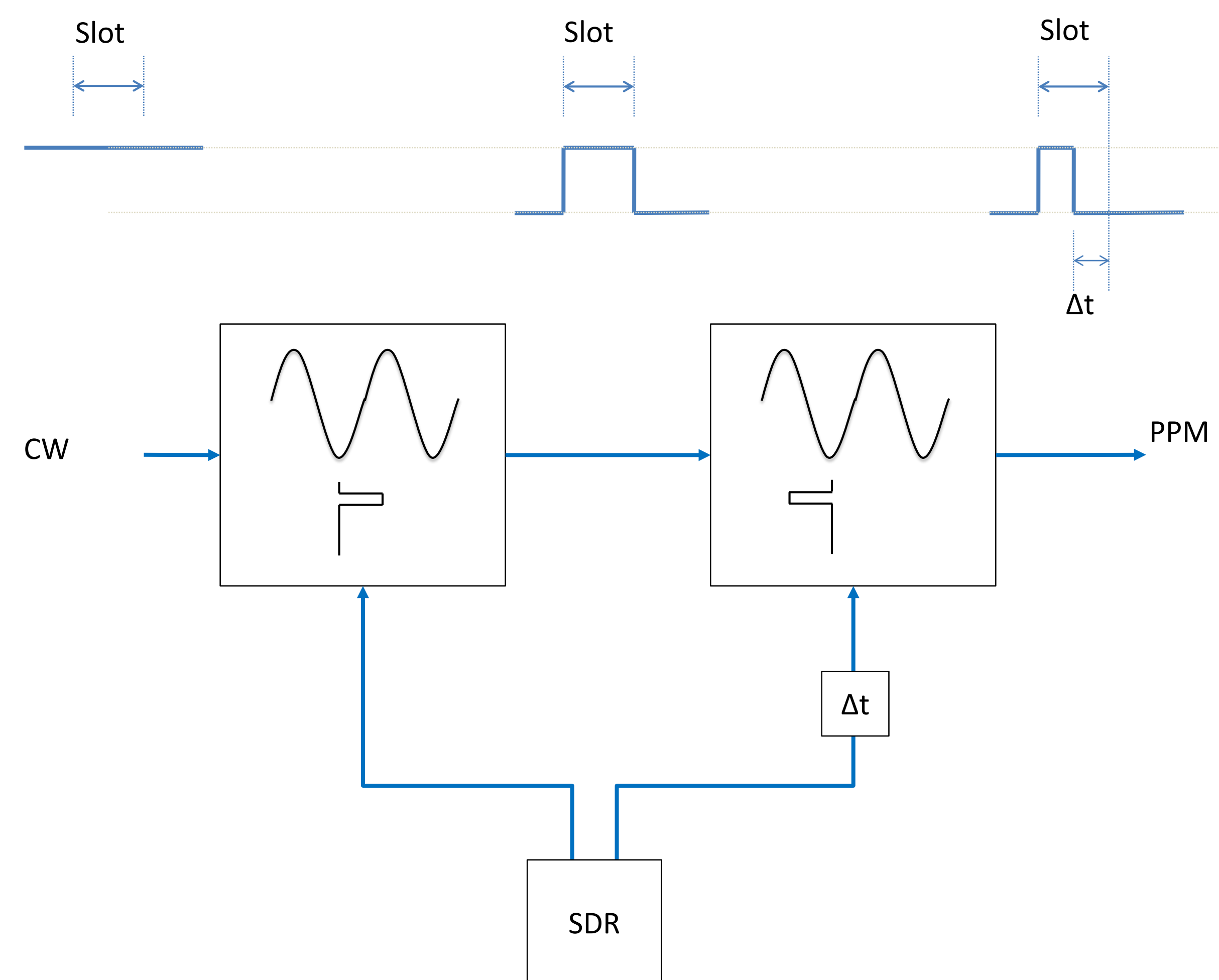

The proposed system consists of two modulators and a variable phase delay.

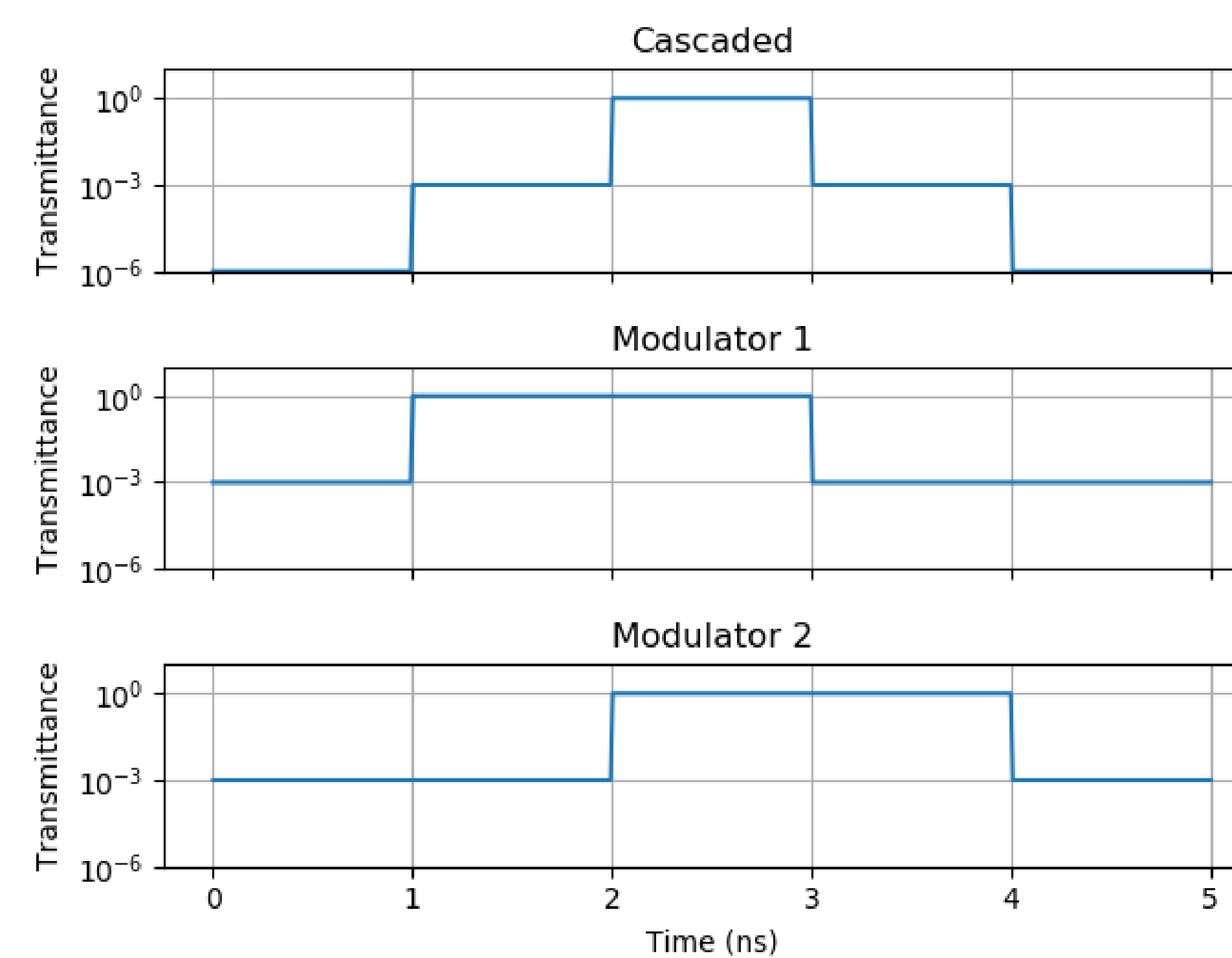

The phase offset between the two modulators allows for pulse carving

## TEST SETUP

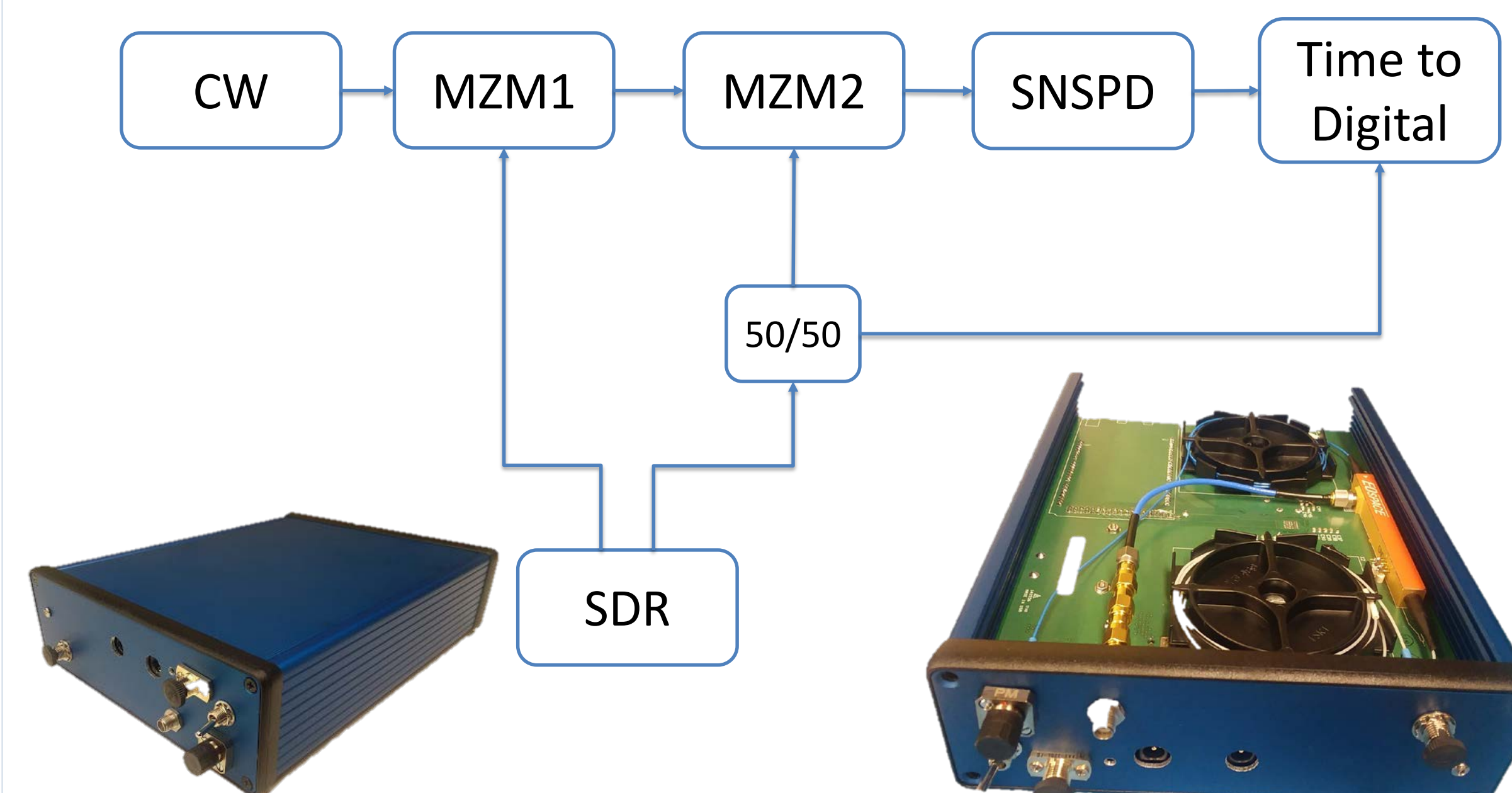

## RESULTS

Results from a full system test showed a significant reduction in pulse width and associated increase in ER. Higher offsets come at the cost of reducing the slot energy creating disproportionately to inter-slot interference energy which creates an optimum set point.

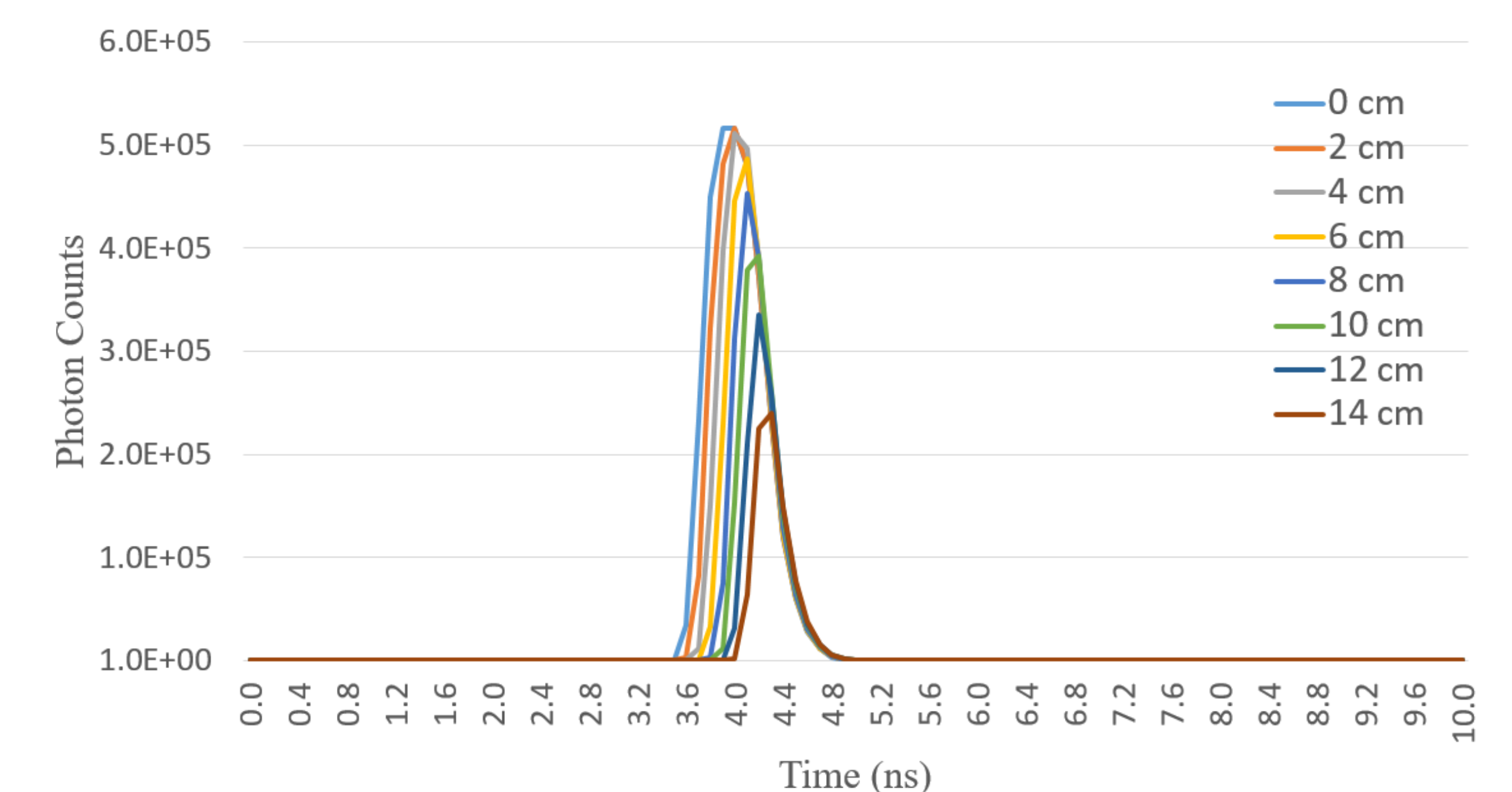
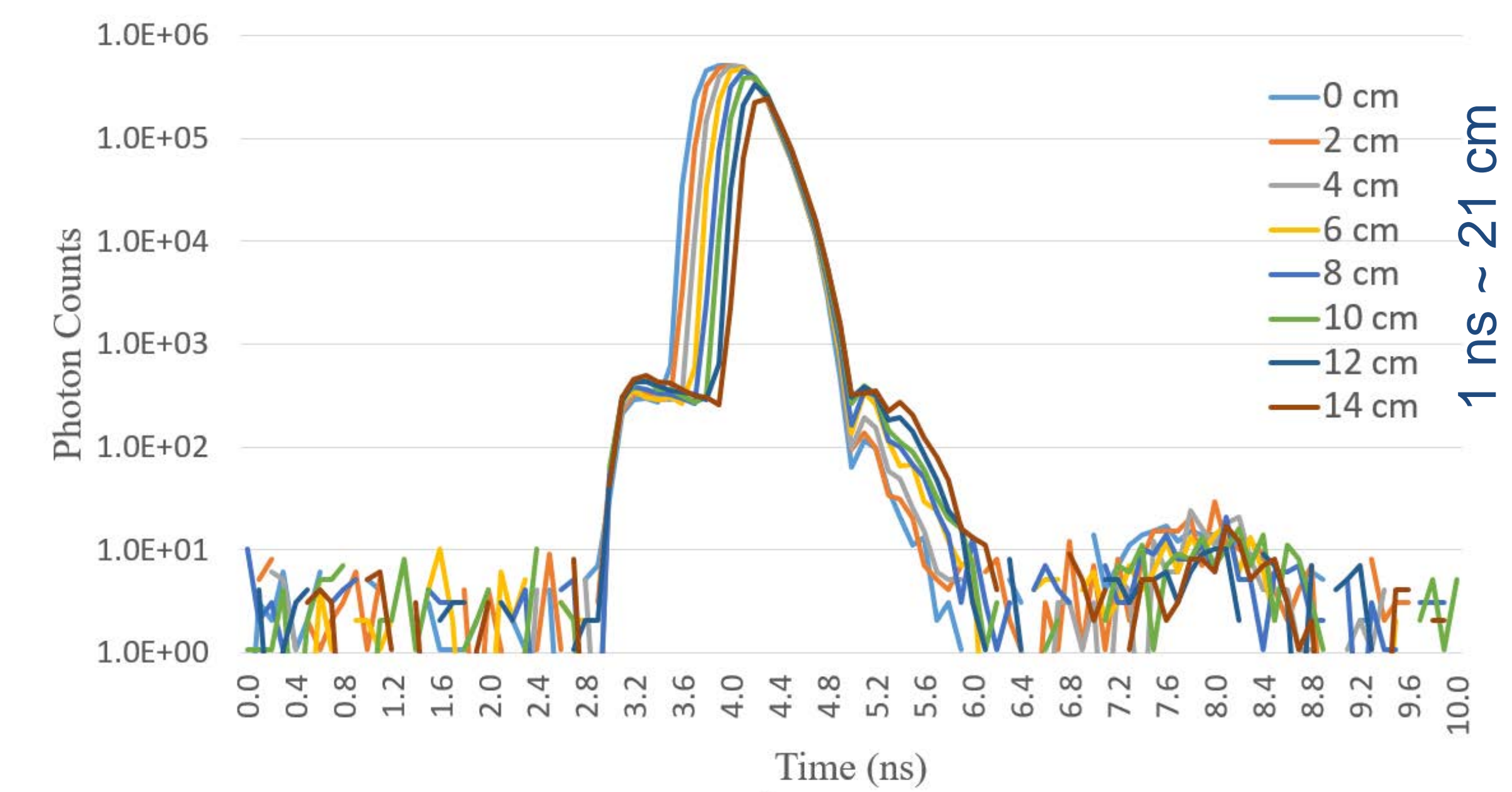

(dB)	0 cm	2 cm	4 cm	6 cm	8 cm	10 cm	12 cm	14 cm
PPM 4	28.4	30.5	28	32.5	30.3	31.1	29.3	27.9
PPM 16	35.1	37	34.8	39.1	37	37.6	36	34.6
PPM 32	38.1	39.8	37.7	41.6	39.8	40.3	38.8	37.5
PPM 64	40.4	41.9	40.2	43.3	41.9	42.4	41.1	40
PPM 128	43.2	44.5	43	45.8	44.6	45	43.8	42.7
PPM 256	45.9	47.1	45.7	48.2	47.15	47.5	46.4	45.2

## CONCLUSIONS

The optical modulation subsystem proposed here address some of the challenges of modulating a PPM signal with high ER and speed requirements. The subsystem gains performance the cost of increased complexity and additional insertion loss. Measurement and analysis of the system showed that for a 1 ns pulse width, a 40 dB ER was achieved for PPM orders above 32.