

# EXTREME ENVIRONMENTS SOLAR POWER PROJECT

## ENABLING SOLAR ARRAY POWER TO THE OUTER PLANETS

JEREMIAH MCNATT

NASA GLENN RESEARCH CENTER



# OUTLINE

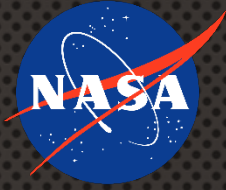

- MOTIVATION/BACKGROUND
- WHAT DO WE CALL AN EXTREME ENVIRONMENT FOR SOLAR POWER
- HOW DO SOLAR CELLS OPERATE IN THESE ENVIRONMENTS
- WHAT CAN BE DONE TO MITIGATE THESE EFFECTS
- WHAT ARE WE DOING UNDER THE EXTREME ENVIRONMENTS SOLAR POWER (EESP) PROJECT



# MOTIVATION

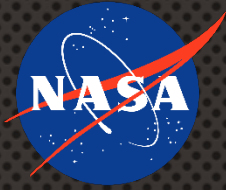

- NASA WANTS TO USE PHOTOVOLTAIC POWER SYSTEMS WHERE AVAILABLE INCLUDING TO THE OUTER PLANETS OF JUPITER AND SATURN
- USES AND LOCATIONS INCLUDE:
  - JUPITER: JUNO
    - EUROPA: EUROPA CLIPPER
    - TROJAN AND GREEK ASTEROIDS
  - SATURN
    - TITAN: TITAN ORBITER
  - DAWN
    - 3 AU DISTANCE
  - ROSETTA
    - 5.25 AU DISTANCE

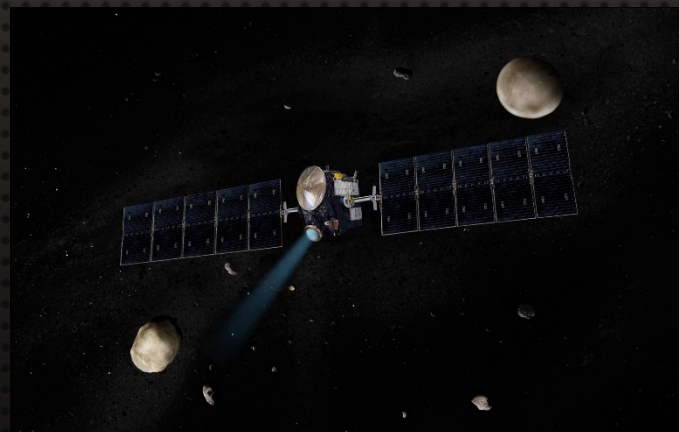
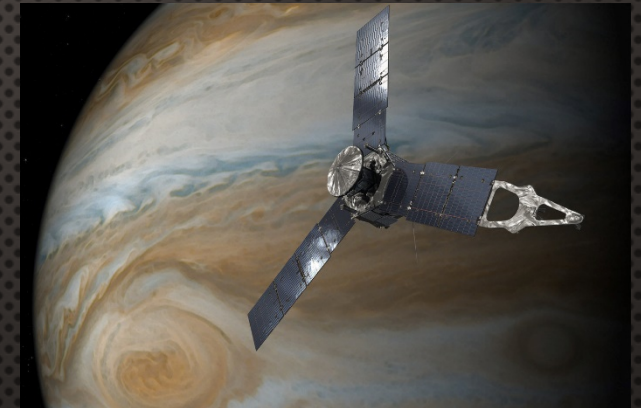



# MOTIVATION

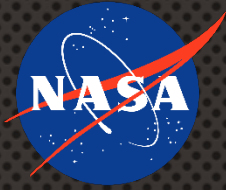

Additional Missions Could include:

- Missions with highly heliocentric orbits (5 – 20 AU)
- Other outer planet moon orbiters
- Jovian inner moon orbiters (with improved radiation resistance)
- Outer planet fly-by missions
- YELLOW INDICATES LOCATIONS AND MISSIONS APPLICABLE TO SOLAR POWER
- OUTER RINGS ARE ORBITER AND FLYBY MISSIONS, INNER RINGS INDICATE LANDERS/PROBES

FROM: SOLAR POWER TECHNOLOGIES FOR FUTURE PLANETARY SCIENCE MISSIONS, DECEMBER 2017 (JPL D-101316)

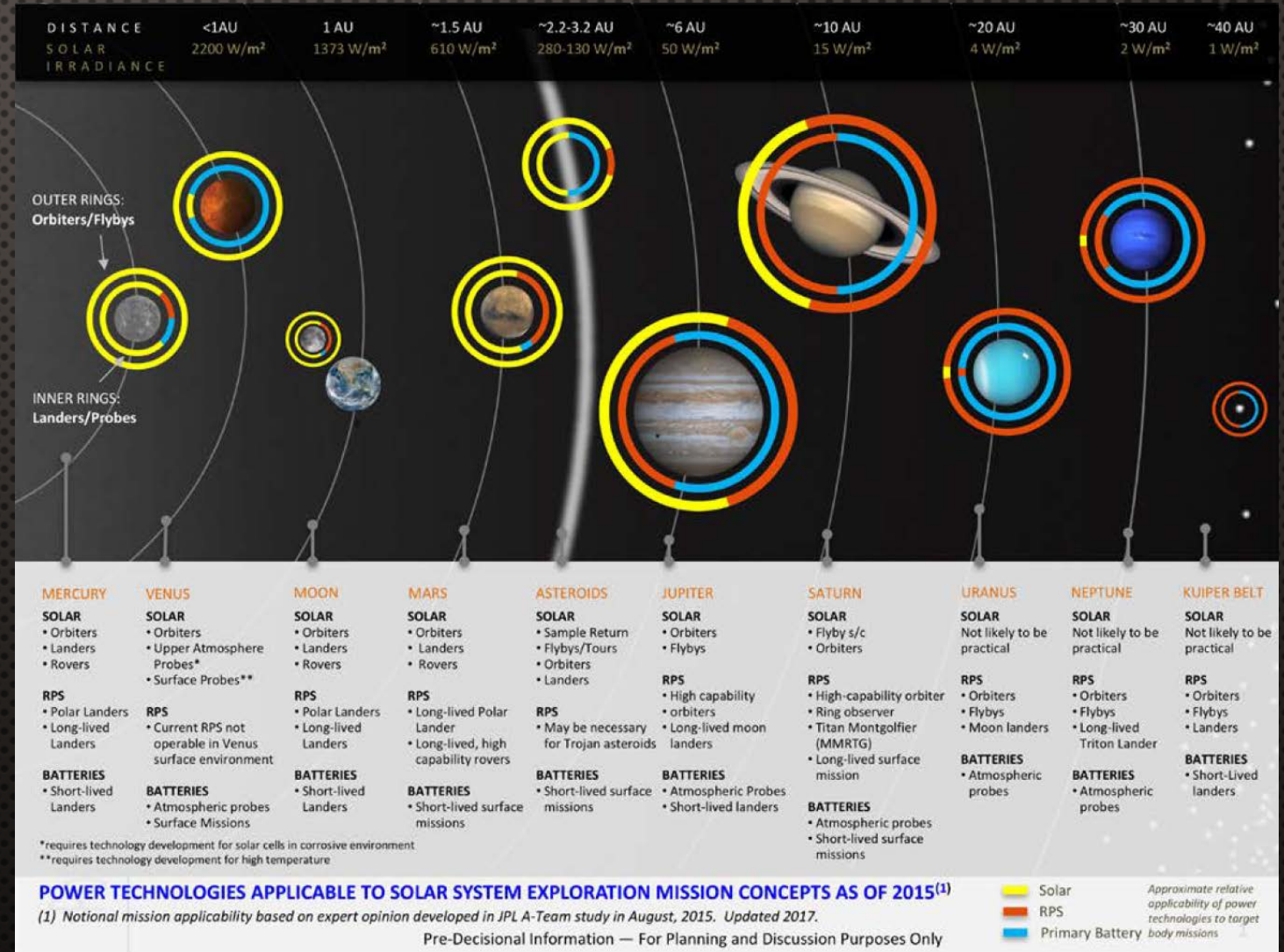



# ENVIRONMENTAL CONDITIONS AT OUTER PLANETS

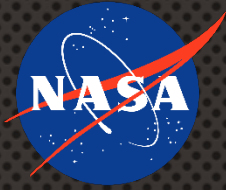

- LOW INTENSITY LIGHT
  - DOWN TO 1% EARTH ORBIT INTENSITY WHEN AT SATURN
- LOW TEMPERATURES
  - EXTREMELY LOW DURING ECLIPSE PERIODS
- POTENTIAL FOR HIGH RADIATION WHEN CLOSE TO JUPITER
  
- ADDITIONALLY, MANY MISSIONS TO THESE LOCATIONS REQUIRE TRAJECTORIES THAT APPROACH VENUS: HIGHER INTENSITY LIGHT AND HIGHER TEMPERATURE

Planetary Solar Flux				
			Solar Flux (Ks)	% Power
Planets	(AU)		W/m <sup>2</sup>	(based on 1 AU)
Venus	0.7233	$(1/Au)^2 * 1370$ →	2619	191.15
Earth	1		1370	100.00
Mars	1.5237		590	43.07
Jupiter	5.2028		51	3.69
Saturn	9.588		15	1.09
Uranus	19.191		4	0.27
Neptune	30.061		2	0.11
Pluto	39.529		1	0.06



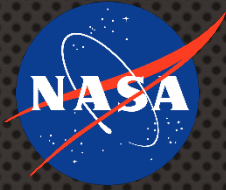

# LOW TEMPERATURE/LOW INTENSITY (LILT) EFFECT

- DECREASE IN SOLAR INTENSITY IMPACTS SOLAR CELL EFFICIENCY
  - FILL FACTOR DECREASES AT VERY LOW INTENSITY LEVEL
  - LEAKAGE CURRENT IS LARGER COMPONENT OF TOTAL
- VARIABLE FROM CELL-TO-CELL, EVEN AMONG THE SAME CELL CHEMISTRY
- UNDER LILT CONDITIONS THE ENTIRE STRING WILL BE CURRENT-LIMITED BY THE OUTPUT OF THE "BAD" CELL AND THE PERFORMANCE OF THE ENTIRE STRING WILL BE DEGRADED

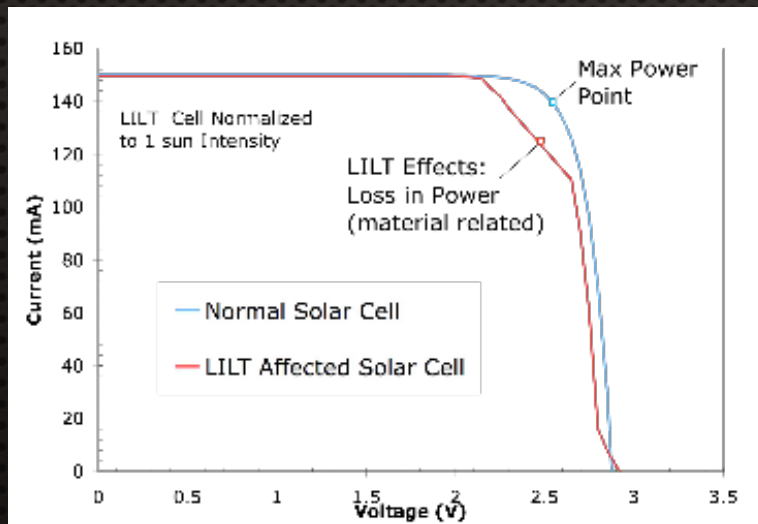

Power loss from a solar cell under low intensity, low temperature conditions. The fill factor and efficiency of the solar cell is degraded (red line) under LILT conditions.



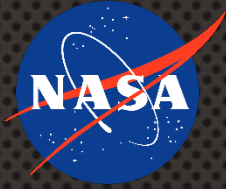

# RADIATION PROBLEM

- ELECTRONS AND PROTONS RELEASED BY THE SUN AND TRAPPED WITHIN VARIOUS PLANETARY ORBITS (SUCH AS EARTH'S VAN ALLEN RADIATION BELTS) CREATE DEFECTS WITHIN THE SEMICONDUCTOR CRYSTALLINE STRUCTURE AND REDUCE SOLAR CELL POWER OUTPUT
- MISSION EXAMPLES:
  - GEO: 15 YEAR MISSION  $5 \text{ E}+14 \text{ E/CM}^2$
  - JUNO: 33 ORBITS,  $1.32\text{E}+15 \text{ E/CM}^2$
  - EUROPA CLIPPER: 59 ORBITS  $3.6 \text{ E}+15 \text{ E/CM}^2$
- EASIEST WAY TO PROTECT THE SOLAR CELL FROM THESE DAMAGING EFFECTS IS BY SHIELDING THE FRONT OF THE SOLAR CELL WITH GLASS
  - THE THICKER THE GLASS, THE MORE PROTECTION THE CELL RECEIVES; HOWEVER THIS ADDS MORE MASS AND COST TO THE SOLAR ARRAY



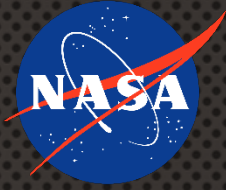

# WHAT IS BEING DONE CURRENTLY TO MAKE THESE CELLS WORK?

- ADDING THICK COVERGLASS OVER THE CELLS
  - TO MITIGATE RADIATION, THE COVERGLASS THICKNESS IS INCREASED AS THE AMBIENT RADIATION LEVEL EXPECTED IS INCREASED
  - LEADS TO INCREASED MASS AND COSTS
- SCREENING EVERY CELL FOR LILT DEGRADATION
  - SINCE NOT ALL CELLS EXHIBIT THE DRAMATIC DROP OFF IN PERFORMANCE UNDER LILT CONDITIONS, CELLS SELECTED FOR SUCH AN ARRAY ARE ALL SCREENED
  - LOW INTENSITY, ROOM TEMPERATURE PERFORMANCE MEASUREMENT IS TAKEN FOR EACH CELL
  - PROCESS IS TIMELY AND COSTLY



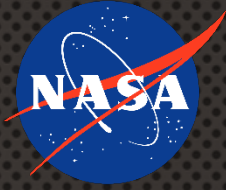

# WHAT ELSE COULD YOU DO?

- CAN YOU IMPROVE THE CELL TO BE LILT RESISTANT AND MORE RADIATION TOLERANT?
  - CHOICE OF APPROPRIATE SEMICONDUCTOR MATERIALS, CELL DESIGNS, AND PRECISE ATTENTION TO CELL FABRICATION PROCESSES COULD BE USED TO DEVELOP A HIGH EFFICIENCY DEVICE THAT IS BOTH RADIATION TOLERANT AND EXHIBITS MINIMAL LILT-TYPE DEGRADATION EFFECTS
- CAN YOU DESIGN AN ARRAY THAT WILL MITIGATE THESE EFFECTS? POTENTIALLY A CONCENTRATOR?
  - SHIELD THE SOLAR CELL AND MINIMIZE THE AMOUNT OF SOLAR CELL AREA NEEDED
  - OPERATING AT HIGHER SOLAR INTENSITY AND TEMPERATURE CONDITIONS THAN ONE-SUN PLANAR ARRAYS (EFFECTIVELY PUT THE CELLS BACK INTO NON-LILT CONDITIONS)



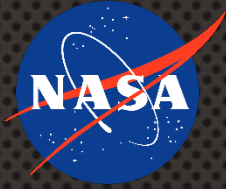

# EXTREME ENVIRONMENTS SOLAR POWER (EESP) KEY TECHNOLOGY CHALLENGES

Challenge	Description
Long-term solar array performance in a deep space environment	Identify and demonstrate solar array & cell technologies that can provide spacecraft power for NASA missions in deep space. <ul style="list-style-type: none"><li>- Minimize mass in high radiation environments</li><li>- Withstand the thermal extremes and cycling of deep space</li><li>- Long-life operation over a wide range of solar distances</li></ul>
Understand and mitigate LILT effects on newer solar cells	Can detrimental/non-predictable Low Intensity Low Temperature (LILT) performance degradation effects on production-level solar cells be easily identified and corrected? <ul style="list-style-type: none"><li>- Eliminate time &amp; cost associated with "cherry-picking" flight cells</li><li>- Identify cause of LILT effects and implement corrective actions in fabrication</li><li>- Enable the use of new high-efficiency/lightweight solar cells for deep space</li></ul>
<p><u>Notes:</u> Specific technical challenges are highly dependent upon the detailed solar array design and the "solutions" to the technical challenges noted above. (i.e. concentrator concepts will minimize LILT issues and provide mass-effective shielding in high radiation environments, but impart sun-pointing requirements and the potential of added mechanical complexities; planar solar arrays require more massive shielding in high radiation orbits and are more susceptible to LILT effects, but implement simpler array designs and deployment schemes). Each specific design has its own unique set of advantages and disadvantages.</p>	



# EESP PROJECT

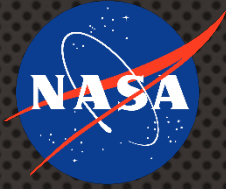

- PROJECT GOALS

- 35% BEGINNING OF LIFE (BOL) CELL EFFICIENCY 28% EOL AT THE BLANKET (OR EQUIVALENT) LEVEL, MEASURED AT 5 AU AND -125 °C RELATIVE ENVIRONMENT
- 8-10 W/KG MEASURED AT EOL INCLUSIVE OF THE ARRAY STRUCTURE AND DEPLOYMENT MECHANISM WITH ALL GIMBALS, STRUCTURES, AND CONTROL SYSTEMS REQUIRED FOR POINTING OR OTHERWISE ACHIEVING END PERFORMANCE LEVELS MUST BE ACCOUNTED FOR IN CALCULATIONS
- PACKAGING DENSITY OF AT LEAST 60 kW/m<sup>3</sup>
- TECHNOLOGY CAPABLE OF OPERATION OVER THE RANGE OF 100 – 300 V.
- DEMONSTRATION OF A REASONABLE PATH TO SPACE QUALIFICATION
- DEMONSTRATION OF THE ABILITY TO INTEGRATE PROPOSED TECHNOLOGY INTO A SOLAR ARRAY STRUCTURE THAT CAN SURVIVE LAUNCH CONDITIONS

- PROJECT PLAN

- EACH CONTRACTOR WILL DEMONSTRATE POTENTIAL SOLUTIONS TO THE LOW INTENSITY, LOW TEMPERATURE (LILT) EFFECT AND WAYS TO REDUCE RADIATION DAMAGE.
- SOLUTIONS WILL BE CHARACTERIZED IN TERMS OF CELL EFFICIENCY, SPECIFIC POWER, AND PACKAGING DENSITY UNDER EXPECTED OPERATING CONDITIONS ASSOCIATED WITH MODERN SPACE CRAFT UTILIZING SOLAR ELECTRIC PROPULSION (SEP) SYSTEMS AT 5AU.
- BASE CONTRACTOR WITH 4 CONTRACTS, OPTIONAL CONTINUATION WITH 2 CONTRACTS, OPTIONAL CONTINUATION WITH 1 CONTRACT



# EESP TECHNICAL APPROACH

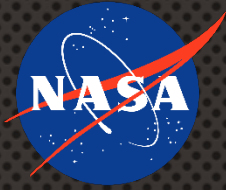

- Four (4) base contracts (with options) were awarded in June 2016
  - 1 planar array using advanced IMM solar cells and 3 concentrator array concepts
  - Show viability of concept, advancement of meeting goals, and feasibility of reaching TRL5 by end of Option II
- APL & ATK were selected for Option I award in May 2017
  - 2x reflective concentrator using IMM solar cells, DSS ROSA
  - Up to 25x refractive concentrator approach employing Compact Telescoping Array
  - Demonstrate advancement, feasibility of reaching TRL5 by end of Option II, and evidence documenting feasibility of further developing the technology for a NASA mission
- APL awarded Option II in June 2018
  - Develop and demonstrate cell / blanket technology to greater than TRL5
  - Provide evidence documenting feasibility of further developing the technology for a NASA mission

## APL

Flexible Array Concentrator Technology, SolAero IMM cells on DSS ROSA



## OATK

Point Focus Concentrator Compact Telescoping Array

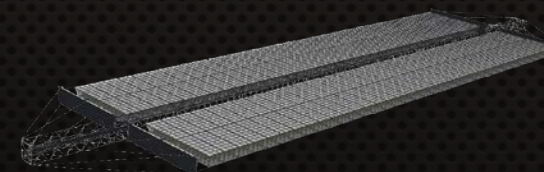
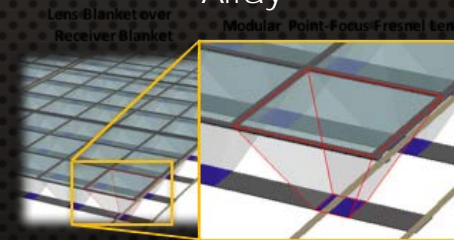

## JPL

MegaFlex Planar Array with SolAero IMM cells

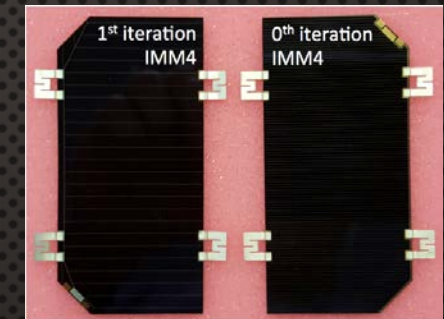

## Boeing

Concentrator with MicroElectroMechanical Systems-based Micro-Concentrator Modules

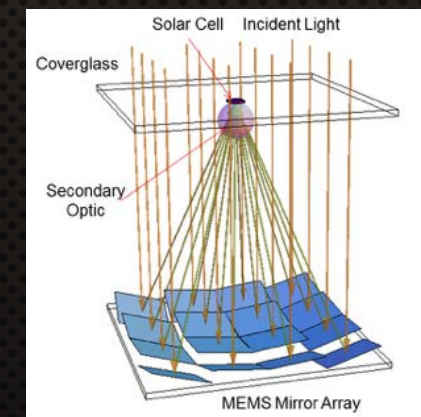



# EESP TECHNICAL STATUS

## BOEING: MEMS MCM

- MEMS mirrors are used to adjust the concentration of light onto the solar cells throughout the mission up to 30x.
- Breadboard MicroConcentrator Module (BB MCM) definition completed breadboard assembly designed
- Solar array blanket integration concepts designed with compatibility with DSS (ROSA) and OATK (Megaflex)
- Spectrolab UTJ and QJ1 cells were used for the radiation testing at  $1E15$   $1\text{MeV}$   $e/\text{cm}^2$

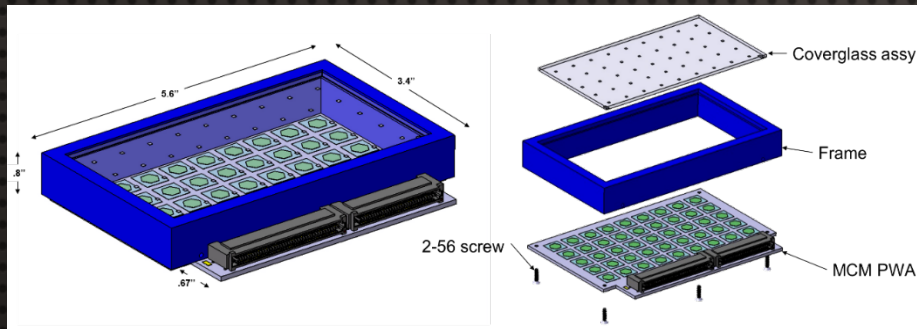

Breadboard design for EESP Base program. Cells are mounted face down on the coverglass assembly

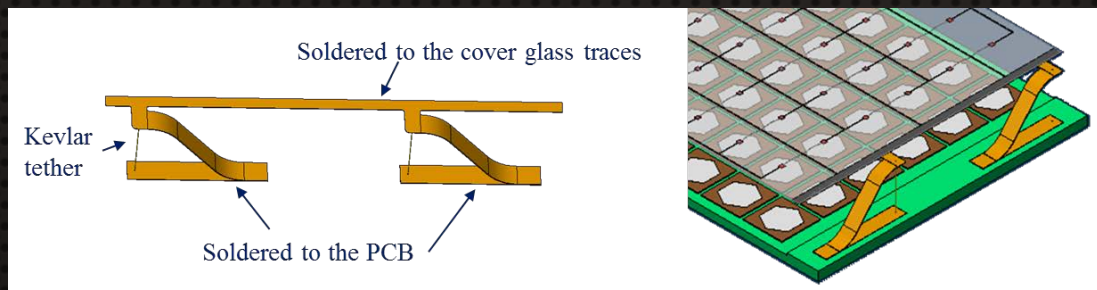

Concept flight design which uses pop up springs to achieve proper spacing between the mirrors and cells



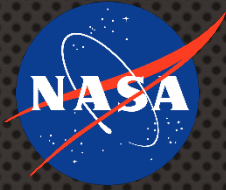

# EESP TECHNICAL STATUS

## JPL: IMM ON PLANAR ARRAY

- Cell trade study completed & IMM4 selected over ZTJ
  - In lab testing, IMM4 cells exceeded BOL and EOL EESP goals for cell efficiency at LILT conditions (5AU -125 C)
  - IMM4 cell grid pattern was optimized for LILT conditions

Fluence (e-/cm <sup>2</sup> )	Demonstrated	NRA Goal
0e00 (BOL)	37.9%	35.0%
4e15 (EOL)	29.5%	28.0%

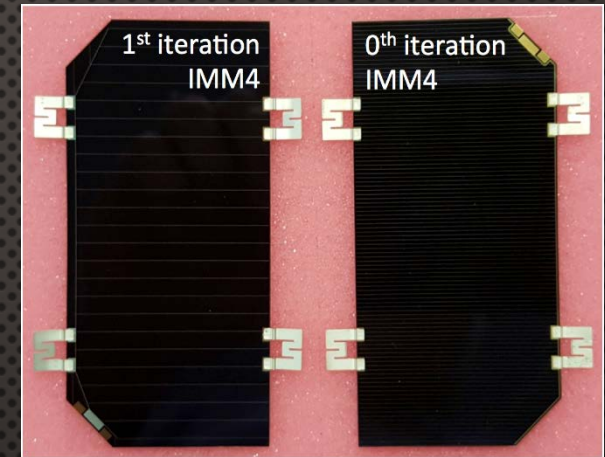

- Array-structure concept trade study was completed, resulting in the down-select of a planar over a concentrator architecture
  - MegaFlex by Orbital ATK found to be the most suitable for integration

Performance	Expected	NRA Goal
LILT BOL cell efficiency	37.9%	35%
LILT EOL cell efficiency	29.5%	28%
LILT EOL array specific power	8.6 W/kg	8-10 W/kg
1AU BOL packaging density	53.5 kW/m <sup>3</sup>	60 kW/m <sup>3</sup>
Stowed & launch capability	Yes	Yes
Operation in 100-300V range	Yes	Yes
Plasma operation 2eV, 1e8/cm <sup>3</sup>	Yes	Yes
LILT EOL minimum array power	5.2 kW	5 kW



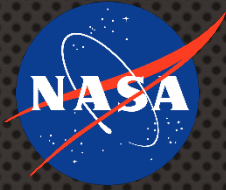

# EESP TECHNICAL STATUS

## ORBITAL ATK: PFC-CTA

- **Lens development/selection**
  - Produced and tested prototype lenses,
  - Lens Efficiency Measurements: lenses perform consistently among samples
  - Thermal cycling: Chamber cycled from +30°C to -180 °C
  - Downselected to Ti and CMG glass lenses
- **Grid Frame Development**
  - Methods to produce grid frames with molded construction pursued
  - “Gusset” frame construction developed - Lenses suspended and supported at corners

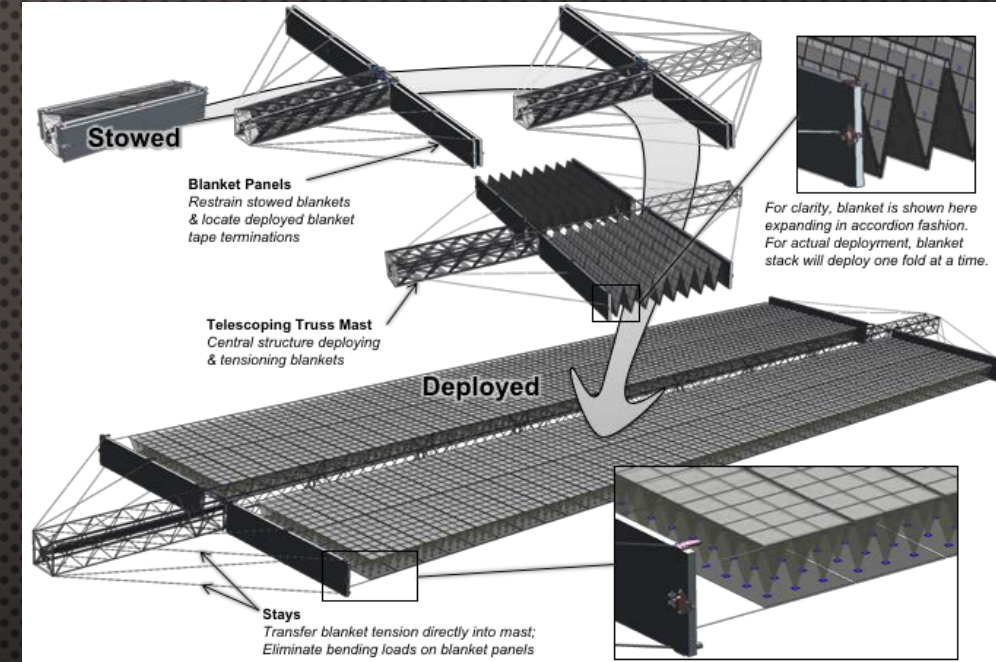



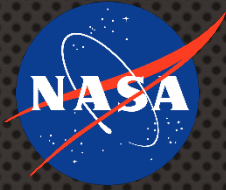

# EESP TECHNICAL STATUS

## ORBITAL ATK: PFC-CTA

- Test mini-blankets assembled
- Deployment / Unfurling Tests
  - Verified no hangups, snags, blankets fully separate after unfurling
  - Verified flatness and alignment of lens vs. PV nodes

### PFC-CTA Blanket Subsystem Evaluation

- Deployment: Sequencing, unfolding
- Deployed alignment: Verify co-alignment of lenses over PV
- Out-of-plane vibration: Verify that drumhead modes of PV or lenses do not cause issues
- In-plane vibration
  - Verify in-plane restraints are sufficient to maintain stack alignment
  - Verify in-plane loads do not cause issues

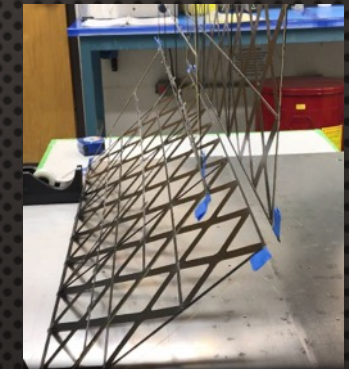
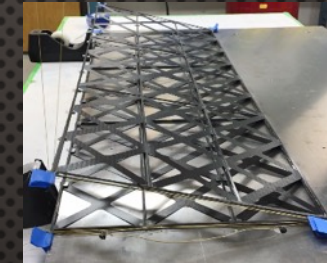
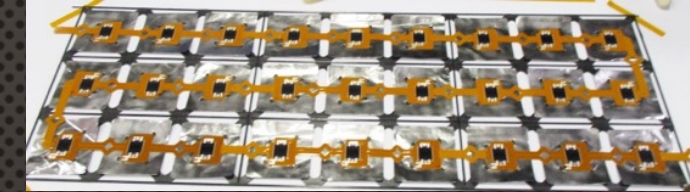
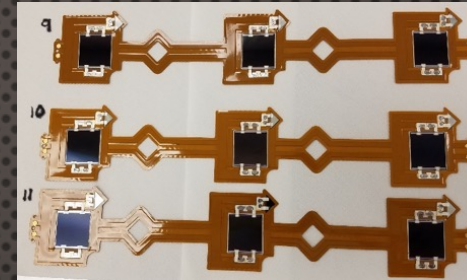

~1m

low fidelity  
lens and PV  
modules

high fidelity  
lens and PV  
modules

low fidelity  
lens and PV  
modules

~3m





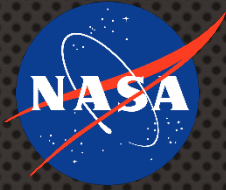

# EESP TECHNICAL STATUS

## APL: TRANSFORMATIONAL ARRAY

### System Concept

- Use the highly developed and well tested DSS Roll Out Solar Array (ROSA) for the array structure and blanket.
  - ROSA is well suited for operation at high temperatures which is useful for Venus flyby
  - ROSA is also well suited for use at Jupiter
  - AFRL demonstrated ROSA on ISS; SSL is flight qualifying ROSA for use in Earth Orbit
- Equip the array with high efficiency IMM solar cells which also offer longer life in radiation environments
- Equip the array with concentrators which could reduce array mass, volume, and cost.



Flexible Array Concentrator Technology (DSS, APL)



ROSA Deployed on ISS under AFRL mission, Photo Credit NASA



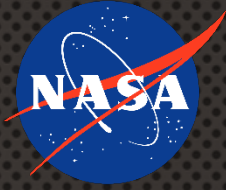

# CURRENT STATUS AND NEXT STEPS FOR EESP

- CONTINUE THROUGH OPTION 2 WITH APL
- LOOK FOR WAYS TO INTEGRATE THESE TECHNOLOGIES INTO MISSIONS
- SHOW THE BENEFITS OF LILT OPTIMIZED AND LILT REDUCING ARRAYS TO FUTURE MISSIONS AND SCIENCE PROGRAMS



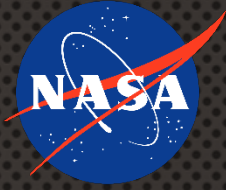

# ACKNOWLEDGMENTS

## NASA GLENN

- FRED ELLIOTT, ANNA MARIA PAL, MICHAEL PISCZCOR (RET.)

## JOHNS HOPKINS APPLIED PHYSICS LABORATORY

- ED GADDY

## ORBITAL ATK (NOW NORTHROP GRUMMAN CORPORATION)

- MIKE MCEACHEN, JIM SPINK, DAVE MURPHY

## NASA JET PROPULSION LABORATORY

- ANDREEA BOCA

## BOEING

- JOHN BEHRENS, MARK BREEN