

**International Journal of Mechanical Engineering and Technology (IJMET)**

Volume 10, Issue 02, February 2019, pp. 44–52, Article ID: IJMET\_10\_02\_0046 Available online at <http://www.iaeme.com/ijmet/issues.asp?JType=IJMET&VType=10&IType=02>  
ISSN Print: 0976-6340 and ISSN Online: 0976-6359

© IAEME Publication



Scopus Indexed

# A WIRELESS SENSOR NETWORK BASED FIRE PROTECTION SYSTEM WITH SMS ALERTS

**Kennedy Okokpujie, Samuel Ndueso John, Etinosa Noma-Osaghae**

Department of Electrical and Information Engineering Covenant University, Ota, Ogun State, Nigeria

**Okokpujie Imhade Princess**

Department of Mechanical Engineering Covenant University, Ota, Ogun State, Nigeria

**Okonigene Robert**

Department of Electrical and Electronics Engineering, *Ambrose Alli University, Ekpoma, Edo State, Nigeria*

## ABSTRACT

*Modern buildings are becoming more complex in technical depth and compartmentalization. The average city dweller also has a complex daily living schedule that sometimes span the entire day with rests taken in between. Existing fire detection technologies have not caught up with the reality of today's complex buildings and way of living. This paper proposes a fire detection system that integrates three capabilities, namely, detection, communication and suppression. It was designed with residential buildings in mind but can be adapted for top notch performance in commercial and other kinds of buildings. It seeks to address the salient issue of real time communication in the face of an unpredictable daily routine and first line suppression moves at the onset of a fire outbreak that most advanced fire detection systems in complex buildings of today have failed to address. The proposed system uses a controller, which comprises of a microcontroller and a Global System for Mobile Communication modem to co-ordinate the operation of a network of radio frequency transmission and reception capable smoke detectors, alarms, the main source of power to the building and a water pump (sprinkler system).*

**Keywords:** wireless sensor networks (WSNs), fire detection, GSM.

**Cite this Article:** Kennedy Okokpujie, Samuel Ndueso John, Etinosa Noma-Osaghae, Okokpujie Imhade Princess and Okonigene Robert, A Wireless Sensor Network Based Fire Protection System with Sms Alerts, International Journal of Mechanical Engineering and Technology, 10(01), 2019, pp. 44–52

<http://www.iaeme.com/IJMET/issues.asp?JType=IJMET&VType=10&IType=02>

## 1. INTRODUCTION

Safety has become the watch word throughout all spheres of life. Governments, organizations and individuals now understand the importance of safety and continue to devise means to ensure its implementation across all walks of life. Natural and man-made disasters [1], which are predominantly unpredictable, have the capacity to cause untold loss of lives and properties. To cope with the unpredictable nature of disasters, man designed systems that can send danger alerts early enough so that preventive steps can be taken to avert colossal loss of lives and properties.

A lot of warning systems have been developed to prevent loss of lives and properties due to fire outbreaks. Fire detection systems are integral parts of modern buildings and billions are spent each year to maintain installed fire detection systems. This maintenance is done to ensure that installed fire detection systems effectively prevent the outbreak of fire. Fire detection systems today are performing more effectively than at any other time because intelligence has been added to its arsenals [2]. New sensors have made it possible to detect danger signs of fire earlier. Wireless systems make it possible for firefighters to strategize on how to combat a fire outbreak before they arrive at the scene. The level of intelligence being implemented to safeguard against fire outbreak in modern buildings today, hold the promise of reducing false alarm, assisting firefighting and speeding up building evacuation in the event of a fire outbreak.

All around the world and on a yearly basis, lives are lost to fire outbreaks and properties worth millions of dollars are destroyed by fire. Residential fires leads the pack and a combo of electrical and domestic accidents are the most common source of fire outbreaks in homes. It has been discovered that buildings with some form of early warning system such as smoke, heat or flame detectors are safe to some extent from catastrophic fire disasters. Fire protection systems are usually tailored to the building's purpose and design [3].

Rapid urbanization and over population have given rise to cities with densely packed residential and commercial buildings [4]. Fire outbreaks are very common in highly populated urban cities. In addition, life in modern cities of today is so complex that the itinerary of a city dweller is usually not stable and for the most part, cannot be predicted. Modern building designs are also becoming more complex and need to be monitored by more effective techniques.

The proposed system has a functional network of smoke detectors that can sense the specific location or origin of smoke, discriminate between fire and non-fire threats, trigger an alarm, suppress fires with a sprinkler system, turn off the main electrical switch in the house and send 'real time' SMS alerts of an impending fire outbreak to the owner of the house, the nearest fire service station, neighbors and friends. The system can be implemented in very large building complexes that have numerous floors and rooms, many of which may be unoccupied. The proposed system can help monitor homes whose occupants may be sleeping or at work[5].

The objectives include creating a network of radio frequency reception and transmission capable smoke detectors, incorporating a mechanism that discontinues the flow of electricity in the event of a fire [6], creating a water-sprinkler system to control the spread of fire and installing a controller that consists of a coordinating microcontroller and a GSM modem that can send text messages in real time.

## 2. RELATED WORK

Mohammad *et al.*, [7] proposed a smart fire detection system with early notification using machine learning. Their work tried to bridge the gap between the fire service department and homes by intelligently detecting potential house fires and alerting the fire service department to them. The core of their work was using machine learning and integrated sensors (sensors that can sense heat, light and smoke) to minimize the probability of false fire alarm. The system proposed by the authors could relay messages about potential house fires to various other service

departments apart from the fire service department. The authors also declared that the proposed system was reliable.

Waghmare and Annamalai [8] proposed a way of detecting fire based on color, shape and motion. In this method, the authors analyzed videos got from cameras using an algorithm that had a computer imaging background. Several frames of pictures taken by cameras were continuously analyzed by embedded fire detection algorithm for any potential fire threats. The fire algorithm was implemented using MATLAB® and tools such as Colour blurring. The authors declare that it was a faster way of detecting house fires and triggering the necessary alarms.

An internet of things based fire alarming and authentication system was proposed by some researchers. A 360° capable camera working in tandem with a raspberry pi microcontroller relay snapshots of any potential fire to a designated administrator who confirms if a potential fire outbreak has actually started or not. Upon confirmation, the microcontroller triggers an alarm and sends a distress message to the nearest fire brigade service. The authors specifically designed the fire detection system for garment factories that tends to have a lot of labyrinths or sharp corners [9].

Sankalp [10] proposed a disaster detection system that is capable of using one sensor to alert necessary parties about impending disaster in a home or workplace. A team of researchers developed and easily deployable compact and energy efficient sensor network that can be used to continuously monitor forest environments for fire outbreaks in their infancy. The researchers tried out their concept in a real life scenario that involved in controlling wildfires. The researchers noted that the result of the trial was very promising. Early forest fire detection and low false alarm rate were the key indicators in the work of these researchers.

Digvijay *et al.*, [11] proposed a fire detection system that can give a live video feed of the exact location where the fire was first detected. The system proposed by these researchers also had the capability of sending messages via a GSM module to concerned parties, alerting them of impending danger. The authors declared that the designed system saves energy by switching the 'live video feed on' only when a fire outbreak has been detected.

A fuzzy logic based fire detection system that depends on a multisensory fire detection network with the added novelty of being a web-based notification system was proposed by Sowah *et al.*, [12] The system could also send message alerts over the conventional GSM network and was designed specifically to address the issue of redundancy in fire detection. The authors wanted a means of ensuring that alerts concerning fire outbreaks almost always get to the designated persons and services along with the location of the fire outbreak.

Simmi *et al.*, [13] focused on fire outbreak that could be caused by gas leakages. The system proposed by the authors first detects the presence of combustible gas and turns on a fan that disperses the gas through assisted ventilation. The proposed system also sends an alert message to those who are concerned about the possibility of a fire outbreak from a gas leak.

A forest fire detection and surveillance system based on GSM and RF modules was suggested by Agarwal *et al.*, [14]. It involves an intensive surveillance system in which almost every tree in a forest was with the hardware necessary to detect their exact location, detect fires and transfer relevant data for further processing. There is general need to carry out research for economic development, and to sustain the exiting wireless network which help to maintained day to day living from fire at break [15-24].

### 3. METHODOLOGY

The proposed system consists of photoelectric smoke sensors with radio frequency transceivers. The smoke detectors are connected to a microcontroller. The microcontroller coordinates the operation of the smoke sensors, a pump that discharges water, a switch (relay) that turns off power

supply to the entire building, an alarm and a GSM module that sends fire outbreak alerts to designated persons and locations.

The system deals with the issue of false alarm by waiting to receive the distress signal repeatedly over a specified period of time.

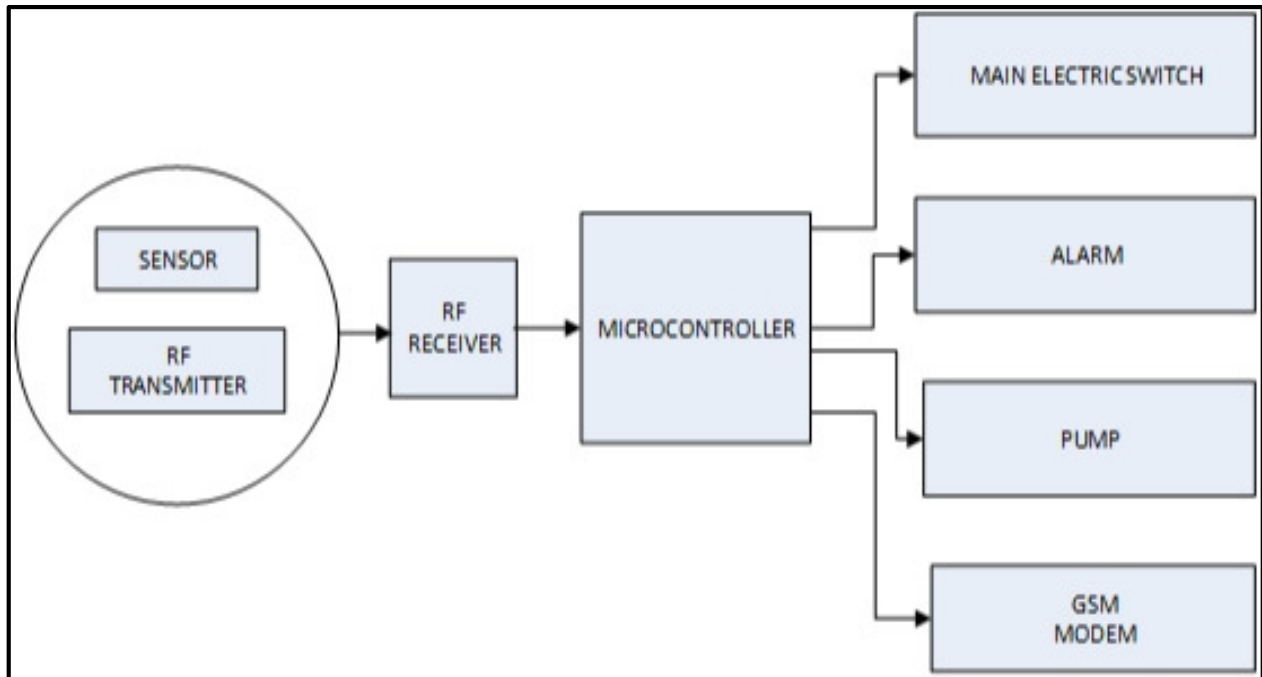

**Figure 1** Block Diagram of the Fire Protection System.

### 3.1. Hardware Implementation

The proposed system was implemented using the following:

1. Microcontroller:Atmega328P.
2. Relay module.
3. GSM modem.
4. Buzzer.
5. Radio transceiver.
6. Smoke detector.

### 3.2. Algorithm for Wireless Fire Alarm System

Initialize the master controller.

Initialize GSM module.

Set GSM module to SMS Mode (AT+CMGS).

Initialize RF Wireless Module.

Initiate connection to smoke detector transmitter circuitry.

Continuously check for fire detection signal.

If fire is detected, do the following:

- (a). Activate siren/alarm.
- (b). Send SMS to the nearest fire fighter station indicating fire outbreak.
- (c). Send SMS to home owner.
- (d). Activate water pump.
- (e). Disable mains distribution board.

Else do nothing, keep checking fire detection

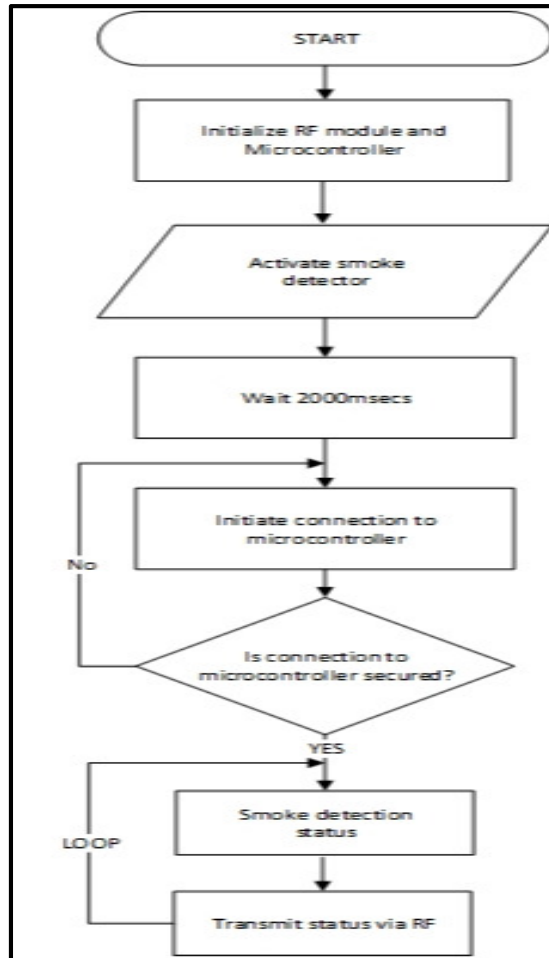

**Figure 2** Flowchart for Smoke Detection Transmitter Circuitry.

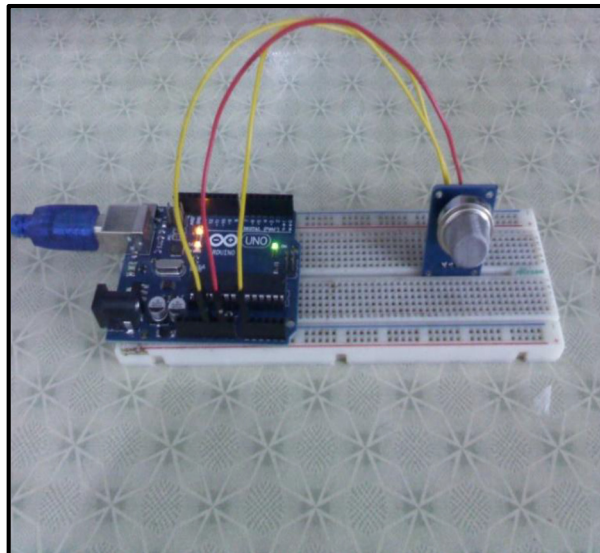

**Figure 3** the Smoke Detector Undisturbed by Smoke Signal

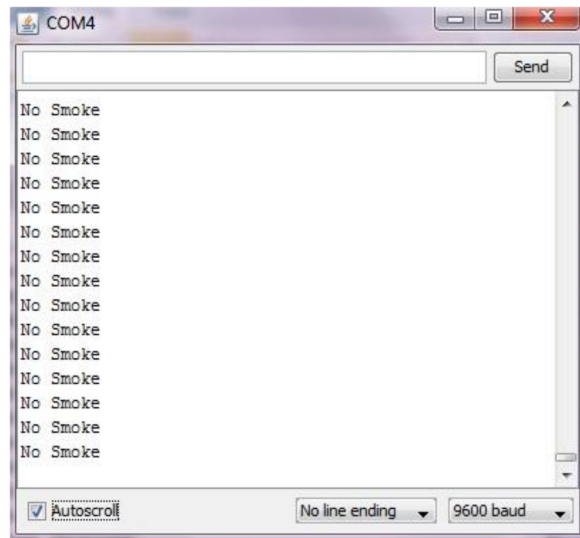

**Figure 4** Application Result when there is no Smoke

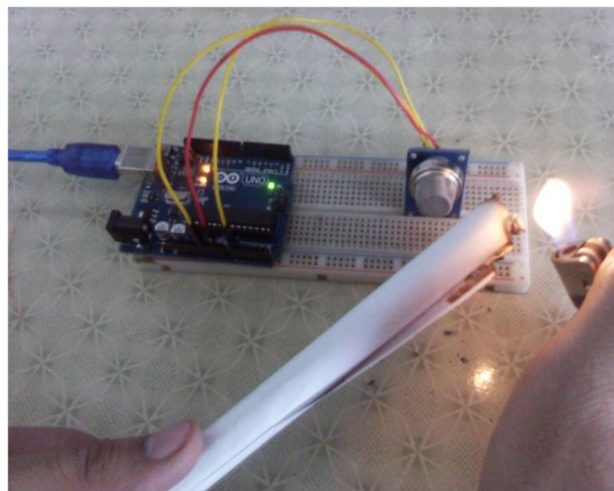

**Figure 5** Application Result when there is Smoke.

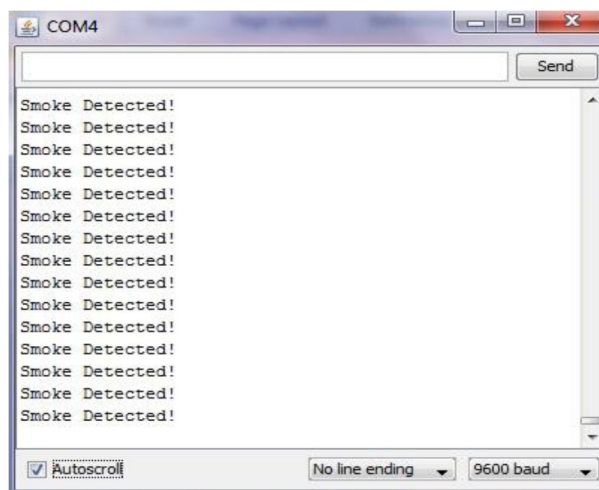

**Figure 6** the Smoke Detector Disturbed by Smoke Signal

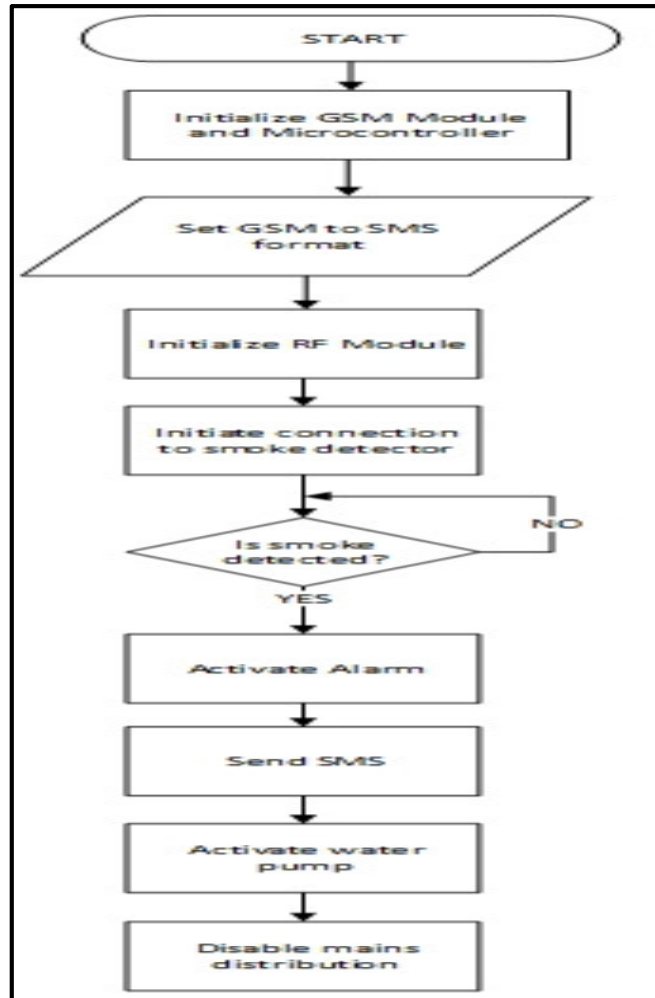

Figure 6 Flowchart for Master Controller Application

### 3.3. The Controller

It consists of the microcontroller and the GSM Module. The microcontroller was programmed using C language. The C program written for the microcontroller enabled it to interface with the smoke detector, alarm, GSM modem, water pump and the switch to the main distribution board.

### 3.4. The Smoke Detector

The smoke detector was able to indicate the presence or absence of smoke. The sensor sets off a local alarm when it detects smoke. The GSM modem works with a GSM wireless network. The device can be connected to a computer via a USB cable. The GSM modem uses a SIM (Subscriber Identification Module) Card to gain access to the wireless network which it uses to transmit and receive information.

### 3.5. The Relay

The relay helps with switching off the main switch in the event of a fire outbreak. When there is a fire outbreak, the microcontroller sends a switching current to the relay which in turn completely turns off the main source of electric power to the affected premises.

#### 4. CONCLUSION

Before The proposed fire detection system made use of wireless sensor networks to detect smoke whilst distinguishing between smoke coming from real fires and from false fires, trigger alarm, send distress messages via a mobile network and cut-off power to the house in the event of a power outbreak. It performed all these functions without any hiccups.

#### ACKNOWLEDGMENT

This work was sponsored by Covenant University, Ota. Ogun State, Nigeria.

#### REFERENCES

- [1] O. Adewoyin, E. O. Joshua, M. Akinyemi, M. Omeje, and E. Joel, "Investigation to determine the vulnerability of reclaimed land to building collapse using near surface geophysical method," 2017.
- [2] A. A. Atayero and A. S. Alatishe, "Design and Construction of a Microcontroller-Based Automatic Irrigation System," in Proceedings of the World Congress on Engineering and Computer Science, 2015.
- [3] J. Azeta, K. O. Okokpujie, I. P. Okokpujie, O. Osemwegie, and A. Chibuzor, "A Plan for Igniting Nigeria's Industrial Revolution," International Journal of Scientific & Engineering Research, vol. 7, p. 489, 2016.
- [4] A. P. Opoko, A. A. Oluwatayo, I. C. Ezema, and C. A. Opoko, "Residents' Perception of Housing Quality in an Informal Settlement," International Journal of Applied Engineering Research, vol. 11, pp. 2525-2534, 2016.
- [5] J. N. Samuel, O. E. Robert, S. C. Peters, and O. Kennedy, "INTELLIGENT PLANT WATERING SYSTEM FOR RURAL FARMERS," in Proceedings of the International Conference on Software Engineering Research and Practice (SERP), 2016, p. 194.
- [6] A. Obiasi, F. Anyasi, O. Okokpuje, J. Erua, and O. Osahenvemwen, "An Innovative Technique in Switching Electrical Appliances: An Omni-Directional RF Remote Control Switch Mechanism," Journal of Engineering and Applied Sciences, vol. 4, pp. 268-271, 2009.
- [7] M. S. Mahmud, M. S. Islam, and M. A. Rahman, "Smart Fire Detection System with Early Notifications Using Machine Learning," International Journal of Computational Intelligence and Applications, p. 1750009, 2017.
- [8] M. Waghmare and M. Annamalai, "Fire Detection Based on Color, Shape and Motion," Image, vol. 4, 2017.
- [9] A. Imteaj, T. Rahman, M. K. Hossain, M. S. Alam, and S. A. Rahat, "An IoT based fire alarming and authentication system for workhouse using Raspberry Pi 3," in Electrical, Computer and Communication Engineering (ECCE), International Conference on, 2017, pp. 899-904.
- [10] S. Mehra, "Disaster detection system using Arduino," in Information Communication and Embedded Systems (ICICES), 2017 International Conference on, 2017, pp. 1-6.
- [11] D. Singh, N. Sharma, M. Gupta, and S. Sharma, "Development of System for Early Fire Detection using Arduino UNO," International Journal of Engineering Science, vol. 10857, 2017.
- [12] R. A. Sowah, A. R. Ofoli, S. N. Krakani, and S. Y. Fiawoo, "Hardware Design and Web-Based Communication Modules of a Real-Time Multisensor Fire Detection and Notification System Using Fuzzy Logic," IEEE Transactions on Industry Applications, vol. 53, pp. 559-566, 2017.
- [13] M. S. Sharma, D. Singh, S. S. Rathore, and P. Bansal, "Fire Detection System with GSM Using Arduino," Imperial Journal of Interdisciplinary Research, vol. 3, 2017.



- [14] A. Agarwal, V. Sharma, R. Singh, A. Ghelot, and K. Bahukhandi, "A Design and Application of Forest Fire Detection and Surveillance System Based on GSM and RF Modules," in *Proceeding of International Conference on Intelligent Communication, Control and Devices*, 2017, pp. 451-459
- [15] K. O. Okokpujie, E. C. Chukwu, E. Noma-Osaghae, I. P. Okokpujie. Novel Active Queue Management Scheme for Routers in Wireless Networks. *International Journal on Communications Antenna and Propagation (I. Re. CAP)*. 2018; 8(1):53-61.
- [16] K. Okokpujie, E. Noma-Osaghae, S. John, K. A. Grace, I. Okokpujie. A face recognition attendance system with GSM notification. In *Electro-Technology for National Development (NIGERCON)*, 2017 IEEE 3rd International Conference on 2017 Nov 7 (pp. 239-244). IEEE.
- [17] K. Okokpujie, O. Shobayo, E. Noma-Osaghae, O. Imhade, O. Okoyeigbo. Realization of MPLS-Based VPN Network for Improved Qos Metrics. *TELKOMNIKA (Telecommunication Computing Electronics and Control)*. 2018; 16.
- [18] K. O. Okokpujie, E. C. Chukwu, E. Noma-Osaghae, M. Odusanmi, I. P. Okokpujie. A UNIQUE MATHEMATICAL QUEUING MODEL FOR WIRED AND WIRELESS NETWORKS. *International Journal of Civil Engineering and Technology (IJCIET)*. 2018 Sep 30;9(9):810-31.
- [19] I. Dunmade, M. Udo, T. Akintayo, S. Oyedepo, I. P. Okokpujie. Lifecycle Impact Assessment of an Engineering Project Management Process—a SLCA Approach. In *IOP Conference Series: Materials Science and Engineering 2018 Sep (Vol. 413, No. 1, p. 012061)*. IOP Publishing.
- [20] I. P. Okokpujie, O. S. Fayomi, R. O. Leramo. The Role of Research in Economic Development. In *IOP Conference Series: Materials Science and Engineering 2018 Sep (Vol. 413, No. 1, p. 012060)*. IOP Publishing.
- [21] E. Noma-Osaghae, K. O. Okokpujie, C. U. Ndujiuba, O. Olatunji, I. P. Okokpujie. Epidemic Alert System: A Web-based Grassroots Model. *International Journal of Electrical and Computer Engineering (IJECE)*. 2018; 8 (5):3809-28.
- [22] Okokpujie KO, Odusami M, Okokpujie IP, Abayomi-Alli O. A Model for Automatic Control of Home Appliances using DTMF Technique. *International Journal of Scientific & Engineering Research*. 2017 Jan 26; 8 (1):266-72.
- [23] K. Okokpujie, E. Noma-Osaghae, S. John, P. C. Jumbo. Automatic home appliance switching using speech recognition software and embedded system. In *Computing Networking and Informatics (ICCNI)*, 2017 International Conference on 2017 Oct 29 (pp. 1-4). IEEE.
- [24] K. Okokpujie, C. Emmanuel, O. Shobayo, E. Noma-Osaghae, I. Okokpujie. Comparative analysis of the performance of various active queue management techniques to varying wireless network conditions. *Int J Elec & Comp Eng*. 2019 Feb; 9 (1):359-68.