

Flow Characterization Studies of the 10-MW TP3 Arc-Jet Facility: Probe Sweeps

Tahir Gökçen and Antonella I. Alunni

AMA Inc., NASA Ames Research Center, Moffett Field, CA 94035

This work is performed at NASA ARC Entry Systems and Technology Division

AIAA Paper 2016-3676

AIAA AVIATION 2016 Conferences: Session TP-10, High Enthalpy Ground Testing
June 13-17, 2016, Washington, DC

Introduction: Arc-Jet Testing, 10-MW TP3 Facility

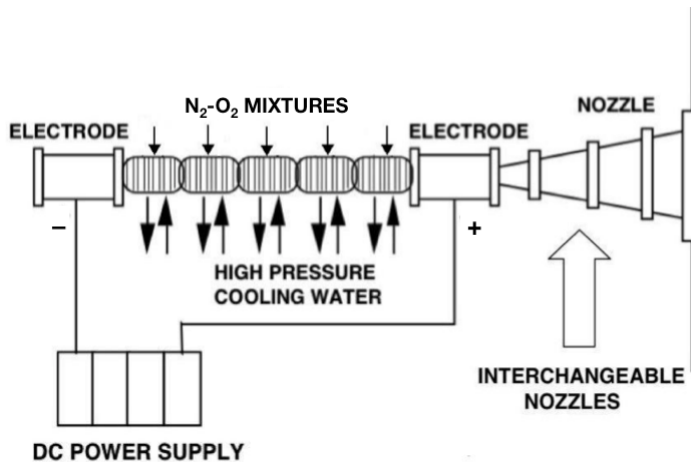

TP3 arc-heater/nozzle sketch

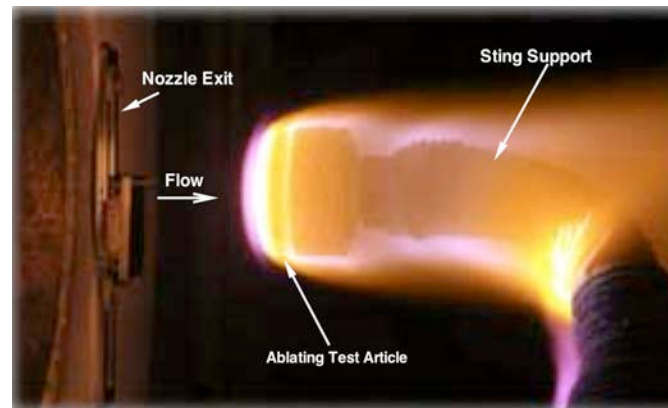

Stagnation coupon test



Wedge test

- Arc-jets provide the primary means to test the performance of various types of thermal protection systems (TPS) in an aerothermodynamic heating environment
- The Aerodynamic Heating Facility (AHF) at NASA Ames Research Center was recently upgraded to run an arc-heater, named TP3
 - 10-MW constricted arc-heater
 - Formerly known as TP2 when operated at NASA Johnson Space Center
 - Currently operates with a test gas mixture of nitrogen and oxygen
 - Testing capability with a N_2 - CO_2 mixture will be added in the near future (Fall 2016)
 - Able to simulate various heating profiles in time representative of hypersonic flight

Objectives and Scope

- Present arc-jet flow characterization data obtained in three test series in the TP3 7.5-inch conical nozzle
 - A flight heating profile was simulated in the arc-jet stream using 10.16-cm diameter flat-faced models (test articles and calorimeters), AHF 307
 - The heating profile was achieved through 7 steps (6 arc-heater conditions, with step 1 condition repeated as step 6 condition), AHF 307
 - Six conditions cover a wide range of facility parameters
 - For each step of the heating profile, surveys of the arc-jet test flow with the pitot and heat flux probes were performed for arc-jet flow characterization (AHF 307, AHF 318, AHF 320)
 - 9.1-mm diameter sphere-cone probes with null-point heat flux gages (AHF 307)
 - 15.9-mm diameter hemisphere probes with Gardon gages (AHF 318, AHF 320)
- Computational fluid dynamics simulations are performed to provide estimates of the arc-jet test environment parameters
 - Centerline total enthalpy
 - Comparisons with the pitot pressure and heat flux survey data

Pitot Pressure and Heat Flux Survey Probes

TP3 7.5-Inch Nozzle Flow



9.1-mm sphere-cone probe, null-point gage

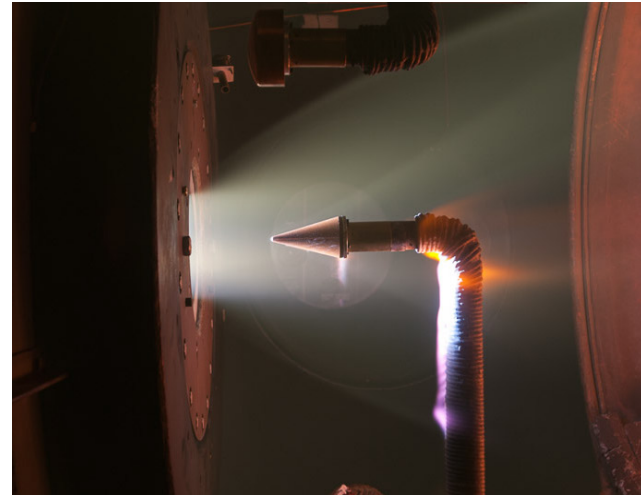

AHF 307 test



15.9-mm hemisphere probe, Gardon gage



AHF 320 test

Computational Approach

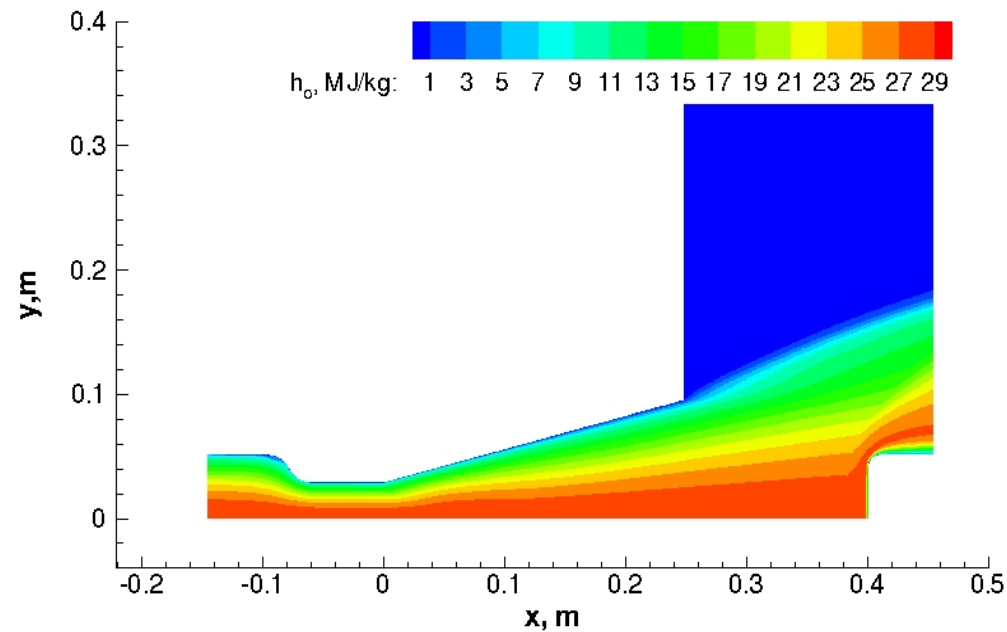
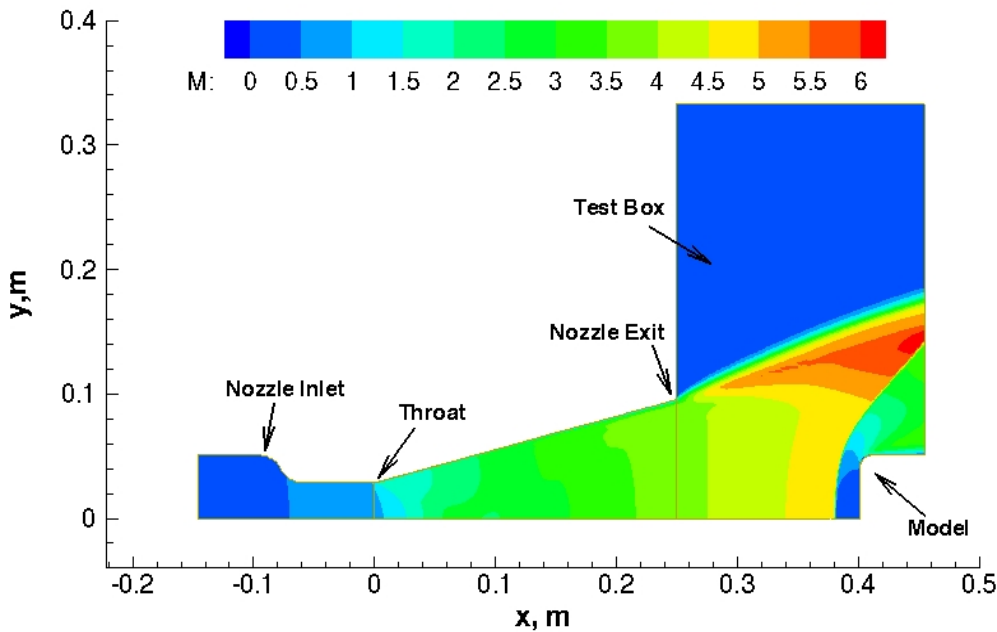

- CFD analysis includes simulation of nonequilibrium flow in the arc-jet facility (the nozzle, test box, over the model)
- Prescribe flow profiles with chemical equilibrium composition at the nozzle entrance; Centerline total enthalpy is set to match the measured slug calorimeter data
- 2-D axisymmetric Navier-Stokes equations with nonequilibrium processes
- Thermochemical model for arc-jet flow
 - Five or six chemical species: N_2 , O_2 , NO , N , O , (Ar, if present)
 - Two-temperature model (Park): T -translational-rotational, T_v -vibrational-electronic
- Data-Parallel Line Relaxation Method - DPLR Code

Presentation of Results

- One stagnation model simulation example
 - Estimate of centerline total enthalpy based on facility and calorimeter data
- Comparisons of computations with the pitot pressure and heat flux survey data
 - TP3-AHF 307, AHF 318 and AHF 320 survey data
 - Two different set of probes
 - The heating profile conditions: step 1 thru step 7 (six conditions covering a wide range of facility parameters)
 - Repeatability of the survey data are given in the paper

Example: Computed Nozzle Centerline and Stagnation Streamline Profiles

Flat-Faced Model ($D = 10.16 \text{ cm}$, $r_c/D = 3/32$), CWFC

TP3 7.5-Inch Nozzle Flow Simulation: $\dot{m} = 190 \text{ g/s}$, $h_{ob} = 17.6 \text{ MJ/kg}$, $h_{ocI} = 28.8 \text{ MJ/kg}$, nonuniform profiles

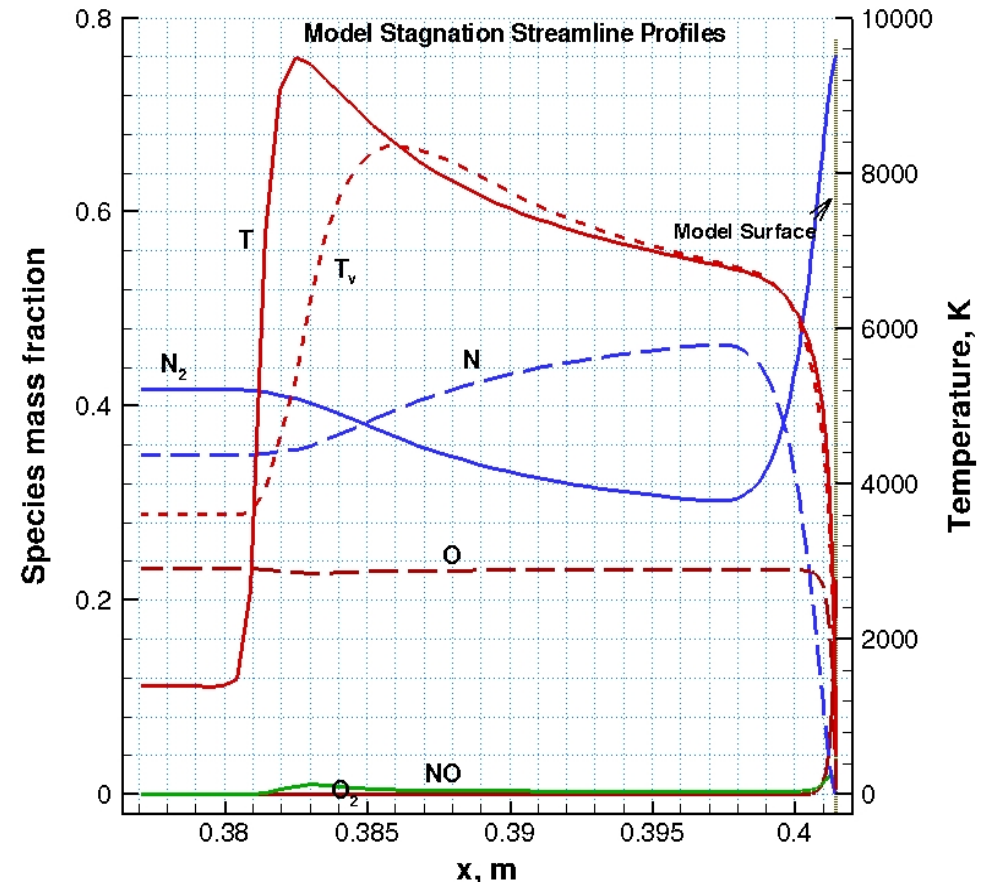
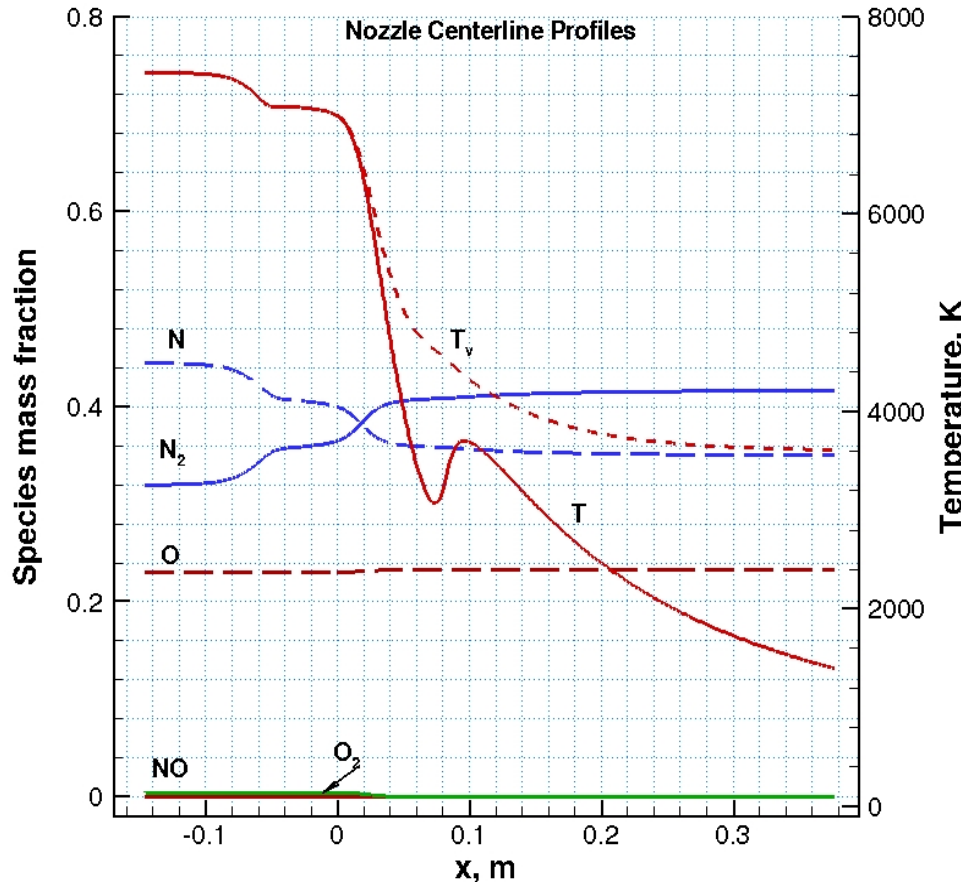

- Flow is in chemical and vibrational nonequilibrium
- Oxygen remains fully dissociated except in the boundary layer (and shear layer)
- Nitrogen is partially dissociated

Example Case: Prescribed Nozzle Inlet Profiles

TP3 7.5-Inch Nozzle Flow Simulation: $\dot{m} = 190 \text{ g/s}$, $h_{ob} = 17.6 \text{ MJ/kg}$, $h_{ocl} = 28.8 \text{ MJ/kg}$, nonuniform profiles

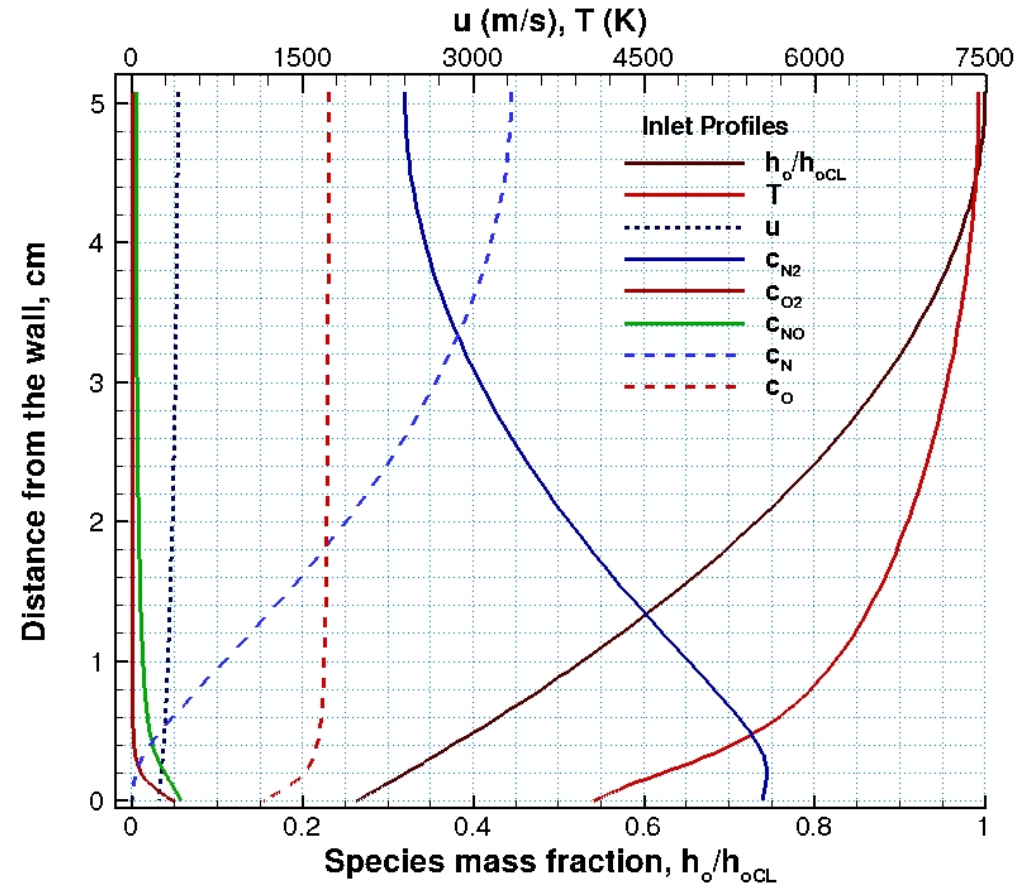
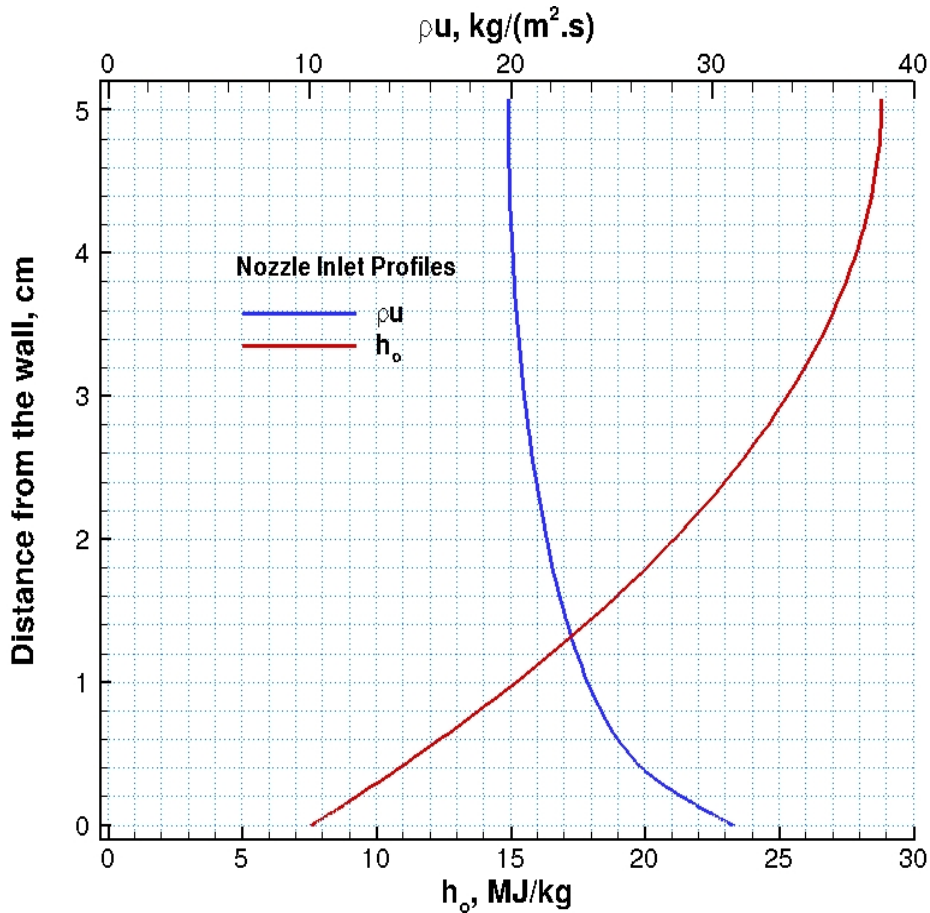

- Uniform pressure and parabolic enthalpy profiles are specified at the nozzle inlet
- Species concentrations and other flow properties are calculated from thermochemical equilibrium relations

Example: Computed Model Surface Heat Flux and Pressure

Flat-Faced Model ($D = 10.16 \text{ cm}$, $r_c/D = 3/32$), CWFC

TP3 7.5-Inch Nozzle Flow Simulation: $\dot{m} = 190 \text{ g/s}$, $h_{ob} = 17.6 \text{ MJ/kg}$, $h_{ocl} = 28.8 \text{ MJ/kg}$, nonuniform profiles

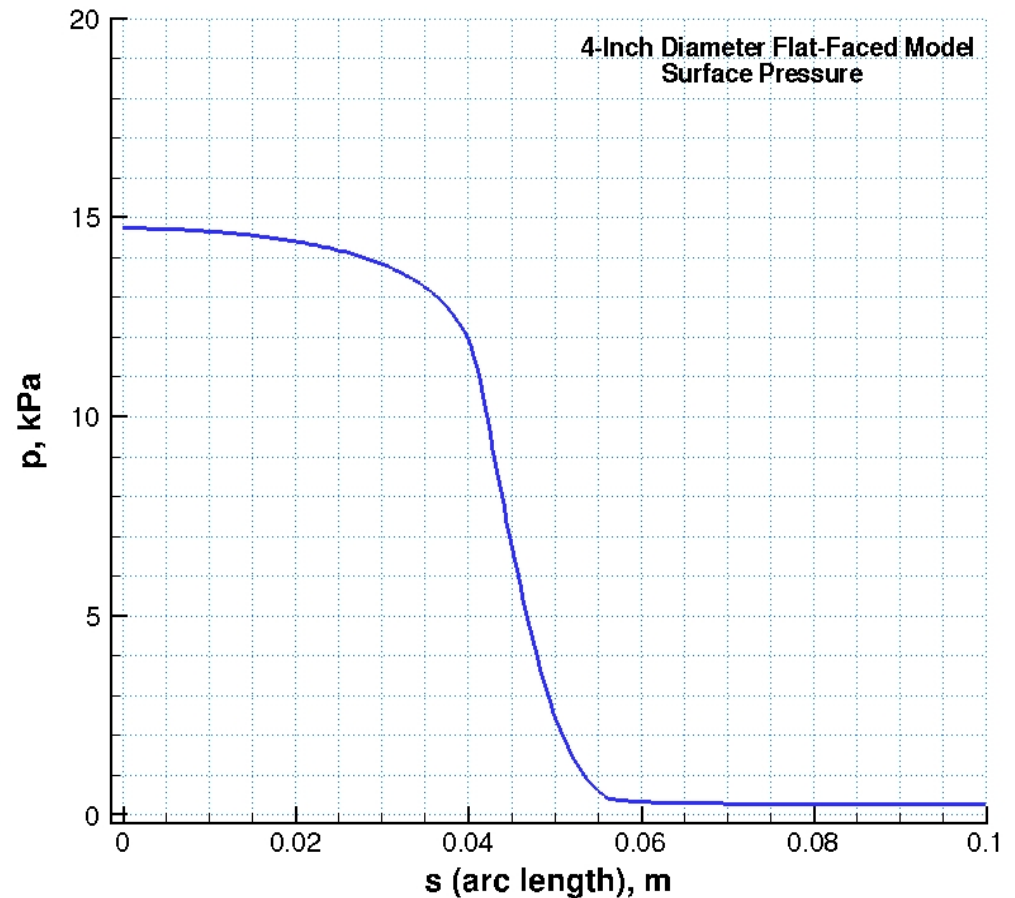
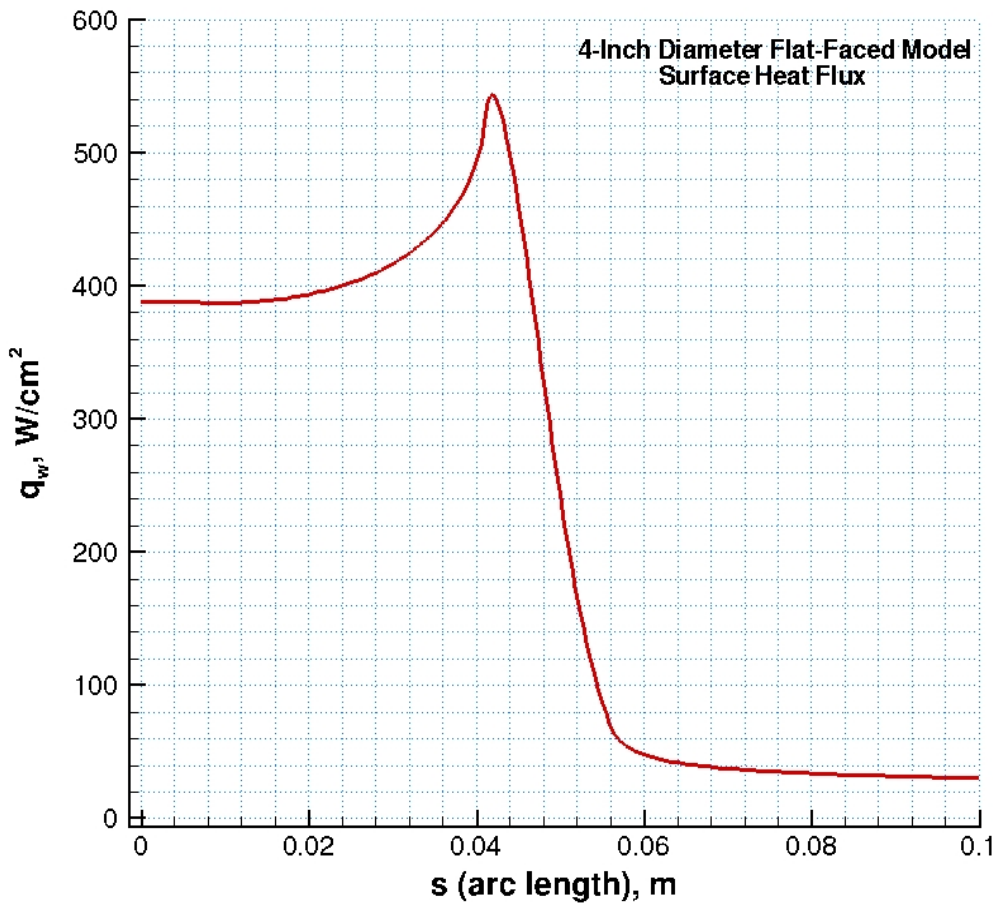

- Averaged calorimeter data from AHF 307 runs 11-2 and 12-2: 388 W/cm^2 and 14.75 kPa
- Centerline total enthalpy is determined to reproduce the measured slug calorimeter data
- At the nozzle inlet: parabolic enthalpy profile, and the mass flux profile is based on pressure and enthalpy

Comparisons of Computations with Pitot Pressure and Heat Flux Survey Data

Test Series: AHF 307	I (A)	V (V)	\dot{m} (g/s)	p_{midc} (kPa)	q_s (W/cm ²)	p_s (kPa)	h_{ob} (MJ/kg) CFD	h_{ocl} (MJ/kg) CFD	q_{HWFC} (W/cm ²) CFD	Cond No.
Runs 14-1–35-1	262	1264	25	25.4	58.6	1.74	11.8	13.8	51.5	1
Runs 11-2, 12-2	1113	3401	190	220	388	14.8	17.6	28.8	349	2
Runs 8-1, 9-1	1762	5187	501	558	730	36.0	16.4	34.1	497	3
Runs 6-1, 7-1	1214	3946	310	311	335	21.5	13.6	21.9	292	4
Runs 3-2, 4-1	419	1683	40	43	118	3.3	15.4	19.6	104	5
Runs 3-3, 4-2	716	3681	310	251	114	17.0	7.5	9.4	89	6
AHF 320										
Runs 5-3, 6-3	1756	4861	500	516	593	33.5	13.9	29.9	N/A	3
Runs 3-4, 4-4	1204	3637	310	293	266	19.3	10.3	18.8	N/A	4

Conditions 4 and 6 include cold-gas injection at the plenum, 20% and 28% of the total mass flow rate, respectively.

- Pitot pressure and heat flux surveys were performed at separate arc-jet runs at the same nominal arc-heater conditions (current and mass flow rate)
- Six conditions cover a wide range of facility parameters: arc current varies from 262 A to 1762 A, and total mass flow rate from 24 g/s to 501 g/s
- Two conditions with cold-gas N₂ injection at the arc-heater plenum

Comparisons of Computations with Survey Data (step 1, AHF 307)

TP3 7.5-Inch Nozzle Flow Simulation: $\dot{m} = 25$ g/s, $h_{ob} = 11.8$ MJ/kg, $h_{ocl} = 13.8$ MJ/kg, $p_{box} = 0.05$ torr

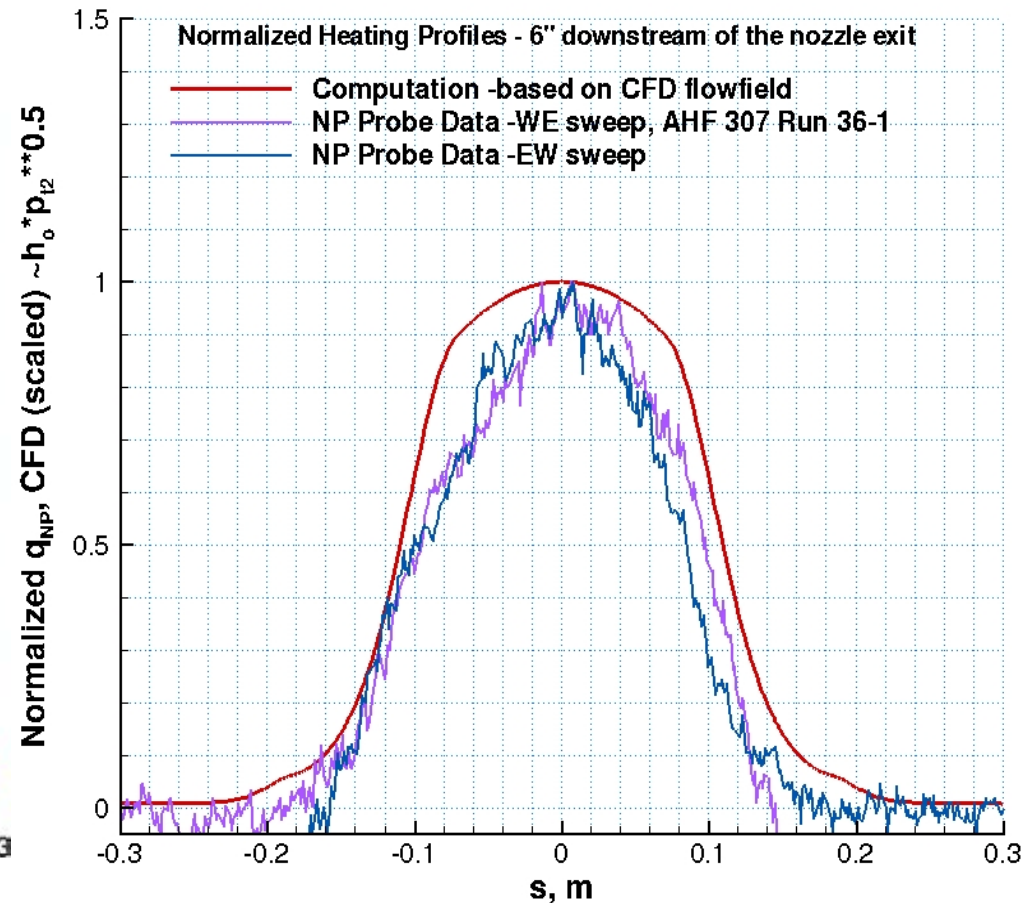
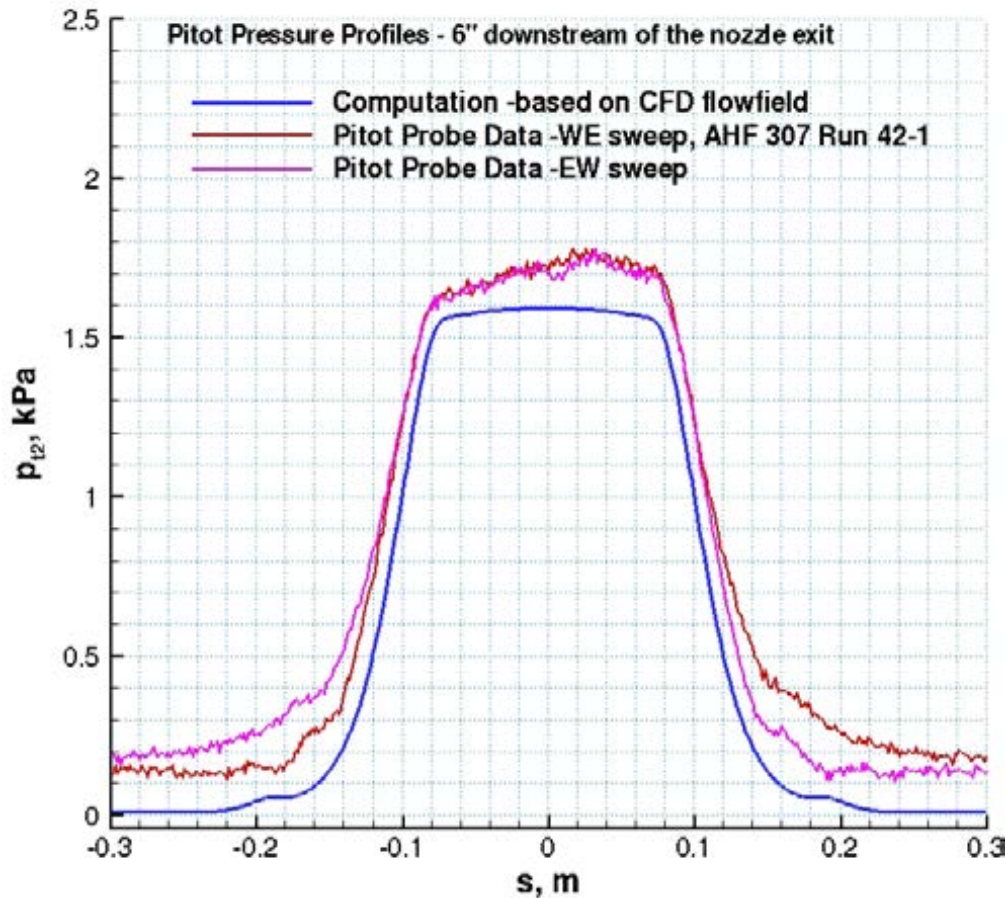

- This case represents a facility condition at an **extremely low mass flow rate, moderate enthalpy and without plenum gas injection**
- The pitot pressure data show an incomplete recovery to the test box pressure and a larger core than computations (probes were moving too fast to equilibrate at these lower pressures); and it is not symmetric
- Heat flux surveys show a more peaked distribution than computations

Comparisons of Computations with Survey Data (step 1, AHF 320)

TP3 7.5-Inch Nozzle Flow Simulation: $\dot{m} = 25$ g/s, $h_{ob} = 11.8$ MJ/kg, $h_{ocl} = 13.8$ MJ/kg, $p_{box} = 0.7$ torr

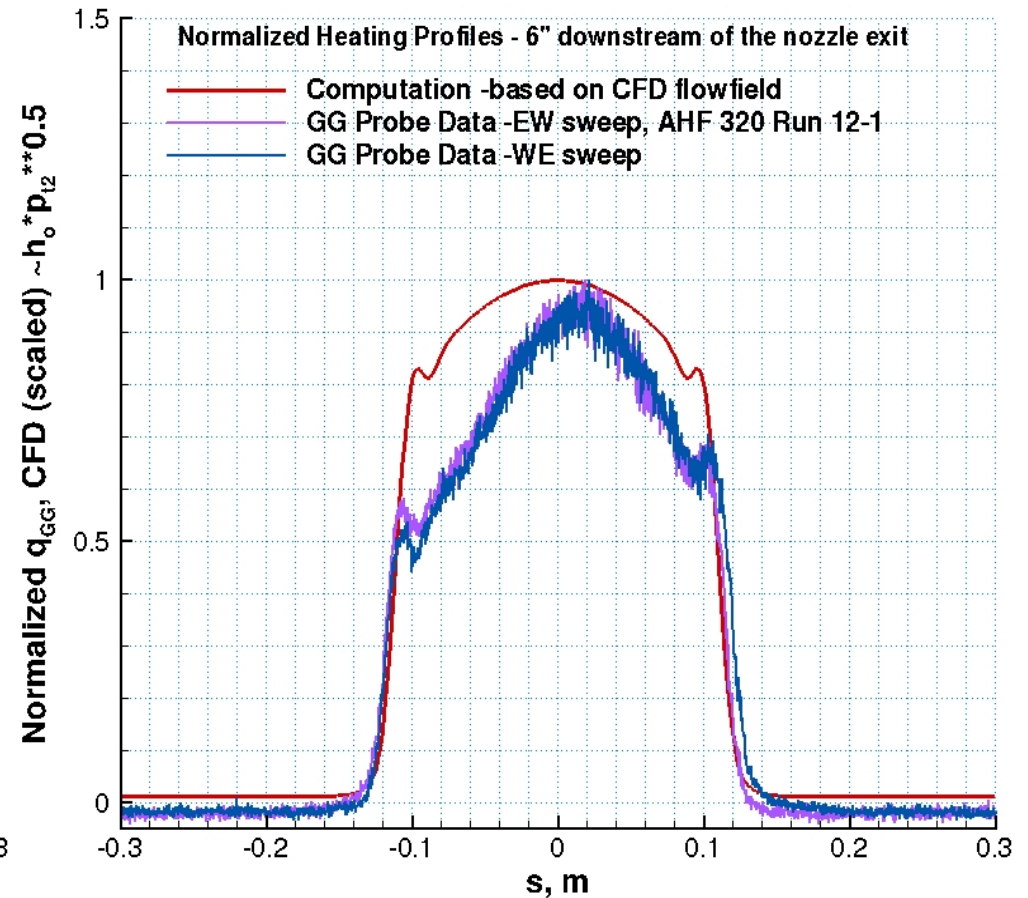
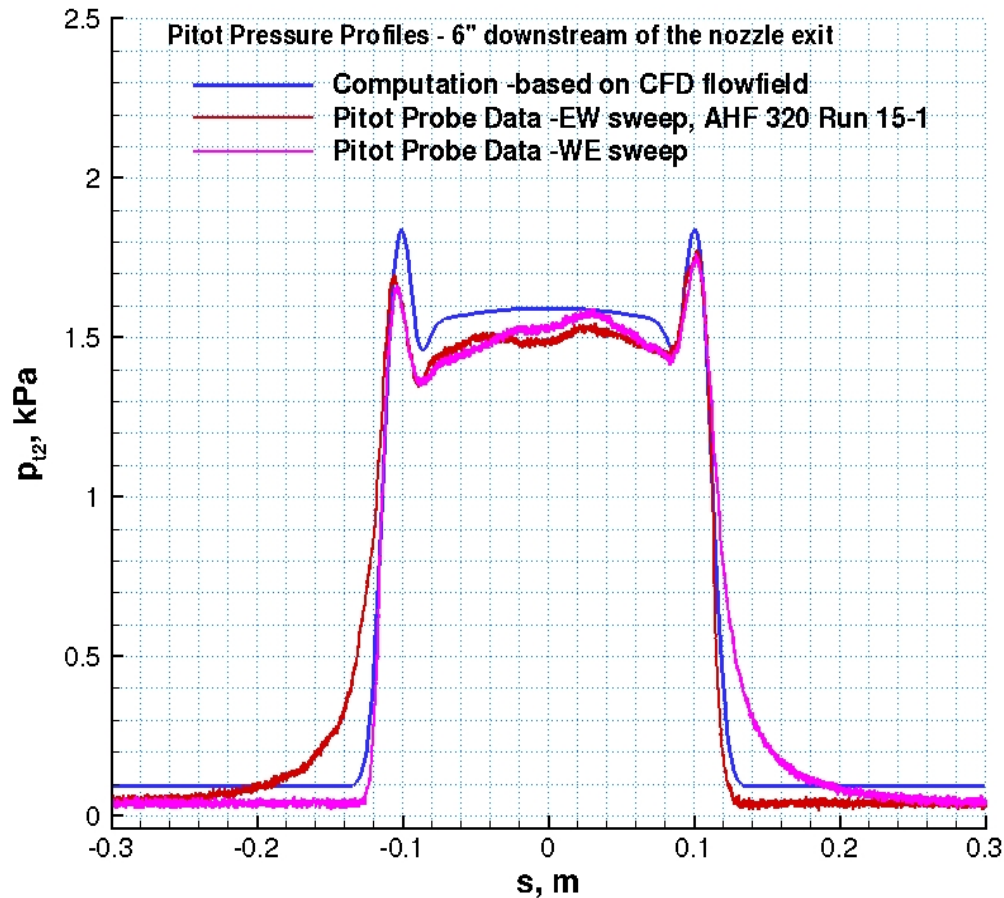

- Pitot probe speed is too high when probes are outside the core flow
- 15.9-mm probe measurements are sensitive to the probe speed, especially at lower pressures
- The heat flux data show an asymmetric distribution (also more peaked than computations)
- Note that the test box pressure for AHF 320 is higher than for AHF 307

Repeatability of 15.9-mm Probe Survey Data (step 1, AHF 320)

TP3 7.5-Inch Nozzle Flow: $\dot{m} = 25$ g/s, $I = 279$ A, $p_{midc} = 27.5$ kPa, $p_{box} = 0.7$ - 0.8 torr

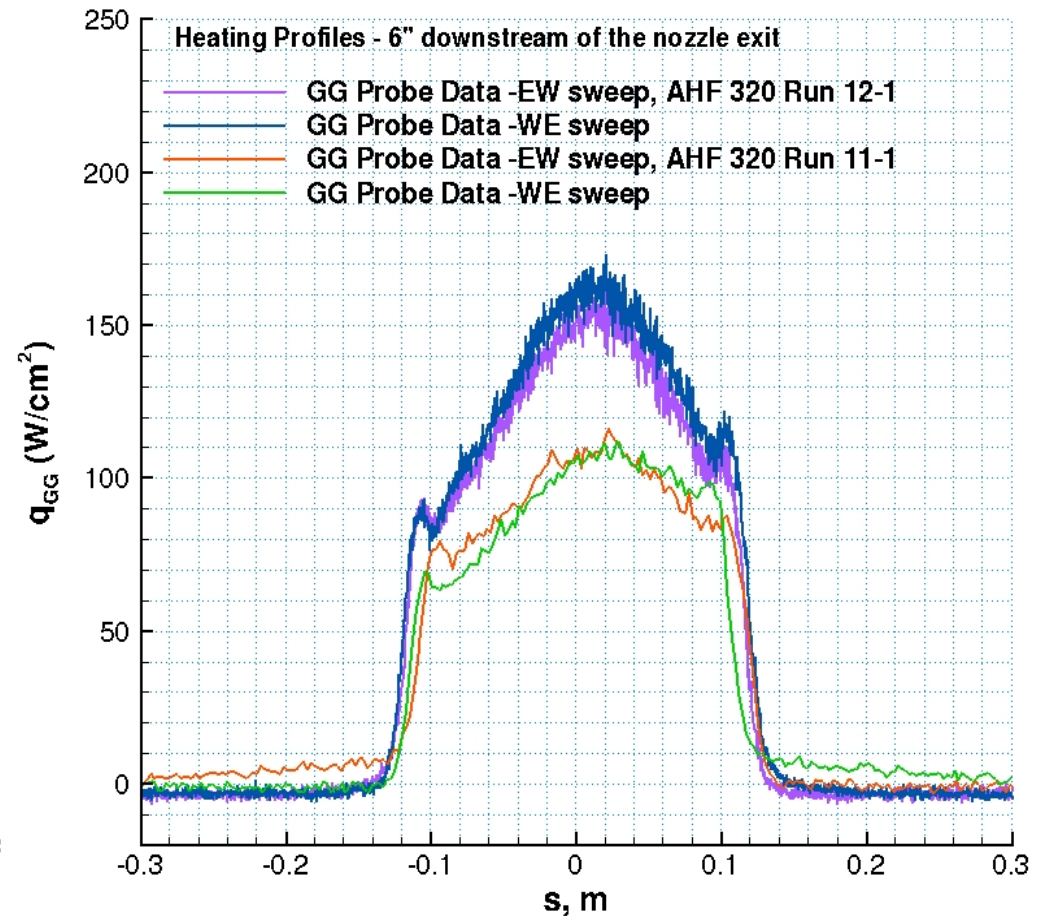
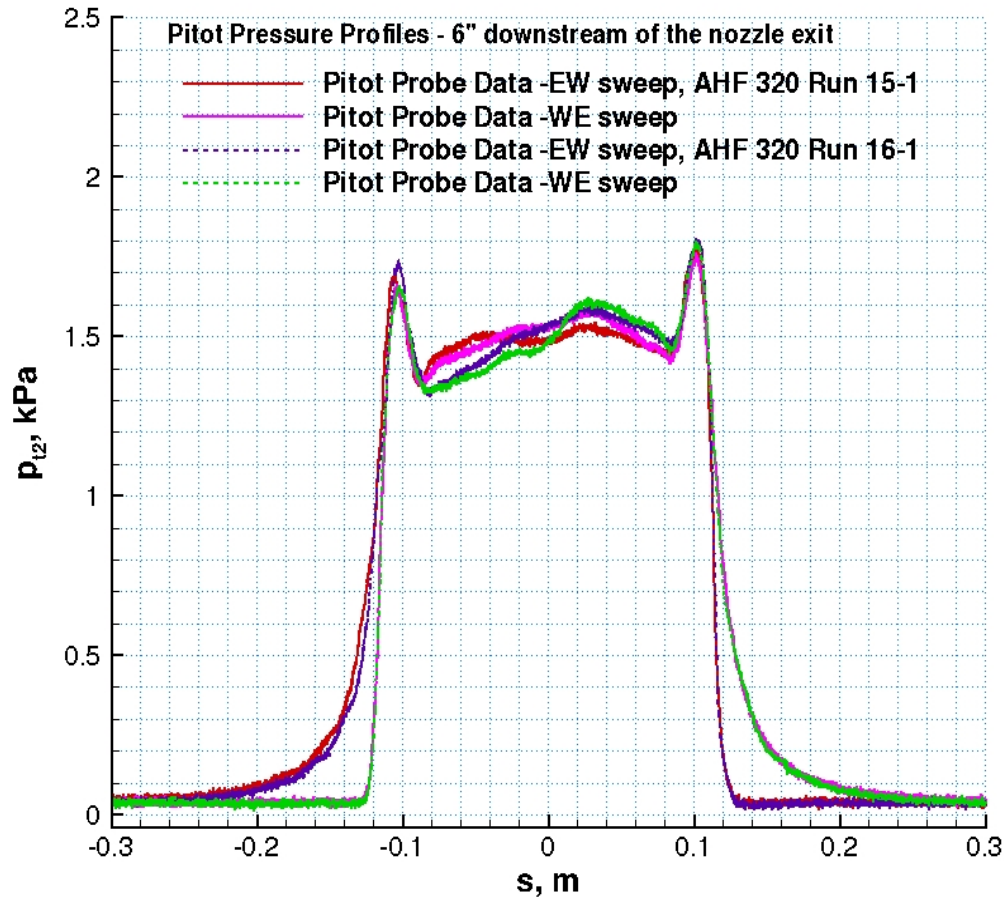

- The pitot probe data are reasonably repeatable
- The heat flux data show an asymmetric distribution, not very repeatable
- Quantitative heat flux values from the Gardon gage probe are not used: normalized distribution is used for comparisons
- Approximate probe dwell times: 50 s for Runs 15-1 and 16-1, and 1.2 s for Run 11-1, 12 s for Run 12-1

Effects of Test Box Pressure on Computed Flowfield and Survey Data

TP3 7.5-Inch Nozzle Flow Simulation: $\dot{m} = 25$ g/s, $h_{ob} = 11.8$ MJ/kg, $h_{ocl} = 13.8$ MJ/kg

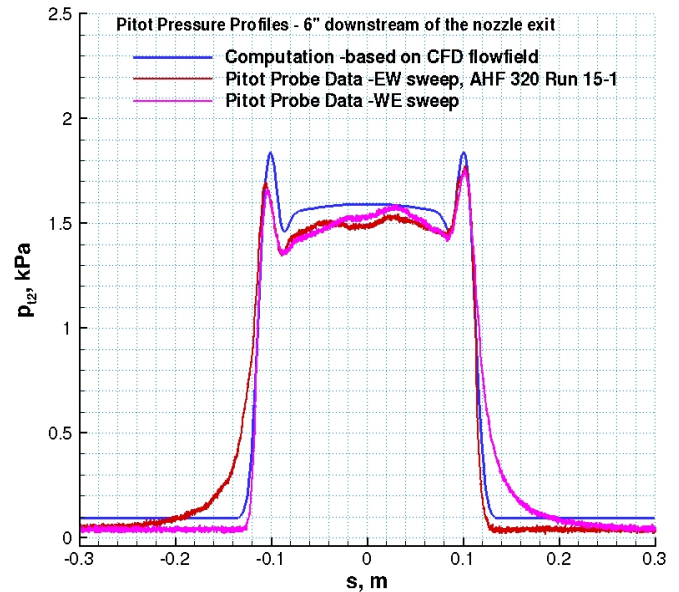
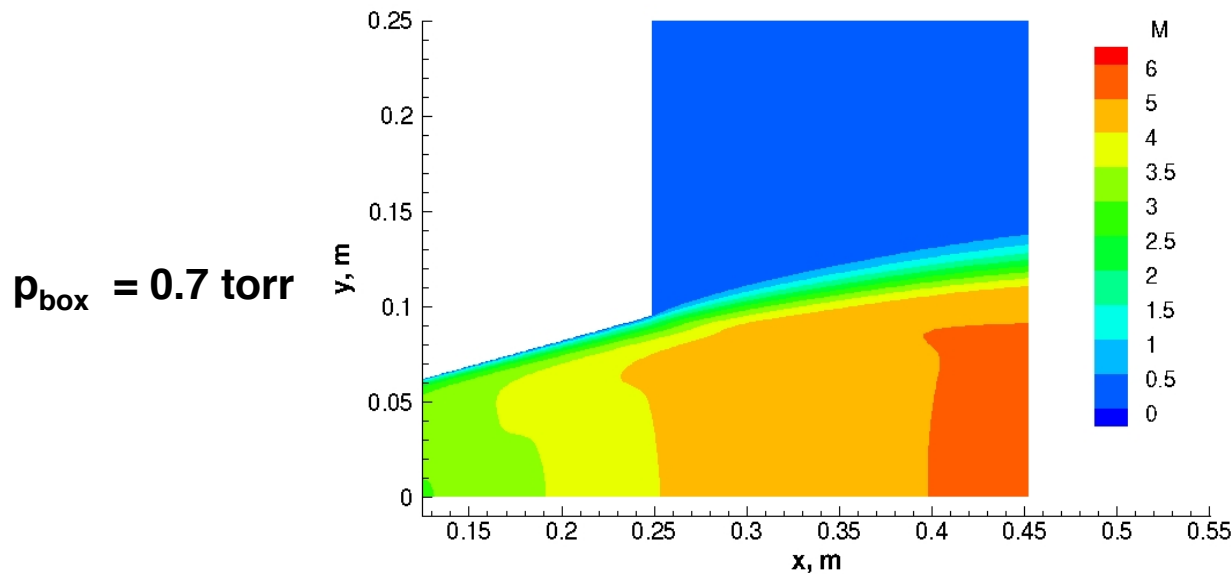
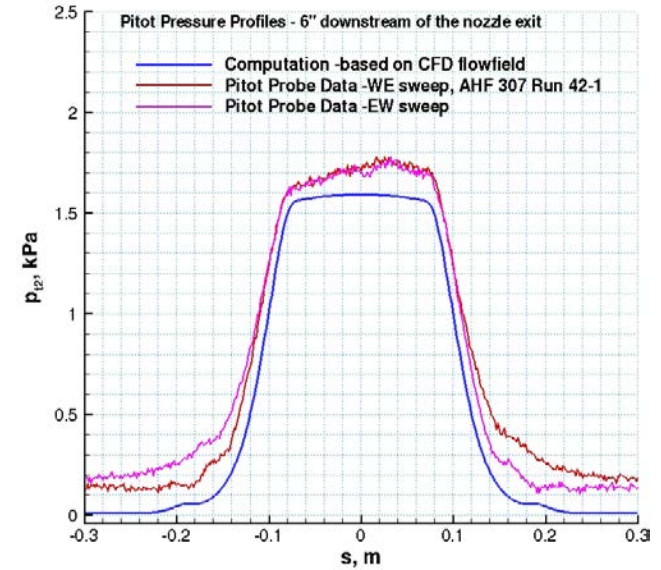
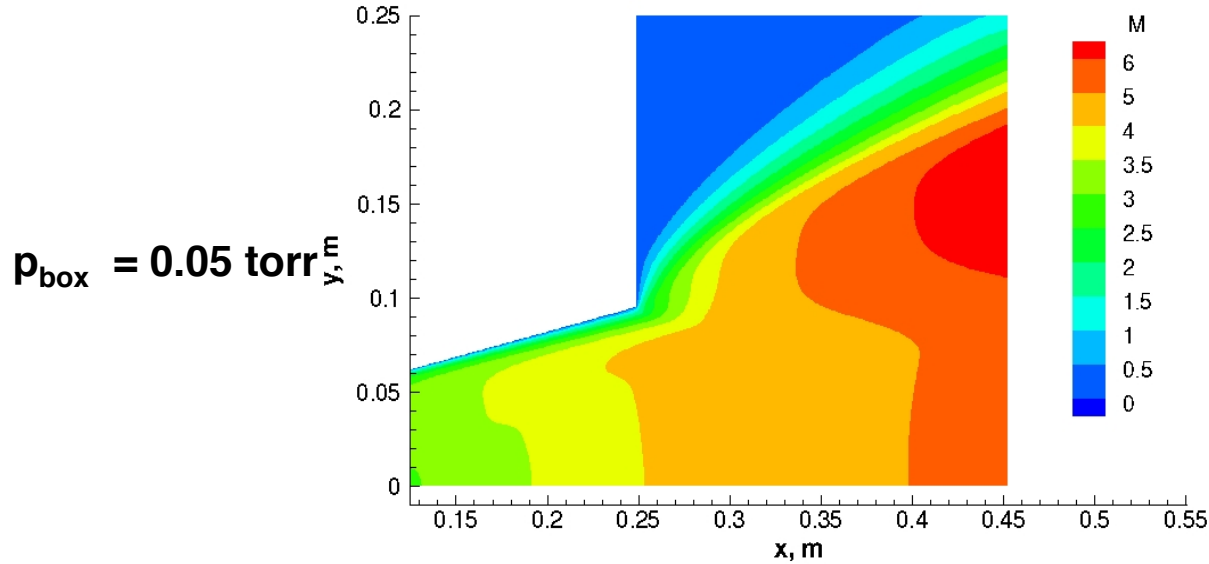

Comparisons of Computations with Survey Data (step 2, AHF 307)

TP3 7.5-Inch Nozzle Flow Simulation: $\dot{m} = 190$ g/s, $h_{ob} = 17.6$ MJ/kg, $h_{ocl} = 28.8$ MJ/kg, $p_{box} = 0.4$ torr

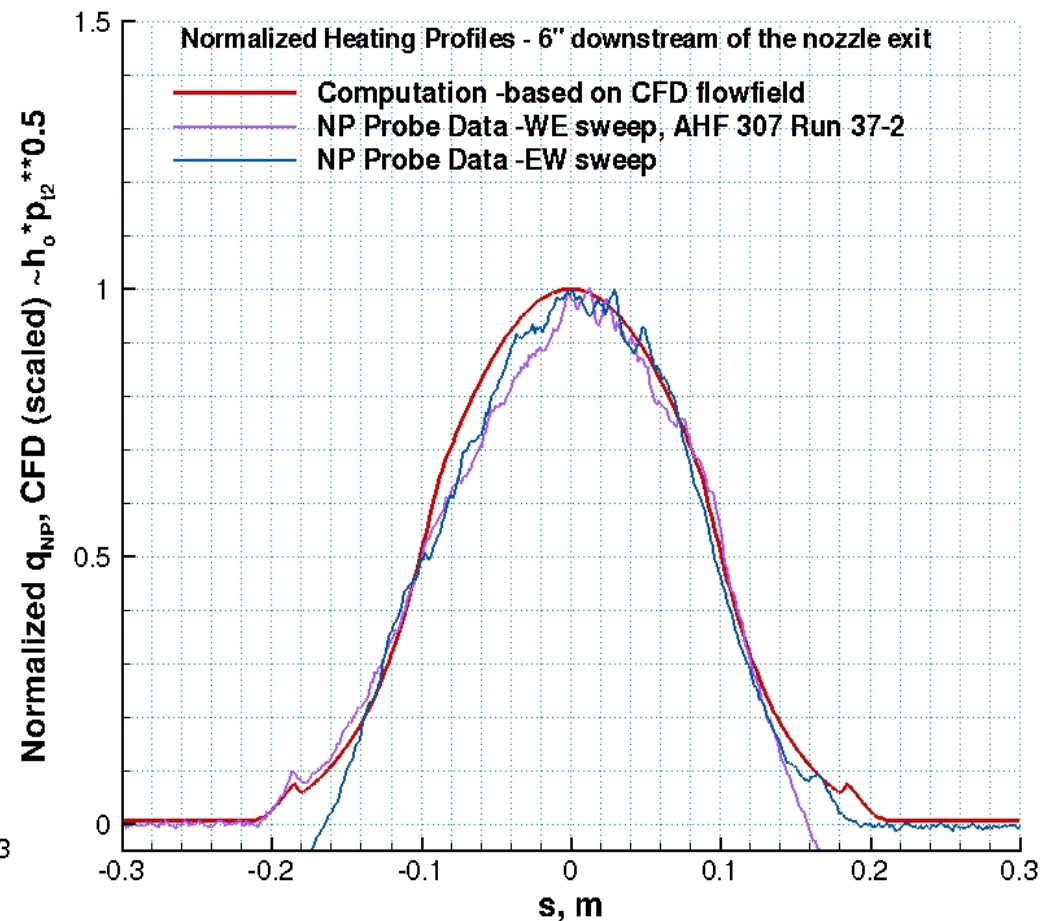
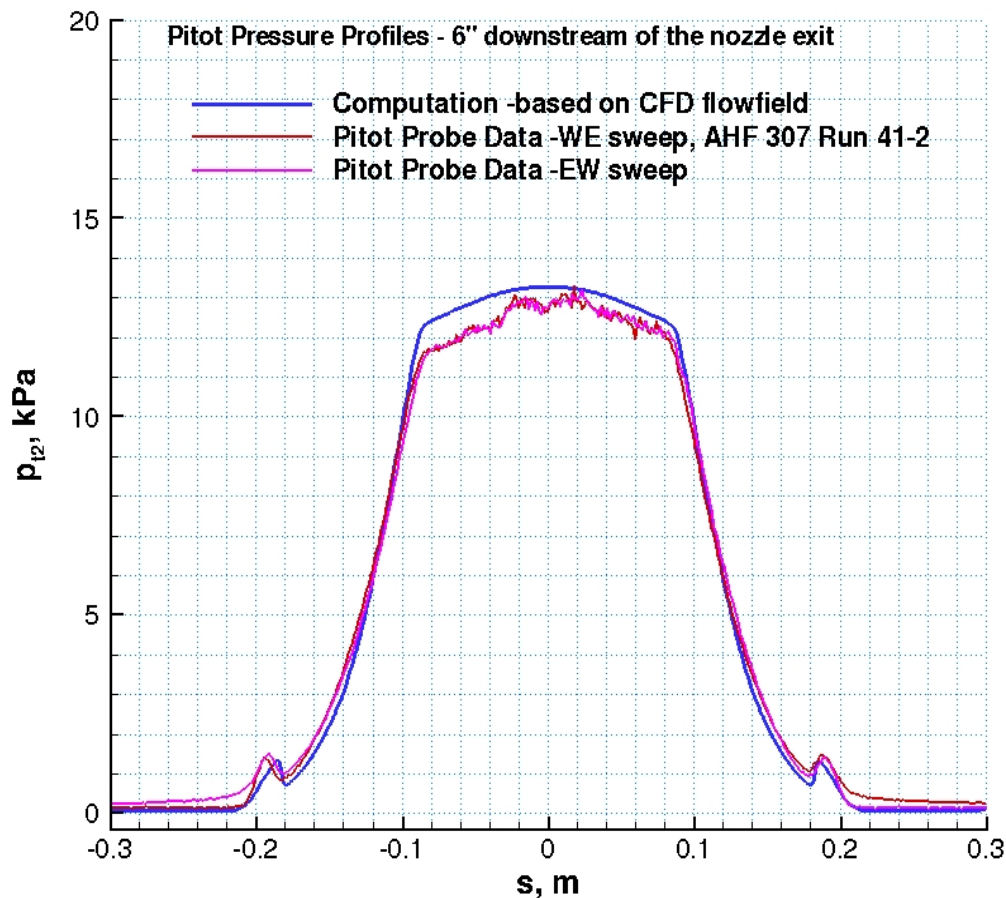

- This case represents a facility condition at an **intermediate mass flow rate, relatively high enthalpy** and **without plenum gas injection**
- CFD simulations reproduce the survey data quite well

Comparisons of Computations with Survey Data (step 2, AHF 320)

TP3 7.5-Inch Nozzle Flow Simulation: $\dot{m} = 190$ g/s, $h_{ob} = 17.6$ MJ/kg, $h_{ocl} = 28.8$ MJ/kg, $p_{box} = 0.4$ torr

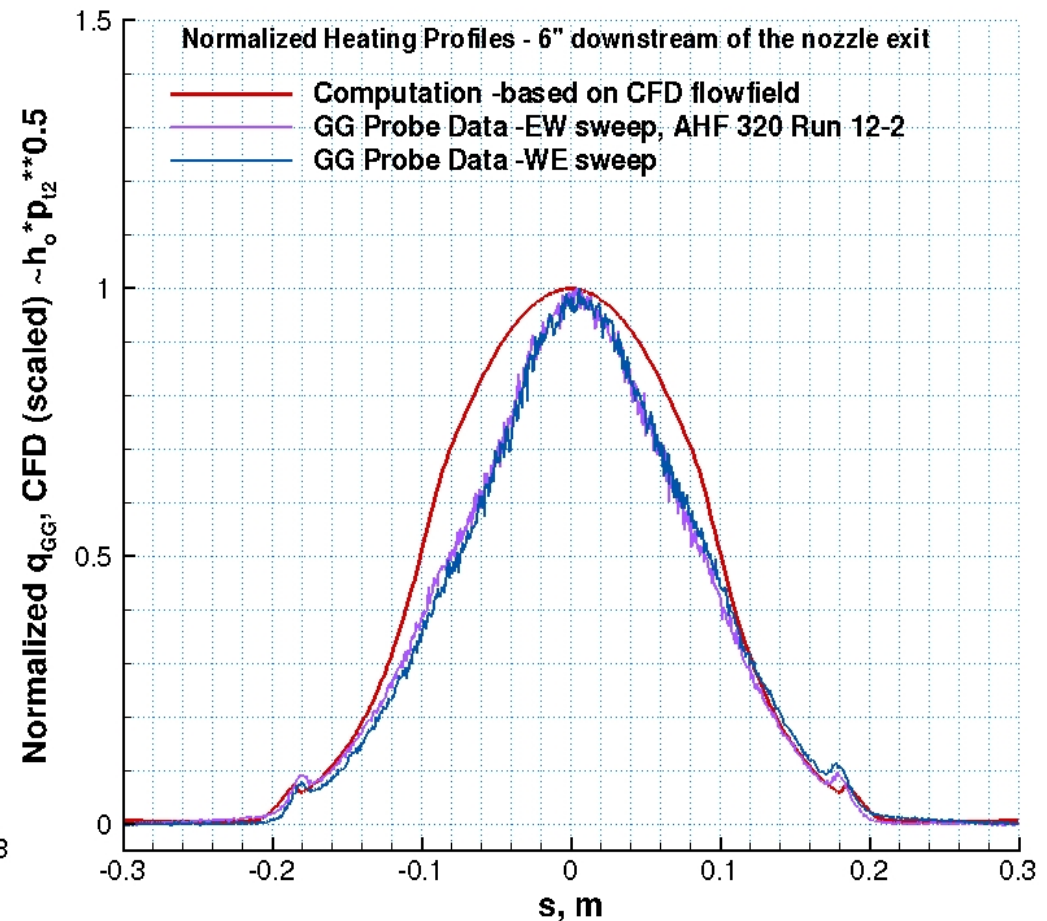
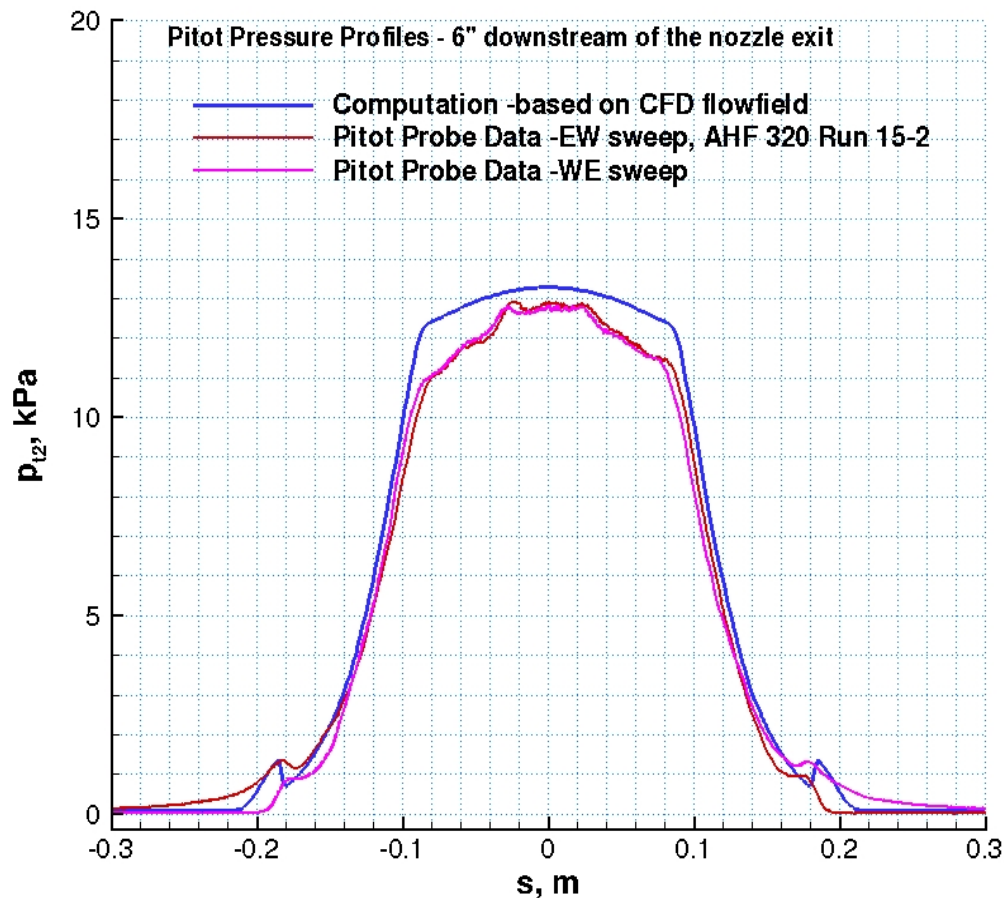

- The heat flux survey data show a highly peaked distribution (like a triangle), much more than computations
- Note the feature in the pitot pressure data near the nozzle centerline: possibly weak wave interactions

Repeatability of 15.9-mm Probe Survey Data (step 2, AHF 320)

TP3 7.5-Inch Nozzle Flow: $\dot{m} = 190 \text{ g/s}$, $I = 1110 \text{ A}$, $p_{midc} = 205 \text{ kPa}$

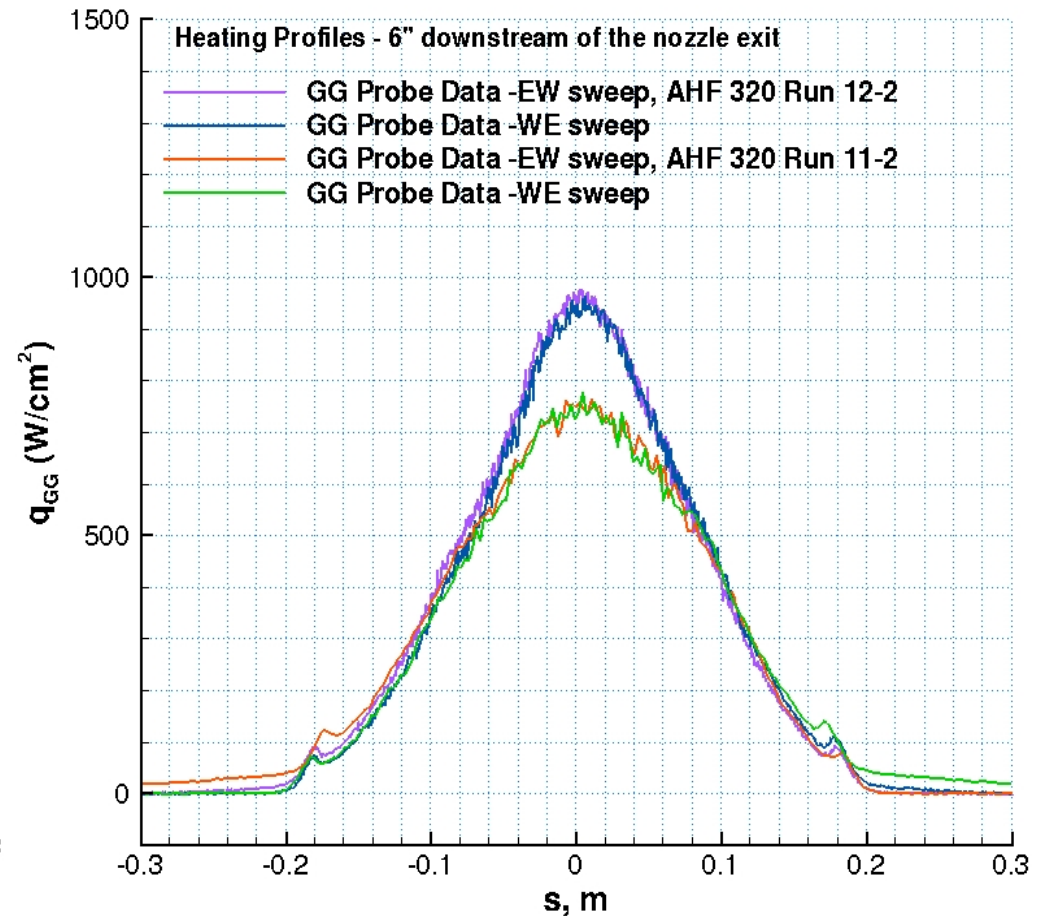
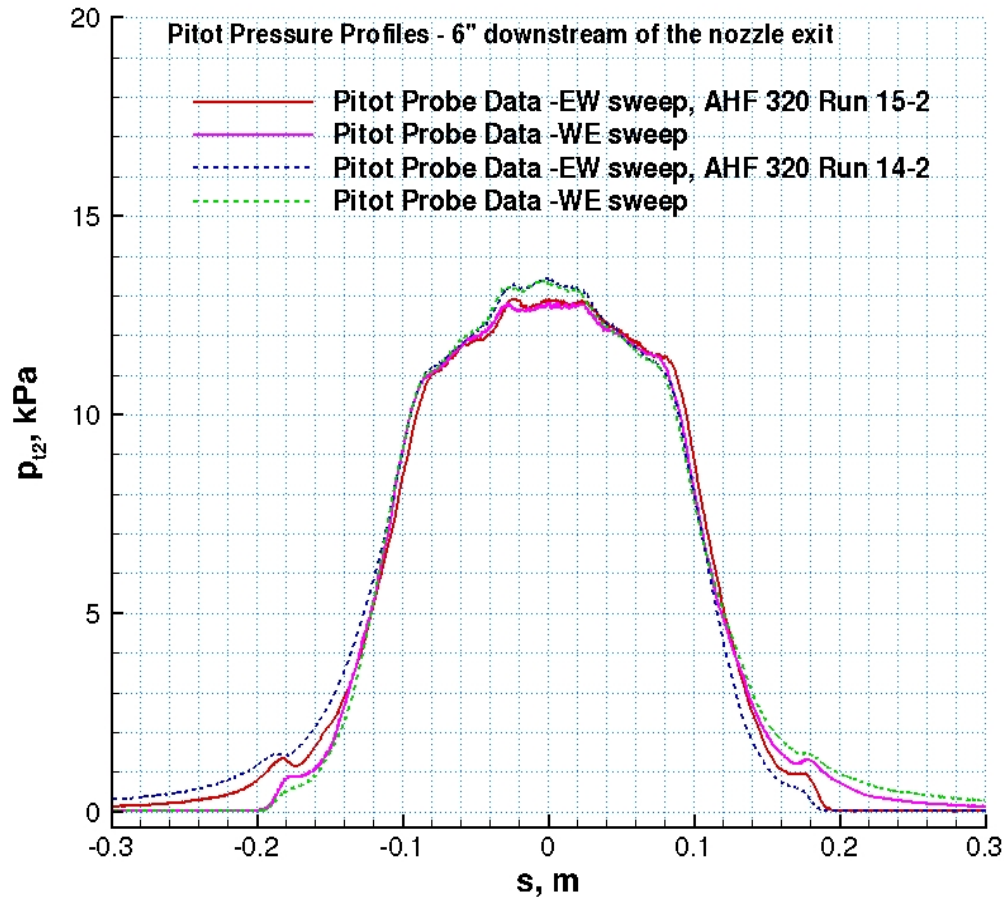

- The pitot probe data are repeatable
- The heat flux data show a symmetric distribution (approximately), not repeatable
- Probe dwell times: 15 s and 30 s for Runs 14-2 and 15-2, and 1.6 s and 7 s for Runs 11-2 and 12-2

Comparisons of Computations with Survey Data (step 3, AHF 307)

TP3 7.5-Inch Nozzle Flow Simulation: $\dot{m} = 501$ g/s, $h_{ob} = 16.4$ MJ/kg, $h_{ocl} = 34.1$ MJ/kg, $p_{box} = 1$ torr

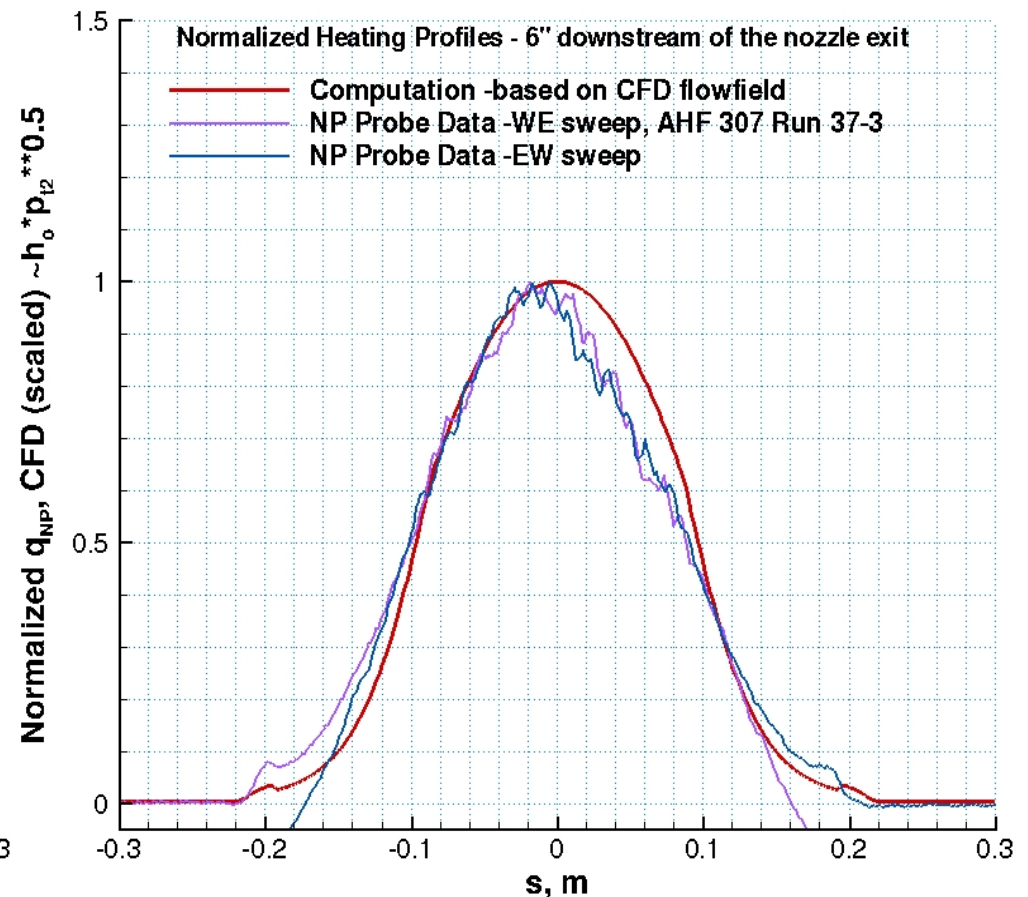
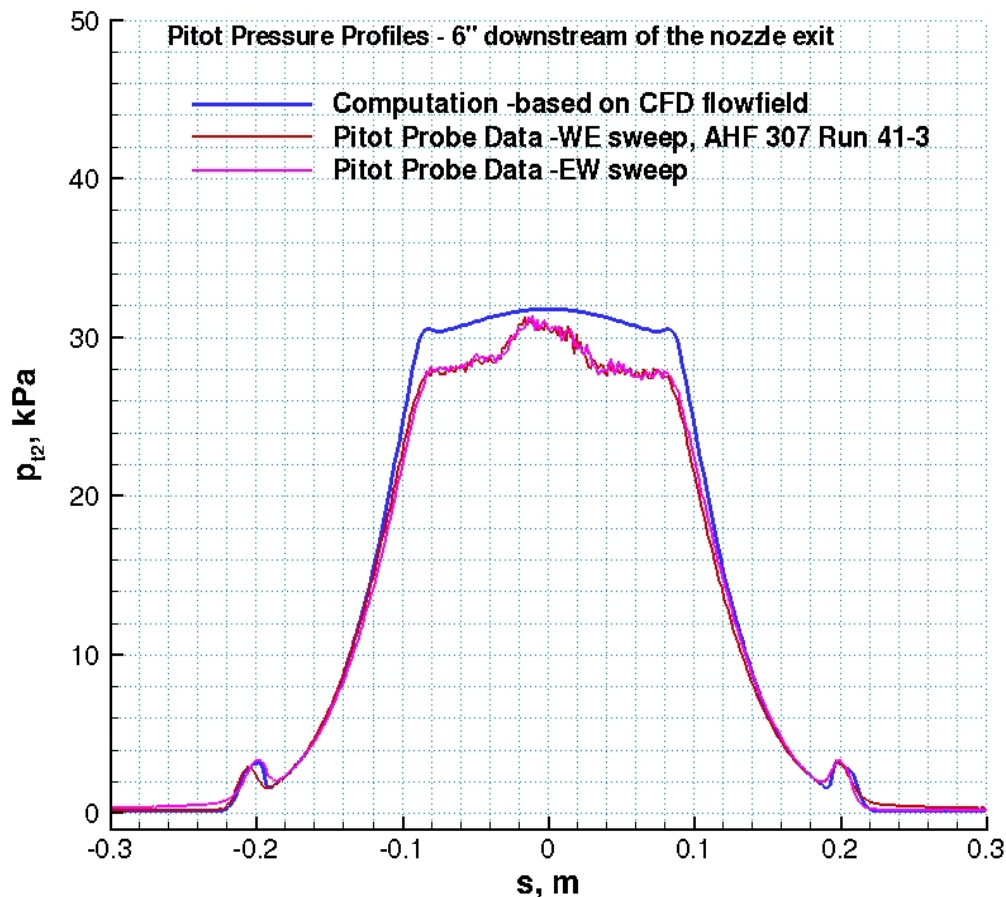

- This case represents a facility condition close to **the facility max (mass flow rate and current)** at high enthalpy and **without plenum gas injection**
- Pitot surveys show interesting features: somewhat higher pressure region near the nozzle centerline, possibly as a result of some disturbances in the nozzle flowfield; slightly asymmetric (skews to the west)
- Estimated total enthalpy is quite high for this facility

Comparisons of Computations with Survey Data (step 3, AHF 320)

TP3 7.5-Inch Nozzle Flow Simulation: $\dot{m} = 500$ g/s, $h_{ob} = 13.9$ MJ/kg, $h_{ocl} = 29.9$ MJ/kg, $p_{box} = 1$ torr

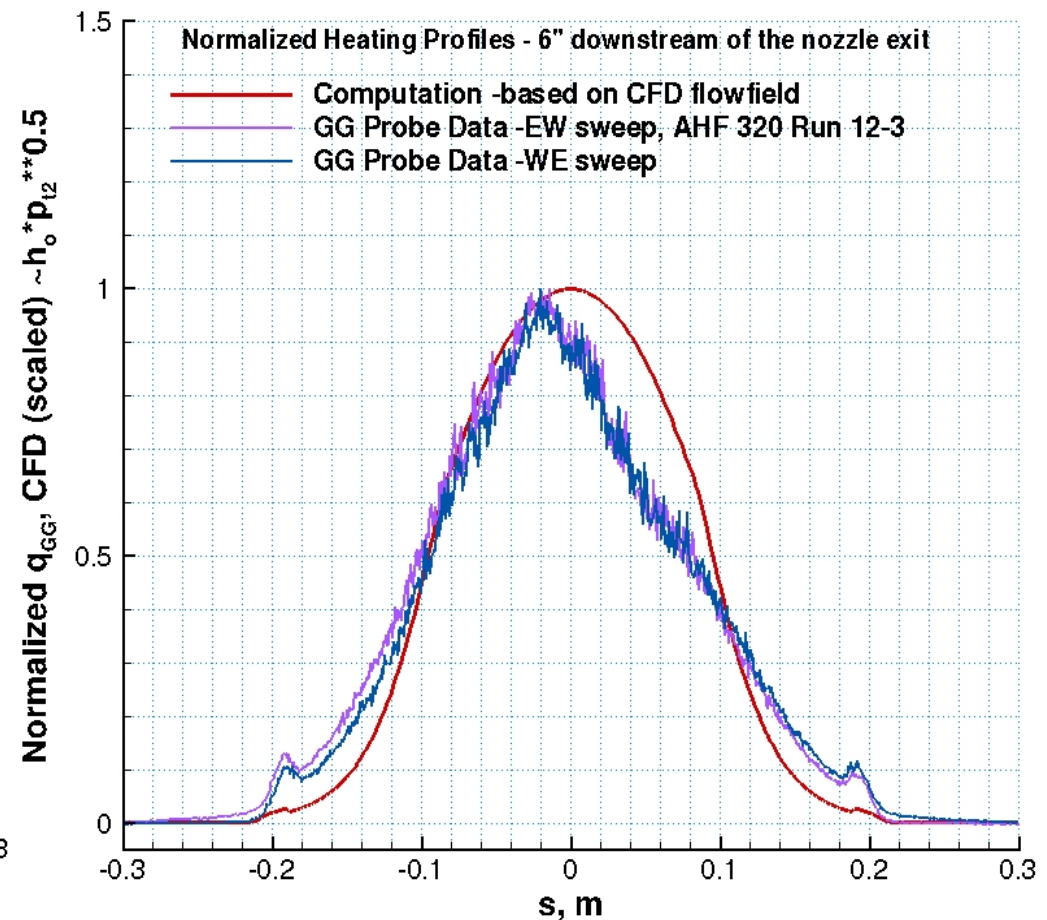
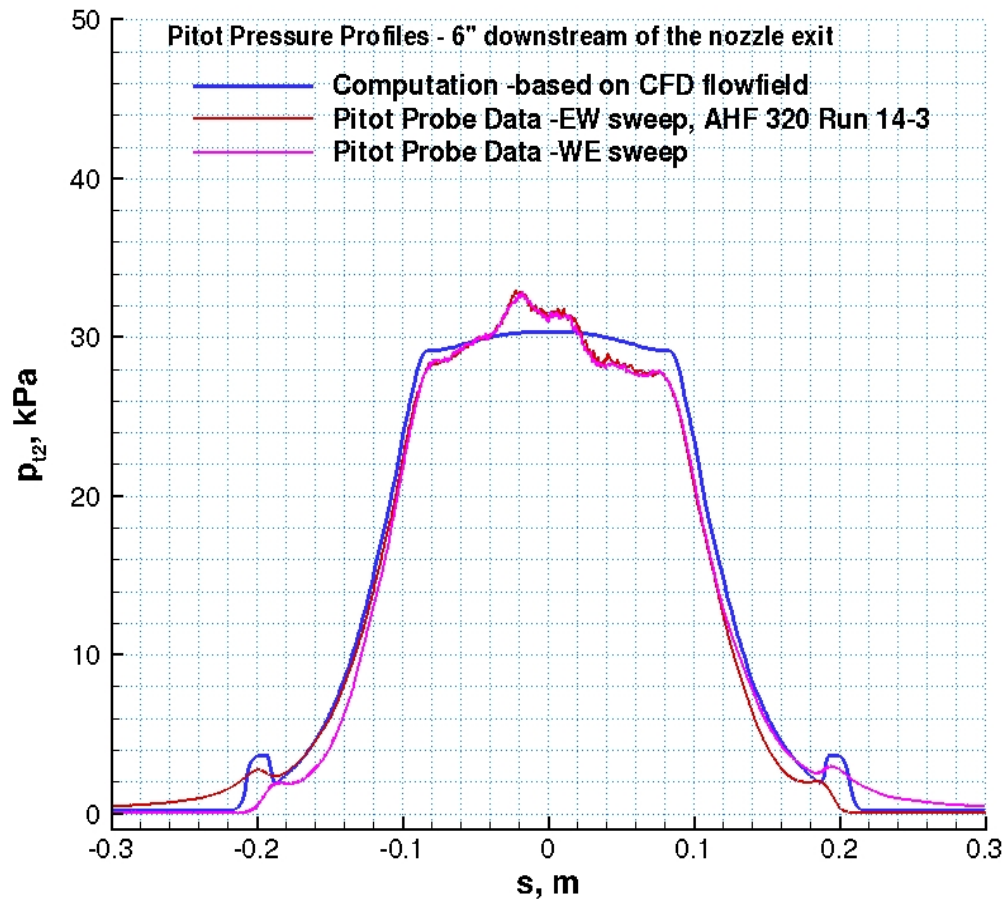

- CFD simulations are based on AHF 320 calibration data
- In the pitot surveys, there is a higher pressure region near the nozzle centerline (similar to the earlier surveys, but it is asymmetric); Although this feature could be explained by geometric imperfections in the nozzle walls, the fact that it does not appear in all surveys at other conditions requires further study
- Asymmetry in the heating profile is confirmed, skewed to the west side

Comparisons of Computations with Survey Data (step 4, AHF 307)

TP3 7.5-Inch Nozzle Flow Simulation: $\dot{m} = 310$ g/s, $h_{ob} = 13.6$ MJ/kg, $h_{ocl} = 21.9$ MJ/kg, $p_{box} = 1$ torr

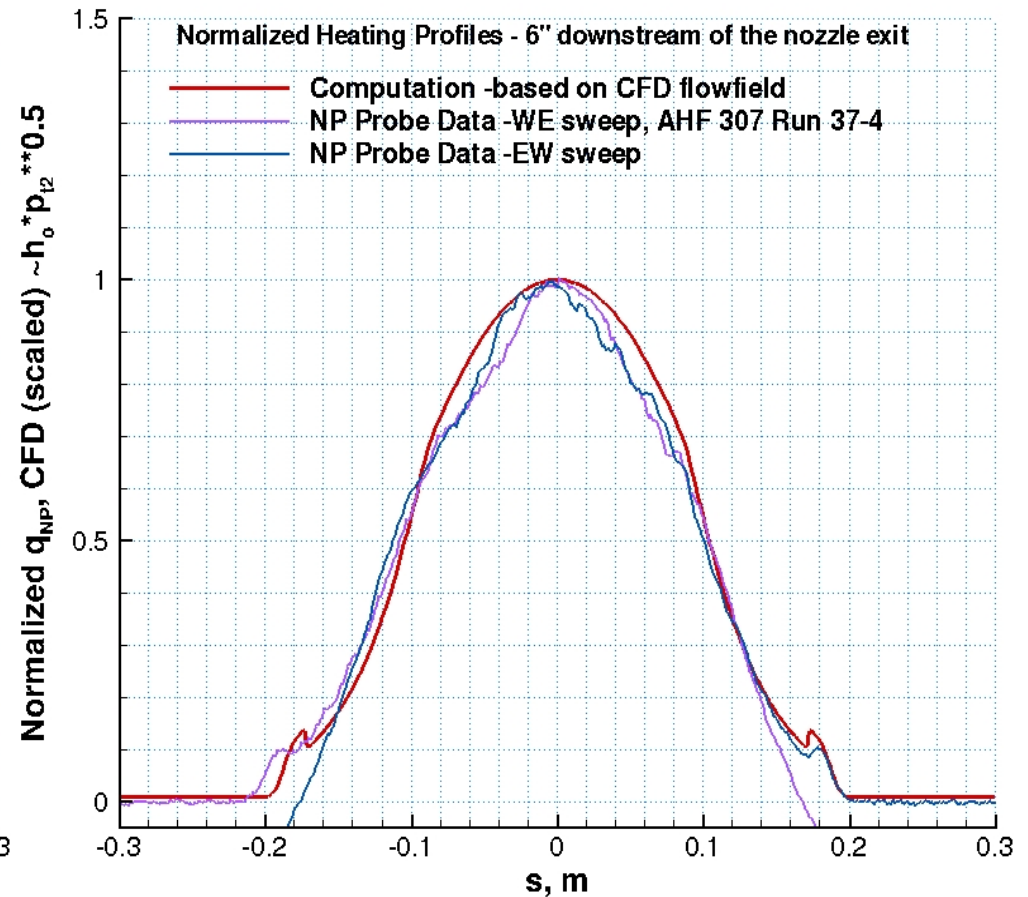
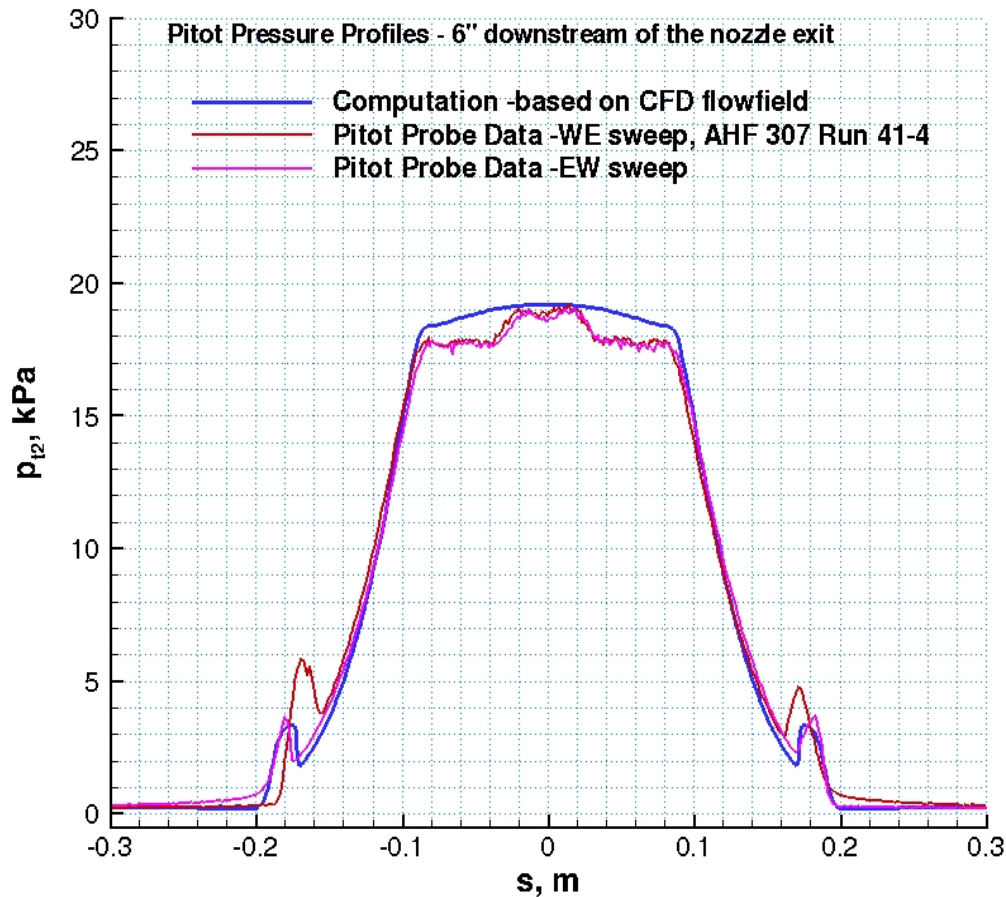

- This case represents a facility condition at **relatively high mass flow rate and moderately high enthalpy**, and **with cold gas injection** of N_2 at the plenum (20% of total mass flow rate)
- The pitot survey shows a somewhat higher pressure region near the nozzle centerline
- Both pitot and heat flux survey data are repeatable and approximately symmetric

Comparisons of Computations with Survey Data (step 4, AHF 318)

TP3 7.5-Inch Nozzle Flow Simulation: $\dot{m} = 310$ g/s, $h_{ob} = 13.6$ MJ/kg, $h_{ocl} = 21.9$ MJ/kg, $p_{box} = 1$ torr

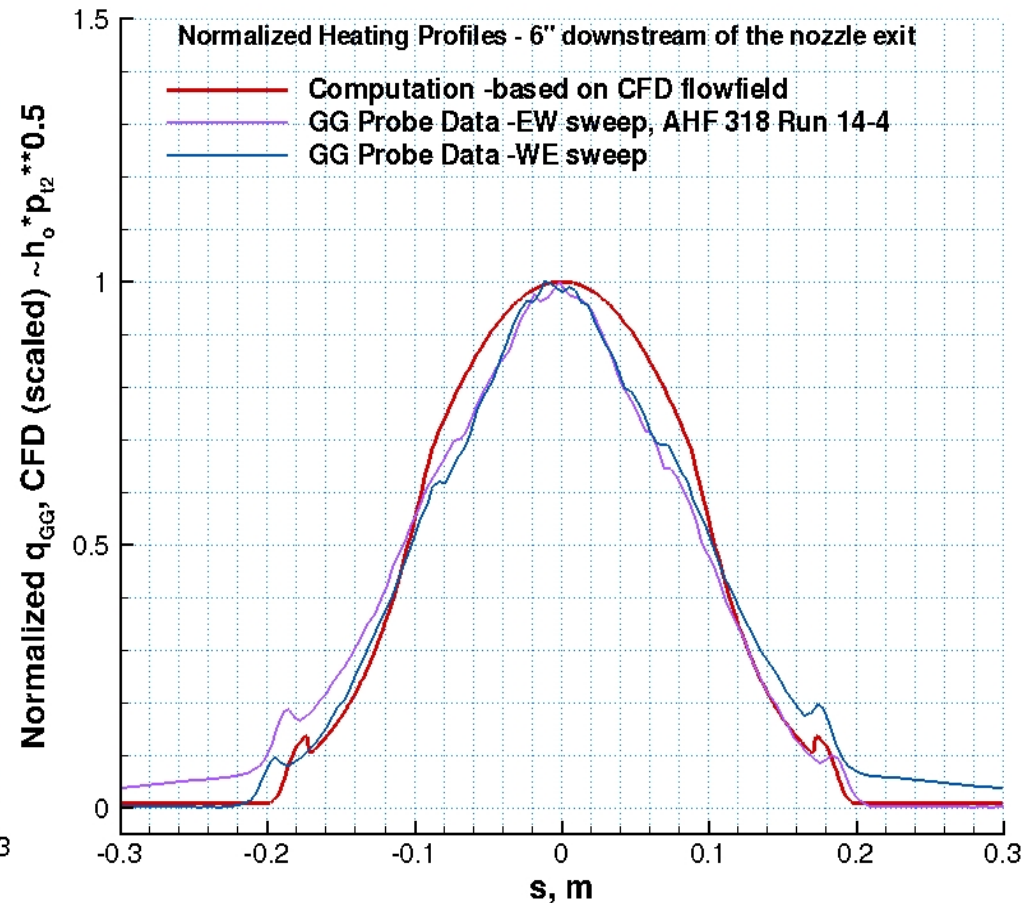
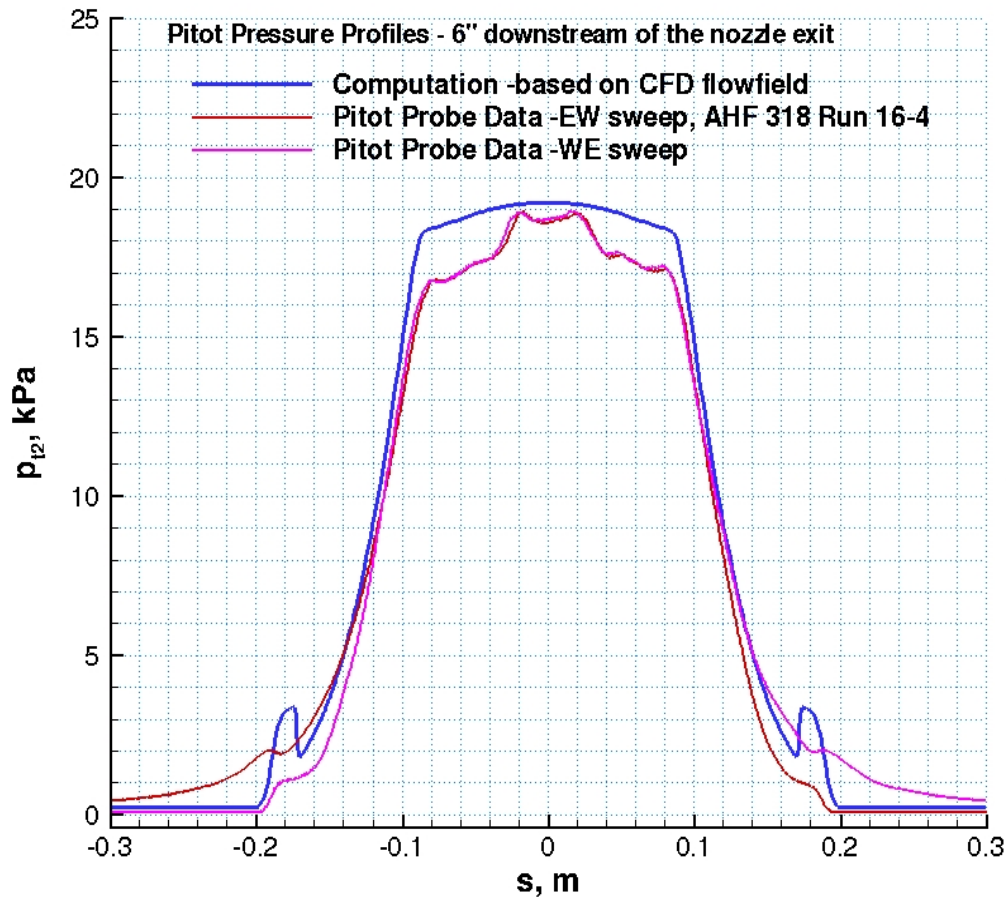

- The pitot survey shows a somewhat higher pressure region near the nozzle centerline (similar to AHF 307 survey data)
- Both pitot and heat flux survey data are repeatable and approximately symmetric

Comparisons of Computations with Survey Data (step 4, AHF 320)

TP3 7.5-Inch Nozzle Flow Simulation: $\dot{m} = 310$ g/s, $h_{ob} = 10.3$ MJ/kg, $h_{ocl} = 18.8$ MJ/kg, $p_{box} = 1$ torr

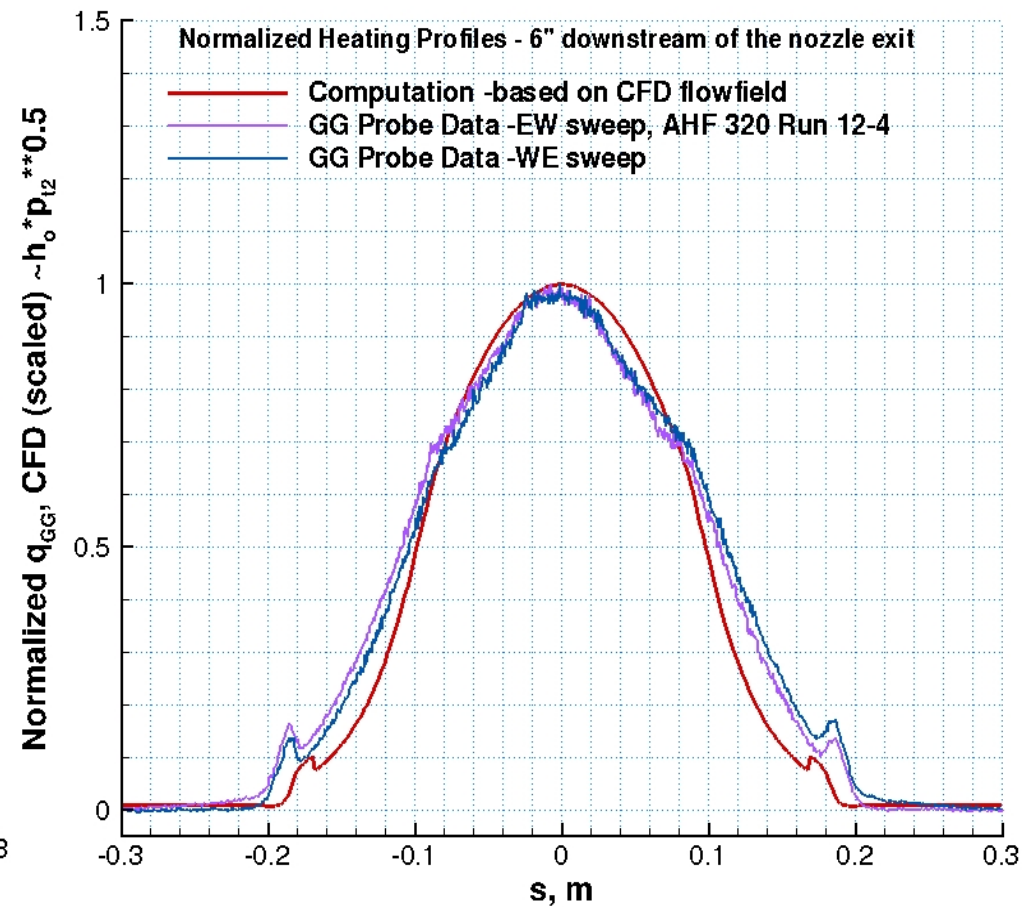
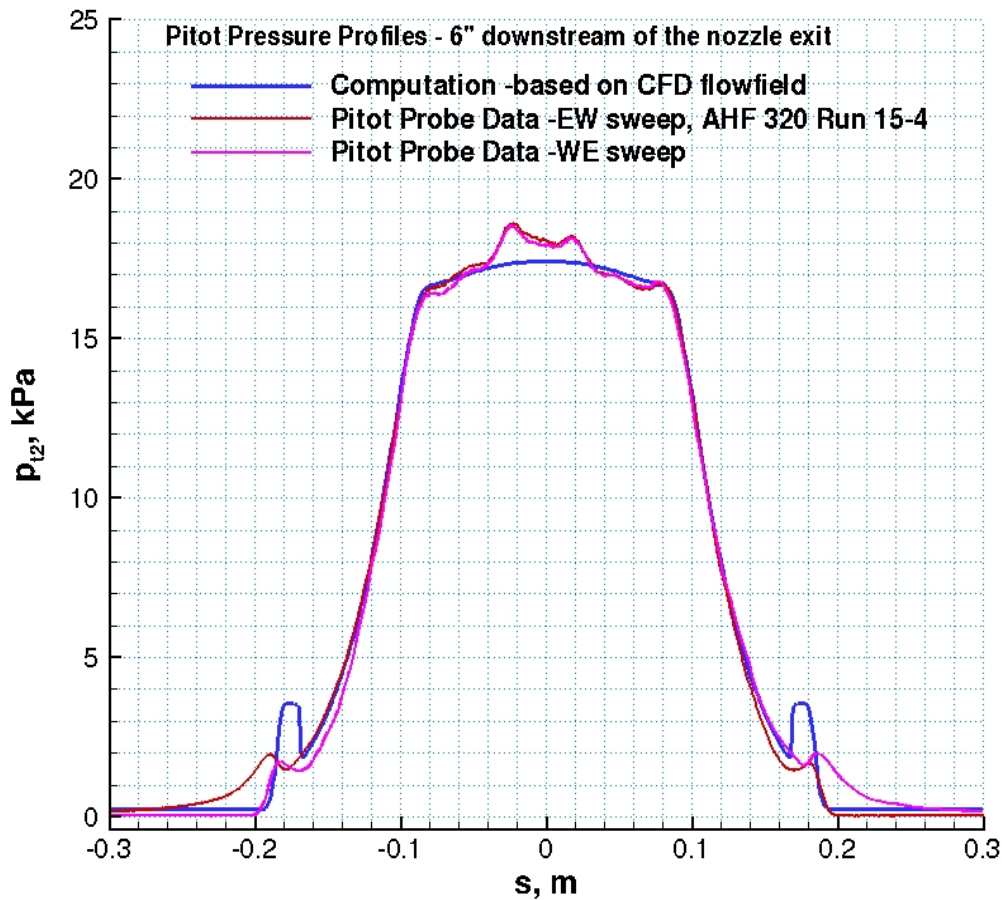

- CFD simulations are based on AHF 320 calibration data
- Both pitot and heat flow survey data are approximately symmetric

Comparisons of Computations with Survey Data (step 5, AHF 307)

TP3 7.5-Inch Nozzle Flow Simulation: $\dot{m} = 40$ g/s, $h_{ob} = 15.4$ MJ/kg, $h_{ocl} = 19.6$ MJ/kg, $p_{box} = 0.1$ torr

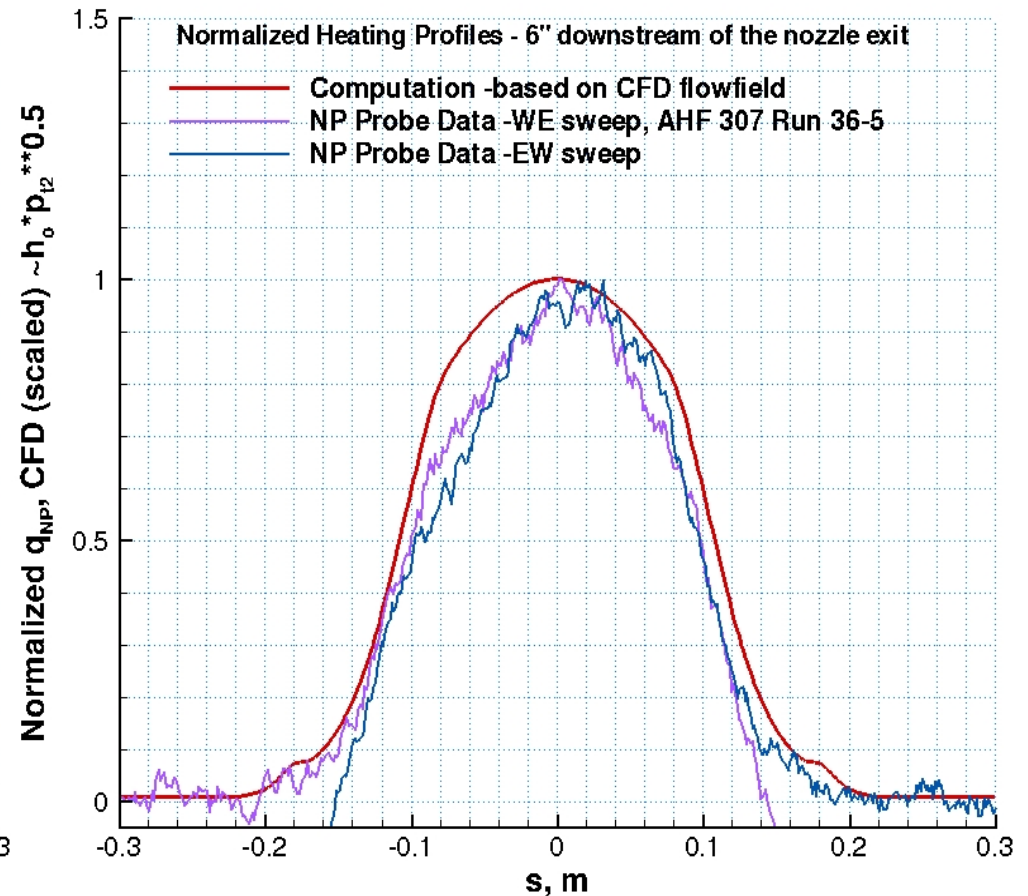
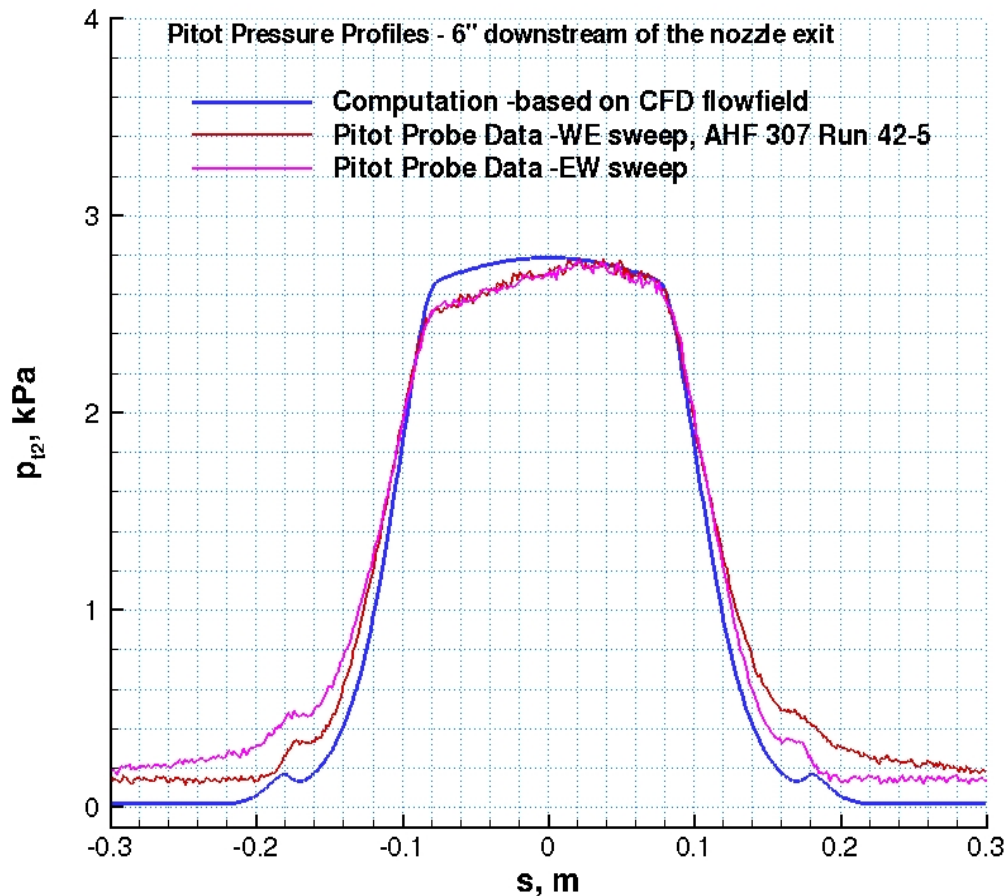

- This case represents a facility condition at relatively **low mass flow rate and moderately high enthalpy**, and **without cold gas injection** at the plenum
- Both pitot and heat flux survey data are not symmetric while the sweep data are repeatable in both sweep directions
- There is an incomplete recovery in the pitot pressure data to the test box pressure

Comparisons of Computations with Survey Data (step 5, AHF 320)

TP3 7.5-Inch Nozzle Flow Simulation: $\dot{m} = 40$ g/s, $h_{ob} = 15.4$ MJ/kg, $h_{ocl} = 19.6$ MJ/kg, $p_{box} = 0.7$ torr

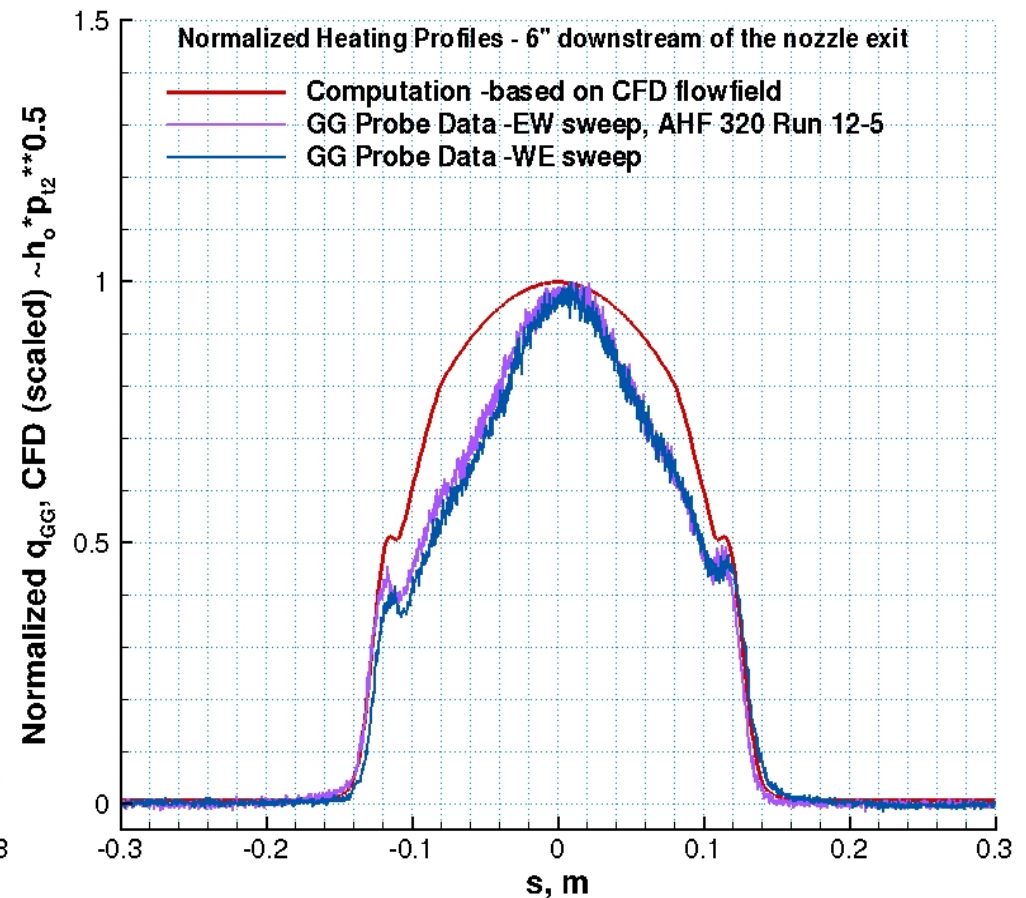
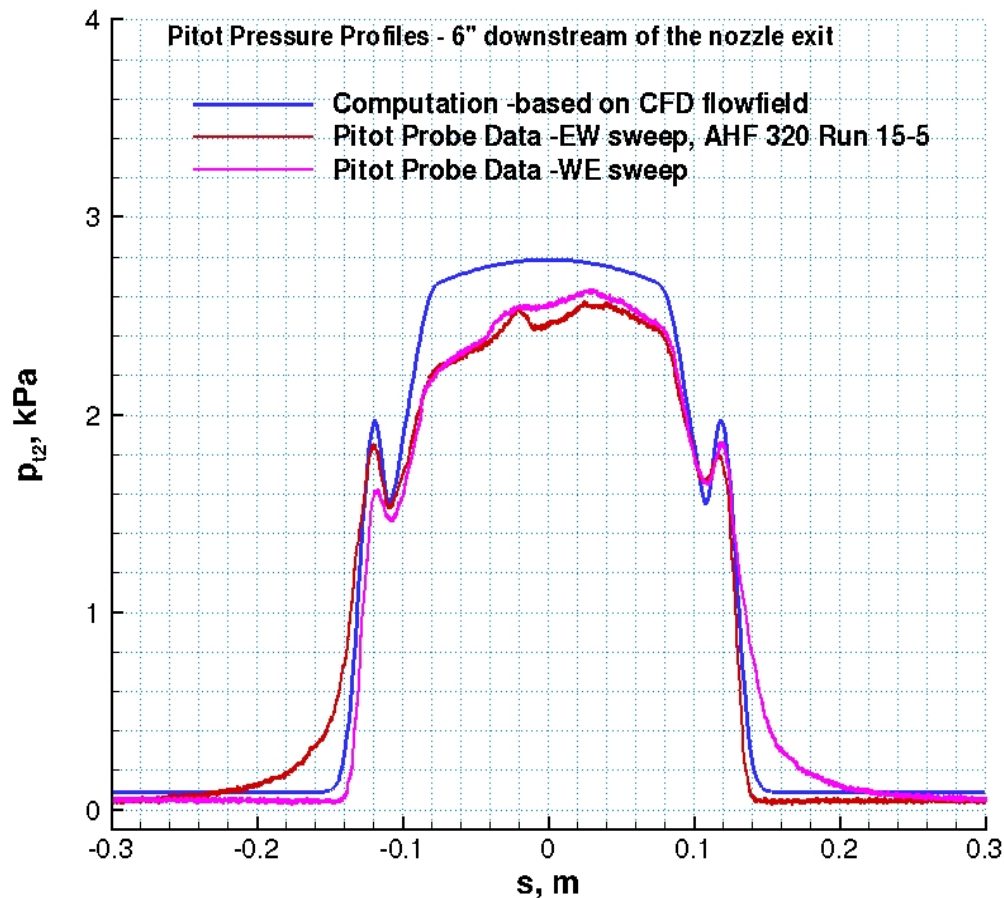

- Both pitot and heat flux survey data are not symmetric while the sweep data are reasonably repeatable in both sweep directions
- The asymmetric feature skewing to the east side is confirmed (west side in step 3 condition)
- The heat flux data show a more peaked distribution than computations
- Test box pressure for AHF 320 is much higher than for AHF 307

Comparisons of Computations with Survey Data (step 7, AHF 307)

TP3 7.5-Inch Nozzle Flow Simulation: $\dot{m} = 310$ g/s, $h_{ob} = 7.5$ MJ/kg, $h_{ocl} = 9.4$ MJ/kg, $p_{box} = 0.5$ -2 torr

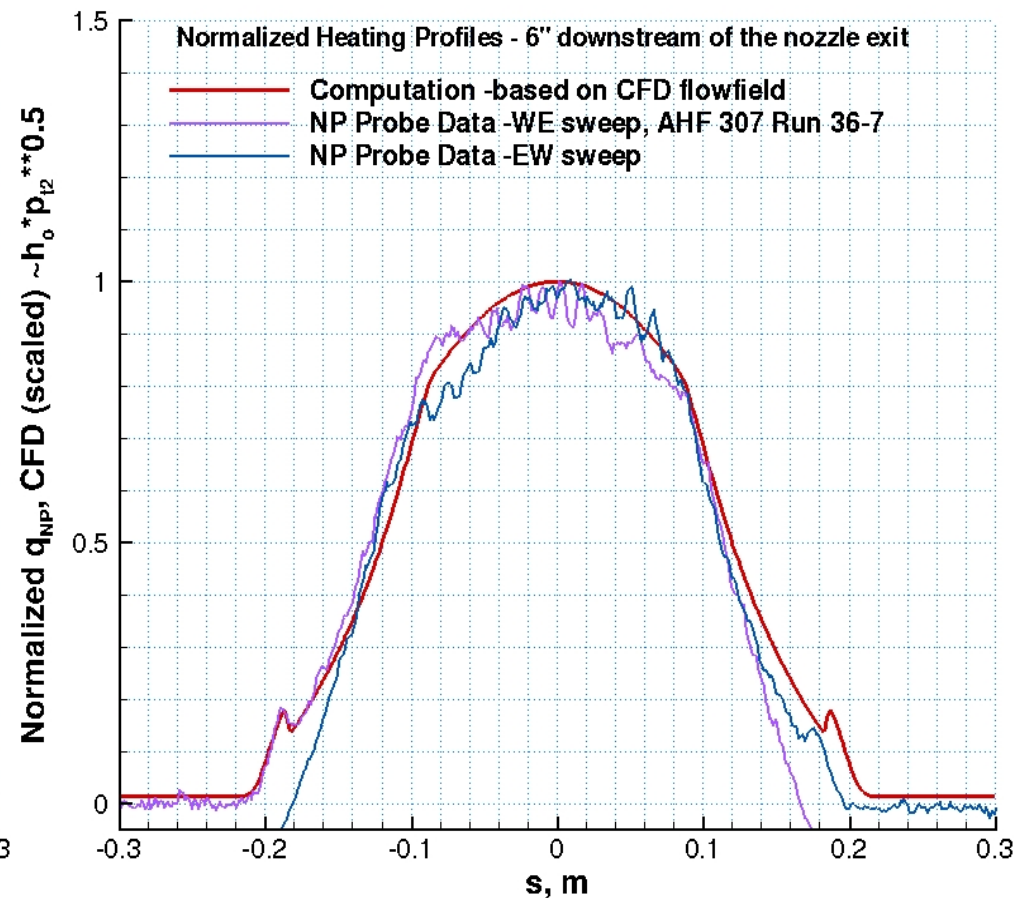
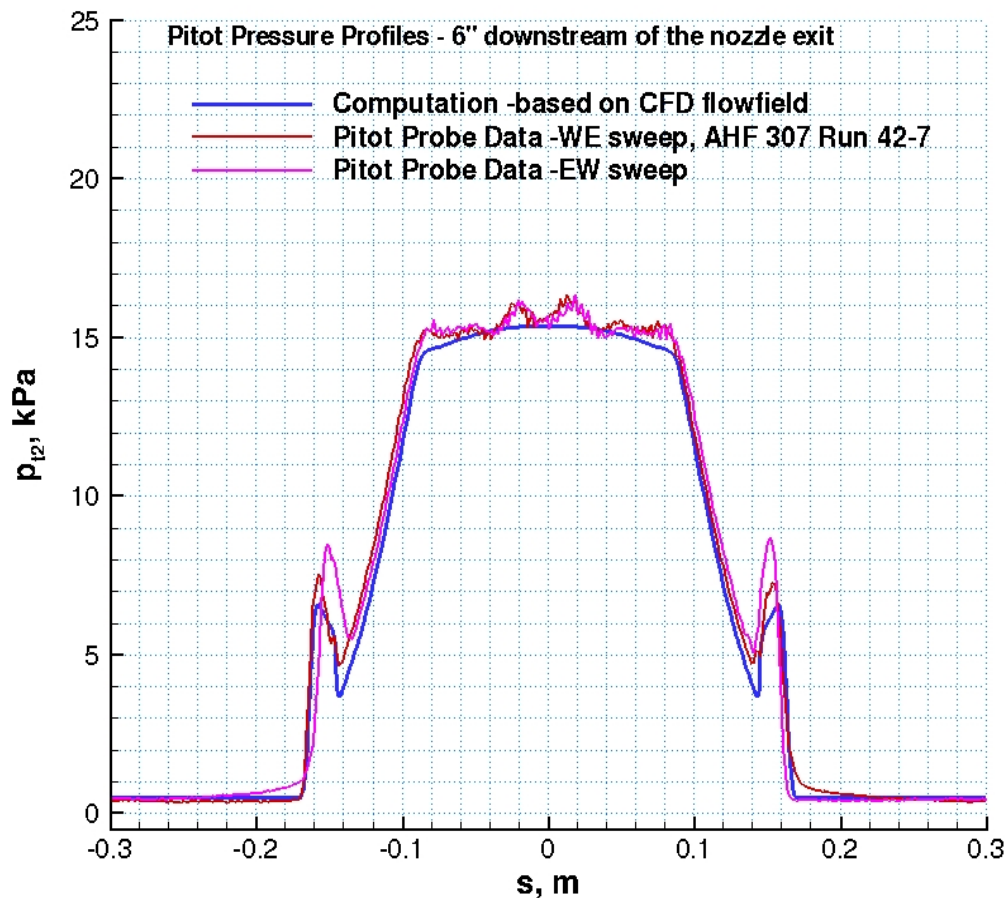

- This case represents a facility condition at relatively **high mass flow rate and low enthalpy**, and **with cold gas injection** of N_2 at the plenum (28% of total mass flow rate)
- The pitot pressure data were obtained at $p_{box} = 2$ torr, and the NP heat flux data at $p_{box} = 0.5$ torr
- The pitot survey appears to indicate some wave interactions near the nozzle centerline

Comparisons of Computations with Survey Data (step 7, AHF 318)

TP3 7.5-Inch Nozzle Flow Simulation: $\dot{m} = 310$ g/s, $h_{ob} = 7.5$ MJ/kg, $h_{ocl} = 9.4$ MJ/kg, $p_{box} = 0.5$ torr

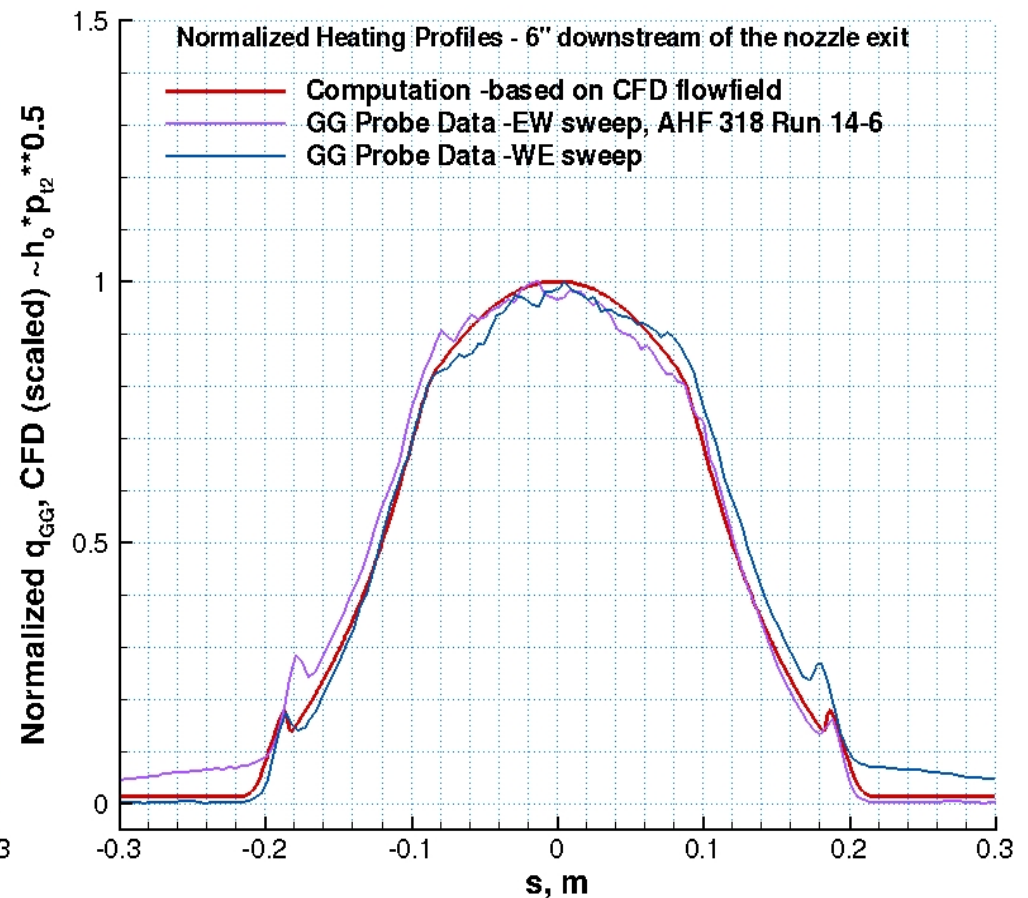
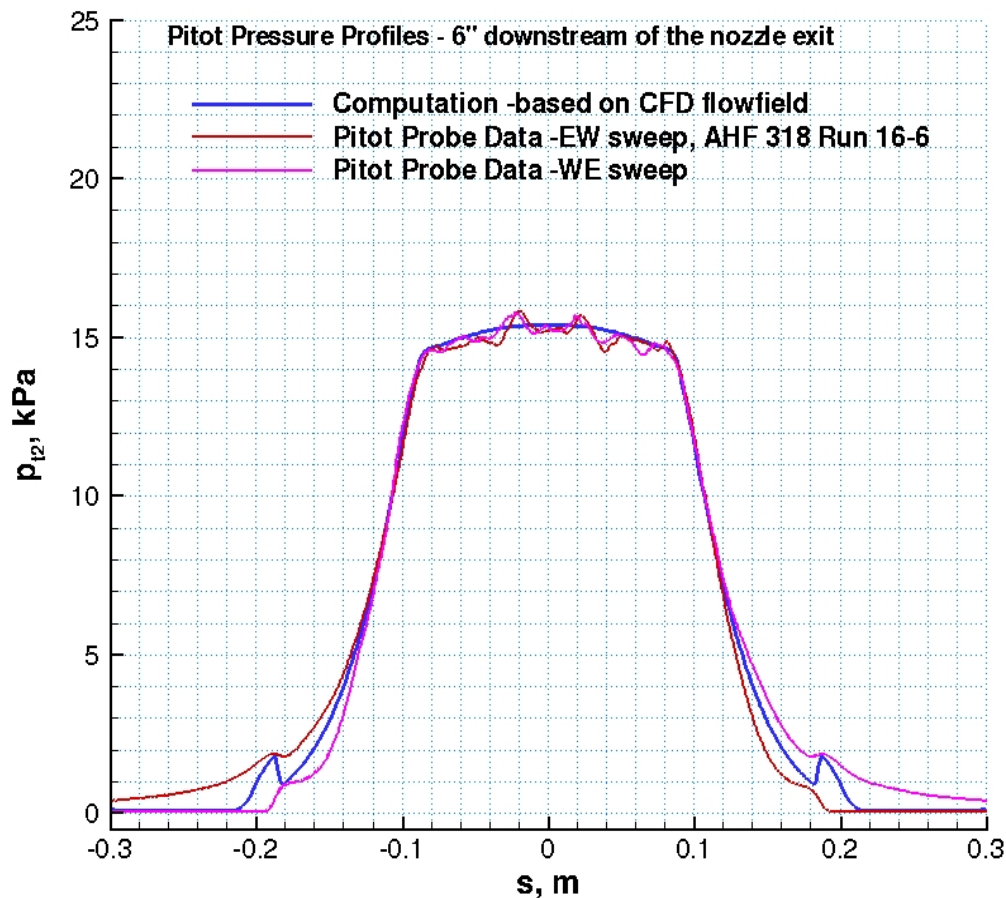

- Both pitot and heat flux survey data are repeatable and approximately symmetric
- The pitot survey shows similar wave interactions near the nozzle centerline (observed in AHF 307)

Comparisons of Computations with Survey Data (step 7, AHF 320)

TP3 7.5-Inch Nozzle Flow Simulation: $\dot{m} = 310$ g/s, $h_{ob} = 7.5$ MJ/kg, $h_{ocl} = 9.4$ MJ/kg, $p_{box} = 0.5$ torr

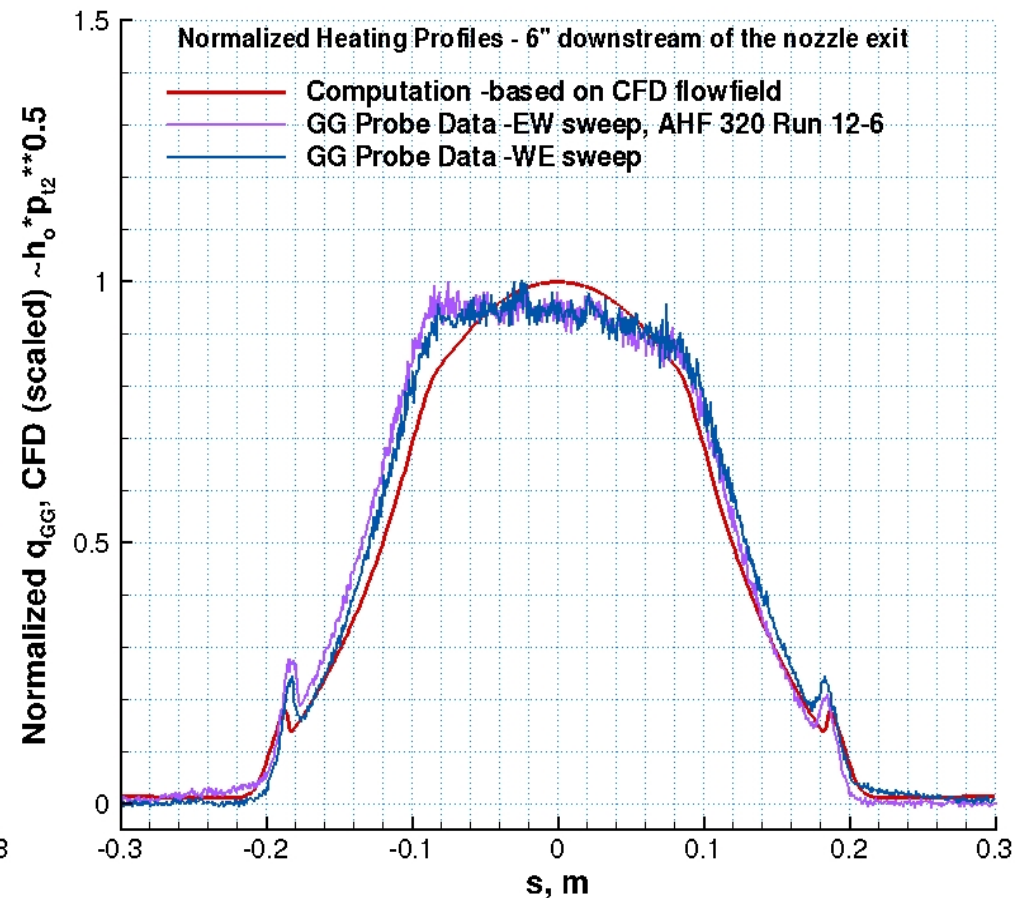
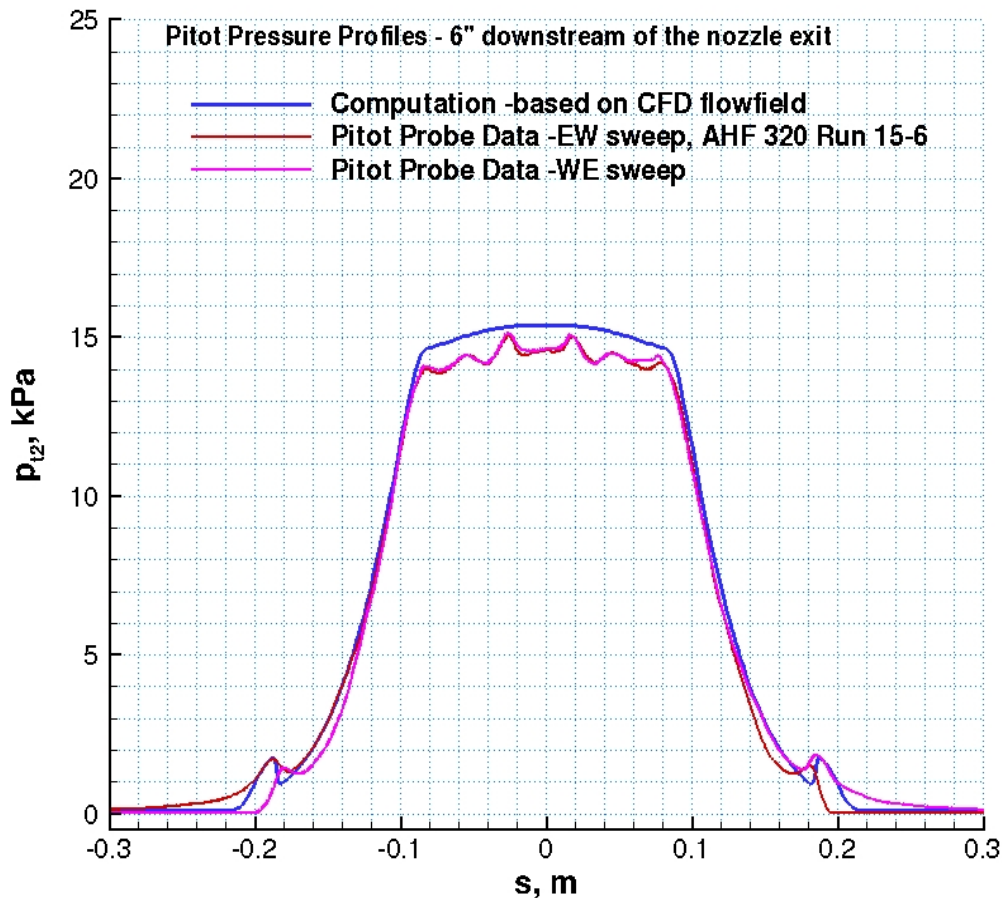

- The heat flux data show a remarkably flat distribution, considering the cold gas injection at the plenum
- The pitot survey shows similar wave interactions near the nozzle centerline (observed in AHF 307 and AHF 318)
- Relatively uniform heating distribution is remarkable (in contrast to our experience with other arc-jet facilities)

Concluding Remarks and Future Work

- The survey data obtained using two different sets of probes at six arc-heater conditions in the TP3 7.5-inch nozzle provide assessment of the flow uniformity and valuable data for the arc-jet flow characterization
 - Six conditions cover a wide range of facility parameters: arc current varies from 262 A to 1762 A, and total mass flow rate from 24 g/s to 501 g/s
 - Two of these conditions include cold-gas N₂ injection at the arc-heater plenum
- The probe survey data clearly show that the arc-jet test flow in the TP3 facility is not uniform at most conditions, and the extent of non-uniformity is highly dependent on various arc-jet parameters such as arc current, mass flow rate (or arc heater pressure), and the amount of cold-gas injection at the plenum
 - Not even axisymmetric at the extremes of the facility operating envelope
 - Effects of the observed asymmetric flows on the calorimeter measurements and their interpretation (CFD-estimated centerline total enthalpy values) remain to be investigated
- CFD analysis is an essential part of arc-jet flow characterization studies
 - Computations show reasonably good agreement with the experimental measurements except at the extreme low pressure conditions of the facility envelope
 - Pitot pressure and normalized heating distributions from two sets of survey probes
- Several additional challenges remain in arc-jet flow calibration using multiple heat flux measuring devices to provide heat flux datasets consistent with each other: calibration of the null-point and Gardon gages, and reexamination of methodologies to infer the heat flux for these measurement devices

Acknowledgments

This work was funded by the NASA Orion TPS Insight/Oversight project. The arc-jet operational capability at NASA ARC is also supported by NASA-SCAP. The authors would like to thank all of the facilities staff involved in the TP3 tests, in particular, test engineers **Frank C. L. Hui, J. Enrique Carballo, Erika D. Rodrigues, and Imelda Terrazas-Salinas**. The support from the NASA Ames Entry Systems and Technology Division, through contract NNA15BB15C to AMA, Inc., is gratefully acknowledged.