

AMERICAN MUSEUM
Novitates

PUBLISHED BY THE
AMERICAN MUSEUM
OF NATURAL HISTORY

CENTRAL PARK WEST AT 79TH STREET
NEW YORK, N.Y. 10024 U.S.A.

NUMBER 2719

NOVEMBER 27, 1981

DONN E. ROSEN AND LYNNE R. PARENTI
Relationships of *Oryzias*, and the
Groups of Atherinomorph Fishes

AMERICAN MUSEUM *Novitates*

PUBLISHED BY THE AMERICAN MUSEUM OF NATURAL HISTORY
CENTRAL PARK WEST AT 79TH STREET, NEW YORK, N.Y. 10024

Number 2719, pp. 1–25, figs. 1–20

November 27, 1981

Relationships of *Oryzias*, and the Groups of Atherinomorph Fishes

DONN E. ROSEN¹ AND LYNNE R. PARENTI²

ABSTRACT

Newly discovered evidence, particularly that pertaining to the gill arch skeleton and hyoid apparatus, indicates that adrianichthyoids (ricefishes and their allies) are related more closely to halfbeaks, flyingfishes, needlefishes, and sauries than to the killifishes with which they have been associated for over a century. This discovery was used as an occasion to reevaluate atherinomorph interrelationships and the monophyly of the included groups. We conclude that atherinoids are not presently a definable group, but that killifishes and the ricefishes plus halfbeaks and allies are. We also support the monophyly of the Atherinomorpha. In our proposed theory of relationships we have (1) abandoned use of the term Atherinoidei to represent the fishes formerly grouped

by that name, preferring instead to include them in a general classification of the Atherinomorpha by a listing convention; and (2) used the ordinal term Cyprinodontiformes for killifishes, in conformity with a recent monographic revision by Parenti (1981), and the term Beloniformes (including the Adrianichthyoidei and Exocoetoidei) for its coordinate sister group. We find the Atherinomorpha to be supported by 10 characters uniquely derived among ctenosquamate neoteleostean fishes and a subdivision including cyprinodontiforms and beloniforms to be supported by four characters uniquely derived within the Atherinomorpha. Some or all "atherinoid" fishes are thought to be plesiomorphous to that subdivision.

INTRODUCTION

Atherinomorph fishes may be defined as a monophyletic group by derived characters of the egg, embryo (Rosen, 1964; Breder and Rosen, 1966; Foster, 1967), ethmoid ossification (Rosen, 1964), infraorbital bones (Ro-

sen, 1964; Nelson, 1969), rostral cartilage (Alexander, 1967; Parenti, 1981), upper-jaw protrusile mechanism (Alexander, 1967), spermatogonium formation (Grier, Linton, Leatherland, and DeVlaming, 1980; Grier, in

¹ Curator, Department of Ichthyology, American Museum of Natural History.

² Smithsonian Postdoctoral Fellow, Division of Fishes, National Museum of Natural History.

press; Grier, Burns, and Flores, in press), nasal capsule (Melinkat and Zeiske, 1979), and at least two features of the dorsal gill arch skeleton to be described below.

The discovery of the gill arch synapomorphies of atherinomorphs was an outgrowth of an earlier discovery of gill arch evidence that the ricefishes, *Oryzias*, and their close relatives in *Adrianichthys*, *Xenopocilus*, and *Horaichthys*, are allied with the flying-fishes, halfbeaks, needlefishes, and sauries rather than with the killifishes—a group with which they have been continuously associated for over a century. We have, therefore, taken this occasion to review some new and old evidence for interrelationships among the groups of Atheriniformes, an order formally established by Rosen (1964) to include atherinoids (silversides and phallostethids), cyprinodontoids (killifishes and ricefishes), and exocoetoids (halfbeaks and their relatives) and coextensive with the Atherinomorpha of Rosen (1973). Rosen (1964) had left the interrelationships of the three suborders unspecified and had defined them and their subgroups using characters in a manner that we find, in part, to be unworkable. Accepting as an initial premise the monophyly of the atherinomorph fishes, as defined above, we present our analyses of the derived characters that define component groups and subgroups.

ABBREVIATIONS AND SYMBOLS

ANATOMICAL:

AC: accessory cartilage

C-1,2,3,4: ceratobranchials 1 to 4

E-1,2,3,4: epibranchials 1 to 4

IAC: interarcual cartilage

PB-1,2,3,4: pharyngobranchials 1 to 4

UNC-1: uncinat process of first epibranchial

UNC-PB-2: uncinat process of second pharyngobranchial

UP-4: fourth upper pharyngeal toothplate

ANATOMICAL SYMBOLS IN FIGURES:

open circles: cartilage

stippling: bone

INSTITUTIONAL:

AMNH, American Museum of Natural History,
New York

MCZ, Museum of Comparative Zoology, Cambridge

SU, Stanford University Collections in the California Academy of Sciences, San Francisco

UBC, University of British Columbia, Vancouver

UMMZ, University of Michigan Museum of Zoology, Ann Arbor

GILL ARCH ANATOMY

The crucial evidence that, for us, prompted the reinvestigation of this group of fishes concerns the anatomy of the gill arch skeleton. Rosen and Greenwood (1976) had noted previously that many groups of acanthopterygians are characterized by the presence of an accessory cartilage in the dorsal gill arches that connects the epibranchial bone of the first arch with the pharyngobranchial bone of the second arch. They pointed out that this interarcual cartilage and its connections are distinctively modified in various groups of fishes and that synbranchiform fishes, for example, are uniquely characterized in part by having the interarcual cartilage ossified. Among atherinomorph fishes there are also a number of unusual features of the dorsal and ventral gill arch anatomy, including interarcual cartilages, that specify a set of hierarchical relationships among the various taxa.

Allis (1903) apparently was the first to report on the existence in acanthopterygians of a separate cartilage between the first epi- and second infrapharyngobranchial, but he mistakenly identified this cartilage as a supra-pharyngobranchial (see Nelson, 1968, p. 137). Later, Allis (1915) recognized the secondary nature of this element and introduced the term interarcual cartilage for it. Nelson (*loc. cit.*) remarked that it is "common among perciform fishes, e.g., *Epinephelus*," and, indeed, we have found the cartilage to be primitively present in the dorsal gill arch skeleton of every major group of the Acanthopterygii (*sensu* Rosen, 1973) in which an uncinat process, or its equivalent, is present on the first epibranchial (fig. 1). In published illustrations of acanthopterygian dorsal gill arches, however, the cartilage has not always been distinguished as a separate ele-

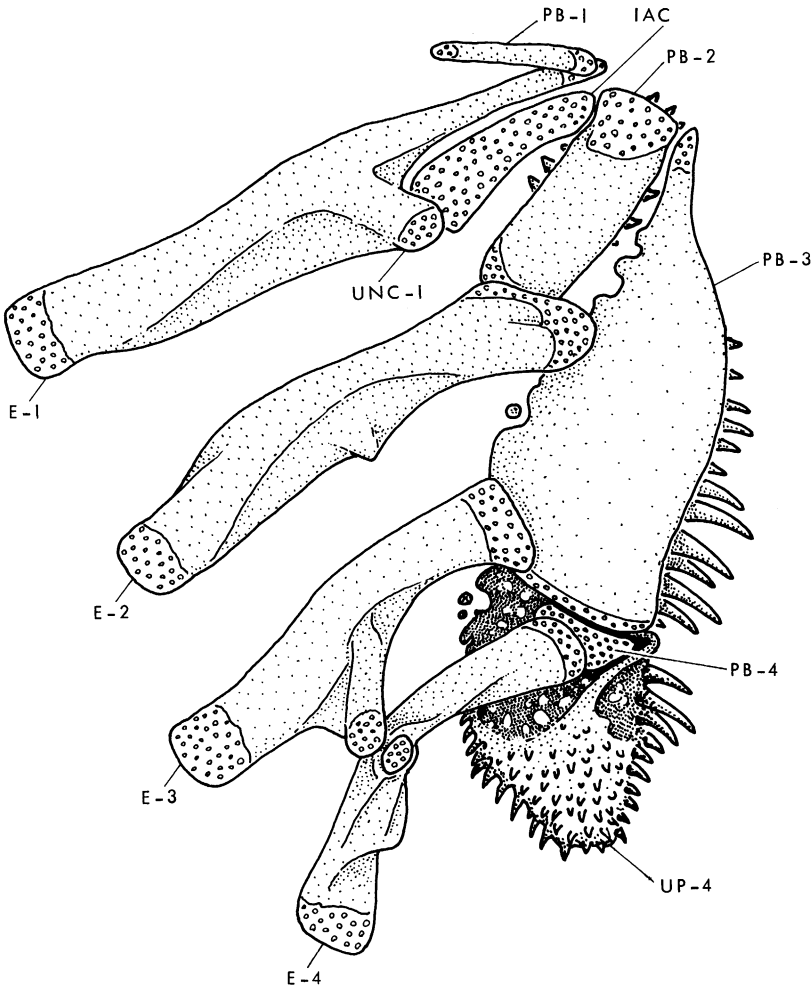

FIG. 1. Percoid dorsal gill arches. *Morone americana* (Gmelin) AMNH 26515 same as *Centropristis striata* (Linnaeus) AMNH 22052.

ment (e.g., in Rosen, 1973) and in many instances no cartilages of any sort are shown.

Primitively among euteleosts the cartilaginous tip of a short uncinus near the distal end of the first epibranchial directly contacts the cartilage of an uncinus process on the dorsolateral side of the second pharyngobranchial [Rosen, 1973, figure 3 (a characoid), figure 5 (a salmonid), figure 58 (an esocoid)]. This type of contact between the first two arches persists in primitive neoteleosts and in plesiomorphous groups of

acanthopterygians such as some "beryciforms," as in *Holocentrus* (fig. 2). The condition derived relative to this is to have the uncinus process of the first epibranchial and second pharyngobranchial separated by an intervening interarcual cartilage as in *Morone*, *Centropristis* (fig. 1), *Caranx* (fig. 3A), *Monodactylus* (fig. 3B), *Drepane* (fig. 4A), *Sphyraena* (fig. 4B) and *Agonostomus* (fig. 4C). Among acanthopterygians presently classified as "perciforms" or as closely allied with "perciforms" the interarcual car-

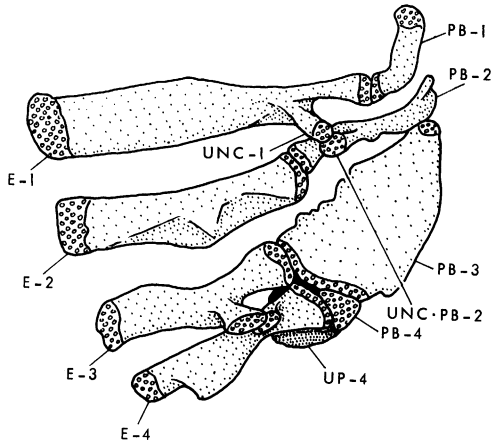

FIG. 2. Berycoid dorsal gill arches. *Holocentrus vexillarius* Poey, AMNH 23374. Note that the cartilaginous tip of the uncinate processes on the first epibranchial and second pharyngobranchial come directly together without an intervening cartilage. Contrast with figures 1, 3, 4.

tilage is absent only in those groups with some specialized condition of the epi- or pharyngobranchials, as, for example, when the first epibranchial has a very small (*Nothothenia*, fig. 5A) or no (*Xiphister*, fig. 5B) uncinate process.

It is also primitive for euteleosts (and other main groups of teleosts as well) to have a fourth pharyngobranchial cartilage (Nelson, 1969; Rosen, 1973) and to have each of the four epibranchials approximately equal in size. The derived conditions among acanthopterygians are to have the fourth pharyngobranchial reduced or absent and to have one or more epibranchials specialized in size or shape. In *Caranx* (fig. 3A), for example, a slender fourth epibranchial articulates with a relic fourth pharyngobranchial, whereas the other three epibranchials are robust. In *Monodactylus* (fig. 3B) the articular head of the second epibranchial is, by far, the largest epibranchial element. In *Drepane*

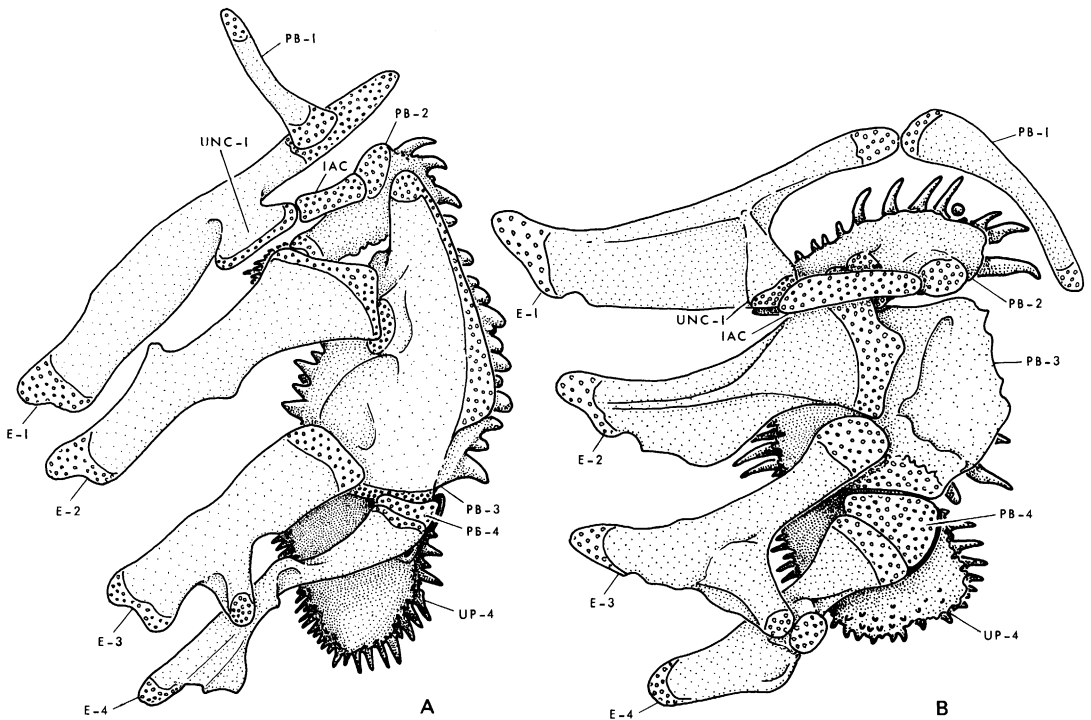

FIG. 3. Percoid dorsal gill arches. A, *Caranx mate* Cuvier and Valenciennes, AMNH 15206. B, *Monodactylus argenteus* (Linnaeus), AMNH 30803.

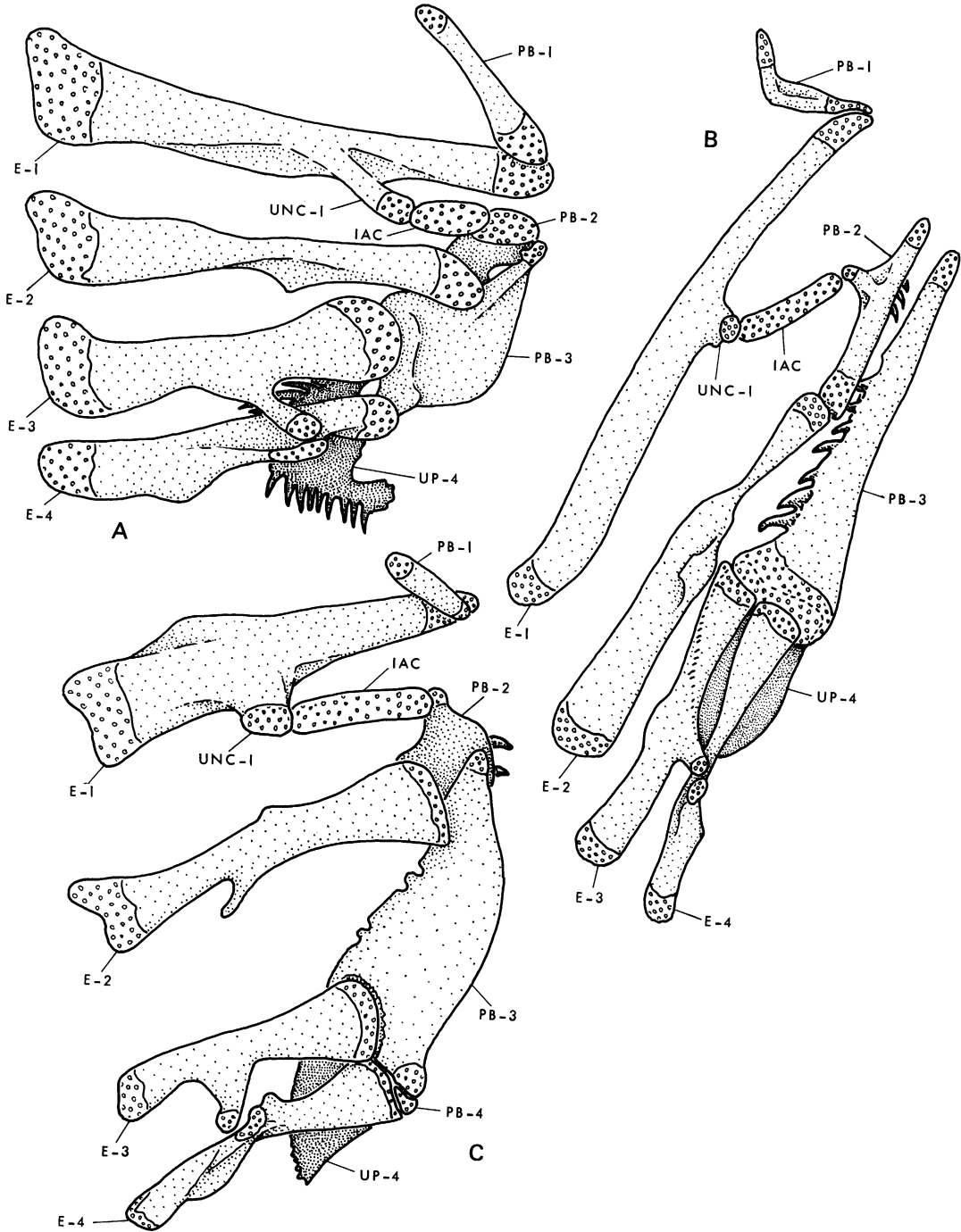

FIG. 4. Percoid, sphyaenoid, and mugiloid dorsal gill arches. A, *Drepane punctata* (Linnaeus), AMNH 13922. B, *Sphyaena borealis* De Kay, AMNH 4339. C, *Agonostomus monticola* (Bancroft), AMNH 11613.

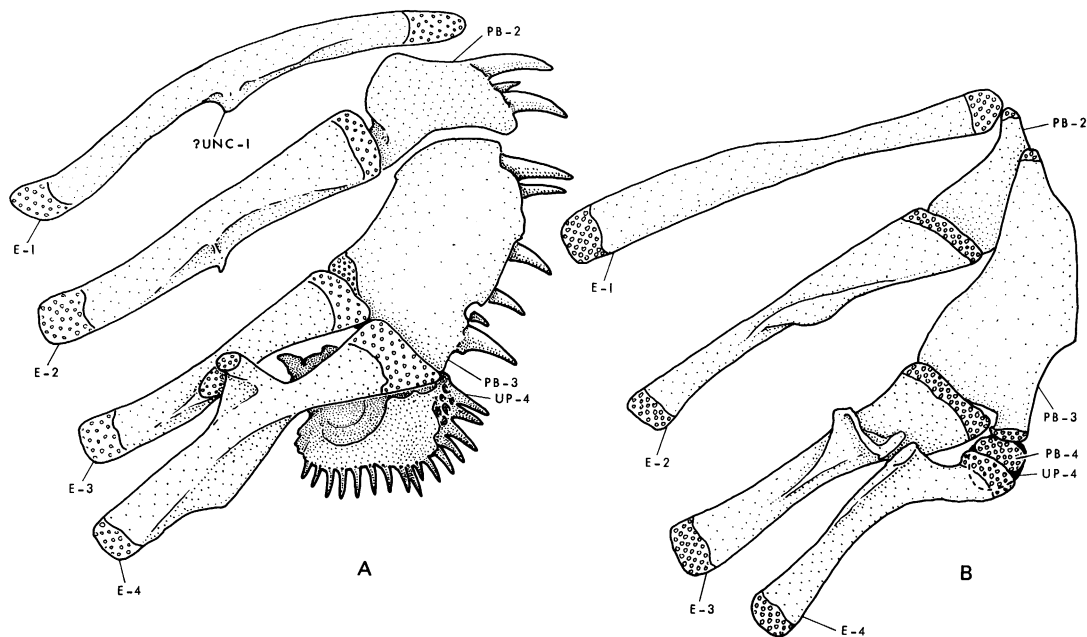

FIG. 5. Notothenioid and blennioid dorsal gill arches. A, *Notothenia cornucola* Richardson, AMNH 3606. B, *Xiphister atropurpurens* (Kittlitz), AMNH 2709.

(fig. 4A) and *Xiphister* (fig. 5B) the third epibranchial is the largest element.

The dorsal gill arch skeleton of atherinomorphs is of a derived acanthopterygian type. The articular head of the fourth epibranchial is very large and forms the main supporting element for the pharyngobranchial dentition, a condition that is unusual in forms lacking a fourth pharyngobranchial. The more usual condition is for support of the posterior toothplates to shift from the fourth to the third and fourth or mainly the third epibranchial (Rosen, 1973). The first epibranchial and interarcual cartilage also are specialized, but in atherinomorphs the situation is rather complex. We recognize four basic conditions: (1) In silversides the uncinat process arises at the midpoint or nearer the proximal rather than distal end of the epibranchial at a sharp angle to the main shaft of the bone and the interarcual cartilage articulates with the base or shaft rather than with the cartilaginous tip of the uncinat process on the second pharyngobranchial (figs.

6 to 9). (2) In killifishes the first epibranchial has no uncinat process on its shaft, the usually rather long interarcual cartilage is borne instead on an expanded basal epibranchial cartilage and inserts, as in silversides, on the bony shaft of the uncinat process of the second pharyngobranchial (fig. 10). (3) In some ricefishes (the species of *Xenopoecilus*, fig. 11) and some halfbeaks and flyingfishes [species of *Chriodorus*, *Arrhamphus*, *Parexocoetus*, *Hirundichthys*, and *Cypselurus* (figs. 12 and 13)] the first epibranchial has no uncinat process, has an expanded basal cartilage to which is attached a small interarcual cartilage confined to the region between the bases of epibranchials 1 and 2; the first arch has thus entirely lost contact with the pharyngobranchial of the second arch. (4) In other ricefishes and halfbeaks and in the sauries and needlefishes examined, the anatomical arrangements are just as in condition (3), but there is no interarcual cartilage present (figs. 14 to 17). We can assume that these conditions are transformations of the

same character or characters because all of these fishes are united by the two synapomorphies of the posterior dorsal gill arches (loss of the fourth pharyngobranchial and enlargement of the distal end of the fourth epibranchial as the main supporting element of the pharyngobranchial dentition) and the eight synapomorphies enumerated at the outset. Given that assumption of monophyly, we infer the transformation of this character to be from condition (1) to condition (4), rather than the reverse, since the presence of an uncinete process and a narrow proximal end on the first epibranchial are primitive for euteleosteans. A consequence of that inference is that in atherinomorphs the uncinete process has shifted proximally on the first epibranchial, carrying the interarcual cartilage with it, that the uncinete process is represented in killifishes, ricefishes, halfbeaks, etc. as part of the enlarged basal cartilage, that the interarcual cartilage is represented in some ricefishes, halfbeaks, and flyingfishes by a vestige at the base of the epibranchial, and that its absence in other ricefishes, halfbeaks, needlefishes, and sauries is not primitive but due to secondary loss. Evidence that the uncinete process can occupy a basal position is illustrated by the silverside *Melanorhinus microps* (fig. 18) and the species of *Pseudomugil* (fig. 9C). The proximal position of the uncinete process in *Melanorhinus* is correlated with the absence of an interarcual cartilage; the cartilage is also absent in some killifishes (Parenti, 1981, figs. 45, 48a, and 48b). Perhaps the most interesting independent evidence that the absence of an uncinete process can be associated with a reduced interarcual cartilage with proximal (basal) articulation to the first epibranchial is the condition found in *Ceratostethus* (fig. 19A). In this phallostethid, the form of the cartilage closely resembles those found in some adrianichthyoids, hemiramphids, and exocoetoids.

Ricefishes and exocoetoids share three other derived features of the gill arch skeleton. All show a reduction in size of the second and third epibranchials which no longer have any direct contact with the pharyngo-

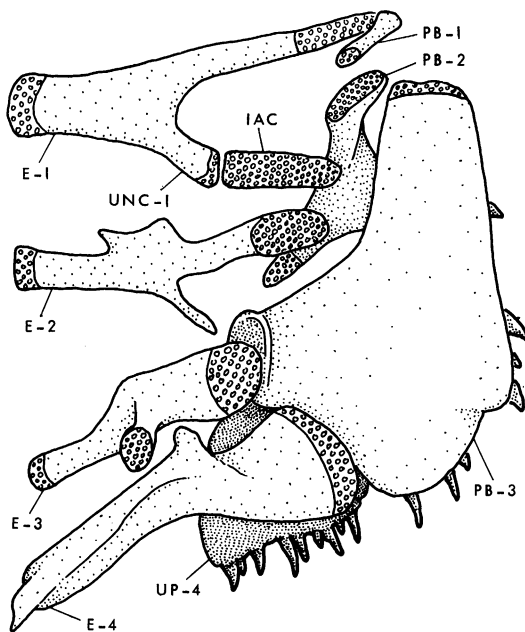

FIG. 6. "Atherinoid" dorsal gill arches. *Telmatherina ladiges* Abe, AMNH 35378. Note angle of UNC-1 and point of contact of IAC with PB-2, features found in all unreduced "atherinoid" gill arch skeletons. Contrast with figures 1, 3, and 4, and compare with figures 7, 8, and 9.

branchials. This means that in these fishes the pharyngobranchials are supported mainly by the enlarged fourth epibranchial and by the connective tissue and muscles from the basicranium and that the second pharyngobranchial is supported by the connective tissue it shares with the large third pharyngobranchial. Being supported in this way, the second pharyngobranchial has a characteristic orientation in which the anterior part of the bone is angled sharply upward toward the anterior end of the third pharyngobranchial. A third derived feature shared by these fishes is the very large ventral flange on each of the fifth ceratobranchials (toothed lower pharyngeals) and the close apposition (in ricefishes) or fusion (in exocoetoids) of the right and left elements.

Some parts of the gill arch anatomy, therefore, support the monophyly of the Ather-

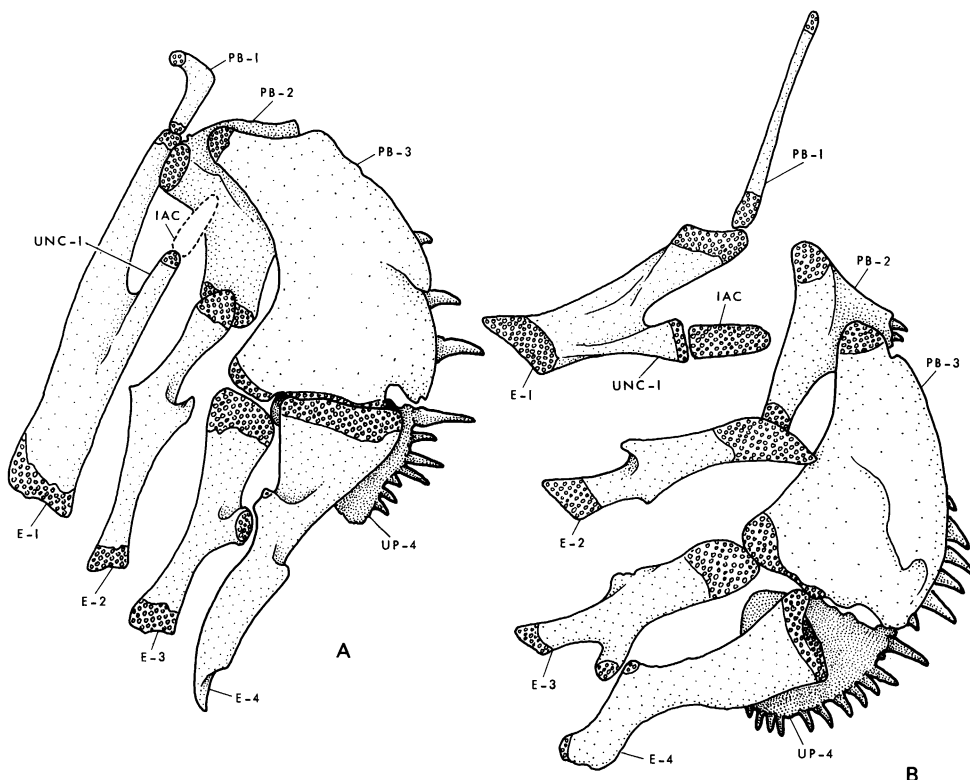

FIG. 7. "Atherinoid" dorsal gill arches. *Rheocles alaotrensis* (Pellegrin), AMNH 28127 (position of IAC estimated). B, *Melanotaenia maccullochi* Ogilby, AMNH 44401.

inomorpha (loss of fourth pharyngobranchial and enlargement of fourth epibranchial); other parts define a group including cyprinodontoids, ricefishes, and exocoetoids (absence of uncinete process and expansion of base of first epibranchial; two other possible features are discussed below), and define a subgroup consisting of ricefishes and exocoetoids. The two additional features of the dorsal gill arches that are consistent with an alignment of killifishes with ricefishes and exocoetoids are the absence in all of a first pharyngobranchial (as contrasted with its presence in atherinoids) and the trend toward size reduction of the second and third epibranchials in the plesiomorphous groups referred to by Parenti (1981) as aplocheiloids (fig. 10). The problems with interpretation of these two features are that the first is a loss-character which is also true of phallostethid fishes (fig.

19) (and we have no way of distinguishing the two cases of bone loss as different) and the second is somewhat ambiguous because the difference in size between the first and the second and third epibranchials is only slight in aplocheiloids (although it is quite pronounced among apomorph groups of killifishes referred by Parenti to the cyprinodontoids).

REPRODUCTION AND DEVELOPMENT

Since the sexual products have previously been considered evidence for monophyly of the Atherinomorpha and since no recent summary of this evidence exists, some comments are in order. In 1964 Rosen noted that a "large, spherical, demersal, chorionated egg with adhesive filaments occurs in all . . . groups." He also recorded that (1) in the

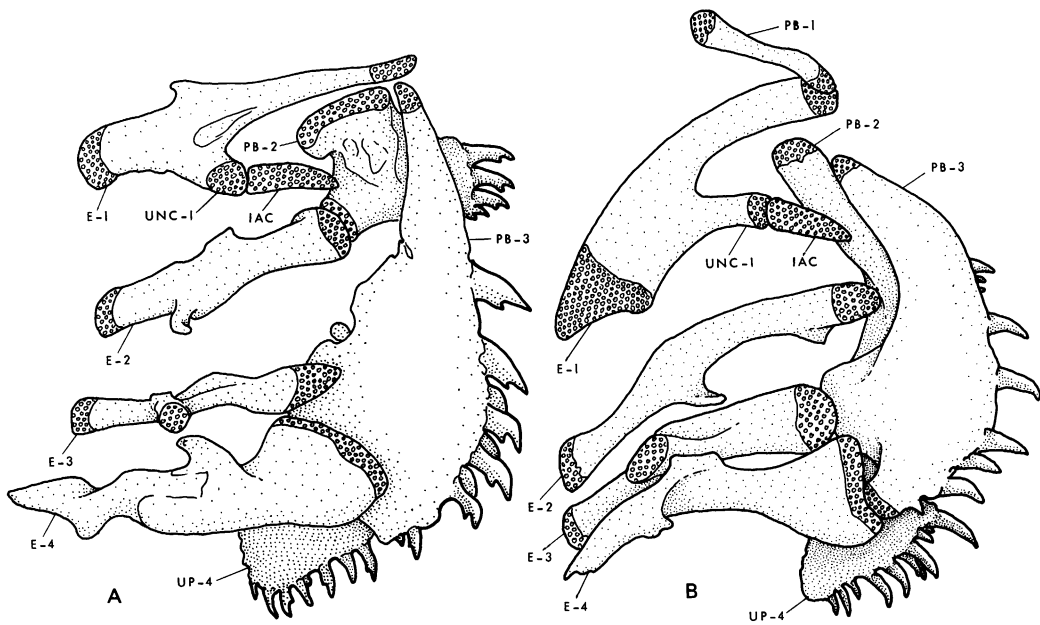

FIG. 8. "Atherinoid" dorsal gill arches. A, *Melaniris chagresi* (Meek and Hildebrand), UMMZ 179955. B, *Bedotia geayi* Pellegrin, AMNH 28132.

developing embryo of *Exocoetus*, *Oryzias*, the cyprinodontoid *Xiphophorus* and *Menidia*, but not in *Sphyaena*, and probably not in *Mugil* and other fishes, the heart is displaced forward in front of the head on the yolk sac instead of developing in the throat region and (2) that the consequence of this exceptional embryonic cardiac inversion is "the complete separation of the afferent and efferent circulation in the pericardial serosa, whereas the embryos of fishes with a more usual position of the heart have the afferent and efferent circulations superimposed." Rosen also noted, as did Greenwood et al. (1966), that the atherinomorph egg lacks an oil globule, and this was based on an earlier statement by Orton (1955). Foster (1967), however, regarded exocoetoids as reproductively more specialized than atherinoids or cyprinodontoids because "exocoetoids have secondarily lost the conspicuous oil globules which are present in the eggs of members of the other two suborders." Later Foster (1968) wrote that "Although conspicuous lipid globules are con-

sistently observed in the eggs of [cyprinodontoids and atherinoids] . . . these globules are never observed in the eggs of any [exocoetoid] . . . except those of certain hemiramphids." Foster did not mention which hemiramphids, but his general observations might suggest that exocoetoids have eggs in some sense different from those of other atherinomorphs. All of these observations and opinions were made within a context of a classification in which ricefishes were considered cyprinodontoids rather than exocoetoids. But with ricefishes as the plesiomorph group of exocoetoids Rugh's (1952) description of the *Oryzias* egg has special interest: "At oviposition many oil globules may be seen between the yolk and the periblast. During early development these decrease in number by confluence and merge into a single large globule at the vegetal pole." About the related *Horaichthys* Kulkarni (1940) wrote: "The ovum contains a large amount of yolk with a number of globules in it. The globules are numerous, small and scattered in eggs just removed from the

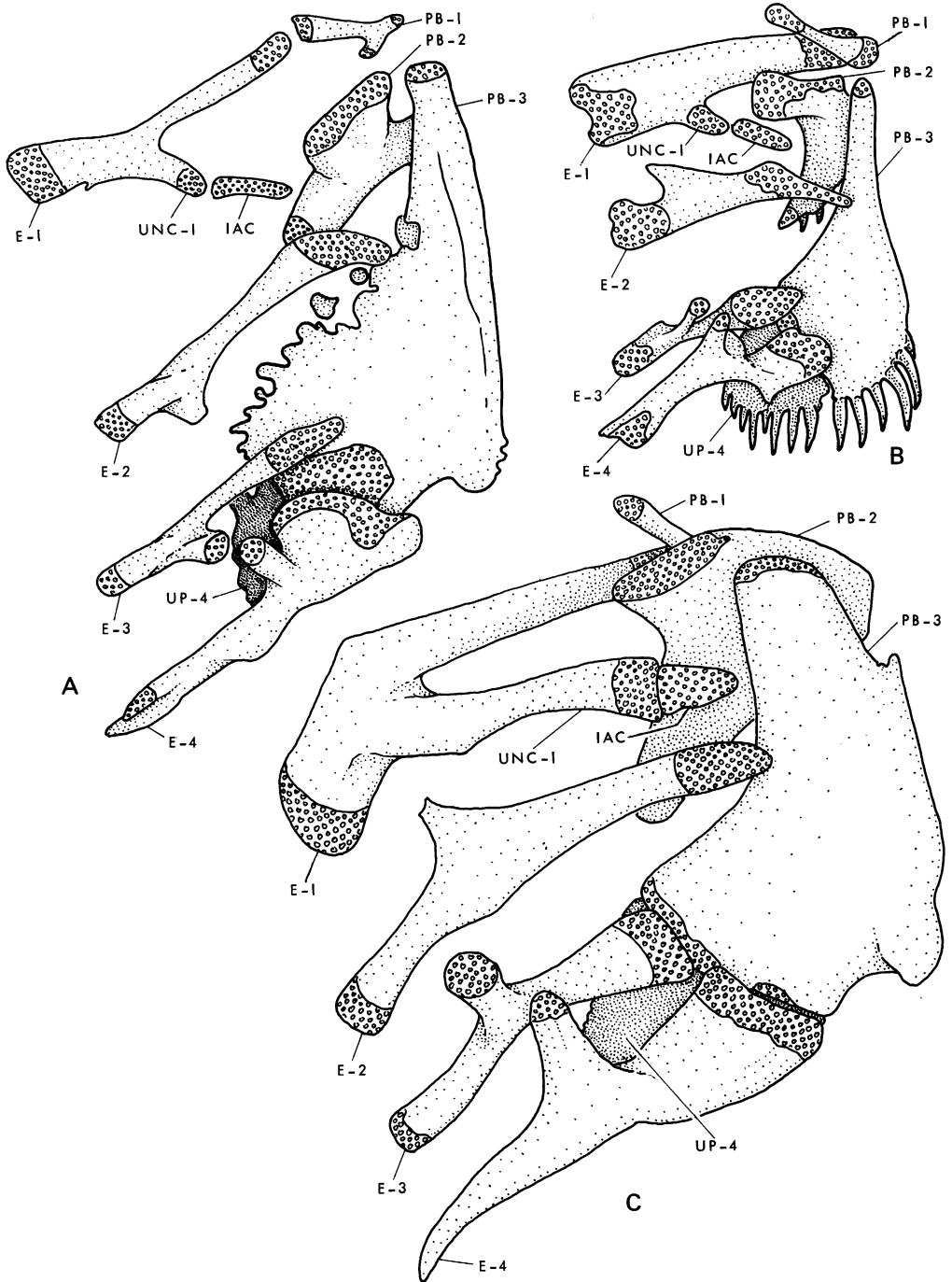

FIG. 9. "Atherinoid" dorsal gill arches. A, *Menidia menidia* (Linnaeus), AMNH 35924. B, *Quirichthys stramineus* (Whitley), AMNH 20571. C, *Pseudomugil novaeguineae* Weber, AMNH 20345.

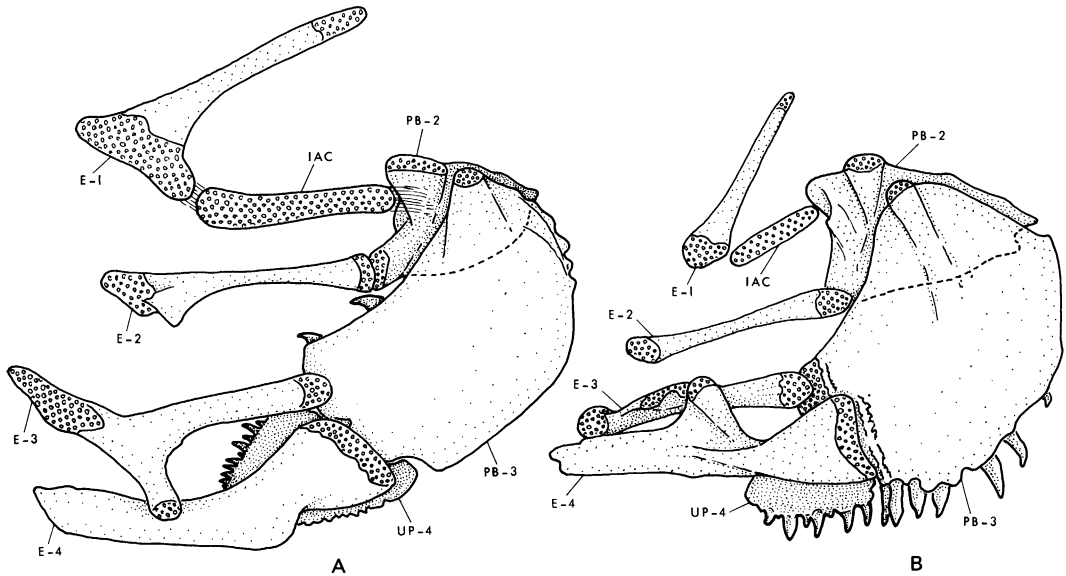

FIG. 10. Aplocheiloid cyprinodontiform dorsal gill arches. A, *Aplocheilus panchax* (Hamilton-Buchanan), AMNH 44403. B, *Rivulus harti* (Boulenger), AMNH 15189. The base of E-1 in A is the usual condition of cyprinodontiforms.

ovary . . . but in those which . . . development has . . . proceeded the oil globules are large, fewer in number and concentrated at one pole.”

Kulkarni (*op. cit.*) was also the first author to notice the similarity of the chorionic filaments in various kinds of atherinomorph eggs. He recorded two kinds of filaments, short ones of mostly uniform length distributed over the egg and a tuft of longer ones that entangled the egg on plant material. He compared the egg of *Horaichthys* with those of killifishes and needlefishes and then wrote that “with its two types of filaments, appears in many respects to be very similar to that of the Philippine *Gulaphallus* [a phallostethid] . . . [and that the] egg of *Oryzias* . . . is also similar, though the shorter filaments . . . appear to be much smaller and the longer ones rolled into a thicker cluster than in *Horaichthys*.” Earlier, Breder (1932) had illustrated the structure and relative size of the long and short filaments on the egg chorion of *Parxocoetus*, a flyingfish.

Derived similarities in the ovum and em-

bryogenesis among the main groups of atherinomorphs are paralleled by those in testicular structure. According to Grier, Linton, Leatherland, and DeVlaming (1980) and Grier, Burns, and Flores (in press) spermatogonia are entirely restricted to the distal end of the tubule immediately beneath the tunica albuginea whereas other groups of teleosts have the spermatogonia distributed along the length of the tubule. There is also a possibility that atherinomorph sperm are distinctive (Grier, 1976).

MONOPHYLY

“ATHERINOIDS”: The modern taxonomic concept of “atherinoid” fishes is derived from their former inclusion in a larger group, Percosoces or Mugiliformes, which contained also mullets, barracudas, and sometimes, threadfins. Their taxonomic definition usually amounted to a statement that they are different from barracudas and similar to mullets or that they lacked the defining characters of both barracudas and mullets. Jor-

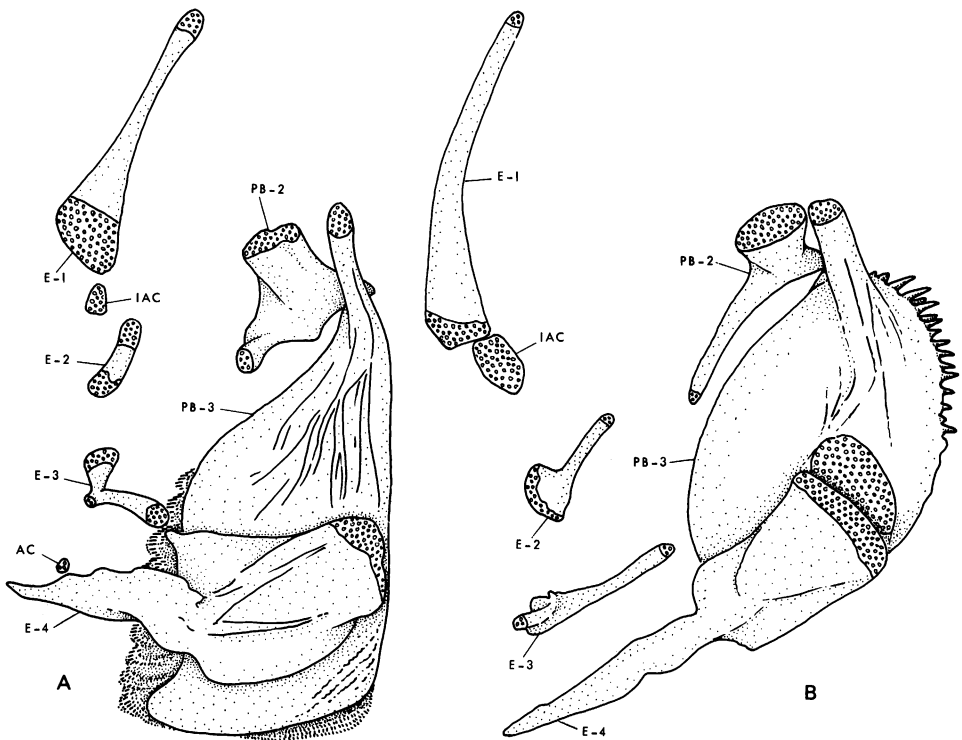

FIG. 11. Adrianichthyoid dorsal gill arches. A, *Xenopoeilus sarasinorum* (Popta), AMNH 20481. B, *Xenopoeilus poptae* Weber and de Beaufort, AMNH 20480.

dan (1905), for example, identified them as the "most primitive of living *Percesoces*," stating that they are small, slender fishes with a small mouth and feeble teeth, no lateral line, and in color translucent green sometimes with a broad band of silver or burnished black. Jordan and Hubbs (1919), in the first major review of the family, were of the opinion that "the numerous genera of the Atherinidae . . . form a compact and obviously natural group," but gave no diagnostic characters for it.

The earliest attempt at detailed anatomical definition of "atherinoids" was by Starks (1899) who wrote: "Lower limb of post-temporal attached to opisthotic by ligament; basisphenoid developed; myodome opening to exterior posteriorly; region about foramen magnum not produced; superior pharyngeals typical in shape, bearing teeth; vertebrae nu-

merous, from 45 to 52; first dorsal with from 3 to 8 spines; anal with 1 spine." Parts of this definition, consisting entirely of ambiguous or primitive characters, or statements now known to be inaccurate, have been incorporated into some subsequent definitions of the group or have been replaced entirely by comparable lists. Berg (1940) gave only: pelvic bones connected with cleithra by a ligament; vertebrae 31 to 60; lower and upper ribs present; no intermuscular bones. Gosline (1962) wrote: pelvic girdle not supported by postcleithral strut; vertebrae more than 26; eggs usually adhesive; spinous dorsal placed well back on body; pectoral fins high on sides; pelvic fins with a spine and five soft rays; third and fourth upper pharyngeals fused; infraorbital canal interrupted. Rosen (1964), in a key, provided this list: lateral line wanting or represented by a series of pits or

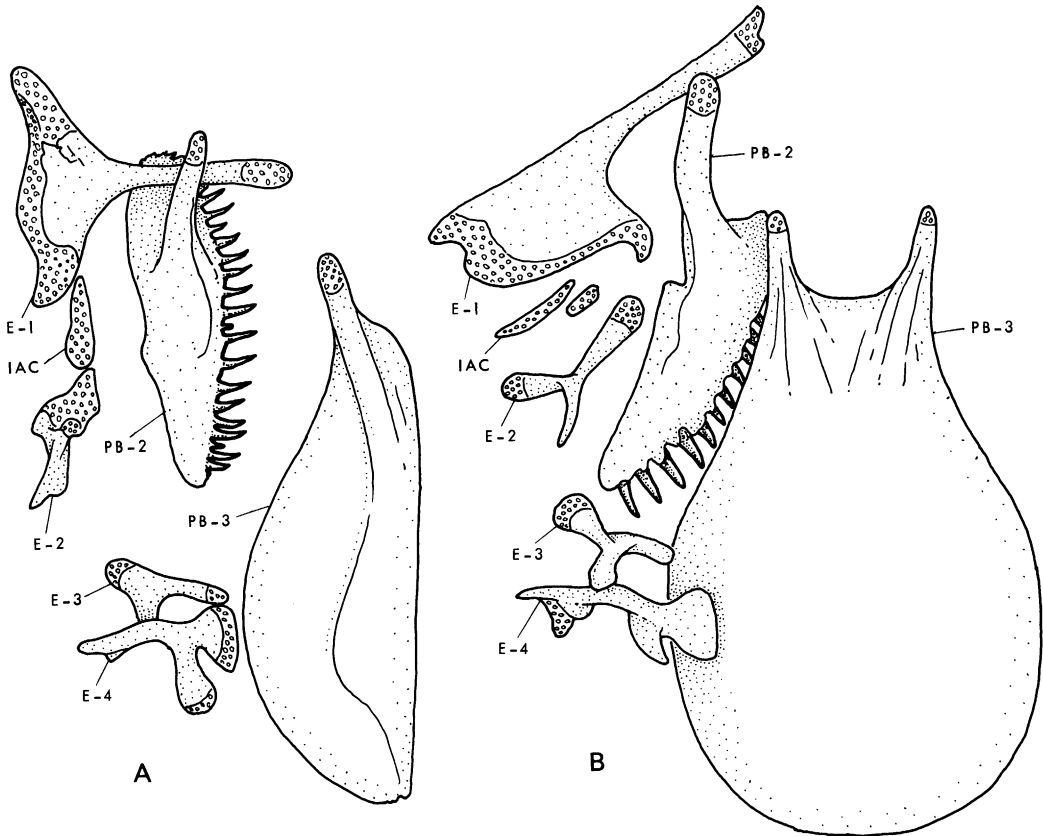

FIG. 12. Exocoetoid dorsal gill arches. A, *Parexocoetus brachypterus* (Richardson), AMNH 44402; same as *Hirundichthys affinis* (Günther), AMNH 22001 and *Cypselurus furcatus* (Mitchill), AMNH 21810. B, *Arrhamphus sclerolepis* Günther, AMNH 40002.

scale canals at midside; lower pharyngeal bones separate; parietals present; branchiostegal rays five to seven; usually with a first dorsal fin of flexible spines above or in advance of anal origin; anal fin usually preceded by a spine; narial opening paired; pelvic fins abdominal, subabdominal or thoracic in position, not modified into a clasping organ; first pleural rib on third vertebra; and adductor arcus palatini muscle restricted to posterior part of orbit. More recently Nelson (1976) listed a selection of some of the ambiguous and primitive features given above. One of the most striking features of this collection of definitions is the extent to which they differ on the nature of certain characters

(number of vertebrae, position of spinous dorsal fin, development of lateral line) and the kinds of characters included. It seems fair to conclude that there has been a great deal of uncertainty about exactly what it takes to be an "atherinoid" fish.

We are unable to diagnose the "atherinoids" cladistically. For example, if we judge that atherinomorphs are acanthopterygian fishes, then it is primitive for atherinomorphs to have dorsal, anal and pelvic fin spines, about 26 vertebrae, 15 branched caudal rays, a thoracic or subthoracic pelvic girdle, and the spinous and soft dorsal rays joined or only narrowly separated. The atherinomorphs that most closely approximate

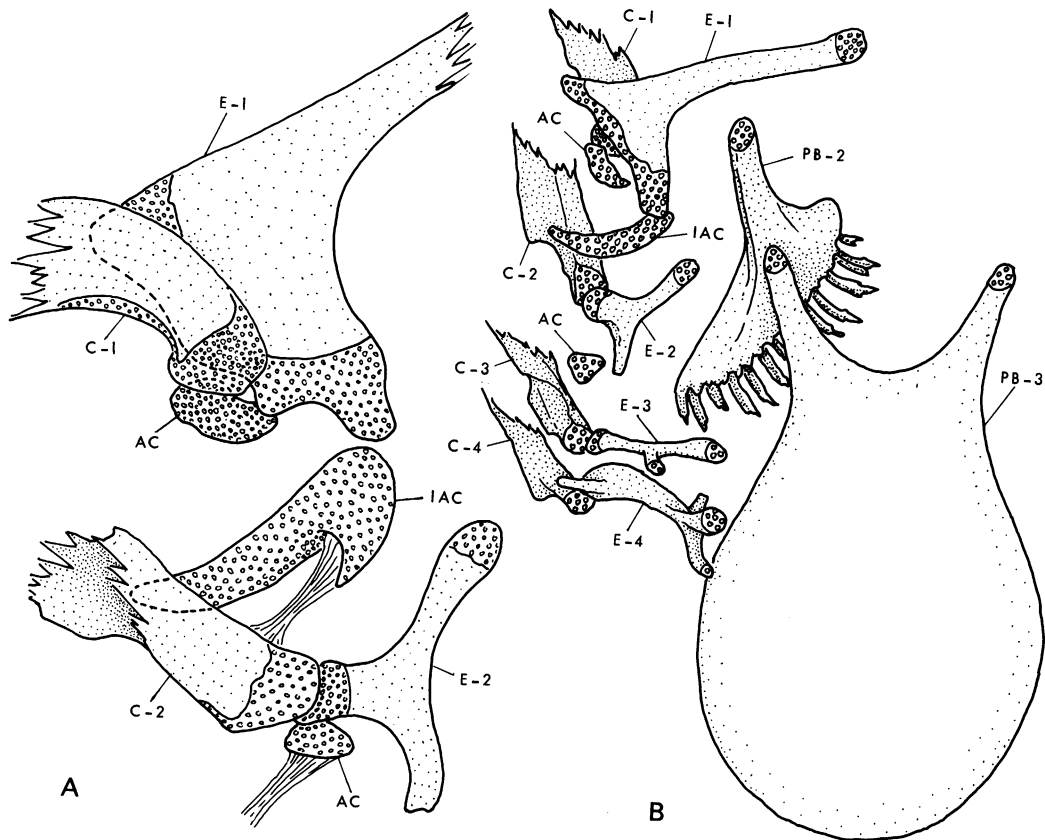

FIG. 13. Exocoetoid dorsal gill arches. *Chriodorus atherinoides* Goode and Bean, AMNH 20599. A, detail of bases of first two epibranchials. B, dorsal gill arch skeleton.

these primitive conditions are the freshwater Malagaysian species of the genera *Rheocles*, *Rheocloides*, and *Bedotia*. The freshwater rainbowfishes, or melanotaeniids, of Australia and New Guinea resemble the Malagaysian forms but have a more derived condition of the two dorsals, thereby aligning them with non-Malagaysian atherinomorphs. Likewise other "atherinoids" (the freshwater pseudomugilids of New Guinea and Australia, the freshwater phallostethids from the Philippines, and the worldwide freshwater and marine atherinids) have still further derived conditions of the dorsal fins, and of the pelvics, the extent of spine development, and number of vertebrae, as well, which align at least some of them more closely with

cyprinodontoids and exocoetoids than with the rainbowfishes or Malagaysian silversides (see Myers, 1928). Therefore, an Atherinidae might only be definable by exclusion of both bedotiids and melanotaeniids as in the suggested alignments above.

Although, as used by previous authors, neither the Atherinidae nor the Atherinoidei can be presently regarded as monophyletic groups, the groups referred to as the bedotiids, melanotaeniids, atherinids, pseudomugilids, telmatherinids, isonids, and phallostethids can collectively be regarded as outgroups for specifying the defining characters and relationships of cyprinodontoids, adrianichthyoids, and exocoetoids. Allen (1980, pp. 451, 452) combined the pseudo-

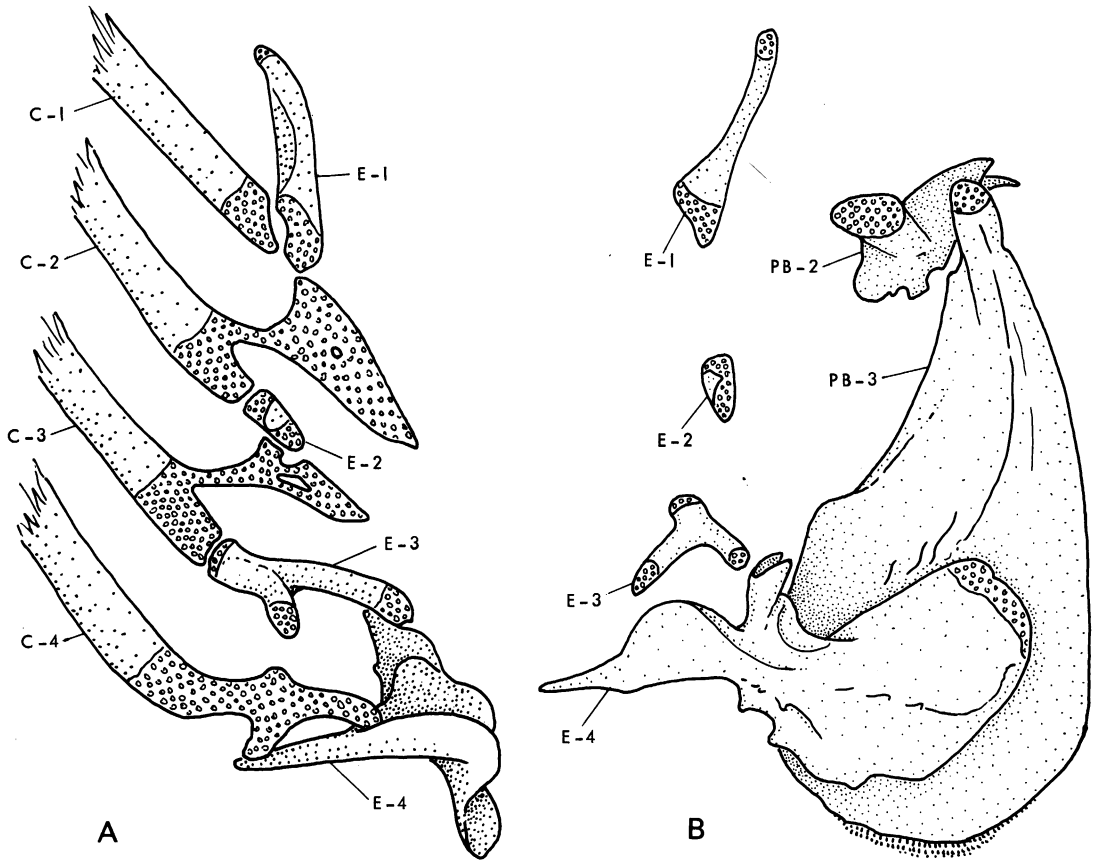

FIG. 14. Adrianichthyoid dorsal gill arches. *Oryzias luzonensis* (Herre and Ablan), SU 29564. A, detail of ceratobranchials and epibranchials. The triangular cartilaginous processes on C-2 and C-3 are diagnostic of unreduced adrianichthyoid ceratobranchials. B, dorsal gill arch skeleton.

mugilids with the melanotaeniids based on shared specializations of the pelvic region and, although his studies were confined to only certain "atherinoid" groups of the Australia-New Guinea region, we provisionally accept that alignment.

CYPRINODONTIFORMS (=CYPRINODONTOIDS OF ROSEN, 1964; GREENWOOD ET AL., 1966): Cyprinodontiform synapomorphies are discussed at length by Parenti (1981). As atherinomorphs, their unique defining features are the symmetrical caudal fin endoskeleton in which the epural symmetrically opposes the parhypural, the unlobed caudal fin, the position of the first pleural rib on the second vertebra (rather than the third or

fourth), the lowset pectoral fins with a large, scalelike postcleithrum, a pattern of early sexual maturation and prolonged embryonic development, and the structure of the dorsal gill arch skeleton. As described above, the last character is the elongate interarcual cartilage that joins the expanded base of the first epibranchial with the shaft of the second pharyngobranchial. Only one other group of teleosts with a similar condition is known to us, viz., the gobioid fishes in which a long cartilage joins the base of the first epibranchial with the tip of the second pharyngobranchial uncinat process.

CYPRINODONTIFORMS PLUS BELONIFORMS: Characters that unite cyprinodonti-

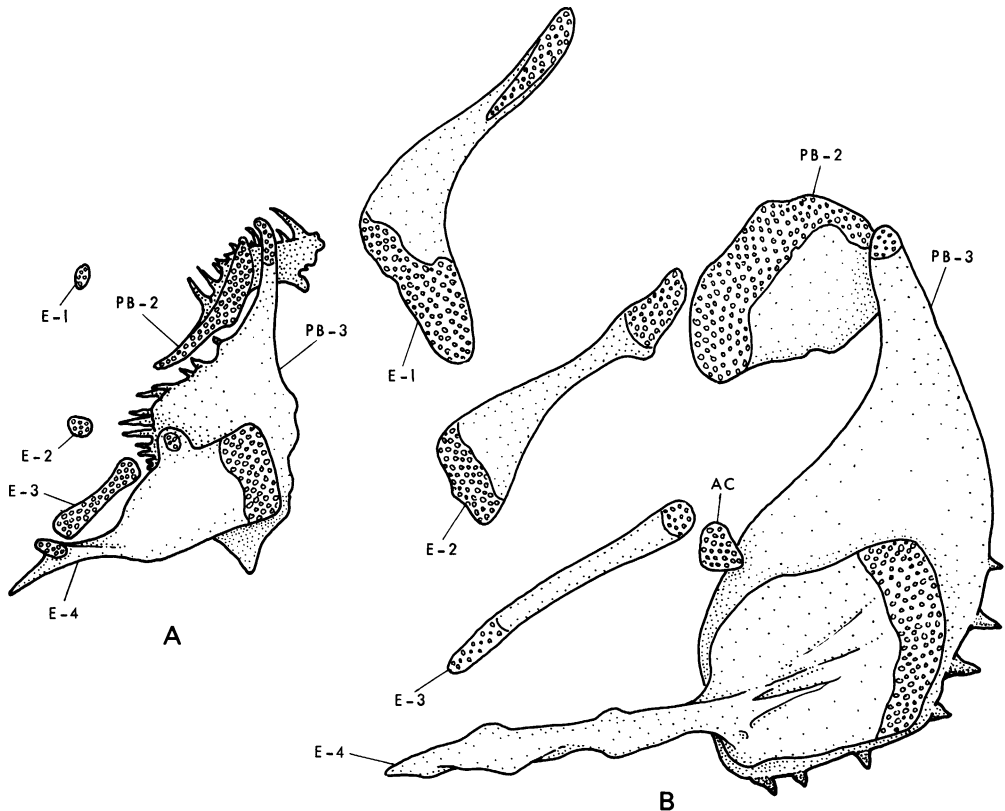

FIG. 15. Adrianichthyoid dorsal gill arches. A, *Horaichthys setnai* Kulkarni, AMNH 36576. B, *Adrianichthys kruyti* Weber, UBC.

forms with adrianichthyoid and exocoetoid fishes (=Beloniformes in the present usage) are the expanded base of the first epibranchial, the size reduction of the second and third epibranchials, the loss of the first pharyngobranchial (also true of phallostethids) and the absence of a second infraorbital bone (that is, the infraorbital series is represented only by the preorbital, or lacrimal and dermosphenotic, whereas in atherinoids there are three bones present in the infraorbital series).

BELONIFORMS (=ADRIANICHTHYOIDS AND EXOCOETOIDS): Adrianichthyoid fishes are defined easily by the great expansion of the articular surface of the fourth epibranchial, the presence of a complex, branched, cartilaginous ceratobranchial epiphysis, a re-

duced autopalatine with posterior articular cartilage (Rosen, 1964), and no metapterygoid or ectopterygoid (the last two are homoplasious with the condition in some or all cyprinodontoids).

Exocoetoids are defined by the presence of a median lower pharyngeal tooth plate (see Rosen, 1964), a ventral platelike process posteriorly on the basioccipital, an elongate lower jaw in at least some stage of the life history (Nichols and Breder, 1928), more than three anterior branchiostegal rays (see Rosen, 1964, pp. 239-240), and a single narial opening on each side (Burne, 1909). One other feature mentioned frequently (e.g., Hubbs and Wisner, 1979) as an exocoetoid trait is the low trunk lateral line; however, some freshwater hemiramphids lack a later-

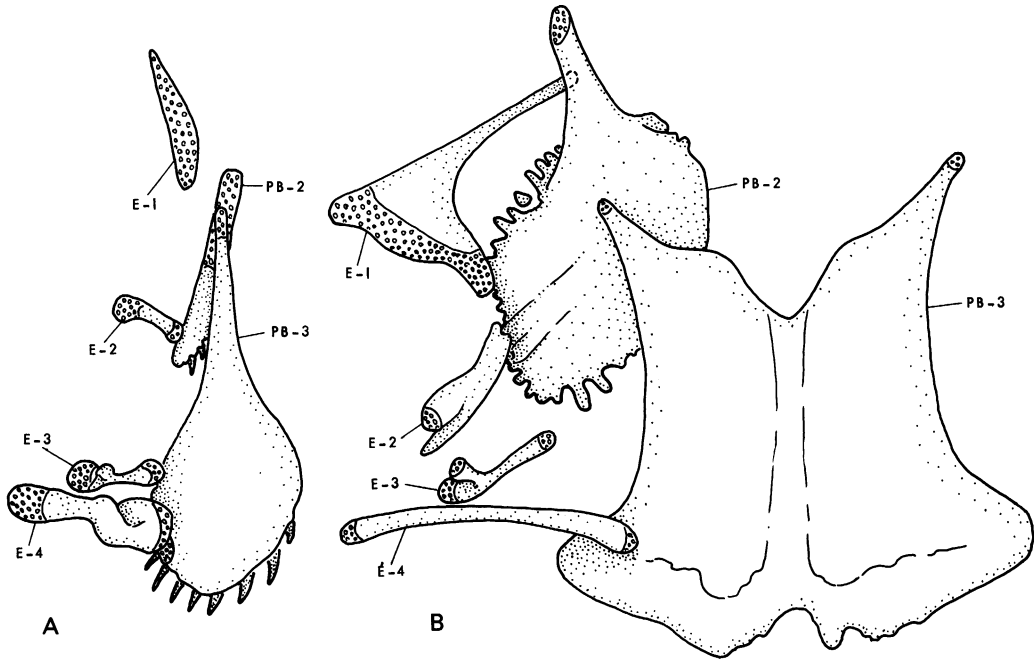

FIG. 16. Scomberesocoid and exocoetoid dorsal gill arches. A, *Belonion apodion* Collette, AMNH 36579. B, *Nomorhamphus celebensis* Weber and de Beaufort, AMNH 35379, showing fusion of right and left PB-3.

alis canal system as do the adrianichthyoids, nearest allies to the exocoetoids. A study of the early development of the lateralis system might resolve the uncertainty about the significance of this feature.

A group comprising adrianichthyoids and exocoetoids, the beloniforms, is defined by the small or absent (inferred reduction or loss, see above) interarcual cartilage, relatively very small second and third epibranchials, vertical reorientation of the second pharyngobranchial, presence of large ventral flanges on the fifth ceratobranchials, only a single, ventral hypohyal bone, no interhyal bone, and the lower caudal fin lobe with more principal rays than the upper lobe (e.g., with formulas of I,6-7,I; I,6-6,II; I,5-6,I; I,5-5,II, etc., but never with more principal rays in the upper lobe as is primitive for all other euteleosts except some catfishes). One species of *Pseudomugil* (*P. tenellus*) that we have examined also has a I,6-7,I caudal ray count.

CLADISTIC SUMMARY OF MAIN GROUPS

CHARACTERS: The characters rated here as synapomorphies of major atherinomorph groups are those of the cladistically plesiomorphous members of each group. The reasoning is that derived characters shared only by apomorph groups belonging to different lineages or by only one or a few apomorph species of different groups require numerous assumptions of character convergence or reversal (homoplasy) to account for the absence of these characters elsewhere. Theories of relationship such as those incorporating numerous assumptions of homoplasy are by definition less parsimonious than those in which the derived characters, present in cladistically plesiomorphous species or groups, are inferred to have been lost or gained but once in the ancestor of all apomorph (descendant) members. A simple illustration of this problem is the occurrence

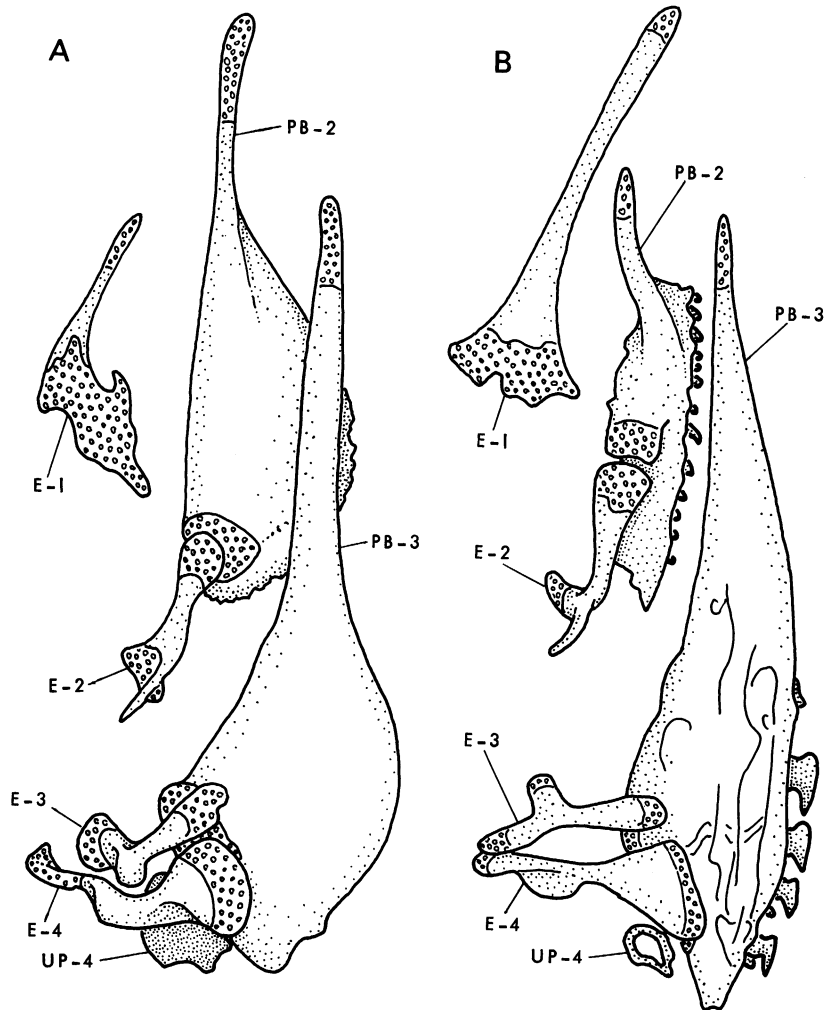

FIG. 17. Scomberesocoid dorsal gill arches. A, *Xenentodon cancila* (Hamilton-Buchanan), AMNH 38433. B, *Cololabis brevirostris* (Peters), AMNH 14133.

of fin spines in the Atherinomorpha. If atherinomorphs are members of the Ctenosquamata (myctophiforms, paracanthopterygians, atherinomorphs, and percomorphs, as treated by Rosen, 1973), then fin spines may be regarded as synapomorphic for ctenosquamates and plesiomorphic for atherinomorphs. Because cyprinodontiforms and beloniforms lack fin spines it is necessary to postulate a single loss in their common ancestor if one or more of the spine-bearing

“atherinoids” are their plesiomorph sister group. If, on the other hand, we use the argument of Rosen (1964) that cyprinodontiforms and beloniforms are plesiomorphic to “atherinoids,” then spines would have to have been lost once and then regained by “atherinoids.” In addition to the added assumption of regaining fin spines, Rosen’s scheme requires five other homoplasies (in characters 3 and 14 to 17 as enumerated below). The present scheme is therefore pre-

ferred because it generates the fewest ad hoc assumptions about character convergence or reversal (i.e., only in characters 2 and 3).

Another example of this problem that is useful to mention here concerns the hyoid bar and branchiostegal rays because a certain pattern of these elements has been said to characterize apomorph groups of euteleosts (Hubbs, 1919; McAllister, 1968). The primitive condition of these elements is for the ventral margin of the anterior ceratohyal to be entire rather than notched and for the numerous (10 or more) branchiostegal rays to decrease gradually in size anteriorly and to be attached to the lateral face of the hyoid bar. The derived condition, characteristic of most neoteleosts, is for the ventral margin of the anterior ceratohyal to be notched and for the 10 or fewer branchiostegals to be divided into two series: a posterior series of bladelike rays on the lateral face of the hyoid bar posterior to the notch in the anterior ceratohyal and an anterior series of hairlike rays attached to the ventral edge of the anterior ceratohyal anterior to the notch. In the most derived condition there are generally no more than four bladelike rays on the lateral face of the bar. Based on this assessment, the hyoid apparatus of some exocoetoids (large number of branchiostegals, and absence of an anterior ceratohyal notch in belonids and scomberesocids) was assessed as primitive and constituted one of the early reasons for excluding these fishes and the related hemiramphids and exocoetoids from the acanthopterygian assemblage. Once the adrianichthyoids are included as the sister group of the exocoetoids, however, that early interpretation becomes problematical because the species of *Oryzias* and *Xenopoeilus* have only four posterior bladelike rays and one or two anterior hairlike rays in sequence with the bladelike ones and the anterior ceratohyal notched (*Adrianichthys* and *Horaichthys* have fewer rays). Accepting the synapomorphies that unite cyprinodontiforms and beloniforms (adrianichthyoids and exocoetoids), and these with "atherinoids," and observing that "atherinoids" and cyprinodontiforms have the de-

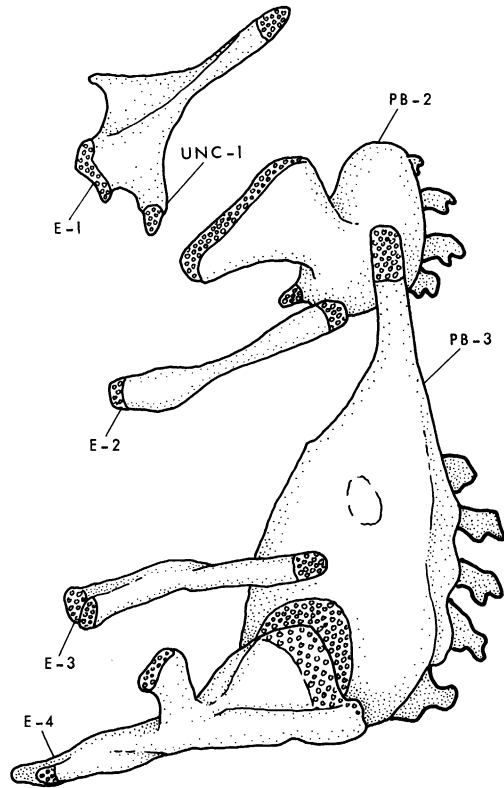

FIG. 18. "Atherinoid" dorsal gill arches. *Melanorhinus microps* (Poey), AMNH 25878. Note basal position of UNC-1 and absence of interarcual cartilage.

rived hyoid bar apparatus of percomorphs, prescribe two inferences: (1) that the structure and position of the anterior hairlike rays of adrianichthyoids is a transformed state of the condition in cyprinodontiform, "atherinoid" and percomorph fishes, and (2) that the apparently primitive condition of the hyoid apparatus in some exocoetoids is secondary (i.e., homoplasious).

A summary of the 17 characters we have used to establish a hypothesis of atherinomorph relationships follows:

A relationship between atherinomorphs and the neoteleosts is specified by, among other characters:

- (1) The four posterior bladelike branchiostegals inserting laterally on the

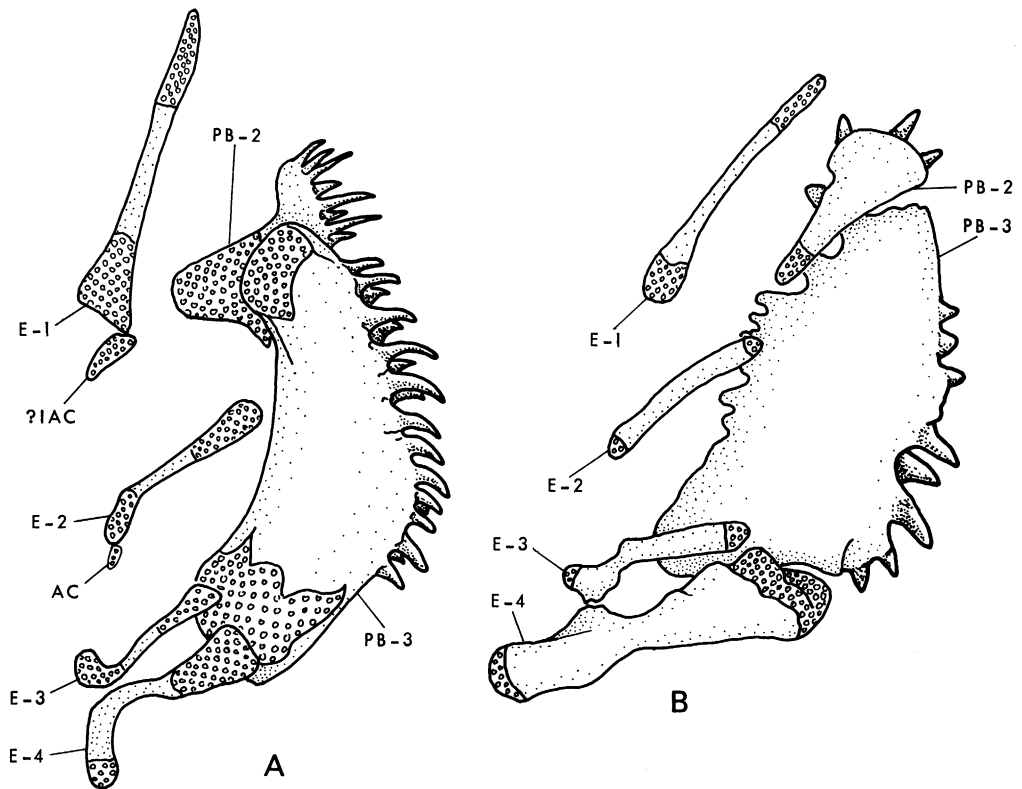

FIG. 19. Phallostethid dorsal gill arches. A, *Ceratostethus bicornis* (Regan), MCZ 47304-5. B, *Gulphallus mirabilis* Herre, SU 38903.

hyoid bar, the anteriormost inserting just posterior to a notch on the anterior ceratohyal.

That atherinomorphs are also members of a more restrictive group, the Ctenosquamata, is specified by, among other characters:

- (2) The presence of dorsal, anal and pelvic fin spines.

The relationship of the atherinomorphs to a still more restrictive grouping, the Percomorpha, is indicated by:

- (3) The presence in the dorsal gill arch skeleton of an interarcual cartilage between the first epibranchial and second pharyngobranchial.

Atherinomorphs are themselves defined as a monophyletic group by:

- (4) A large demersal egg with long adhesive and short filaments and many lipid globules that coalesce at the vegetal pole.
- (5) The complete separation of the embryonic afferent and efferent circulations by development of the heart in front of, rather than under, the head.
- (6) The spermatogonia forming only at the blind end of the tubule near the tunica albuginea.
- (7) The rostral cartilage being decoupled from the premaxilla.
- (8) Protrusile upper jaw mechanism with crossed palatamaxillary ligaments and with a maxillary ligament to the cranium.
- (9) Dermal and endochondral disclike ethmoid ossifications.

- (10) A hydraulic pump mechanism in the nasal organ.
- (11) The absence of third, fourth, and fifth infraorbital bones.
- (12) In the dorsal gill arch skeleton, the uncinat process arising on the proximal half of the first epibranchial, coalesced with the base of this epibranchial, or absent.
- (13) The absence of a fourth pharyngobranchial.

A subgroup of the atherinomorphs, consisting of cyprinodontiforms + beloniforms, is defined by:

- (14) The absence of a second infraorbital bone.
- (15) The first epibranchial with an expanded base and no separate uncinat process.
- (16) The absence of a first pharyngobranchial.
- (17) The second and third epibranchials noticeably smaller than the first and fourth.

For reasons of parsimony, as explained above, we rate a number of shared features as convergent or reversed. Convergent characters include: (1) absence of an interarcual cartilage in the atherinid *Melanorhinus* and in *Phallostethus* and present as a small basal cartilage in *Ceratostethus* (convergent with beloniforms); (2) a pelvic spine in male killifishes of the genus *Pantanodon* and a dorsal spine in the killifish *Jordanella* (convergent with spines in "atherinoids"); the pelvic spines in some exocoetoids (Rosen, 1964, p. 249) may be a retained primitive condition, however; (3) the attachment of the pelvic girdle posterior to the fourth rib in some atherinids, some cyprinodontiforms and in beloniforms; (4) presence of long premaxillary ascending processes in some "atherinoids" and in some cyprinodontiforms; (5) absence of an ectopterygoid and metapterygoid in cyprinodontoids and adrianichthyoids. Reversed characters include: (1) more than six pelvic fin rays in many species of New World aplocheiloid and a few apomorph cyprinodontoid killifishes (Parenti, 1981) and in

some specimens of *Oryzias* and in *Xenopoeilus*; (2) absence of most fin spines in some "atherinoids" and in most cyprinodontiforms and beloniforms; (3) absence of an anterior ceratohyal notch in belonids and scomberesocids and a large number of size-graded branchiostegals in all exocoetoids; (4) the posterior location of the pelvics in some atherinids and cyprinodontiforms, and in beloniforms (also rated, above, as convergent among these forms).

CLASSIFICATIONS: Branching diagrams from five sources are compared (Boulenger, 1904; Regan, 1910; Gosline, 1963; Rosen, 1964; and the proposed scheme) to illustrate the relative number of inferred convergent characters (homoplasies) in each (fig. 20). Cladistic representations of relationships of "atherinoids," cyprinodontiforms and beloniforms are based on explicit statements of relationships in the various sources, or are abstracted from a branching diagram provided by an author. In each case, the percomorphs are included to represent both other ctenosquamates (for purposes of adding fin spines to the analysis) and other neoteleosts (for purposes of adding the hyoid apparatus). The character state tree proposed here based on 17 characters, as just mentioned, incorporates only two homoplasies—the minimum number possible with these data. When these same 17 characters are placed on the branches of the cladogram representing Boulenger's scheme, 16 homoplasies are generated, character 1 being the only uncontradicted synapomorphy—and this is the same as the maximum number of homoplasies that would be generated by a completely unresolved polychotomy of the four taxa. Regan's scheme requires 11 homoplasies, and Rosen's, six. Gosline's scheme is similar to Regan's but fails to resolve the relationships of cyprinodontiforms and beloniforms in relation to "atherinoids" and percomorphs (i.e., the first two groups form a trichotomy with a branch that includes the last two groups), and is contradicted by 15 of the 17 characters. These results are not affected by the fact that we recognize the "atherinoids" as constituting six subgroups of unresolved interrelationships (bedotiids, melanota-

A : "atherinoids"
 B : Beloniformes
 C : Cyprinodontiformes
 P : Percomorpha

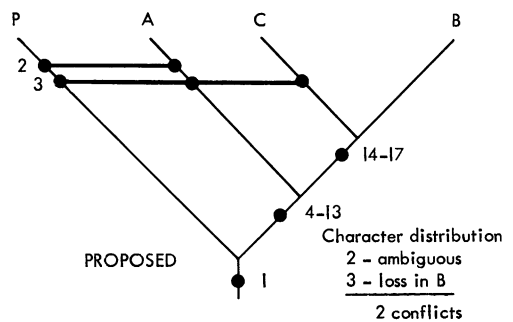
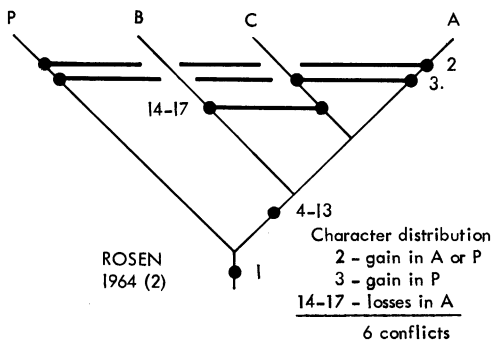
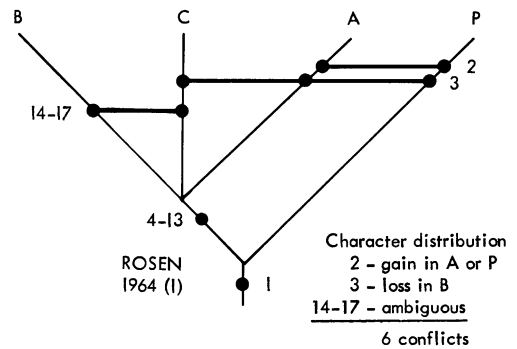
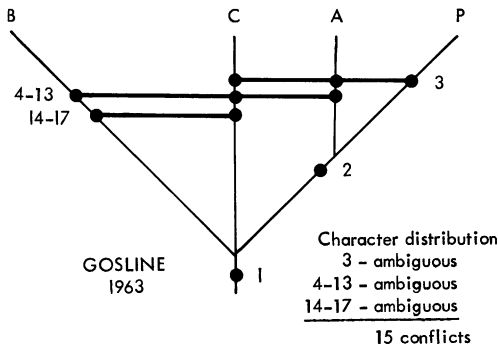
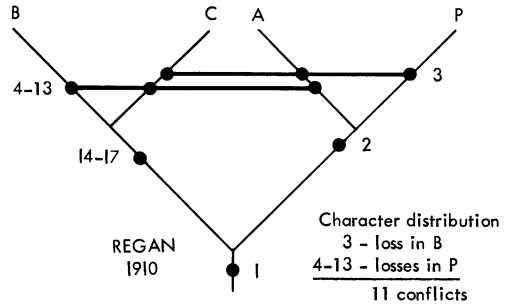
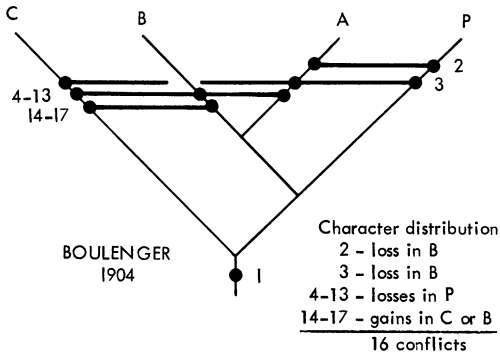

FIG. 20. Distribution of 17 apomorph characters (black dots) in six theories of relationship of four taxa. Numbers to left or right of dots in each diagram represent numbered characters in synapomorphy scheme in text. The character distributions show the most parsimonious interpretations of character conflict with cladistic structure. Thus, an inference of character loss or independent gain minimizes the number of character changes. Ambiguous characters are those involving two of the three branches in an unresolved trichotomy or those requiring the same number of assumptions about character loss or gain. The theories of Bouleenger, Regan, and Gosline are implied by their classifications of these and

eniids, atherinids, telmatherinids, isonids, and phallostethids), that Rosen (1964) treated "atherinoids" as a definable taxon, or that other authors considered the "atherinoids" to be part of a larger group containing also mugilids and sphyraenids.

We conclude that since our cladogram of relationships represents the most parsimonious arrangement of taxa based on the 17 characters employed, and represents what we believe to be the present state of knowledge about atherinomorph interrelationships, that cladogram should be used as a basis for a revised classification of atherinomorph fishes.

A classification derived from the proposed scheme in figure 20, and following convention with respect to exocoetoids, is:

Series Atherinomorpha

Division I

- Family Atherinidae
- Family Bedotiidae
- Family Isonidae
- Family Melanotaeniidae (including Pseudomugilidae)
- Family Phallostethidae (including Neostethidae)
- Family Telmatherinidae

Division II

Order Cyprinodontiformes (see Parenti, 1981)

Order Beloniformes

- Suborder Adrianichthyoidei
 - Family Adrianichthyidae (including Horaichthyidae and Oryziidae)

Suborder Exocoetoidei

- Superfamily Exocoetoidea
 - Family Hemiramphidae
 - Family Exocoetidae

Superfamily Scomberesocoidea

Family Belonidae

Family Scomberesocidae

ACKNOWLEDGMENTS

We thank Drs. Gareth Nelson for comments on the typescript and William Eschmeyer (California Academy of Sciences), William Fink (Museum of Comparative Zoology), Norman Wilimovsky (University of British Columbia), and Reeve Bailey (University of Michigan, Museum of Zoology) for lending specimens in their care.

LITERATURE CITED

- Alexander, R. McN.
1967. Mechanisms of the jaws in some atheriniform fishes. *Jour. Zool., London*, vol. 151, pp. 233-255.
- Allen, G. R.
1980. A generic classification of the rainbowfishes (family Melanotaeniidae). *Rec. Western Australian Mus.*, vol. 8, no. 3, pp. 449-490.
- Allis, E. P., Jr.
1903. The skull, and the cranial and first spinal muscles and nerves in *Scomber scomber*. *Jour. Morph.*, vol. 18, pp. 45-328.
1915. The homologies of the hyomandibula of the gnathostome fishes. *Ibid.*, vol. 26, pp. 563-624.
- Berg, L. S.
1940. Classification of fishes both Recent and fossil. Reprint, English and Russian, 1947. Ann Arbor, Michigan, J. W. Edwards, 517 pp.
- Boulenger, G. A.
1904. A synopsis of the suborders and families of teleostean fishes. *Ann. Mag. Nat. Hist.*, ser. 7, vol. 13, pp. 161-190.
- Breder, C. M., Jr.
1932. On the habits and development of cer-

←

other taxa. Gosline's is abstracted from his published branching diagram of numerous taxa. The diagram labeled Rosen (1964) (1) is implied by his classification with the addition of the percomorphs as an outgroup; that labeled Rosen (1964) (2) is implied by statements in his text. Some taxonomic equivalents in the literature are: (1) Cyprinodontiformes (=Cyprinodontoidei, part; Cyprinodontes, part; Microcyprini, part; Haplomi, part). (2) Beloniformes (=Pharyngognathi malacopterygii, part; Syntentognathi, part). (3) "atherinoids" (=Atherinoidei; Mugiliformes, part; Percosoces, part). (4) Percomorpha (=Percomorphi, part; Acanthopterygii, part).

- tain Atlantic Syngnathini. Papers Tortugas Lab., vol. 28, publ. no. 1, pp. 1-35.
- Breder, C. M., Jr., and D. E. Rosen
1966. Modes of reproduction in fishes. New York, Nat. Hist. Press, 941 pp.
- Burne, R. H.
1909. The anatomy of the olfactory organ of teleostean fishes. Proc. Zool. Soc. London, May-December, pp. 610-633.
- Foster, N. R.
1967. Trends in the evolution of reproductive behavior in killifishes. Studies Trop. Oceanogr., no. 5, pp. 549-566.
1968. Utility of egg and larval characters in the classification of atheriniform fishes (abstract). Amer. Zool., vol. 8, no. 4, abstr. 388.
- Gosline, W. A.
1962. Systematic position and relationships of the percopsine fishes. Pacific Sci., vol. 16 April, pp. 207-217.
1963. Considerations regarding the relationships of the percopsiform, cyprinodontiform, and gadiform fishes. Occas. Papers Mus. Zool., Univ. Michigan, no. 629, pp. 1-38.
- Greenwood, P. H., D. E. Rosen, S. H. Weitzman, and G. S. Myers
1966. Phyletic studies of teleostean fishes, with a provisional classification of living forms. Bull. Amer. Mus. Nat. Hist., vol. 131, art. 4, pp. 339-456.
- Grier, H. J.
1976. Sperm development in the teleost *Oryzias latipes*. Cell. Tiss. Res., vol. 168, pp. 419-431.
In press. Cellular organization of the testis and spermatogenesis in fishes. Amer. Zool.
- Grier, H. J., J. R. Burns, and J. A. Flores
In press. Testis structure in three species of teleosts with tubular gonopodia: *Anableps anableps*, *Anableps dowi*, and *Jenynsia lineata*. Copeia.
- Grier, H. J., J. R. Linton, J. F. Leatherland, and V. L. DeVlaming
1980. Structural evidence for two different testicular types in teleost fishes. Amer. Jour. Anat., vol. 159, pp. 331-345.
- Hubbs, C. L.
1919. A comparative study of the bones forming the opercular series of fishes. Jour. Morph., vol. 33, no. 1, pp. 61-71.
- Hubbs, C. L., and R. L. Wisner
1979. Revision of the sauries (Pisces, Scomberesocidae) with descriptions of two new genera and one new species. Fishery Bull., vol. 77, no. 3, pp. 521-566.
- Jordan, D. S.
1905. A guide to the study of fishes. New York, Henry Holt and Co., 2 vols., 624 and 599 pp.
- Jordan, D. S., and C. L. Hubbs
1919. A monographic review of the family of Atherinidae or silversides. Studies Ichthyol., Stanford Univ. Publ., Univ. Ser., 87 pp.
- Kulkarni, C. V.
1940. On the systematic position, structural modifications, bionomics and development of a remarkable new family of cyprinodont fishes from the province of Bombay. Rec. Indian Mus., vol. 42, pt. 2, pp. 379-423.
- McAllister, D. E.
1968. The evolution of branchiostegals and associated opercular, gular, and hyoid bones and the classification of teleostome fishes, living and fossil. Bull. Natl. Mus. Canada, no. 221, 239 pp.
- Melinkat, R., and E. Zeiske
1979. Functional morphology of ventilation of the olfactory organ in *Bedotia geayi* Pellegrin 1909 (Teleostei, Atherinidae). Zool. Anz., Jena, vol. 203, nos. 5/6, pp. 354-468.
- Myers, G. S.
1928. The systematic position of the phallostethid fishes, with diagnosis of a new genus from Siam. Amer. Mus. Novitates, no. 295, 12 pp.
- Nelson, G. J.
1968. Gill-arch structure in *Acanthodes*. In Ørvig, T. (ed.), Current problems of lower vertebrate phylogeny. Proc. Fourth Nobel Symp. June 1967 Swedish Mus. Nat. Hist. Stockholm, Almquist and Wiksell, pp. 129-143.
1969. Gill arches and the phylogeny of fishes, with notes on the classification of vertebrates. Bull. Amer. Mus. Nat. Hist., vol. 141, art. 4, pp. 475-552.
- Nelson, J. S.
1976. Fishes of the world. New York, John Wiley, 416 pp.
- Nichols, J. T., and C. M. Breder, Jr.
1928. An annotated list of the Syngnathini. Zoologica, vol. 8, no. 7, pp. 423-448.

Orton, G. L.

1955. Separation of eggs of synentognath and allotriognath fishes in early embryonic stages. *California Fish and Game*, vol. 41, no. 1, pp. 103-105.

Parenti, L. R.

1981. A phylogenetic and biogeographic analysis of cyprinodontiform fishes (Teleostei: Atherinomorpha). *Bull. Amer. Mus. Nat. Hist.*, vol. 168, art. 4, pp. 335-557.

Regan, C. T.

1910. Notes on the classification of the teleostean fishes. *Proc. Seventh Internatl. Zool. Congr.*, Cambridge, Massachusetts, pp. 1-16.

Rosen, D. E.

1964. The relationships and taxonomic position of the halfbeaks, killifishes, silversides, and their relatives. *Bull. Amer. Mus. Nat. Hist.*, vol. 127, art. 5, pp. 217-268.

1973. Interrelationships of higher euteleostean fishes. *In* Greenwood, P. H., R. S. Miles, and C. Patterson (eds.), *Interrelationships of fishes*. London, Academic Press, pp. 397-513.

Rosen, D. E., and P. H. Greenwood

1976. A fourth neotropical species of synbranchid eel and the phylogeny and systematics of synbranchiform fishes. *Bull. Amer. Mus. Nat. Hist.*, vol. 157, art. 1, pp. 1-70.

Rugh, R.

1952. *Experimental embryology. A manual of techniques and procedures*. Revised ed., second printing. Minneapolis, Burgess Publ. Co., 480 pp.

Starks, E. C.

1899. The osteological characters of the fishes of the suborder Percesoces. *Proc. U.S. Natl. Mus.*, vol. 22, no. 1179, pp. 1-10.

