

NASA/CR—2018—219903

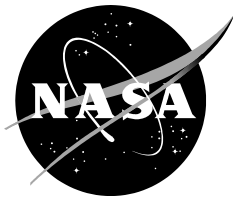

Exploration of Backscatter Methods for Wireless Avionics

Aaron Parks
Jeeva Wireless, Seattle, Washington

Vamsi Talla
Jeeva Wireless, Seattle, Washington

Bryce Kellogg
Jeeva Wireless, Seattle, Washington

Joshua Smith
Jeeva Wireless, Seattle, Washington

Shyam Gollakota
Jeeva Wireless, Seattle, Washington

June 2018

NASA STI Program ... in Profile

Since its founding, NASA has been dedicated to the advancement of aeronautics and space science. The NASA scientific and technical information (STI) program plays a key part in helping NASA maintain this important role.

The NASA STI program operates under the auspices of the Agency Chief Information Officer. It collects, organizes, provides for archiving, and disseminates NASA's STI. The NASA STI program provides access to the NTRS Registered and its public interface, the NASA Technical Reports Server, thus providing one of the largest collections of aeronautical and space science STI in the world. Results are published in both non-NASA channels and by NASA in the NASA STI Report Series, which includes the following report types:

- **TECHNICAL PUBLICATION.** Reports of completed research or a major significant phase of research that present the results of NASA Programs and include extensive data or theoretical analysis. Includes compilations of significant scientific and technical data and information deemed to be of continuing reference value. NASA counterpart of peer-reviewed formal professional papers but has less stringent limitations on manuscript length and extent of graphic presentations.
- **TECHNICAL MEMORANDUM.** Scientific and technical findings that are preliminary or of specialized interest, e.g., quick release reports, working papers, and bibliographies that contain minimal annotation. Does not contain extensive analysis.
- **CONTRACTOR REPORT.** Scientific and technical findings by NASA-sponsored contractors and grantees.
- **CONFERENCE PUBLICATION.** Collected papers from scientific and technical conferences, symposia, seminars, or other meetings sponsored or co-sponsored by NASA.
- **SPECIAL PUBLICATION.** Scientific, technical, or historical information from NASA programs, projects, and missions, often concerned with subjects having substantial public interest.
- **TECHNICAL TRANSLATION.** English-language translations of foreign scientific and technical material pertinent to NASA's mission.

Specialized services also include organizing and publishing research results, distributing specialized research announcements and feeds, providing information desk and personal search support, and enabling data exchange services.

For more information about the NASA STI program, see the following:

- Access the NASA STI program home page at <http://www.sti.nasa.gov>
- E-mail your question to help@sti.nasa.gov
- Phone the NASA STI Information Desk at 757-864-9658
- Write to:
NASA STI Information Desk
Mail Stop 148
NASA Langley Research Center
Hampton, VA 23681-2199

NASA/CR—2018—219903

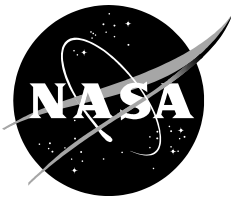

Exploration of Backscatter Methods for Wireless Avionics

Aaron Parks
Jeeva Wireless, Seattle, Washington

Vamsi Talla
Jeeva Wireless, Seattle, Washington

Bryce Kellogg
Jeeva Wireless, Seattle, Washington

Joshua Smith
Jeeva Wireless, Seattle, Washington

Shyam Gollakota
Jeeva Wireless, Seattle, Washington

National Aeronautics and
Space Administration

Neil A. Armstrong Flight Research Center
Edwards, CA 93523-0273

June 2018

Table of Contents

1. EXECUTIVE SUMMARY	3
2. INTRODUCTION.....	4
3. EXPERIMENTAL TEST SETUP	4
3.1. DOWNLINK SENSITIVITY TEST	5
3.2. UPLINK SENSITIVITY TEST WITH SELF-INTERFERENCE DERATING	6
3.2.1. <i>Mitigating Self-Interference Effects</i>	9
3.3. THROUGHPUT PROJECTIONS	10
3.4. REAL-WORLD RANGE TESTING	11
4. SUITABILITY OF PASSIVE RADIO FOR WIRELESS AVIONICS.....	13
4.1. MODELING.....	13
4.1.1. <i>Modeling Parameters</i>	13
4.1.2. <i>Assumptions and Simplifications</i>	14
4.1.3. <i>Protocol Options</i>	14
4.1.4. <i>Link Margin Analysis</i>	15
4.2. RESULTS	16
5. BACKGROUND ON JEEVA WIRELESS TECHNOLOGY	20
5.1. PASSIVE WI-FI, ZIGBEE, AND BLE.....	21
5.1.1. <i>Implementation and System Design</i>	21
5.2. WANS CATTER: CHIRP SPREAD SPECTRUM (CSS) PASSIVE RADIO.....	22
5.2.1. <i>System Design</i>	23
6. SUMMARY AND CONCLUSION.....	24

Appendices

APPENDIX A: COVERAGE PROJECTIONS FOR AIRCRAFT COMPARTMENTS AND OUTDOOR AREAS	25
APPENDIX B: WANS CATTER (CHIRP SPREAD SPECTRUM) PROJECTED COVERAGE.....	26
APPENDIX C: PASSIVE WI-FI PROJECTED COVERAGE	38
APPENDIX D: REFERENCES.....	50
APPENDIX E: ACRONYMS AND ABBREVIATIONS	51

Tables

TABLE 3-1: DOWNLINK SENSITIVITY TEST SUMMARY	6
TABLE 3-2: UPLINK SENSITIVITY AT VERY LOW LEVELS OF OUT-OF-BAND SELF-INTERFERENCE POWER.....	9
TABLE 3-3: MAXIMUM THROUGHPUT FOR APPLICATION DATA TRANSFER GIVEN IDEAL NETWORK CONDITIONS.....	10
TABLE 4-1: ANALYSIS OF ITU-R M.2197 HO CLASS MEMBER APPLICATIONS.....	16
TABLE 4-2: ANALYSIS OF ITU-R M.2197 HI CLASS MEMBER APPLICATIONS	17
TABLE 4-3: ANALYSIS OF ITU-R M.2197 LO CLASS MEMBER APPLICATIONS	18
TABLE 4-4: ANALYSIS OF ITU-R M.2197 LI CLASS MEMBER APPLICATIONS.....	19

Equations

EQUATION 1: BACKSCATTERED SIGNAL POWER AS SEEN AT THE RECEIVER.....	6
EQUATION 2: SIMPLIFIED LINK MARGIN EQUATION.....	15
EQUATION 3: EXPANDED LINK MARGIN EQUATION	15

Figures

FIGURE 2-1: TOPOLOGY FOR THE TWO JEEVA PASSIVE RADIO SYSTEMS INVESTIGATED	4
FIGURE 3-1: GENERAL CONFIGURATION OF TRANSMIT COMPANION, TAG, AND RECEIVER	5
FIGURE 3-2: DOWNLINK RECEIVER SENSITIVITY TEST SETUP.....	5
FIGURE 3-3: EXAMPLE FREQUENCY PLAN FOR THE PASSIVE RADIO SYSTEM.....	7
FIGURE 3-4: UPLINK SENSITIVITY WITH SELF-INTERFERENCE DERATING TEST BLOCK DIAGRAM	8
FIGURE 3-5: UPLINK SENSITIVITY WITH SELF-INTERFERENCE DERATING TEST LAB SETUP	8
FIGURE 3-6: MEASURED SENSITIVITY AS A FUNCTION OF SELF-INTERFERENCE.....	9
FIGURE 3-7: RESULTS OF MODELING THE HALLWAY TEST	11
FIGURE 3-8: HALLWAY TEST.....	11
FIGURE 3-9: PER AS A FUNCTION OF ENDPOINT POSITION (WANSCLATTER).....	12
FIGURE 3-10: PER AS A FUNCTION OF LINK MARGIN.....	12
FIGURE 3-11: PER AS A FUNCTION OF RECEIVER POSITION (PASSIVE WI-FI)	13
FIGURE 5-1: OVERVIEW OF THE PASSIVE WI-FI/ZIGBEE/BLE SYSTEM.....	21
FIGURE 5-2: PASSIVE WI-FI WINDOW SECURITY SYSTEM.....	22
FIGURE 5-3: DEPLOYMENT OF A LONG RANGE PASSIVE RADIO SYSTEM	22
FIGURE 5-4: CHIRP SYMBOLS	23
FIGURE 5-5: COTS ENDPOINT AND COMPANION PROTOTYPE.....	24

1. Executive Summary

This report describes and characterizes the low-power Jeeva Passive Radio systems, including Wanscatter (passive Chirp Spread Spectrum) and Passive Wi-Fi, with respect to their applicability to wireless avionics. The Wireless Avionics Intra-Communications (WAIC) objectives document, ITU-R M.2197 [1], describes a number of applications of wireless avionics, and lists requirements specifications for each. Additionally, it describes models for compartments and areas of aircraft or vehicles in which wireless avionics would be applied. This exploratory study attempts to map Jeeva's Passive Radio technology to those scenarios outlined in the ITU-R M.2197 operational objectives document, and determine the areas and applications for which it is most suitable.

Jeeva Passive Radio operates differently than conventional radios. In a conventional radio, a sensor-connected radio node must actively emit a signal in order to communicate. In a Jeeva Passive Radio system, that node instead simply reflects radio frequency energy which is emitted by another nearby device (called the Companion), which can be "plugged in" or otherwise has access to more power. Using reflections, a data packet can be generated and interpreted by a standard receiver. This method of communication inherently uses less energy, resulting in the potential for far lower power consumption and thus far longer battery life.

Overall, 68.4% of use cases described by the ITU-R M.2197 operational objectives document were found to be addressable by Jeeva's Passive Radio systems (26 addressable of 38 total), with 26 of those best addressable by Wanscatter and three found to be best addressable with passive Wi-Fi. See Section 4.2 for a detailed breakdown of application suitability. The most fitting types of applications were in the LI (Low-rate Indoors) and LO (Low-rate Outdoors) categories, where lower rates were acceptable and thus Wanscatter could be applied and its much better uplink sensitivity leveraged.

Jeeva has identified the Wanscatter (Chirp Spread Spectrum) system as likely holding the most promise for applications such as those outlined in the ITU-R M.2197 operational objectives document. We recommend that Wanscatter be a technology considered for adoption in wireless avionics.

2. Introduction

Jeeva Wireless' Passive Radio technology allows devices to communicate at extremely low power by using backscatter modulation. This report explores the applicability of Passive Radio technologies to wireless avionics. Specifically, this report focuses on the Wanscatter (Passive Chirp Spread Spectrum) and Passive Wi-Fi systems.

The objective of Passive Radio is to reduce the power and complexity required for a low power sensing device to perform wireless communications. Passive Radio leverages a fundamentally different mechanism for transmitting information (reflections rather than emissions).

In the Passive Radio system, RF energy in the form of a brief continuous wave (CW) is emitted by an external, high-capable and powered device called the **Companion**. This signal from the Companion impinges on nearby **Endpoint** antenna(s), and when an Endpoint chooses to communicate it simply modulates the reflectivity (backscatter coefficient) of its antenna by changing the load impedance attached to the antenna. In doing this backscatter modulation, it can synthesize data packets belonging to a wide variety of protocols such as Bluetooth LE, Wi-Fi, ZigBee, and Chirp Spread Spectrum based protocols such as LoRa. The advantage of performing backscatter modulation at the Endpoint is a reduction in power consumption, cost, and size of the Endpoint radio implementation.

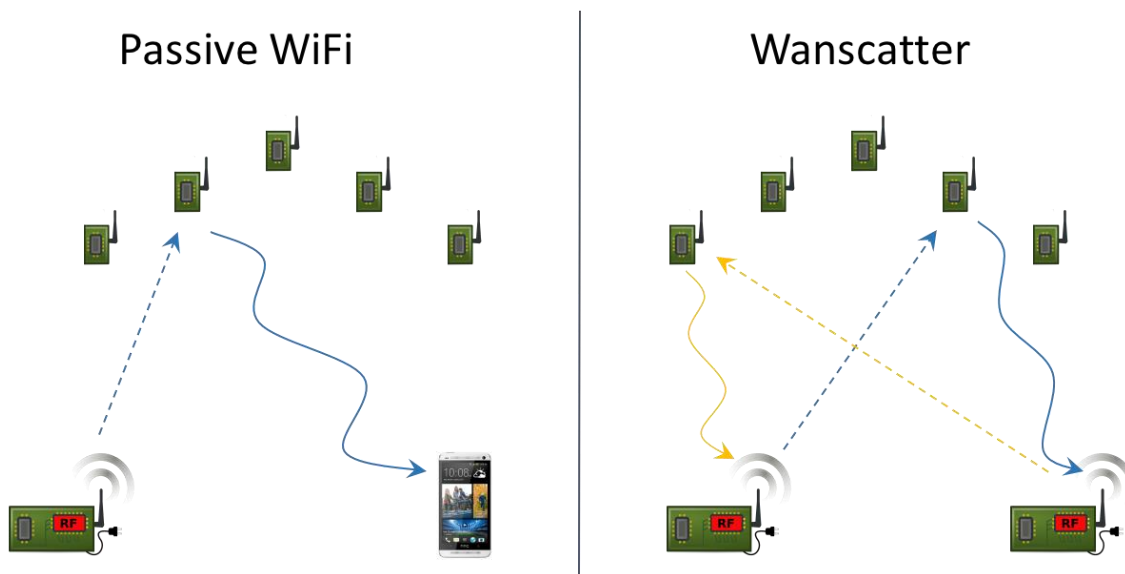

Figure 2-1: Topology for the Two Jeeva Passive Radio Systems Investigated

In this report, these two forms of Passive Radio are characterized and their suitability for multiple applications in wireless avionics are determined. Firstly, in Section 3 experimental test setups for characterization of the Passive Radio systems are described. In Section 4, each application listed in the ITU-R M.2197 operational objectives document is examined and a set of requirements are extracted, and test results are used to support a “pass” or “fail” conclusion for Jeeva’s Passive Radio technology in its suitability for use in each application. Section 5 goes on to provide a brief background in Jeeva’s technology, introducing the unique topology and describing its benefits and complexities. Section 6 concludes the report.

3. Experimental Test Setup

In this section, test setups for characterizing the performance of the system are described, and some analysis of the system is performed.

Figure 3-1 gives an overview of Jeeva's passive radio topology. In this system, a transmit Companion emits a packet which is comprised of a wakeup signal which wakes the Endpoint from a low power state, downlink header and payload intended for the Endpoint, and a **scatter slot**, which is a period of continuous wave during which the Endpoint is expected to backscatter. A receiver, also expected to be a powered and high-capable device, listens for the backscattered reply from the Endpoint during the scatter slot interval. The receiver can then relay messages from the Endpoint to a client.

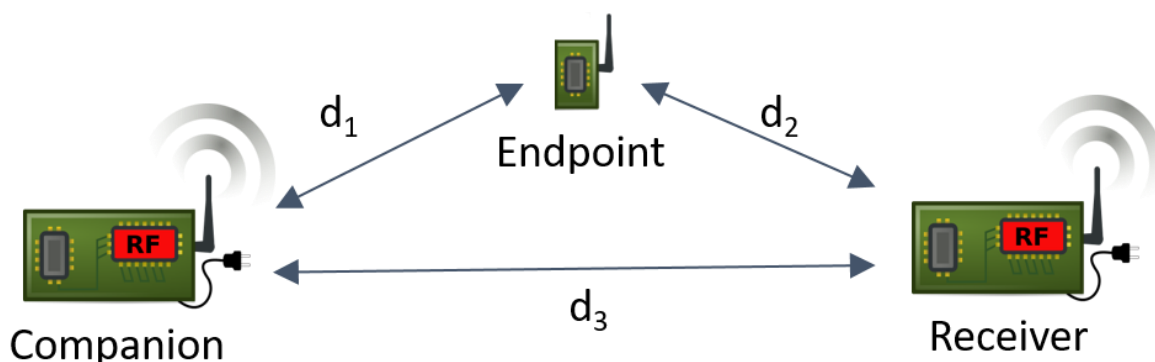

Figure 3-1: General Configuration of Transmit Companion, Tag, and Receiver

The most important parameter in determining range and reliability is receive sensitivity; the minimum signal power at the receiver for which error-free communication can take place. Both downlink (Companion to Endpoint) and uplink (Endpoint to Receiver) sensitivity must be considered. In this section, downlink and uplink receive sensitivity measurements are done for both Chirp Spread Spectrum and Passive Wi-Fi systems, taking into account the derating of uplink sensitivity caused by the unique self-interference which occurs in Jeeva's passive radio topology. Uplink packet error rates are given as a function of received signal strength, a proxy for range. Maximum achievable throughput of the system is determined analytically as a function of the physical rate. Finally, the transmit and receive power requirements of our Endpoint prototypes are reported.

3.1. Downlink Sensitivity Test

A simple cabled test was performed to determine the signal power required at the Jeeva Endpoint device to produce reliable downlink performance. A variable attenuator was inserted between a signal source (Companion) and Endpoint, and the Companion was set to repeatedly transmit downlink packets. A spectrum analyzer was used to verify the power observed at the antenna port of the Jeeva Endpoint. The Endpoint was programmed to decode downlink packets and toggle an I/O line upon correct packet reception.

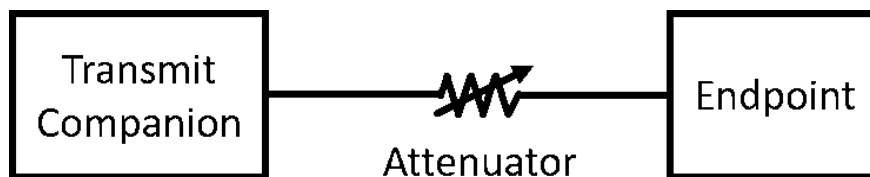

Figure 3-2: Downlink Receiver Sensitivity Test Setup

Figure 3-2 depicts the simple test setup used for downlink testing. An Ettus E310 Embedded USRP was used as the transmit Companion device for all testing, and was running a gnuradio script invoking a custom gnuradio out-of-tree module which implements the Jeeva Companion

transmit-side functionality. First-revision Passive Wi-Fi and long-range Endpoint prototypes were used to receive the downlink data, both of which employ passive detection and correlating receivers. The on-off keyed (OOK) downlink transmission consists of a 32-bit wake code from a selected family of Gold codes, and an information packet which represents bits through 13-bit Barker sequences.

Both Chirp Spread Spectrum and Passive Wi-Fi Endpoints were tested. Reliable detection was defined as a Packet error rate (PER) of less than 10%. The sensitivity in each case for reliable detection was -55 dBm signal power at the Endpoint antenna port. Table 3-1 summarizes the results of the downlink sensitivity test, projecting a link budget and estimated free space operating range.

Table 3-1: Downlink Sensitivity Test Summary

	Communication Protocol	
	Passive Wi-Fi (2450 MHz)	Chirp Spread Spectrum (915 MHz)
Downlink Sensitivity	-55 dBm	-55 dBm
Downlink Link Budget	85 dB	85 dB
Projected Free Space Operating Distance, Assuming 0dBi Antennas (Downlink Only)	172 meters	465 meters

The downlink sensitivity is limited when compared with other radio protocols such as Wi-Fi, Bluetooth, or Zigbee. This is because the downlink receiver on the Endpoint makes use of an ultra-low-power and low-complexity passive detector attached to an optimized digital logic block, rather than relying on a power-consuming active radio receiver involving a mixer and local oscillator. However, because the downlink involves only a single $1/r^2$ path loss, and transmit Companion power is generally kept fairly high (30 dBm when possible) the downlink sensitivity is not generally the limiting factor in range of the system.

3.2. Uplink Sensitivity Test with Self-Interference Derating

In this test, the ability for the receiver to decode the backscattered uplink signal is measured. This is the most important factor in determining practical range of a Jeeva Passive Radio link. We begin with an analysis of the link budget of the system and move on to characterizing the system through a cabled test setup which takes into account the non-idealities of the system.

The backscattered signal power as seen at the receiver can be determined by the expression in Equation 1, where power and gain values are expressed in logarithmic (dB) form:

$$P_{RX} = P_{TX} + G_{TX} + 2G_{EP} + G_{RX} + 40 \log_{10} \left(\frac{\lambda}{4\pi} \right) - 10n \log_{10}(d_1 d_2) + \alpha$$

Equation 1: Backscattered Signal Power as Seen at the Receiver

Where P_{TX} is the transmit power of the transmit companion, λ is the wavelength, d_1 is the distance from transmit Companion to Endpoint, d_2 is the distance from Endpoint to receiver, G_{TX} , G_{EP} , and G_{RX} are the antenna gains of the transmit Companion, Endpoint, and receiver, (n) is the path loss exponent used to model the area of deployment of the wireless system, and α is an efficiency factor which includes both inherent and implementation-dependent losses in the synthesis of backscatter signals.

In the Jeeva Passive Radio topology, a Companion transmits an illumination signal in a band adjacent to the band in which the receiver is operating, and the Endpoint uses subcarrier-modulated backscatter to push this energy into the band of the receiver and thus make it detectable by the receiver. An example of this is shown in the spectrum analyzer plot of Figure 3-3, in which a strong transmit tone is seen at 912 MHz and a weaker backscattered signal is seen at 915 MHz. However, if the transmit Companion and receiver are close together, this high-power adjacent-band transmission from the Companion results in out-of-band interference at the receiver, reducing the achievable sensitivity at the receiver. In performing a link budget analysis, the receive sensitivity (RS) varies with the amount of out-of-band interference present at the receiver.

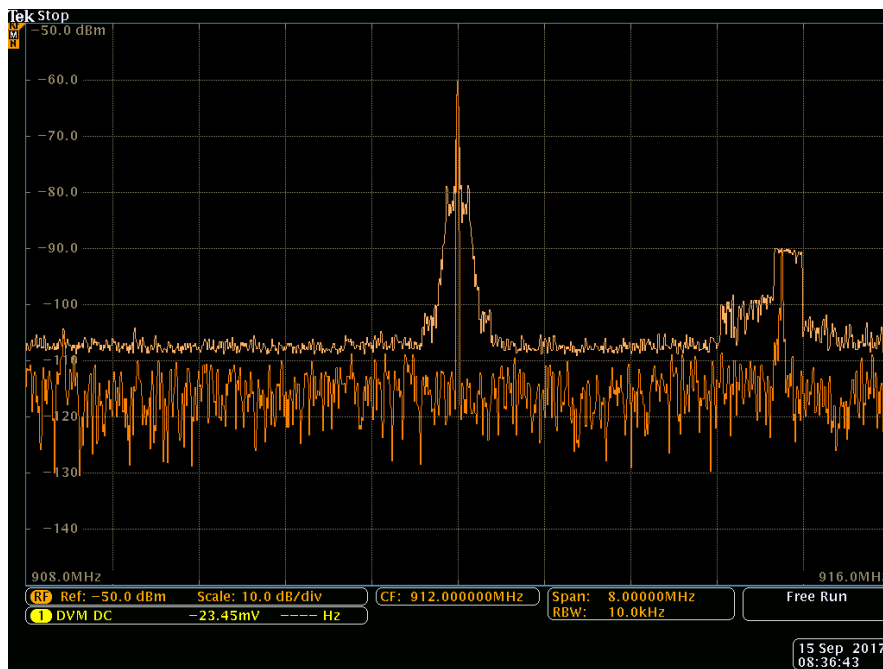

Figure 3-3: Example Frequency Plan for the Passive Radio System

A cabled test was performed which involved determining the receive sensitivity threshold for an uplink receiver in the Jeeva passive radio link as a function of the amount of self-interference present in the system. For the Wanscatter system, in these tests the illumination signal and receiver frequency difference (Δf) was 3 MHz. For the Passive Wi-Fi system, the Δf value was set to 12.375 MHz, an offset which prior tests showed was suitable for reducing self-interference. A block diagram of the test setup for this cabled experiment is shown in Figure 3-4, and a photograph of Jeeva’s cabled setup is in Figure 3-6.

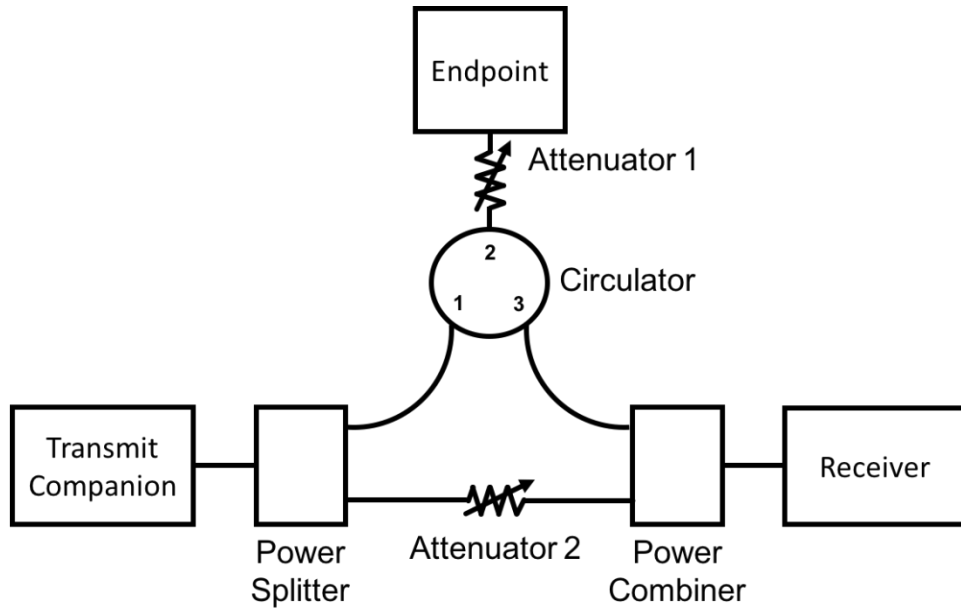

Figure 3-4: Uplink Sensitivity with Self-Interference Derating Test Block Diagram

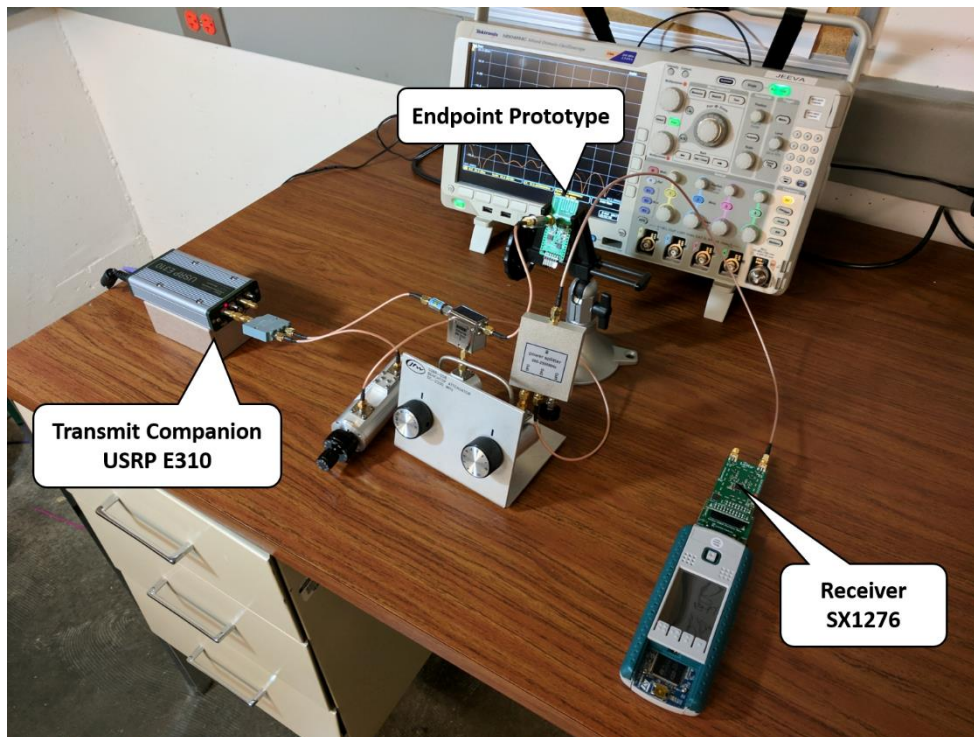

Figure 3-5: Uplink Sensitivity with Self-Interference Derating Test Lab Setup

The results of the self-interference derating tests are shown in Figure 3-6. In our tests, this self-interference sensitivity derating was a significant factor in the performance of both the long-range Wanscatter system and the Passive Wi-Fi system, reducing receiver sensitivity by more than 45 dB for the Wanscatter system at very high interference power levels. However, it is worth noting that these extremely high self-interference power levels would imply a very small compartment or deployment space, and thus in many cases coverage is still adequate.

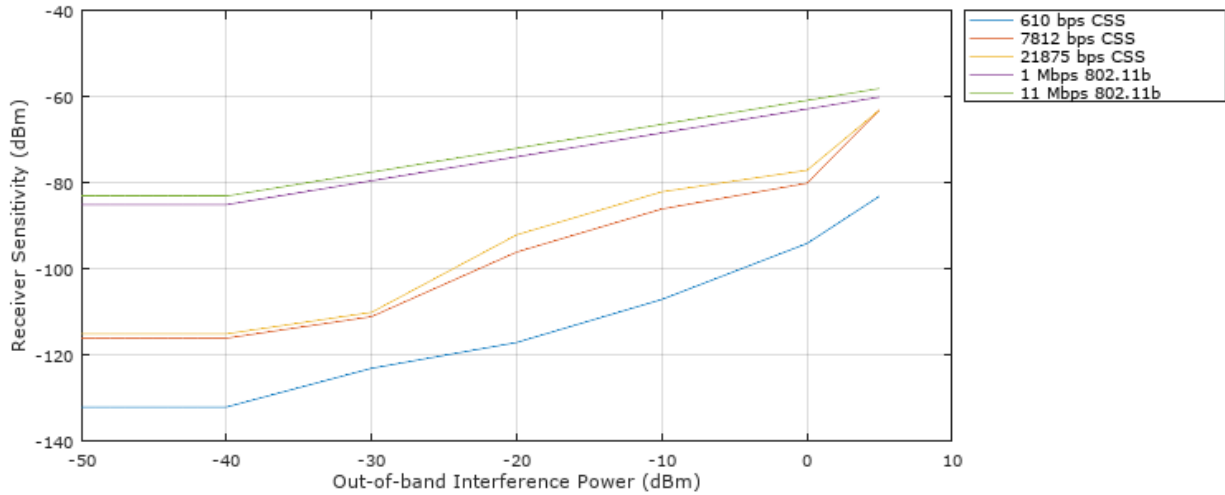

Figure 3-6: Measured Sensitivity as a Function of Self-Interference

Table 3-2 lists the sensitivity of the system for very low values of self-interference power. These sensitivity values were within 2-3 dB of the expected given in the documentation for Wi-Fi and LoRa receivers used.

Table 3-2: Uplink Sensitivity at Very Low Levels of Out-of-Band Self-Interference Power

	Communication Protocol	
	Passive Wi-Fi (2450 MHz)	Chirp Spread Spectrum (915 MHz)
Uplink Sensitivity	1 Mbps: -85 dBm 11 Mbps: -83 dBm	610 bps: -132 dBm 7812 bps: -116 dBm 21875 bps: -115 dBm

3.2.1. Mitigating Self-Interference Effects

Because of the large impact self-interference can have on receiver sensitivity, measures must be taken to mitigate the resulting sensitivity reduction. A recommended way to avoid this kind of derating is to select the most distant possible placement of the transmit Companion and receiver which still maintains acceptable link margin throughout the desired coverage area. However, our tests shows that self-interference levels of less than roughly -40 dBm produce insignificant impact on sensitivity, and thus the transmit Companion and receiver need not be moved farther away from each other once this threshold is reached.

In addition to increasing transmit Companion to receiver distance, two other measures could be taken which could potentially be automated by the Jeeva system in future revisions. In one measure, transmit Companion power could be reduced in an attempt to not overload the receiver if in very close quarters. In some cases this could mitigate some effects of self-interference, though it would also reduce the backscattered signal strength and thus may have near-zero net impact in many instances. In another measure, higher subcarrier modulation frequencies could be selected by the Endpoint, allowing for the illumination signal to be spaced

further in frequency from the receiver's band and thus taking better advantage of the receiver's frequency selectivity and reducing the effects of self-interference. This would have the side effect of a moderate increase in power requirements at the Endpoint.

As can be seen in the link margin plots included in the appendices at the end of this report (and described in Section 4), in many deployments (particularly in small spaces) the self-interference sensitivity derating will not result in a failure of coverage and thus this effect does not necessarily need to be addressed.

3.3. Throughput Projections

To determine the achievable application throughput for a data link, the impact of both packet overhead and network overhead must be taken into account. In Table 3-3 we give the maximum application throughput attainable, given that no retries are required. This level of performance can be expected in single-node networks in which the link margin and signal-to-interference ratio (SIR) is sufficient to provide error-free transmission. This analysis is based on considering the total length in time of packets in each protocol, and the amount of payload data which can be transmitted per packet.

Table 3-3: Maximum Throughput for Application Data Transfer Given Ideal Network Conditions

	Communication Protocol				
	Passive Wi-Fi (2450 MHz) ¹		Chirp Spread Spectrum (915 MHz) ²		
Physical Rate	1 Mbps	11 Mbps	610 bps	7,812 bps	21,875 bps
Maximum Payload Length	256 bytes	256 bytes	17 bytes ³	255 bytes	255 bytes
Max Payload Throughput	650,571 bps	2,596,588 bps	360 bps	7,445 bps	20,577 bps

In this analysis, the maximal payload length is selected to provide the best case maximal throughput. This does not account for the impact of packet length on packet error rate (PER). In a suboptimal RF environment in which either link margin or SIR is insufficient to guarantee no retries, packet error rate would increase with packet length, and thus optimizing throughput may result in reducing packet length below the maximal allowable length.

¹ Throughput projections for Passive Wi-Fi are based on a single 802.11 client with zero retries, no encryption, no request to send (RTS) or clear to send (CTS), and no data fragmentation.

² Throughput projections for Chirp Spread Spectrum assume the LoRa packet format and are based on results provided by the "LoRa calculator" tool from Semtech.com [2]

³ Messages longer than 17 bytes at 610 bps would result in a packet which exceeds the 400 ms maximal length dictated by the FCC for narrowband transmissions on a single channel.

3.4. Real-World Range Testing

Several tests were performed to obtain real-world corroboration of cabled test results. In these tests, range of the system was measured in a near-free-space scenario to try and determine a fit between predicted and measured performance.

Jeeva characterized and performed range measurements for the Wanscatter system in a 55 meter long by three meter wide hallway. First, a model was constructed and used to determine the expected link margin throughout the hallway. Finally the model was compared to real measured packet loss rates throughout the hallway to confirm that coverage was achieved throughout the entire hallway as predicted by the model.

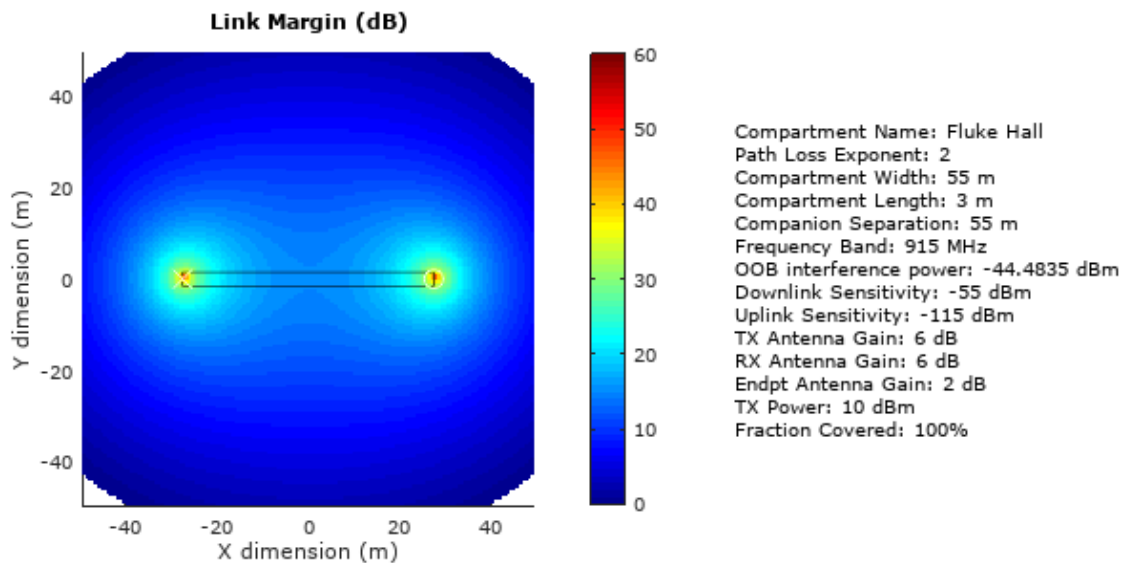

Figure 3-7: Results of Modeling the Hallway Test

The path loss exponent (PLE) of the hallway was experimentally determined to be very close to 2.0, and so a PLE of 2.0 was used in modeling of the hallway. Figure 3-7 illustrates the results of modeling the hallway using the characterized sensitivity of the downlink and uplink, as well as the known PLE of the space and gain parameters of transmitter, receiver, and Endpoint antennas. The transmit power of the Companion was reduced by a factor of 100 (-20 dB) in order to artificially limit the range of the system, as a 30 dBm transmit Companion would show no change in performance throughout this small space with the low determined PLE.

Actual measurements were then performed throughout the hallway, with the receiver situated at one end of the hallway, the transmitter placed at the opposite end, and the Endpoint position varied between the two. Figure 3-8 depicts the test setup. Note that the hallway is mostly lined with concrete, and the ceiling and one wall mainly consists of exposed metal surfaces and tubing.



Figure 3-8: Hallway Test

PER is given as a function of endpoint position for three Wanscatter data rates in Figure 3-9. These tests show some performance variation throughout the hallway, as predicted by the model due given the relatively low link margin (<10dB) when the Endpoint is placed in the center of the hallway at the midpoint of the transmit Companion and receiver. However, though some variation was observed in PER, it is apparent that good coverage was obtained over this 55 meter hallway even with the severely limited transmit Companion output power of 10 dBm. Figure 3-10 shows the PER as a function of link margin, aggregated across all data rates. It can

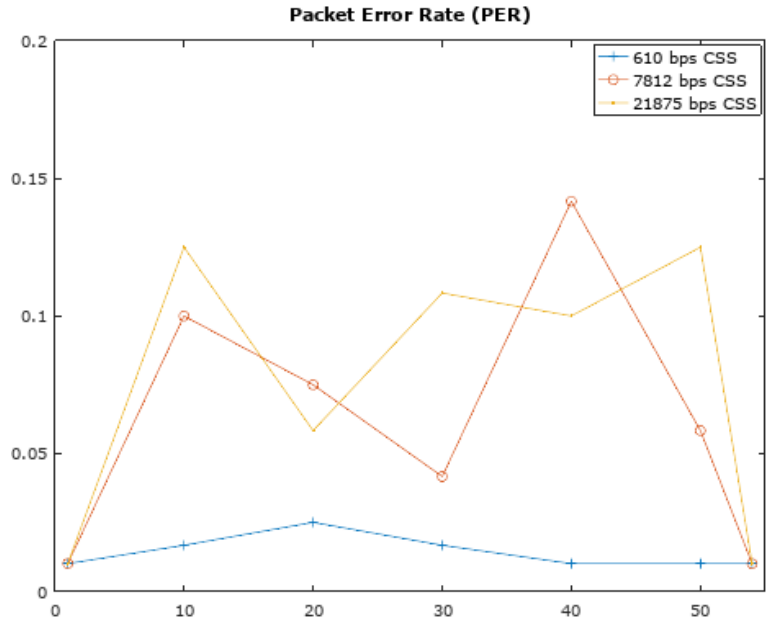

Figure 3-9: PER as a Function of Endpoint Position (Wanscatter)

be seen from this plot that the packet error rate is a soft function of link margin in the Wanscatter system and that the value of sensitivity was chosen to produce a PER of approximately 10%

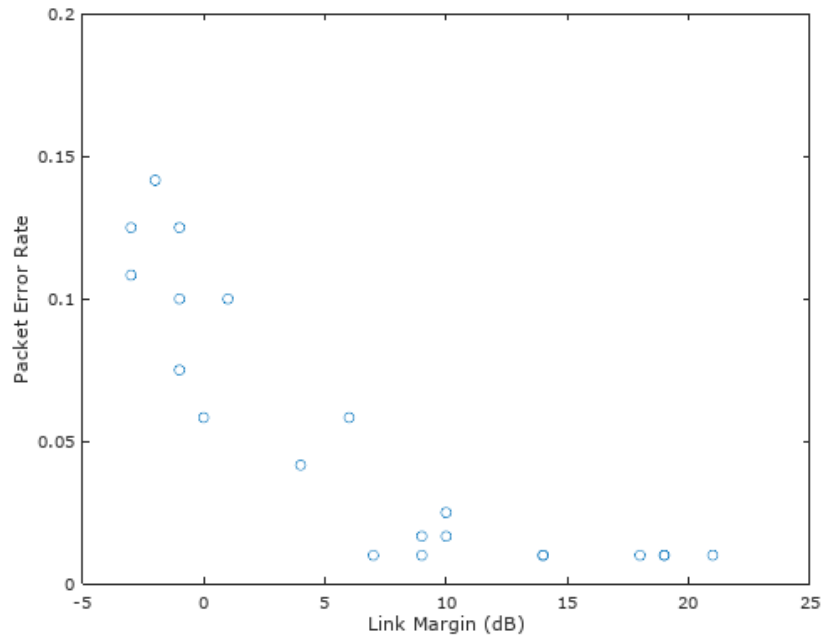

Figure 3-10: PER as a Function of Link Margin

Characterization of Passive Wi-Fi link was done slightly differently, with the transmit Companion and Endpoint placed at a fixed distance of 2 meters apart and the receiver's distance from the Endpoint varied. This method of characterization was chosen due to the far lower sensitivity of the Passive Wi-Fi system; Passive Wi-Fi will be best suited for applications in which the Endpoint can be kept near the transmit Companion. The results of this test are shown in Figure 3-11.

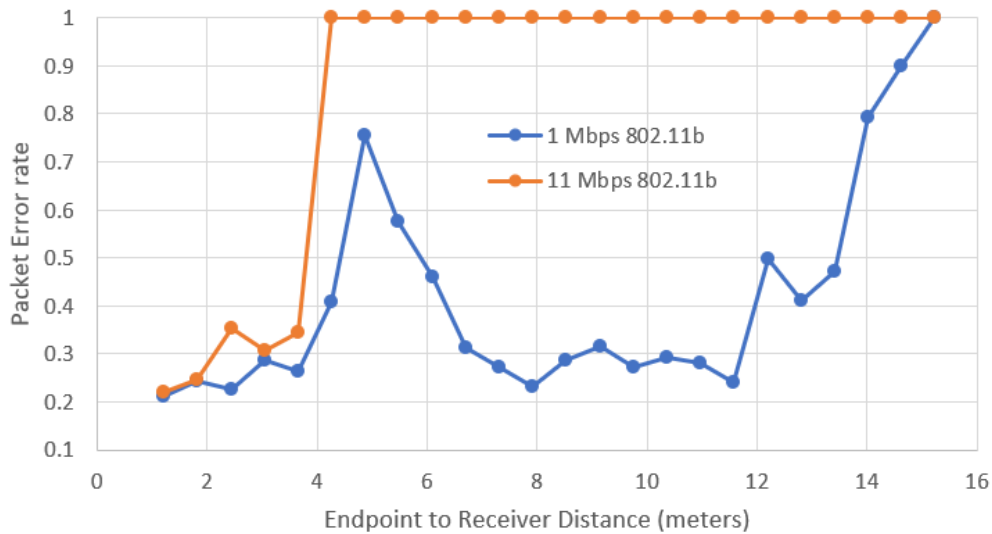

Figure 3-11: PER as a Function of Receiver Position (Passive Wi-Fi)

4. Suitability of Passive Radio for Wireless Avionics

The use cases identified in the ITU-R M.2197 operational objectives document fall into four categories, with a total of 38 use cases across all four categories. The categories (LI/LO/HI/HO) represent whether the system will be used inside compartments of a vehicle (I) or outside the vehicle (O), and whether the data rates are high (H) or low (L).

In this section we identify requirements specifications for each of the application use cases described in the ITU-R M.2197 operational objectives document, describe our modeling parameters and assumptions which comprise the model, compute link margins given data from experimental results and link budgeting analysis, and summarize results by making a pass/fail determination for each application.

4.1. Modeling

4.1.1. Modeling Parameters

In order to make a determination of the suitability and expected performance of Jeeva's passive radio links in each application, the following parameters from both the ITU-R M.2197 operational objectives document and test results presented in Section 3 of this report were included in our models:

1. Application-specific parameters from ITU-R M.2197 operational objectives document
 - a. **Physical data rates** required for each application. This determines which protocols are suitable for use in this application.
 - b. **Dimensions** of the compartment/area

- c. **Path Loss Exponent** given in the ITU-R M.2197 operational objectives document for each compartment/area
2. Parameters from Jeeva test results and system analysis
 - a. **Receiver Sensitivity**, which is a function of the level of out-of-band interference and also of the protocol and data rate used.
 - b. **Wavelength**, simply the wavelength of the protocol used (either 915 MHz or 2.45GHz).
 - c. **Antenna gain**, assumed to be a conservative 0 dBi for the Endpoint, and 2 dBi for the transmit Companion and receiver antennas.
 - d. **Backscatter efficiency**, which in Jeeva's testing has been determined to be roughly -5dB across all protocols and frequencies.
 - e. **Companion transmit power**, which is assumed to be the FCC-allowable 30dBm in all test cases. Note that in small spaces, reducing transmit power does not impact range as the system is self-interference limited.

4.1.2. Assumptions and Simplifications

For this analysis, we make the following assumptions and simplifications:

1. **Placement of Endpoints:** Endpoint devices (sensors) could be located anywhere in the compartment or area described.
2. **Placement of Companions:** A pair of Companion devices are placed at midpoints of the shortest two opposing edges of compartments or areas described. This has the benefit of low self-interference between the two Companion devices, but also gives high illumination signal power throughout the compartment. In some geometries this is a near-optimal placement, but for the purposes of the results presented here this should simply be considered as a first approximation of a good deployment geometry.
3. **Dimensional Simplification:** Our model assumes that the height of the compartment or area is generally insignificant compared with the width and length, thus enabling far simpler 2-dimensional modeling. The largest two dimensions are always used to describe a 2-D rectangle over which the link margin modeling occurs. While this may not be entirely accurate for small compartments, the majority of compartments can be well-modeled in this way, and small compartments generally are not limited in link margin.

4.1.3. Protocol Options

Five protocol options will be considered for each application, and in each case the option which has a PHY rate which exceeds but is nearest to the minimum for the application will be selected, as that option will produce the best range while meeting data rate requirements. Note that this strategy for protocol selection may result in unnecessarily high link margin for some applications in smaller compartments/areas, and thus higher rate protocols could be used for those in order to decrease channel occupancy.

The five protocol options considered for use are:

1. **1 Mbps 802.11b (Wi-Fi)**
 - BPSK Modulation,
 - Frequency = 2450MHz
 - Delta-F = 12.375MHz

2. 11 Mbps 802.11b (Wi-Fi)

- QPSK Modulation
- Frequency = 2450MHz
- Delta-F = 12.375MHz

3. 610 bps Chirp Spread Spectrum (LoRa)

- Spreading Factor = 10
- BW = 125kHz
- Coding Rate = 4/8
- Frequency = 915MHz
- Delta-F = 3MHz

4. 7812 bps Chirp Spread Spectrum (LoRa)

- Spreading Factor = 8
- BW = 500kHz
- Coding Rate = 4/8
- Frequency = 915MHz
- Delta-F = 3MHz

5. 28175 bps Chirp Spread Spectrum (LoRa)

- Spreading Factor = 7
- BW = 500kHz
- Coding Rate = 4/5
- Frequency = 915MHz
- Delta-F = 3MHz

4.1.4. Link Margin Analysis

The goal of these tests is to compute the link margin, which is the difference between actual received power and the receive sensitivity, and as a rule of thumb should be kept above 10 dB for reliable performance of any radio link. The link margin (LM) can be computed as shown in Equation 2 and Equation 3.

$$LM = P_{RX} - RS$$

Equation 2: Simplified Link Margin Equation

$$LM = G_{TX} + 2G_{EP} + G_{RX} + 40 \log_{10} \left(\frac{\lambda}{4\pi} \right) - 10n \log_{10}(d_1 d_2) + \alpha - RS$$

Equation 3: Expanded Link Margin Equation

Where RS is the sensitivity of the receiver and is computed from a lookup table of empirically determined values, P_{TX} is the transmit power of the transmit companion, λ is the wavelength, d_1 is the distance from transmit Companion to Endpoint, d_2 is the distance from Endpoint to receiver, G_{TX} , G_{EP} , and G_{RX} are the antenna gains of the transmit Companion, Endpoint, and receiver, (PLE) is the path loss exponent used to model the area of deployment of the wireless system, and α is an efficiency factor which includes both inherent and implementation-dependent losses in the synthesis of backscatter signals.

4.2. Results

In this section, full applications lists from the ITU-R M.2197 operational objectives document are reproduced along with pass/fail determinations. The appendices at the end of this report contains a full listing of figures depicting link margin across compartments and areas listed in the ITU-R M.2197 operational objectives document, which is referenced in the application analysis below. Table 4-1, Table 4-2, Table 4-3, and Table 4-4 describe each application and the Jeeva system’s suitability for that application given the test setup and parameters described above, with references to figures in the appendices at the end of this report which address the particular compartments considered for each application.

Overall, 68.4% of use cases described by the ITU-R M.2197 operational objectives document were found to be addressable by Jeeva’s Passive Radio systems given the deployed geometry described in this section (26 addressable of 38 total), with 26 of those best addressable by Wanscatter (passive Chirp Spread Spectrum) and three best addressable with passive Wi-Fi. The most suitable types of applications were in the LI and LO categories, where lower rates were acceptable. To better understand these results after reviewing Table 4-1, Table 4-2, Table 4-3, and Table 4-4 below, we refer to the appendices at the end of this document, for a full listing of areas and compartments outlined in the ITU-R M.2197 operational objectives document alongside their link margin models for various protocols

Table 4-1: Analysis of ITU-R M.2197 HO Class Member Applications

Application	Net Peak Data Rate Per Data-Link/ (kbit/s)	Suitable Protocol	Link Rate Pass/Fail	Example Coverage Analysis Ref #	Full Area Coverage Pass/Fail
Avionics Communications Bus	100	1 Mbps 802.11b	Pass	2R,2W	Fail
Audio Communications System	20	21875 bps CSS	Pass	1R,1W	Pass
Structural Sensors	45	1 Mbps 802.11b	Pass	2R,2W	Fail
External Imaging Sensors (Cameras, etc.)	1000	1 Mbps 802.11b	Pass	2R,2W,2V	Fail
Active Vibration Control	50	1 Mbps 802.11b	Pass	2R,2W,2V	Fail

Table 4-2: Analysis of ITU-R M.2197 HI Class Member Applications

Application	Net Peak Data Rate Per Data-Link/ (kbit/s)	Suitable Protocol	Link Rate Pass/Fail	Example Coverage Analysis Ref #	Full Area Coverage Pass/Fail
Air Data Sensors	100	1 Mbps 802.11b	Pass	2R	Fail
FADEC Aircraft Interface	12.5	21875 bps CSS	Pass	1W	Pass
Engine Prognostic Sensors	4800 peak 80 average per sensor	11 Mbps 802.11b	Pass	2K	Pass
Flight Deck & Cabin Crew Voice	64 raw 16 CVSD 2.4 MELP	11 Mbps 802.11b	Pass	2H	Fail
Flight Deck Crew Fixed Imagery	2 000 File sizes to > 1 Mbyte 2.5 s update each	11 Mbps 802.11b	Pass	2H	Fail
Cabin Crew Fixed Imagery	1 000 File sizes to > 1 Mbyte 5 s update each	1 Mbps 802.11b	Pass	2E	Fail
Flight Deck Crew Motion Video	64 or 256	1 Mbps 802.11b	Pass	2H	Fail
Cabin Crew Motion Video	64 or 256	1 Mbps 802.11b	Pass	2H	Fail
Flight Deck Crew Digital Data (EFO...)	< 1 000 (1 250 kb, > 10 s transfer time)	1 Mbps 802.11b	Pass	2H	Fail
Cabin Crew Digital Data	< 100 (125 kb, > 10 s transfer time)	1 Mbps 802.11b	Pass	2E	Fail

Table 4-3: Analysis of ITU-R M.2197 LO Class Member Applications

Application	Net Peak Data Rate Per Data-Link/ (kbit/s)	Suitable Protocol	Link Rate Pass/Fail	Example Coverage Analysis Ref #	Full Area Coverage Pass/Fail
Ice Detection	0.5	610 bps CSS	Pass	1R	Pass
Landing Gear (Proximity) Sensors	0.2	610 bps CSS	Pass	1S,1U	Pass
Landing Gear Sensors, Tire Pressure, Tire & Brake Temperature & Hard Landing Detection	1	7812 bps CSS	Pass	1S,1U	Pass
Landing Gear Sensors, Wheel Speed for Anti-Skid Control & Position Feedback for Steering	5.5	7812 bps CSS	Pass	1S,1U	Pass
Flight Control System Sensors, Position Feedback & Control Parameters	8	21875 bps CSS	Pass	1R	Pass
Additional Proximity Sensors, Aircraft Doors	0.2	610 bps CSS	Pass	1Q	Pass
Engine Sensors	0.8	7812 bps CSS	Pass	1T	Pass
Cargo Compartment Data	0.5	610 bps CSS	Pass	1A,1I	Pass
Structural Sensors	0.5	610 bps CSS	Pass	1R,1V,1W	Pass
Temperature/Humidity & Corrosion Detection	1	7812 bps CSS	Pass	1R,1V,1W	Pass

Table 4-4: Analysis of ITU-R M.2197 LI Class Member Applications

Application	Net Peak Data Rate Per Data-Link (kbit/s)	Suitable Protocol	Link Rate Pass/Fail	Example Coverage Analysis Ref #	Full Area Coverage Pass/Fail
Cabin Pressure	0.8	7812 bps CSS	Pass	1E	Pass
Engine Sensors	0.8	7812 bps CSS	Pass	1K	Pass
Smoke Sensors (Unoccupied Areas)	0.1	610 bps CSS	Pass	1A, 1I	Pass
Smoke Sensors (Occupied Areas)	0.1	610 bps CSS	Pass	1H, 1E	Pass
Fuel Tank/Line Sensors	0.2	610 bps CSS	Pass	1P	Pass
Proximity Sensors, Passenger & Cargo Doors, Panels	0.2	610 bps CSS	Pass	1Q	Pass
Sensors for Valves & Other Mechanical Moving Parts	0.2	610 bps CSS	Pass	1K	Pass
ECS Sensors	0.5	610 bps CSS	Pass	1E	Pass
EMI Detection Sensors	1	7812 bps CSS	Pass	1C	Pass
Emergency Lighting Control	0.5	610 bps CSS	Pass	1H,1E	Pass
General Lighting Control	0.5	610 bps CSS	Pass	1H,1E	Pass
Cabin Removables Inventory	0.1	610 bps CSS	Pass	1E	Pass
Cabin Control	0.5	610 bps CSS	Pass	1E	Pass

5. Background on Jeeva Wireless Technology

Wireless connectivity has been a key obstacle in achieving the vision of Internet of Things (IoT). Active radios including Wi-Fi, Bluetooth, ZigBee, SigFox and LoRa are extremely power hungry, significantly affecting battery life of connected devices, and cost at least 4–6 dollars, making them too expensive for embedding into objects at large scale. As a result, radio solutions require constant frequent battery recharging / replacement / maintenance. This combination of factors limits device lifetime and increases the cost of the solution, making truly ubiquitous connectivity infeasible.

Jeeva has identified this pain point and addressed it with a novel passive radio technology based on backscatter communication. The key insight behind our technology is that the generation of the RF carrier in active radios is prohibitively expensive. Instead of generating a carrier, Jeeva's passive radios use reflections (backscatter) to communicate at 1000-10,000x lower power than conventional radios. Additionally, passive radio also eliminates the need for bulky RF analog front end and expensive external components such as crystals, capacitors and inductors, thereby enabling wireless connectivity at fraction of the cost, size, and power consumption of traditional active radios.

Jeeva's technology effort began by developing standard compliant Wi-Fi, Bluetooth and ZigBee passive radio solutions. Specifically, Jeeva's technology leveraged the economy of scales of existing wireless standards and directly communicates with off-shelf devices including cell phones, Wi-Fi routers, home or industrial automation hubs/gateways, tablets and laptops with no software or hardware modification to these existing devices. We developed the following systems:

- Passive Wi-Fi, ZigBee, and Bluetooth systems for home and industrial sensing applications, where devices like temperature sensors and entry detection sensors can directly communicate with unmodified smart home hubs and Wi-Fi routers.
- A long range system which leverages the Chirp Spread Spectrum (CSS) modulation scheme to achieve communication at hundreds of meters, the longest ranges ever demonstrated with backscatter devices.

The rest of this section provides some background information on each of Jeeva's Passive Radio offerings, to help give context for this report describing Passive Radio's applicability to wireless avionics applications.

5.1. Passive Wi-Fi, ZigBee, and BLE

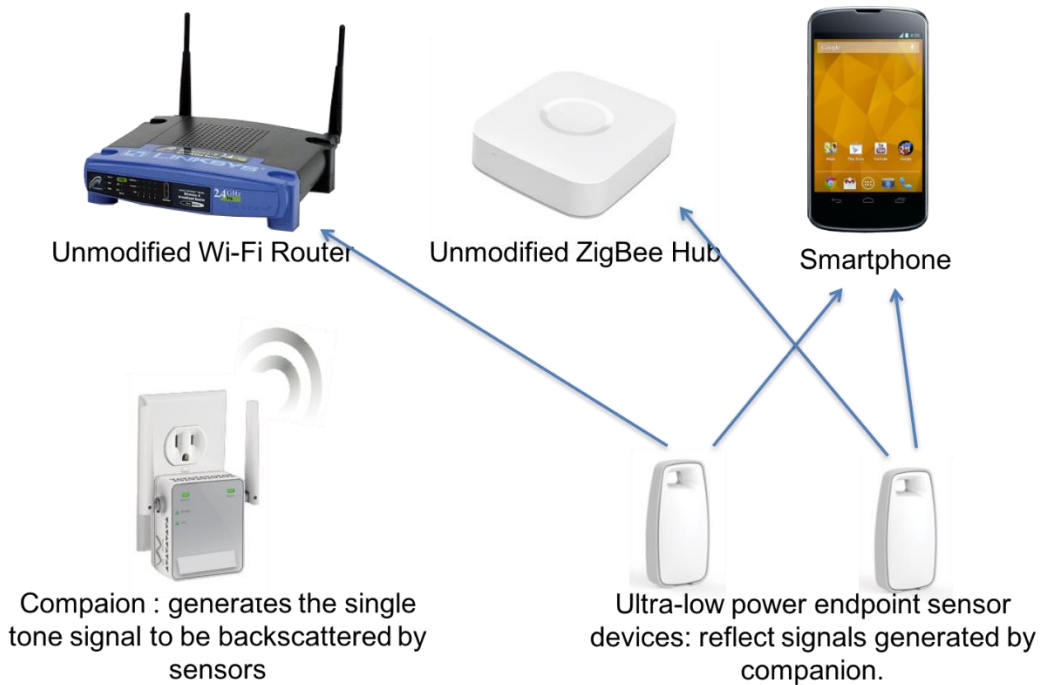

Figure 5-1: Overview of the Passive Wi-Fi/ZigBee/BLE System

An illumination device (Companion) comprised of a Wi-Fi transmitter periodically emits a special single tone signal. The wireless signal impinges on the antenna of the nearby Jeeva Endpoint device, which detects it and uses a proprietary reflection/backscatter technique to convert the energy from that single tone signal into a standards-compliant Wi-Fi/ZigBee packet which can then be received by any nearby Wi-Fi/ZigBee device. Compared to a conventional radio solution, this approach provides enormous power savings, potentially allowing battery-free operation. Signals sent by a Passive Wi-Fi transmitter are interoperable with commodity Wi-Fi transceivers such as those available on nearly all modern smartphones, and thus the backscatter transmitter can send messages to an unmodified off-the-shelf phone.

5.1.1. Implementation and System Design

We implement the Passive Wi-Fi and Passive ZigBee system for home and industrial sensing applications. Since, the implementations for the two protocols are very similar, in the report we will only describe the Wi-Fi implementation. Since Wi-Fi and ZigBee operate in the same 2.4 GHz ISM band, the ZigBee system is also implemented using the same hardware components and requires only firmware modification to switch from Wi-Fi to ZigBee protocol.

The Passive Wi-Fi endpoint devices were implemented on printed circuit boards using commercial off the shelf components (COTS). The endpoint device uses an FPGA for digital baseband Wi-Fi protocol and phase shift keying baseband modulation. The digital output of the FPGA is fed to a backscatter switch network, which controls the impedance of the antenna to synthesize Wi-Fi data packets from the incident RF carrier. We integrated a variety of sensors with the Passive Wi-Fi system to demonstrate home sensing use cases. As shown in Figure 5-2, we designed a window security sensor which uses a reed switch to detect whether a window/door is open or closed and communicates the information to a Wi-Fi access point using the passive Wi-Fi technique. We also developed a Passive Wi-Fi temperature sensor.

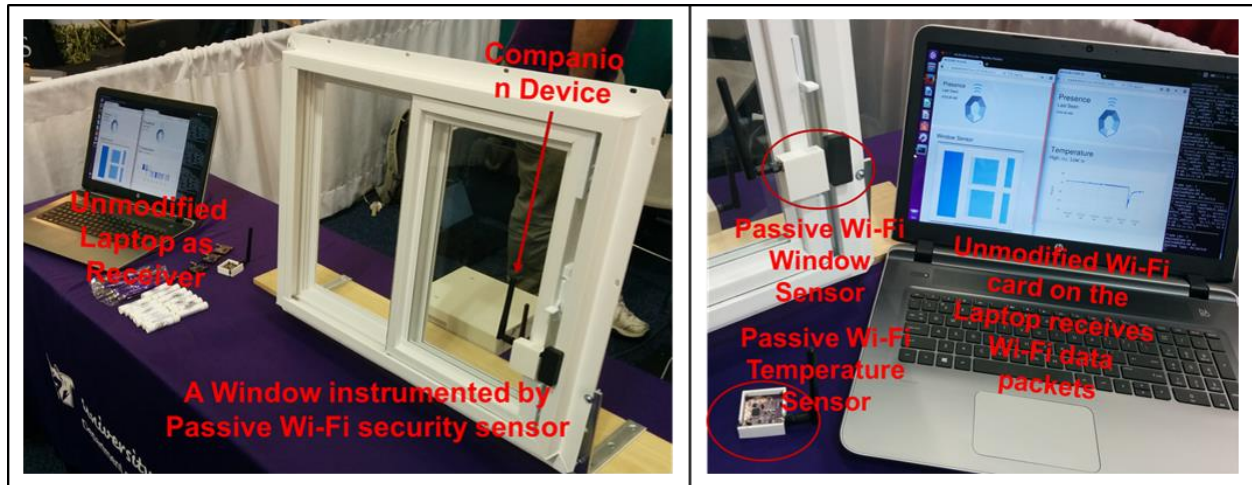

Figure 5-2: Passive Wi-Fi Window Security System

The companion device for Passive Wi-Fi was implemented using a USRP E310, a software defined radio platform by Ettus research. The software defined radio platform gives us the flexibility to quickly prototype and iterate different configurations for the companion device. The USRP-based Passive Wi-Fi companion device implements carrier sense and coordinates communication between different passive Wi-Fi devices using downlink OOK communication. We use the Wi-Fi network card of a standard laptop as the Wi-Fi receiver, and have verified interoperability of the Passive Wi-Fi system across many makes and models of Wi-Fi transceivers with no counterexamples.

5.2. Wanscatter: Chirp Spread Spectrum (CSS) Passive Radio

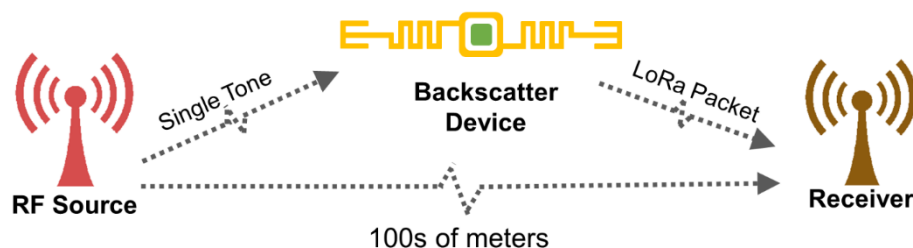

Figure 5-3: Deployment of a Long Range Passive Radio System

The Passive Wi-Fi/ZigBee/Bluetooth and all existing backscatter systems are limited to short operating ranges. To appreciate why a long range passive radio (backscatter) based system is hard, consider the deployment in Figure 5-3. Here the endpoint reflects signals from an RF source companion to synthesize data packets that are then decoded by a receive companion. The challenge is that, before arriving at the endpoint, the signals from the RF source are already

attenuated. The endpoint can reflect these weak signals to synthesize data packets which get further attenuated as they propagate to the receiver. With a separation of 400 m between the two companions, the backscattered signal is at -134 dBm. In contrast, the direct signal from the source to receive companion is more than a million times stronger at -45 dBm. Thus, the backscatter signal is not only drowned by noise but also suffers significant interference from the RF source.

We develop the long range passive radio communication system to satisfy two key constraints. First, the endpoint encodes information in a way that can be decoded at the receiver down to and below -135 dBm signal strength and reliably operate in the presence of strong out-of-band interference. Second, instead of using a custom receiver that can be prohibitively expensive (e.g., RFID readers), the backscattered signals should be decoded on readily and cheaply available commodity hardware that would expedite the adoption and development of our design. To do so, we first profile existing radio technologies and picked out the LoRa protocol which provides the highest sensitivity of -149 dBm and supports bit rates of 18 bps to 37.5 kbps, which are sufficient for most IoT applications. Further, LoRa is resilient to both in-band and out-of-band interference. Specifically, the Sx1276 receiver hardware from SEMTECH can reliably decode LoRa packets in the presence of 95 dB higher out of band interference.

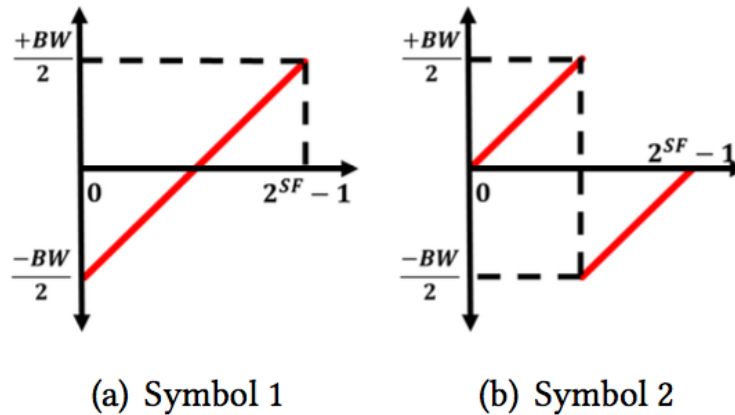

Figure 5-4: Chirp Symbols

We design a chirp spread spectrum (CSS) based LoRa backscatter system. An example of CSS modulation is shown in Figure 5-4, where a '0' bit is represented as a continuous chirp that increases linearly with frequency, while a '1' bit is a chirp that is cyclically shifted in time. In addition, to mitigate the self-interference from the RF source companion, the CSS modulated packets should be created a frequency offset from the RF carrier. We use direct digital synthesis method to continuously change in the frequency of the carrier as a function of time with a frequency offset and fed that signal into a backscatter switch network to create CSS modulated packets at the required frequency offset.

5.2.1. System Design

We implement the long range passive radio system using commercial off the shelf components. The endpoint device is based upon Igloo Nano FPGA which implements the digital section of the design. We developed a Verilog implementation of backscatter synthesis of chirp spread spectrum modulation using a direct digital synthesis (DDS) method. The RF section consists of RF switches by Analog Devices (ADG 902), a matching network, and a PCB PIFA antenna. The designed endpoint prototype is shown in Figure 5-5.

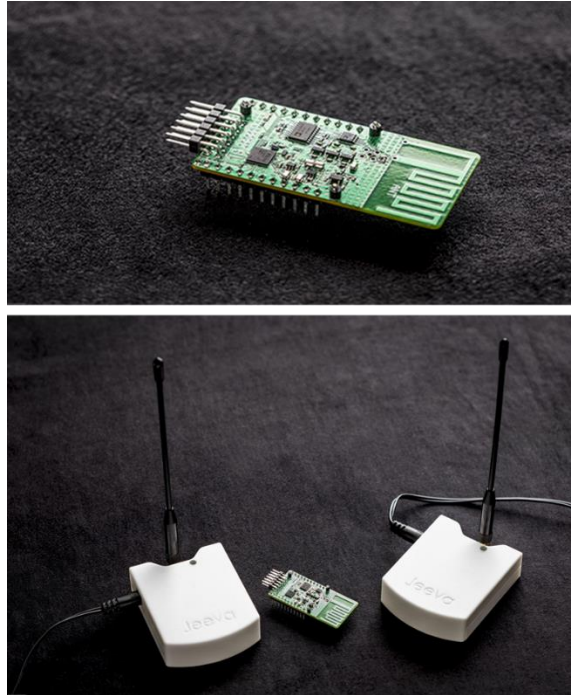

Figure 5-5: COTS Endpoint and Companion Prototype

The companion had a Wi-Fi network interface to communicate with (non-passive radio network) external devices and was designed using the LoRa compliant Sx1276 chipset by SEMTECH. We used the OOK/FSK transmit mode of the LoRa chipset to transmit a single tone signal for the RF source companion device. We amplified the signal tone signal using a power amplifier to output 30 dBm which is the maximum allowable limit imposed by FCC in US. On the receive companion, the Sx1276 chipset was configured to operate in the LoRa receive mode with the appropriate parameters. We used the CC3200 Wi-Fi SoC by Texas instruments in the companion for computation and to provide Wi-Fi connectivity. The SoC configured the LoRa chip to operate in transmit or receive mode and received and forwarded data to devices outside the passive radio network using the Wi-Fi network interface.

6. Summary and Conclusion

This report has described and characterized the Jeeva Passive Radio systems, including Passive Wi-Fi and Wanscatter (passive Chirp Spread Spectrum) with respect to their applicability in wireless avionics.

Overall, 68.4% of use cases described by the ITU-R M.2197 operational objectives document were found to be addressable by Jeeva's Passive Radio systems (26 addressable of 38 total), with 23 of those best addressable by Wanscatter and three found to be best addressable with passive Wi-Fi. The most suitable types of applications were in the LI and LO categories, where lower rates were acceptable and thus Wanscatter could be applied and its much better uplink sensitivity leveraged.

Jeeva has identified the Wanscatter (Chirp Spread Spectrum) system as likely holding the most promise for applications such as those outlined in the ITU-R M.2197 operational objectives document. We recommend that Wanscatter be a technology considered for adoption in wireless avionics.

Appendix A: Coverage Projections for Aircraft Compartments and Outdoor Areas

Coverage projections display the link margin for Endpoint placements - Each color point in the surface represents a possible Endpoint placement and the resulting link margin. Companions are placed at opposing corners of the compartment. All compartments and areas are modeled as rectangular regions for simplicity, capturing the largest two dimensions of the compartment or area.

The results table in Appendix B shows link margin for the Wanscatter (Chirp Spread Spectrum) system. Because the highest Wanscatter data rate achievable by Jeeva's system (21875 bps PHY rate) showed good coverage in every scenario except the cabin compartment (which all rates failed to adequately cover), only the results for the 21875 bps PHY rate are reprinted here.

The table in Appendix C shows link margin for the Passive Wi-Fi system. Because 1 Mbps Wi-Fi was not identified as being the best suited protocol option for any particular use case, only plots for 11 Mbps Passive Wi-Fi are reprinted here.

Appendix B: Wanscatter (Chirp Spread Spectrum) Projected Coverage

Protocol Details

Chirp Spread Spectrum (LoRa)

Frequency = 915 MHz

Spreading Factor = 7

Bandwidth = 500 kHz

Coding Rate = 4/5

21875 bps PHY rate

Because the highest Wanscatter data rate achievable by Jeeva's system (21875 bps PHY rate) showed good coverage in every, only the results for the 21875 bps PHY rate are reprinted here.

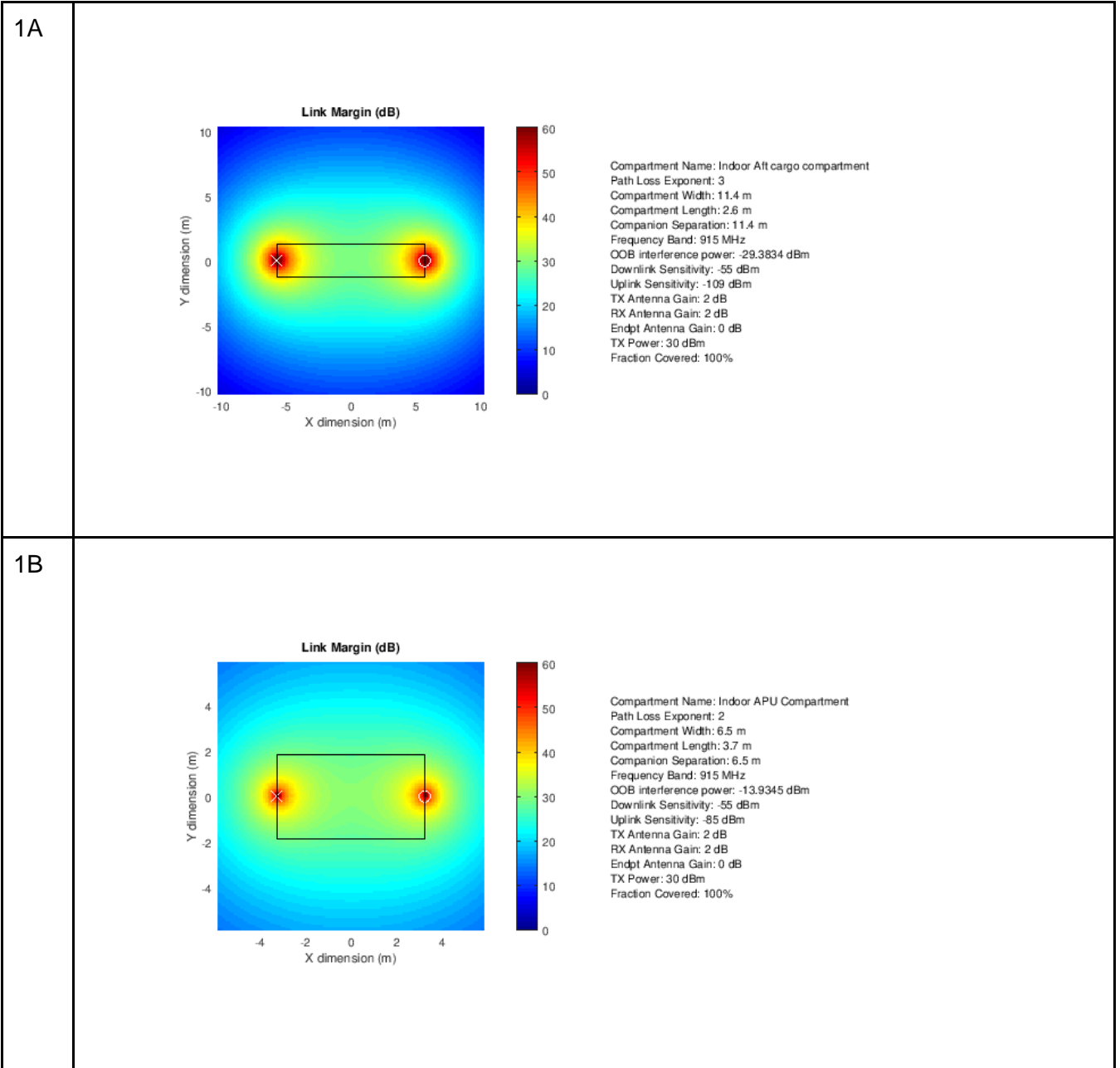

1C

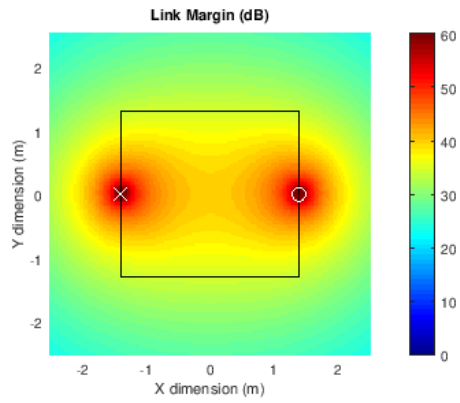

Compartment Name: Indoor Avionics Compartment
Path Loss Exponent: 2
Compartment Width: 2.8 m
Compartment Length: 2.8 m
Companion Separation: 2.8 m
Frequency Band: 915 MHz
OOB interference power: -6.6194 dBm
Downlink Sensitivity: -55 dBm
Uplink Sensitivity: -80 dBm
TX Antenna Gain: 2 dB
RX Antenna Gain: 2 dB
Endpt Antenna Gain: 0 dB
TX Power: 30 dBm
Fraction Covered: 100%

1D

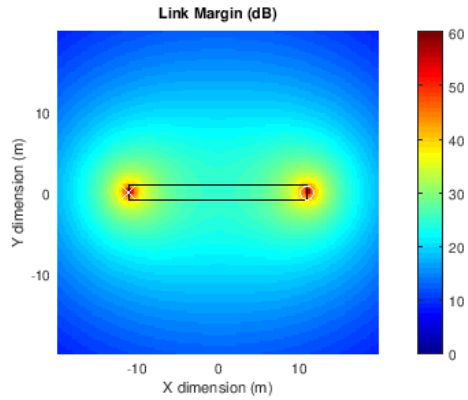

Compartment Name: Indoor Bilge
Path Loss Exponent: 2
Compartment Width: 22 m
Compartment Length: 1.8 m
Companion Separation: 22 m
Frequency Band: 915 MHz
OOB interference power: -24.5247 dBm
Downlink Sensitivity: -55 dBm
Uplink Sensitivity: -101 dBm
TX Antenna Gain: 2 dB
RX Antenna Gain: 2 dB
Endpt Antenna Gain: 0 dB
TX Power: 30 dBm
Fraction Covered: 100%

1E

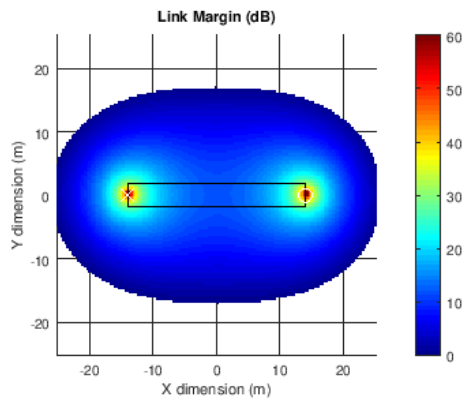

Compartment Name: Indoor Cabin compartment
Path Loss Exponent: 3
Compartment Width: 28 m
Compartment Length: 3.7 m
Companion Separation: 28 m
Frequency Band: 915 MHz
OOB interference power: -41.0909 dBm
Downlink Sensitivity: -55 dBm
Uplink Sensitivity: -115 dBm
TX Antenna Gain: 2 dB
RX Antenna Gain: 2 dB
Endpt Antenna Gain: 0 dB
TX Power: 30 dBm
Fraction Covered: 100%

1F

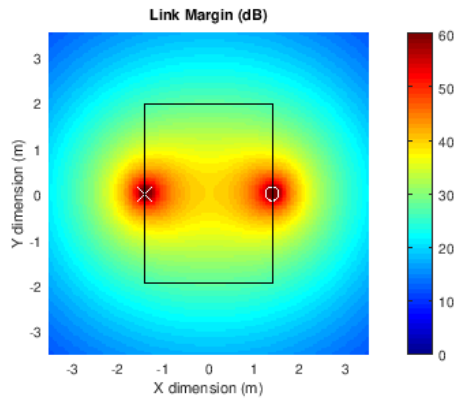

Compartment Name: Indoor Centre tank
Path Loss Exponent: 2.5
Compartment Width: 2.8 m
Compartment Length: 3.9 m
Companion Separation: 2.8 m
Frequency Band: 915 MHz
OOB interference power: -8.8552 dBm
Downlink Sensitivity: -55 dBm
Uplink Sensitivity: -81 dBm
TX Antenna Gain: 2 dB
RX Antenna Gain: 2 dB
Endpt Antenna Gain: 0 dB
TX Power: 30 dBm
Fraction Covered: 100%

1G

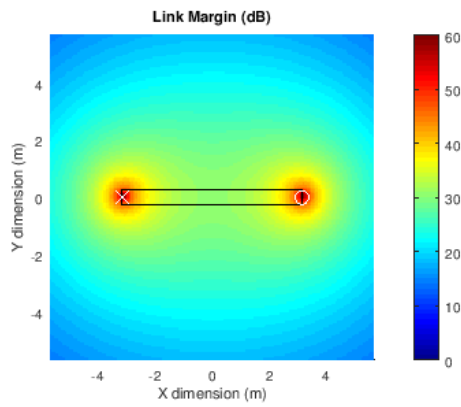

Compartment Name: Indoor Flaps stowage bays
Path Loss Exponent: 2
Compartment Width: 6.3 m
Compartment Length: 0.5 m
Companion Separation: 6.3 m
Frequency Band: 915 MHz
OOB interference power: -13.663 dBm
Downlink Sensitivity: -55 dBm
Uplink Sensitivity: -85 dBm
TX Antenna Gain: 2 dB
RX Antenna Gain: 2 dB
Endpt Antenna Gain: 0 dB
TX Power: 30 dBm
Fraction Covered: 100%

1H

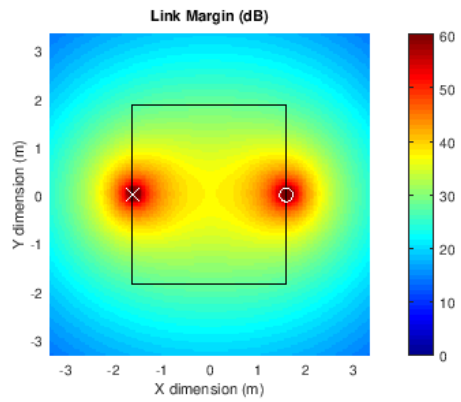

Compartment Name: Indoor Flight deck
Path Loss Exponent: 2.5
Compartment Width: 3.2 m
Compartment Length: 3.7 m
Companion Separation: 3.2 m
Frequency Band: 915 MHz
OOB interference power: -10.305 dBm
Downlink Sensitivity: -55 dBm
Uplink Sensitivity: -82 dBm
TX Antenna Gain: 2 dB
RX Antenna Gain: 2 dB
Endpt Antenna Gain: 0 dB
TX Power: 30 dBm
Fraction Covered: 100%

1I

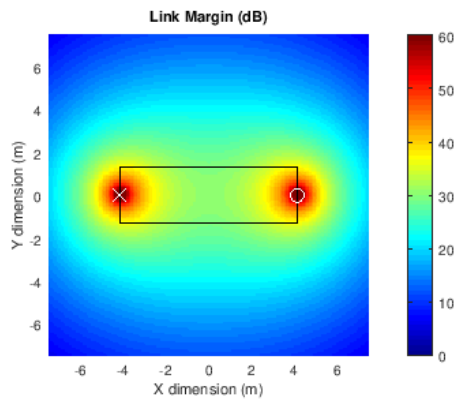

Compartment Name: Indoor Fwd cargo compartment
Path Loss Exponent: 3
Compartment Width: 8.3 m
Compartment Length: 2.6 m
Companion Separation: 8.3 m
Frequency Band: 915 MHz
OOB interference power: -25.2485 dBm
Downlink Sensitivity: -55 dBm
Uplink Sensitivity: -102 dBm
TX Antenna Gain: 2 dB
RX Antenna Gain: 2 dB
Endpt Antenna Gain: 0 dB
TX Power: 30 dBm
Fraction Covered: 100%

1J

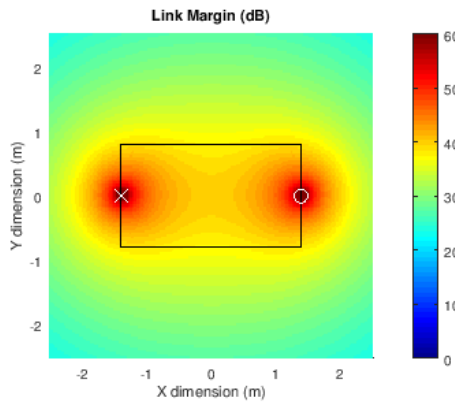

Compartment Name: Indoor Main landing gear bays
Path Loss Exponent: 2
Compartment Width: 2.8 m
Compartment Length: 1.6 m
Companion Separation: 2.8 m
Frequency Band: 915 MHz
OOB interference power: -6.6194 dBm
Downlink Sensitivity: -55 dBm
Uplink Sensitivity: -80 dBm
TX Antenna Gain: 2 dB
RX Antenna Gain: 2 dB
Endpt Antenna Gain: 0 dB
TX Power: 30 dBm
Fraction Covered: 100%

1K

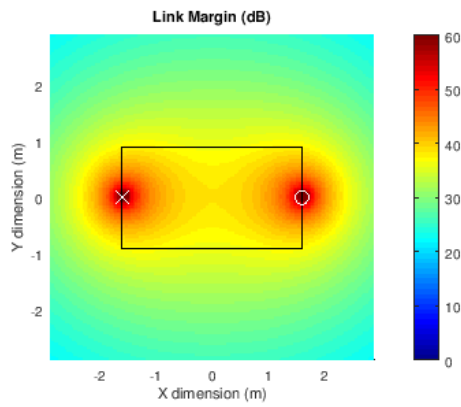

Compartment Name: Indoor Nacelles
Path Loss Exponent: 2
Compartment Width: 3.2 m
Compartment Length: 1.8 m
Companion Separation: 3.2 m
Frequency Band: 915 MHz
OCB interference power: -7.7792 dBm
Downlink Sensitivity: -55 dBm
Uplink Sensitivity: -81 dBm
TX Antenna Gain: 2 dB
RX Antenna Gain: 2 dB
Endpt Antenna Gain: 0 dB
TX Power: 30 dBm
Fraction Covered: 100%

1L

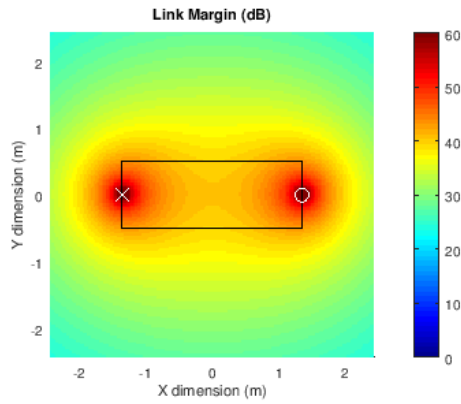

Compartment Name: Indoor Nose landing gear bay
Path Loss Exponent: 2
Compartment Width: 2.7 m
Compartment Length: 1 m
Companion Separation: 2.7 m
Frequency Band: 915 MHz
OCB interference power: -6.3035 dBm
Downlink Sensitivity: -55 dBm
Uplink Sensitivity: -80 dBm
TX Antenna Gain: 2 dB
RX Antenna Gain: 2 dB
Endpt Antenna Gain: 0 dB
TX Power: 30 dBm
Fraction Covered: 100%

1M

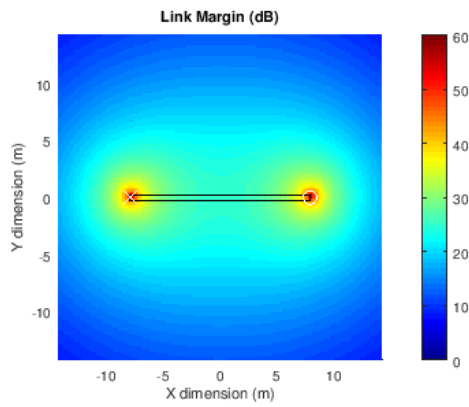

Compartment Name: Indoor Slats stowage bays
Path Loss Exponent: 2
Compartment Width: 15.8 m
Compartment Length: 0.5 m
Companion Separation: 15.8 m
Frequency Band: 915 MHz
OCB interference power: -21.6493 dBm
Downlink Sensitivity: -55 dBm
Uplink Sensitivity: -95 dBm
TX Antenna Gain: 2 dB
RX Antenna Gain: 2 dB
Endpt Antenna Gain: 0 dB
TX Power: 30 dBm
Fraction Covered: 100%

1N

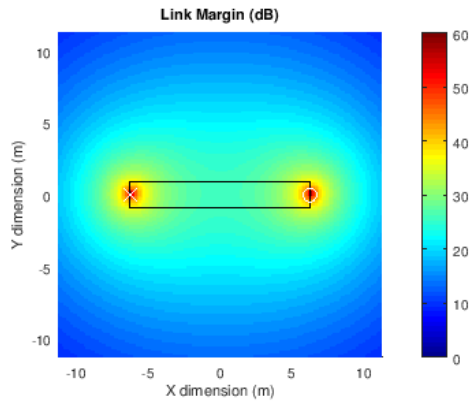

Compartment Name: Indoor Stabilizers horizontal
Path Loss Exponent: 2
Compartment Width: 12.5 m
Compartment Length: 1.8 m
Companion Separation: 12.5 m
Frequency Band: 915 MHz
OCB interference power: -19.6144 dBm
Downlink Sensitivity: -55 dBm
Uplink Sensitivity: -92 dBm
TX Antenna Gain: 2 dB
RX Antenna Gain: 2 dB
Endpt Antenna Gain: 0 dB
TX Power: 30 dBm
Fraction Covered: 100%

10

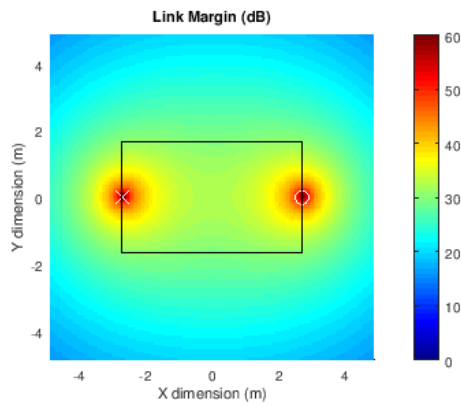

1P

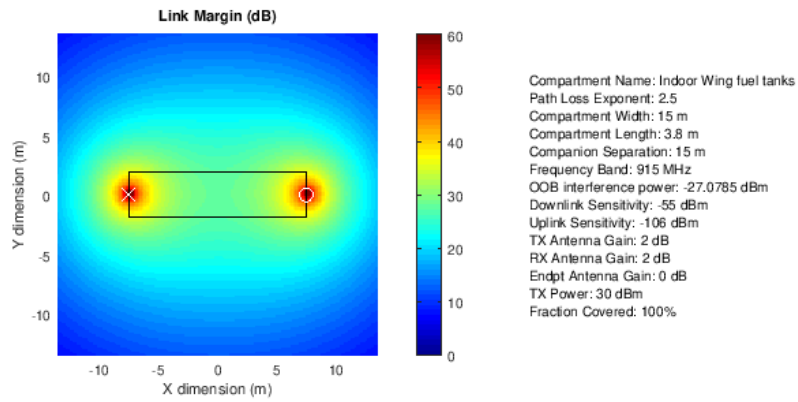

1Q

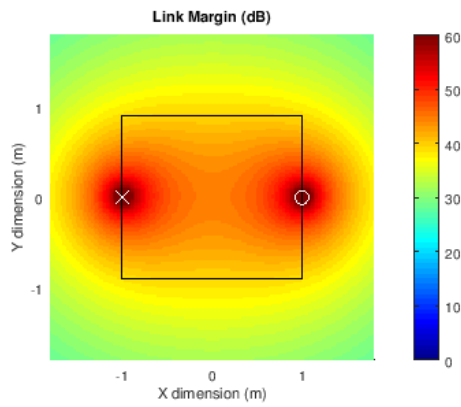

Compartment Name: Outdoor Cabin and Cargo door areas
Path Loss Exponent: 2
Compartment Width: 2 m
Compartment Length: 1.8 m
Companion Separation: 2 m
Frequency Band: 915 MHz
OCB interference power: -3.6968 dBm
Downlink Sensitivity: -55 dBm
Uplink Sensitivity: -79 dBm
TX Antenna Gain: 2 dB
RX Antenna Gain: 2 dB
Endpt Antenna Gain: 0 dB
TX Power: 30 dBm
Fraction Covered: 100%

1R

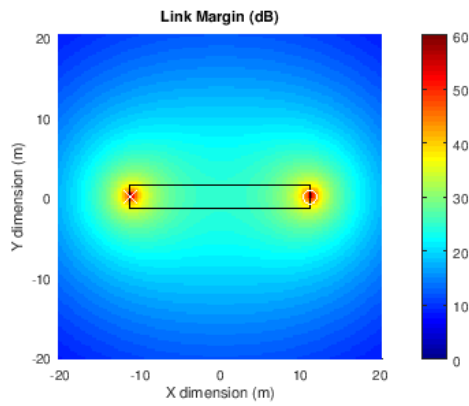

Compartment Name: Outdoor Fuselage
Path Loss Exponent: 2
Compartment Width: 22.5 m
Compartment Length: 3 m
Companion Separation: 22.5 m
Frequency Band: 915 MHz
OCB interference power: -24.7199 dBm
Downlink Sensitivity: -55 dBm
Uplink Sensitivity: -101 dBm
TX Antenna Gain: 2 dB
RX Antenna Gain: 2 dB
Endpt Antenna Gain: 0 dB
TX Power: 30 dBm
Fraction Covered: 100%

1S

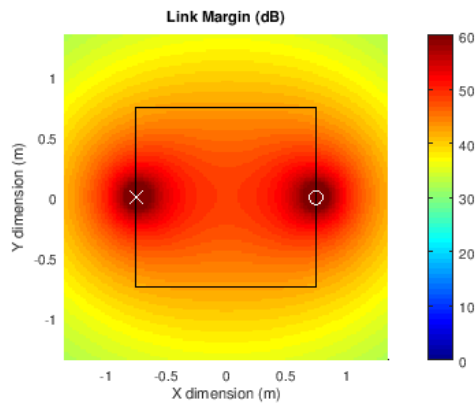

Compartment Name: Outdoor Main Landing Gear
Path Loss Exponent: 2
Compartment Width: 1.5 m
Compartment Length: 1.5 m
Companion Separation: 1.5 m
Frequency Band: 915 MHz
OOB interference power: -1.198 dBm
Downlink Sensitivity: -55 dBm
Uplink Sensitivity: -78 dBm
TX Antenna Gain: 2 dB
RX Antenna Gain: 2 dB
Endpt Antenna Gain: 0 dB
TX Power: 30 dBm
Fraction Covered: 100%

1T

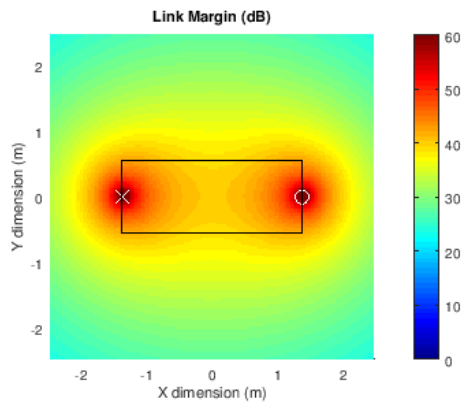

Compartment Name: Outdoor Nacelles
Path Loss Exponent: 2
Compartment Width: 2.75 m
Compartment Length: 1.1 m
Companion Separation: 2.75 m
Frequency Band: 915 MHz
OOB interference power: -6.4629 dBm
Downlink Sensitivity: -55 dBm
Uplink Sensitivity: -80 dBm
TX Antenna Gain: 2 dB
RX Antenna Gain: 2 dB
Endpt Antenna Gain: 0 dB
TX Power: 30 dBm
Fraction Covered: 100%

1U

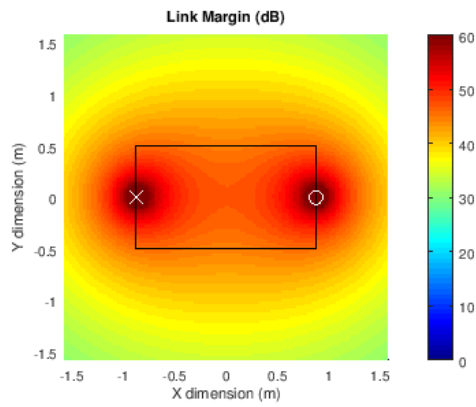

Compartment Name: Outdoor Nose Landing Gear
Path Loss Exponent: 2
Compartment Width: 1.75 m
Compartment Length: 1 m
Companion Separation: 1.75 m
Frequency Band: 915 MHz
OOB interference power: -2.537 dBm
Downlink Sensitivity: -55 dBm
Uplink Sensitivity: -79 dBm
TX Antenna Gain: 2 dB
RX Antenna Gain: 2 dB
Endpt Antenna Gain: 0 dB
TX Power: 30 dBm
Fraction Covered: 100%

1V

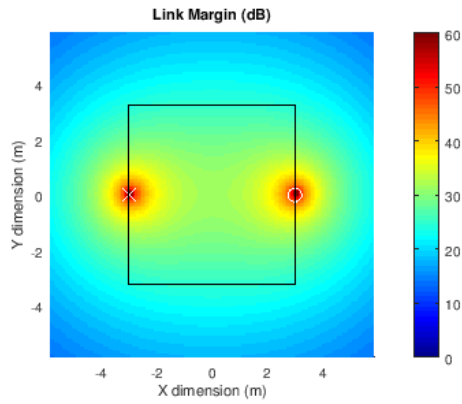

Compartment Name: Outdoor Stabilizers
Path Loss Exponent: 2
Compartment Width: 6 m
Compartment Length: 6.5 m
Companion Separation: 6 m
Frequency Band: 915 MHz
OOB interference power: -13.2392 dBm
Downlink Sensitivity: -55 dBm
Uplink Sensitivity: -85 dBm
TX Antenna Gain: 2 dB
RX Antenna Gain: 2 dB
Endpt Antenna Gain: 0 dB
TX Power: 30 dBm
Fraction Covered: 100%

1W

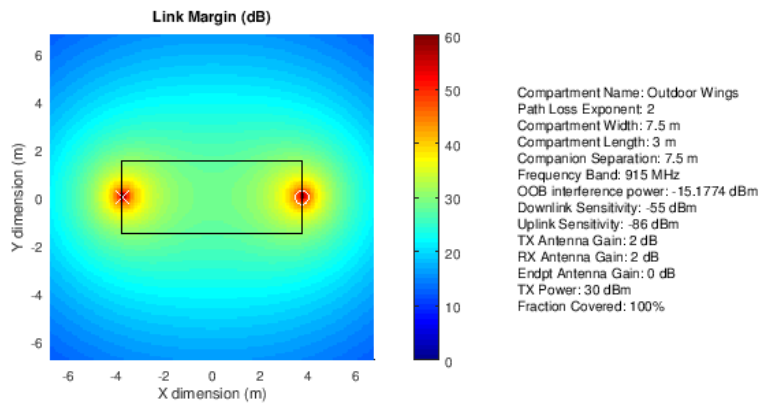

Appendix C: Passive Wi-Fi Projected Coverage

Protocol Details

802.11b (BPSK/QPSK)

Frequency = 2450 MHz

11 Mbps PHY rate

*Because 11 Mbps 802.11b was the only Wi-Fi standard which was found to be the most suitable choice for an application scenario specified in the ITU-R M.2197 operational objectives document, only 11 Mbps Passive Wi-Fi link margin plots are reprinted here.

2A

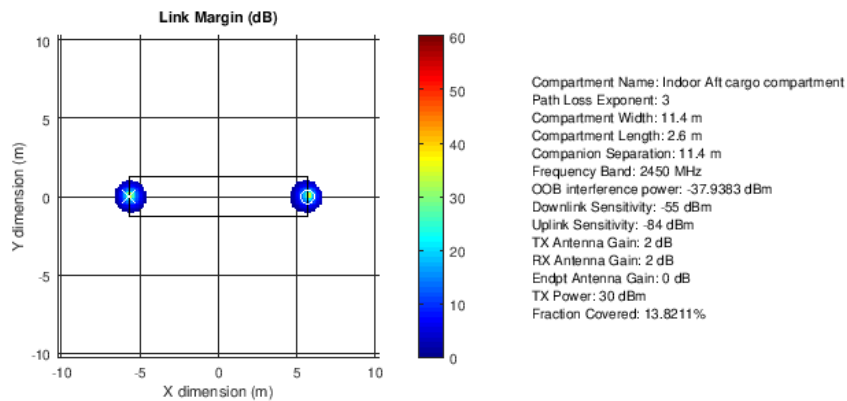

2B

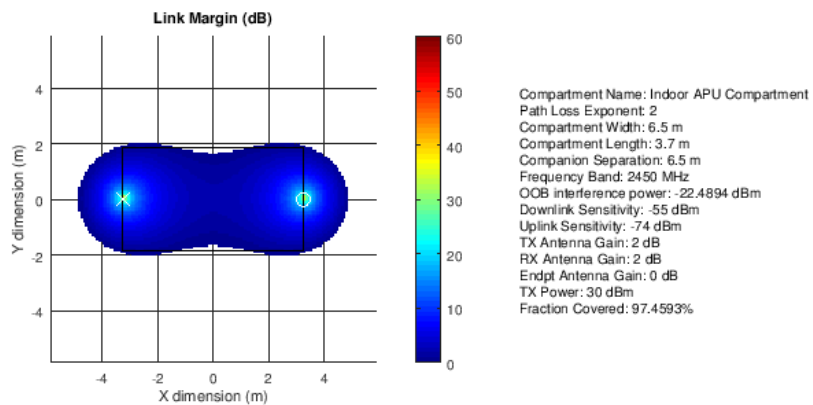

2C

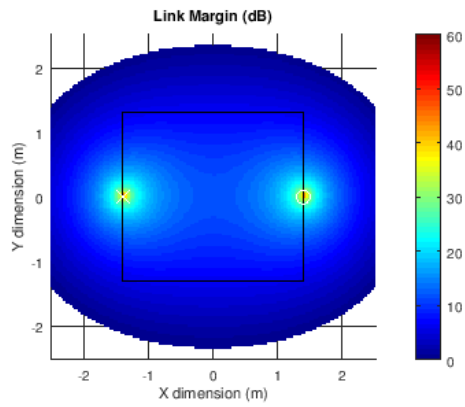

Compartment Name: Indoor Avionics Compartment
Path Loss Exponent: 2
Compartment Width: 2.8 m
Compartment Length: 2.6 m
Companion Separation: 2.8 m
Frequency Band: 2450 MHz
OOB interference power: -15.1743 dBm
Downlink Sensitivity: -55 dBm
Uplink Sensitivity: -69 dBm
TX Antenna Gain: 2 dB
RX Antenna Gain: 2 dB
Endpt Antenna Gain: 0 dB
TX Power: 30 dBm
Fraction Covered: 100%

2D

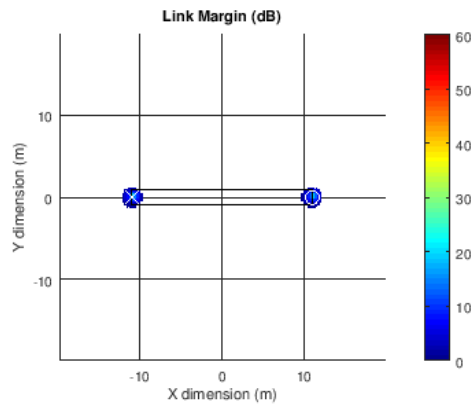

Compartment Name: Indoor Bilge
Path Loss Exponent: 2
Compartment Width: 22 m
Compartment Length: 1.8 m
Companion Separation: 22 m
Frequency Band: 2450 MHz
OOB interference power: -33.0796 dBm
Downlink Sensitivity: -55 dBm
Uplink Sensitivity: -81 dBm
TX Antenna Gain: 2 dB
RX Antenna Gain: 2 dB
Endpt Antenna Gain: 0 dB
TX Power: 30 dBm
Fraction Covered: 11.3821%

2E

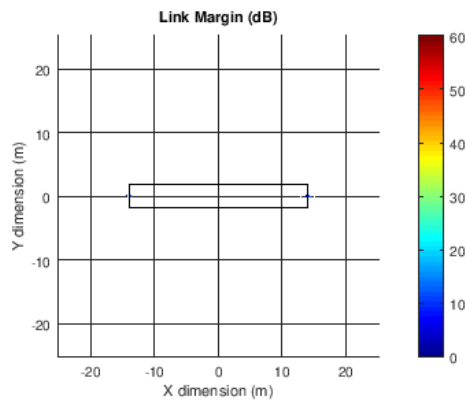

Compartment Name: Indoor Cabin compartment
Path Loss Exponent: 3
Compartment Width: 28 m
Compartment Length: 3.7 m
Companion Separation: 28 m
Frequency Band: 2450 MHz
OOB interference power: -49.6458 dBm
Downlink Sensitivity: -55 dBm
Uplink Sensitivity: -85 dBm
TX Antenna Gain: 2 dB
RX Antenna Gain: 2 dB
Endpt Antenna Gain: 0 dB
TX Power: 30 dBm
Fraction Covered: 0.4878%

2F

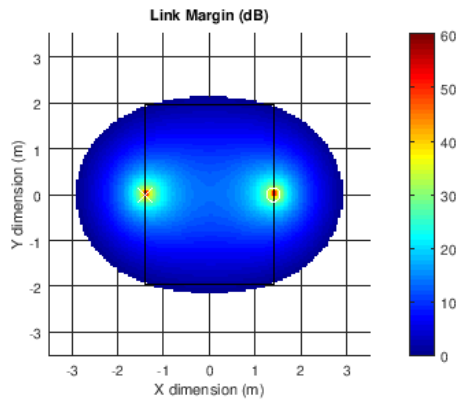

Compartment Name: Indoor Centre tank
Path Loss Exponent: 2.5
Compartment Width: 2.8 m
Compartment Length: 3.9 m
Companion Separation: 2.8 m
Frequency Band: 2450 MHz
OOB interference power: -17.4101 dBm
Downlink Sensitivity: -55 dBm
Uplink Sensitivity: -72 dBm
TX Antenna Gain: 2 dB
RX Antenna Gain: 2 dB
Endpt Antenna Gain: 0 dB
TX Power: 30 dBm
Fraction Covered: 100%

2G

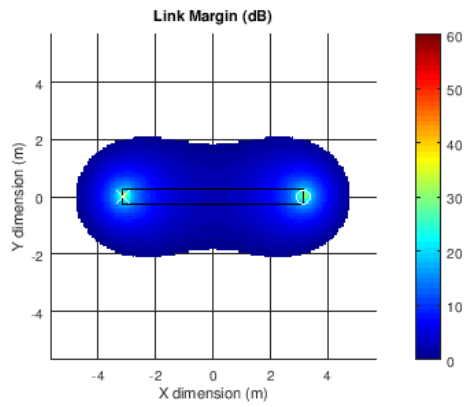

Compartment Name: Indoor Flaps stowage bays
Path Loss Exponent: 2
Compartment Width: 6.3 m
Compartment Length: 0.5 m
Companion Separation: 6.3 m
Frequency Band: 2450 MHz
OOB interference power: -22.2179 dBm
Downlink Sensitivity: -55 dBm
Uplink Sensitivity: -74 dBm
TX Antenna Gain: 2 dB
RX Antenna Gain: 2 dB
Endpt Antenna Gain: 0 dB
TX Power: 30 dBm
Fraction Covered: 100%

2H

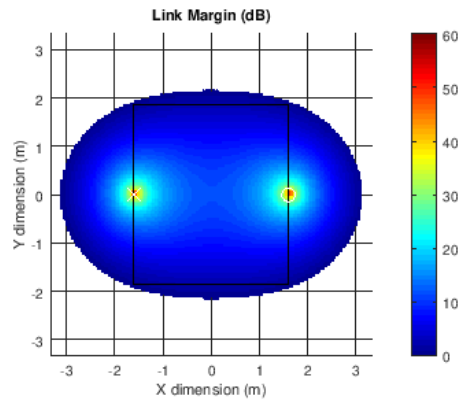

Compartment Name: Indoor Flight deck
Path Loss Exponent: 2.5
Compartment Width: 3.2 m
Compartment Length: 3.7 m
Companion Separation: 3.2 m
Frequency Band: 2450 MHz
OOB interference power: -18.8599 dBm
Downlink Sensitivity: -55 dBm
Uplink Sensitivity: -73 dBm
TX Antenna Gain: 2 dB
RX Antenna Gain: 2 dB
Endpt Antenna Gain: 0 dB
TX Power: 30 dBm
Fraction Covered: 100%

2I

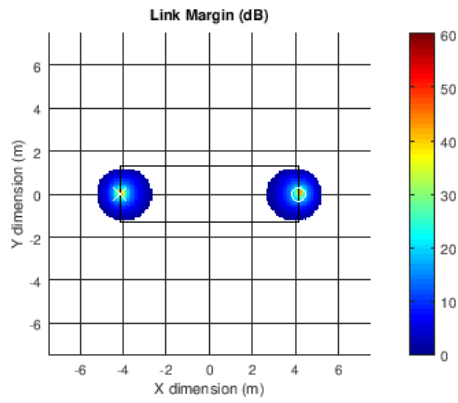

Compartment Name: Indoor Fwd cargo compartment
Path Loss Exponent: 3
Compartment Width: 8.3 m
Compartment Length: 2.6 m
Companion Separation: 8.3 m
Frequency Band: 2450 MHz
OOB interference power: -33.8034 dBm
Downlink Sensitivity: -55 dBm
Uplink Sensitivity: -82 dBm
TX Antenna Gain: 2 dB
RX Antenna Gain: 2 dB
Endpt Antenna Gain: 0 dB
TX Power: 30 dBm
Fraction Covered: 28.1426%

2J

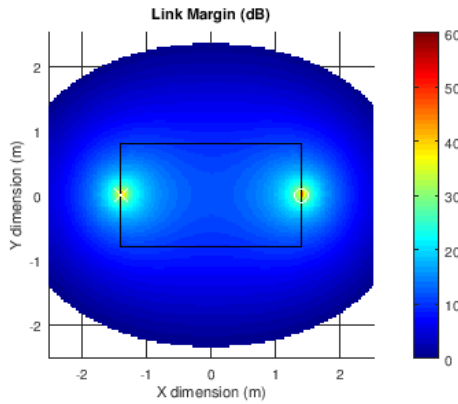

Compartment Name: Indoor Main landing gear bays
Path Loss Exponent: 2
Compartment Width: 2.8 m
Compartment Length: 1.6 m
Companion Separation: 2.8 m
Frequency Band: 2450 MHz
OOB interference power: -15.1743 dBm
Downlink Sensitivity: -55 dBm
Uplink Sensitivity: -69 dBm
TX Antenna Gain: 2 dB
RX Antenna Gain: 2 dB
Endpt Antenna Gain: 0 dB
TX Power: 30 dBm
Fraction Covered: 100%

2K

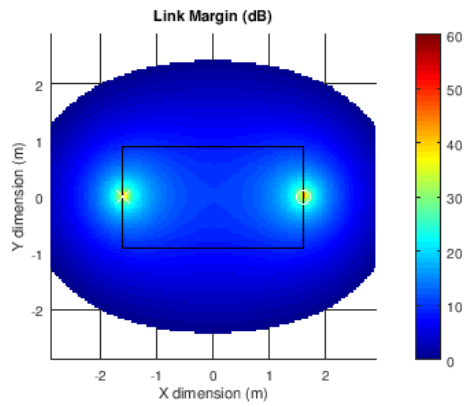

Compartment Name: Indoor Nacelles
Path Loss Exponent: 2
Compartment Width: 3.2 m
Compartment Length: 1.8 m
Companion Separation: 3.2 m
Frequency Band: 2450 MHz
OOB interference power: -16.3341 dBm
Downlink Sensitivity: -55 dBm
Uplink Sensitivity: -70 dBm
TX Antenna Gain: 2 dB
RX Antenna Gain: 2 dB
Endpt Antenna Gain: 0 dB
TX Power: 30 dBm
Fraction Covered: 100%

2L

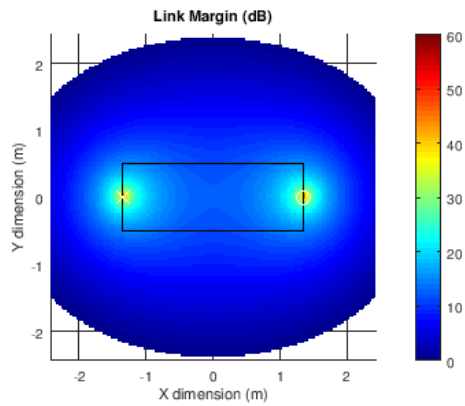

Compartment Name: Indoor Nose landing gear bay
Path Loss Exponent: 2
Compartment Width: 2.7 m
Compartment Length: 1 m
Companion Separation: 2.7 m
Frequency Band: 2450 MHz
OOB interference power: -14.8584 dBm
Downlink Sensitivity: -55 dBm
Uplink Sensitivity: -69 dBm
TX Antenna Gain: 2 dB
RX Antenna Gain: 2 dB
Endpt Antenna Gain: 0 dB
TX Power: 30 dBm
Fraction Covered: 100%

2M

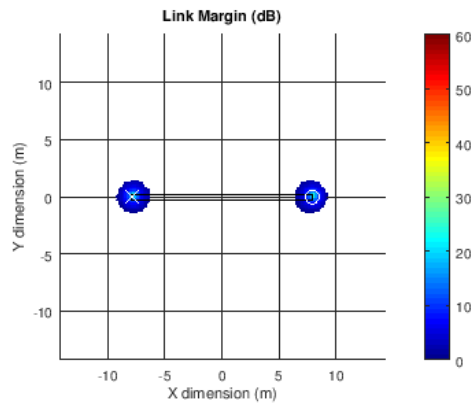

Compartment Name: Indoor Slats stowage bays
Path Loss Exponent: 2
Compartment Width: 15.8 m
Compartment Length: 0.5 m
Companion Separation: 15.8 m
Frequency Band: 2450 MHz
OOB interference power: -30.2042 dBm
Downlink Sensitivity: -55 dBm
Uplink Sensitivity: -79 dBm
TX Antenna Gain: 2 dB
RX Antenna Gain: 2 dB
Endpt Antenna Gain: 0 dB
TX Power: 30 dBm
Fraction Covered: 19.5122%

2N

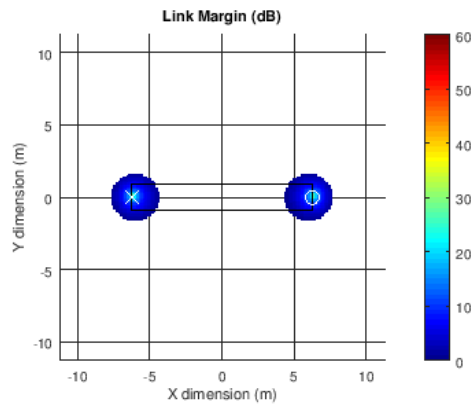

Compartment Name: Indoor Stabilizers horizontal
Path Loss Exponent: 2
Compartment Width: 12.5 m
Compartment Length: 1.8 m
Companion Separation: 12.5 m
Frequency Band: 2450 MHz
OOB interference power: -28.1693 dBm
Downlink Sensitivity: -55 dBm
Uplink Sensitivity: -78 dBm
TX Antenna Gain: 2 dB
RX Antenna Gain: 2 dB
Endpt Antenna Gain: 0 dB
TX Power: 30 dBm
Fraction Covered: 30.0813%

20

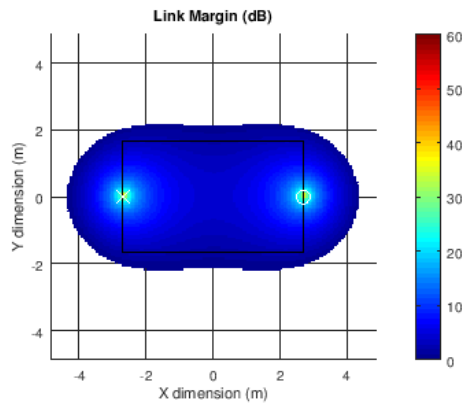

Compartment Name: Indoor Stabilizers vertical
Path Loss Exponent: 2
Compartment Width: 5.4 m
Compartment Length: 3.3 m
Companion Separation: 5.4 m
Frequency Band: 2450 MHz
OOB interference power: -20.879 dBm
Downlink Sensitivity: -55 dBm
Uplink Sensitivity: -73 dBm
TX Antenna Gain: 2 dB
RX Antenna Gain: 2 dB
Endpt Antenna Gain: 0 dB
TX Power: 30 dBm
Fraction Covered: 100%

2P

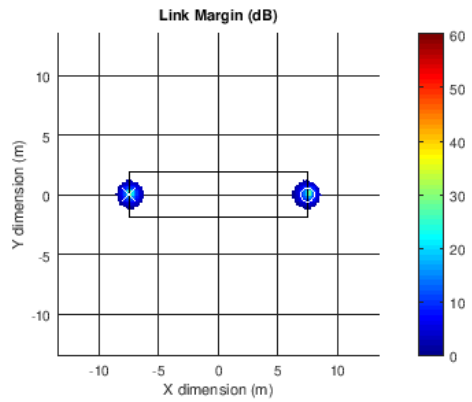

Compartment Name: Indoor Wing fuel tanks
Path Loss Exponent: 2.5
Compartment Width: 15 m
Compartment Length: 3.8 m
Companion Separation: 15 m
Frequency Band: 2450 MHz
OOB interference power: -35.6334 dBm
Downlink Sensitivity: -55 dBm
Uplink Sensitivity: -83 dBm
TX Antenna Gain: 2 dB
RX Antenna Gain: 2 dB
Endpt Antenna Gain: 0 dB
TX Power: 30 dBm
Fraction Covered: 9.0244%

2Q

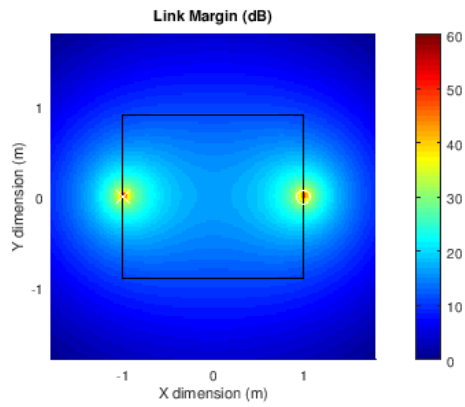

Compartment Name: Outdoor Cabin and Cargo door areas
Path Loss Exponent: 2
Compartment Width: 2 m
Compartment Length: 1.8 m
Companion Separation: 2 m
Frequency Band: 2450 MHz
OOB interference power: -12.2517 dBm
Downlink Sensitivity: -55 dBm
Uplink Sensitivity: -68 dBm
TX Antenna Gain: 2 dB
RX Antenna Gain: 2 dB
Endpt Antenna Gain: 0 dB
TX Power: 30 dBm
Fraction Covered: 100%

2R

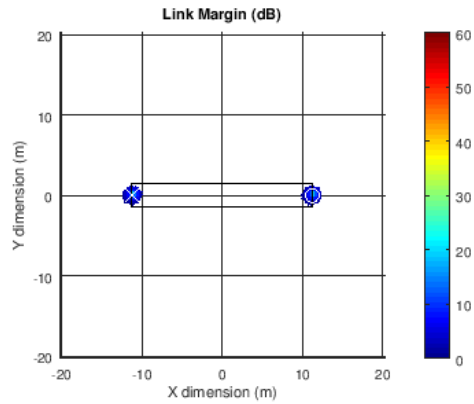

Compartment Name: Outdoor Fuselage
Path Loss Exponent: 2
Compartment Width: 22.5 m
Compartment Length: 3 m
Companion Separation: 22.5 m
Frequency Band: 2450 MHz
OOB interference power: -33.2748 dBm
Downlink Sensitivity: -55 dBm
Uplink Sensitivity: -81 dBm
TX Antenna Gain: 2 dB
RX Antenna Gain: 2 dB
Endpt Antenna Gain: 0 dB
TX Power: 30 dBm
Fraction Covered: 7.7236%

2S

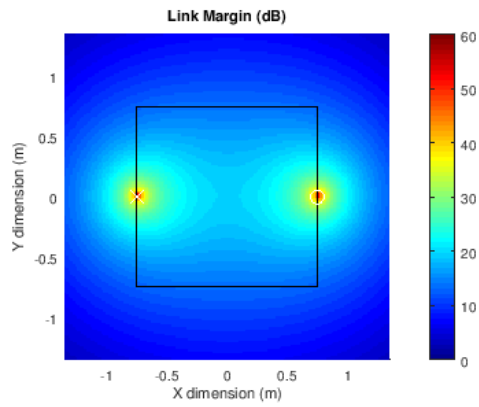

Compartment Name: Outdoor Main Landing Gear
Path Loss Exponent: 2
Compartment Width: 1.5 m
Compartment Length: 1.5 m
Companion Separation: 1.5 m
Frequency Band: 2450 MHz
OOB interference power: -9.7529 dBm
Downlink Sensitivity: -55 dBm
Uplink Sensitivity: -66 dBm
TX Antenna Gain: 2 dB
RX Antenna Gain: 2 dB
Endpt Antenna Gain: 0 dB
TX Power: 30 dBm
Fraction Covered: 100%

2T

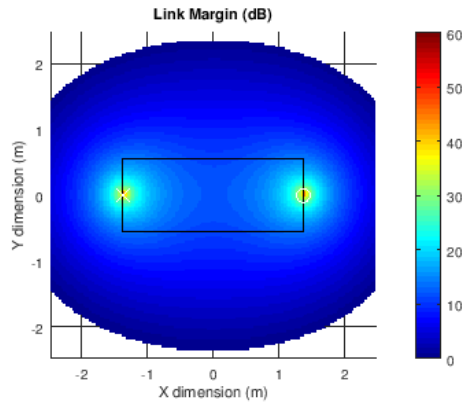

Compartment Name: Outdoor Nacelles
Path Loss Exponent: 2
Compartment Width: 2.75 m
Compartment Length: 1.1 m
Companion Separation: 2.75 m
Frequency Band: 2450 MHz
OOB interference power: -15.0178 dBm
Downlink Sensitivity: -55 dBm
Uplink Sensitivity: -69 dBm
TX Antenna Gain: 2 dB
RX Antenna Gain: 2 dB
Endpt Antenna Gain: 0 dB
TX Power: 30 dBm
Fraction Covered: 100%

2U

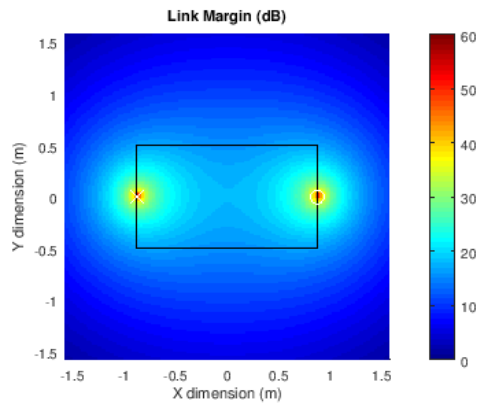

Compartment Name: Outdoor Nose Landing Gear
Path Loss Exponent: 2
Compartment Width: 1.75 m
Compartment Length: 1 m
Companion Separation: 1.75 m
Frequency Band: 2450 MHz
OOB interference power: -11.0919 dBm
Downlink Sensitivity: -55 dBm
Uplink Sensitivity: -67 dBm
TX Antenna Gain: 2 dB
RX Antenna Gain: 2 dB
Endpt Antenna Gain: 0 dB
TX Power: 30 dBm
Fraction Covered: 100%

2V

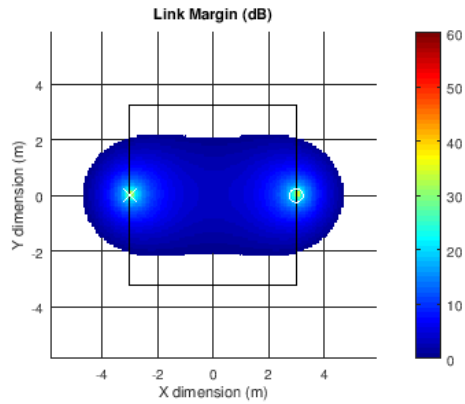

Compartment Name: Outdoor Stabilizers
Path Loss Exponent: 2
Compartment Width: 6 m
Compartment Length: 6.5 m
Companion Separation: 6 m
Frequency Band: 2450 MHz
OOB interference power: -21.7941 dBm
Downlink Sensitivity: -55 dBm
Uplink Sensitivity: -74 dBm
TX Antenna Gain: 2 dB
RX Antenna Gain: 2 dB
Endpt Antenna Gain: 0 dB
TX Power: 30 dBm
Fraction Covered: 67.3299%

2W

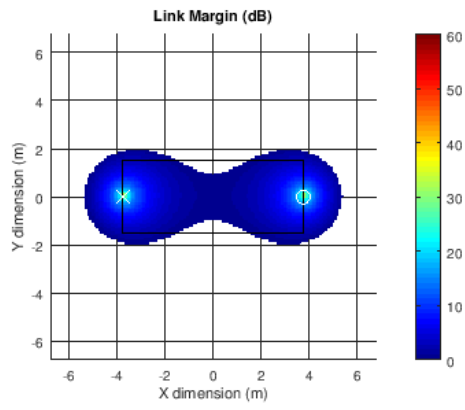

Compartment Name: Outdoor Wings
Path Loss Exponent: 2
Compartment Width: 7.5 m
Compartment Length: 3 m
Companion Separation: 7.5 m
Frequency Band: 2450 MHz
OOB interference power: -23.7323 dBm
Downlink Sensitivity: -55 dBm
Uplink Sensitivity: -75 dBm
TX Antenna Gain: 2 dB
RX Antenna Gain: 2 dB
Endpt Antenna Gain: 0 dB
TX Power: 30 dBm
Fraction Covered: 91.5352%

Appendix D: References

- [1] International Telecommunication Union, "Technical Characteristics and Operational Objectives for Wireless Avionics Intra-Communications (WAIC)," International Telecommunication Union, Geneva, 2011.
- [2] Semtech, "www.semtech.com," [Online]. Available: <http://www.semtech.com/apps/product.php?pn=sx1276>.

Appendix E: Acronyms and Abbreviations

BLE	BlueTooth Low Energy
bps	Bits per Second
BPSK	Binary Phase Shift Key
BW	Bandwidth
COTS	Commercial Off the Shelf
CSS	Chirp Spread Spectrum
CTS	Clear to Send
CW	Continuous Wave
dB	Decibel
dBm	Decibel-Milliwatt
DDS	Direct Digital Synthesis
FADEC	Full Authority Digital Engine or Electronic Control
FCC	Federal Communications Commission
FPGA	Field Programmable Gate Array
FSK	Frequency Shift Keying
GHz	Gigahertz
HI	High-Rate Indoors
HO	High-Rate Outdoors
IoT	Internet-of-Things
ITU	International Telecommunication Union
KHz	Kilohertz
LI	Low-Rate Indoors
LM	Link Margin
LO	Low-Rate Outdoors
LoRa	Low-Rate/Long-Range
Mbps	Megabits Per Second
MHz	Megahertz
ms	Millisecond
OOB	Out-of-Band
OOK	On-Off Keyed
PCB	Printed Circuit Board
PER	Packet Error Rate
PHY	Physical Layer
PIFA	Planar Inverted-F Antenna
PLE	Path Loss Exponent
QPSK	Quadrature Phase Shift Keying
RF	Radio Frequency
RFID	Radio-Frequency Identification
RS	Receive Sensitivity
RTS	Request to Send
RX	Receive
SIR	Signal-to-Interference Ratio
SoC	System on Chip
TX	Transmit
USRP	Universal Software Radio Peripheral
WAIC	Wireless Avionics Intra-Communications
Wi-Fi	Wireless Fidelity