



Experimental and computational study of tones occurring with a coaxial nozzle

Khairul Zaman, Ivana Milanovic, Amy Fagan and Chris Miller
NASA Glenn Research Center, Cleveland, OH 44135**

[Professor, University of Hartford, CT. Visiting faculty fellow at GRC, summer, 2017]**

**Aviation Forum 2018
24th AIAA/CEAS Aeroacoustics Conference
Atlanta, June 29, 2018**

**Supported by
Transformational Tools and Technologies (TTT) Project and
Commercial Supersonic Technologies (CST) Project**

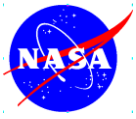

Outline of talk:

Background

Synopsis of preceding study

Present nozzle configuration

Results

Summary

Background:

Tones were encountered in large-scale, multi-stream nozzle tests in the Aeoacoustics Propulsion Laboratory (AAPL).

2-stream nozzle noise data

(James Bridges)

CVP42_66630

Scenario 4: Lossless Conditions / 1ft Radius / ModelScale

polar = 90°

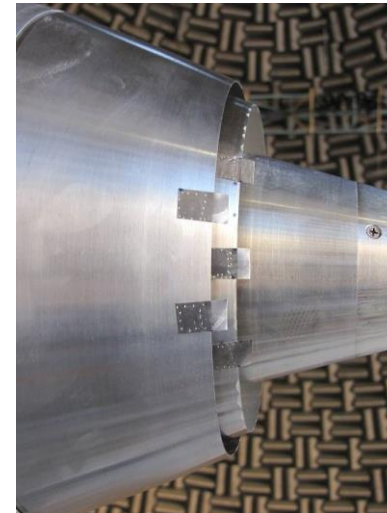
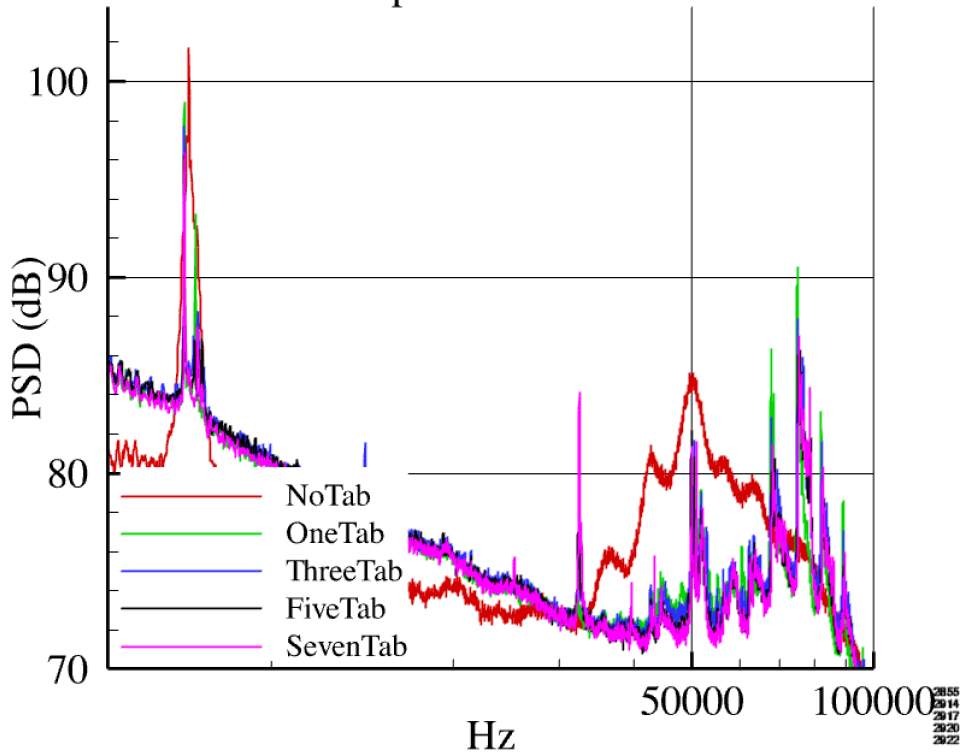

Study with a model of the two-stream nozzle

(*AIAA J.* 56(5), 2018)

Approximately half-scale model was built to study the tones and find possible remedy in a smaller facility.



Struts

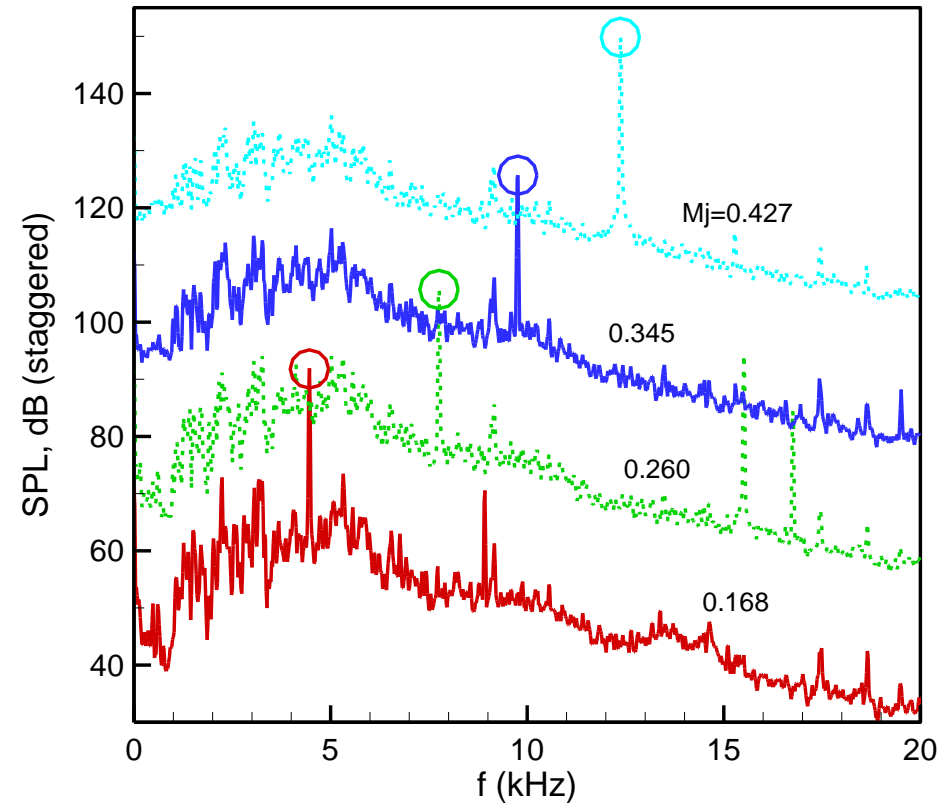

Caps on struts removed the tones

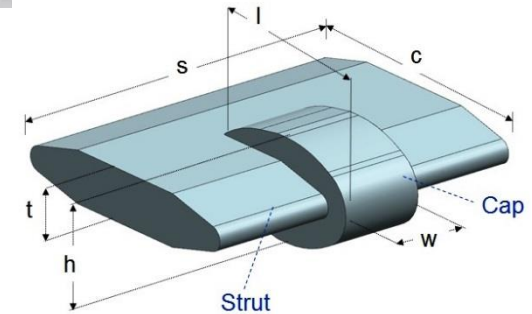
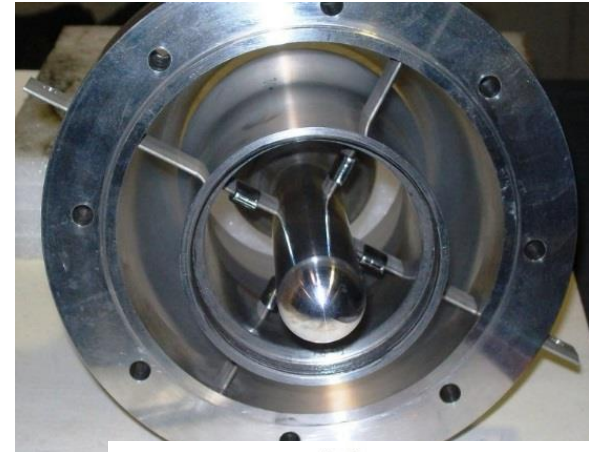
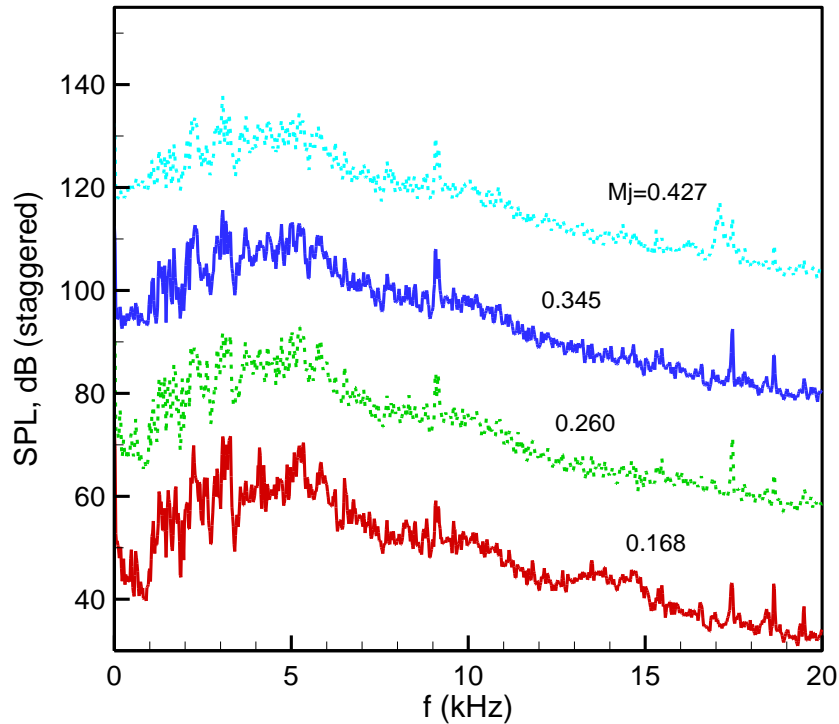

- Caps took the tones out !!
- With full-span caps tones came back in M_j range of 0.4-0.85.



Numerical simulation Results

Chris Miller using COMSOL

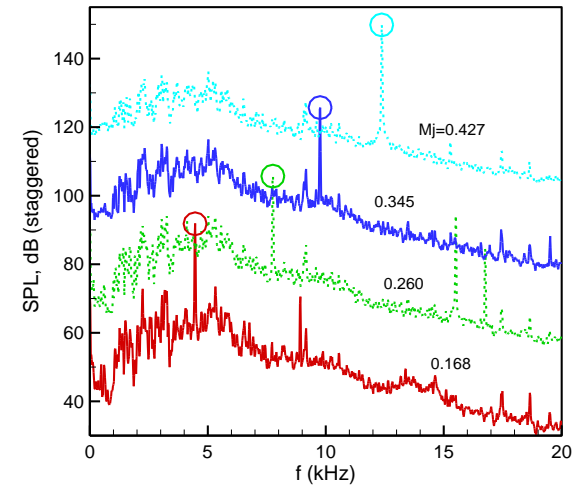
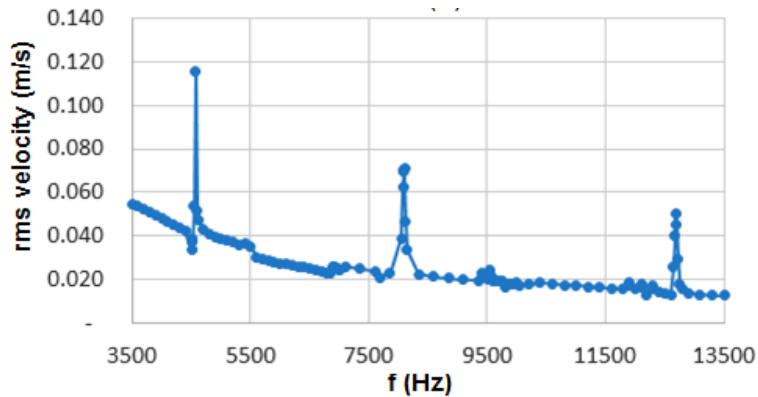

M_j	f (Hz) experiment	f (Hz) simulation
0.168	4460	4565
0.260	7760	8054
0.427	12375	12522

- Peaks at 4.5, 7.8 and 12.4 kHz are captured !
- Hint of energy at 9.8 kHz also.

Pressure distribution for fundamental at 4.5 kHz

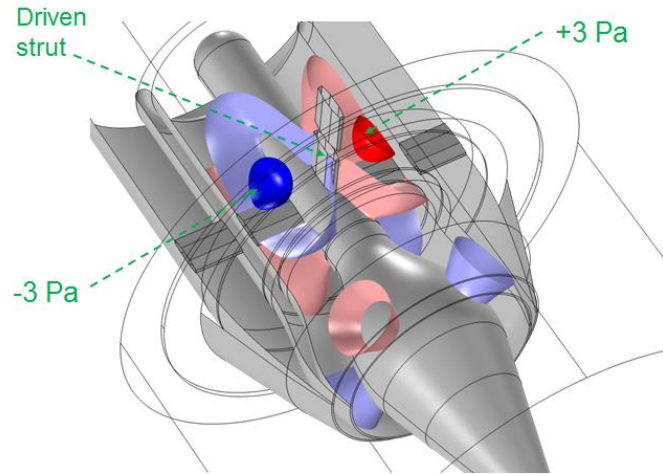
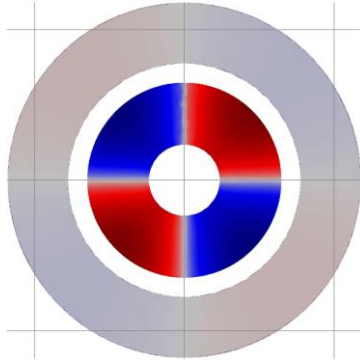

- Standing waves around struts.
- Anti-nodes between pairs of struts.

More complex modes at higher freqs

8.05 kHz

12.52 kHz



Scope of present work:

Numerical simulation with COMSOL continued. Results to be presented in the next paper of the session.

A different coaxial nozzle used in a past experiment (shock interaction with jet plume) also produced tones. Were those also linked to shedding from struts? The answer: no.

In this paper, we present experimental and COMSOL results addressing the tone mechanism in the latter nozzle.

Nozzle details

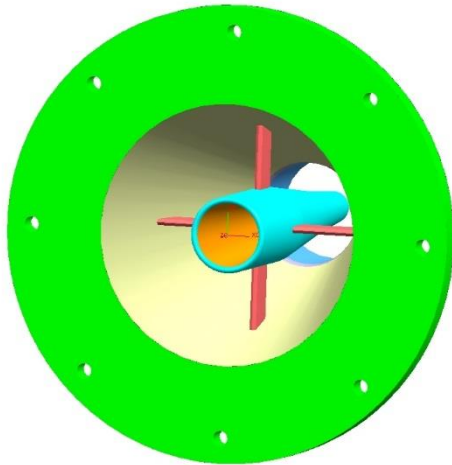
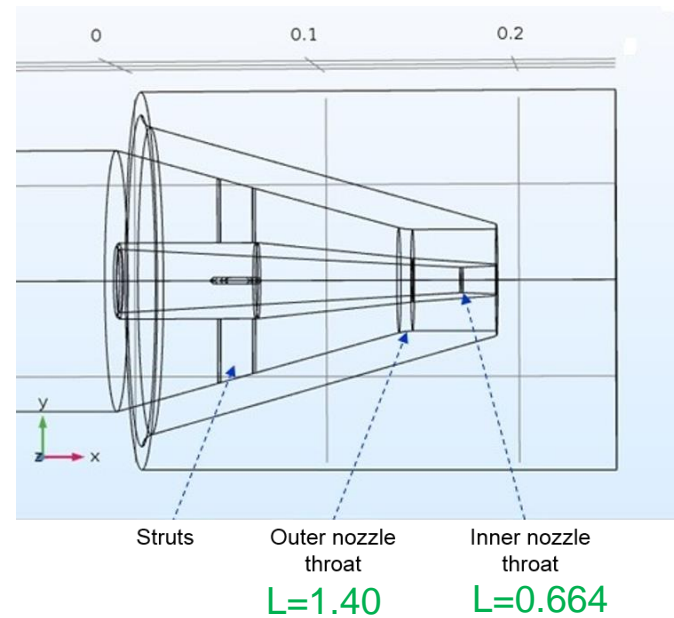
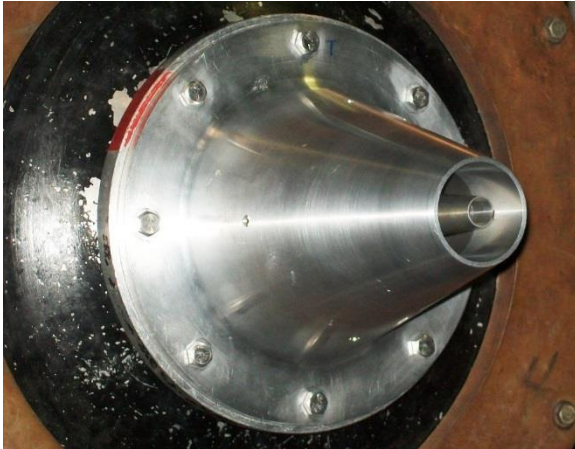

Outer nozzle, $D=2.0$, $M_D=1.4$
 Inner nozzle, $d=0.559$, $M_D=1.6$
 Lip thickness of inner nozzle, $t=0.030$
 Strut thickness, $T=0.125$

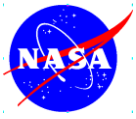

SPL spectra at various M_j

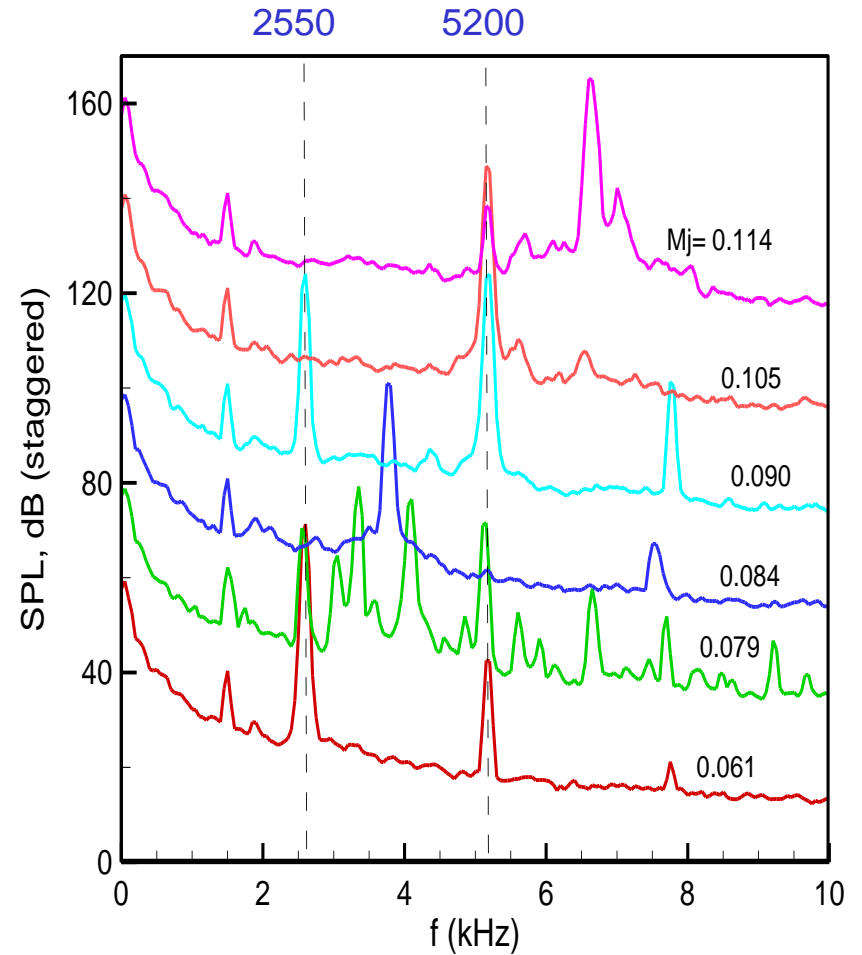
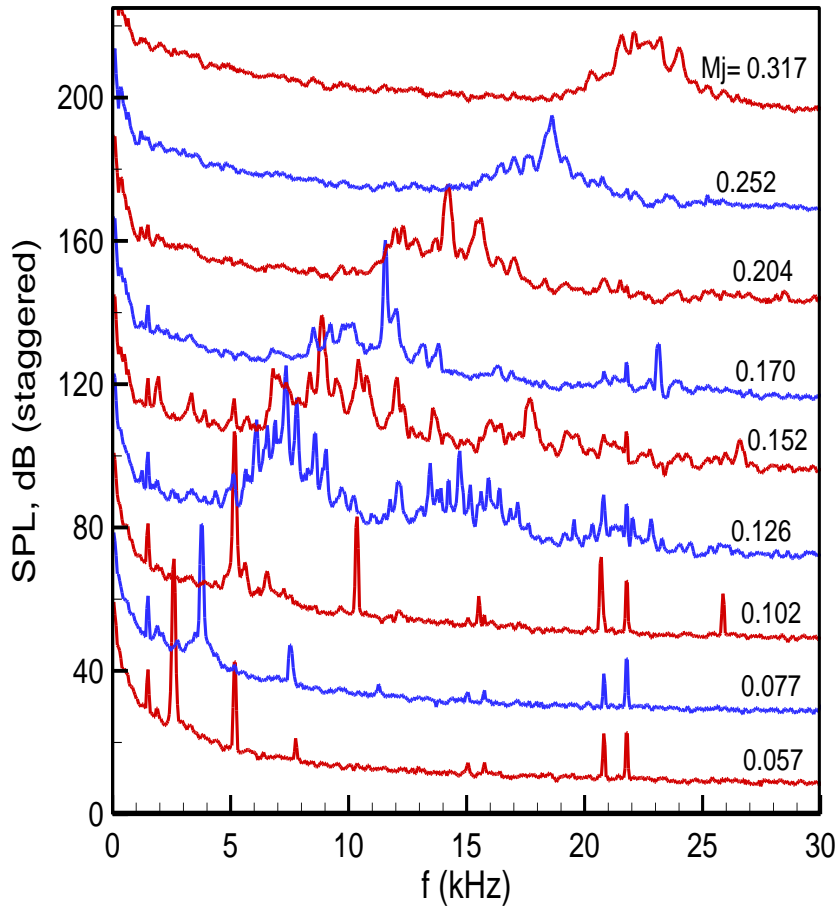

Effect of 'caps' on struts

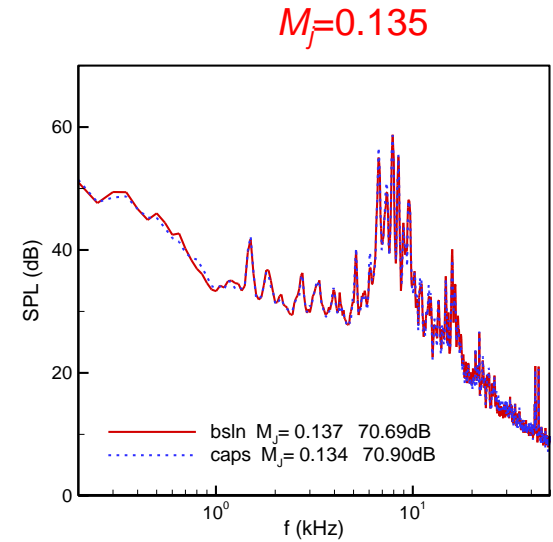
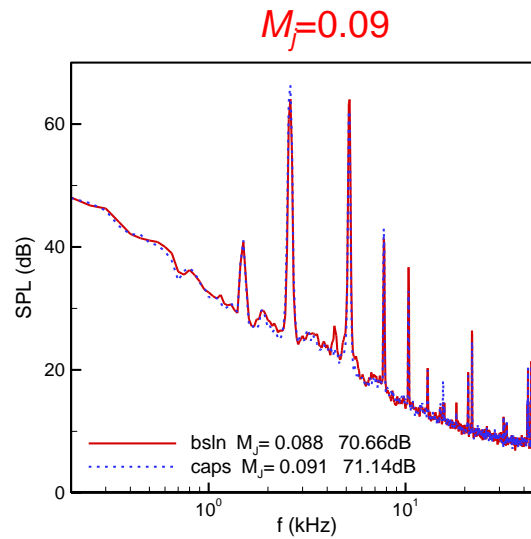
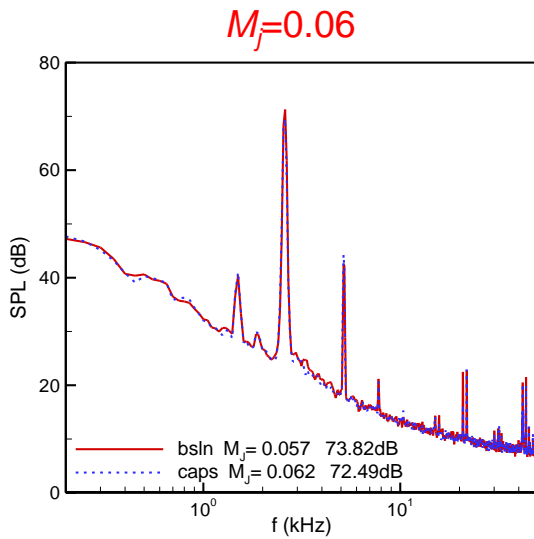

$fT/U_{local} \approx 1.78$ (T = strut thickness).
Shedding from strut is not linked to tones.

Effect of tabs on inner nozzle lip

$M_j=0.06$

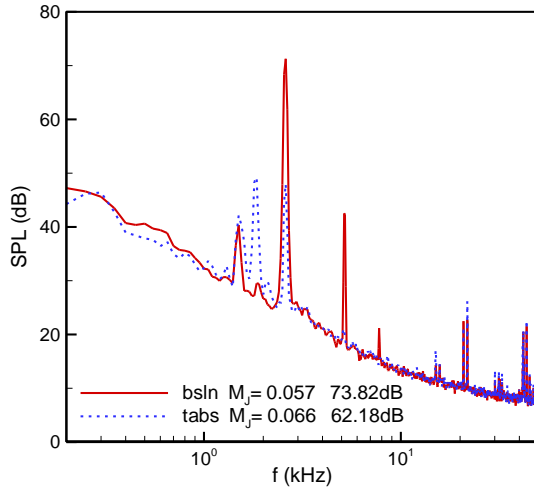

$M_j=0.09$

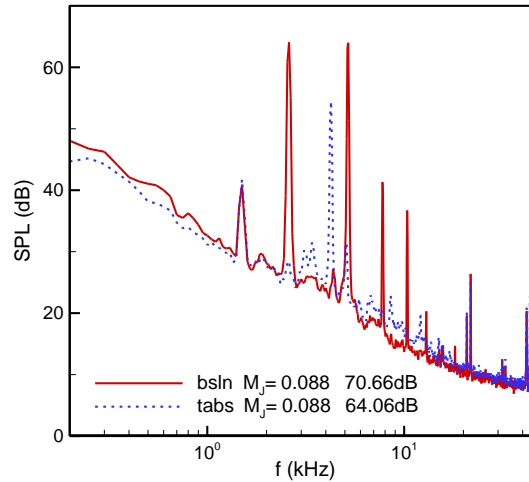

$M_j=0.135$

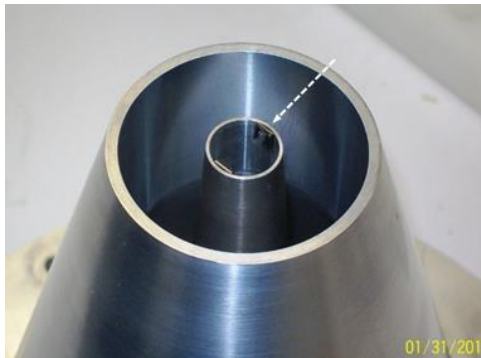
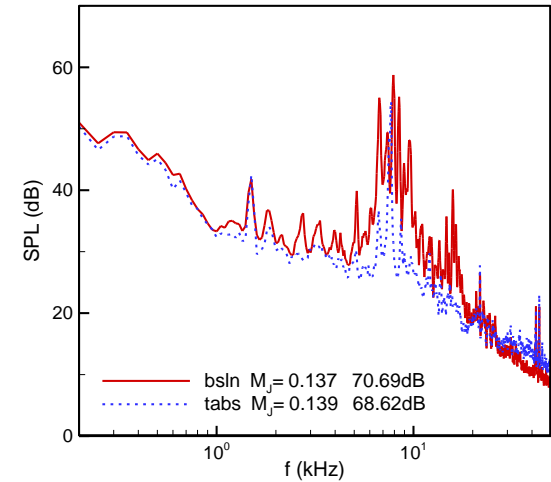

$ft/U_j \approx 0.2$ (t =inner noz lip thickness).

Tones must be linked to shedding from the inner noz lip. Tabs affected tones but did not Take them out completely.

Effect of epoxy beads near inner nozzle throat

$M_j=0.06$

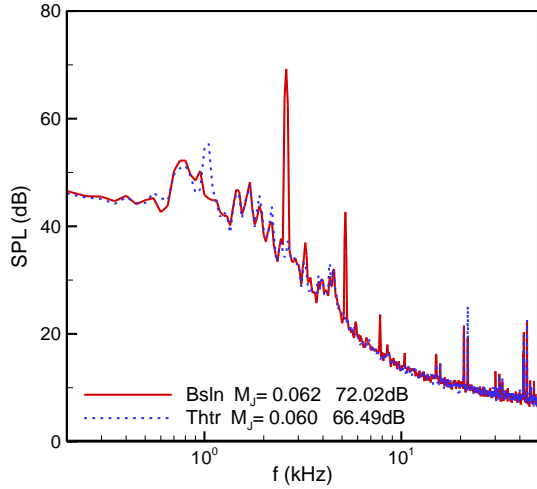

$M_j=0.09$

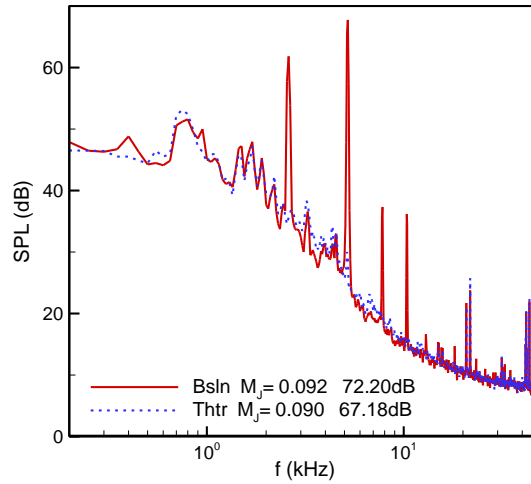

$M_j=0.135$

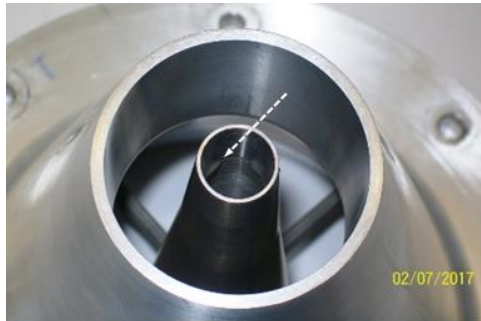
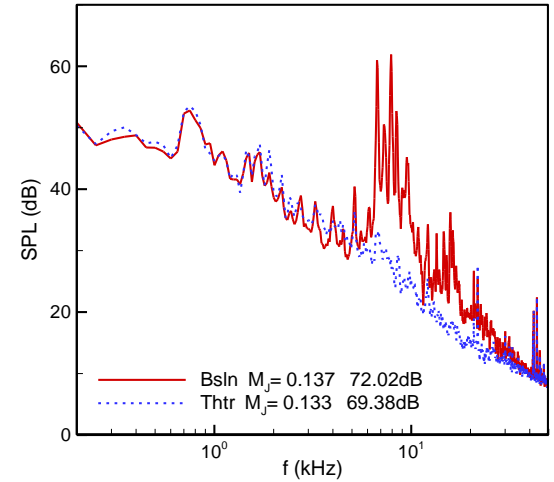

The beads took out tones.



Mechanism?

It is apparent that shedding from inner nozzle lip is the 'driver'. But shedding alone does not explain the sharp tones. It must be locking on to something, most likely the acoustic modes of the configuration.

Numerical simulation with COMSOL (no flow)

(excitation amplitude is ± 1 Pa)

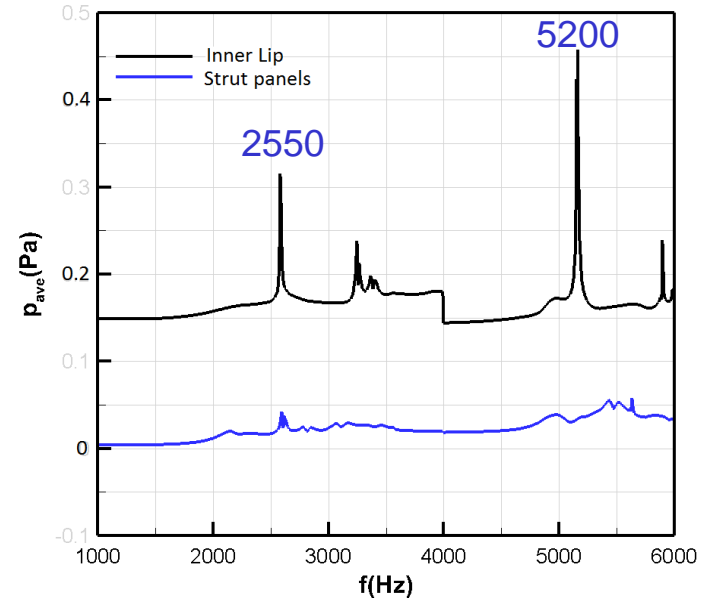
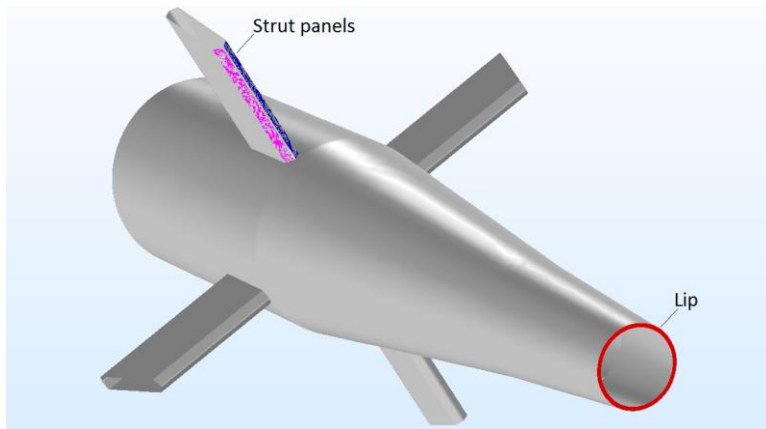
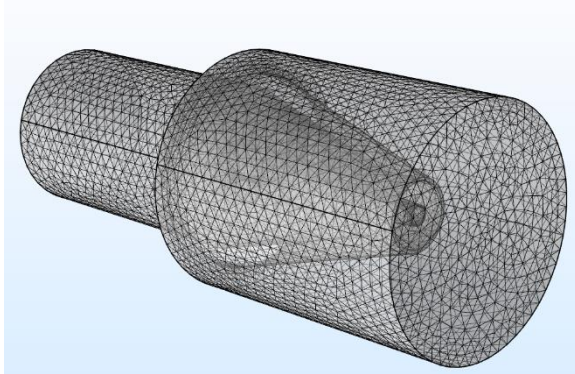

Simulation with lip excitation captures the two tones seen in experiment.

Numerical simulation with COMSOL

Iso-surfaces of pressure amplitude at 2550 Hz.

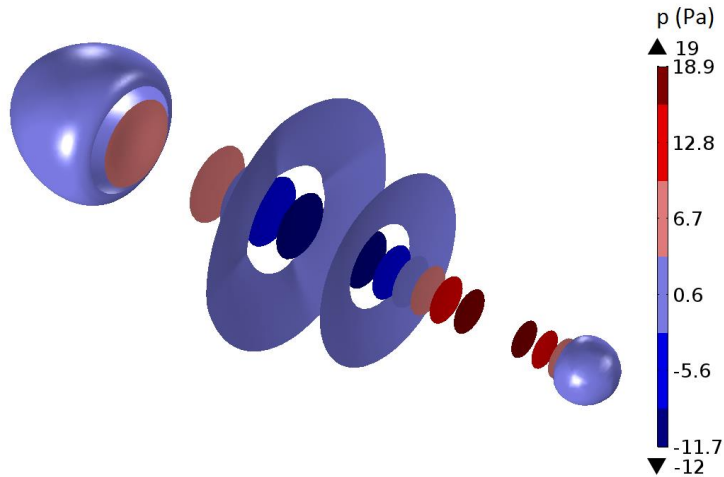

Centerline pressure at 2550 Hz

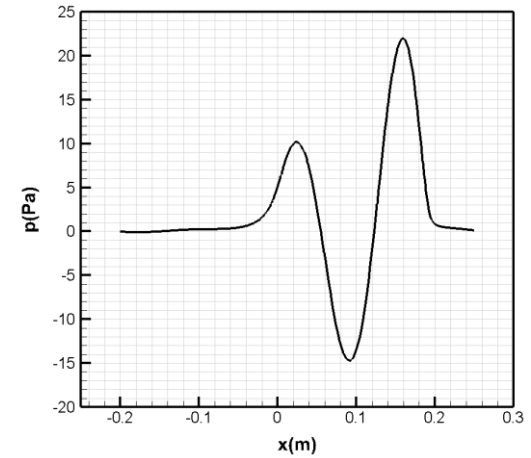

Iso-surfaces exhibit axisymmetric (plane) waves.

Centerline pressure distribution

Centerline pressure
At 5200 Hz

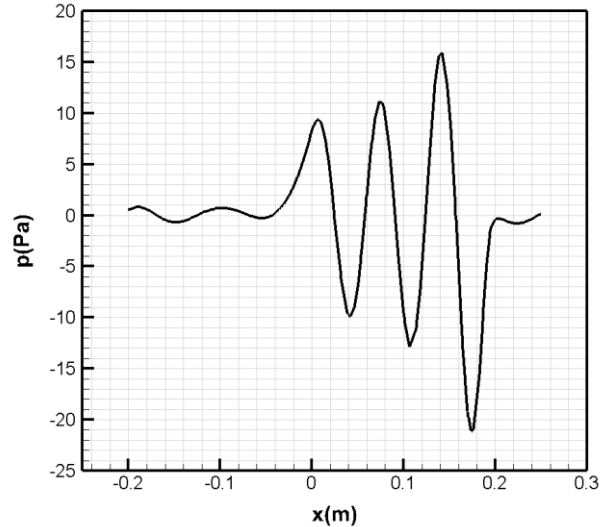

$$\lambda = 2.66$$

$\lambda/4 = 0.664 =$ throat-to-exit
length of inner nozzle

So, likely mechanism:

When shedding frequency from inner nozzle lip excites one-quarter-wave resonance in divergent section of inner nozzle, the 5200Hz tone is generated. Similarly, one-quarter-wave resonance in divergent section of the outer nozzle apparently is responsible for the 2550Hz tone.

What occurred with tabs and epoxy beads?

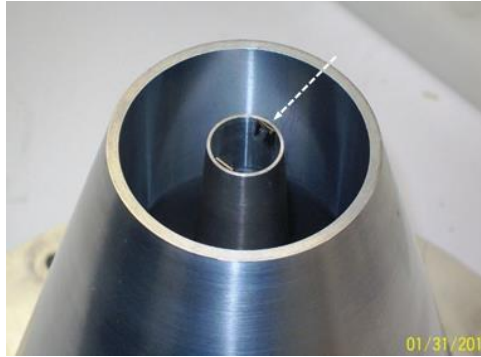

Tabs affected the tones but did not take them out completely. Likely because tabs did not break the 2-D nature of flow completely.

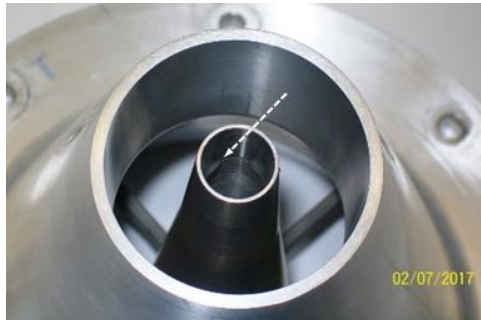

The beads took out the tones. Likely due to more effective break up of 2-D nature of the flow. Disturbances from four beads grew before reaching lip.

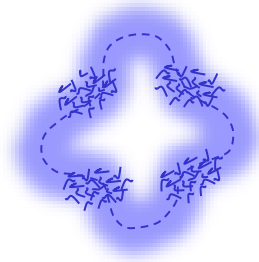

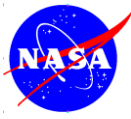

Conclusions:

- Sharp tones at 2550 Hz and 5200 Hz occur in a low range of jet Mach number.
- Vortex shedding from struts is ruled out to be the 'driver'. Instead, vortex shedding from the inner nozzle lip is linked to tones.
- When the shedding frequency matches that of a quarter-wave resonance in the divergent section of the inner nozzle it generates the 5200 Hz tone. A matching of the quarter-wave resonance in the divergent section of the outer nozzle appears to be responsible for the 2550 Hz tone.