

Additive Manufacturing of Liquid Rocket Engine Combustion Devices: A Summary of Process Developments and Hot-Fire Testing Results

*Paul Gradl¹, Sandy E. Greene², Christopher Protz³, Brad Bullard⁴, James Buzzell⁵,
Chance Garcia⁶, Jessica Wood⁷, Kenneth Cooper⁸*
NASA Marshall Space Flight Center, Huntsville, Alabama

James Hulka⁹
Jacobs Technology, Inc., Jacobs Space Exploration Group, Huntsville, Alabama

Robin Osborne¹⁰
ERC Incorporated, Jacobs Space Exploration Group, Huntsville, Alabama

Additive Manufacturing (AM) of metals is a processing technology that has significantly matured over the last decade. For liquid propellant rocket engines, the advantages of AM for replacing conventional manufacturing of complicated and expensive metallic components and assemblies are very attractive. AM can significantly reduce hardware cost, shorten fabrication schedules, increase reliability by reducing the number of joints, and improve hardware performance by allowing fabrication of designs not feasible by conventional means. The NASA Marshall Space Flight Center (MSFC) has been involved with various forms of metallic additive manufacturing for use in liquid rocket engine component design, development, and testing since 2010. The AM technique most often used at the NASA MSFC has been powder-bed fusion or selective laser melting (SLM), although other techniques including laser directed energy deposition (DED), arc-based deposition, and laser-wire cladding techniques have also been used to develop several components. The purpose of this paper is to discuss the various internal programs at the NASA MSFC using AM to develop combustion devices hardware. To date at the NASA MSFC, combustion devices component hardware ranging in size from 100 lbf to 35,000 lbf have been designed and manufactured using SLM and deposition-based AM processes, and many of these pieces have been hot-fire tested. Combustion devices component hardware have included thrust chamber injectors, injector components such as faceplates, regeneratively-cooled combustion chambers, regeneratively-cooled nozzles, gas generator and preburner hardware, and augmented spark igniters. Ongoing and future developments for combustion devices have also included design of components sized for boost-class engines. Several design and hot-fire test iterations have been completed on these subscale and larger scale components, and a summary of these results will be presented as well.

¹ Senior Combustion Devices Engineer, Component Technology Branch, Senior Member, AIAA

² Senior Combustion Devices Engineer, Component Technology Branch

³ Team Lead, Component Technology Branch

⁴ Team Lead, Component Technology Branch

⁵ Senior Combustion Devices Engineer, Component Technology Branch

⁶ Combustion Devices Engineer, Component Technology Branch

⁷ Combustion Devices Engineer, Component Technology Branch, Senior Member, AIAA

⁸ Additive Manufacturing Lead Engineer, Advanced Manufacturing Branch

⁹ Subject Matter Expert, Component Technology Branch, Associate Fellow, AIAA

¹⁰ Senior Engineer, Component Technology Branch, Associate Fellow, AIAA

Nomenclature

AM	=	Additive Manufacturing or Additively Manufactured
ASI	=	Augmented Spark Igniter
CNC	=	Computer Numerical Control
CSTD	=	Combustion Stability Tool Development
D_c	=	Chamber Diameter (inches)
DED	=	Direct Energy Deposition
EB	=	Electron Beam
EBF ³	=	Electron Beam Freeform Fabrication
GCD	=	Game Changing Development
GRC	=	Glenn Research Center
GRCop	=	Glenn Research Center Copper-alloy
INFCR	=	Integrated Nozzle Film Coolant Ring
lb_f	=	pound-force (thrust)
LEO	=	Liquid Engines Office
LRE	=	Liquid Rocket Engine
LWDC	=	Laser Wire Direct Closeout
HIP	=	Hot Isostatic Press
MDDM	=	Metal Direct Digital Manufacturing
η_{c^*}	=	Characteristic exhaust velocity efficiency
MSFC	=	Marshall Space Flight Center
ORPB	=	oxidizer-rich preburner
PBF	=	Powder bed fusion
P_c	=	Chamber Pressure (psia)
SLM	=	Powder bed fusion
SEM	=	Scanning Electron Microscope
SLM	=	Selective Laser Melting
SLS	=	Space Launch System
STMD	=	Space Technology Mission Directorate
TRL	=	Technology Readiness Level
UAH	=	University of Alabama in Huntsville

I. Introduction

Additive Manufacturing (AM) is an emerging technology for fabrication of complex metallic components that is being evaluated and used in rocket propulsion applications. The NASA Marshall Space Flight Center (MSFC) first started evaluation of this technology in 2010 for a simple hot gas exhaust duct, but has since evolved the technology for complex shapes and internal features that were not previously possible with traditional manufacturing techniques¹. MSFC has continued to evolve additive manufacturing technologies through continued process development, design for additive methods, application and component development and testing, process certification, low technology readiness level (TRL) advancement, end-to-end process evaluation, and material development. A significant portion of AM development at MSFC is focused on liquid rocket engine applications through investments from the Space Launch System (SLS) Liquid Engines Office (LEO), Space Technology and Mission Directorate (STMD) Game Changing Development (GCD) program, Lander Project Office, Commercial Partnerships, and internal investments by MSFC. These investments have already shown significant returns through implementation of reduced part count and fabrication time and continued process certification of a complex pogo baffle on the RS25 engine, achieving several full-scale hot-fire tests and wide use of the AM technology across the commercial space industry².

There are several advantages to additive manufacturing over traditional fabrication methods that includes significant schedule reductions, reductions in overall lifecycle costs, and performance improvements due to complex internal features. Combustion devices components such as injectors, combustion chambers, nozzles and augmented spark ignition systems are taking full advantage of additive manufacturing due to traditionally long-lead times for complex assembly operations, complex internal features, and tight tolerances required to maintain high performance

and assembly integration³. Component designers can significantly reduce the part count and eliminate complex brazing or welding assembly operations using AM. MSFC has completed years of design and process development using additive manufacturing for these components and has successfully hot-fire tested a variety of components and assemblies in several propellant combinations and conditions. These developments have focused on evolving the additive manufacturing technology to realize the full potential of cost and schedule savings and to understand performance associated with these new technologies. Development work has demonstrated a 50% cost savings and >50% schedule savings compared to traditional techniques, although savings are highly dependent on part by part basis. NASA's role is to help evolve the additive manufacturing processes, materials, application of, and certification of additive manufacturing for use in NASA programs and commercial space programs. This is accomplished through partnerships with industry and in-house development efforts to disseminate data to industry.

Additive manufacturing is a general term that defines a layer-by-layer fabrication method to form three-dimensional shapes as opposed to machining (or subtractive manufacturing) and joining multiple parts⁴. Several types of additive manufacturing have evolved over the last decade and are being advanced for combustion devices component fabrication. These processes can be characterized into several categories that use powder and wire as feedstock to fabricate parts. A chart showing the various metal additive manufacturing processes/techniques is shown in Fig. 1 and based on a chart previously shown by Ek^{5,6}. NASA is exploring all the additive technologies shown in the figure with a focus on the powder-bed based, primarily selective laser melting and directed energy deposition technology with a focus on blown powder, arc and laser-wire. There has been some initial process development exploring the solid state additive techniques, shown in Fig. 1, that show an advantage for limited heat input into the material and subsequent component during fabrication.

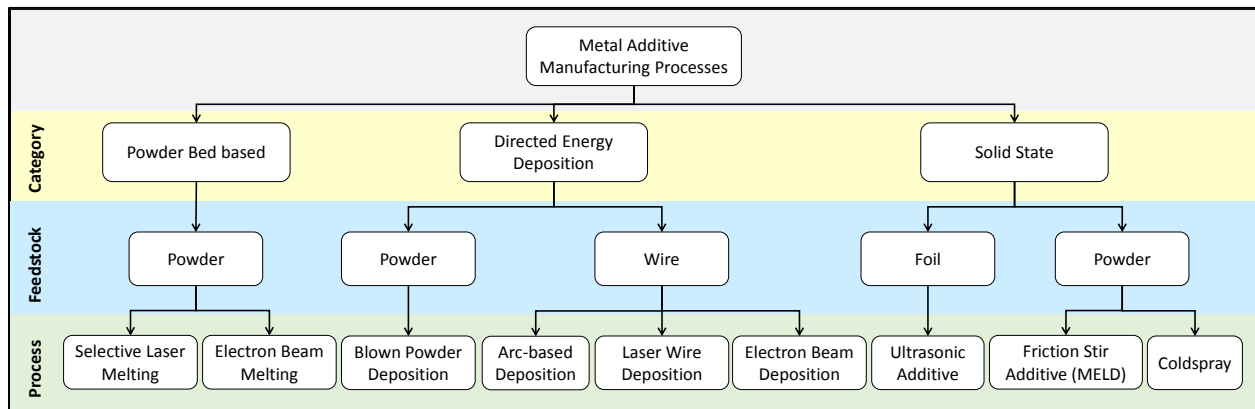

Figure 1. Metallic Additive Manufacturing Processes used in Component Development.

There are varying reasons for using these additive technologies and each has their advantages and disadvantages. The primary considerations are complexity of features and scale of the components. While selective laser melting can produce highly complex internal and external features, it is limited in scale that components such as nozzles would not fit. Alternate techniques such as the directed energy deposition technologies allow for significantly increased build scale and deposition rates, but at the cost of resolution of features⁷. Some of these techniques such as blown powder deposition, are advancing to provide more complex features (such as thinner walls comparable to SLM) while others are being used as a near-net shape casting or forging replacement, offering only coarse features. A relative comparison of the techniques is illustrated in Fig. 2. These processes are continually evolving and new materials are being added, so the deposition/build rates and feature resolution will continue to improve.

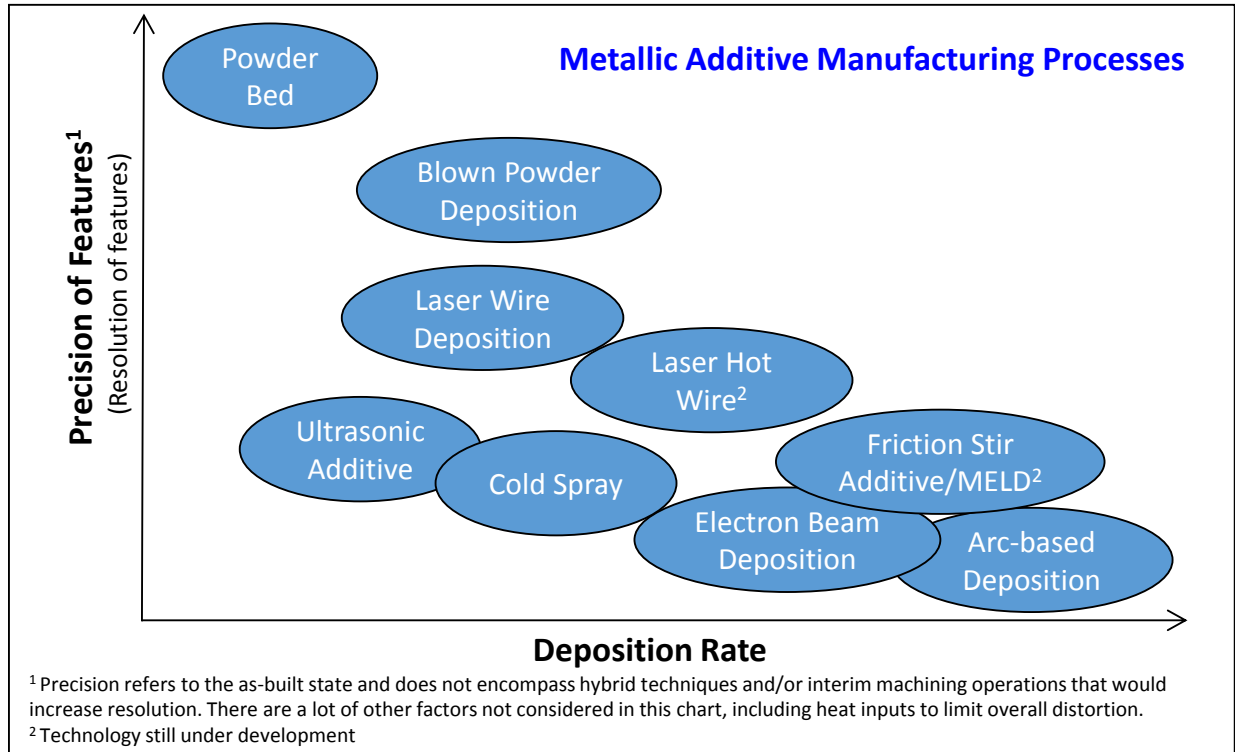

Figure 2. Comparison of Metallic Additive Manufacturing Processes.

A. Selective Laser Melting

The most common AM process is powder-bed fusion (PBF), also known as selective laser melting (SLM), which uses a layer-by-layer powder-bed approach in which the desired component features are sintered and subsequently solidified using a laser. SLM is being used for all combustion device components described in this paper, including subassemblies (i.e. manifolds, flanges). The process starts with a 3D-CAD model that is sliced into thin 2D layers that define the laser toolpath for sintering the part. A thin layer, typically 0.001" or thinner, of metal powder is spread across the build area and a fine focus laser raster and melts (or sinters) the area that defines the part cross-section at that particular layer^{8,9}. A build plate is required to initiate the process so the material has something to bond to. After a layer is completed, the build plate is lowered slightly and a new layer of powder is spread and the laser sinters the new build layer. Sufficient power is used to penetrate into previous build layers, allowing proper bonding between layers. The process is repeated thousands of times until the part is fully fabricated or grown. This allows for complex internal features to be fabricated, such as coolant channels. The entire build is completed in an inert environment that limits oxidation of the melt pool. The SLM process and an example of a SLM copper-alloy liner being fabricated are shown in Fig. 3 and Fig. 4.

The scale for SLM, however, is limited and does not provide a solution for all components. A majority of the SLM machines available for component fabrication are sized to accommodate 250mm x 250mm x 300mm (9.8" x 9.8" x 11"), but new machines are becoming available with up to 600mm x 400mm x 500mm (23.6" x 15.7" x 19.7"). The scale of SLM machines is continually increasing, but have limited availability as of the publication date of this paper.

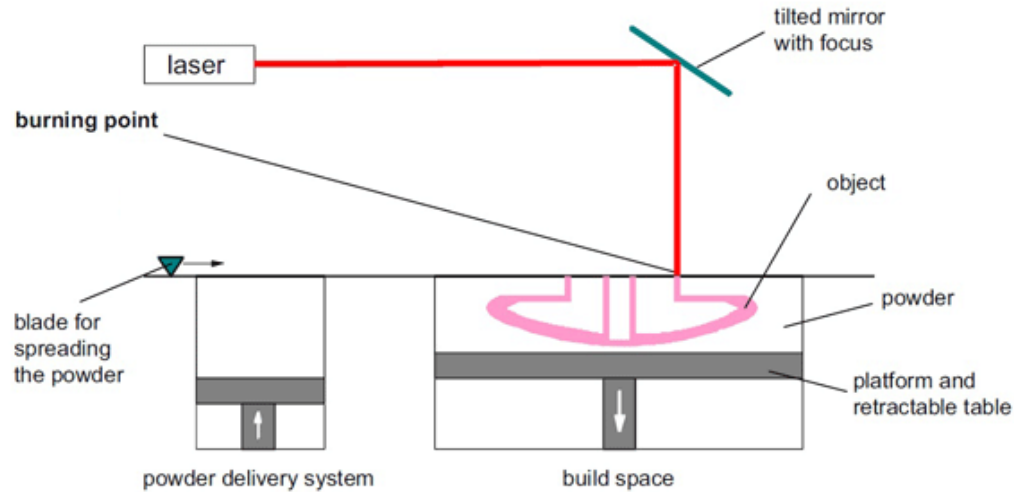

Figure 3. Overview of Selective Laser Melting (SLM) Fabrication Process. [Ref. 10]



Figure 4. SLM Chamber Fabrication showing the Coutouring Pass (Left) and In-fill Pass (Right).

A variety of example SLM parts for use in combustion device applications will be shown throughout this paper, since that has been the focus of the AM development work at MSFC. NASA has also been investigating and developing other additive technologies due to the size limitation of SLM.

B. Directed Energy Deposition

To make use of additive manufacturing for components larger than the SLM scale, MSFC has been evaluating freeform fabrication techniques using directed energy deposition (DED). These additive deposition technologies have been demonstrated to provide preforms for near net shape fabrication as a forging and casting replacement and final geometry (built to model) fabrication. The DED techniques that are being advanced for combustion devices include blown powder deposition, arc-based deposition, and laser-wire deposition, although others are also being considered¹¹.

1. Laser Wire Deposition

Laser wire deposition is being used for combustion devices to closeout coolant channels for nozzles and chambers and also provide local asymmetric and symmetric features. The laser wire-fed deposition process provides the lowest heat flux and uses small wire diameters. Mounting the laser on a multi-axis platform provides the freeform ability to print a part of any size using a localized purge gas. The low heat flux and small wire provide the ability to print internal features with minimal distortion, although this method has the lowest deposition rate of the wire-based processes¹². This technology approach has been used to print large features, such as hatbands on nozzles, with low distortion¹³. NASA and industry partners have evolved and patented a new approach for closeout of channel wall structures, such as regeneratively cooled nozzles, called Laser Wire Direct Closeout (LWDC).

The LWDC process deposits wire to bridge the coolant channels without the need for any filler within the channels. An independent wire feed and offset inert gas-purged laser beam melts wire in an area of stock prior to closeout region of the coolant channels. While the nozzle is rotated about the center axis, the wire is deposited onto the previous layer with a minor amount of laser energy being used to fuse the wire to the backside of the channel lands. This process is repeated along the wall of the nozzle at continuously varying angles until the required area is closed out¹⁴. LWDC is used for the direct closeout of the coolant channels and application of the structural jacket. LWDC is an additive manufacturing wire-fed laser deposition process that eliminates the need for a tight tolerance structural jacket and plating operations. A small diameter wire is generally used and the low heat flux freeform wire-deposition process provides the ability to form the jacket in place while maintaining the geometry of the thin-walled channel lands or ribs minimizing overall distortion¹⁵.

2. Blown Powder Deposition

Blown powder deposition is being used in combustion devices, primarily nozzles, for forming near-final shape components with integral features such as liners, coolant channels, and manifolds, integrating these features into a single large scale build. Several other names are used to describe this technology, including directed energy deposition (DED), laser engineered net shape (LENS), laser freeform manufacturing technology (LFMT), Laser Metal Deposition (LMD), and direct metal deposition (DMD). These techniques are all similar in that powder is accelerated through a series of off-axis nozzles into a melt pool. The melt pool is created by the co-axial laser energy source causing a weld bead to be deposited. The powder is accelerated, or blown, into the melt pool using an inert carrier gas to allow for minimal or reduced oxidation in the high temperature deposition/weld. This system is attached to a robot that controls a toolpath defined by the CAD model. The blown powder system and robot allows for complex freeform structures to be built. Various optics can be used to vary the spot size, which control the size of features that can be built. NASA is working with industry partners to advance this technology, allowing for reduced feature sizes and limited distortion. Examples of the DED blown powder process being developed on nozzles can be seen in Fig. 5.

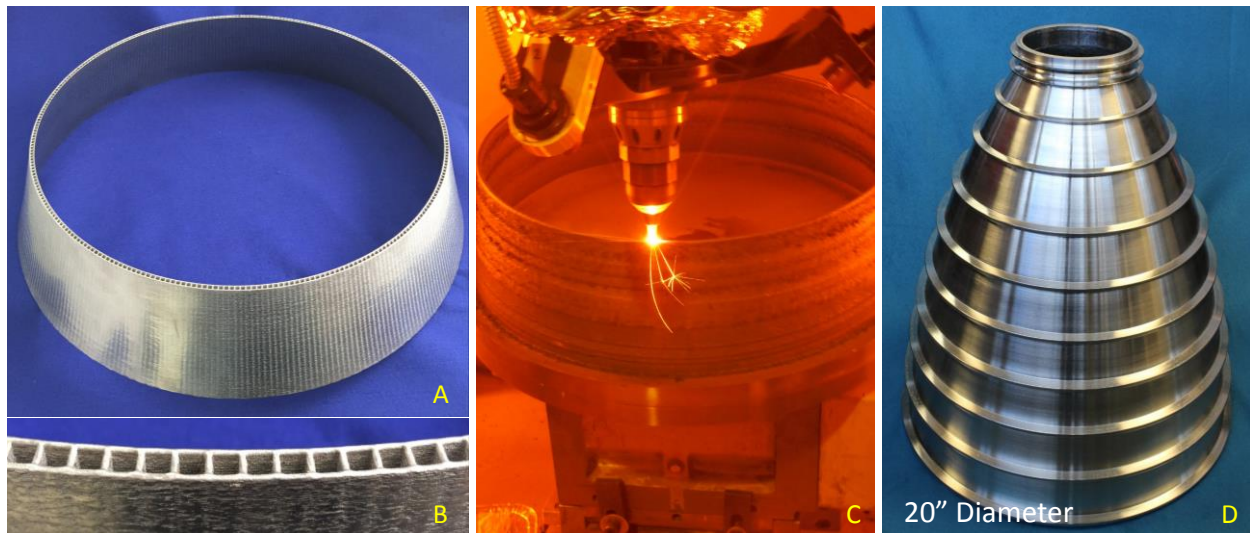

Figure 5. Nozzle feasibility demonstrator components fabricated with DED blown powder deposition – A. Channel wall nozzle MTD with integral channels, B. Integral Channels Fabricated , C. In-process DED fabrication of subscale nozzle jacket, D. Final-machined DED blown powder nozzle jacket.

An ancillary process to the blown powder deposition is the use of DED/CNC hybrid manufacturing or hybrid additive/subtractive techniques. This approach uses the blown powder deposition for the additive portion and subtractive machining capabilities within the same setup, allowing for tool changes between the techniques. This allows for integral features to be machined that would otherwise be inaccessible as an intermediate step during the blown powder additive process. The advantage of this is a single setup and ability to deposit more than one material. NASA is using this approach for a few components including augmented spark igniters and combustion chambers.

3. Arc-based Deposition

The wire arc-based deposition process is being used as a near-net shape preform of nozzle liners and nozzle and chamber jackets within combustion devices. MSFC has been working with Keystone Synergistic Enterprises to advance an arc-based deposition technique called Metal Direct Digital Manufacturing (MDDM) that uses integral sensors to continuously monitor the process. This is a similar technology approach to that being researched at Cranfield University called the Wire Arc and Additive Manufacturing (WAAM) technology for near net shape parts¹⁶. These sensors monitor the deposition process in real-time for bead geometry, temperature and part geometry to make corrections or identify anomalous build locations/features. The MDDM process has significant advantages, including high material deposition rates and large wire diameter.^{17,18} Material property testing has also been conducted and shown to meet the intended design requirements¹⁹.

MDDM arc-based additive manufacturing deposition technology uses a pulsed-wire metal inert gas (MIG) welding process to create near net shape components. The deposition head is integrated with a robot and turntable to freeform components from a derived toolpath. The toolpaths are developed to minimize porosity and allow for optimal properties. A series of integral sensor packages to determine material temperature, build geometry, and melt pool are integrated into the deposition system to allow for real-time inspection of the preforms as they are fabricated. The arc-based deposition process does not have the ability to fabricate precise features since it uses a larger deposited bead, so coarse features are typical of this type of deposition. An example of arc-based manufacturing is shown in Fig. 6.

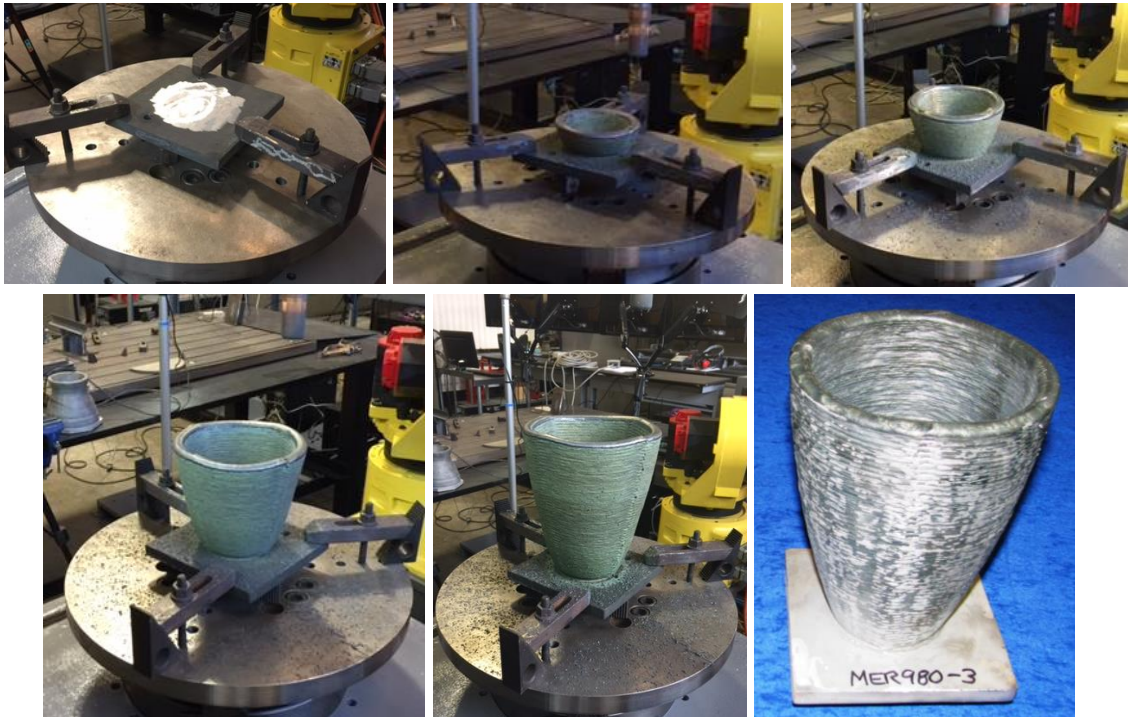

Figure 6. Arc-based Deposition Process for Subscale Nozzle Liner Fabrication.

4. Electron Beam Wire Deposition

NASA is using electron beam wire deposition for cladding of structural jackets on combustion chambers. Electron beam deposition or Electron Beam Freeform Fabrication (EBF³) is a wire fed technique, which has the highest heat flux but offers the advantage of operating in a vacuum chamber to prevent oxidation of materials, such as titanium and its alloys. Of the wire fed processes, the electron beam can be focused to achieve a smaller diameter melt pool, but still offers fairly high deposition rates (20-150 in³/hr)²⁰. This translates into the ability to deposit a smoother surface finish than other wire fed processes. However, operation in a vacuum chamber does limit the size of the build. Sciaky and NASA Langley Research Center (LaRC) are the developers of the technology.

II. Additive Manufactured Thrust Chamber Injectors

Conventional liquid propellant rocket engine injectors typically have a large number of individual piece parts that have individual design drawings, are individually fabricated and inspected, and then integrated into an assembly with heritage joining techniques such as brazing, bonding or welding. AM is especially attractive for reducing the cost of manufacturing injectors because of the simple math of avoiding having to deal with all the piece parts and their processing and assembling. Although this argument may apply more to coaxial element injectors than to impinging element injectors due to their higher part count, avoiding the substantial machining required for a ring manifold and multi-orifice injector faceplate in an impinging element injector, as well as the braze operation to join them, can provide a significant advantage as well.

AM techniques also make possible the ready manufacture of non-conventional manifolding schemes or element designs that would be difficult or impossible to produce with traditionally machined or assembled components, except possibly through the use of more advanced manufacturing processes such as diffusion-bonded fluidic devices (also known as “platelet” technology). Opening this enhanced design space has both advantages and disadvantages. Novel designs can provide significant improvements in injector performance, stability, and compatibility beyond just cost savings. However, such new designs with less heritage or pedigree may take additional cost and schedule to achieve development parity with more historical components.

Some of the specific disadvantages of using AM for injector fabrication, such as feature size resolution (especially radial to the build direction) and excessive surface roughness, are an active area of development within the industry and their influence has improved over time and can be expected to improve further. Another current disadvantage for the powder bed process in injector manufacture is the necessity to remove residual powder from internal passages where the part may have limited access. Removing all of the powder prior to heat treatments (even stress relief) is necessary because trapped powder can become sintered, making it difficult or impossible to remove later. For example, slurry honing has been and can be applied to remove surface effects, but obviously not open completely blocked passages. Thus, most injector passages currently must be relatively straight or have access to inlets and/or outlets for manual intervention to remove powder while the part is still attached to the build plate.

NASA MSFC began examining additively manufactured injectors in earnest in 2012. To date, all designs have been manufactured with powder-bed processes. Table 1 below provides a summary of the injectors that have been developed or are currently under development. Fig. 7 illustrates the range of AM injector hardware designed, built, and tested at the NASA MSFC.

One of the earliest AM injectors built and tested at MSFC was a small, 100 lbf class LOX/Propane injector. The design was created in support of a Nanolaunch (cubesat scale) program and included six swirl coaxial elements with a direct spark igniter. Due to the compact size of the hardware, several design concessions had to be made in order to make it buildable. For example, at this scale, the element fuel annulus gaps would have been too small to print while maintaining sufficient pressure drop across the faceplate, so the annulus was discretized into a number of individual orifices that surrounded the central LOX post. Also, because of the close proximity of fuel and LOX manifolds, the Pc port had to be routed through a convoluted path between these cavities, which proved to be fairly easy with the AM process. In order to independently control the fuel film cooling circuit, a partition within the fuel manifold was printed between the faceplate and the main cavity outer wall and given its own set of feed passages, something that would have been difficult and expensive to produce in a conventional design. All of this complexity was integrated into a 1-piece unit and tested with as-printed orifices. The only machining operations required on this part, after wire EDM removal from the build plate, were the addition of threads for the spark igniter and honing of the element LOX bores to reduce detrimental surface roughness effects on swirl momentum. Multiple injector units were built and two were successfully hot-fire tested, as shown in Fig. 8.

Table 1. Additively manufactured injectors developed at NASA MSFC.

Injector Program	Year	Propellants	Material	Elem. Type	# of Elem.	D_c (in)	P_c (psia)	Hot-Fire?	Ref.
Nanolaunch	2012	LOX /Propane	Inco 625	Swirl coax	6	1.125	130	Y	21
PC020B, C (1.2K)	2012	LOX/GH2	Inco 625	Shear coax	32	2.25	720	Y	27, 28
PD114 (20K #1)	2013	LOX/GH2	Inco 625	Swirl coax	28	5.66	1250	Y	22, 24
PE040 (20K #2)	2014	LOX/GH2	Inco 625	Swirl coax	40	5.66	1540	Y	23, 24
PF057, PG040, PF086 (35K AMDE)	2015	LOX/GH2	Inco 625	Swirl coax	62	7.5	1400	Y	25
PF037 (Methane 4K)	2016	LOX/GCH4	Inco 625	Swirl coax	40	6.6	175-335	N	26
PH127 (MET1)	2017	LOX/GCH4	Inco 625	Shear coax	32	3	350	Y	29
PG056 (LOX/ Methane Gas Generator)	2017	LOX/GCH4	Inco 718	FOF	20	1.8	1200	Y	30
CSTD ORPB	2018	LOX/RP-1	Monel K-500	Swirl coax	7	3.5	3000	N	-
RS-25 Oxidizer Preburner	2018	LOX/GH2	Inco 625	Shear coax	45-120	7.43	3000-5700	N	-

**Figure 7. Various SLM Injectors fabricated and tested at MSFC.**



Figure 8. Water Flow Test of Nanolaunch Injector (left); Hot Fire Test (right).

To evaluate both the structural and performance capabilities of AM in liquid rocket injector applications, two early test programs were initiated at NASA MSFC to directly compare the operating characteristics of conventionally manufactured 20 Klbf LOX/H₂ swirl coaxial element injectors to those of similarly designed SLM powder bed manufactured injectors.^{21,22,23} While some aspects of these AM designs required minor modifications to enable a successful build, the elements themselves were manufactured with the same critical dimensions as their conventionally manufactured counterparts, and then hot fire-tested in similarly sized combustion chambers to those used in earlier test programs. The AM process proved well-suited to injector fabrication, in some cases requiring only minor alterations to accommodate the new process. For example, in contrast to many conventional designs, the injector faceplates for these early builds were welded in place, rather than attached with threaded face nuts, due to the difficulty of machining threads into the element posts. Results of hot-fire testing showed characteristic exhaust velocity efficiencies (η_{C^*}) for the two different manufacturing techniques to be within measurement error.^{22,23,24}

Based on lessons learned during these pathfinder injector AM programs, a follow-on AM swirl coaxial element LOX/H₂ injector was developed for an MSFC in-house 35 Klbf engine technology development program focused on using as much AM technology as possible.²⁵ The injector included an AM core section (containing the elements, inter-propellant plate, fuel manifold annulus inner wall, and acoustic resonator cavities), LOX dome, and high frequency pressure transducer housings with integral GHe cooling circuits. The fuel manifold annulus was fabricated from a machined forging because it would not fit within the SLM build envelope. This injector also incorporated a novel LOX swirl inlet in which the flow passages were routed within the inter-propellant plate. This was done to simplify the design and represented a feature with AM that would not have been possible with traditional methods. Injector testing has been very successful to date, exhibiting stable combustion characteristics, excellent injector and chamber wall compatibility, and $\eta_{C^*} \sim 98-99\%$.²⁴ Fig. 9 shows a water flow test of the AMDE injector and subsequent hot fire test.

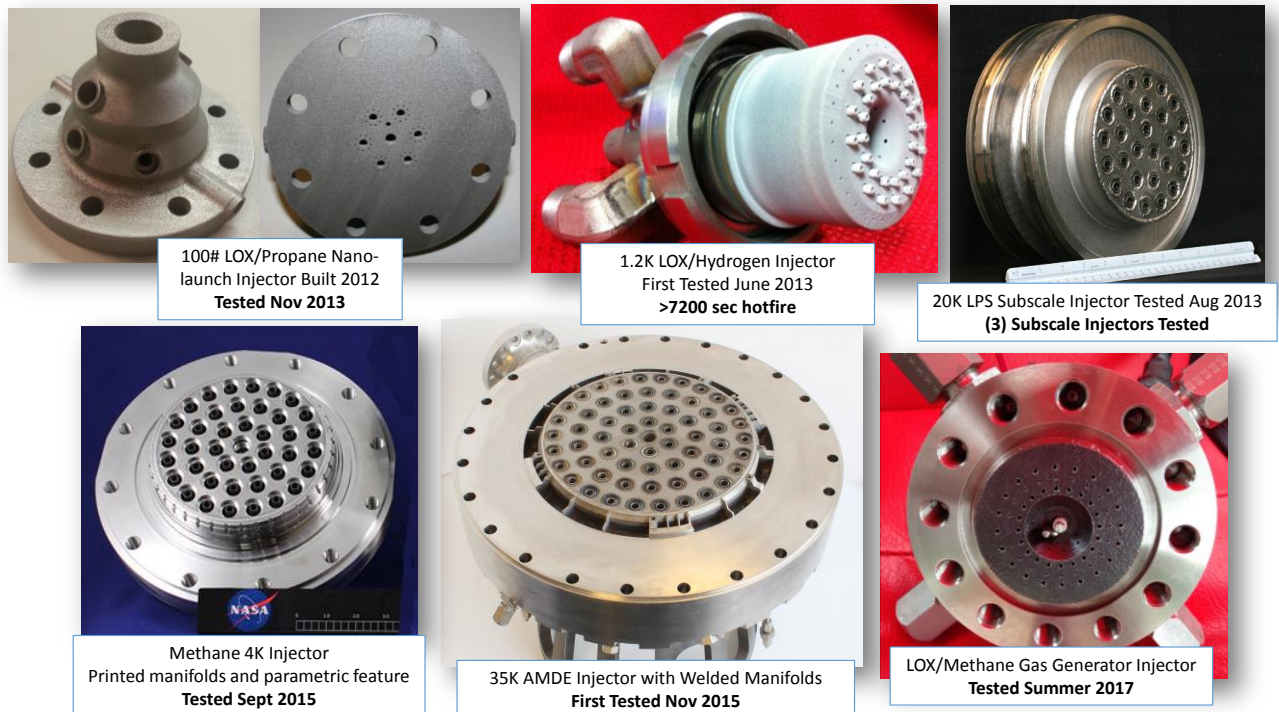
Injector development at MSFC has encompassed a range of element types (swirl coaxial, shear coaxial, impinging), propellant combinations (LOX/H₂, LOX/CH₄, LOX/C₃H₈), and thrust classes (100 lbf to 35K lbf) in an attempt to validate the use of AM in multiple applications.²⁶ While early testing was focused on the development of swirl coaxial elements, primarily due to the availability of existing swirl coaxial injectors with hot-fire test data for comparison, and the ease with which additional complexity could be incorporated without adding cost or engineering design time, shear coaxial and impinging element type injectors have also been successfully built and tested. MSFC has employed a conventionally-built, heritage 1200 lbf shear coaxial element injector for years, often used as a workhorse unit to generate hot gas environments for combustion chamber development testing. In 2012, an AM version of this same hardware was built and later hot fire tested with demonstrated performance closely approaching that of the conventional design.^{27,28} These injectors have accumulated over 7000 seconds of hot-fire test duration. A hot-fire test of a cluster of four engines is shown in Fig. 10.

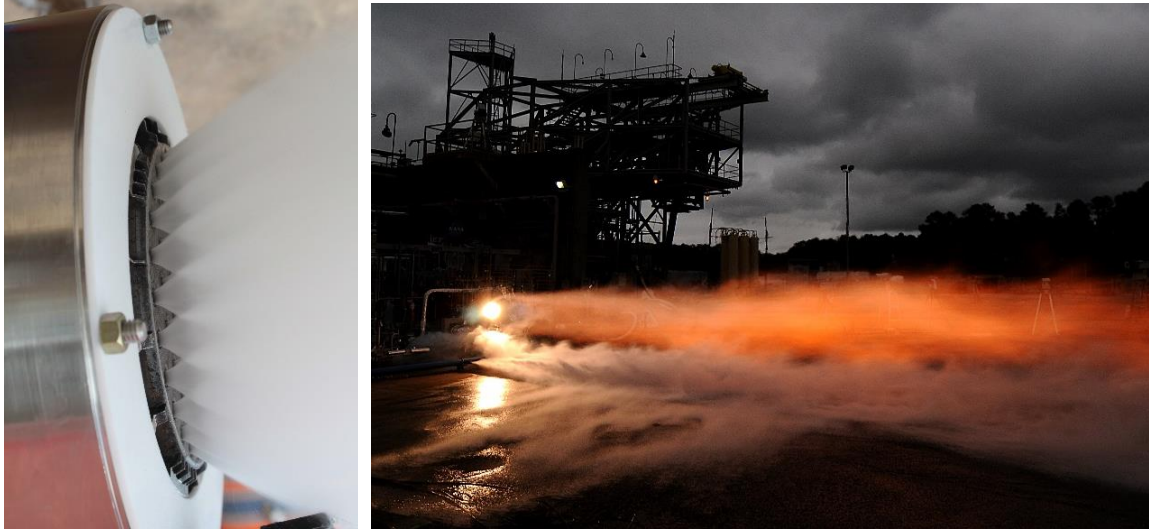

Figure 9. Water Flow of the AMDE Injector LOX Circuit; Hot Fire Test of the AMDE Injector.



Figure 10. Cluster of Four Thrusters with 1200 lbf Shear Coaxial Injectors.

Because impinging element injector operation is affected by dimensional inaccuracies and stream misalignment, the ability to print these injectors successfully has proven more difficult than for those with coaxial elements. While one option is to print the majority of the injector, then final machine the impinging orifices, MSFC has built and tested a fully-AM impinging injector for use in a 22-Klbf LOX/CH₄ gas generator application.^{29,30} This injector included printed element orifices in an FOF arrangement with a direct spark ignition system. Photographs of a water flow of the injector pattern and a hot-fire test are shown in Fig. 11. Testing demonstrated acceptable operation with good temperature uniformity, although measured performance was less than anticipated. An adjustment to element orifice size is expected to resolve the performance concern.

Two AM injectors are currently in development at the NASA MSFC, listed as the final two entries in Table 1. The first is to be used for an oxidizer-rich preburner in a 10-Klbf thrust liquid oxygen and RP-1 propellant oxidizer-rich staged combustion research and development program with the Air Force Research Laboratory. The second is part of a very early feasibility study to replace the oxidizer-pump preburner in the RS-25 engine.

Development at the NASA MSFC has found that AM is well suited to injector fabrication, although heritage designs may need to be adjusted to accommodate limitations imposed by powder bed fabrication. Traditional injectors have employed geometries designed to be built by joining multiple parts created by subtractive-type machine tools. Such designs may not translate well to manufacture with AM methods, but perhaps they shouldn't. Future AM injectors, perhaps based on heritage designs but perhaps not, can and will be found that produce similar results given some designer creativity.



Figure 11. Water-flow of FOF element injector for a LOX/CH₄ Gas Generator (left); Hot-fire test (right).

Additive Manufactured Combustion Chambers

NASA MSFC has developed several additive manufactured channel-cooled combustion chambers from 2013 to present. Chambers have been constructed using the Selective Laser Melting (SLM) powder bed additive manufacturing (AM) technique, but incorporate bimetallic additive and hybrid techniques. The materials used for the chambers has varied from Inconel 718, Inconel 625, Monel K-500, GRCo-84, and C18150 metal alloys. The build techniques used to successfully manufacture combustion chambers using the SLM AM result in a rough as-built surface finish (compared to traditional machining) and off-nominal geometric features. The thrust chambers designs tested ranged from 200 to 1,400+ psia in a variety of propellants and mixture ratios, producing 1,000 to 35,000 lbf thrust.

The NASA Low Cost Upper Stage Propulsion (LCUSP) project developed copper-alloy GRCo-84 (Copper-Chrome-Niobium) using additive manufacturing, specifically SLM³¹. This NASA-led project has matured the process significantly and also made process parameters and characterization data available to industry to enable commercial supply chains. Several industry partners have continued to advance the GRCo-84 material in addition to exploring other copper-alloys such as C-18150, C-18200, C-18000 and Glidcop.

GRCo-84 was developed at GRC as a non-heat treatable copper-alloy for reusable combustion chambers that increases strain and fatigue capabilities over traditional copper-alloys. GRCo-84 has been an ideal material suited for the SLM processing. Through a variety of complementary projects to the LCUSP program, NASA has designed, developed and tested combustion chambers using the SLM process and captured significant lessons learned³².

NASA has completed a series of chambers developed for Liquid Oxygen (LOX)/Hydrogen and LOX/Methane and completed hot-fire testing of these various units accumulating over 100 starts and 6,000 seconds of test time. A summary table of combustion chambers fabricated using this process is provided in Table 2.

From experience, the two main adjustments to the design process for AM SLM regenerative cooling chambers reside in accounting for the minimum feature size that can be reliably built using the AM SLM process and the resultant surface finish³³. There are also complex geometric features that could not be previously manufactured including integral coolant channels that are not limited to traditional cutting tools such as slitting saws and end mills.

The first actively cooled AM chamber fabricated at MSFC for a test program was a simple Inconel 625 spool section (designed for approximately 1000 lbf thrust applications). It was tested at MSFC in 2013 with water cooling, and although it worked well, the resulting channels and surface finish produced a coolant pressure drop much higher than desired. Yet, the AM fabrication process required a significantly shorter schedule than traditional techniques and eliminated the need for a separate coolant channel closeout process, so interest continued and a larger chamber component was pursued.

Table 2. Summary of Additive Combustion Chamber Hot-fire Testing.

Chamber Component Description	Propellants	Additive Process	Material	Starts	Hot-fire Time (sec)
1,000 lbf SLM Chamber Demonstrator, PD061	LOX/GH2	SLM	Inco 625	3	17
4,000 lbf LOX-Methane Regen Thruster, PF037-1	LOX/LCH4	SLM	Inco 718	5	16
4,000 lbf LOX-Methane Regen Thruster, PF037-2	LOX/LCH4	SLM	GRCop-84	3	11
1.2K lbf Slip Jacket Liner Cyclic SLM Chamber, PG034	LOX/GH2	SLM	GRCop-84	25	2365
Methane Engine Thrust Assembly 4K (META4), PG055	LOX/LCH4	SLM	GRCop-84	4	26
Methane Engine Thruster for 1K lbf (MET1), PH127	LOX/LCH4	SLM	GRCop-84	5	30
1.2K Slip Liner for Channel Wall Nozzle, PH034	LOX/GH2	SLM	GRCop-84	19	1805
C-18150 Slip Jacket 1.2K Liner, PH171	LOX/GH2	SLM	C-18150	10	1443
Low Cost Upper Stage Propulsion 35K, PF086	LOX/GH2	SLM/DED	GRCop-84 / Inco 625	12	147
META4 4K lbf #2, PH135	LOX/LCH4	SLM	GRCop-84	17	141
META4x4, PI051 [Ref 34]	LOX/LCH4	SLM	GRCop-84	9	116
			TOTAL	112	6117

A. Methane Engine SLM Thrust Chamber Development

Using Inconel 625, a much larger (4000 lbf thrust) chamber throat section was created with AM, which allowed the design to incorporate pressure and temperature ports along the length of one coolant channel to gather critical data for thermal models. The hardware was successfully cooled, first with water, then later with liquid methane during hot-fire testing in 2015, as shown in Fig. 12. The test program primarily was used to gather heat load data for a specific LOX/methane injector. Since it performed so well, an identical unit was fabricated with AM using GRCop-84, as shown in Fig. 13. This throat section was successfully cooled with liquid methane during its testing in 2016 and further allowed thermal models to be developed to characterize two-phase flow, which occurred during the subcritical coolant's phase change.

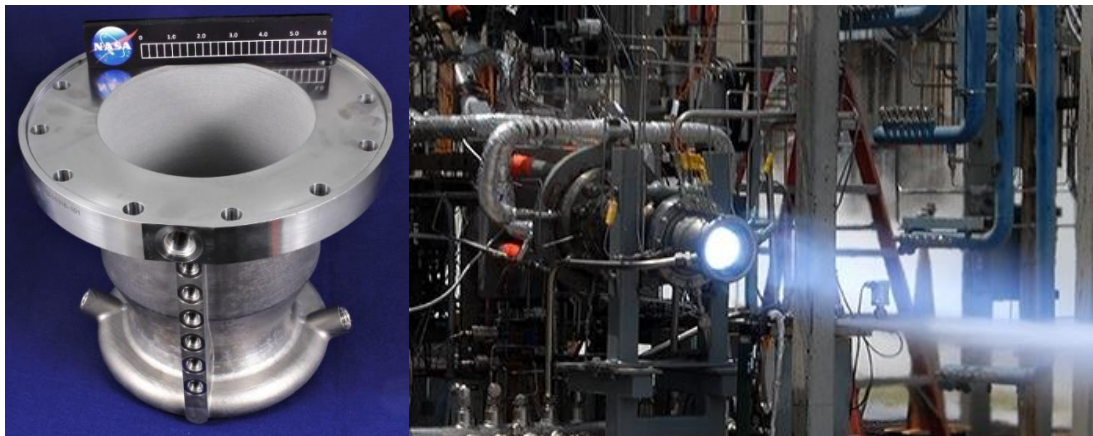

Figure 12. LOX/Methane Hot-fire Testing on AM Inconel Chamber Throat Section (2015).

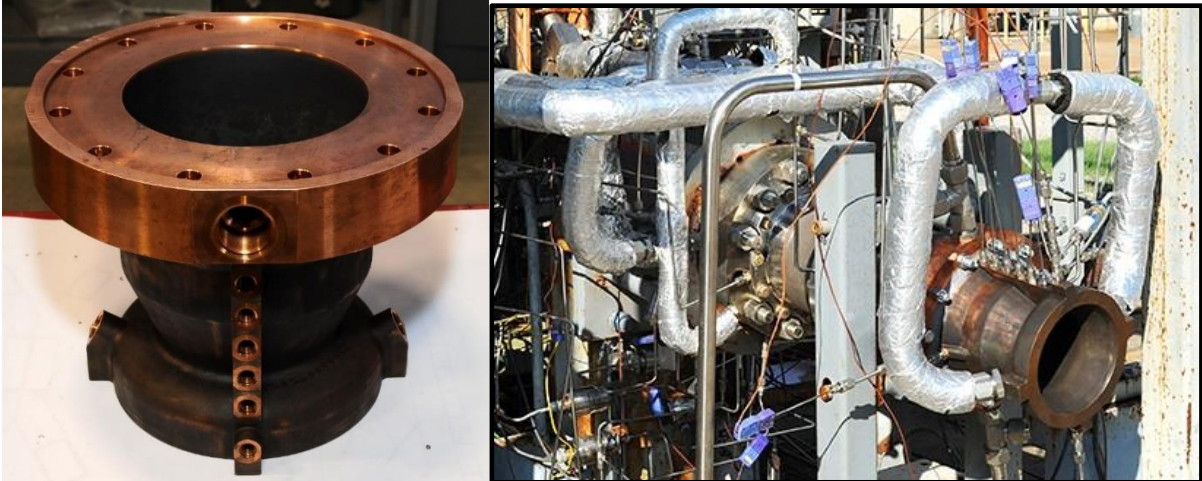

Figure 13. LOX/Methane Test Assembly with on AM GRCop-84 Throat Section.

Using the test data from the AM Inconel and GRCop-84 throat section chambers, a full-length, regeneratively cooled chamber was designed and fabricated for META4 – Methane Engine Thrust Assembly for 4 Kibf, which was developed to provide new technology for LOX/methane in-space engine applications. Due to the required length of the design, it had to be fabricated in two sections with a joint in its mid-section. In the first META4 chamber unit, this mid-section joint was welded together (in a manner similar to the chamber developed for LCUSP), along with a split-ring manifold that allowed the coolant from the throat section to cross-over into the chamber's barrel section. Coolant flow continued in the barrel section channels, providing gaseous methane directly to the injector. Fabricating the META4 chamber with AM also allowed inclusion of critical flow features not possible with traditional manufacturing.

This first unit performed very well in hot-fire testing in 2017. The chamber on the test stand and during a hot-fire test is shown in Fig. 12. High mixture ratio conditions, along with intentional tests to reduce the chamber coolant flow rate, confirmed the high thermal margin available with GRCop-84. Also, the channel restrictions appeared to prevent any flow oscillations from occurring on the fuel side of the system.

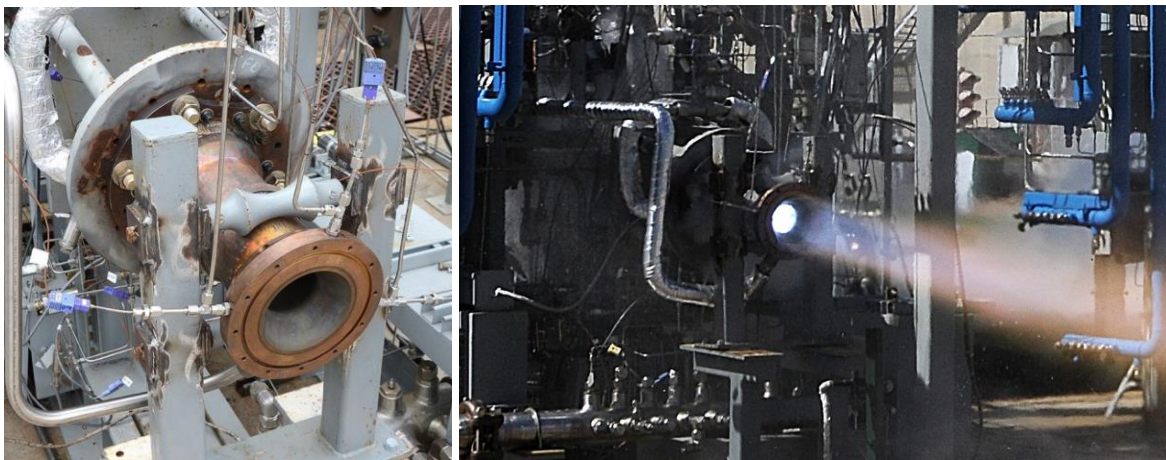

Figure 14. Hot-fire Testing on META4 #1 (2-piece full length GRCop-84).

In META4's second chamber design, the number of welds in the assembly was reduced by replacing the welded mid-section joint with a bolted/sealed joint. Design modifications eliminated all but two welds in the assembly. The new joint also made the hardware easier to fabricate with AM and reduced the required post-processing machining. When META4 #2 was tested in 2018, it performed very well, with high performance and stable flow conditions. Active throttling was also performed and flow on the fuel side of the system remained very stable. The first and second META4 LOX/CH₄ units can be seen side by side in Fig. 15, and during throttled testing in Fig. 16.

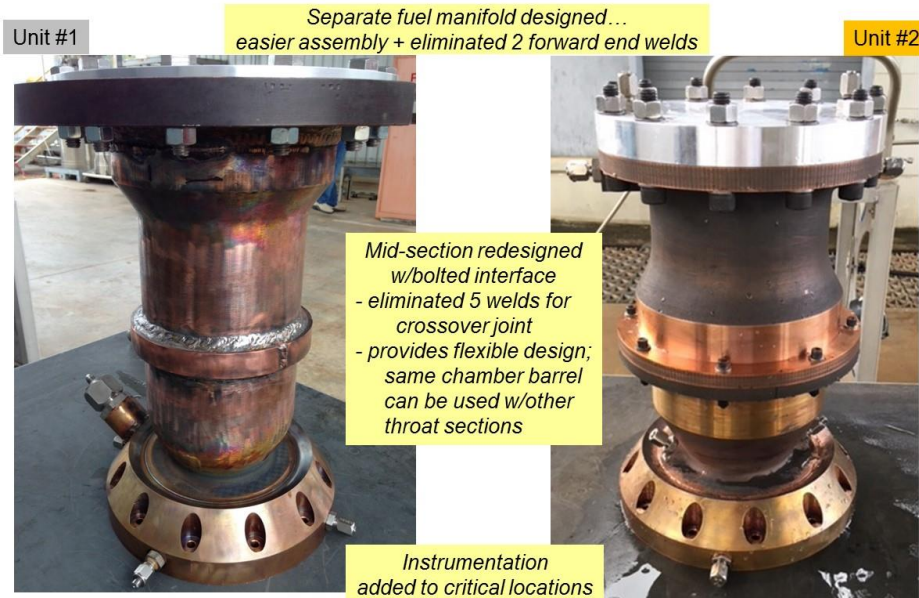

Figure 15. Comparison of META4 #1 and #2 Chambers.

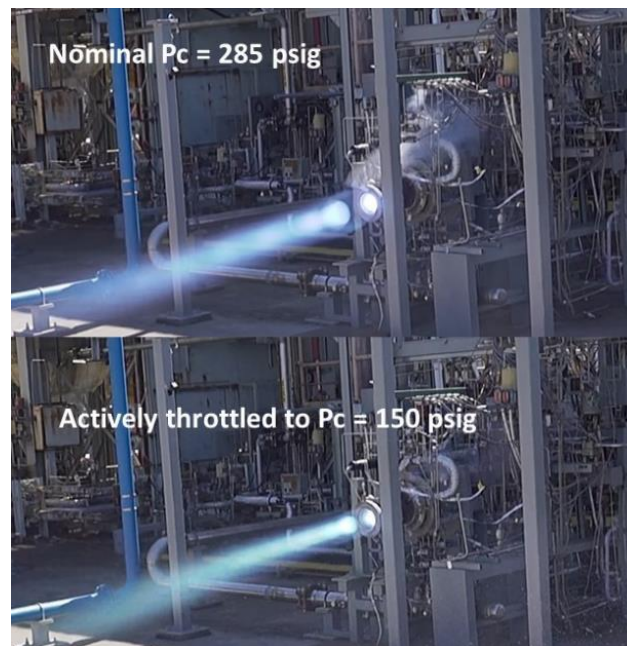

Figure 16. Active Throttling Successfully Demonstrated on META4 #2.

META4 chamber #3's design is exactly the same design as #2, and is planned for hot-fire testing in Summer 2018. It's performance is expected to be the same as unit #2. It's being used to evaluate the operation of compact engine valves for a potential lander engine system.

The design for the META4 chamber was scaled down in size to create META4X4, which offers the same thrust level but in a smaller package. Specifically, the chamber diameter was reduced by 30% offering a chamber size that's more appropriate for 4000 lb_f thrust. The design features for META4X4 remained similar, with local channel features to maintain stable fuel flow and a bolted/sealed mid-section joint. This chamber was also successfully hot-fire tested in 2018 and provided high performance, along with stable flow, even during active throttling shown in Fig. 17.

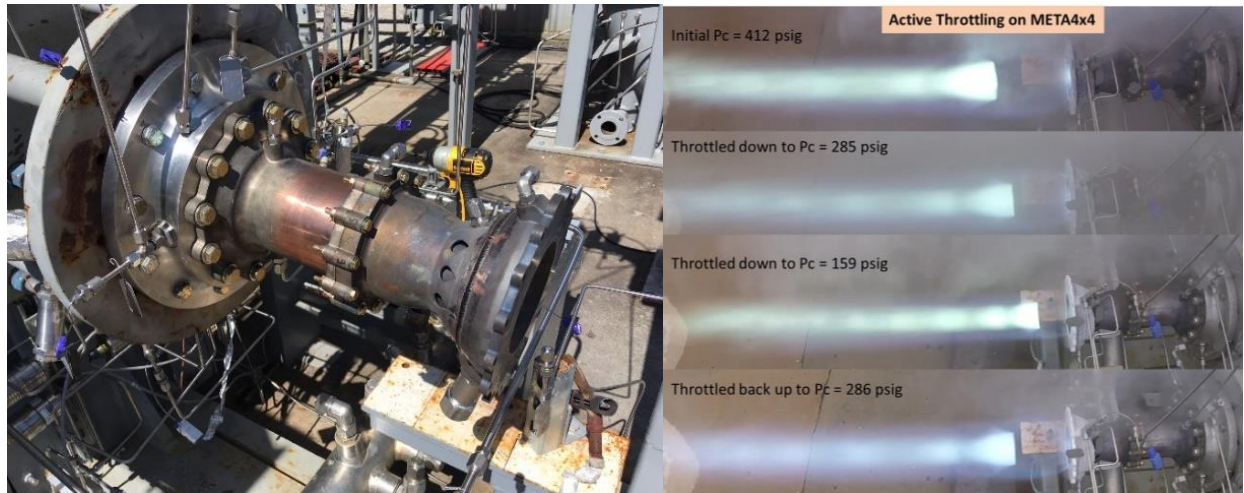

Figure 17. Hot-Fire Testing on META4X4.

The META4 design was further scaled down in size to create the Methane Engine Thruster for 1000 lbf (MET1). MET1 can be used for smaller in-space missions, or it can be clustered together to provide multiples of 1K lbf thrust. Because of its smaller size, the full length of the chamber body could be created by AM – no mid-section joint required. Only one weld was required to attach the AM inlet manifold. Both the body and the inlet manifold were fabricated with GRCop-84. The manifold was printed onto the chamber body as well, but making the manifold separate was found to allow easier access to the coolant channels on the body to remove powder and verify acceptable flow. Channel features similar to META4 and META4X4 were included in MET1 to prevent unstable flow.

The first MET1 chamber was successfully hot-fire tested in 2017. Its coolant flow remained stable, but the fuel did not heat up as much as desired, so the mating injector did not perform as well as expected. To increase the chamber heat load, a modified MET1 chamber is currently being printed with a scalloped hot wall. Compared to the smooth hot wall surface on all previous AM GRCop-84 chambers, this hot wall creates more heated surface area in the chamber for the regenerative cooling to pick up more heat. The AM process made changing the surface profile of the liner simple, so the design change and fabrication was completed rapidly. Hot-fire testing of this new unit will be completed in 2018 to confirm the results. Additional versions are also being fabricated.

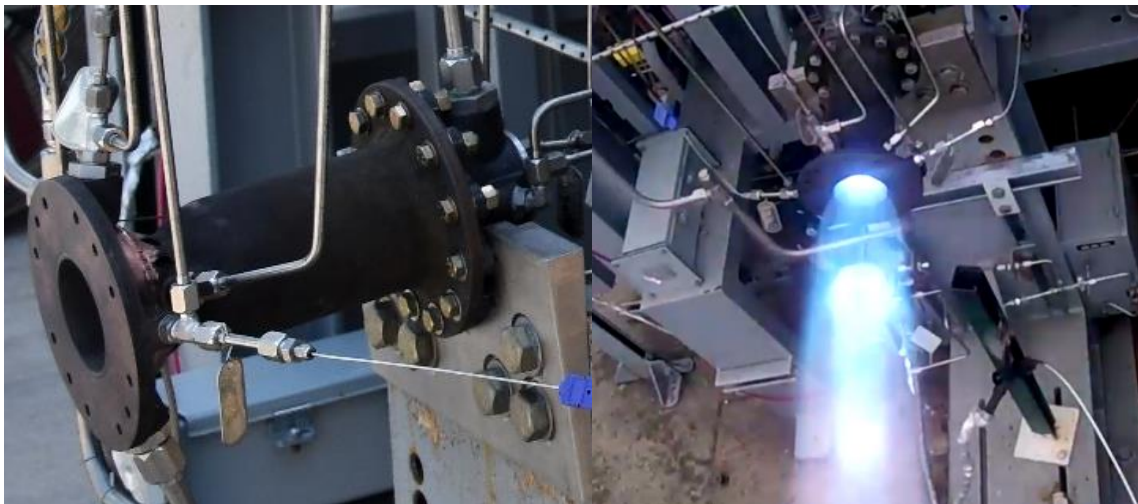

Figure 18. Hot-Fire Testing on Original GRCop-84 MET1 (1K-lbf thrust).

While META4, META4X4, and MET1 have been developed with funding from LOX/methane engine programs, their design features could be easily modified to produce components for LOX/hydrogen systems. Also, while design features have been scaled from META4 to lower thrust levels, they can also be scaled up to produce components applicable to higher thrust levels. Several LOX/methane chamber iterations completed hot-fire testing, and

improvements in surface finish during the SLM process demonstrated 60% less pressure drop than predecessor SLM chambers using two-phase subcritical liquid methane cooling.

B. Workhorse SLM Chamber Development

NASA completed a series of SLM workhorse chamber liners used in several component development programs. A total of three (3) chambers were tested that included two manufactured from GRCop-84 and one from C-18150. The two GRCop-84 chamber liners were fabricated on different machines with different build parameters. The objective of these chamber liners was to provide a simplified test bed to allow liners to be rapidly changed to demonstrate various materials as SLM is being evolved and other components such as regen nozzles and nozzle extensions were being developed. The initial chamber developed as part of this configuration was GRCop-84 and designed for water-cooling and LOX/GH₂ propellants. This is considered a 1,200-1,500 lb_f workhorse chamber, based on the heritage design used in PC020C test series and tested with Carbon-Carbon nozzle extensions^{35,36}. The chamber assembly is shown in Fig. 19.

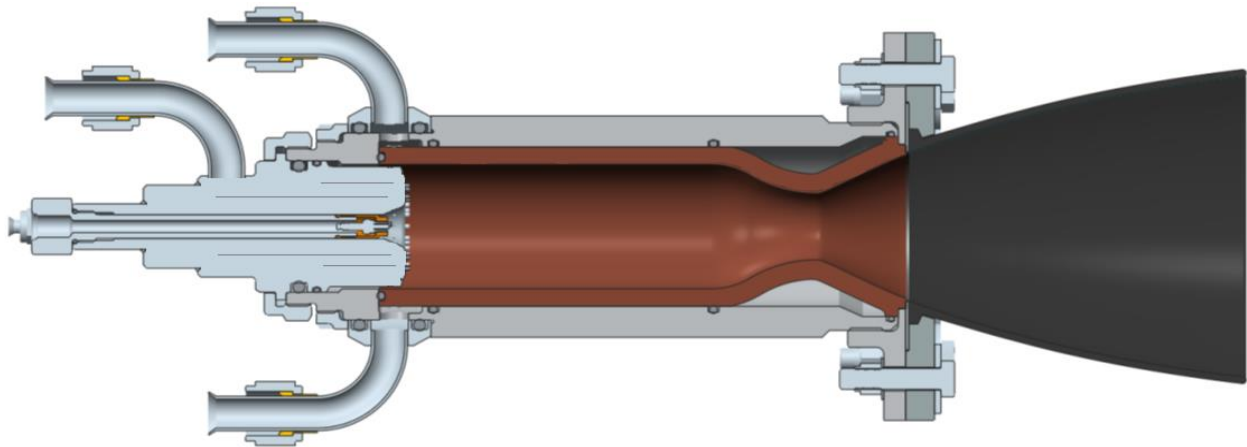

Figure 19. 1.2K lb_f Thruster with Additively-Manufactured GRCop-84 Liner and C-C Nozzle Extension.

This assembly allowed for easy change-outs of the chamber liner, if necessary. The liner was water cooled and a series of O-rings were used at the forward and aft end to seal the liner into the housing. A retaining ring on the aft end held the liner in place. The first liner was fabricated on MSFC's Concept Laser M2 AM SLM machine and fully closed-out providing inlet and outlets for each of the channels.

The pressure drop on the initial chamber liner was higher than predicted during this testing and was attributed to elevated surface roughness of the cooling channels from the AM SLM process. The AM GRCop-84 liner remained in excellent condition throughout this test program, however. It suffered no observable erosion anywhere in its hot wall surface. Testing accumulated 2365 seconds of hot-fire time and 25 starts on this material³⁷. The condition of the chamber wall at the conclusion of this test program is shown in Fig. 20.



Figure 20. 3D Printed GRCop-84 Combustion Chamber liner with 2365 seconds accumulated.

A second liner, identical in configuration, was fabricated at a commercial vendor, ASRC Federal Astronautics (AFA) in Huntsville, AL for a follow-on test program. The liner fabricated by AFA had approximately 50% reduction in surface roughness indicated by profilometer and optical measurements, which resulted in a >20% reduction in coolant pressure drop with identical channel configuration using water cooling. The liner remained in excellent condition with no visible erosion. In two tests, an odd signature in the plume during the startup transient was observed in the video, but no erosion was noted. This was not present in the other test during startup or seen in previous tests. Although there were various color signatures, there was some tint of green. This could have been minor amounts of residual powder from the ID surface loosening or superficial erosion that was not detected from visual inspections. This liner accumulated 19 starts and 1,805 seconds³⁸. Destructive evaluation of liners is now being conducted to fully characterize the as-built condition.

The third liner was fabricated using C-18150 (Copper-Chrome-Zirconium) and completed all necessary solution and aging heat treatments following HIP operations, prior to testing. The C-18150 material was attractive due to reduced powder cost compared to the GRCop-84 at the time of this development program. The C-18150 liner was fabricated at Moog Additive Manufacturing (East Aurora, NY), formerly Linear AMS (Livonia, MI), and was tested to compare its thermal performance with the GRCop-84 units³⁹. This liner had the same dimensions and design as the prior GRCop-84 liners. There was no erosion or oxidation observed and the liner remained in excellent condition even with aggressive wall temperatures. The C-18150 liner accumulated a total of 1443 seconds and 10 starts. The C-18150 and GRCop-84 liners are shown in Figure 21.



Figure 21. GRCop-84 Liners post-SLM (Left) and C-18150 Liners Post-SLM and Heat Treatment (Right), 2nd from left not grit blasted.

All 1.2 Klbf workhorse liners were tested in LOX/GH2 and were water-cooled. Testing demonstrated that the SLM manufacturing process for copper-alloys GRCop-84 and C-18150 is feasible for chamber liners with integral channels. The objective of these liner tests was to complete cyclic testing on the material and demonstrate the SLM lifecycle. The liners were successfully tested and did not show any indications of erosion even with wall temperatures well above 1000 °F. Pictures from hot-fire testing of these liners is shown in Fig. 22.



Figure 22. Hot-fire test of GRCop-84 chamber (Left) and, Hot-fire test of C-18150 Chamber Liner with OATK Carbon-Carbon Extension (Right).

C. Bimetallic Additively Manufactured Combustion Chambers

NASA has completed additively manufactured chamber development using bimetallic processes. The Low Cost Upper Stage-Class Propulsion (LCUSP) Project was a 4-year project within the Game Changing Development Program Office of the NASA Space Technology Mission Directorate to enable this technology. It was a NASA multi-center project including MSFC, GRC, and Langley Research Center (LaRC). LCUSP developed AM technologies specific to regeneratively cooled bimetallic chambers for LOX/LH₂ systems. Nominal thrust of 35,000 lbf was targeted.

Although AM was currently being used for other industries, at the time of initiation of LCUSP, very few rocket specific materials and applications were widely available. The limited amount of thrust chamber materials and processes for thrust chamber assemblies left room for development for NASA's particular applications. Under LCUSP, processes for SLM manufacture of the GRCop-84 copper-alloy, and EBF³ of Inconel 625 were developed and utilized to fabricate a full scale bimetallic additive manufactured test article that was successfully tested demonstrating the technologies. Additionally, materials characterization was performed on these additively manufactured alloys and the bimetallic joint interfaces. This project was actually the precursor to the previous GRCop-84 chambers described earlier.

One challenge for SLM technology in this application was that the build height of the SLM machines utilized in LCUSP was not large enough to build the entire chamber in one piece. A two-piece chamber with an electron beam (EB) welded joint and a mid-chamber coolant manifold was incorporated. Coolant entered the aft manifold and flowed through coolant passages. The coolant then flowed through into the mid-chamber manifold where the two halves were joined, and then back into the coolant passages in the cylindrical section of the chamber and then into the coolant outlet manifold at the head end of the chamber. Fig. 23 shows the completed unit installed in Test Stand 116 at MSFC. A general process flow was described in previous papers and test reports^{40,41}.

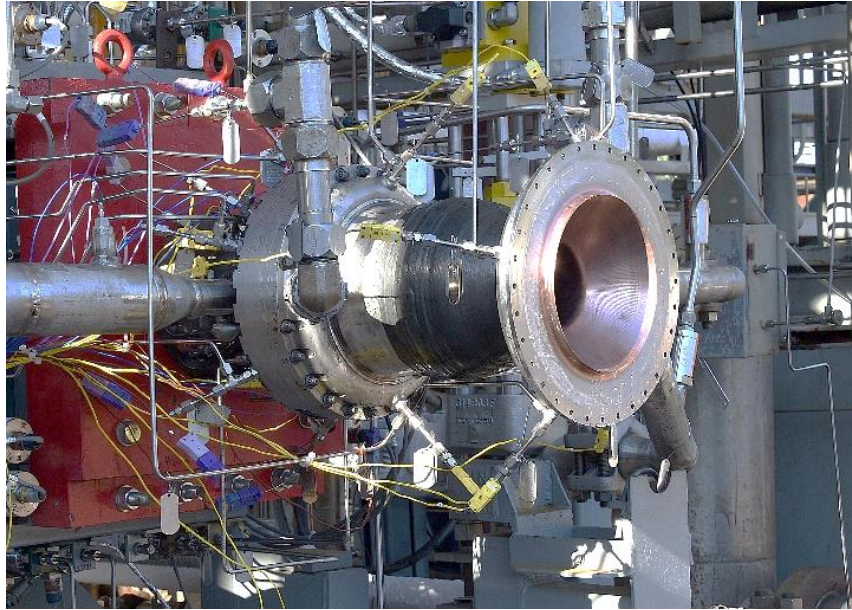

Figure 23. LCUSP Unit 3 Installed in the MSFC Test Stand 116.

The early risks in meeting the requirements centered on the development of the powder SLM process. Subsequent risks were the effects of the typical SLM surface roughness on the coolant side heat transfer coefficient, and the printability and powder removal of features in the size range required for the design.

Once the desired conditions were set, the surface roughness effects were evaluated. A typical roughness based on measurements during process development was utilized and the planned test conditions evaluated. As the conditions were evaluated, the results indicated that for a hydrogen-cooled chamber in this thrust class, the Reynolds number in a range such that some roughness was beneficial for heat transfer – i.e., adding more capability to remove heat than lost in pressure drop. As Reynolds number and roughness continued to increase, however, pressure loss increases without much benefit on heat transfer coefficient. The LCUSP channels were sized such that the pressure drop was expected to be in line with the requirements for a traditionally manufactured thrust chamber by adjusting channels and later confirmed with hot-fire testing. The measured delta P was only 6% lower than the as-designed delta P. In LCUSP, since it was fabricated with AM, the transitions between the two widths were tapered from one width to the other linearly over a short span.

Once the process was developed and as the initial design was underway, the team became aware of historical lessons learned from SLM fabrication. Therefore, early builds consisted of wedges of the more complex geometries that would need to be printed. These wedges demonstrated that features were printable before the team committed to full builds of chamber halves. Additional trial pieces were also printed to characterize the coolant passage feature sizes that would result from a certain model geometry.

As SLM parts are typically printed in a full bed of powder, the powder must be removed from internal passages after the build completes. While this was considered a risk early on, because of the two-piece design of the LCUSP chamber, powder clearing was accomplished very quickly. Water flow testing was performed to visually confirm that all channels were cleared by the gas flow and any powder removal could be completed before continued operations. Some designs previously described included SLM printed manifolds, and powder removal in these cases was more difficult.

Structured light scanning was used as the parts flowed through the entire processes. Scans later in the process flow demonstrated how the liner I.D. moved as further processes (HIP and EBF³) were completed. HIP of the SLM liners resulted in nearly no movement, while the EBF³ process had two interesting results. The inner radius of the liner shrank a noticeable amount, and the exit diameter of the throat spool expanded outward. Both results indicated that significant stress was accumulated in the part through EBF³ processing. The throat contraction had little effect on the test objectives of the LCUSP demonstrator parts and could be accommodated in future units. The aft end movement was more concerning from an interface view and from the manifold failures discussed below. This movement was mitigated in later builds as the process flow was changed to reduce the amount of Inconel deposited to the part in the throat section and at the manifolds by switching to machined forged close-outs for the manifolds.

As the required chamber length exceeded the build box dimensions of the SLM machine utilized for fabrication of these parts, a method of joining the two chamber halves had to be developed. An Electron Beam (EB) weld was selected, as the parts would be in LaRC's EBF³ machine for deposition already. The LaRC developed process parameters for the EB weld of SLM GRCo-84, and demonstrated them on SLM trial rings. This also resulted in process efficiencies as the parts were then already on the mandrel and ready for the next phase, Inconel jacket deposition, as soon as the EB beam weld was complete at the halves,. Following the EB welding, the units completed EBF³ deposition as seen in Fig. 24.

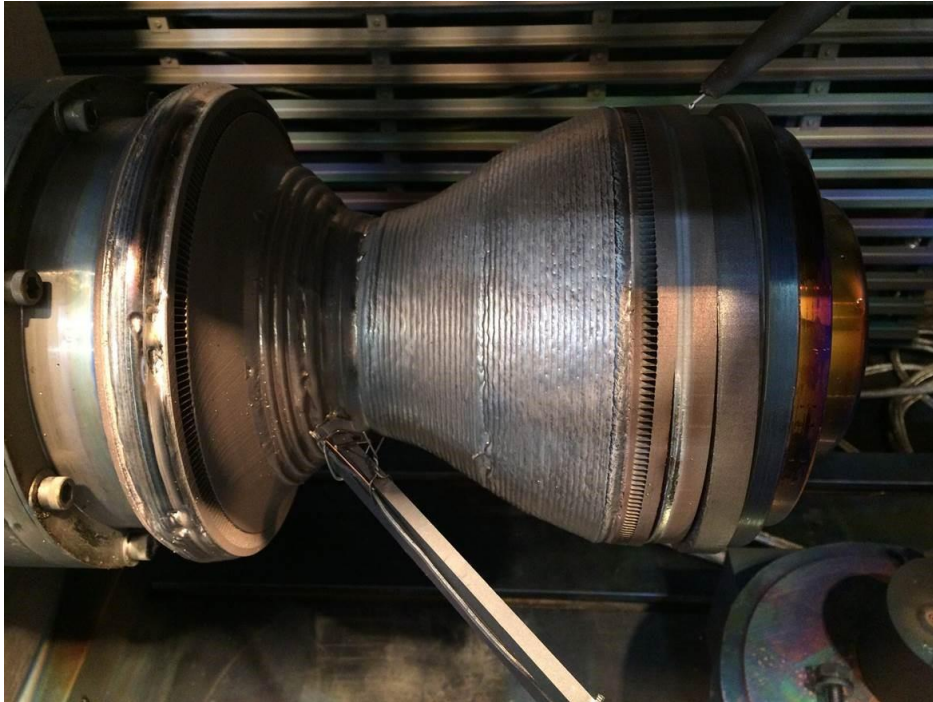

Figure 24. Development LCUSP Unit Between EBF³ Deposition Steps.

On the first development unit, the forward end successfully bonded on both sides of the manifold joint, but due to complications in aligning the EBF³ head to the chamber end contour, the aft end EBF³ deposition did not penetrate into the liner. Based on this experience, process changes to realign the head to the parts were made for the second development unit and it was processed. Unfortunately, after the Post EBF³ HIP cycle and after the parts were shipped to MSFC for inspection and subsequent transfer to the machining vendor, the aft-most and forward-most bond joints were found to have both failed. In response, the team developed a fabrication plan that included new copper builds and EBF³ deposition steps. Additional SLM development units were completed and demonstrated a successful process. A shortened unit and full-length unit (Unit 2.2 and Unit 3, respectively) were fully fabricated and both were successfully tested.

A summary of the cost and manufacturing time is shown in Fig. 25. The cost and schedule of fabrication of an identical scale traditional chamber manufactured utilizing electro-deposited Nickel to close the machined coolant passages is shown along with the timeline for the full scale LCUSP chamber. While AM manifolds were originally planned, they were not utilized on the full unit. However, even with conventionally machined manifolds, LCUSP still offers significant savings of >50% in schedule and >25% in cost. Further cost and schedule savings could be achieved in the future since development work has been completed and the process has become more mature.

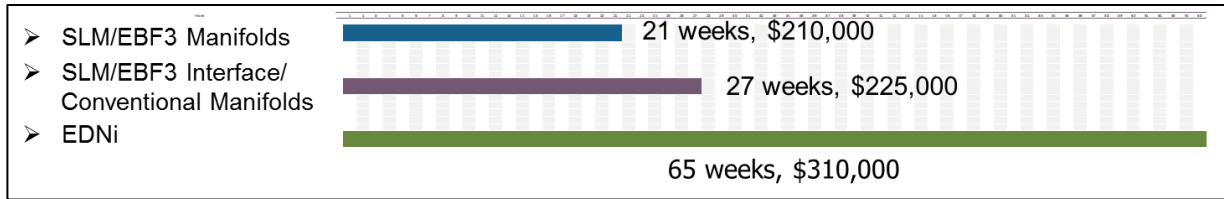

Figure 25. Comparison of Schedule and Cost of Chamber Options.

All LCUSP development hot-fire testing was conducted at the “40K” Position on Test Stand 116 in the East Test Area at the NASA MSFC. This position supplied cryogenic oxygen and conditioned hydrogen (a controllable mixture of liquid and gaseous hydrogen) in pressure-fed configurations from high pressure tanks. Flow rates for all propellants and chamber coolant to the test article were controlled with cavitating venturis in the LOX side and sonic venturis in the fuel side. Shut-off valves downstream of the venturis provided for initiating and terminating flows to the test article. The existing AMDE SLM injector, described earlier and shown in Figs. 7 and 9, was used to deliver propellants to the chamber in this program. This injector was also used on other SLM subscale injector tests conducted at Test Stand 116 at MSFC, as also previously described. An existing Compact Augmented Spark Igniter (ASI) was used in the test configuration.

The LCUSP test program was conducted at Test Stand 116 from October 2017 through March 2018. Fig. 26 provides an image of one of the hot-fire tests in this program. Both the full length chamber (Unit 3) and shortened chamber (Unit 2.2) were tested in the program. The copper-Inconel joint performed well, indicated by the successful hot-fire test campaign including the cryogenic shock during startup. Unit 3.0 had some erosion in the coolant channels due to blockage caused by the manufacturing process. This blockage was removed, and Unit 3.0 successfully tested again after the repairs. Ten mainstage tests were conducted at varying power levels for a total hot-fire time of 147 seconds combined between the two units. A graphic of the LCUSP TCA assembly and hot-fire test picture is provided in Fig. 26 and Fig. 27.

The LCUSP hot fire test program completed all project hot-fire testing milestones and concluded in March 2018. Testing demonstrated the key manufacturing technologies in a relevant environment, taking the additively manufactured LCUSP chamber and the one piece additively manufactured cooled nozzle to 100% of design conditions. Testing provided excellent data on articles manufactured with these technologies and even successfully demonstrated a chamber repair made after blocked cooling passages were discovered after initial testing. LCUSP has transferred the additive manufacturing process using GRCo-84 developed at MSFC and the materials property data collected by GRC to industry for use for government and commercial space development programs.



Figure 26. Hot-fire Test TCA Configuration with LCUSP Unit 3, INFCR, and Carbon-Carbon Nozzle Extension (Left) and TCA assembly during mainstage test (Right).

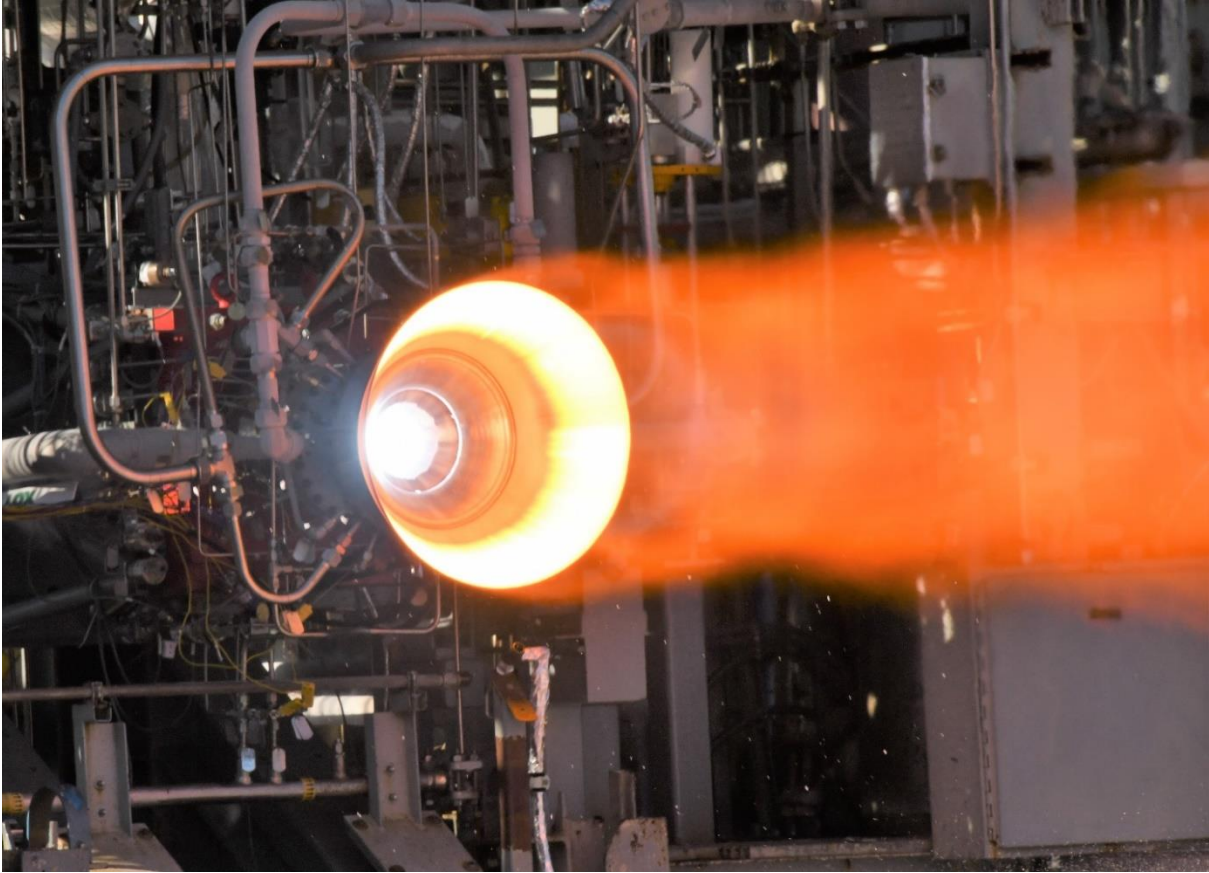

Figure 27. 100% Powerlevel of Short Unit with Carbon-Carbon Nozzle Extension.
[Courtesy of David Olive MSFC/ET10]

Additive Manufacturing for Channel-Cooled Nozzles

NASA has been investigating various additive manufacturing methods for fabrication of liquid rocket engine channel wall nozzles to further reduce cost and schedule. The methods being evaluated are targeting increased scale required for current NASA and commercial space programs, well beyond SLM techniques. Channel-cooled, or regeneratively-cooled nozzles as part of an engine system, present a unique challenge for manufacturing due to the scale and complexity required at these scales. To provide perspective of the scale need, a cartoon comparison shows the relative scale of SLM build boxes to current engines in Fig. 28.

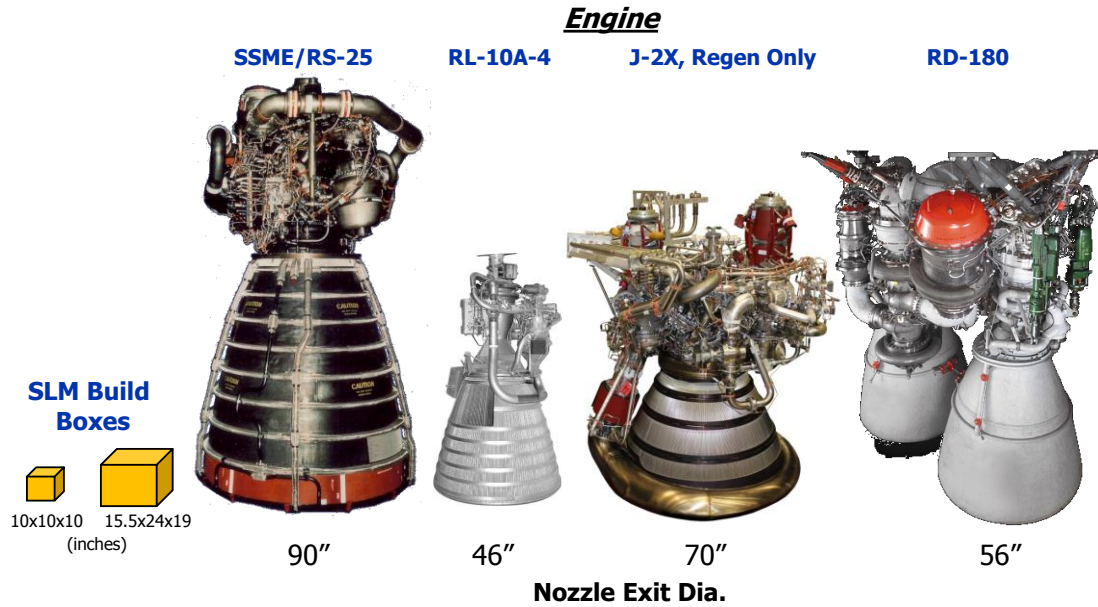

Figure 28. Scale of SLM compared to nozzle requirements demonstrating need for other additive techniques⁴².

Several additive manufacturing methods are being investigated for forming the inner liner, producing the coolant channels, performing closeout of the coolant channels, and fabrication of the manifolds and combinations of channels and manifolds. MSFC has completed initial process development and feasibility subscale hot-fire testing of a series of these advanced fabrication channel wall nozzle technologies to gather performance data in a relevant environment. These fabrication techniques included Laser Wire Direct Closeout (LWDC), arc-based wire deposition, blown powder deposition fabrication, and selective laser melting (at the maximum scale). A summary of the nozzles that completed hot-fire testing is provided in Table 3.

Table 3. Summary of Additive Channel-Cooled Nozzle Hot-fire Testing.

Nozzle Component Description	Propellants	Additive Process	Material	Starts	Hot-fire Time (sec)
1,200 lbf LWDC Regen Nozzle, PH034	LOX/GH2	LWDC	SS347	4	160
1,400 lbf LWDC Regen Nozzle, Additive Liner, PH034	LOX/GH2	LWDC	Inco 625	9	880
Integrated Nozzle Film Coolant Ring (INFCR), PF086	LOX/GH2	SLM	Inco 625	12	147
1,200 lbf DED Regen Nozzle, PH034	LOX/GH2	DED	Inco 625	1	15
800 lbf Radiatively-cooled Nozzle, PD020C	LOX/GH2	SLM	Inco 718	1	30
			TOTAL	23	1232

One of the early SLM nozzles tested in 2013 was a radiatively-cooled Inconel 718. Early development of the SLM process designed for and fabricated thicker walls than desired to make a radiation-cool feasible in the test environment. This was fabricated at MSFC with the Concept Laser M2 and was machined to a final wall thickness. While the technical risk of testing was low, this nozzle still provided data in a relevant environment for SLM additive manufacturing approaches.

Recent testing was completed on a large scale integrated nozzle film coolant ring (INFCR) using SLM under the LCUSP project previously described⁴³. The INFCR is an additively manufactured assembly that incorporated a channel-cooled nozzle section and a separate cooling circuit for film cooling of a Carbon-Carbon nozzle extension that provided a full thrust chamber assembly. The gaseous hydrogen (GH2) cooled portion included an integral inlet and outlet manifold that provide cooling to the channels and a separate inlet manifold that feeds individual film coolant holes for the C-C extension. The entire assembly was designed to maximize the current size limitations for SLM at 15.7" (400mm) diameter. The entire assembly was additively manufactured at a commercial vendor using Inconel 625

on an EOS M400 machine. Additive manufacturing of the INFCR provided a compact design with complex integrated manifold and feed passages along with common internal walls (low pressure differential across) to minimize weight. The INFCR during fabrication is shown in Fig 29.

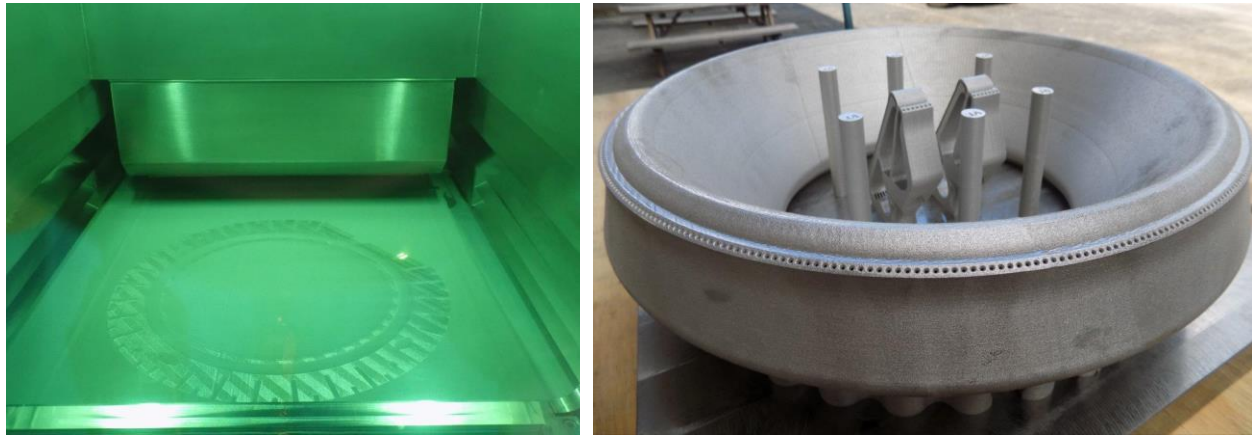

Figure 29. INFCR during SLM build (Left) and Post-build with witness specimens and wedges.

The hotwall boundary conditions were driven by the chamber pressure and mixture ratio for the LCUSP program. These conditions provided adequate cooling to the nozzle, but also pushed material temperature limitations to help evaluate the technology for use in liquid rocket engine applications. The INFCR completed final design and was fabricated at Atlantic Precision, Inc (API) in Port St. Lucie, FL. Due to the complexity of the coolant channels and limited number and small area of inlets and outlets, a series of iterations were completed that included Computer Tomography (CT) scanning and powder removal techniques. Following powder removal, the INFCR completed heat treatments and final machining of interfaces. The hotwall was also polished to reduce the as-built surface finish. The INFCR installed on the test stand and during hot-fire testing is shown in Fig. 30.

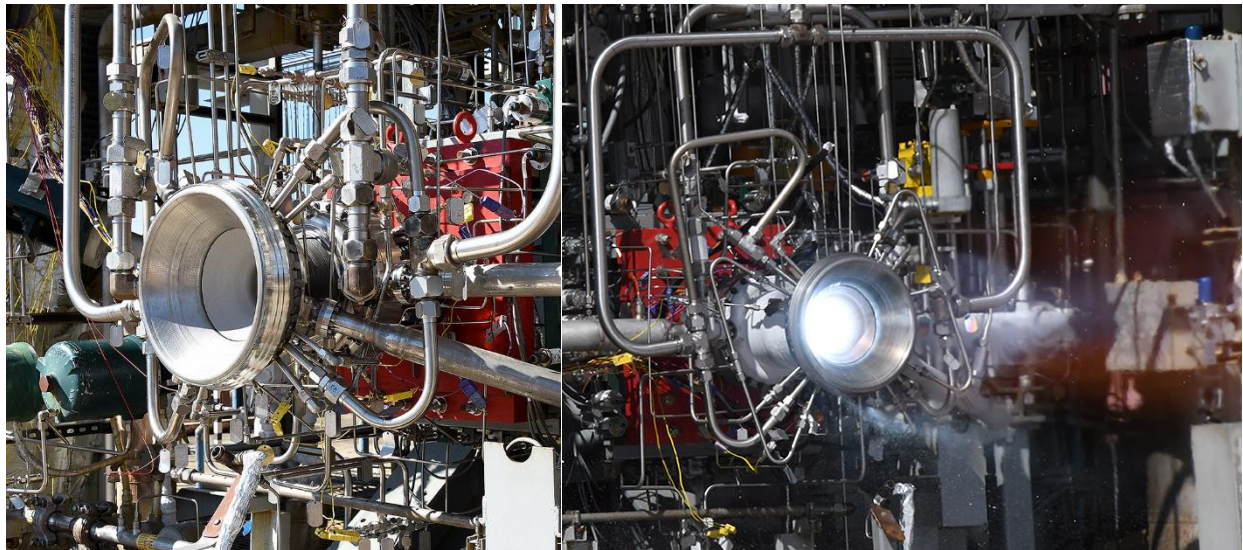

Figure 30. (Left) INFCR Installed on the Test Stand 116 and (Right) Mainstage Test with INFCR.

With the understanding that the SLM technology was very limited in scale, including use of a multi-piece SLM welded-panel nozzle, NASA is developing new additive manufacturing techniques to help solve the scale issues. The first technology is the LWDC closeout techniques as previously described. The LWDC is a DED-based technology and provides a large build volume using open-air localized purge robotic systems.

A series of nozzles were manufactured using this technique and hot-fire tested, along with nozzles manufactured with other additive techniques. The first nozzle used wrought stainless for the liner and the LWDC technique for closeout of the coolant channels. The second nozzle used two different additive techniques, the DED wire arc-

deposition to form the liner and the LWDC technique to close out the coolant channels. The arc-deposition MDDM process demonstrated a substantial schedule savings to provide the preform liner using Inconel 625. The LWDC technique successfully closed out the channels and formed the structural jacket in place with post-processing that only included machining for the manifolds and final machining. Figure 31 shows these techniques as they are integrated into a hot-fire test nozzle unit.

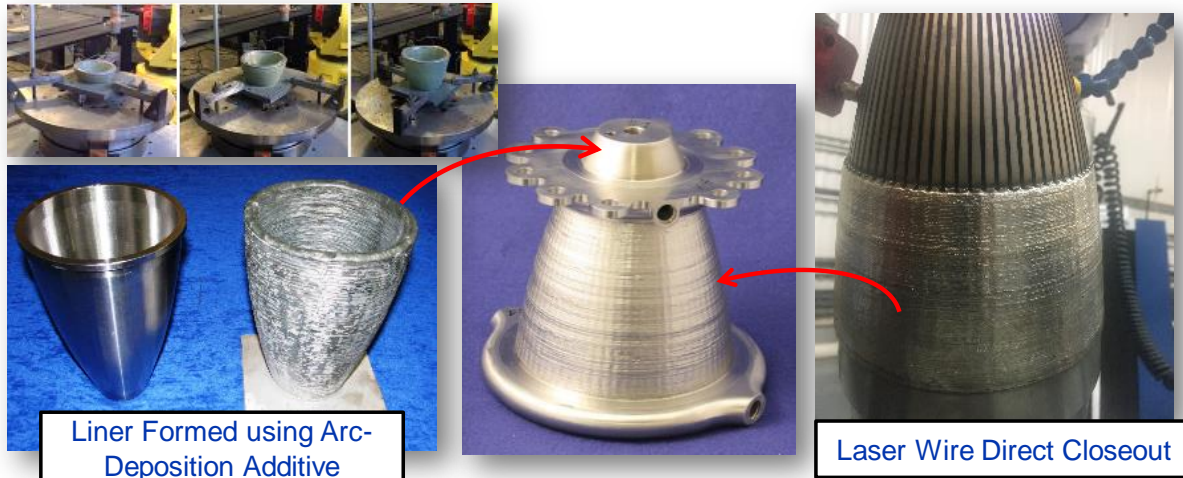

Figure 31. Arc-based additive deposition and Laser Wire Direct Closeout (LWDC) integrated into channel wall nozzle for hot-fire.

Hot-fire testing was completed on two different LWDC-closeout nozzle units in 2017. The units were fabricated from Stainless 347 (SS347) and Inconel 625 with a monolithic closeout. The LWDC process was developed for each of the alloys and met all inspection requirements and proof testing. The nozzles and subsequent closeout technique performed well during hot-fire cyclic testing and no anomalies were noted⁴⁴. There was minor discoloration of the nozzles at the forward end confirming the elevated temperatures, as predicted. The SS347 nozzle achieved 160 seconds and 4 starts in LOX/GH2 at mixture ratios up to 6.06. The Inconel 625 LWDC nozzle accumulated 880 seconds and 9 starts with LOX/GH2 mixture ratios up to 6.7. The nozzles were cooled with water for initial testing and pressure drops using this new fabrication technique met all predictions. The SS347 LWDC nozzle during hot-fire testing is shown in Fig. 32.

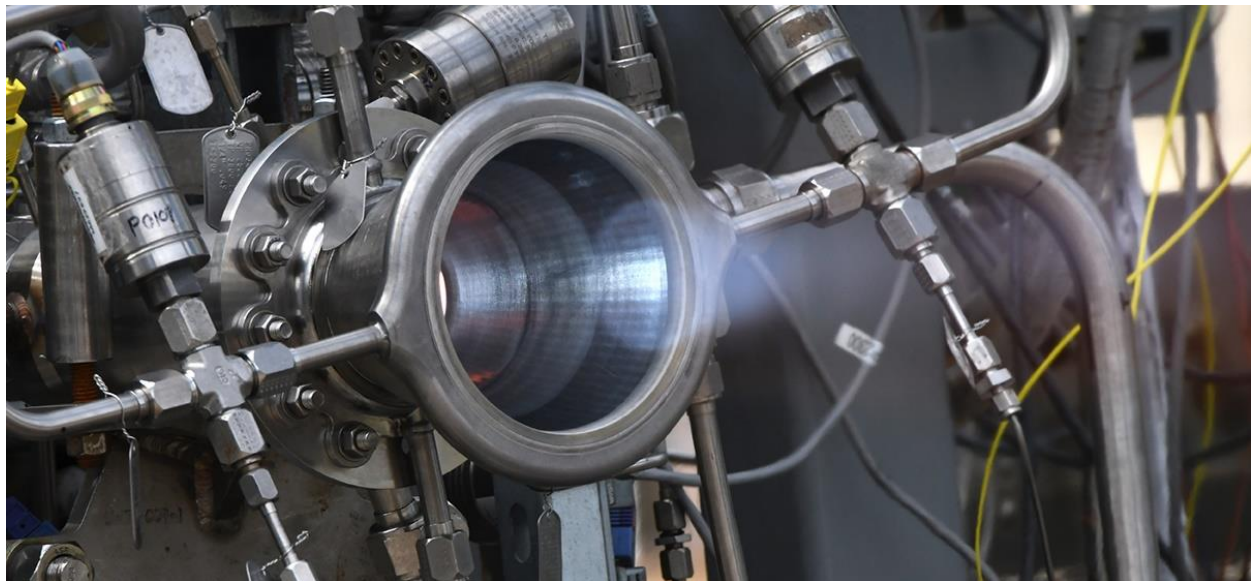

Figure 32. Mainstage Hot-fire of Nozzle #1, LWDC SS347.

A directed energy deposition blown powder nozzle completed a feasibility hot-fire test in late 2017. This nozzle was fabricated with integral coolant channels from Inconel 625. The manifolds were machined from forging and welded. The nozzle completed one test and accumulated 15 seconds and is shown in Fig. 33. The pressure drop from a nozzle with this fabrication technique was 50% of that for the LWDC technique for similar flow rates, primarily driven by the geometry of the inlets and outlets to the channels. This nozzle provided a significant simplification in the integrated liner and channel forming, which is fabricated all in the same step. The only major assembly step was to weld on the manifolds and complete machining. NASA is currently working to advance this technology under a program called Rapid Analysis and Manufacturing Propulsion Technology (RAMPT). This program will fully develop the DED blown powder deposition process for regeneratively cooled nozzles and the scale up of this process⁴⁵.

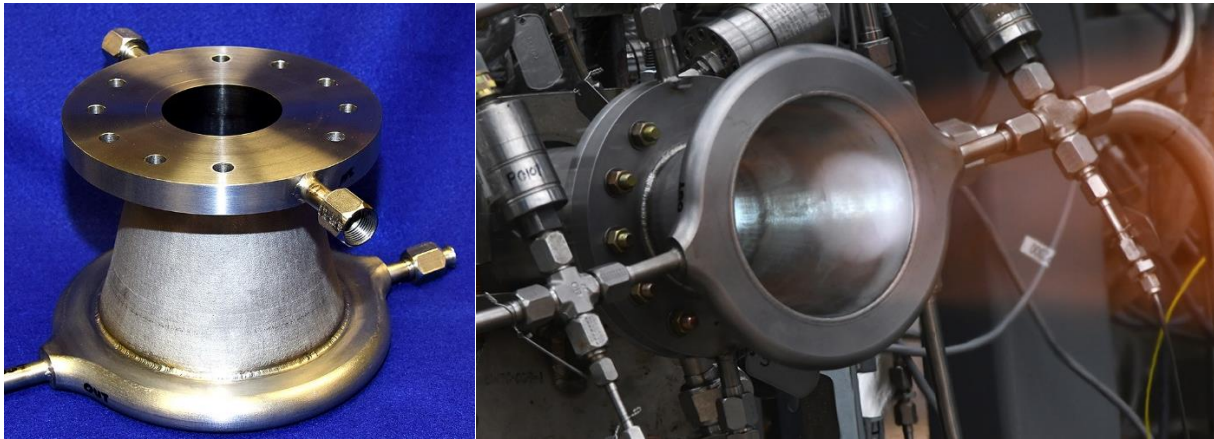

Figure 33. (Left) DED Blown Powder Nozzle and (Right) DED Nozzle during feasibility hot-fire test.

Additively Manufactured Augmented Spark Igniters

AM for the previous components described has been focused on development and initial feasibility for a variety of programs. AM of Augmented Spark Igniters (ASI) has been targeted as a potential upgrade for the RS-25 engine. The RS-25 engine, formerly known as the Space Shuttle Main Engine, is a liquid rocket engine that serves as the core stage engine for NASA's future heavy-lift, human-rated Space Launch System (SLS). The RS-25 engine has three combustion chambers – a Main Combustion Chamber (MCC), an Oxygen Preburner, and a Fuel Preburner, each of which requires an ASI for ignition. The ASI is composed of a copper alloy inner body that, in the past, has been brazed inside a nickel alloy outer body. The copper alloy is needed for high thermal conductivity, while the nickel alloy is required for structural support. With four RS-25 engines on the SLS vehicle, a dozen ASI units are required for each flight of the SLS. Alternative, less expensive methods to fabricate ASI units are being explored for future lower-cost block upgrades of the RS-25 engine. Two different AM technologies have been investigated, and ASI prototypes have been built and tested at MSFC. These additive fabrication approaches include SLM and the hybrid DED/CNC technology. A summary of all AM ASI units that have been hot-fire tested is provided in Table 4.

Table 4. Summary of Additive ASI Hot-fire Testing.

ASI Description	Propellants	Additive Process	Material	Starts
Regen-cooled ASI, AR-1	LOX/LH2	SLM	Inco 625	11
Regen-cooled ASI, AM-3	LOX/LH2	SLM	Inco 625	16
Baseline ASI, AR-B-1	LOX/LH2	SLM	Inco 625	15
Baseline ASI, AR-B-2	LOX/LH2	SLM	Inco 625	21
Regen-cooled ASI, API-1	LOX/LH2	SLM	Inco 625	13
Hybrid, Bi-metallic ASI	LOX/LH2	Hybrid	Inco 625 / C18150	33
TOTAL				109

The first ASI prototype made with AM technology used SLM. Because the SLM technique would not allow for a bi-metallic design, the ASI internal flow path was modified to include a regeneratively cooled circuit to compensate, at least in part, for the absence of the copper alloy in the hottest region of the igniter chamber dome. Seventy-six low-pressure hot-fire tests, some with test durations as long as 2 minutes, were conducted with five different ASI units. A photograph of a regeneratively cooled SLM ASI, along with test photos, is shown in Fig. 34. At the low pressures that were tested, no issues were identified with the design, but low cycle fatigue did not meet safety margins to fully implement this approach.

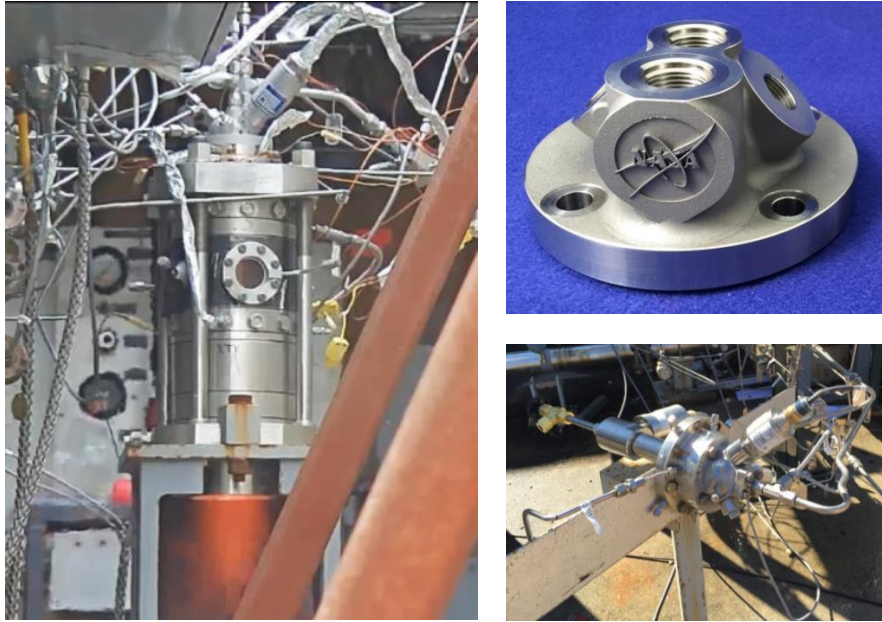

Figure 34. Clockwise from upper right-hand photo: 1) regen-cooled SLM ASI, 2) water flow testing of ASI, and 3) hot-fire testing of ASI.

For a SLM design to be successful, either the ASI mixture ratio would need to be lowered and/or some form of direct cooling of the chamber dome would need to be added. Either option would introduce further departures from the heritage hardware, which would increase the development costs and offset the potential cost-savings. The focus, therefore, pivoted to a different AM technology – hybrid manufacturing, which combines both additive and subtractive manufacturing by merging DED with multi-axis Computer Numerical Control (CNC) machining.

Hybrid DED/CNC manufacturing machines, unlike SLM, are not restricted to a single build direction, and they offer the advantage of smooth, machined finishes in locations that might not be possible with SLM. The technology is also scalable, allowing for larger parts to be built. The primary benefit, however, of using hybrid DED/CNC for the ASI is that the hybrid manufacturing technique is not limited to a single metal. Hybrid manufacturing allows the flight-proven heritage bi-metallic aspect of the ASI to be maintained.

Two full bi-metallic ASI prototypes were designed and built, and later hot-fire tested as part of a collaborative effort between NASA MSFC, DMG MORI, and University of Alabama in Huntsville (UAH)⁴⁶. The ASI builds were accomplished on a DMG MORI LT4300 3D machine, which is a hybrid DED/CNC machine. The LT4300 3D is a standard 9-axis mill-turn CNC machining platform modified to include a DED tool coupled to the machine's milling spindle. Figure 35 shows some photos of an ASI as it was being built in an LT4300 3D machine. The particular LT4300 used in this application was equipped with a 10 kW diode laser with a 4 mm circular spot size. The multi-orifice AM tool was used for deposition.

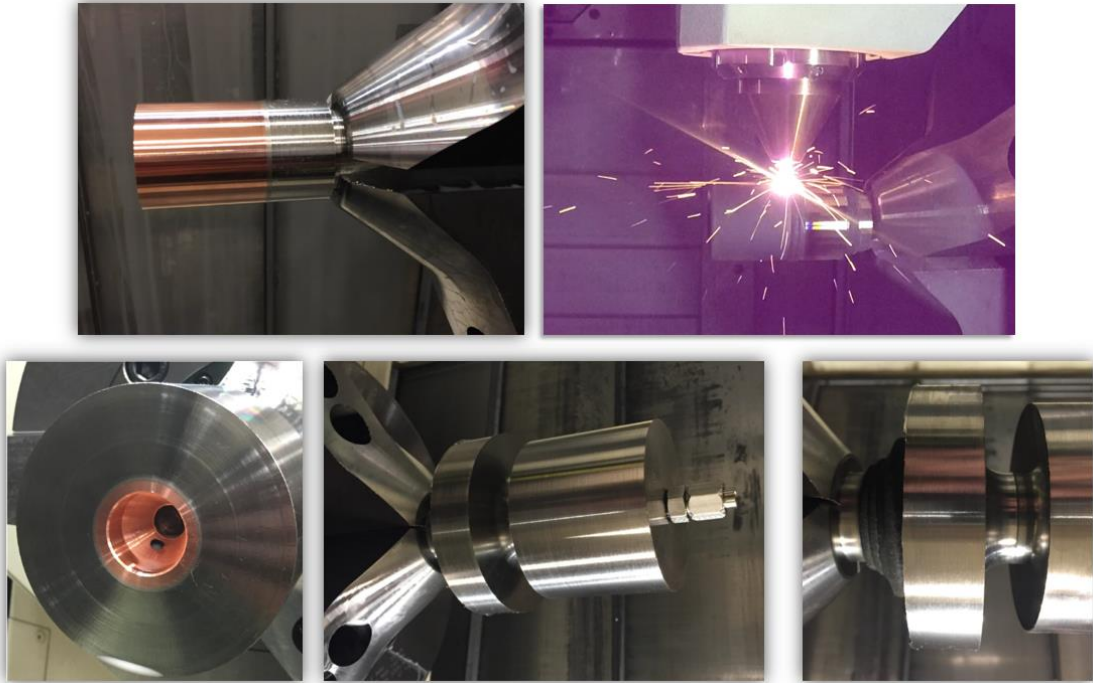

Figure 35. Photos taken during the build process of the prototype ASI.

Photos of two completed ASI builds are shown in Fig. 36. The ASI on the left is a cross section of the first full build of the ASI in which, for leak-testing purposes, the fuel orifices were omitted, and the ASI on the right is the final hot-fire version that includes the fuel orifices in the internal geometry. The multi-axis capability of hybrid manufacturing made it a simple matter to incorporate the ASI torch tube and a large diameter mounting flange resembling the RS-25 liquid oxygen pre-burner's interpropellant plate into the design.



Figure 36. Bi-metallic prototype of the RS-25 ASI, built using hybrid manufacturing. (Left) A cross section of the first full build of the ASI with no fuel orifices. (Right) the final hot-fire version that included fuel orifices.

Several samples of the bi-metallic interface from an initial “head-end-only” build (not shown in Fig. 36) were sectioned and polished so the interfacial region could be studied. Porosity, which can be seen in the microscope images

around the interface region and extending into the Inconel 625, averaged between 50-90 microns in diameter with some pores being much smaller. The suspected causes for the porosity were entrapped gases either inside the powder feedstock or resulting vaporization of alloying elements during the deposition. EDS, SEM and microscope images showed interdiffusion between the two alloys, as can be observed in Fig. 37.

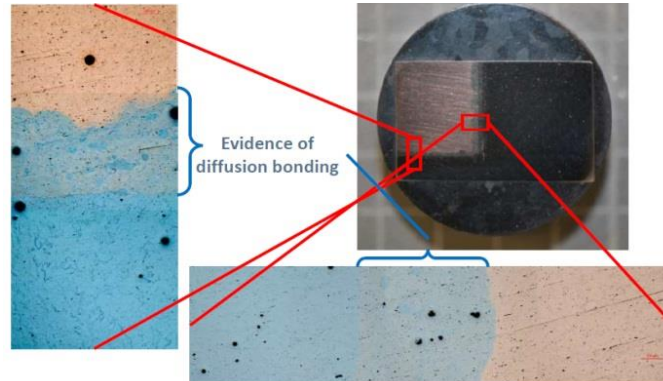

Figure 37. Optical microscopy images of bond area.

After hydrostatic pressure proof testing and helium leak testing were conducted, the second and final build of the igniter was installed in the test cell facility at NASA MSFC for low-pressure, hot-fire component testing to simulate the tank-head operation of the igniter during engine start-up. A total of 33 low pressure, short duration hot-fire ignition tests were conducted. All tests resulted in successful ignition within the first 60 ms of both propellants arriving in the igniter combustion chamber. A typical igniter exhaust flame is shown in Fig. 38. Because LOX/LH₂ combustion produces very little light in the visible spectrum, an infrared camera was used to view the flame.

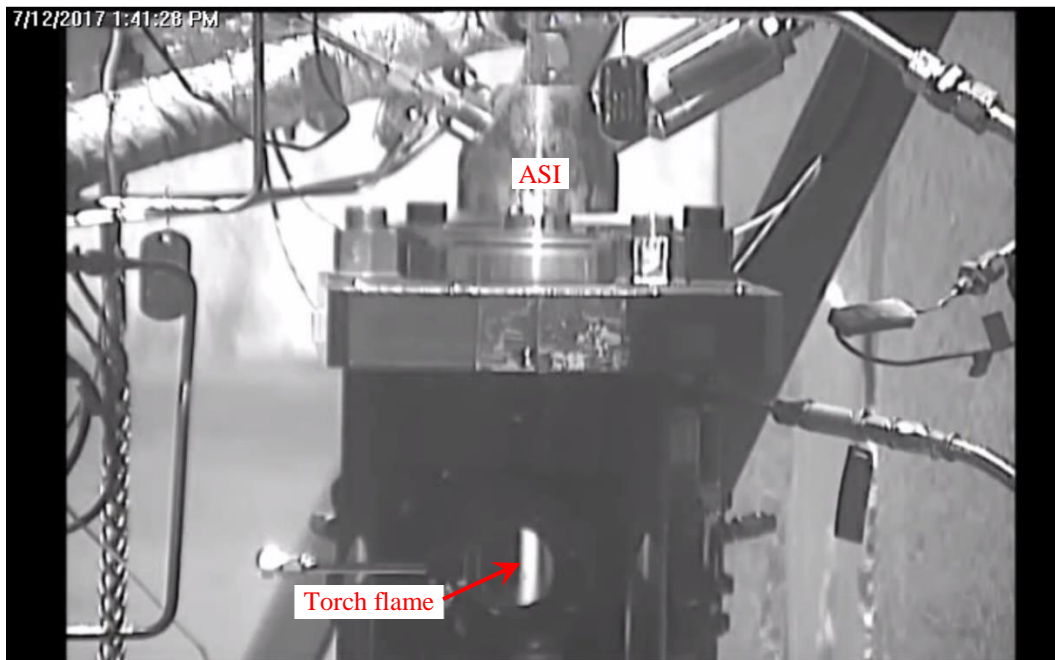

Figure 38. Infrared image of igniter exhaust flame.

While the bi-metallic ASI performed satisfactorily in the low-pressure hot-fire tests, several areas for improvement were identified for the initial builds and later corrected in further development. These areas are related to porosity, oxidation, close-out volumes, machine swarf, and post-build heat treatment.

This development and study demonstrated the fabrication of an igniter through DED/CNC hybrid manufacturing for the ASI. The prototype ASI, a bi-metallic liquid rocket engine component made of copper and nickel alloys, was made as a single build, in a matter of days, as opposed to the weeks or months it normally has taken to build ASI units with traditional machining and brazing processes. Hydrostatic testing confirmed the structural integrity of the part, while examination of the 1240-1400 micron interfacial region showed a complete diffusional bond between the two alloys. Numerous low-pressure, hot-fire tests of the component demonstrated extremely fast and consistent ignition, like the heritage ASI upon which the current design is based. While more work is needed to optimize the DED/CNC process for the bi-metallic ASI, initial results for hybrid manufacturing of this LRE component are very encouraging and open the possibility for producing even larger, more complex bi-metallic engine components with advanced manufacturing technology.

Conclusions

Over the past 8 years, the NASA MSFC has designed, developed and hot-fire tested numerous combustion devices components, including injectors, combustion chambers, channel-wall cooled nozzles, and augmented spark igniters, using additive manufacturing (AM) techniques. Component level and integrated system level testing in a variety of propellants has been conducted and performance derived from these tests. The AM technologies, specifically Selective Laser Melting (SLM) and Direct Energy Deposition (DED), have been found to be readily applicable for such components. Advantages of additively manufacturing these components include reduced component recurring cost, decreased manufacturing schedule, and the ability to incorporate geometric features for performance improvements that were not previously possible. However, additive manufacturing is not necessarily the best process for every component application, and should be traded among other fabrication techniques. The life cycle cost of additive manufacturing should also be correctly evaluated to include nonrecurring costs such as the specific detailed design for AM, SLM and DED process development, post-processing treatments, and potentially additional materials characterization and component and system testing to finally realize the full cost benefits.

MSFC has completed development and testing of several injectors using SLM and determined that additive manufacturing is well suited to injector fabrication. AM offers the opportunity to create complex internal passages and cavities, although a thorough understand of the design application is critical to make full use of the fabrication technology. Multiple injectors in several propellant combinations have demonstrated combustion efficiencies essentially the same as those of traditionally manufactured injectors. The material preferences for injectors include the superalloy family of Inconel 625, 718, and Monel K-500. MSFC has completed several injector hot-fire test programs and accumulated thousands of seconds of time, including a subscale injector with over 7,200 seconds.

All combustion chambers fabricated using the SLM process for Inconel 718, GRCo-84, and C-18150 have successfully completed hot-fire testing in a variety of propellants. Total time accumulated on these chambers is over 6,100 seconds and 112 starts. MSFC continues to hot fire new designs, so time in hot fire continues to accumulate. Additional research is being conducted to optimize the design and build parameters and feature characteristics affecting performance such as the surface roughness. Current developments at MSFC have shown substantial reduction in pressure drop with reduction in surface finish.

The SLM GRCo-84 has been demonstrated as a feasible replacement liner material for combustion chambers, and has become the preferred option moving forward with various chamber development programs. A substantial cost and schedule savings has been demonstrated using the SLM fabrication technique, particularly with GRCo-84. New design concepts have also been introduced that were not previously possible and iterative design and test programs being completed than previously thought possible. Process improvements using SLM fabrication have demonstrated reduced pressure drops over development iterations, further increasing performance. SLM has been successfully demonstrated and is a process that NASA is baselining for many combustion chambers as part of engine projects. Other developments are continuing with SLM materials including further research into the C-18150 and development of GRCo42 for an increase in thermal conductivity⁴⁷.

A series of channel-wall cooled nozzles using various additive manufacturing were fabricated and completed hot-fire testing. Nozzles present a unique challenge due to the scale, which is beyond SLM for most applications. To solve this, the NASA MSFC has developed some large-scale DED techniques for forming the liner and closeout of the coolant channels. Newly developed additive techniques specific to nozzle fabrication, such as the Laser Wire Direct Closeout (LWDC), have been proven to simplify fabrication steps, and have been advanced through hot-fire testing. Over 1,200 seconds of hot-fire time has been accumulated on channel-wall cooled nozzles using various additive manufacturing techniques. Through a multi-center project, the NASA will continue to evolve additive for large scale nozzles, focused on DED blown powder deposition. This process provides a significant simplification in the integrated

liner and channel forming, which is fabricated all in the same step. NASA is currently working to advance this technology under a program called Rapid Analysis and Manufacturing Propulsion Technology (RAMPT) specific to nozzle technology.

Augmented Spark Igniters (ASI) have been demonstrated through SLM additive manufacturing and hybrid DED/CNC manufacturing techniques and hot-fire testing at component and system levels. These ASIs included integral cooling features with monolithic and bimetallic approaches. Over 109 starts have been demonstrated on the ASI components targeting conditions for the RS-25 engine. These fabrication approaches offer a significant cost and schedule savings compared to traditional manufacturing.

Bimetallic additive manufactured components such as the LCUSP combustion chamber and the hybrid-manufactured ASI demonstrate combining materials for designs that require both high conductivity and strength. Two DED techniques, Electron Beam Freeform Fabrication and blown powder deposition, have been combined with traditional machining and SLM processes to enable these technologies. Successful hardware fabrication and hot-fire testing has confirmed these technologies and their performance. Several challenges exist with the bimetallic components particularly for heat treatment processes that trade properties for both of the components and optimize structural properties required. The temperatures normally specified in the heat treatment steps for nickel alloys are near or above the melting temperatures of copper alloys. Therefore, if a bi-metallic part such as the chamber or ASI is to undergo heat treatment to strengthen the nickel alloy, a customized heat treat schedule will need to be devised.

Acknowledgments

There has been significant development work focused on additive manufacturing across the various NASA centers and MSFC. It is understood that these development efforts are completed with a much larger team, so the authors would like to acknowledge several people and organizations involved. Thank you to the outstanding design support from ER34 Detailed Design – Kevin Baker, Will Brandsmeier, Dwight Goodman, Adam Willis, Shawn Skinner, and Cory Medina. Thank you for the outstanding support from all our detailed analysis groups – ER41, ER42, ER43. The NASA EM42 AM lab has provided outstanding development support including Zach Jones, Omar Mireles, Jim Lydon, Brian West and Majid Babai. GRC has provided the expertise in GRCop-84 and general SLM materials including: Dave Ellis, Bob Carter, Brad Lerch, Ivan Locci, Laura Evans. Thank you to the various project offices involved in supporting this development work including: Space Launch System (SLS) Liquid Engines - Steve Wofford, Keegan Jackson, Andy Hardin, Mike Shadoan, and Carol Jacobs (retired); STMD Low Cost Upper Stage Propulsion Project – John Fikes, John Vickers; NASA IRAD/Tech Excellence – Jim Turner, James Cannon, Mary Beth Koelbl; Lander Office – Greg Barnett, Greg Chavers. Thank you to our critical industry partners involved in development including Dr. Greg Hyatt and Sean Sporie (DMG MORI Advanced Solutions, Inc), Bryant Walker (Keystone Synergistic Enterprises), Albert Hammeke (Laser Technology Associates), Bhaskar Dutta (DM3D), Tanksley Machine, ProCAM, Joe Sims, (ASRC Federal Astronautics), Moog, Stratasys, Dr. Judy Schneider and students at University of Alabama Huntsville (UAH), and Tyler Blummenthal (RPMI). Thank you for the outstanding support from the test conductors and test teams at TS115 (Cynthia Sprader and crew), TS116 (Ryan Wall and crew), and Test Cells (Paul Dumbacher and crews) including machine shop and ET test area support staff. The ASI and nozzle development was funded by the LEO at NASA MSFC, and through collaborative but separate efforts between MSFC and Aerojet Rocketdyne (AR) and thank you to engineering counterparts at AR. Thank you to the many other unnamed engineers at MSFC, commercial space companies, and industry that engaged in various tasks on this development, co-development and partnerships, technical discussions and that have contributed to these various techniques.

References

- ¹ Betts, E.M., Eddleman, D.E., Reynolds, D.C., Hardin, N.A. Using Innovative Technologies for Manufacturing Rocket Engine Hardware. JANNAF 6th Liquid Propulsion Subcommittee Meeting; 5-9 Dec. 2011; Huntsville, AL.
- ² Ballard, R.O. Next-Generation RS-25 Engines for the NASA Space Launch System. NASA M17-6076. 7th European Conference for Aeronautics and Space Sciences (EUCASS 2017). Milan; Italy. 3-6 Jul. (2017).
- ³ Gradl, P., Brandsmeier, W., Calvert, M., et al. Additive Manufacturing Overview: Propulsion Applications, Design for and Lessons Learned. Presentation: M17-6434. 1 December (2017).
- ⁴ ASTM Committee F42 on Additive Manufacturing Technologies. Standard Terminology for Additive Manufacturing Technologies ASTM Standard: F2792-12a. (2012).
- ⁵ Ek, K., “Additive Manufactured Metals,” Master of Science thesis, KTH Royal Institute of Technology (2014).

⁶ Qian, M., W. Xu, M. Brandt, and H. P. Tang. "Additive manufacturing and postprocessing of Ti-6Al-4V for superior mechanical properties." *MRS Bulletin* 41, no. 10 (2016): 775-784.

⁷ O'Neill, W., Cockburn, A., et al. "Supersonic Laser Deposition of Ti and Ti64 Alloys". 5th International Symposium on High Power Fibre Laser and their Applications/14th International Conference on Laser Optics. July 1, 2010. St. Petersburg, Russia.

⁸ Bremen, S., Meiners, W. and Diatlov, A., Selective Laser Melting. *Laser Technik Journal*, 9(2), pp.33-38. (2012).

⁹ Sames, W.J., List, F.A., Pannala, S., Dehoff, R.R. and Babu, S.S., The metallurgy and processing science of metal additive manufacturing. *International Materials Reviews*, 61(5), pp.315-360. (2016).

¹⁰ VDI-Guideline 3404 (2009) Additive Fabrication-Rapid Technologies (Rapid Prototyping) – Fundamentals, Terms and Definitions, Quality Parameter, Supply Agreements. (2014).

¹¹ Gradl, P. Rapid Fabrication Techniques for Liquid Rocket Channel Wall Nozzles. AIAA-2016-4771, Paper presented at 52nd AIAA/SAE/ASEE Joint Propulsion Conference, July 27, 2016. Salt Lake City, UT.

¹² Syed, W.U.H., Pinkerton, A.J. and Li, L. A comparative study of wire feeding and powder feeding in direct diode laser deposition for rapid prototyping. *Applied Surface Science*, 247(1), pp.268-276 (2005).

¹³ Honore, M. "Structural strengthening of Rocket Nozzle Extensions by Means of Laser Metal Depositioning". In Support of Volvo Channel Wall Nozzle. Force Technology. MTI Mtg Laserfusing Presentation. 1 February, 2013.

¹⁴ Gradl, P.R., Reynolds, D.C. and Walker, B.H., National Aeronautics and Space Administration (NASA), 2017. Freeform deposition method for coolant channel closeout. U.S. Patent 9,835,114. Issued December 5, 2017

¹⁵ Gradl, P., Greene, S., Brandsmeier, W., Johnston, I. Channel Wall Nozzle Manufacturing and Hot-Fire Testing using a Laser Wire Direct Closeout Technique for Liquid Rocket Engines. 54th AIAA/SAE/ASEE Joint Propulsion Conference, AIAA Propulsion and Energy Forum, (AIAA-2018). July 9-12, 2018. Cincinnati, OH.

¹⁶ Colegrove, P. and Williams, S., High deposition rate high quality metal additive manufacture using wire+ arc technology. Cranfield University. (2012)

¹⁷ Xiong, Jun, et al. Fabrication of Inclined Thin-walled Parts in Multi-layer Single-pass GMAW-based Additive Manufacturing with Flat Position Deposition. *Journal of Materials Processing Technology* 240: 397-403. (2016).

¹⁸ Ruan, J., Sparks, T. E., Fan, Z., Stroble, J. K., Panackal, A., & Liou, F. (2006). A review of layer based manufacturing processes for metals. In *17th Solid Freeform Fabrication Symposium, Austin (USA)* (pp. 233-245).

¹⁹ Gradl, P.R., Brandsmeier, W. Alberts, D., Walker, B., Schneider, J.A. Manufacturing Process Developments for Large Scale Regeneratively-cooled Channel Wall Rocket Nozzles. Paper presented at 63rd JANNAP Propulsion Meeting/9th Liquid Propulsion Subcommittee, December 5-9, 2016. Phoenix, AZ.

²⁰ Scheck, C., Jones, N., Farina, S., George, C. and Melendez, M., Technical Overview of Additive Manufacturing. Naval Surface Warfare Center, Carderock Division. NSWCCD-61-TR-2014/16. (April 2014).

²¹ Buzzell, J., and Bullard, B., "100 lbf LOX-Propane Nanolaunch Thruster Hot-Fire Test Program," ER32 Branch, NASA MSFC, MSFC Internal Presentation, 11/14/2013.

²² Barnett, G.L., and Bullard, D.B., "Test Summary Report for Test Program PD114, '28 Element Subscale SLM Injector Testing'," NASA Marshall Space Flight Center, December 13, 2013.

²³ Barnett, G.L., and Bullard, D.B., "Test Summary Report for Test Program PE040, '40 Element Subscale 3-D Printed Injector Testing'," NASA Marshall Space Flight Center, January 2015.

²⁴ Barnett, G. L., and Bullard, D. B., "Summary of Liquid Oxygen/Hydrogen, Direct Metal Laser Sintering Injector Testing and Evaluation Effort at Marshall Space Flight Center," 62nd JANNAP Propulsion Meeting and Joint Meeting of the 10th Modeling & Simulation Subcommittee (MSS) / 8th Liquid Propulsion Subcommittee (LPS) / 7th Spacecraft Propulsion Subcommittee (SPS), Nashville, TN, June 1-5, 2015.

²⁵ Bullard, D.B., Rice, D.C., Nelson, G.M., Case, N.L., Rocker, M., Wall, T.R., and Hulka, J.R., "Design, Fabrication and Hot-Fire Test of an Additively Manufactured Liquid Oxygen/Hydrogen 35-klbf Swirl Coaxial Element Injector," Joint Meeting of the Programmatic and Industrial Base (PIB) / 11th Modeling & Simulation Subcommittee (MSS) / 9th Liquid Propulsion Subcommittee (LPS) / 8th Spacecraft Propulsion Subcommittee (SPS), Phoenix, AZ, December 5-9, 2016.

²⁶ Elam Greene, S., "Test Summary Report for Test Program PF037, '4000 lb_f LOX-CH₄ Regen Cooled Thruster,'" NASA Marshall Space Flight Center, September 8, 2016.

²⁷ Elam Greene, S., "Test Summary Report for Test Program PC020B, 'Acoustic Model 4-Thruster System Testing,'" NASA Marshall Space Flight Center, Test Report TR RT10-13-01, April 8, 2013.

²⁸ Elam Greene, S., "Test Summary Report for Test Program PC020C, 'Acoustic Model Spare Thruster Testing,'" NASA Marshall Space Flight Center, Test Report TR RT10-13-02, June 14, 2013.

²⁹ Elam Greene, S., and Wood, J., "Test Summary Report for Test Program PH127, 'Methane Engine Testing for 1K lbf (MET1)," NASA Marshall Space Flight Center, October 4, 2017.

³⁰ Buzzell, J., "Test Summary Report for Test Program PG056 'LOX-Methane GG Injector & Workhorse Chamber Assembly'," ER36 Branch, NASA MSFC, Unreleased MSFC Test Report. (2017).

³¹ Protz, C., Bowman, R., Cooper, K., Fikes, J., Taminger, K., Wright, B. Additive Manufacturing of Low Cost Upper Stage Propulsion Components. Joint Army-Navy-NASA-Air Force (JANNAF) Liquid Propulsion Subcommittee (LPS) Advanced Materials Panel (AMP) Additive Manufacturing for Propulsion Applications Technical Interchange Meeting (TIM); 3-5 Sept. (2014.)

³² Carter, R. W., Ellis, D.L., Locci, I.E., Evans, L.J., Lerch, B., Jones, Z.C., Cooper, K. G. Evaluation of GRCop-84 Produced Using Selective Laser Melting, 62nd JANNAF Propulsion Meeting and Joint Meeting of the 10th Modeling & Simulation Subcommittee (MSS) / 8th Liquid Propulsion Subcommittee (LPS) / 7th Spacecraft Propulsion Subcommittee (SPS), Nashville, TN, June 1-5, 2015.

³³ Garcia, C.P., Gradl, P.R., Protz, C.S., Wood, J., and Greene, S. E. Characterizing Performance of Additively Manufacturing Regenerative Cooled Combustion Chambers through Hot Fire Testing, Paper presented at 65th JANNAF Propulsion Meeting/10th Liquid Propulsion Subcommittee, May 21-24, 2018. Long Beach, CA.

³⁴ Greene, S.E.. "Methane Engine Thrust Assembly for 4K lbf with a 4 Inch Diameter Chamber (META4X4)." Test Summary Report, Test Program PI051. NASA MSFC, May 8, 2018.

³⁵ Gradl, P., Greene, S.E., Valentine, P., Crisanti, M. "Subscale Carbon-Carbon Nozzle Extension Development and Hot Fire Testing in Support of Upper Stage Liquid Rocket Engines", JANNAF 63rd Propulsion Meeting/9th Liquid Propulsion Subcommittee Meeting, December 5-9, 2016. Phoenix, AZ.

³⁶ Gradl, P.R., and Valentine, P.G. "Carbon-Carbon Nozzle Extension Development in Support of In-space and Upper-Stage Liquid Rocket Engines". AIAA 2017-5064, 53rd AIAA/SAE/ASEE Joint Propulsion Conference, AIAA Propulsion and Energy Forum, Atlanta, GA. (2017).

³⁷ Greene, S.E., and Gradl, P. "C-CAT Nozzle Material Testing." NASA Internal Test Summary Report (available upon request), Test Program PG034 & PG053. NASA MSFC, January 13, 2017.

³⁸ Gradl, P., and Greene, S.E.. "Channel Wall Nozzle Testing." Test Summary Report, Test Program PH034. NASA MSFC, February 12, 2018.

³⁹ Greene, S.E., and Gradl, P. "Subscale Nozzle Testing for Orbital ATK." NASA Test Summary Report, Test Program PH171. NASA MSFC, January 10, 2018.

⁴⁰ Gradl, P.R., Protz, C., Greene, S.E., Ellis, D., Lerch, B., and Locci, I. "Development and Hot-fire Testing of Additively Manufactured Copper Combustion Chambers for Liquid Rocket Engine Applications", 53rd AIAA/SAE/ASEE Joint Propulsion Conference, AIAA Propulsion and Energy Forum, (AIAA 2017-4670)

⁴¹ Gradl, P., Protz, C., Greene, S.E., Garcia, C., Brandsmeier, W., Medina, C., Goodman, D., Baker, K., Barnett, G. Design, Development and Hotfire Testing of Monolithic Copper and Bimetallic Additively Manufactured (AM) Combustion Chambers for LOX/Methane and LOX/Hydrogen Applications Paper presented at 63rd JANNAF Propulsion Meeting/9th Liquid Propulsion Subcommittee, December 5-9, 2016. Phoenix, AZ.

⁴² Gradl, P.R., Brandsmeier, W. Alberts, D., Walker, B., Schneider, J.A. Manufacturing Process Developments for Large Scale Regeneratively-cooled Channel Wall Rocket Nozzles. Paper presented at 63rd JANNAF Propulsion Meeting/9th Liquid Propulsion Subcommittee, December 5-9, 2016. Phoenix, AZ.

⁴³ C. S. Protz, W. C. Brandsmeier, K. G. Cooper, J. Fikes, P. R. Gradl, Z. C. Jones, and C. R. Medina, D. L. Ellis,; and K. M. Taminger. "Thrust Chamber Assembly using GRCop-84 Bimetallic Additive Manufacturing and Integrated Nozzle Film Coolant Ring Supporting Low Cost Upper Stage Propulsion", Paper presented at 65th JANNAF Propulsion Meeting/10th Liquid Propulsion Subcommittee, May 21-24, 2018. Long Beach, CA.

⁴⁴ Gradl, P.R., Greene, S. E., Brandsmeier, W., Johnston, M.I., Hot-Fire Testing and Large-Scale Deposition Manufacturing Development Supporting Liquid Rocket Engine Channel Wall Nozzle Fabrication, Paper presented at 65th JANNAF Propulsion Meeting/10th Liquid Propulsion Subcommittee, May 21-24, 2018. Long Beach, CA.

⁴⁵ Fikes, J., Vickers, J., Gradl, P., Protz, C. (n.d.). Rapid Analysis and Manufacturing Propulsion Technology (RAMPT). Retrieved April 24, 2018, from <https://gameon.nasa.gov/projects/rapid-analysis-and-manufacturing-propulsion-technology-ramp/>

⁴⁶ Sporie, S., Schneider, J.A., Osborne, R. "Using hybrid manufacturing in the freeform fabrication of bi-metallic components". IAC-17-C2.9.7.x41117. 68th International Astronautical Congress (IAC), Adelaide, Australia, 25-29 September 2017

⁴⁷ Ellis, D.L., 2003. Conductivity of GRCop-42 alloy enhanced. NASA Glenn Research Center Research & Technology, p.16.