

# Computing stable outcomes in symmetric additively-separable hedonic games<sup>\*</sup>

Martin Gairing and Rahul Savani

Department of Computer Science, University of Liverpool.  
{gairing,rahul.savani}@liverpool.ac.uk

**Abstract.** We study the computational complexity of finding stable outcomes in hedonic games, which are a class of coalition formation games. We restrict our attention to symmetric additively-separable hedonic games, which are a nontrivial subclass of such games that are guaranteed to possess stable outcomes. These games are specified by an undirected edge-weighted graph: nodes are players, an outcome of the game is a partition of the nodes into coalitions, and the utility of a node is the sum of incident edge weights in the same coalition. We consider several stability requirements defined in the literature. These are based on restricting feasible player deviations, for example, by giving existing coalition members veto power. We extend these restrictions by considering more general forms of preference aggregation for coalition members. In particular, we consider voting schemes to decide if coalition members will allow a player to enter or leave their coalition. For all of the stability requirements we consider, the existence of a stable outcome is guaranteed by a potential function argument, and local improvements will converge to a stable outcome. We provide an almost complete characterization of these games in terms of the tractability of computing such stable outcomes. Our findings comprise positive results in the form of polynomial-time algorithms, and negative results in the form of proofs of PLS-hardness. The negative results extend to more general hedonic games.

## 1 Introduction

Hedonic games were introduced in the economics literature as a flexible model of coalition formation [24]. In a hedonic game, each player has preferences over coalitions and an outcome of the game is a partition of the players into coalitions. The defining feature of a hedonic game is that for a given outcome each player cares only about the other players in the same coalition. It is natural to judge the quality of an outcome by how stable it is with respect to the players' preferences. Many different notions of stability appear in the literature. The survey by Aziz and Savani [5] gives detailed background on hedonic games and outlines their applications. This paper studies the computational complexity of finding stable outcomes in hedonic games.

In this paper, we consider and extend the stability requirements for hedonic games introduced in the seminal work of Bogomolnaia and Jackson [17]. An outcome of a hedonic game is called *Nash stable* if no player prefers to be in a different coalition. For Nash stability, the feasibility of a deviation depends only on the preferences of the deviating player. Less stringent stability requirements restrict feasible deviations: a

---

<sup>\*</sup> This work was supported by EPSRC grants EP/L011018/1 and EP/J019399/1. This paper combines results from the two conference papers [29] and [30].

coalition may try to hold on to an attractive player or block the entry of an unattractive player. In [17], deviations are restricted by allowing members of a coalition to “veto” the entry or exit of a player. Bogomolnaia and Jackson [17] introduce *individual stability*, where every member of a coalition has a veto that can prevent a player from joining (deviating to) this coalition, i.e., a player can deviate to another coalition only if *everyone* in this new coalition is happy to have her. They also introduce *contractual individual stability*, where, in addition to a veto for entering, coalition members have a veto to prevent a player from leaving the coalition – a player can deviate only if everyone in her coalition is happy for her to leave.

The case where every member of a coalition has a veto on allowing players to enter and/or leave the coalition can be seen as an extreme form of *voting*. This motivates the study of more general voting mechanisms for allowing players to enter and leave coalitions. In this paper, we consider general voting schemes, for example, where a player is allowed to join a coalition if the majority of existing members would like the player to join. We also consider other methods of *preference aggregation* for coalition members. For example, a player is allowed to join a coalition only if the aggregate utility (i.e., the sum of utilities) of the existing members does not decrease. These preference aggregation methods are also considered in the context of preventing a player from leaving a coalition. We study the computational complexity of finding stable outcomes under stability requirements with various restrictions on deviations.

## 1.1 The model

In a general hedonic game, a player’s preferences depend only on the members of this player’s coalition. In this paper, we study a subclass of hedonic games with *symmetric additively-separable* utilities, which allow a succinct representation of the game as an *undirected edge-weighted graph*  $G = (V, E, w)$ , where  $V$  corresponds to the set of players and the weight of an edge defines the utility that the incident players receive for being in the same coalition. The following definitions in this section are for symmetric additively-separable games. We assume that the graph  $G$  has no self-loops, which corresponds to a player getting payoff 0 from being alone in a singleton coalition. For clarity of our voting definitions, we assume without loss of generality that  $w_e \neq 0$  for all  $e \in E$  (an edge with weight 0 can be dropped). Every node  $i \in V$  represents a player. An outcome is a partition  $p$  of  $V$  into coalitions. Denote by  $p(i)$  the coalition to which  $i \in V$  belongs under  $p$ .

The utility of  $i \in V$  under  $p$  is the sum of the weights of edges to others in the same coalition, i.e.,

$$\sum_{\{i,j\} \in E \mid j \in p(i)} w(\{i, j\}).$$

Each player wants to maximize her utility, so a player *wants to deviate* if there exists a coalition  $c$  that is either in  $p$  or is empty where

$$\sum_{\{i,j\} \in E | j \in p(i)} w(\{i,j\}) < \sum_{\{i,j\} \in E | j \in c} w(\{i,j\}).$$

We consider different restrictions on player deviations. They restrict when players are allowed to join and/or leave coalitions. A deviation of player  $i$  to coalition  $c$  (either in  $p$  or empty) is called

- *Nash feasible* if player  $i$  wants to deviate to  $c$ .
- *vote-in feasible* with threshold  $T_{in}$  if it is Nash feasible and either at least a  $T_{in}$  fraction of  $i$ 's edges to  $c$  are positive or  $i$  has no edge to  $c$ .
- *vote-out feasible* with threshold  $T_{out}$  if it is Nash feasible and either at least a  $T_{out}$  fraction of  $i$ 's edges to  $p(i)$  are negative or  $i$  has no edges within  $p(i)$ .
- *sum-in feasible*<sup>1</sup> if it is Nash feasible and

$$\sum_{\{i,j\} \in E | j \in c} w(\{i,j\}) \geq 0.$$

- *sum-out feasible* if it is Nash feasible and

$$\sum_{\{i,j\} \in E | j \in p(i)} w(\{i,j\}) \leq 0.$$

Outcomes where no corresponding feasible deviation is possible are called *Nash stable*, *vote-in stable*, *vote-out stable*, *sum-in stable*, and *sum-out stable*, respectively. Outcomes which are vote-in (resp. vote-out) stable with  $T_{in} = 1$  (resp.  $T_{out} = 1$ ) are also called *veto-in* (resp. *veto-out*) *stable*. Note that an outcome is veto-in stable iff it is an *individually stable* outcome; and an outcome is both veto-in and veto-out stable iff it is a *contractually individually stable* outcome (we use the terms individually stable and contractually individually stable since they are commonly used and known in the economics literature following their definition in [17]).

While we have introduced these stability notions in the context of symmetric additively-separable games, the following notions can also be stated for general hedonic games. A deviation of player  $i$  to coalition  $c$  is

- Nash feasible if it improves the utility of a player  $i$ .
- *vote-in feasible* with threshold  $T_{in}$  if it is Nash feasible and, of those players in  $c$  that are not indifferent to  $i$  joining, at least a  $T_{in}$  fraction of them will gain utility by  $i$  joining  $c$ .
- *vote-out feasible* with threshold  $T_{out}$  if it is Nash feasible and, of those players in  $p(i)$  that are not indifferent to  $i$  leaving  $p(i)$ , at least a  $T_{out}$  fraction of them will gain utility by  $i$  leaving  $p(i)$ .

---

<sup>1</sup> By the symmetry of preferences, sum-in feasibility only restricts a player from joining a coalition that gives her negative utility.

The two notions that do not make sense for general hedonic games are sum-in and sum-out feasibility, since preferences in a general hedonic game are specified by a weak order over possible coalitions.

## 1.2 An example

Figure 1 gives an example of an additively-separable symmetric hedonic game that we use to illustrate some of the stability requirements that we have defined. Consider the outcome  $\{\{a, b, d\}, \{c, e, f\}\}$ . The utilities of the players  $a, b, c, d, e, f$  are 10, 5,  $-1$ , 5, 1, 4, respectively.

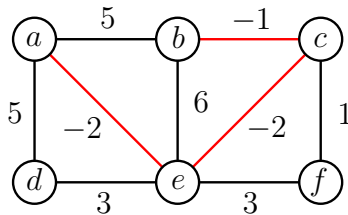

**Fig. 1.** An example of an additively-separable symmetric hedonic game.

Players  $a, b, d, f$  have no Nash feasible deviations,  $c$  has a Nash feasible deviation to go alone and start a singleton coalition, and  $e$  has a Nash feasible deviation to join the other coalition. The deviation of  $c$  is not veto-out feasible, since  $f$  prefers  $c$  to stay, however it is vote-out feasible for any  $T_{out} \leq 0.5$ . It is also sum-out feasible. The deviation of  $e$  is not veto-in feasible, but is vote-in feasible for any  $T_{in} \leq 2/3$ . Since there are no deviations that are both veto-in and veto-out feasible, this is a contractually individually stable outcome. The outcome  $\{\{a, b, d\}, \{c\}, \{e, f\}\}$  is an individually stable outcome, and  $\{\{a, b, d, e, f\}, \{c\}\}$  is Nash stable.

## 1.3 Justification of the model

The computational complexity of a problem is measured in terms of the size of its input and therefore depends on the representation of the problem instance. For coalition formation games, the number of players  $n$  is a natural parameter of the game. We desire *succinct representations*, where the size of the input is polynomial in  $n$ , otherwise, as the number of players grows it may become infeasible even to write down the game.

For succinct representations of hedonic games such as hedonic nets [25], it is NP-hard to decide whether there exists a Nash stable outcome. Indeed, this also holds for *non-symmetric* additively-separable games, which are represented by an edge-weighted *directed* graph [12, 17]. This implies that such a game may not have a stable outcome. We study a more restrictive model where stable outcomes (for all of the stability requirements we consider) are guaranteed to exist, noting that

our hardness results extend to all more general models where existence of stable outcomes is either guaranteed or promised, i.e., instances are restricted to those possessing stable outcomes. In a *symmetric* additively-separable hedonic game, for each of the stability requirements we consider, a stable outcome *always exists*. Define *total happiness* as the sum of the players' utilities. Then existence of a stable outcome is guaranteed by the following potential function argument:

**Observation 1** *Total happiness is a potential function for symmetric additively-separable hedonic games.*

More precisely, if a player unilaterally improves her utility by some additive  $\alpha$ , then the total happiness increases by  $2\alpha$ . This follows directly from the fact that two players are incident to each edge. The existence of a potential function implies that, for all our considered stability requirements, local improvements will find a stable outcome. Moreover, all the problems we consider are in the complexity class PLS (polynomial local search) [32], which we introduce next.

#### 1.4 Local search and the complexity class PLS

Local search is one of few general and successful approaches to difficult combinatorial optimisation problems. A local search algorithm tries to find an improved solution in the *neighborhood* of the current solution. A solution is *locally optimal* if there is no better solution in its neighborhood. Johnson et al. [32] introduced the complexity class PLS (polynomial local search) to capture those local search problems for which a better neighboring solution can be found in polynomial time if one exists, and a local optimum can be verified in polynomial time.

A problem in PLS comprises a finite set of candidate solutions. Every candidate solution has an associated non-negative integer cost, and a neighbourhood of candidate solutions. In addition, a PLS problem is specified by the following three polynomial-time algorithms that:

1. construct an initial candidate solution;
2. compute the cost of any candidate solution in polynomial time;
3. given a candidate solution, provide a neighbouring solution with lower cost if one exists.

The goal in a PLS problem is to find a local optimum, that is, a candidate solution whose cost is no more than the cost of any neighbouring candidate solution.

Suppose  $A$  and  $B$  are problems in PLS. Then  $A$  is PLS-reducible to  $B$  if there exist polynomial-time computable functions  $f$  and  $g$  such that  $f$  maps an instance  $I$  of  $A$  to an instance  $f(I)$  of  $B$ , and  $g$  maps the local optima of instance  $f(I)$  of  $B$  to local optima of instance  $I$ . A problem in PLS is PLS-complete if all problems in PLS are PLS-reducible to it. Prominent PLS-complete problems include finding a locally optimal max-cut in a graph (LOCALMAXCUT) [45], or a stable solution in a

Hopfield network [32]. PLS captures the problem of finding pure Nash equilibria for many classes of games where pure Nash equilibria are guaranteed to exist, such as congestion games [28], for which it is also PLS-complete to find a pure equilibrium.

On the one hand, finding a locally optimal solution is presumably easier than finding a global optimum; in fact, it is very unlikely that a PLS problem is NP-hard since this would imply  $\text{NP} = \text{coNP}$  [32]. On the other hand, a polynomial-time algorithm for a PLS-complete problem would resolve a number of longstanding open problems, e.g., it would show that *simple stochastic games* can be solved in polynomial time [50]. Thus, PLS-complete problems are believed not to admit polynomial-time algorithms.

## 1.5 Computational problems

We define the search problems, NASHSTABLE, IS (individually stable), CIS (contractually individually stable), VOTEIN, and VOTEOUT of finding a stable outcome for the respective stability requirement. We introduce VOTEINOUT as the search problem of finding an outcome which is vote-in and vote-out stable. All voting problems are parametrized by  $T_{in}$  and/or  $T_{out}$ . We recall that outcomes which are vote-in (resp. vote-out) stable with  $T_{in} = 1$  (resp.  $T_{out} = 1$ ) are also called *veto-in* (resp. *veto-out*) *stable*, so IS is the computational problem of finding a veto-in stable outcome, and CIS is the problem of finding an outcome that is both veto-in and veto-out stable. We also introduce SUMCIS as the problem of finding an outcome which is sum-in and sum-out stable.

Symmetric additively-separable hedonic games are closely related to party affiliation games [11], which are also specified by an undirected edge-weighted graph. In a party affiliation game each player must choose between one of two “parties”; a player’s happiness is the sum of her edges to nodes in the same party; in a Nash stable outcome no player would prefer to be in the other party. The problem PARTYAFFILIATION is to find a stable outcome in such a game. If such an instance has only negative edges then it is equivalent to the problem LOCALMAXCUT, which is to find a Nash stable outcome of a local max-cut game. Note that for LOCALMAXCUT all edges in the underlying graph are non-negative. In party affiliation games there are at most two coalitions, while in hedonic games any number of coalitions is allowed. Thus, whereas PARTYAFFILIATION for instances with only negative edges is PLS-complete [45], NASHSTABLE is trivial in this case, as the outcome where all players are in singleton coalitions is Nash stable. Both problems are trivial when all edges are non-negative, in which case the grand coalition of all players is Nash stable. Thus, interesting hedonic games contain both positive and negative edges.

We define a restricted version of PARTYAFFILIATION, called ONEENEMYPARTYAFFILIATION, in which each player dislikes at most one other player, i.e., each node is incident to at most one negative edge. We use the following variant of this problem as a starting point for several of our reductions.

**Definition 1.** We define the problem  $\text{ONEENEMYPARTYAFFILIATION}^*$  as a restricted version of  $\text{ONEENEMYPARTYAFFILIATION}$  which is restricted to instances where no player is ever indifferent between the two coalitions.

In other words, in an instance of  $\text{ONEENEMYPARTYAFFILIATION}^*$ , for every possible partition of the players into two coalitions, every player has a *strict* preference over the two coalitions.

## 1.6 Our results

In this paper, we examine the complexity of computing stable outcomes in symmetric additively-separable hedonic games. We observe that  $\text{NASHSTABLE}$ , i.e., the problem of computing a Nash stable outcome, is  $\text{PLS}$ -complete (Observation 2). Here, we give a simple reduction from  $\text{PARTYAFFILIATION}$ , which was shown to be  $\text{PLS}$ -complete in [45]. Our reduction relies on a method to ensure that all stable outcomes use exactly two coalitions (while in general there can be as many coalitions as players).

We then study  $\text{IS}$ , i.e., the problem of finding an individually-stable outcome. We show that if the outcome is restricted to contain at most two coalitions, an individually-stable outcome can be found in polynomial time (Proposition 1). This suggests that a reduction showing  $\text{PLS}$ -hardness for  $\text{IS}$  cannot be as simple as for  $\text{NASHSTABLE}$ : one needs to construct hedonic games that allow three or more coalitions. In order to prove that  $\text{IS}$  is  $\text{PLS}$ -complete, we first show that  $\text{ONEENEMYPARTYAFFILIATION}^*$  is  $\text{PLS}$ -complete (Theorem 3 and Corollary 1). The reduction to  $\text{ONEENEMYPARTYAFFILIATION}^*$  is from  $\text{CIRCUITFLIP}$ . It is rather involved and is our main technical result. We then reduce  $\text{ONEENEMYPARTYAFFILIATION}^*$  to  $\text{IS}$ . For this reduction, we replace every negative edge with a gadget, with the rest of the instance remaining intact. The internal nodes of the gadgets are restricted to belong to one of five coalitions, with all original nodes restricted to be in one of two coalitions as in  $\text{ONEENEMYPARTYAFFILIATION}^*$ . The “one enemy” property ensures that the gadgets do not interfere with each other and can be analysed in isolation. The “no indifference” property is needed for the gadgets to operate correctly.

Perhaps surprisingly, given the apparently restrictive nature of the stability requirement, we show that  $\text{SUMCIS}$  is  $\text{PLS}$ -complete (Theorem 5). In contrast, we show that the problem  $\text{CIS}$  of finding a contractually individually stable outcome can be solved in polynomial time. We make explicit two conditions in Propositions 2 and 3, both met in the case of  $\text{CIS}$ , that (individually) guarantee that local improvements converge in polynomial time. We use these propositions to give further positive results for other combinations of restrictions, where either the entering or leaving restriction is veto based.

Finally, we study the complexity of finding vote-in and vote-out stable outcomes. Using a different argument to the polynomial-time cases mentioned previously, we show that local improvements converge in polynomial time in the case of vote-in-stability and vote-out-stability with  $T_{in}, T_{out} > 0.5$  (Theorem 8). We show that if we

Enter / Leave	1: no restr.	2: sum-in	3: veto-in	4: vote-in
A: no restr.	NASHSTABLE PLS-complete Observation 2	PLS-complete Observation 2	IS PLS-complete Theorem 4	VOTEIN PLS-complete Theorem 6
B: sum-out	PLS-complete Theorem 5	SUMCIS PLS-complete Theorem 5	P Proposition 2	?
C: veto-out	P Proposition 3	P Proposition 3	CIS P Proposition 2 or 3	P Proposition 3
D: vote-out	VOTEOUT ? (see Theorem 7)	? (see Theorem 7)	P Proposition 2	VOTEINOUT P ( $T_{in}, T_{out} > 0.5$ ) Theorem 8

**Table 1.** Table showing the computational complexity of the search problems for different entering and leaving deviation restrictions. Note that columns 1 and 2 are essentially equivalent, since if a player has a Nash feasible deviation that results in a negative payoff, she also has a sum-in feasible (and hence also Nash feasible) deviation, namely to form a singleton coalition.

require vote-in-stability alone, we get a PLS-complete search problem (Theorem 6). The problem of finding a vote-out stable outcome is conceptually different (e.g., we can find a veto-out-stable outcome in polynomial time, whereas it is PLS-complete to find a veto-in-stable outcome). The technical difficulty in proving a hardness result for VOTEOUT is restricting the number of coalitions. Ultimately, we leave the complexity of VOTEOUT open, but do show that  $k$ -VOTEOUT, which is the problem of computing a vote-out stable outcome when at most  $k$  coalitions are allowed, is PLS-complete (Theorem 7).

Our results are summarized in Table 1, which gives an almost complete characterization of tractability.

## 1.7 Related work

*Stability concepts and existence of stable outcomes.* Many different stability concepts for hedonic games have been considered. Bogomolnaia and Jackson [17] first formulated Nash stability, individual stability, and contractual individual stability for hedonic games. We study all three of these concepts in this paper, and these concepts motivated us to introduce definitions of stability based on voting and aggregation. Many other related stability concepts for hedonic games have also been considered, including core stability [17], contractual Nash stability [47], strong Nash stability [33], perfect partitions [6], and strict strong Nash stability and strong individual stability [4]. A large body of work has studied conditions on hedonic games, such as restrictions on players' preferences, that guarantee the existence of these different types of stable outcomes [2, 4, 13, 17, 17, 19, 22, 23, 33]. Aziz and Savani [5]



provide a detailed overview of many of these solution concepts and related existence results; Sung and Dimitrov [47] provide an alternative classification of these concepts.

*Computational complexity of stable outcomes.* Ballester [12] was one of the first to study stable outcomes for hedonic games from the perspective of computational complexity. He showed that for hedonic games represented by an *individually rational list of coalitions*, the complexity of checking whether a core stable, Nash stable, or individually stable outcome exists is NP-complete. Elkind and Wooldridge [25] studied the computational complexity of problems related to stable outcomes of hedonic games that are represented by hedonic nets, a succinct, rule-based representation based on marginal contribution nets (which were introduced by Jeong and Shoham [31]). Sung and Dimitrov [48] showed NP-hardness of deciding whether a stable outcome exists in an additively-separable hedonic game for core stability, strict core stability, Nash stability, and individual stability. For core stability and strict core stability, those NP-hardness results have been extended by Aziz et al. [7] to the case of symmetric player preferences; as discussed in the introduction, Nash stable and individually stable outcomes always exist in symmetric additively separable games, so the corresponding decision problems are trivial. Woeginger [49] showed that deciding if a core stable outcome exists in an additively-separable hedonic game is actually not just NP-hard, but complete for the second level of the polynomial hierarchy; Peters [42] extended this result to show that the same tight complexity bound applies for deciding whether a *strict* core stable exists, even in *symmetric* additively-separable hedonic games.

Peters and Elkind [43] unified and extended several of these complexity results. They identify simple conditions on the expressivity of hedonic games formalism, which if met, imply that the problem of checking whether a given game admits a stable outcome is computationally hard. Their results cover a variety of stability concepts, such as core stability, individual stability, and Nash stability, and different hedonic game models, including additively-separable games and fractional hedonic games, discussed below. On the positive side, Peters [41] showed that the existence of several types of stable outcome can be decided in linear time for hedonic games that satisfy a notion of bounded treewidth and bounded degree.

*Fractional hedonic games.* In this paper we study additively separable hedonic games, where a player’s utility is defined as the sum of weights of edges between that player and the other members of that player’s coalition. Aziz et al. [8] introduced fractional hedonic games, where this sum is replaced by the *average*, i.e., the sum divided by the cardinality of the coalition. Aziz et al. [10], in an extended version of [8], propose a number of conditions under which the core of fractional hedonic games is non-empty and provide algorithms for computing a core stable outcome. By contrast, they show that the core may be empty in other cases, and that it is computationally hard in general to decide non-emptiness of the core. Bilò et al. [15] consider Nash stability in symmetric fractional hedonic games. They show that Nash stable outcomes cannot

be reached by best response dynamics in symmetric fractional hedonic games. They also prove that the problems of computing a best Nash stable coalition structure and an optimal one (not necessarily stable) are NP-hard. Aziz et al. [9] studied the computational complexity of computing welfare maximizing outcomes for fractional hedonic games, providing both hardness and approximation results.

In a *modified* fractional hedonic game, the utility of a player is the sum of weights of edges to players in the same coalition divided by the cardinality of the coalition *minus one*, i.e., ignoring the player itself. It turns out, that this small modification actually has quite a dramatic effect on the set of Nash stable outcomes. Modified fractional hedonic games were first studied by Olsen [39]. Monaco et al. [36] studied strong equilibria and core stable outcomes in modified fractional hedonic games. Bilò et al. [15] and Monaco et al. [36] discuss differences between modified and non-modified fractional hedonic games.

*Quality of stable outcomes.* In the field of algorithmic game theory, much attention has been paid to the quality of equilibria, as captured by measures such as the Price of Anarchy [34] and Price of Stability [3], which compare the welfare under worst or best-case Nash equilibria, respectively, with the optimal welfare over all possible outcomes. For hedonic games, analogous measures can be defined with Nash equilibrium replaced by an appropriate stability concept such as Nash or core stability. In this spirit, Brânzei and Larson [18] studied the trade-off between core stability and social welfare in additively-separable hedonic games. Elkind et al. [26] provided lower and upper bounds on the *Price of Pareto Optimality* in additively separable hedonic games, fractional hedonic games, and modified fractional hedonic games. Bilò et al. [15] study an analogue of the price of stability for fractional hedonic games, also for restricted graph topologies.

*Bargaining approaches to coalition formation.* Bloch and Diamantoudi [16] study a bargaining procedure for coalition formation in the setting of hedonic games: Given an order of the players, each player can propose an outcome, and the next player accepts the current proposal or vetoes it and make a counter-proposal. Chalkiadakis et al. [20] consider a deterministic bargaining process that produces coalition structures in coalitional games, with a focus on weighted voting games.

*Related work on PLS-completeness.* For surveys on the computational complexity of local search, see [1, 38]. Given the PLS-completeness of solving local max cut and party affiliation games, algorithms for finding approximate solutions have been studied [14, 21]; see also [40]. Our PLS-hardness results use ideas from Krentel [35], Monien and Tscheuschner [37], Schäffer and Yannakakis [45], and in particular Elsässer and Tscheuschner [27]. We use the PLS-completeness of LOCALMAXCUT which was shown by Schäffer and Yannakakis [45].

## 1.8 Outline of the paper

In Section 2, we show that `NASHSTABLE` is PLS-complete. In Section 3, we prove our main technical result: `ONEENEMYPARTYAFFILIATION` is PLS-complete. `ONEENEMYPARTYAFFILIATION` is the starting point for our reduction to `IS` (i.e., `VETOIN`) in Section 4, which shows that `IS` is PLS-complete. In Section 5, we show that the remaining veto-based problems, namely all those (except for `IS`) in row C and column 3 in Figure 1, can be solved in polynomial time. In Section 6, we show that the problem `SUMCIS` is PLS-complete. In Section 7, we give both positive and negative results for computing stable outcomes under various voting-based stability requirements. Finally, in Section 8, we conclude with open problems.

## 2 Nash stability and restricting the number of coalitions

In this section, we show that `NASHSTABLE` is PLS-complete via a reduction from `PARTYAFFILIATION`. Recall that in Nash stable outcomes for hedonic additively separable games, players might form more than two coalitions, while party affiliation games are restricted to two coalitions. To deal with this we use a mechanism, called *supernodes*, which can restrict the number of coalitions that will be non-empty in stable outcomes. In the reduction in this section we use two supernodes to restrict to two coalitions; later in the paper we will use a variable number of  $k$  supernodes to restrict the number of coalitions to  $k$ .

**Observation 2** `NASHSTABLE` is PLS-complete.

*Proof.* Consider an instance of `PARTYAFFILIATION`, represented as an edge-weighted graph  $G = (V, E, w)$ . We augment  $G$  by introducing two new players, called *supernodes*. Every player  $i \in V$  has an edge of weight  $W > \sum_{e \in E} |w_e|$  to each of the supernodes. The two supernodes are connected by an edge of weight  $-M$ , where  $M > |V| \cdot W$ . By the choice of  $M$  the two supernodes will be in different coalitions in any Nash stable outcome of the resulting hedonic game. Moreover, by the choice of  $W$ , each player will be in a coalition with one of the supernodes. So, in every Nash stable outcome we have exactly two coalitions. The fact that edges to supernodes have all the same weight directly implies a one-to-one correspondence between the Nash stable outcomes in the hedonic game and in the party affiliation game.  $\square$

## 3 Key technical result: `ONEENEMYPARTYAFFILIATION` is PLS-complete

In this section, we prove our key technical result, that `ONEENEMYPARTYAFFILIATION` is PLS-complete. The instances that we produce have the useful property that no player is ever indifferent between two coalitions, which we make explicit in Corollary 1. We use these special instances for other reductions in this paper.

The starting point for our reduction to ONEENEMYPARTYAFFILIATION is the prototypical PLS-complete problem CIRCUITFLIP, introduced and shown to be PLS-complete in [32].

**Definition 2.** *An instance of CIRCUITFLIP is a boolean circuit with  $n$  inputs and  $n$  outputs. A feasible solution is an assignment to the inputs and the value of a solution is the output treated as a binary number. The neighbourhood of an assignment consists of all assignments obtained by flipping exactly one input bit. The objective is to maximise the value of the output.*

*High-level overview of proof.* The following *natural algorithm* exists for solving CIRCUITFLIP: Start with a arbitrary bit-string  $c$  of length  $n$ ; search the neighbourhood  $c$  for a candidate solution with better value; if a better solution is found repeat, otherwise return the current solution, which is a local optimum.

In order to prove PLS-hardness of ONEENEMYPARTYAFFILIATION with a reduction from CIRCUITFLIP, we need to be able to turn an instance  $F$  of CIRCUITFLIP into an instance  $G$  of ONEENEMYPARTYAFFILIATION, so that any stable solution of  $G$  can be mapped in polynomial time to a local optimum of  $F$ . In essence, the way we will achieve this is as follows. Our reduction from an instance  $F$  of CIRCUITFLIP to an instance  $G$  of ONEENEMYPARTYAFFILIATION, will have the property that when better response dynamics is run on  $G$  it will simulate running the “natural algorithm” on  $F$ . A major complication is that we require that this works for *any* initial bi-partition that we start better response dynamics from in  $G$ , however in general an arbitrary bi-partition will not correspond to an obvious step of the natural algorithm applied to  $F$ . Our construction has a built-in “correction mechanism”, so that, after some initial phase, we will indeed have a direct correspondence between better response dynamics in  $G$  and the natural algorithm in  $F$ .

In more detail, we will use the following idea of Schäffer and Yannakakis [45]. Firstly, we extend the circuit in CIRCUITFLIP by adding extra outputs; the extended circuit computes the value of a bit-string as before, and also a canonical better solution if one exists, or the input if the current input is locally optimal. In our construction, there will be *two copies* of this extended circuit in the CIRCUITFLIP instance. The two circuit copies will alternate roles: One circuit will compute the output value of the current solution ( $c$  in the description above) and the next better solution  $c'$ . Then  $c'$  will be fed into the other circuit copy, which will compute the value of  $c'$  and a next better solution. Then the value of  $c$  and  $c'$  are compared, and if the value of  $c'$  is better, the two circuit copies swap roles, which starts the next iteration of the natural algorithm.

For each of these circuit copies, we will build gadgets in our ONEENEMYPARTYAFFILIATION instance that represent the gates of the circuit. Parts of the construction will monitor when one of the circuit copies is correctly computing its output, and only under appropriate conditions the roles of the two circuit copies will be swapped. Gates in our construction can be in one of two regimes: the FIX GATES regime,

which makes sure gates are computing correctly, and the RESET GATES regime, which gets gates ready for the two circuits to swap roles. During the initial phase of better response dynamics applied to the  $G$ , the gates will be fixed if required and at some point the current bi-partition will directly correspond to a correct intermediate state of the natural algorithm applied to  $F$ .

**Theorem 3.** ONEENEMYPARTYAFFILIATION *is PLS-complete.*

*Proof.* We reduce from CIRCUITFLIP. Let  $C$  be an instance of CIRCUITFLIP with inputs  $V_1, \dots, V_n$ , outputs  $C_1, \dots, C_n$ , and gates  $G_1, \dots, G_N$ . We make the following simplifying assumptions about  $C$ :

- (i) The gates are topologically ordered so that if the output of  $G_i$  is an input to  $G_j$  then  $i > j$ .
- (ii) All gates are NOR gates with fan-in 2.
- (iii)  $G_1, \dots, G_n$  is the output and  $G_{n+1}, \dots, G_{2n}$  is the (bitwise) negated output of  $C$  with  $G_1$  and  $G_{n+1}$  being the most significant bits.
- (iv)  $G_{2n+1}, \dots, G_{3n}$  outputs a (canonical) better neighbouring solution if  $V_1, \dots, V_n$  is not locally optimal, and otherwise returns the locally optimal input  $V_1, \dots, V_n$ .

We use two complete copies of  $C$ . One of them represents the current solution while the other one represents the next (better) solution. Each copy gives rise to a graph. We will start by describing our construction for one of the two copies and later show how they interact. Given  $C$  construct a graph  $G_C$  as follows:

We have nodes  $v_1, \dots, v_n$  representing the inputs of  $C$ , and nodes  $g_i$  representing the output of the gates of  $C$ . We will also use  $g_i$  to refer to the whole gate. For  $i \in [n]$ , denote by  $w_i := g_{2n+i}$  the nodes representing the better neighbouring solution. Recall that  $g_1, \dots, g_n$  represent the output of  $C$  while  $g_{n+1}, \dots, g_{2n}$  correspond to the negated output.

In our party affiliation game we use 0 and 1 to denote the two coalitions. We slightly abuse notation by using  $u = \kappa$  for  $\kappa \in \{0, 1\}$  to denote that node  $u$  is in coalition  $\kappa$ . In the construction, we assume the existence of nodes with a fixed coalition. This can be achieved as in the proof of Observation 2 with the help of supernodes. We use 0 and 1 to refer to those constant nodes. In the graphical representation (cf. Figure 4), we represent those constants by square nodes. Square nodes with the same number represent the the same supernode and are only shown separately to make the figures nicer.

We follow the exposition of both Schäffer and Yannakakis [45] and Elsässer and Tscheuschner [27] and use *types* of gadget to describe our construction. Nodes may be part of multiple types. We introduce 8 numbered types. In general, the higher the number of the type, the smaller the edge weights, so earlier types are “more important”. Different types will serve different purposes.

As in [27, 37], we use a mechanism for biasing nodes based on the coalitions of other nodes, as described by the following lemma and definition.

**Lemma 1.** For any polynomial-time computable function  $f : \{0, 1\}^k \mapsto \{0, 1\}^m$  one can construct a graph  $G_f = (V_f, E_f, w)$  having the following properties: (i) there exist  $s_1, \dots, s_k, t_1, \dots, t_m \in V_f$  with no negative incident edge, (ii) each node in  $V_f$  is only incident to at most one negative edge, (iii)  $f(s_1, \dots, s_k) = (t_1, \dots, t_m)$  in any Nash stable solution of the party affiliation game defined by  $G_f$ .

*Proof.* It is well known that for any polynomial-time computable function  $f : \{0, 1\}^k \mapsto \{0, 1\}^m$  one can construct a circuit  $C$  with polynomial many gates that implements this function [46, Theorem 9.30]. Clearly, we can also restrict  $C$  to NOR gates with fan-in and fan-out at most 2. Organize the gates in levels according to their distance to  $C$ 's output; output gates are at level 1.

We replace each gate  $g_i$  at level  $\ell$  with the gadget in Figure 2. Nodes  $a, b$  are inputs and  $d$  is the output of gate  $g_i$ .

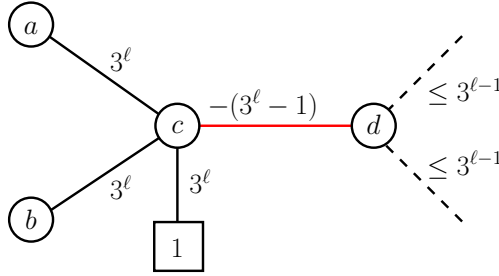

**Fig. 2.** NOR gate

Note that  $a$  and  $b$  are also either output nodes of some other gates of the circuit, or they correspond to inputs of the circuit. In the latter case we connect  $a$  or  $b$  to the corresponding input  $s$ -node by an edge of weight  $3^{\ell+1}$ .

If  $\ell = 1$ , i.e.,  $g_i$  is an output gate, then we connect  $d$  to the corresponding output  $t$ -node with an edge of weight 1. Otherwise ( $\ell > 1$ ),  $d$  is also the input to at most 2 lower level gates. The corresponding edges have weight at most  $3^{\ell-1}$ .

In any Nash stable solution,  $d = 1$  if and only if  $a = b = 0$ . In other words  $d = \text{NOR}(a, b)$ . The claim follows since our construction fulfils properties (i), (ii) and (iii).  $\square$

**Definition 3.** For a polynomial-time computable function  $f : \{0, 1\}^k \mapsto \{0, 1\}^m$  we say that  $G_f$  as constructed in Lemma 1 is a graph that looks at  $s_1, \dots, s_k \in V_f$  and biases  $t_1, \dots, t_m \in V_f$  according to the function  $f$ .

We are now ready to introduce the types of gadgets.

*Type 1: Check Gates.* For each gate  $g_i$  we have a three-part component as depicted in Figure 4(a). The inputs of  $g_i$ , denoted  $I_1(g_i)$  and  $I_2(g_i)$ , are either inputs of the circuit or outputs of some gate with larger index. The main purpose of this component is to

check if  $g_i$  is correct, i.e.,  $g_i = \neg(I_1(g_i) \wedge I_2(g_i))$ , and to set  $z_i = 1$  if  $g_i$  is incorrect. The nodes  $\alpha, \beta, \gamma, \delta$  and  $\lambda$  are local nodes for the gate. A gate can be in two operational modes, called *gate bias regimes*. Type 7 will determine in which of the following bias regimes a gate is.

**Definition 4 (Gate bias regimes).** *In the RESET GATE regime  $\alpha_{i,1}, \alpha_{i,2}, \gamma_{i,1}$  and  $\gamma_{i,2}$  get a bias towards 1 while  $\lambda_{i,1}, \lambda_{i,2}, \beta_{i,1}, \beta_{i,2}, \beta_{i,3}, \delta_{i,1}, \delta_{i,2}$  and  $\gamma_{i,3}$  get a bias towards 0. In the FIX GATE regime we have opposite biases.*

When we define Type 7 we will specify a function as needed for Definition 3. This function looks at a single node, whose current coalition (0 or 1) determines which regime we are in. The function biases the internal nodes of the Type 1 gadget according to Definition 4.

*Type 2: Propagate Flags.* In order to propagate values for the  $z$  variables we interconnect them as in Figure 4(b) by using the topological order on the gates. Observe that for any locally optimal solution  $z_i = 1$  enforces  $z_j = 1$  for all  $j < i$ . This component is also used to (help to) FIX the gates in order and to RESET them in the opposite order. Node  $z_{N+1}$  is for technical convenience.

Note that the three edges from each  $z_i$  node to the three nodes  $\gamma_{i,1}, \gamma_{i,2}$ , and  $\gamma_{i,2}$  are part of the type 1 gadget.

Type 1 and 2 components are the same for both copies. In the following we describe how the copies interact. We denote the two copies of  $C$  by  $C^0$  and  $C^1$  and also use superscripts to distinguish between them for nodes of type 1 and 2.

*Type 3: Set/Reset Circuits.* The component of type 3 interconnects the  $z$ -flags from the two circuits  $C^0, C^1$ , using the nodes  $z_0^1, z_0^0, z_1^0, z_1^1$ . This component is depicted in Figure 4(c) and has multiple purposes. First, it ensures that in a local optimum  $d^0$  and  $d^1$  are not both 1. Second, when certain conditions are met, it triggers to reset the circuit with smaller output. And third, it locks  $d^0$  or  $d^1$  to 1 and resets them back to 0 when certain conditions are met.

The  $z$  and  $y$  nodes can also be in two different operational modes called COMPUTE regime and RESET regime which is determined by Type 6.

**Definition 5 (Circuit bias regimes).** *Let  $\kappa \in \{0, 1\}$ . In the COMPUTE regime for  $z^\kappa$  all  $z_i^\kappa$  get a bias to 0 for all  $0 \leq i \leq N + 1$  and  $y^\kappa$  gets a bias to 1. In the RESET regime for  $z^\kappa$  we give opposite biases.*

When we define Type 6 we will specify a function that looks at several nodes and biases the  $z$  and  $y$  nodes according to Definition 5.

*Type 4: Check Outputs.* This component compares the current output of the two circuits and gives incentives to the nodes  $d^0$  or  $d^1$  accordingly: If  $C^0$  has a smaller output than  $C^1$  then  $d^0$  is incentivized to be 1; otherwise  $d^1$  is incentivized to be 1. For all  $i \in [n]$ , we have edges  $(d^0, g_{n+i}^0), (d^0, g_i^1), (d^1, g_{n+i}^1), (d^1, g_i^0)$  and  $(0, g_{n+i}^0), (1, g_i^1), (0, g_{n+i}^1), (1, g_i^0)$  of weight  $2^{2n+1-i}$ . To break symmetry we have edges  $(0, d^0), (1, d^1)$  of weight  $2^n$ .

*Type 5: Feedback Better Solution.* This component is depicted in Figure 4(d). It is used to feedback the improving solution of one circuit to the input of the other circuit. Its operation is explained in Lemma 2.

Figure 3 shows how the two circuit copies are constructed of type 1 gadgets and connected via types 2 to 5.

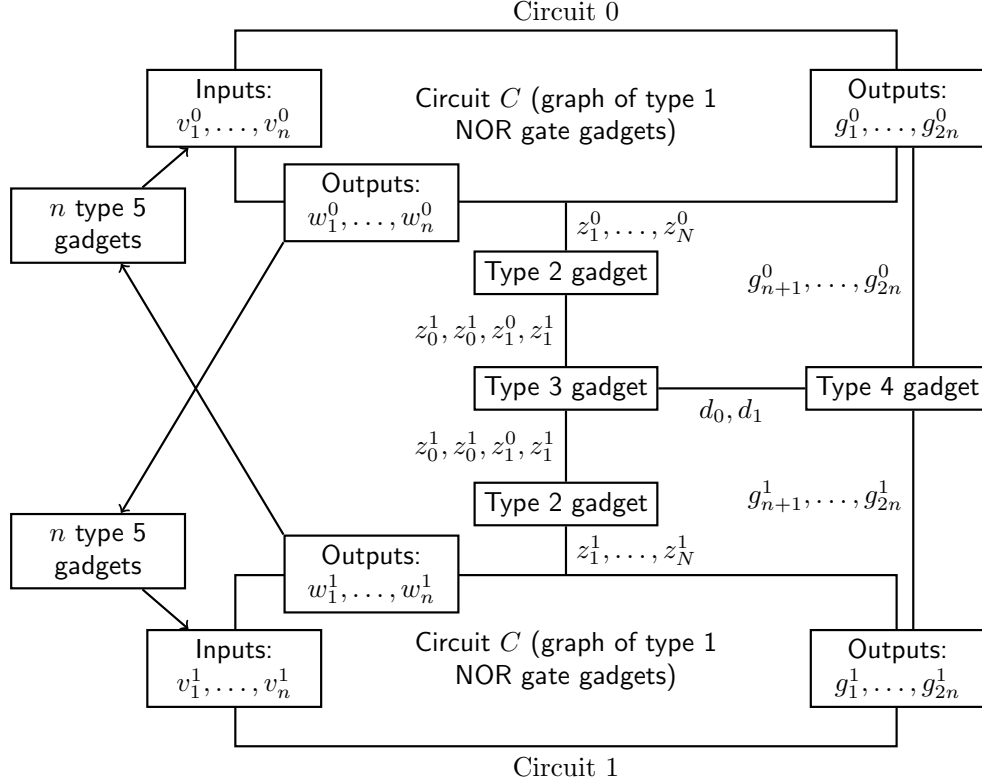
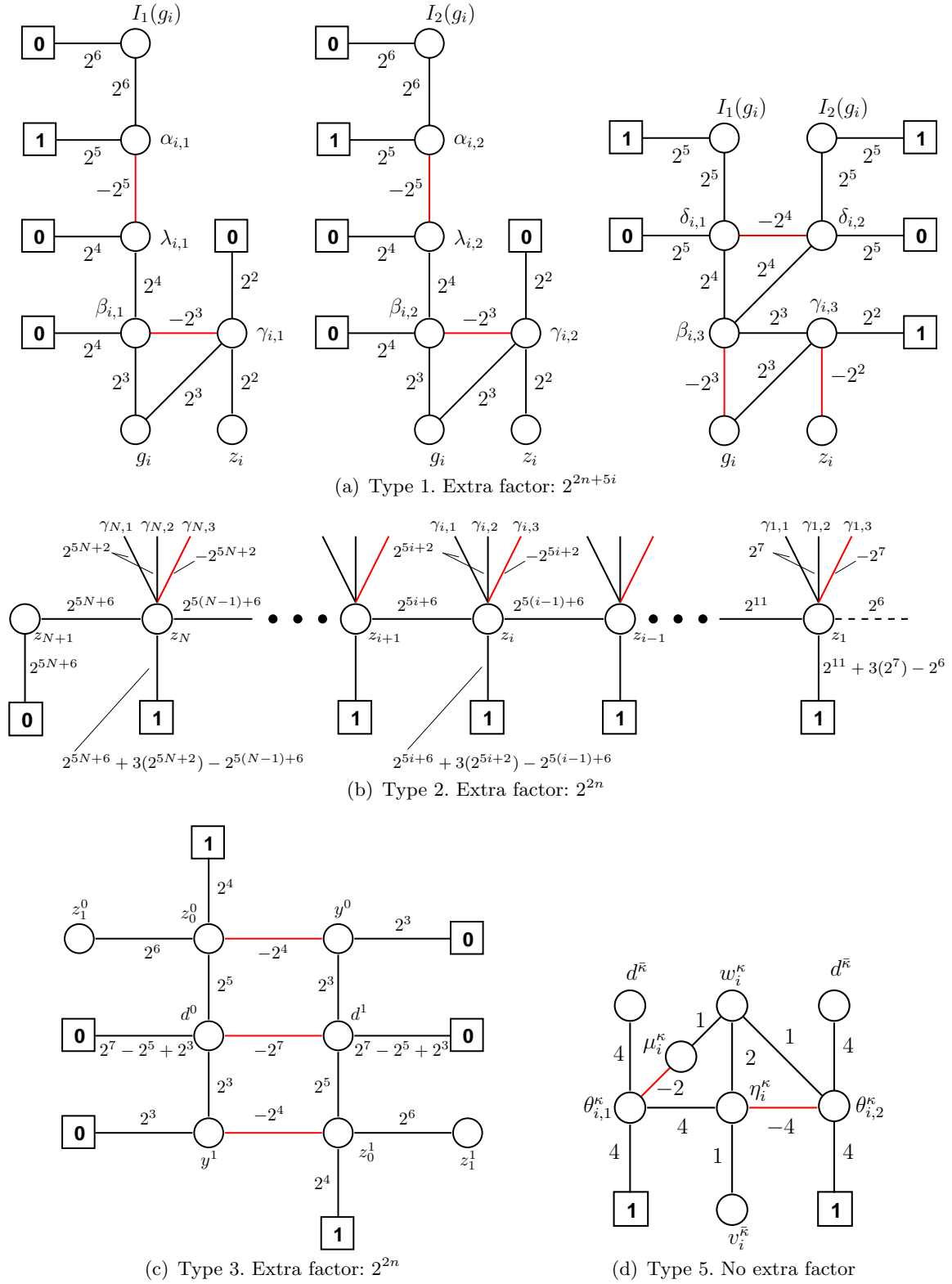

**Fig. 3.** Overview of construction. Shared nodes are shown on edges (except for type 5).

In the final three types we look at and bias nodes (as in Definition 3) from the lower types already defined. For the final types we do not give explicit edge weights. In order that the “looking” has no side-effects on the operation of the lower types, we scale edge weights in these types so that any edge weight of lower type is larger than the sum of the edge weights of all higher types. More precisely, for  $j \in \{5, 6, 7\}$ , the weight of the smallest edge of type  $j$  is larger than the sum of weights of all edges of types  $(j + 1), \dots, 8$ .

In the following, denote by  $C(v)$  the value of circuit  $C$  of the CIRCUITFLIP instance on input  $v = (v_i)_{i \in [n]}$  and  $w(v)$  the better neighbouring solution. Both are functions as in Definition 3.





**Fig. 4.** Components of type 1,2,3, and 5. Edge weights have to be multiplied by the factors given above.

*Type 6: Change Bias Regimes for  $z$ .* The component of type 6 looks at  $v^0, v^1, d^0, d^1, \eta^0$  and  $\eta^1$  (type 5) and biases  $z_i^0, z_i^1, y^0$  and  $y^1$  according to Definition 5 as follows.  $z^0$  is put in the COMPUTE regime if at least one of the following 3 conditions is fulfilled: (i)  $C(v^0) \geq C(v^1)$ , (ii)  $w(v^1) = v^0$ , or (iii)  $w(v^1) \neq \eta^1 \wedge d^0 = 1$ . Else  $z^0$  is put into the RESET regime. Likewise  $z^1$  is put in the COMPUTE regime if at least one of the following three conditions is fulfilled: (i)  $C(v^0) < C(v^1)$ , (ii)  $w(v^0) = v^1$ , or (iii)  $w(v^0) \neq \eta^0 \wedge d^1 = 1$ . Else  $z^1$  is put into the RESET regime. Note that conditions (i) and (ii) are important for normal computation, while (iii) is needed to overcome bad starting configurations.

*Type 7: Change Bias Regimes for Gates.* For each  $i \in [N]$  and  $\kappa \in \{0, 1\}$ , if  $z_{i+1}^\kappa = 0$  we put the internal nodes of  $g_i^\kappa$  in the FIX GATE regime and in the RESET GATE regime otherwise. We do this by looking at  $z_{i+1}^\kappa$  and biasing the internal nodes of the corresponding type 1 gadget as in Definition 4.

*Type 8: Fix Incorrect Gate.* For each  $i \in [N]$  and  $\kappa \in \{0, 1\}$ , the components of type 8 give a tiny bias to  $g_i^\kappa$  for computing correctly. In detail, for each gate  $g_i^\kappa$  we look at  $\alpha_{i,1}^\kappa, \alpha_{i,2}^\kappa$  and bias  $g_i^\kappa$  to  $\neg(\alpha_{i,1}^\kappa \wedge \alpha_{i,2}^\kappa)$ .

This completes our construction. We proceed by showing properties of Nash stable outcomes. Each of the following six lemmas should be read with the implicit clause: “In every Nash stable outcome.”

The following lemma explains the operation of type 5 gadgets. Depending on  $d^0$  ( $d^1$ ) it gives the inputs  $v^1$  ( $v^2$ ) an incentive to copy the better solution  $w^1$  ( $w^0$ ) of the other circuit or it makes sure that  $w^1$  ( $w^0$ ) are indifferent with respect to type 5 edges.

**Lemma 2.** *Let  $\kappa \in \{0, 1\}$ , then the following holds for all  $i \in [n]$ :*

- (a) *If  $d^\kappa = 0$  then  $w_i^\kappa$  is indifferent w.r.t. edges of type 5.*
- (b) *If  $d^\kappa = 1$  then  $\eta_i^\kappa = w_i^\kappa$ .*

*Proof.* Suppose  $d^\kappa = 0$ . If  $\eta_i^\kappa = 0$  then  $\theta_{i,1}^\kappa = 1$  and  $\theta_{i,2}^\kappa = \mu_i^\kappa = 0$ , and hence  $w_i^\kappa$  is indifferent w.r.t. edges of type 5. The case  $\eta_i^\kappa = 1$  is symmetric. This proves (a). If  $d^\kappa = 1$  then  $\theta_{i,1}^\kappa = \theta_{i,2}^\kappa = 1$ , so  $\eta_i^\kappa$  is indifferent w.r.t. the edges connecting it to  $\theta_{i,1}^\kappa$  and  $\theta_{i,2}^\kappa = 1$ . Hence  $\eta_i^\kappa$  will copy the value of  $w_i^\kappa$ , which proves (b).  $\square$

We proceed by showing how type 1 gadgets ensure that an incorrect gate enforces the corresponding  $z$  node to be set to 1 and how this gets propagated through the type 2 gadget.

**Lemma 3.** *If  $g_i^\kappa$  is incorrect then  $z_i^\kappa = 1$ . If  $z_i^\kappa = 1$  then  $z_j^\kappa = 1$  for all  $0 \leq j \leq i$  and  $y^\kappa = 0$ .*

*Proof.* Gate  $g_i^\kappa$  can be incorrect in two ways:

- (i)  $I_j(g_i^\kappa) = 1$  for some  $j \in \{1, 2\}$  and  $g_i^\kappa = 1$ ,

(ii)  $I_1(g_i^\kappa) = I_2(g_i^\kappa) = 0$  and  $g_i^\kappa = 0$ .

For case (i) observe that  $I_j(g_i^\kappa) = 1 \implies \alpha_{i,j}^\kappa = 1 \implies \lambda_{i,j} = 0 \implies \beta_{i,j}^\kappa = 0$ . Together with  $g_i^\kappa = 1$  this directly implies  $\gamma_{i,j}^\kappa = 1$ . Consider now case (ii). Since  $I_1(g_i^\kappa) = I_2(g_i^\kappa) = 0$  we have  $\delta_{i,1}^\kappa = \delta_{i,2}^\kappa = 0$  and therefore  $\beta_{i,3}^\kappa = 0$ . Together with  $g_i^\kappa = 0$  this directly implies  $\gamma_{i,3}^\kappa = 0$ . In either case, this implies  $z_i^\kappa = 1$ , proving the first part of the lemma.

The second claim holds by induction, since  $z_i^\kappa = 1$  enforces  $z_{i-1}^\kappa = 1$ , while  $z_0^\kappa = 1$  enforces  $y^\kappa = 0$ .  $\square$

The next lemma shows how the  $z$  nodes can make the inputs of gates indifferent with respect to type 1 edges of that gate. This is important so that gates with smaller index can change their output.

**Lemma 4.** *If  $z_{i+1}^\kappa = 1$  then the inputs  $I_1(g_i^\kappa)$  and  $I_2(g_i^\kappa)$  are indifferent with respect to the type 1 edges of gate  $g_i^\kappa$ .*

*Proof.* We show that  $\alpha_{i,1}^\kappa = \alpha_{i,2}^\kappa = 1$  and  $\delta_{i,1}^\kappa = \delta_{i,2}^\kappa = 0$ , which implies the claim. According to type 7, since  $z_{i+1}^\kappa = 1$ , gate  $i$  is in the RESET GATE regime.

We first show that in this regime, we must have  $\alpha_{i,1}^\kappa = \alpha_{i,2}^\kappa = 1$ . It is immediate that if  $I_j(g_i^\kappa) = 1$  then  $\alpha_{i,j}^\kappa = 1$  for  $j \in \{1, 2\}$ . We now show that  $I_j(g_i^\kappa) = 0$  implies  $\alpha_{i,j}^\kappa = 1$  for  $j \in \{1, 2\}$ . Suppose, without loss of generality, that  $j = 1$ . Suppose  $I_1(g_i^\kappa) = 0$  and for the sake of contradiction that  $\alpha_{i,1}^\kappa = 0$ . Since  $\alpha_{i,1}^\kappa$  is biased to 1 it can only be 0 if  $\lambda_{i,1}^\kappa = 1$ . Since  $\lambda_{i,1}^\kappa$  is biased to 0, it can only be 1 if  $\beta_{i,1}^\kappa = 1$ . Since  $\beta_{i,1}^\kappa$  is biased to 0, it can only be 1 if  $g_i = 1$  and  $\gamma_{i,1}^\kappa = 0$ . However, since  $\beta_{i,1}^\kappa = 1$  and  $g_i^\kappa = 1$  and  $\gamma_{i,1}^\kappa$  is biased to 1, we have  $\gamma_{i,1}^\kappa = 1$ . Thus  $\alpha_{i,1}^\kappa = 1$ .

We are left to show that in the RESET GATE regime we must have  $\delta_{i,1}^\kappa = \delta_{i,2}^\kappa = 0$ . If  $(I_1(g_i^\kappa), I_2(g_i^\kappa)) = (0, 0)$ , it is immediate that  $\delta_{i,1}^\kappa = \delta_{i,2}^\kappa = 0$ . Suppose  $(I_1(g_i^\kappa), I_2(g_i^\kappa)) = (0, 1)$ . Then it is immediate that  $\delta_{i,1}^\kappa = 0$ , and then since  $\delta_{i,2}^\kappa$  is biased to 0, it must also be 0. The case  $(I_1(g_i^\kappa), I_2(g_i^\kappa)) = (1, 0)$  is symmetric. Finally, suppose  $(I_1(g_i^\kappa), I_2(g_i^\kappa)) = (1, 1)$ . If  $\delta_{i,1}^\kappa = \delta_{i,2}^\kappa = 1$  then it is immediate that  $\beta_{i,3}^\kappa = 1$ . Then  $\delta_{i,1}^\kappa$  and  $\delta_{i,2}^\kappa$  are both indifferent to the edges of type 1, but they are not stable since they are biased to 0. Suppose  $\delta_{i,1}^\kappa = 1$  and  $\delta_{i,2}^\kappa = 0$ . If  $\beta_{i,3}^\kappa = 0$  then  $\delta_{i,1}^\kappa$  is indifferent to the edges of type 1, but is biased to 0 and hence is not stable. If  $\beta_{i,3}^\kappa = 1$ , then since  $\beta_{i,3}^\kappa$  is biased to 0, we must have  $g_i = 0$  and  $\gamma_{i,3}^\kappa = 1$ . But then  $\gamma_{i,3}^\kappa$  is not stable since it is biased to 0. The case  $\delta_{i,1}^\kappa = 0$  and  $\delta_{i,2}^\kappa = 1$  is symmetric.  $\square$

The following two lemma are important for being able to correct gates in the appropriate circumstances.

**Lemma 5.** *Suppose  $z_{i+1}^\kappa = 0$  and  $z_i^\kappa = 1$  for some index  $1 \leq i \leq N$ .*

(a) *If  $g_i^\kappa$  is correct then  $\gamma_{i,1}^\kappa = \gamma_{i,2}^\kappa = 0$  and  $\gamma_{i,3}^\kappa = 1$ .*

(b) *If  $g_i^\kappa$  is not correct then  $g_i^\kappa$  is indifferent w.r.t. edges of type 1 but w.r.t. the edges only in type 8 deviating would improve her happiness.*

*Proof.* According to type 7, since  $z_{i+1}^\kappa = 0$ , gate  $i$  is in the FIX GATE regime. Thus  $\gamma_{i,1}^\kappa$  and  $\gamma_{i,2}^\kappa$  are biased to 0. First suppose the gate is correct.

If the correct output is 0 then we have  $g_i^\kappa = 0$ , and  $z_i^\kappa = 1$  by assumption. Then  $\gamma_{i,1}^\kappa$  and  $\gamma_{i,2}^\kappa$  either prefer 0 or are indifferent w.r.t. the edges in type 1 (depending on the values of  $\beta_{i,1}^\kappa$  and  $\beta_{i,2}^\kappa$ ). As they are biased to 0 they will be 0. Suppose that  $\gamma_{i,3}^\kappa = 0$  for the sake of contradiction. Then since it is biased to 1, we must have  $\beta_{i,3}^\kappa = 0$ . Since  $\beta_{i,3}^\kappa$  is biased to 1, we must have  $\delta_{i,1}^\kappa = \delta_{i,2}^\kappa = 0$ . However, as the correct output is 0, at least one of the input bits must be 1. Suppose w.l.o.g. that  $I_1(g_i^\kappa) = 1$ . Then, since  $\delta_{i,1}^\kappa$  is indifferent w.r.t. the edges in type 1 and is biased to 1, it must be 1, a contradiction.

Now suppose the correct output is 1. Thus we have  $g_i^\kappa = 1$ , and  $z_i^\kappa = 1$  by assumption. Then  $\gamma_{i,3}^\kappa$  either prefers 1 or is indifferent w.r.t. the edges in type 1 (depending on the value of  $\beta_{i,3}^\kappa$ ). Since  $\gamma_{i,3}^\kappa$  is biased to 1, it will be 1. Suppose that  $\gamma_{i,1}^\kappa = 1$  for the sake of contradiction. Since  $\gamma_{i,1}^\kappa$  is biased to 0 it can only be 1 if  $\beta_{i,1}^\kappa = 0$ . Since  $\beta_{i,1}^\kappa$  is biased to 1 it can only be 0 if  $\lambda_{i,1}^\kappa = 0$ . Since  $\lambda_{i,1}^\kappa$  is biased to 1 it can only be 0 if  $\alpha_{i,1}^\kappa = 1$ . Since the output is 1 the input  $I_1(g_i^\kappa) = 0$ , and then since  $\alpha_{i,1}^\kappa$  is indifferent w.r.t. the edges in type 1 and is biased to 0, it must be 0, a contradiction. The same reasoning applies for  $\gamma_{i,2}^\kappa$ . This completes the proof of (a).

Now suppose the output is incorrect. Note that  $g_i$  is indifferent w.r.t. the edges of type 1 if and only if  $\beta_{i,1}^\kappa \neq \gamma_{i,1}^\kappa$  and  $\beta_{i,2}^\kappa \neq \gamma_{i,2}^\kappa$  and  $\beta_{i,3}^\kappa = \gamma_{i,3}^\kappa$ .

First suppose the output is 0. Thus we have  $g_i^\kappa = 0$ , and  $z_i^\kappa = 1$  by assumption. Since the output is 0 and incorrect, we have  $I_1(g_i^\kappa) = I_2(g_i^\kappa) = 0$ ,

Suppose  $\beta_{i,1}^\kappa = \gamma_{i,1}^\kappa = 1$ . Then  $\gamma_{i,1}^\kappa$  is indifferent w.r.t. the edges in type 1 and is biased to 0, a contradiction. Now suppose  $\beta_{i,1}^\kappa = \gamma_{i,1}^\kappa = 0$ . Since  $\beta_{i,1}^\kappa$  is biased to 1, we have  $\lambda_{i,1}^\kappa = 0$ . Since  $\lambda_{i,1}^\kappa$  is biased to 0, we have  $\alpha_{i,1}^\kappa = 1$ . But  $\alpha_{i,1}^\kappa$  is indifferent w.r.t. the edges of type 1 and biased to 0, a contradiction. Thus  $\beta_{i,1}^\kappa \neq \gamma_{i,1}^\kappa$  and likewise  $\beta_{i,2}^\kappa \neq \gamma_{i,2}^\kappa$ .

Now suppose  $\beta_{i,3}^\kappa = 1$  and  $\gamma_{i,3}^\kappa = 0$ . Then  $\gamma_{i,3}^\kappa$  is indifferent w.r.t. the edges in type 1 and biased to 1, a contradiction. Now suppose  $\beta_{i,3}^\kappa = 0$  and  $\gamma_{i,3}^\kappa = 1$ . Then  $\gamma_{i,3}^\kappa$  prefers to be 0 than 1, a contradiction. We have shown that  $g_i^\kappa$  is indifferent w.r.t. edges of type 1 when the output is 0 and incorrect.

Since  $I_1(g_i^\kappa) = I_2(g_i^\kappa) = 0$ , and  $\alpha_{i,1}^\kappa$  and  $\alpha_{i,2}^\kappa$  are biased to 0, we have  $\alpha_{i,1}^\kappa = \alpha_{i,2}^\kappa = 0$ . Thus type 8 biases  $g_i^\kappa$  to 1, and it would gain by flipping as claimed.

Now suppose the output is 1. Thus we have  $g_i^\kappa = 1$ , and  $z_i^\kappa = 1$  by assumption. Suppose  $\beta_{i,1}^\kappa = \gamma_{i,1}^\kappa = 0$ . Then  $\gamma_{i,1}^\kappa$  prefers to be 1 than 0, a contradiction. Suppose  $\beta_{i,1}^\kappa = \gamma_{i,1}^\kappa = 1$ . Then  $\gamma_{i,1}^\kappa$  is indifferent w.r.t. edges of type 1 and is biased to 0, a contradiction. Thus  $\beta_{i,1}^\kappa \neq \gamma_{i,1}^\kappa$  and likewise  $\beta_{i,2}^\kappa \neq \gamma_{i,2}^\kappa$ .

Now suppose  $\beta_{i,3}^\kappa = 1$  and  $\gamma_{i,3}^\kappa = 0$ . Then  $\gamma_{i,3}^\kappa$  prefers to be 1 than 0, a contradiction. Now suppose  $\beta_{i,3}^\kappa = 0$  and  $\gamma_{i,3}^\kappa = 1$ . Since  $\beta_{i,3}^\kappa$  is biased to 1, we must have  $\delta_{i,1}^\kappa = \delta_{i,2}^\kappa = 0$ . Since the output is 1 and incorrect, we have at least one of  $I_1(g_i^\kappa)$  and  $I_2(g_i^\kappa)$  equal to 1. Suppose w.l.o.g. that  $I_1(g_i^\kappa) = 1$ . Then, since  $\delta_{i,1}^\kappa$  is indifferent w.r.t. the edges

in type 1 and is biased to 1, it must be 1, a contradiction. We have shown that  $g_i^\kappa$  is indifferent w.r.t. edges of type 1 when the output is 1 and incorrect.

At least one of  $I_1(g_i^\kappa)$  and  $I_2(g_i^\kappa)$  are 1. Suppose w.l.o.g. that  $I_1(g_i^\kappa) = 1$ . Then  $\alpha_{i,1}^\kappa = 1$ . Thus type 8 biases  $g_i^\kappa$  to 0, and it would gain by flipping as claimed. This completes the proof of (b).  $\square$

**Lemma 6.** *If  $d^\kappa = 1$  and  $d^{\bar{\kappa}} = 0$  then for all  $1 \leq i \leq 2n$ , node  $g_i^\kappa$  is indifferent w.r.t. edges in type 4.*

*Proof.* Each of these nodes is incident to exactly two type 4 edges both having the same weight. For  $1 \leq i \leq n$  these are  $(1, g_i^\kappa)$  and  $(d^{\bar{\kappa}}, g_i^\kappa)$ , while for  $n + 1 \leq i \leq 2n$  these are  $(0, g_i^\kappa)$  and  $(d^\kappa, g_i^\kappa)$ . The claim follows since  $d^\kappa = 1$  and  $d^{\bar{\kappa}} = 0$ .  $\square$

We proceed by showing how the COMPUTE and RESET regimes influence  $z$  and  $y$  nodes.

**Lemma 7.** *Suppose  $d^\kappa = 1$  and  $d^{\bar{\kappa}} = 0$ .*

- (a) *If  $z^\kappa$  is in the COMPUTE regime then  $z_i^\kappa = 0$  for all  $0 \leq i \leq N + 1$  and  $y^\kappa = 1$ .*
- (b) *If  $z^\kappa$  is in the RESET regime then  $z_i^\kappa = 1$  for all  $0 \leq i \leq N + 1$  and  $y^\kappa = 0$ .*

*Proof.* We start proving part (a). Since  $z^\kappa$  is in the COMPUTE regime we immediately get  $z_{N+1}^\kappa = 0$ . Assume, by way of contradiction, that there exists an index  $1 \leq i \leq N$  such that  $z_i^\kappa = 1$  and  $z_{i+1}^\kappa = 0$ . First assume  $g_i^\kappa$  is correct. Then  $\gamma_{i,1}^\kappa = \gamma_{i,2}^\kappa = 0$  and  $\gamma_{i,3}^\kappa = 1$  by Lemma 5(a). This and the fact that  $z_{i+1}^\kappa$  is biased to 0 implies that  $z_i^\kappa = 0$ , a contradiction. Now assume  $g_i^\kappa$  is not correct. Then, by Lemma 5(b),  $g_i^\kappa$  is indifferent w.r.t. edges of type 1 but w.r.t. the edges only in type 8 flipping would improve her happiness. If  $3n + 1 \leq i \leq N$  this already implies that  $g_i^\kappa$  would gain by switching, a contradiction. For the outputs and negated outputs, i.e.,  $1 \leq i \leq 2n$ , we know by Lemma 6 that  $g_i^\kappa$  is indifferent w.r.t. edges in type 4. Moreover for the gates that represent the better neighbouring solution, i.e.  $2n + 1 \leq i \leq 3n$ , we know by Lemma 2(a) that  $g_i^\kappa$  is indifferent w.r.t. edges in type 5. (Recall that  $w_i^\kappa$  is just another name for  $g_{2n+i}^\kappa$ .) In either case,  $g_i^\kappa$  would gain by switching, a contradiction. Thus,  $z_i^\kappa = 0$  for all  $1 \leq i \leq N$ . It remains to show that  $z_0^\kappa = 0$  and  $y^\kappa = 1$ . Since  $z_1^\kappa = 0$  and  $z^\kappa$  is in the COMPUTE regime, we get (by inspection of type 3 edges) that  $z_0^\kappa = 0$  which then implies  $y^\kappa = 1$ . This completes the proof of part (a).

To see part (b), observe that  $d^{\bar{\kappa}} = 0$  together with the bias of  $y^\kappa$  to 0 implies  $y^\kappa = 0$ . Now since  $y^\kappa = 0$  and  $d^\kappa = 1$  the bias of  $z_0^\kappa$  enforces  $z_0^\kappa = 1$ . The rest is by induction since  $z_i^\kappa = 1$  and the bias directly implies  $z_{i+1}^\kappa = 1$  for all  $0 \leq i \leq N$ . This completes the proof of part (b).  $\square$

We now continue with the proof of Theorem 3. Suppose we are in a Nash stable outcome of the party affiliation game. For our proof we assume  $C(v^0) \geq C(v^1)$ . We will point out the small differences of the other case afterwards. Since  $C(v^0) \geq C(v^1)$ ,

$z^0$  is in the COMPUTE regime, i.e., all  $z_i^0$  are biased to 0 and  $y^0$  is biased to 1 (by type 6). Thus,  $z_{N+1}^0 = 0$ .

The remainder of the proof splits depending on the coalition of  $z_1^0$  and  $z_1^1$ . By Lemma 3 we know that  $z_1^k = 0$  implies that all gates in  $C^k$  are correct.

$z_1^0 = 1$ : By Lemma 3 we have  $z_0^0 = 1$  and  $y^0 = 0$ . If  $d^0 = d^1 = 0$  then  $d^0$  is better off changing to 1 (by inspection of type 3 edges). If  $d^0 = 1$  then Lemma 7(a) implies  $z_1^0 = 0$ , a contradiction. If  $d^1 = 1$  and  $z^1$  is in the RESET regime then by Lemma 7(b) and Lemma 4,  $v^1$  is indifferent w.r.t. type 1 edges. Thus  $v^1 = \eta^0$ . But then either condition (ii) or (iii) for putting  $z^1$  in the COMPUTE regime (cf. type 6) are fulfilled. So  $z^1$  has to be in the COMPUTE regime. Lemma 7(a) then implies  $z_1^1 = 0$ . But then the neighbourhood of  $d^1$  in type 3 is dominated by 0, a contradiction to  $d^1 = 1$ .

$z_1^0 = 0$  and  $z_1^1 = 1$ : By Lemma 3 we have  $z_0^1 = 1$  and  $y^1 = 0$ . Since  $C(v^0) \geq C(v^1)$  we know that  $z^0$  is in the COMPUTE regime. So  $z_1^0 = 0$  enforces  $z_0^0 = 0$  and  $y^0 = 0$ . By inspection of type 3 edges we have  $d^0 = 0$  and thus  $d^1 = 1$ . First assume that  $z^1$  is in the RESET regime, then  $z_i^1 = 1$  for all  $0 \leq i \leq N+1$  and Lemma 4 says that the inputs of all gates  $g_i^1$  are indifferent w.r.t. type 1 edges. In particular this holds for  $v^1 = (v_i^1)_{i \in [n]}$ , so  $v^1 = \eta^0$ . By Lemma 2(b),  $\eta^0 = w^0$ . Since  $z_1^0 = 0$ ,  $C^0$  is computing correctly and thus  $w^0 = w(v^0)$ . Combining this we get  $v_1 = w(v^0)$  which contradicts our assumption that  $z^1$  is in the RESET regime. Thus  $z^1$  is in the COMPUTE regime. Since  $d^1 = 1$  we can apply Lemma 7(a) to conclude  $z_1^1 = 0$ , a contradiction.

$z_1^0 = 0$  and  $z_1^1 = 0$ : By Lemma 3 we have  $z_0^0 = z_0^1 = 0$  and  $y^0 = y^1 = 1$ . Moreover we know that both circuits are computing correctly. If  $d^0 = 1$  then  $d^1 = 0$  and  $d^0$  is indifferent w.r.t. type 3 edges. Since both circuits are computing correctly and  $C(v^0) \geq C(v^1)$ , the type 4 edges enforce  $d^0 = 0$ . But then  $d^1$  is indifferent w.r.t. type 3 edges and the type 4 edges enforce  $d^1 = 1$ . So,  $d^0 = 0$  and  $d^1 = 1$ . If  $z^1$  is in the RESET regime then Lemma 7(b) gives  $z_1^1 = 1$ , a contradiction. Thus,  $z^1$  is in the COMPUTE regime. Since  $d^1 = 1$  we can apply Lemma 2(b). This and the fact that  $C^0$  is computing correctly implies  $\eta^0 = w(v^0)$ . So  $z^1$  can only be in the COMPUTE regime if  $v^1 = w(v^0)$ . Since  $C(v^0) \geq C(v^1)$  this implies that  $v^0 = v^1$  is a local optimum for the circuit  $C$ .

This finishes the proof in case  $C(v^0) \geq C(v^1)$ . The case  $C(v^0) < C(v^1)$  is completely symmetric except here the conclusion  $v^0 = v^1$  in the very last sentence leads to the contradiction  $C(v^0) < C(v^0)$ . So this case can't happen in a local optimum.

Note that throughout the construction we made sure that no node is incident to more than one negative edge. This completes the proof of Theorem 3.  $\square$

The instance produced by this reduction has the property that no node is indifferent between the two coalitions. We will make use of this property later in the paper.

**Corollary 1.** *ONEENEMYPARTYAFFILIATION is PLS-complete even if restricted to instances where no player is ever indifferent between the two coalitions, i.e. ONEENEMYPARTYAFFILIATION\* is PLS-complete.*

## 4 Individual stability

In this section, we study the computational complexity of finding individually stable outcomes. We first provide a polynomial-time algorithm for 2-IS, which we define as the problem of finding an individually stable outcome when at most two coalitions can form, i.e., we restrict the maximum number of coalitions in the problem definition as for PARTYAFFILIATION. The main result in this section is that IS is PLS-complete. We reduce from ONEENEMYPARTYAFFILIATION\* that was shown to be PLS-complete in the previous section. Our reduction uses exactly 5 coalitions, a restriction which we enforce using supernodes. We leave open the computational complexity of the problems 3-IS and 4-IS, where at most 3 or 4, respectively, coalitions can form.

**Proposition 1.** *2-IS can be solved in polynomial time.*

*Proof.* We assume that there is at least one negative edge. Otherwise, the grand coalition is Nash stable (and thus individually stable). The algorithm goes as follows:

Start with any bipartition. Move nodes with incident negative edges so that they have a negative edge to the other coalition. In this process, each node will move at most once, since after a move of a node  $u$ , there is a negative edge between  $u$  and some other node  $v$  in the other coalition, and we will never need to move either  $u$  or  $v$  again. In each of the two parts (coalitions), contract all nodes with negative incident edges into a single node and call the contracted nodes  $s$  and  $t$ . For any other node the new edge weights to  $s$  and  $t$  are the sum of the original edge weights to the corresponding contracted nodes. Now (ignoring all edges between  $s$  and  $t$ ) compute a min cut between  $s$  and  $t$  via a max flow algorithm and assign the nodes accordingly.

After the first stage, all nodes that we are about to contract have a negative edge to the other coalition. So they are not allowed to join the other coalition. After the contraction this property is preserved since the algorithm will not move contracted nodes anymore. The flow algorithm operates only on positive edges and computes a global minimum cut between  $s$  and  $t$ . Thus, the cut also maximizes the total happiness of all non-contracted nodes. So none of these nodes have an incentive to switch coalitions, since unilateral improvements would further increase the total happiness (recall Observation 1). All performed steps of the algorithm can be done in polynomial time.  $\square$

Next we show that IS is PLS-complete<sup>2</sup> when we do not impose a restriction on the number of coalitions in the problem definitions as we did for 2-IS.

**Theorem 4.** *IS is PLS-complete.*

<sup>2</sup> The version of Theorem 4 that appeared in [30] missed a special case that is dealt with here.

*Proof.* Throughout this proof, “stability” refers to “individual stability”.

We start with an instance of `ONEENEMYPARTYAFFILIATION*`. The instance has the property that no player is ever indifferent between the two coalitions that make up a stable outcome. We add five supernodes which are connected by a complete graph of sufficiently large negative edges. This enforces that in any stable outcome the supernodes are in different coalitions, say 0, 1, 2, 3, 4. The supernodes are used to *restrict* which coalition a node can be in in a stable outcome. This is achieved by having large positive edges of equal weight to the corresponding supernodes. All original nodes of the `ONEENEMYPARTYAFFILIATION*` instance are restricted to be 0 or 1.

We now show how to simulate a negative edge of `ONEENEMYPARTYAFFILIATION*` by an IS-gadget. To do so, we replace a negative edge  $(a, b)$  of weight  $-w$  with the gadget in Figure 5. Nodes  $a$  and  $b$  are original nodes and restricted to  $\{0, 1\}$ , node

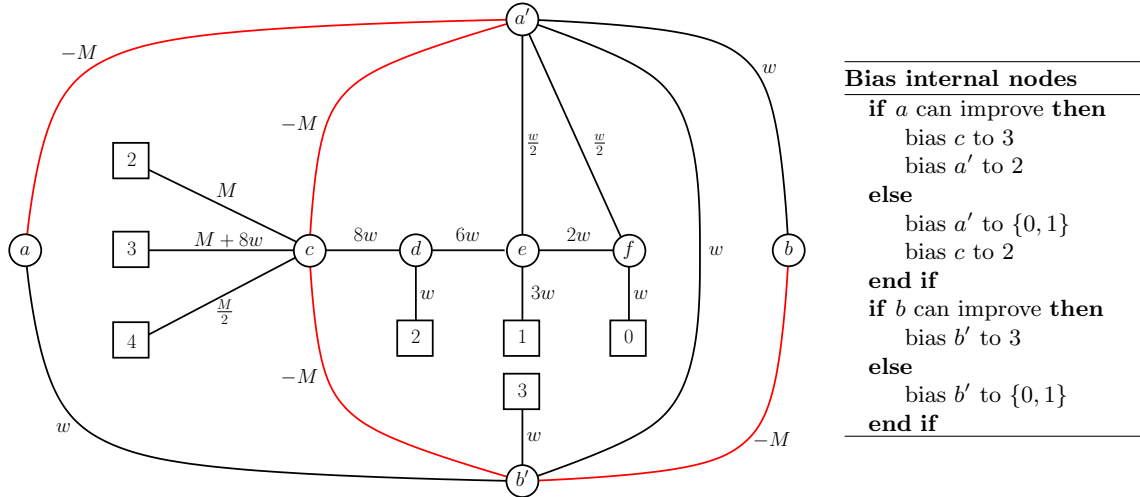

**Fig. 5.** Gadget to replace negative edges.  $M$  is a sufficiently large positive value.

$a'$  is restricted to  $\{0, 1, 2\}$ , node  $b'$  is restricted to  $\{0, 1, 3\}$ , node  $c$  is restricted to  $\{2, 3, 4\}$ , node  $d$  is restricted to  $\{2, 4\}$ , node  $e$  is restricted to  $\{1, 2\}$ , node  $f$  is restricted to  $\{0, 2\}$ . As depicted in the gadget, nodes  $b', c, d, e,$  and  $f$  have additional edges to supernodes.

Coalitions 2, 3 and 4 are only used locally within the gadget. The pseudocode next to the gadget describes how the internal nodes of the gadget are biased; a bias to a set of coalitions should be interpreted as an individual bias to each coalition in the set. In the pseudocode, checking whether a node can improve is w.r.t. her *original* neighborhood. We use “look at” and “bias” as defined in the following lemma and definition. In particular, we check if a node can improve by looking at all nodes in her original neighborhood.



**Lemma 8.** For any polynomial-time computable function  $f : \{0, 1\}^k \mapsto \{0, 1, 2, 3\}^m$  one can construct a graph  $G_f = (V_f, E_f, w)$  having the following properties: (i) there exist  $s_1, \dots, s_k, t_1, \dots, t_m \in V_f$ , (ii) all edges  $e \in E_f$  are positive, (iii)  $f(s_1, \dots, s_k) = (t_1, \dots, t_m)$  in any stable solution of the additively separable hedonic game defined by  $G_f$ .

*Proof.* We first show how to construct a graph  $G_{f'}$ , which implements a function  $f' : \{0, 1\}^k \mapsto \{0, 1\}^{4m}$ . This part is similar to the proof of Lemma 1. We need a slightly different proof here, because we cannot use negative edges as in Lemma 1. To overcome this, our construction will use more than two coalitions, which was not possible for the party affiliation games in Lemma 1. Afterwards, we show how to augment  $G_{f'}$  to implement  $f : \{0, 1\}^k \mapsto \{0, 1, 2, 3\}^m$ .

Recall from Lemma 1 that for any polynomial-time computable function  $f' : \{0, 1\}^k \mapsto \{0, 1\}^{4m}$  one can construct a circuit  $C$  with polynomial many gates that implements this function, where all gates are NOR gates with fan-in and fan-out at most 2. Again, we organize the gates in levels according to their distance to  $C$ 's output; output gates of  $C$  are at level 1.

We replace each gate  $g_i$  at level  $\ell$  with the gadget in Figure 6. Nodes  $u, v$  are inputs and  $y$  is the output of the gate. Nodes  $u, v, y$  are restricted to  $\{0, 1\}$ . Nodes  $w$  and  $x$  are internal to the gate and restricted to  $w \in \{1, 2\}$  and  $x \in \{0, 2\}$ , respectively. By construction of the gadget, we have that in any Nash stable solution,  $y = 1$  if and only if  $u = v = 0$ . In other words  $y = \text{NOR}(u, v)$ .

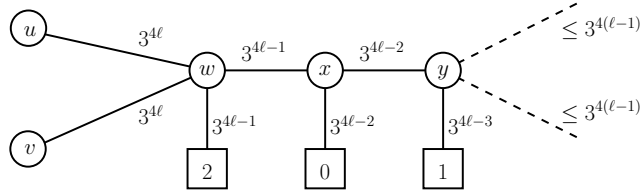

**Fig. 6.** NOR gate without negative edges

As in Lemma 1,  $u$  and  $v$  are also either output nodes of some other gate of the circuit, or they correspond to inputs of the circuit. In the latter case we connect  $u$  or  $v$  to the corresponding input  $s$ -node by an edge of weight  $3^{4\ell+1}$ .

To connect the output  $t$ -nodes, we need to augment  $G_{f'}$  in order to allow for the extended range of the function  $f : \{0, 1\}^k \mapsto \{0, 1, 2, 3\}^m$ . For each output node  $t_i$  we will use 4 outputs of  $G_{f'}$ .

For each of these four outputs, we first change the domain by using a slightly modified NOR-gate. Observe that by changing the restrictions of nodes  $w$ ,  $x$ , and  $y$  in a NOR-gate and connecting them to different supernodes, we can change the domain of the NOR gate to any two distinct values in  $\{0, 1, 2, 3, 4\}$ . E.g., if we want  $y \in \{2, 4\}$  and  $y = 2$  if and only if  $u = v = 0$ , then we can change the restrictions

$w \in \{1, 3\}$ ,  $x \in \{2, 3\}$ , and  $y \in \{2, 4\}$ ; and replace the edges of  $w, x, y$  to supernodes 2, 0, 1 by edges of the same weights to supernodes 3, 2, 4, respectively. Using this idea, we first change the domain of the four outputs of  $C$  that correspond to  $t_i$  to  $\{0, 4\}$ ,  $\{1, 4\}$ ,  $\{2, 4\}$ , and  $\{3, 4\}$ , respectively. These four modified outputs are then all connected to the output node  $t_i$  (which we restrict to  $\{0, 1, 2, 3\}$ ) with edges of weight 1. Suppose that, under  $f$ , the value of  $t_i$  is  $\kappa \in \{0, 1, 2, 3\}$ , then three of the corresponding modified outputs of  $f'$  will take on value 4 and the remaining one (which is uniquely determined) will take on value  $\kappa$ .

The claim follows since our construction fulfils properties (i), (ii) and (iii).  $\square$

**Definition 6.** For a polynomial-time computable function  $f : \{0, 1\}^k \mapsto \{0, 1, 2, 3\}^m$  we say that  $G_f$  as constructed in Lemma 8 is a graph that looks at  $s_1, \dots, s_k \in V_f$  and biases  $t_1, \dots, t_m \in V_f$  according to the function  $f$ .

Recall that the instance of ONEENEMYPARTYAFFILIATION\* has the property that no player is ever indifferent between the two coalitions that make up a stable outcome. By scaling edge weights we can implement the “look at” required to bias the internal nodes of the gadget without affecting their original preferences.

For the gadget in Figure 5, we say that node  $a$  is *locked* by the gadget if  $a = 1$  and  $a' = 0$  or  $a = 0$  and  $a' = 1$ . Node  $b$  is said to be locked accordingly. The following three lemmas describe the operation of the gadget. All three lemmas should be read with the implicit clause: *If the internal nodes  $(a', b', c, d, e, f)$  of Figure 5 are stable.* Let  $\neg u$  denote the complement of  $u$  over  $\{0, 1\}$ .

**Lemma 9.** *Node  $c$  is either in coalition 2 or in coalition 3, while nodes  $d, e$  and  $f$  are in coalition 2. If  $c = 2$  then  $a' = \neg a$ , and if  $c = 3$  then  $b' = \neg b$ .*

*Proof.* We start by showing that  $c \in \{2, 3\}$ . By way of contradiction assume  $c = 4$ . Then  $c = 4 \Rightarrow d = 4 \Rightarrow e = 1 \Rightarrow f = 0$  and therefore  $a' = \neg a \in \{0, 1\}$ . Together with  $b' \in \{0, 1, 3\}$  this directly implies that  $c$  can improve by choosing  $c = 2$ , contradicting our assumption. Thus  $c \in \{2, 3\}$ . From  $c \neq 4$  we immediately get  $d = 2 \Rightarrow e = 2 \Rightarrow f = 2$ . If  $c = 2$  then the negative edges incident to  $a'$  assure  $a' = \neg a$ . Similarly, if  $c = 3$  then the negative edges incident to  $b'$  assure  $b' = \neg b$ . This completes the proof of the lemma.  $\square$

**Lemma 10.** *If neither  $a$  nor  $b$  can improve then  $a$  and  $b$  are locked by the gadget.*

*Proof.* Since neither  $a$  nor  $b$  can improve,  $a'$  and  $b'$  are biased to  $\{0, 1\}$  and  $c$  is biased to 2. If  $c = 2$  then  $a' = \neg a$  (by Lemma 9). So  $b'$  has an edge of weight  $w$  to both 0 and 1. Together with the bias this implies  $b' = \neg b$ . If  $c = 3$  then  $b' = \neg b$ . So  $a'$  has an edge of weight  $w$  to both 0 and 1. Together with the bias this implies  $a' = \neg a$ . So in both cases  $a' = \neg a$  and  $b' = \neg b$ . The claim follows.  $\square$

**Lemma 11.** *If  $a$  or  $b$  (or both) can improve then one of the nodes that can improve is not locked while the other node is locked by the gadget. Moreover, if  $a$  (resp.  $b$ ) is not locked by the gadget then  $b' = \neg b$  (resp.  $a' = \neg a$ ).*

*Proof.* We consider three cases: (i) only  $a$  can improve, (ii) only  $b$  can improve, (iii)  $a$  and  $b$  can improve.

Case (i) (only  $a$ ): Here  $c$  is biased to 3,  $a'$  is biased to 2, and  $b'$  is biased to  $\{0, 1\}$ . First assume  $c = 2$ . Lemma 9 enforces  $a' = \neg a$  which together with the bias implies  $b' = \neg b$ . But then the bias on  $c$  gives  $c = 3$ , a contradiction. Thus  $c = 3$ , which enforces  $b' = \neg b$  and with the bias implies  $a' = 2$ . So  $a$  is not locked and  $b$  is locked.

Case (ii) (only  $b$ ): Here  $c$  is biased to 2,  $a'$  is biased to  $\{0, 1\}$ , and  $b'$  is biased to 3. First assume  $c = 3$ . Lemma 9 enforces  $b' = \neg b$  which together with the bias implies  $a' = \neg a$ . But then the bias on  $c$  gives  $c = 2$ , a contradiction. Thus  $c = 2$ , which enforces  $a' = \neg a$  and with the bias implies  $b' = 3$ . So  $a$  is locked and  $b$  is not locked.

Case (iii) ( $a$  and  $b$ ): Here  $c$  is biased to 3,  $a'$  is biased to 2, and  $b'$  is biased to 3. If  $c = 2$  then Lemma 9 enforces  $a' = \neg a$ , which together with the bias implies  $b' = 3$ . So in this case  $a$  is locked and  $b$  is not locked. If  $c = 3$  then Lemma 9 enforces  $b' = \neg b$ , which together with the bias implies  $a' = 2$ . So in this case  $a$  is not locked and  $b$  is locked.

In every case both claims of the lemma are fulfilled.  $\square$

To complete the proof we show that a stable outcome of the IS instance is also a stable outcome for the `ONEENEMYPARTYAFFILIATION*` instance. Suppose the contrary. Then there must exist an original node which is stable for IS but not for `ONEENEMYPARTYAFFILIATION*`. Clearly such a node must be the node  $a$  or  $b$  for some gadget. So either  $a$  or  $b$  (or both) can improve. But then by the first statement in Lemma 11 one of the improving nodes is unlocked, say  $a$ . Since  $a$  was only incident to one negative edge in the `ONEENEMYPARTYAFFILIATION*` instance,  $a$  cannot be locked by any other gadget. Moreover, by the second statement in Lemma 11,  $a$  is now connected in the gadget by a positive edge to the node  $b'$  and  $b' = \neg b$ . On the one hand, if  $a = b$  then the original edge  $(a, b)$  contributes  $-w$  to  $a$ 's utility while now  $a$  receives 0 from the edge  $(a, b')$ . On the other hand, if  $a \neq b$  then the corresponding utility contributions are 0 and  $w$ . So if  $a$  changes strategy then the difference in her utility w.r.t.  $b$  is the same in both problems, since we just shifted the utility of node  $a$  w.r.t.  $b$  by  $w$ . So  $a$  is also not stable for IS, a contradiction. This finishes the proof of Theorem 4.  $\square$

## 5 Other veto-based stability concepts

In an IS outcome, a single player can veto another player joining her coalition, but there is no restriction on leaving a coalition. The following proposition shows that adding certain leaving conditions yields polynomial-time convergence from the all-singleton partition.

**Proposition 2.** *Any problem in column 3 of Table 1 can be solved in polynomial time provided that the leaving condition requires that the leaving node has at least one negative edge within the coalition. In particular, this holds for the problems in cells 3B, 3C, and 3D.*

*Proof.* We use local improvements starting from the set of singleton coalitions. Then a player can make at most one improving step, since all edges in resulting non-singleton coalitions will be positive because of the veto-in restriction, and so no player can leave such a coalition. Hence we arrive at a stable outcome in at most  $|V|$  improving steps.  $\square$

Interestingly, requiring veto-out feasibility is already enough for polynomial-time convergence even if we have no restriction on the entering condition. This stands in contrast to Theorem 4.

**Proposition 3.** *All problems in row C of Table 1 can be solved in polynomial time by local improvements starting from any initial configuration and using at most  $2|V|$  improving steps.*

*Proof.* To get a running time of  $2|V|$  (rather than  $O(|V|^2)$ ) we restrict players from joining a non-empty coalition to which they have no positive edge. This ensures that whenever a player joins a non-empty coalition then this player (and all players to which she is connected by a positive edge in the coalition) will never move again. Moreover, a player can only start a new coalition once. It follows that each player can make at most two strategy changes. In total we have at most  $2|V|$  local improvements.  $\square$

## 6 sumCIS

Next we study SUMCIS, where a deviating player's total weight to the new coalition is non-negative, and to the old coalition is non-positive. Even though deviations are very restricted here, it is PLS-complete to compute a stable outcome.

**Theorem 5.** *SUMCIS is PLS-complete.*

*Proof.* We reduce from LOCALMAXCUT. Consider an arbitrary instance of LOCALMAXCUT with only (non-negative) integer edge weights. Recall that such an instance can be cast as an instance of PARTYAFFILIATION by negating the weights of the edges. Let  $G = (V, E, w)$  represent the PARTYAFFILIATION instance. For each player  $i \in V$  let  $\sigma_i$  be the total weight of edges incident to player  $i$ , i.e.  $\sigma_i = \sum_{\{i,j\} \in E} w(\{i,j\})$ . Observe that  $\sigma_i$  is a negative integer. We augment  $G$  by introducing two new players, called *supernodes*. Every player  $i \in V$  has an edge of weight  $\frac{-\sigma_i}{2} + \frac{1}{4}$  to each supernode. The two supernodes are connected by an edge of weight  $-M$  where  $M$  is sufficiently large (i.e.,  $M > \sum_{i \in V} (\frac{-\sigma_i}{2} + \frac{1}{4})$ ). The resulting graph  $G'$  represents our SUMCIS instance.

Consider a stable outcome of the SUMCIS instance  $G'$ . By the choice of  $M$  the two supernodes will be in different coalitions. Now consider any player  $i \in V$ . If  $i$  is not in a coalition with one of the supernodes, then  $i$ 's payoff is non-positive. On the other hand joining the coalition of one of the supernodes yields positive payoff, since

$2(\frac{-\sigma_i}{2} + \frac{1}{4}) + \sigma_i > 0$ . Thus, each player  $i \in V$  will be in a coalition with one of the supernodes. So our outcome partitions  $V$  into two parts, say  $V_1, V_2$ .

It remains to show that any stable outcome for the SUMCIS instance is also a local optimum for the PARTYAFFILIATION instance. Assume that the outcome of the SUMCIS instance is stable but in the corresponding outcome of PARTYAFFILIATION instance there exists a player  $i$  that can improve by joining the other coalition. W.l.o.g. assume  $i \in V_1$ . Then,  $\sum_{s \in V_1} w(\{i, s\}) < \sum_{s \in V_2} w(\{i, s\})$ . With  $\sigma_i = \sum_{s \in V} w(\{i, s\})$  and since  $\sigma_i$  is integer, we get

$$\sum_{s \in V_1} w(\{i, s\}) \leq \frac{\sigma_i}{2} - \frac{1}{2} < \frac{\sigma_i}{2} < \frac{\sigma_i}{2} + \frac{1}{2} \leq \sum_{s \in V_2} w(\{i, s\}).$$

It follows that in the SUMCIS instance, player  $i$ 's payoff is negative in her current coalition  $V_1$  whereas joining  $V_2$  would yield positive payoff. This contradicts our assumption that we are in a stable outcome of the SUMCIS instance. The claim follows.  $\square$

## 7 Voting-based deviations

In this section we study the complexity of computing stable outcomes under various voting-based stability requirements. We start by showing PLS-hardness for the case where a deviating player needs a  $T_{in}$  majority in the target coalition but there is no restriction on leaving coalitions.

**Theorem 6.** *VOTEIN is PLS-complete for any voting threshold  $0 \leq T_{in} \leq 1$ .*

*Proof.* We reduce from ONEENEMYPARTYAFFILIATION\* represented by an edge-weighted graph  $G = (V, E, w)$ . Let  $\Delta(G)$  be the maximum degree of a node in  $G$ . Recall that, in every bipartition, no player is ever indifferent between the two coalitions.

First observe that the case  $T_{in} > \frac{\Delta(G)-1}{\Delta(G)}$  is exactly the same as IS (for which we show hardness in Theorem 4), since in this case one negative edge is enough to veto a player joining a coalition. In the following we assume  $T_{in} \leq \frac{\Delta(G)-1}{\Delta(G)}$ .

We augment  $G$  as follows:

For every negative edge  $(a, b)$  in  $G$  we introduce  $2\Delta(G) - 2$  new nodes, called *followers*, and connect them with  $a$  and  $b$  as shown in Figure 7. Both  $(a$  and  $b)$  get  $\Delta(G) - 1$  followers and have a  $\delta$  edge to each of them. Moreover, the followers have also an edge of weight  $\varepsilon$  to the other node. Here  $0 < \varepsilon < \delta$  and  $\delta$  is small enough so that the preferences of the original players ( $a$  and  $b$ ) are still determined only by the original edges. In a stable outcome the followers will be in the same coalition as their “leader”, i.e., the node to which they have a  $\delta$  edge. In particular, in Figure 7, the  $\Delta - 1$  nodes above the negative edge will be in the same coalition as  $a$  and the bottom ones will be with  $b$ . The presence of followers ensures that each negative edge

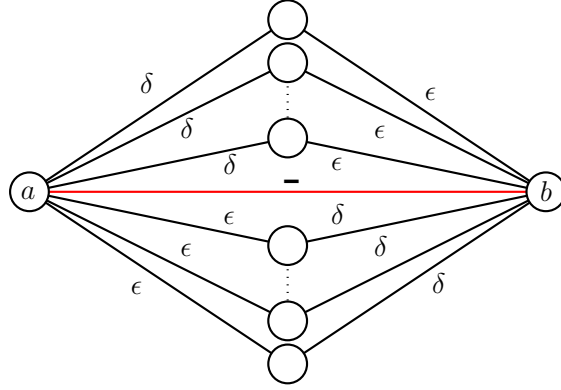

**Fig. 7.** Gadget used for showing that `VOTEIN` is `PLS`-complete. The gadget augments negative edges with followers that ensure that there is always a  $T_{in}$ -majority when a player enters a coalition.

to some coalition will be accompanied by  $\Delta - 1$  positive edges to the same coalition. Thus, for any node and any (possibly empty) coalition, either the node does not have an edge to the coalition or at least a  $\frac{\Delta-1}{\Delta}$  fraction of those edges are positive. Since  $T_{in} \leq \frac{\Delta-1}{\Delta}$ , we get that there is always a  $T_{in}$ -majority for entering a coalition. In other words, in a stable outcome of the `VOTEIN` instance, the voting doesn't impose any restrictions.

To ensure that any stable outcome for the `VOTEIN` instance has only two coalitions we further augment  $G$  by introducing two supernodes, as used in the proof of Observation 2. The claim follows.  $\square$

`VOTEOUT` is conceptually different from `VOTEIN`. In `VOTEOUT` a coalition of two players connected by a positive edge is vote-out stable. This makes it hard to restrict the number of coalitions. Doing this is probably the key for proving `PLS`-hardness also for `VOTEOUT`. For the following theorem we consider a version of `VOTEOUT` where the number of coalitions is restricted by the problem. Let  $k$ -`VOTEOUT` be the problem of computing a vote-out stable outcome when at most  $k$  coalitions are allowed. Observe that for any  $k \geq 2$  such a vote-out stable outcome exists and that local improvements starting from any  $k$ -partition converge to such a stable outcome.

**Theorem 7.**  $k$ -`VOTEOUT` is `PLS`-complete for any voting threshold  $0 \leq T_{out} < 1$  and any  $k \geq 2$ .

*Proof.* Our reduction is from `ONEENEMYPARTYAFFILIATION`, but we first reduce to the intermediate problem `ONEENEMYNASHSTABLE`, which is a restricted version of `NASHSTABLE` where each player is only incident to at most one negative edge. Consider an instance of `ONEENEMYPARTYAFFILIATION` which is represented as an edge-weighted graph  $G = (V, E, w)$ . We augment  $G$  with two supernodes in exactly

the same way as in Theorem 6. This ensures that any stable outcome of the ONEENEMYNASHSTABLE instance uses only two coalitions and thus is also a stable outcome for the ONEENEMYPARTYAFFILIATION instance. Hence, ONEENEMYNASHSTABLE is PLS-complete.

We now reduce from ONEENEMYNASHSTABLE to  $k$ -VOTEOUT. Let  $G$  be the graph corresponding to an instance of ONEENEMYNASHSTABLE. Let  $\Delta(G)$  be the maximum degree of a node in  $G$ . We augment  $G$  as follows: We introduce  $s \cdot k \cdot \Delta(G)$  new nodes where  $s$  is an integer satisfying  $s \geq \frac{T_{out}}{1-T_{out}}$ . Those nodes are organized in  $s \cdot \Delta(G)$  complete graphs of  $k$  nodes each. All the edges in the complete graphs have weight  $-M$  where  $M$  is sufficiently large ( $M > |V| \cdot \Delta(G) \cdot \varepsilon$  will do). Moreover, we connect every original node  $u \in V$  to every new node with an edge of weight  $-\varepsilon$ , where  $\varepsilon > 0$ .

By the choice of  $M$  and since at most  $k$  coalitions are allowed, in any stable solution there will be one node from each complete graph in each of the  $k$  coalitions. This shifts the utility of each player  $i \in V$  with respect to each coalition by  $-s \cdot \Delta(G) \cdot \varepsilon$ . Moreover, every original node has at least  $s \cdot \Delta(G)$  negative edges to each coalition. Since each node is incident to at most  $\Delta(G)$  positive edges, it follows that the fraction of negative edges to each coalition is at least  $\frac{s}{s+1} \geq T_{out}$ . Thus, in every stable outcome all nodes  $u \in V$  have a  $T_{out}$ -majority for leaving their coalition. This implies that in the corresponding outcome of the ONEENEMYNASHSTABLE instance, no player can improve her utility by joining one of the  $k$  coalitions used in  $k$ -VOTEOUT. Moreover, in every stable outcome the utility of each node  $u \in V$  with respect to the set of original nodes  $V$  is non-negative, since  $u$  has at most one negative incident edge in the ONEENEMYNASHSTABLE instance and  $k \geq 2$ . It follows that a stable outcome for the  $k$ -VOTEOUT instance is also a stable outcome for the ONEENEMYNASHSTABLE instance. The claim follows.  $\square$

It is an interesting open problem whether PLS-completeness also holds if the restriction on the number of allowed coalitions is dropped. Can we construct a gadget that imposes this restriction without restricting the problem a priori?

Since VOTEIN and a restricted version of VOTEOUT are PLS-complete it is interesting to study the combination of both problems. What happens if we require vote-in stability *and* vote-out stability? With a mild assumption on the voting thresholds  $T_{in}, T_{out}$ , we establish:

**Theorem 8.** *For any instance of VOTEINOUT with voting thresholds  $T_{in}, T_{out} > \frac{1}{2}$  local improvements from any initial configuration converge in at most  $2|E|$  steps.*

*Proof.* For any outcome  $p$  define a potential function  $\Phi(p) = \Phi^+(p) - \Phi^-(p)$ , where  $\Phi^+(p)$  (resp.  $\Phi^-(p)$ ) is the number of positive (resp. negative) internal edges, i.e. edges not crossing coalition boundaries. Consider a local improvement of some player  $i$  from coalition  $p(i)$  to  $p'(i)$ . Since  $T_{out} > \frac{1}{2}$ , player  $i$  has either no edges or more negative than positive edges to  $p(i)$ . Likewise, since  $T_{in} > \frac{1}{2}$ , player  $i$  has either no or more positive than negative edges to  $p'(i)$ . So,  $\Phi(p)$  cannot decrease by a local improvement.

A player  $i$  that performs a local improvement will either have edges to  $p(i)$  or to  $p'(i)$ , so  $\Phi(p') > \Phi(p)$ . The claim follows since  $-|E| \leq \Phi(p) \leq |E|$  and  $\Phi(p)$  is integer.  $\square$

## 8 Open problems

In this paper, we studied the computational complexity of finding stable outcomes in hedonic games. We show that `NASHSTABLE` is PLS-complete. On the other hand we show that `CIS`, that is finding a stable outcome where any member of a coalition can block (veto) a player from leaving or joining, can be solved in polynomial time. For the case where a player can only block a player from joining, we show that the corresponding problem `IS` is PLS-complete (Theorem 4). Our reduction to `IS` uses five coalitions. On the other hand, `2-IS`, where the number of coalitions is restricted to two, is solvable in polynomial time (Proposition 1). This leaves open the complexity of `3-IS` and `4-IS`, where the number of coalitions is restricted to three or four, respectively.

We then study cases where members of a coalition can vote on whether to allow a player to leave or join a coalition. The problem `VOTEIN` is parameterized by a voting threshold,  $T_{in} \in [0, 1]$ . `IS` can be seen as `VOTEIN` with  $T_{in} = 1$ . Theorem 5 shows hardness for  $0 \leq T_{in} < 1$ , so in fact we show that `VOTEIN` is PLS-complete for all voting thresholds. In contrast, we show that the case of `VOTEOUT` with  $T_{out} = 1$  is polynomial-time solvable (Proposition 3). This suggests that `VOTEOUT` is conceptually different from `VOTEIN`. Indeed, it seems difficult to restrict the coalitions in this case. We do show that  $k$ -`VOTEOUT`, where we restrict the outcome to have at most  $k$  coalitions, is PLS-complete for  $0 \leq T_{out} < 1$ , but we leave the complexity of `VOTEOUT` as an interesting open problem.

On the positive side, we show that local improvements converge in polynomial time in the case of requiring *both* vote-in- and vote-out- stability with  $T_{in}, T_{out} > \frac{1}{2}$ . We leave open the case of `VOTEINOUT` with voting thresholds that do not satisfy these conditions, in particular the case of  $T_{in} = T_{out} = \frac{1}{2}$ . We also leave open the case of finding an outcome that is vote-in and sum-out stable.

Elsässer and Tscheuschner [27] showed that local max cut is PLS-complete even when the input graph has degree at most five. In contrast, Poljak [44] gives a polynomial-time algorithm for graphs with degree at most three. It would be interesting to study degree restrictions for additively-separable hedonic games.



# Bibliography

- [1] E. H. L. Aarts and J. K. Lenstra. *Local Search in Combinatorial Optimization*. Wiley-Interscience, 1997.
- [2] J. Alcalde and P. Revilla. Researching with whom? Stability and manipulation. *Journal of Mathematical Economics*, 40(8):869–887, 2004.
- [3] E. Anshelevich, A. Dasgupta, J. M. Kleinberg, É. Tardos, T. Wexler, and T. Roughgarden. The price of stability for network design with fair cost allocation. *SIAM J. Comput.*, 38(4):1602–1623, 2008.
- [4] H. Aziz and F. Brandl. Existence of stability in hedonic coalition formation games. In *Proc. of the International Conference on Autonomous Agents and Multiagent Systems (AAMAS)*, pages 763–770, 2012.
- [5] H. Aziz and R. Savani. Hedonic games. In *Handbook of Computational Social Choice*, pages 356–376. Cambridge University Press, 2016.
- [6] H. Aziz, F. Brandt, and P. Harrenstein. Pareto optimality in coalition formation. *Games and Economic Behavior*, 82:562–581, 2013.
- [7] H. Aziz, F. Brandt, and H. G. Seedig. Computing desirable partitions in additively separable hedonic games. *Artif. Intell.*, 195:316–334, 2013. doi: 10.1016/j.artint.2012.09.006.
- [8] H. Aziz, F. Brandt, and P. Harrenstein. Fractional hedonic games. In *Proc. of the International Conference on Autonomous Agents and Multi-Agent Systems (AAMAS)*, pages 5–12, 2014.
- [9] H. Aziz, S. Gaspers, J. Gudmundsson, J. Mestre, and H. Täubig. Welfare maximization in fractional hedonic games. In *Proc. of the International Joint Conference on Artificial Intelligence, (IJCAI)*, pages 461–467, 2015.
- [10] H. Aziz, F. Brandl, F. Brandt, P. Harrenstein, M. Olsen, and D. Peters. Fractional hedonic games. *CoRR*, abs/1705.10116, 2017.
- [11] M.-F. Balcan, A. Blum, and Y. Mansour. Improved equilibria via public service advertising. In *Proc. of the ACM-SIAM Symposium on Discrete Algorithms (SODA)*, pages 728–737, 2009.
- [12] C. Ballester. NP-completeness in hedonic games. *Games and Economic Behavior*, 49(1):1–30, 2004.
- [13] S. Banerjee, H. Konishi, and T. Sönmez. Core in a simple coalition formation game. *Social Choice and Welfare*, 18:135–153, 2001.
- [14] A. Bhargat, T. Chakraborty, and S. Khanna. Approximating pure Nash equilibrium in cut, party affiliation and satisfiability games. In *Proc. of the ACM Conference in Electronic Commerce (EC)*, pages 132–146, 2010.
- [15] V. Bilò, A. Fanelli, M. Flammini, G. Monaco, and L. Moscardelli. Nash stable outcomes in fractional hedonic games: Existence, efficiency and computation. *Journal of Artificial Intelligence Research*, 62:315–371, 2018.

- [16] F. Bloch and E. Diamantoudi. Noncooperative formation of coalitions in hedonic games. *International Journal of Game Theory*, 40(2):263–280, 2011.
- [17] A. Bogomolnaia and M. O. Jackson. The stability of hedonic coalition structures. *Games and Economic Behavior*, 38(2):201–230, 2002.
- [18] S. Brânzei and K. Larson. Coalitional affinity games and the stability gap. In *Proc. of the International Joint Conference on Artificial Intelligence (IJCAI)*, pages 1319–1320, 2009.
- [19] N. Burani and W. S. Zwicker. Coalition formation games with separable preferences. *Mathematical Social Sciences*, 45(1):27–52, 2003.
- [20] G. Chalkiadakis, E. Elkind, M. Polukarov, and N. R. Jennings. The price of democracy in coalition formation. In *Proc. of the International Conference on Autonomous Agents and Multiagent Systems (AAMAS)*, pages 401–408, 2009.
- [21] G. Christodoulou, V. S. Mirrokni, and A. Sidiropoulos. Convergence and approximation in potential games. In *Proc. of the Symposium on Theoretical Aspects of Computer Science (STACS)*, pages 349–360, 2006.
- [22] D. Dimitrov and S. C. Sung. On top responsiveness and strict core stability. *Journal of Mathematical Economics*, 43(2):130–134, 2007.
- [23] D. Dimitrov, P. Borm, R. Hendrickx, and S. C. Sung. Simple priorities and core stability in hedonic games. *Social Choice and Welfare*, 26(2):421–433, 2006.
- [24] J. H. Drèze and J. Greenberg. Hedonic coalitions: Optimality and stability. *Econometrica*, 48(4):987–1003, 1980.
- [25] E. Elkind and M. Wooldridge. Hedonic coalition nets. In *Proc. of the International Conference on Autonomous Agents and Multiagent Systems (AAMAS)*, pages 417–424, 2009.
- [26] E. Elkind, A. Fanelli, and M. Flammini. Price of pareto optimality in hedonic games. In *Proc. of the Conference on Artificial Intelligence (AAAI)*, pages 475–481, 2016.
- [27] R. Elsässer and T. Tscheuschner. Settling the complexity of local max-cut (almost) completely. In *Proc. of the International Colloquium on Automata, Languages and Programming (ICALP)*, pages 171–182, 2011.
- [28] A. Fabrikant, C. H. Papadimitriou, and K. Talwar. The complexity of pure Nash equilibria. In *Proc. of the ACM Symposium on Theory of Computing (STOC)*, pages 604–612, 2004.
- [29] M. Gairing and R. Savani. Computing stable outcomes in hedonic games. In *Proc. of the International Symposium on Algorithmic Game Theory (SAGT)*, pages 174–185, 2010.
- [30] M. Gairing and R. Savani. Computing stable outcomes in hedonic games with voting-based deviations. In *Proc. of the International Conference on Autonomous Agents and Multi-Agent Systems (AAMAS)*, pages 559–566, 2011.
- [31] S. Ieong and Y. Shoham. Marginal contribution nets: A compact representation scheme for coalitional games. In *Proc. of the ACM Conference on Electronic Commerce (EC)*, pages 193–202, 2005.

- [32] D. S. Johnson, C. H. Papadimitriou, and M. Yannakakis. How easy is local search? *Journal of Computer and System Sciences*, 37(1):79–100, 1988.
- [33] M. Karakaya. Hedonic coalition formation games: A new stability notion. *Mathematical Social Sciences*, 61(2):157–165, 2011.
- [34] E. Koutsoupias and C. H. Papadimitriou. Worst-Case Equilibria. In C. Meinel and S. Tison, editors, *Proc. of the International Symposium on Theoretical Aspects of Computer Science (STACS)*, Lecture Notes in Computer Science, Vol. 1563, Springer Verlag, pages 404–413, 1999.
- [35] M. W. Krentel. Structure in locally optimal solutions. In *Proc. of the Symposium on Foundations of Computer Science (FOCS)*, pages 216–221, 1989.
- [36] G. Monaco, L. Moscardelli, and Y. Velaj. Stable outcomes in modified fractional hedonic games. In *Proc. of the International Conference on Autonomous Agents and Multiagent Systems (AAMAS)*, pages 937–945, 2018.
- [37] B. Monien and T. Tscheuschner. On the power of nodes of degree four in the local max-cut problem. In *Proc. of the International Conference on Algorithms and Complexity (CIAC)*, pages 264–275, 2010.
- [38] B. Monien, D. Dumrauf, and T. Tscheuschner. Local search: Simple, successful, but sometimes sluggish. In *Proc. of the International Colloquium on Automata, Languages, and Programming (ICALP)*, pages 1–17, 2010.
- [39] M. Olsen. On defining and computing communities. In *Proc. of Computing: the Australasian Theory Symposium (CATS)*, pages 97–102, 2012.
- [40] J. B. Orlin, A. P. Punnen, and A. S. Schulz. Approximate local search in combinatorial optimization. *SIAM Journal on Computing*, 33(5):1201–1214, 2004.
- [41] D. Peters. Graphical hedonic games of bounded treewidth. In *Proc. of the Conference on Artificial Intelligence (AAAI)*, pages 586–593, 2016.
- [42] D. Peters. Precise complexity of the core in dichotomous and additive hedonic games. In *Proc. of the International Conference on Algorithmic Decision Theory (ADT)*, pages 214–227, 2017.
- [43] D. Peters and E. Elkind. Simple causes of complexity in hedonic games. In *Proc. of the International Conference on Artificial Intelligence (IJCAI)*, pages 617–623, 2015.
- [44] S. Poljak. Integer linear programs and local search for max-cut. *SIAM Journal on Computing*, 21(3):450–465, 1995.
- [45] A. A. Schäffer and M. Yannakakis. Simple local search problems that are hard to solve. *SIAM Journal of Computing*, 20(1):56–87, 1991.
- [46] M. Sipser. *Introduction to the Theory of Computation*. Thomson, 2006.
- [47] S. C. Sung and D. Dimitrov. On myopic stability concepts for hedonic games. *Theory and Decision*, 62(1):31–45, 2007.
- [48] S. C. Sung and D. Dimitrov. Computational complexity in additive hedonic games. *European Journal of Operational Research*, 203(3):635–639, 2010.
- [49] G. J. Woeginger. A hardness result for core stability in additive hedonic games. *Mathematical Social Sciences*, 65(2):101–104, 2013.

- [50] M. Yannakakis. Equilibria, fixed points, and complexity classes. In *Proc. of the International Symposium on Theoretical Aspects of Computer Science (STACS)*, pages 19–38, 2008.