

Use of CMIP Atmospheric Boundary Conditions with ISMs

Richard Cullather & Sophie Nowicki

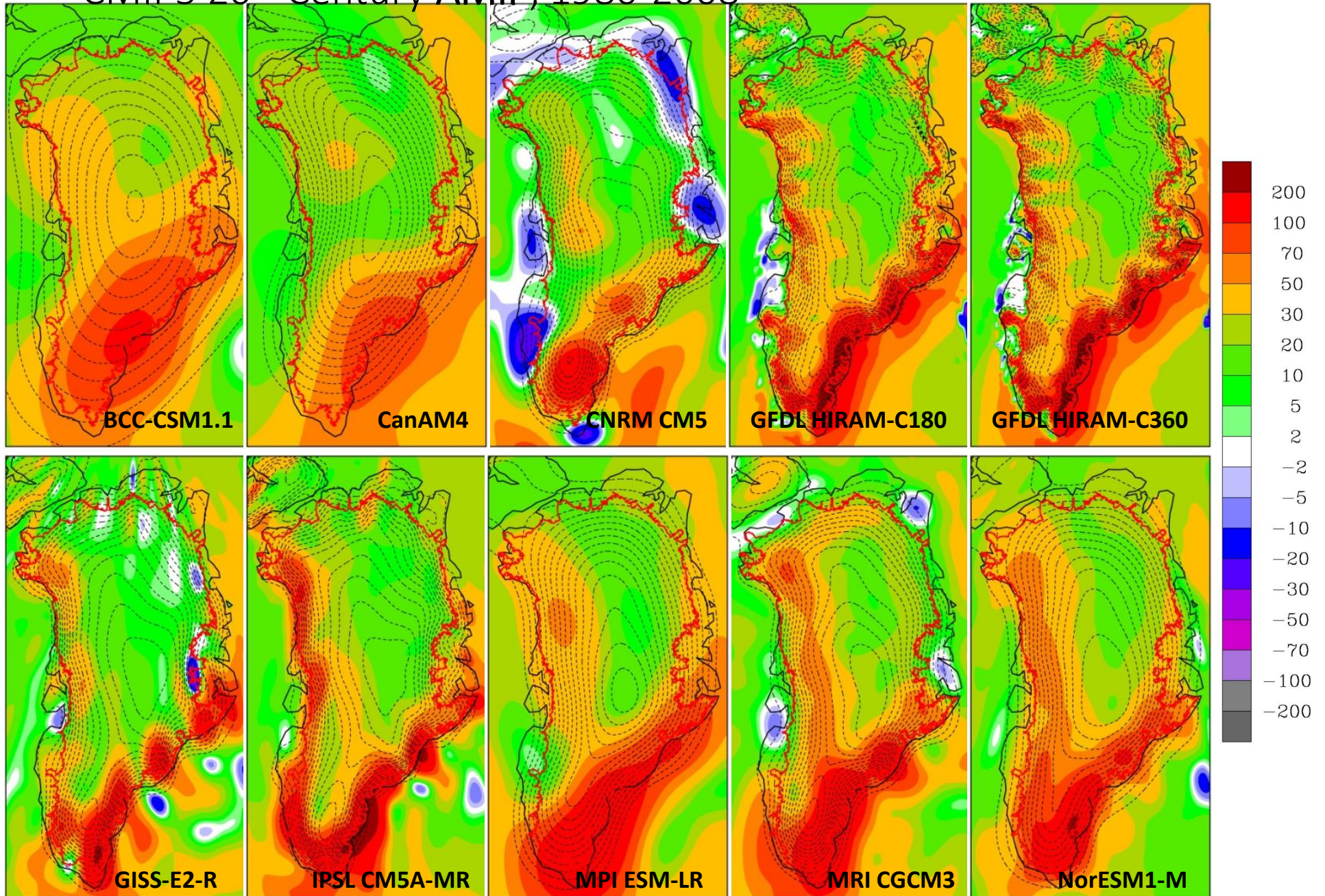

“Surface Mass Balance” ($pr - evspsbl - mrrro(s)$) [cm yr⁻¹ w.e.]
CMIP5 20th Century AMIP, 1980-2008



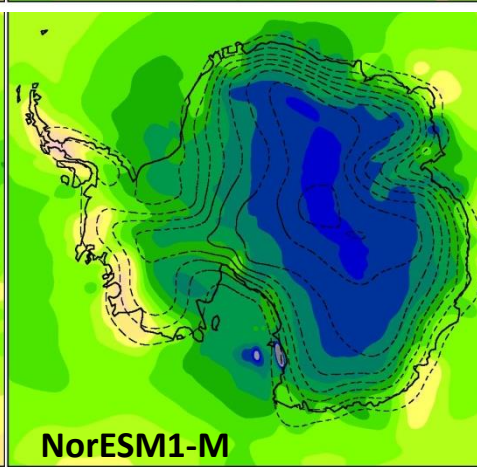
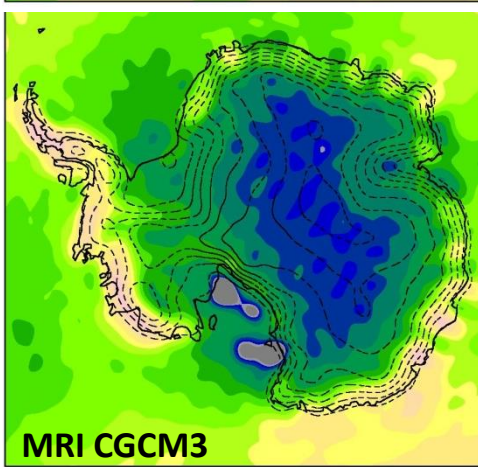
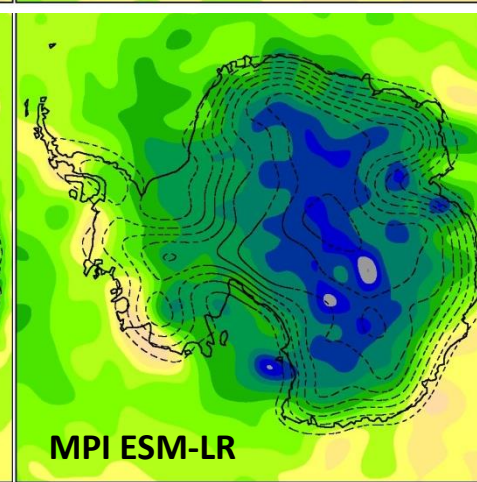
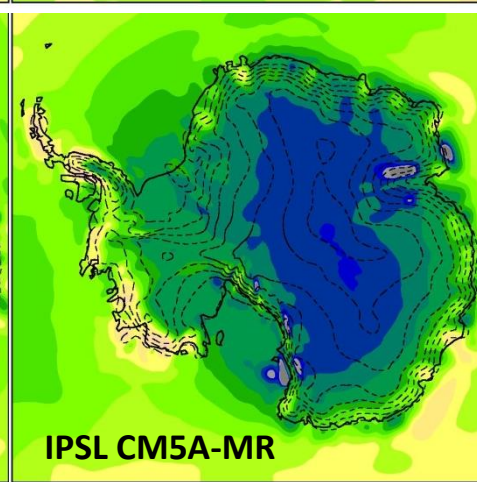
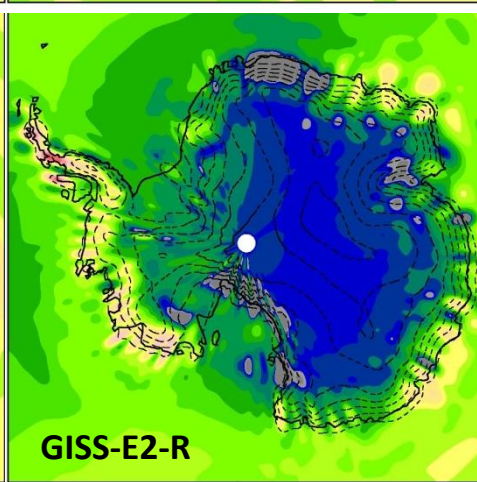
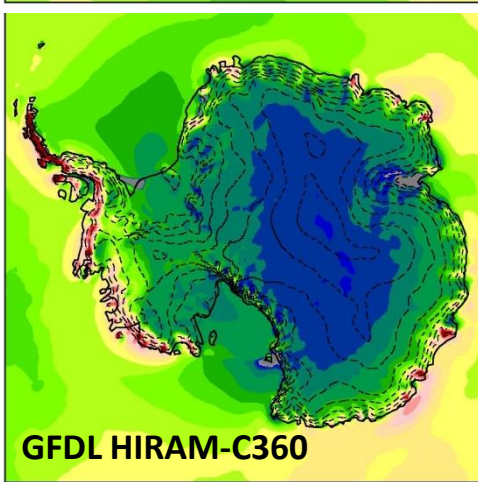
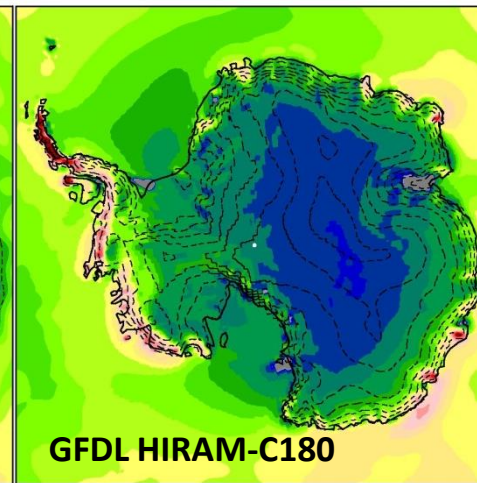
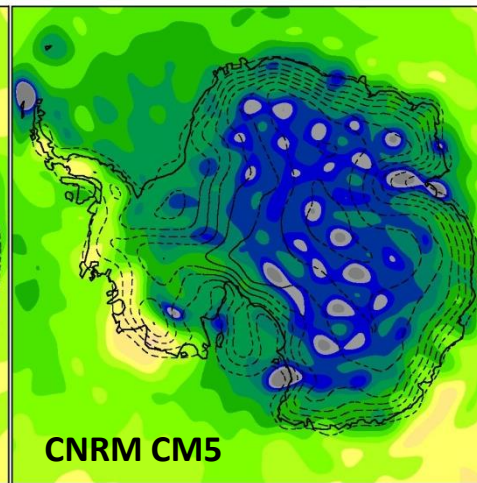
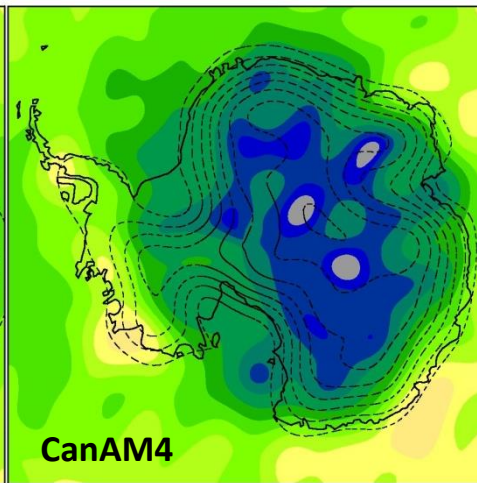
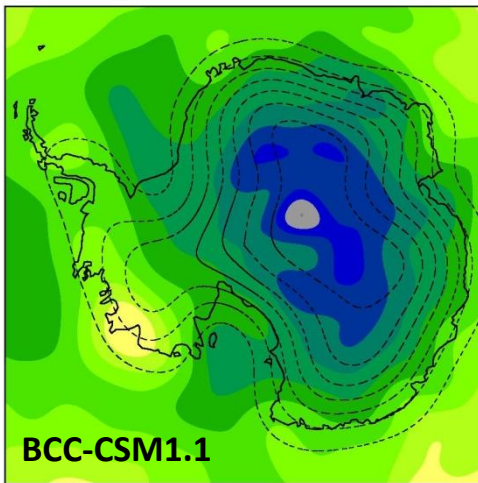

- **Why are we interested in using forcing from Earth System Models?**

- CMIP integrations represent the best available picture of future climate.
- Interest in coupled systems to obtain:
 - Interactive feedbacks between ice sheets and external forcing.
 - Quantification of the relative impacts of ice sheet changes in the context of the global climate system.

- **What is difficult about this?**

1. The variables are not output.
2. The overall magnitude is wrong.
3. The spatial distribution is wrong: Resolution of SMB (and T_{sfc}) is too coarse, does not adequately resolve topographic gradients.
4. The time-evolution is wrong: Climate model representation may not incorporate important local physical processes.

SMB Validation

- Primarily through comparison with gridded data sets: RCM/reanalysis output.
- Those data sets are validated through a variety of means:
 - Ice cores/ or glaciological methods.
 - Accumulation radar.
 - Surface Mass Balance and Snow on Sea Ice Working Group (SUMup).
 - SurfACE Mass Balance of Antarctica (SAMBA).
 - AWS.
 - Evaluation of related variables: temperature, energy budget.

(a) Modelled surface mass balance (m i.e. / yr)

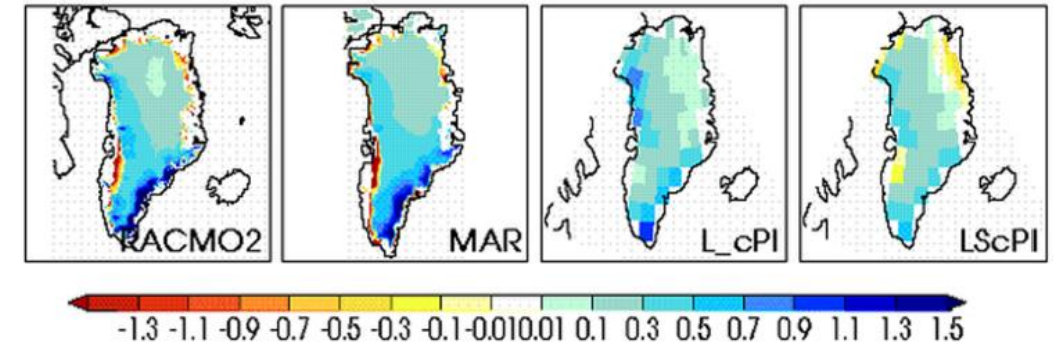

e.g., Punge et al. 2012

15 OCTOBER 2013

VIZCAÍNO ET AL.

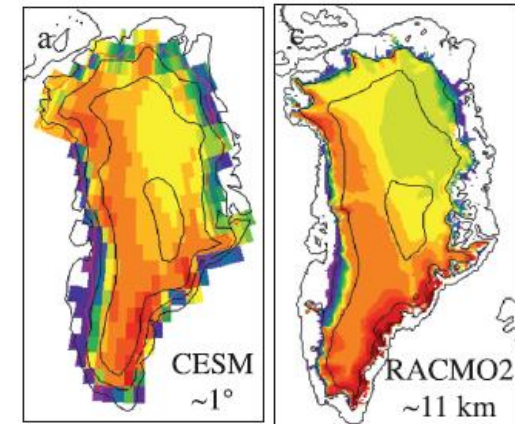
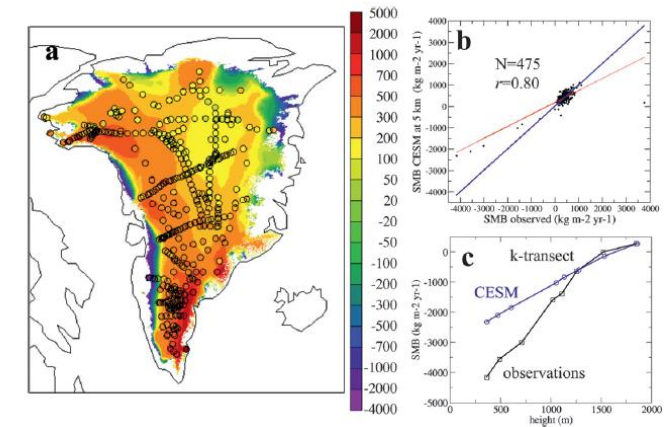

e.g., Vizcaino et al. 2013

Potential Remedies – Simple Downscaling

- Flux-corrected (anomaly): similar techniques were first used in atmosphere/ocean coupling.
- Methods could also incorporate topographic downscaling (e.g., Helsen et al., 2012).
- Application is specific to a particular ESM.
- These methods may not work in a transient climate.
- Does not adequately compensate for missing physics.

Coupled ocean-atmosphere models with flux correction

R Sausen¹, K Barthel², and K Hasselmann³

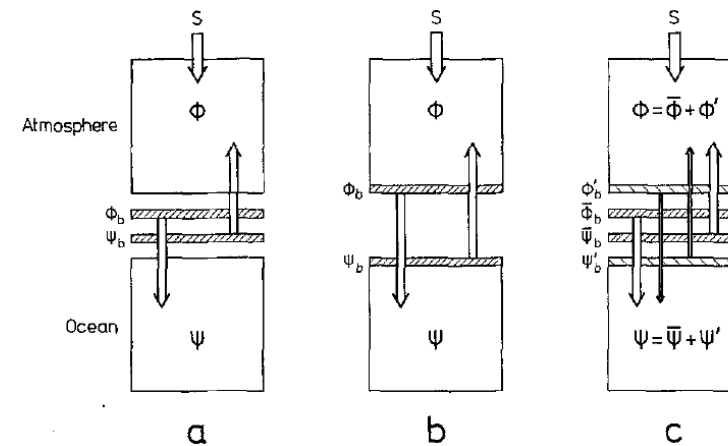

Fig. 1a–c. Boundary or coupling conditions of atmosphere and ocean models in different modes: **a** uncoupled; **b** fully coupled and **c** flux corrected

Influence of Spatial Resolution and Treatment of Orography on GCM Estimates of the Surface Mass Balance of the Greenland Ice Sheet

ROBIN W. GLOVER

Potential Remedies – Intermediate Complexity Models (e.g., PDD)

- Development of a surface “wrapper” to interface between ESM output and ISM.
- Physics might be better controlled in-house.
- Not specific to particular ESM.
- Development by the ISM, may be considerable investment.

COUPLING AN ICE SHEET MODEL TO
EC-EARTH

Jeroen VAN LENT

19 January 2013

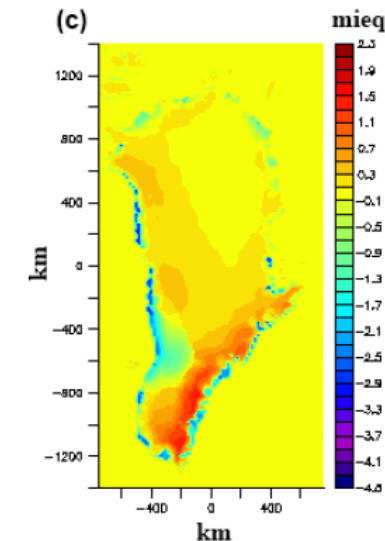

Potential Remedies – Offline Dynamical Downscaling

- Use of RCM for providing fields.
- Arguably the most comprehensive physical representation.
- Time consuming, computationally expensive.
- Potentially dependent on differences among RCMs.

Estimating the Greenland ice sheet surface mass balance contribution to future sea level rise using the regional atmospheric climate model MAR

X. Fettweis¹, B. Franco¹, M. Tedesco², J. H. van Angelen³, J. T. M. Lenaerts³, M. R. van den Broeke³, and H. Gallée⁴

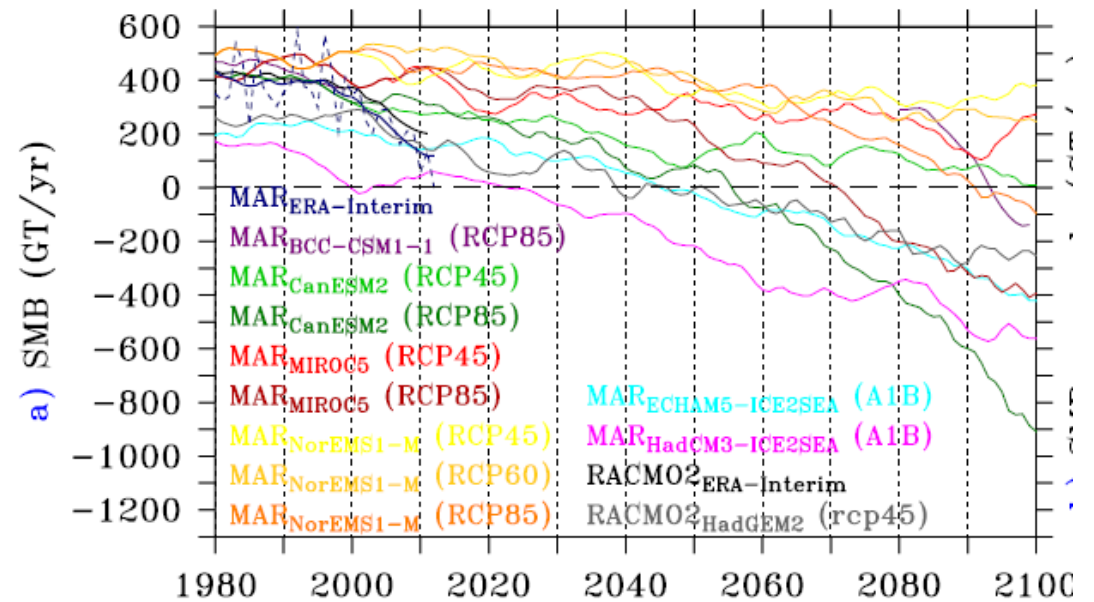

Potential Remedies – Embedded Dynamical Downscaling

- Height classes, etc.
- In development among several ESM groups. But not all.
- Provides the most reliable SMB directly from the ESM.
- There remain difficulties/artifacts in methods.
- ESM-dependent.

Greenland Surface Mass Balance as Simulated by the Community Earth System Model. Part I: Model Evaluation and 1850–2005 Results

MIREN VIZCAÍNO,^{*,+} WILLIAM H. LIPSCOMB,[#] WILLIAM J. SACKS,[@] JAN H. VAN ANGELEN,^{**}
BERT WOUTERS,⁺⁺ AND MICHEL R. VAN DEN BROEKE^{**}

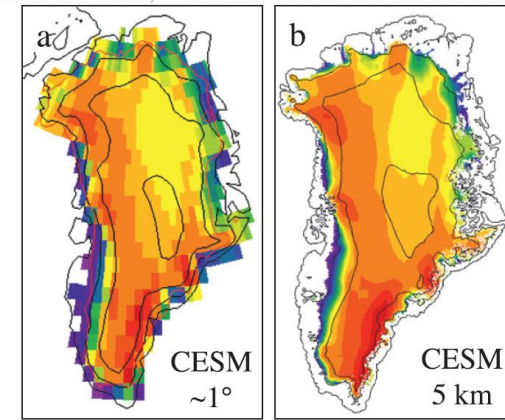

A system of conservative regridding for ice–atmosphere coupling in a General Circulation Model (GCM)

R. Fischer^{1,2}, S. Nowicki³, M. Kelley^{2,4}, and G. A. Schmidt²

Discussion

- In model integrations we have:
 1. Uncertainty in the performance of the ISM.
 2. Uncertainty in the boundary forcing fields.
 3. Uncertainty in the *downscaling of the boundary forcing fields (!?!).*Which methods are more likely to add the third layer of uncertainty?
- **Liability**: who is responsible for deficiencies in boundary forcing fields?
- Should integrations be restricted to a sub-set of ESMs that provide realistic, high resolution SMB? What is lost in doing so?
- SMB is validated using the contemporary (or past) climate. How do we evaluate conditions for the future climate?