



“Parallels in Communication and Navigation Technology and Natural Phenomenon”

The Nature Inspired Exploration for Aerospace 2017 Bio mimicry
Summit

Ohio Aerospace Institute
October 4-6, 2017

Dr. Robert Romanofsky
Senior Technologist
Communications and Intelligent Systems Division
NASA Glenn Research Center
Cleveland, OH



Recognizing Themes and Patterns in Nature and Technology

- The premise is more than art imitates life, or technology imitates nature – it is a nascent step to see how we might be *unwittingly* inspired and influenced.
- An introspective search for hidden connections between technology and nature – especially as it pertains to links between electromagnetics in navigation and communication systems and biology, etc.
- Perhaps a *superficial* attempt to enumerate and examine these types of connections and parallelisms.
- “But ask the animals, and they will teach you, or the birds in the sky, and they will tell you; or speak to the earth, and it will teach you, or let the fish in the sea inform you.” Job 12: 7-13
- “All things by immortal power, near or far, to each other linked are, that thou canst not stir a flower without troubling of a star,” Francis Thompson, Mistress of Vision
- “Life imitates art far more than art imitates life”, from Oscar Wilde’s essay “The Decay of Lying,” discusses life's imitative instinct, and that the self-conscious aim of life is to find expression.

The Schmitt Trigger

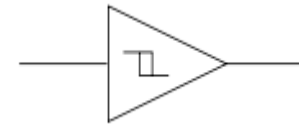

- A Schmitt Trigger is a bistable device used to square-up waveforms with slow rise and fall times – to convert a sinewave into a square wave for example, or to remove noise, by using a detection threshold feature
- “There are numerous electrical systems in which it is desired that a slowly varying potential from some control device shall actuate another circuit in a positive, “on-off” manner,” Otto H Schmitt, A Thermionic Trigger, *J. Sci. Instrum.* **15** 24 (1938)
- He developed the Schmitt trigger by studying nerves in squids, attempting to engineer a device that replicated the biological system of nerve propagation
- Otto Schmitt had a gift for drawing connections between disparate disciplines. The term “biomimetic” was coined by Otto Schmitt in 1959 ²

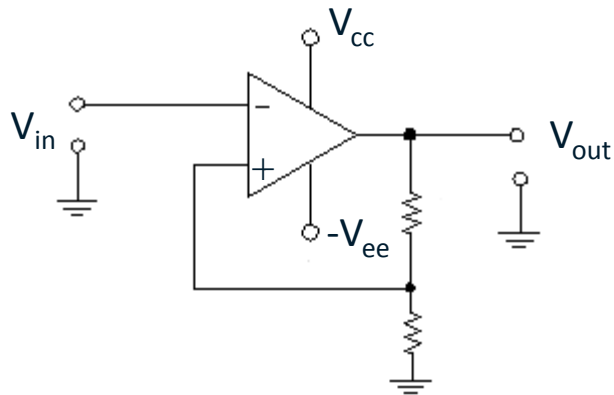

Op Amp implementation of a Schmitt trigger

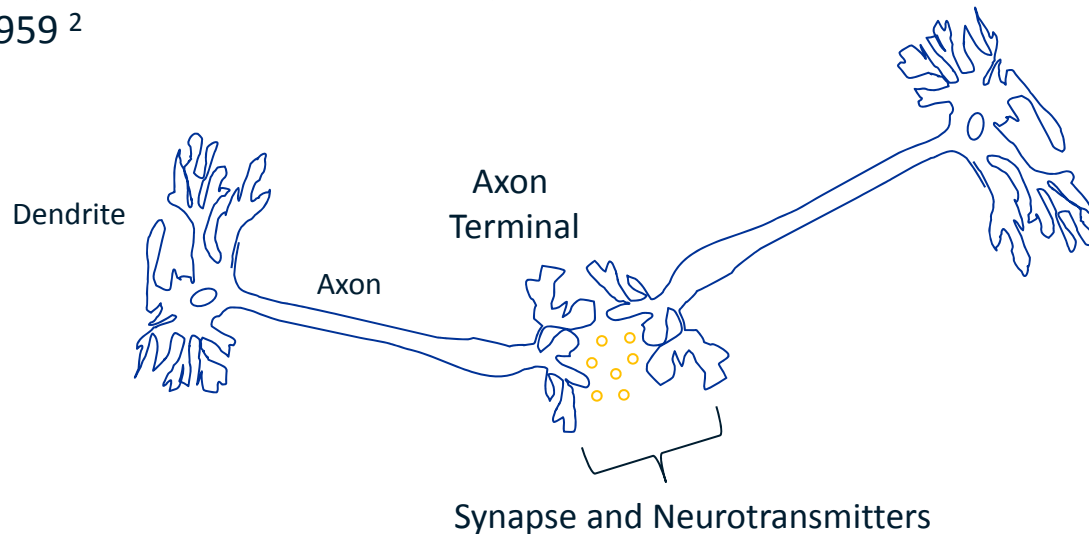

Communication from a neuron to a neuron. Communication channel is closed when the membrane potential is near resting potential of the cell, but rapidly opens when the membrane increases to a precisely defined threshold voltage

² Jon M. Harkness, “In Appreciation A Lifetime of Connections: Otto Herbert Schmitt, 1913–1998,”



Scale-free correlations in collective motion: (“sense and avoid”)





Scale-free correlations in collective motion with position-based interactions

- Collective Motion (CM) is observed in a variety of animal groups such as bird flocks and fish schools. The correlation lengths of speed and velocity fluctuations in starling flocks are not set by a specific interaction range, but are instead scale-free, proportional to the group size. So far, this observation has been justified by hypothesizing that flocks evolved to follow critical dynamics near a phase transition, where scale-free correlations are known to emerge. Criticality could provide an evolutionary advantage by allowing the flock to optimally respond to an external perturbation such as a predator attack³
- Ferrante, et al. considered an active elasticity model, where N self-propelled agents are moving in 2D, with neighbors permanently linked by spring-like linear forces. The results above show that the scale-free correlations observed in starling experiments are not necessarily due to a critical regime, but can be a natural consequence of position-based interactions among individuals. Our work also provides a bio-inspired algorithm that can produce coherent, group-level collective motion for robot swarms or other artificial flocks.
- Decentralized control algorithms are better than centralized control algorithms because they are more resilient, given a centralized algorithm has a single point of failure.
- In an artificial swarm, Instead of each drone broadcasting to every other drone a complete map of safe space, the decentralized algorithm has drones only share maps with their immediate neighbors — sharing only relevant intersected data on to the next neighbor.

³ E. Ferrante et al., "Scale-free correlations in collective motion with position-based interactions," Proceedings of the Fourteenth International Conference on the Synthesis and Simulation of Living Systems

See also <https://techcrunch.com/2016/04/22/mit-creates-a-control-algorithm-for-drone-swarms/>



Predator-Prey Theory and Health of the Space Industrial Base

- Physical sciences represent natural behaviors using differential equations
- The classical Lotka-Volterra (L-V) equations are used to model assemblies of interacting entities that influence one another through competition and cooperation.
- Classical L-V or predator-prey coupled equations are first-order, non-linear differential equations that show how the two populations evolve and generally leads to periodic fluctuations with prey lagging predator maxima
- The canonical equations are:

$$dp/dt = p(\alpha - \beta P) \quad (1)$$

$$dP/dt = -P(\gamma - \delta p) \quad (2)$$

where p and P represent the prey and Predator populations, respectively. The growth rate of prey in the absence of predation is α and β is the predator interaction parameter or the effect that predation has on the prey. The predator death rate in the absence of prey is γ and δ is the prey interaction parameter or the effect of prey on the predator population.

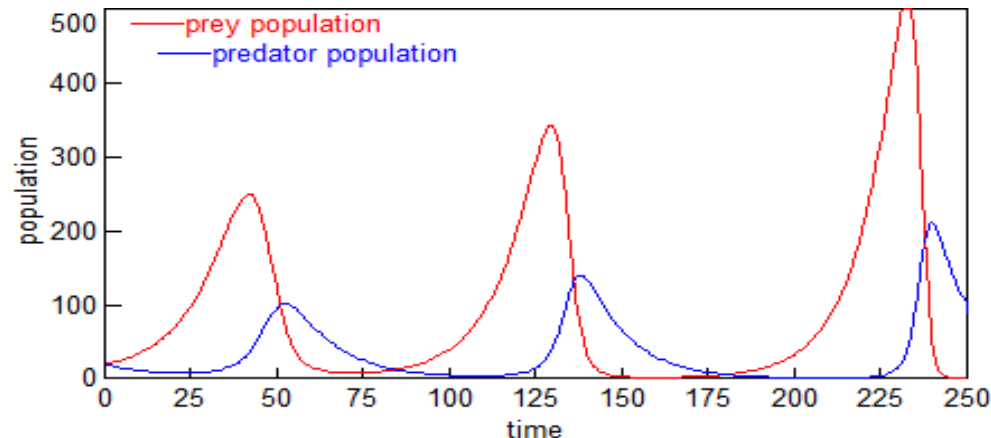

- The equations do not account for mutations or environmental adaptation. In the context of a space industrial base model, this means the basic equations would not account for technological obsolescence or game changing breakthroughs
- These simple models yield very rich/dynamic interaction results, and are in fact closely associated with so-called chaos theory. The survival or demise and associated timeline are critically dependent on the choice of initial conditions or interaction parameters. The sensitivity is often referred to as the **butterfly effect**.



Predator-Prey Theory and Health of the Space Industrial Base

- Predictions diverge so rapidly for chaotic systems, forecasting is impossible even though future trends are completely determined by initial conditions. That is, the process *is* deterministic, not random - there is a precise rule for how the system evolves from an initial condition or state. Nevertheless, the deterministic nature of this system does not make it predictable. Trends and sensitivities to certain parameter ranges may make it an imperfect but useful “crystal ball.”
- Modified Lotka-Volterra set of equations are proposed:

$$dp/dt = p\alpha[1 - p] + Pp(1 - \beta)/[(1 - \kappa)/(K(\kappa) + K_p)] + n_p(t) \quad (3)$$

$$dP/dt = P\gamma[1 - P] - pP\beta/[(1 - \kappa)/(K(\kappa) + K_p)] + n_P(t) \quad (4)$$

α	inherent per-capita growth rate of the competition
γ	inherent per-capita growth rate of the SIB
$K(\kappa)$	global commercial space free-market (a variable that fluctuates and hopefully grows with time)
κ	represents “cooperation” ($0\% < \kappa \leq 100\%$)
K_p	competitor’s domestic non-commercial market (e.g. defense or civil)
K_P	SIB domestic non-commercial market (e.g. defense or civil)
β	competitor’s percentage share of global health ($0\% < \beta < 100\%$)
$n_p(t)$	“noise” (fluctuations) associated with competitor’s environment
$n_P(t)$	“noise” (fluctuations) associated with the SIB’s environment

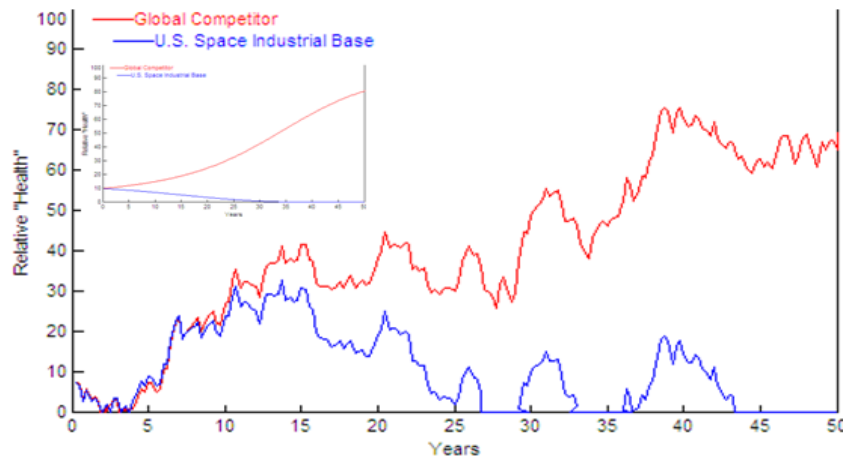

Model output for Case 1: $\beta=0.499$, $\alpha=0.099$, and $\gamma=0.033$. κ was arbitrarily set to 5%. Inset is without noise.



Crystals and Periodic Structures

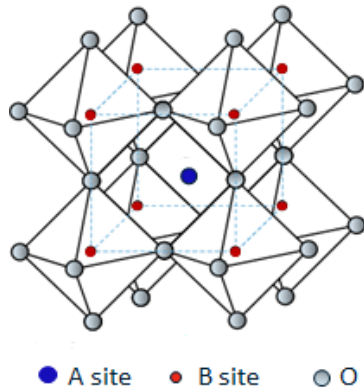

Perovskite crystal structure showing oxygen octahedral cage. Perovskite crystal family. The crystal structure is given by the general chemical formula ABO_3 where the A element is a large cation situated at the corners of the unit cell, the B element is a smaller cation located at the body center, and O are oxygen atoms forming an octahedron. The A-site ion is generally an alkaline earth or rare earth element and the B site ion a transitional metal element

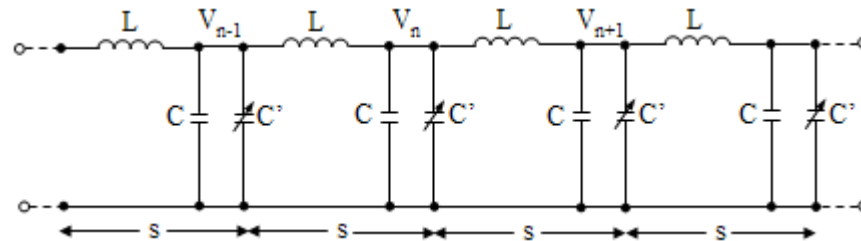

A chain of LC circuits representing an infinite, periodically loaded transmission line resulting in slow-wave propagation.

Consider a cascade of short sections of lossless transmission line shunted by a voltage variable capacitance C' , so as to form the infinite periodic structure as illustrated. Each distributed transmission line section is modeled by an LC circuit and each unit cell consists of L, C, and C' . Let the separation of each unit cell be designated as s . Such periodic structures exhibit slow-wave behavior ($v_p \ll c$) and band-pass characteristics, like filters. The phenomenon is analogous to acoustic wave propagation in crystal structures. These types of circuits are used as phase shifters. A wave traveling through this periodic structure will only experience a phase shift from unit cell to unit cell, such that V_n is delayed relative to V_{n-1} as

$$V_n = V_{n-1} e^{-j\theta_s}$$

In general, θ_s could be complex to account for attenuation as well as phase shift. Summing currents leaving node n

$$0 = V_n(j\omega C + j\omega C') + (V_n - V_{n-1})(-j/(\omega L)) + (V_n - V_{n+1})(-j/(\omega L))$$

Substituting we arrive at

$$\cos(\theta_s) = \frac{1}{2}(2 - \omega^2 L(C + C'))$$

Requiring θ_s to be real to represent a propagating mode, letting $\cos(\theta_s) = \pm 1$, we find the structure has a zero lower frequency cutoff ω_L (obvious by inspection) and an upper cutoff frequency ω_H corresponding to

$$\omega_H = 2/(L(C + C'))^{1/2}$$



There are similarities between the way a field of grass responds to a breeze and the natural restoring forces of a semiconductor crystal.



In the case of simple harmonic motion, restoring force is proportional to displacement

Waves and Diffraction



- The same mathematical foundations underlie acoustical and electromagnetic waves. A wave is a disturbance in a medium. An electromagnetic wave travels along a transmission line at speed

$$s = \sqrt{\frac{1}{C L}} \quad \text{An transverse wave travels along a guitar string with speed} \quad s = \sqrt{\frac{T}{\mu}}$$

where C and L are capacitance and inductance per unit length, T is tension (stiffness) and μ is mass per unit length. Compliance is the inverse of stiffness.

- Diffraction refers to various phenomena that occur when a wave encounters an obstacle (e.g. a slit). The “shadow” is not what would be expected from geometrical optics (i.e. ray tracing).
- Christiaan Huygens (1629–1695) was a Dutch mathematician, astronomer and physicist. He recognized that light was a wave and “Each point on a wavefront acts as a source of secondary wavelets. The combination of these secondary wavelets produces the new wavefront in the direction of propagation.”



Waves in a slowly moving river can lap backwards against a peninsular shoreline mimicking a diffraction effect



DNA Data Storage: 3.6 billion years of evolution

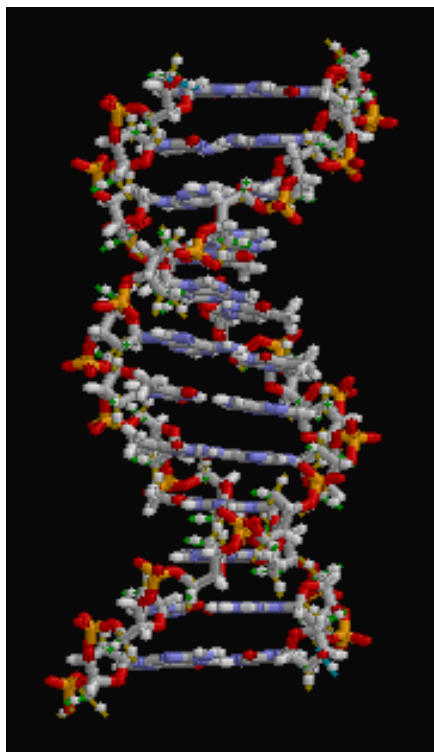

Concept: store digital data in the base sequence of DNA

- four-lettered nucleic acid-based alphabet of DNA (A, C, G and T) can be transformed into binary code—for example, as 00 for A, 01 for C, 10 for G and 11 for T
- Extreme chemical stability and rapid replication
- Schrödinger argued that life could be thought of in terms of storing and passing on biological information
- Genetic information storage demanded tremendous information density (100,000 times more dense (bits/volume) than a flash drive)
- Data retention time > 1,000 years
- A single image from HiRISE camera on the Mars Reconnaissance Orbiter can be 28 gigabits. The solid state recorder stores 160 gigabits on 700 flash memory chips.

“A Brief History of Nucleic Acid-based Information Storage”, H. Park, Library of Congress Designing Storage Architectures Meeting, September 19, 2017 (adapted from lecture notes of Jack Szostack)

http://www.bing.com/images/search?sp=-1&pq=dna+photo&sc=8-&sk=&cvid=234322AC76FF45E6898B97F7EE659795&q=DNA+photo&qft=+filterui:license-2_L3_L4_L5_L6_L7&FORM=R5IR43

https://www.nobelprize.org/nobel_prizes/medicine/laureates/1962/perspectives.html



Artificial Muscles and Deployable Antennas

- Ionic Polymer Metal Composites are created by embedding a metal a few microns into an ionic polymer through a series of oxidation-reduction reactions (platinum is imbedded into Nafion). When a voltage is applied they bend towards the anode, acting as actuators. Originally they attracted much attention because of their potential for use as artificial muscles and other medical applications, but recently have been used for a wide variety of applications. Typical behavior is illustrated in the figure.
- The IMPC of length L undergoes an end deflection δ such that the radius of curvature $\rho \approx (L^2 + \delta^2) / 2\delta$.

Application to Inflatable Antennas

Large deployable antennas operating at Ka-band frequencies and above will require active sensing systems to determine the shape of the primary reflector. Shape errors can be compensated for by using an articulated feed to provide beam shaping.

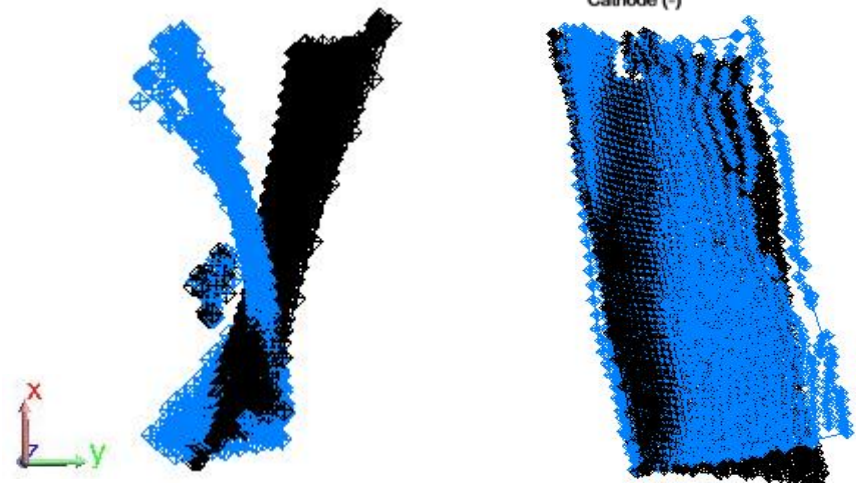
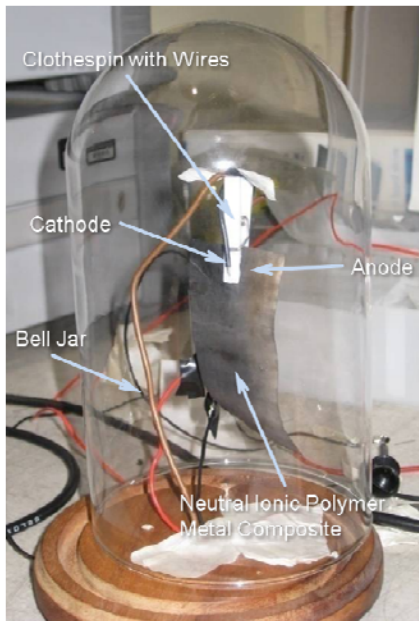
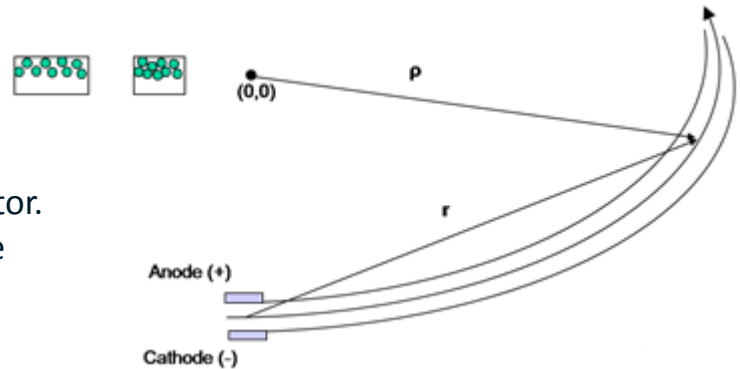

IPMC, mapped with LR200 laser, with 500 Å of gold applied. Scan shows both in neutral state (black) and with applied 5V (blue), with gold side touching anode. Bottom View (left). Front View (right). Maximum deflection was 0.59 inches. IPMC sample was made at the University of Maine, Orono

K. Shaler and R. Romanofsky, "Surface Metrology of Inflatable Cassegrain Antenna System: Comparison of LR200 and Photogrammetry Systems," 2009



Genetic Algorithms and Evolvable Antennas

- Modern biology began in the nineteenth century with Charles Darwin's work on evolution
- Natural selection concerns the survival and reproduction of individuals due to differences in phenotype. It is the basic mechanism of evolution - adaptation that is inherited in a population
- Genetic algorithms are commonly used to generate optimized solutions by relying on bio-inspired operations such as mutation
- Evolution is an iterative process and starts from a population of randomly generated solutions, with the population in each iteration called a generation. The fitness (objective function) of each solution in the population is evaluated
- Developed for the ST5 nanosat mission to measure the effect of solar activity on the Earth's magnetosphere.
- ST5 mission successfully launched on March 22, 2006 and the antenna shown below represents the world's first artificially-evolved object to fly in space

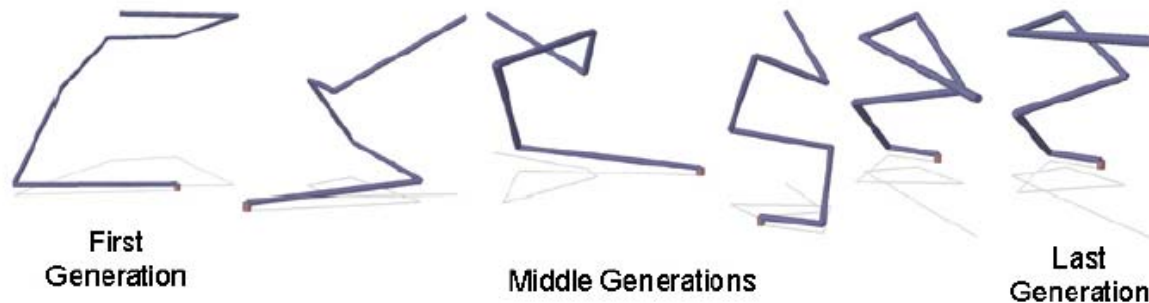

Fitness (objective) function is proportional to voltage standing wave ratio and gain error. The goal is to minimize the function



NASA ST5 spacecraft antenna evolved to optimize the radiation pattern



Butterflies and Optical Communications



Morpho rhetenor butterflies exhibit coloring through structure (multilayer scales) rather than pigmentation. A display technology based on the reflective properties of Morpho wings was commercialized by Qualcomm in 2007. Interference patterns can be formed from multilayer thin films.

https://en.wikipedia.org/wiki/Morpho_rhetenor

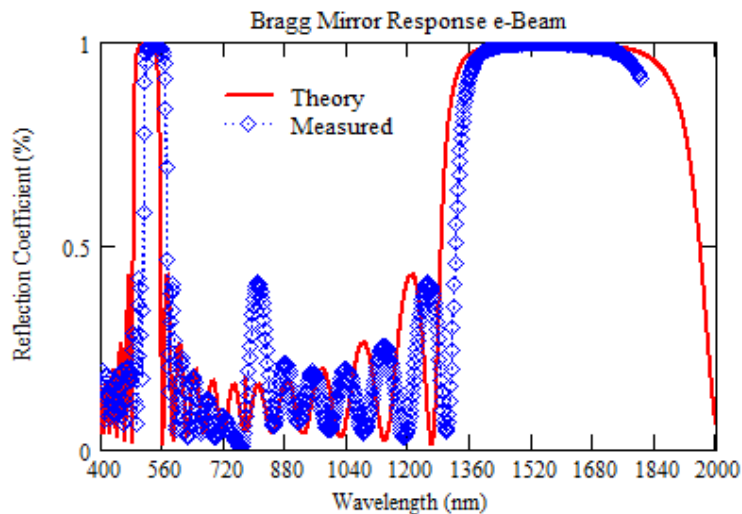

RF Transparent Bragg Sub-reflector for the NASA Glenn Integrated Radio and Optical Communications project. The mirror consists of an 11 layer stack-up of rutile (158 nm thick) and silica (269 nm thick) fabricated by pulsed laser deposition. The mirror sits in front of the 32 GHz feed so needs to be transparent at microwave wavelengths. Measured results for e-beam evaporated 11 layer TiO₂/SiO₂ dielectric mirror. Reflection at 1550 nm is >99.6 %.⁴

⁴R. Romanofsky, "The Teletenna - a Hybrid Telescope Antenna System," Patent Pending, LEW 19485-1



Conclusions

- The origin and process of innovation and invention by humans as problem solvers can be difficult to trace – separating true bio-inspiration from coincidence.
- There are many other examples than were described herein because of the time limitation. These include spiral antennas mollusks, photosynthesis and artificial leaves, The whispering Gallery of St Paul's Cathedral (London) and whispering gallery mode resonators, a bats' high-frequency transmitter may be more efficient and sensitive than radar systems created by human beings, saturniidae moth antennas and infrared sensors, jerk equations and chaotic systems and jerk circuits, entangled photons and an emerging discipline that questions whether or not everything in the universe is interconnected - how could it be otherwise?
- “The potential of reinventing nature’s innovation may be reduced if these inventions can be documented, not as biological observations but as engineering mechanisms and tools. Effectively, there is a need to establish a database and handbooks that logically catalogues nature’s capabilities, specifications, mechanisms, processes, tools and functions in terms of principles, materials, dimensions, limitations, etc.... Such documentation might help to accelerate advances in human made technologies.”⁵

⁵ “Biomimetics: mimicking and inspired-by biology,” Y. Bar-Cohen, Proceedings of the SPIE Smart Structures Conference, San Diego, CA., SPIE Vol. 5759-02, March 7-10, 2005

See, for example: “Teorija Reshenija Izobretatel'skih Zadach,” (Theory of Inventive Problem Solving)