



Materials Science on the International Space Station

Dr. Martin Volz, NASA Marshall Space Flight Center
Martin.Volz@nasa.gov



Early Microgravity Applications



NASA was not the first to understand and utilize the benefits of processing materials in a microgravity environment.

William Watts of Bristol, England built a “drop tower” in 1753 to process molten lead into uniformly spherical shot for firearms



**Boughton Shot Tower
Chester, England
1799, 168' tall**



Molten lead is poured



Through a sieve

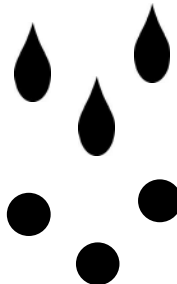

**Uniform drops freefall
(microgravity), buoyancy
effects are minimized**

**Surface tension dominates
forming uniform spheres**



**Solidified shot lands in a
cushion of cooling water**



**Phoenix Shot Tower
Baltimore, MD, 1828
234' - tallest structure in US
2.5 million pounds shot/year**



Long Duration Microgravity Materials Science Research



| Foundational Era 1950's to 1980 | Shuttle Era 1980 to 2000 |
|--|-----------------------------|
| Mercury / Gemini / Apollo / Soyuz Spacecraft / Skylab | STS and MIR |

Soyuz 6 1969 1st Welding Experiment
 Apollo 14 1971 Composite Casting
 Skylab 1973-1979



Apollo Furnace



Skylab

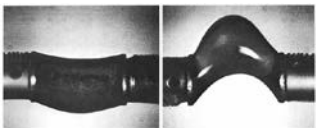

Skylab: "such tests proved that the processing of metals without using containers is feasible in space".



Skylab Materials Processing Facility
 Multipurpose Furnace System

| TECHNOLOGY | |
|------------|---------------------------------------|
| D008 | RADIATION IN SPACECRAFT |
| D024 | THERMAL CONTROL COATINGS |
| M415 | THERMAL CONTROL COATINGS |
| M479 | ZERO-g FLAMMABILITY |
| M512 | MATERIALS PROCESSING FACILITY |
| M551 | METALS MELTING |
| M552 | EXOTHERMIC BRAZING |
| M553 | SPHERE FORMING |
| M555 | GALLIUM ARSENIDE CRYSTAL GROWTH |
| M516 | CREW ACTIVITIES / MAINTENANCE STUDY |
| M518 | MULTIPURPOSE FURNACE SYSTEM |
| M556 | VAPOR GROWTH OF II-VI COMPOUNDS |
| M557 | IMMISCIBLE ALLOY COMPOSITIONS |
| M558 | RADIOACTIVE TRACER DIFFUSION |
| M559 | MICROSEGREGATION IN GERMANIUM |
| M560 | GROWTH OF SPHERICAL CRYSTALS |
| M561 | WHISKER-REINFORCED COMPOSITES |
| M562 | INDIUM ANTIMONIDE CRYSTALS |
| M563 | MIXED M V CRYSTALS GROWTH |
| M564 | METAL AND HALIDE EUTECTICS |
| M565 | SILVER GRIDS MELTED IN SPACE |
| M566 | COPPER-ALUMINUM EUTECTICS |
| T003 | IN-FLIGHT AEROSOL ANALYSIS |
| T025 | CORONAGRAPH CONTAMINATION MEASUREMENT |
| T027 | ATM CONTAMINATION MEASUREMENT |
| T053 | EARTH LASER BEACON |

- STS3 1982 Latex Spheres
- STS9 1983 Spacelab 1
- STS17 1985 Spacelab 3
- STS51B 1985 Spacelab 2
- STS61A 1985 Spacelab D1
- STS40 1991 Spacelab LS1
- STS42 1992 IML1
- STS50 1992 USML
- STS46 1992 EUREKA
- STS47 1992 Spacelab-J
- STS55 1993 Spacelab D2
- STS57 1993 LEMZ
- STS60 1994 CLPS
- STS62 1994 USMP2
- STS65 1994 IML2
- STS73 1995 USML2
- STS76 1996 QUELD LPS
- STS77 1996 CFZF SEF
- STS78 1996 LM2
- STS94 1997 MSL
- STS87 1997 USMP4



STS3
 Latex
 Spheres



STS9
 InP
 THM



IML1
 HgI
 VCG

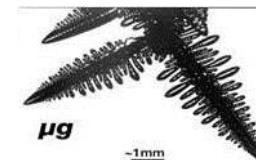

USMP2
 IDGE



Materials Science Performance Goal



Establish and improve quantitative and predictive relationships between the structure, processing, and properties of materials.

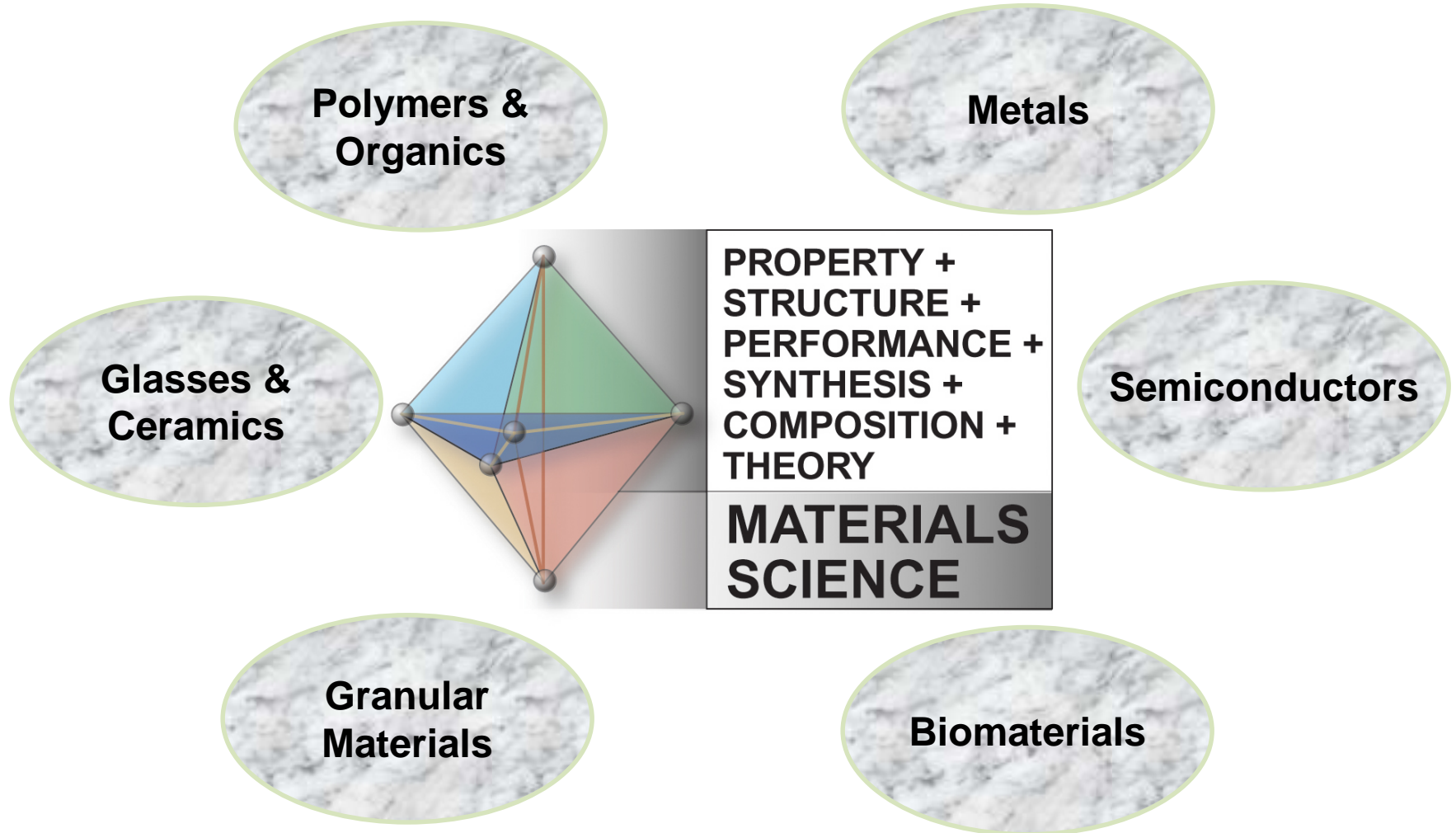



Microgravity Reduces Thermal and Solutal Convection



- Microgravity promotes diffusion controlled growth and the uniform solidification of microstructures

Earth-grown



Pb-Sb
Anisotropic dendrite formation

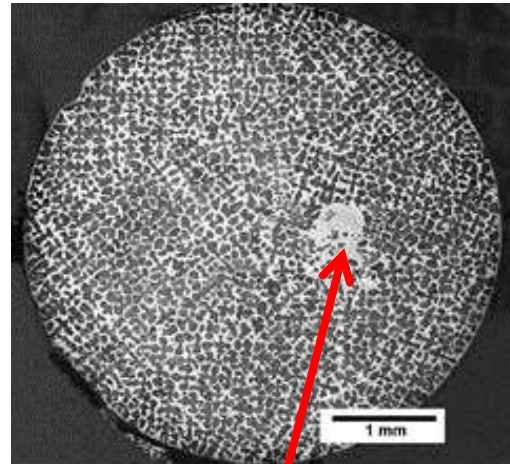

Segregation channel
Pb-Sn

Space-grown

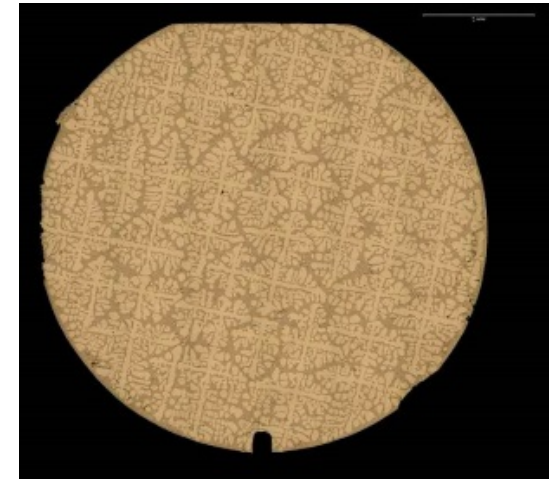

Al 7% Si alloy
uniform microstructure



Microgravity Minimizes Sedimentation and Buoyancy



- Promotes uniform particle distributions
- Advances our understanding of coarsening and sintering

Earth

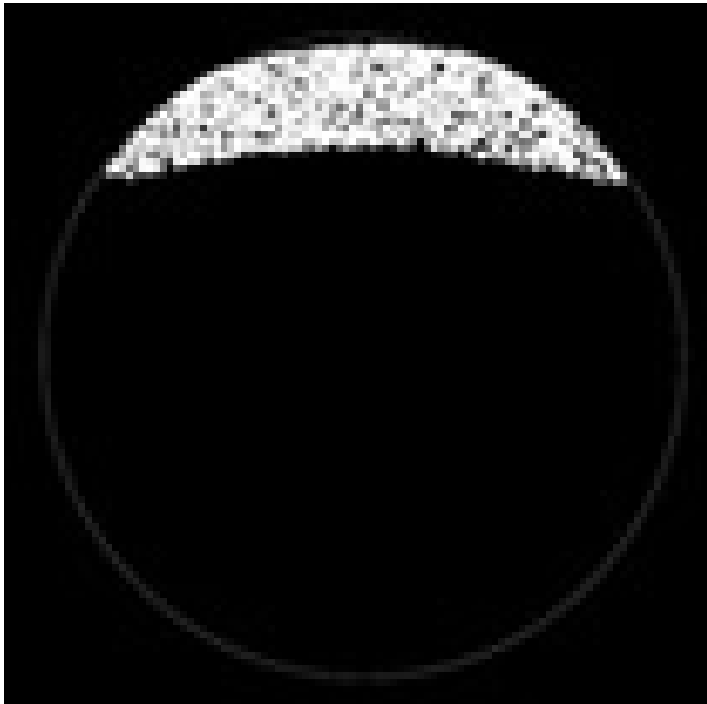

Pb-Sn alloy (*Sn in white*)
Particles rise to top

Space

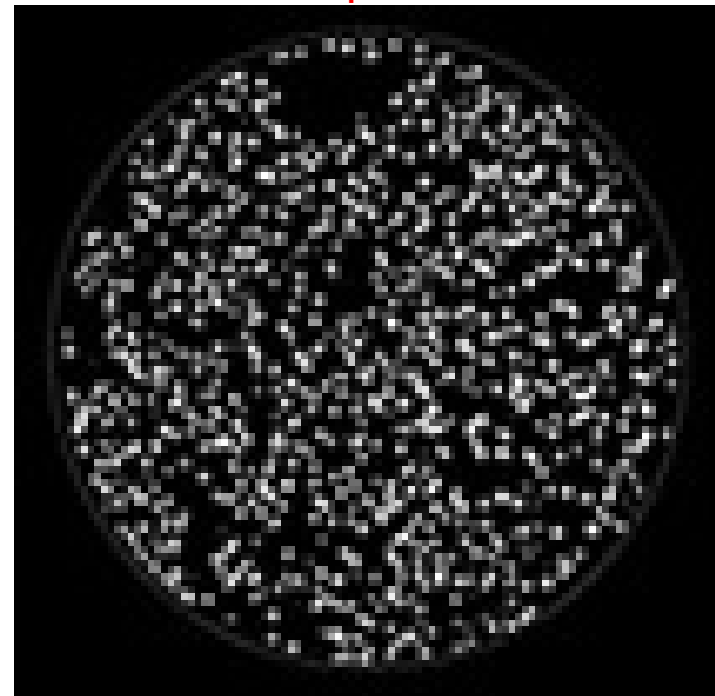

Pb-Sn alloy
uniform particle distribution



Microgravity Increases Dopant Homogeneity in Semiconductors



Objective

- Semiconductors are often doped to establish specific electronic properties (i.e. n-type or p-type).
- Convection on Earth can cause the distribution of these dopants to be inhomogeneous, degrading the suitability of crystals for their intended application.
- Absence of convection in microgravity enables an uniform distribution of the dopants.

Earth-grown



Space-grown

Right: Te segregation behavior revealed by etching InSb. Top portion is the seed crystal grown on Earth. Bottom section is regrowth in microgravity. Sample grown during the Skylab mission.

A. F. Witt, H. C. Gatos, M. Lichtensteiger, M. C. Lavine, and C. J. Herman, *Journal of the Electrochemical Society* **122**, 276-283 (1975)



Microgravity Expands the Possibilities for Containerless Processing



- Enables accurate measurements of material properties such as viscosity and surface tension
- Facilitates nucleation studies
- Increases the size of crystals that can be grown containerless
- Reduces defect densities from contact with container wall

Earth

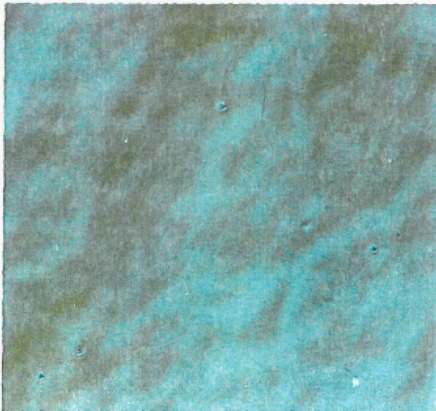

Space



Above: Magnification of defect structures from CdZnTe samples grown on Space and on Earth. The microgravity sample was grown during the USML-1 SpaceLab mission in 1992. Growth in microgravity resulted in a 100-fold decrease in defect density as compared to Earth.

Feed rod

Melt

Crystal



Si Float-Zone sample. The weight from gravity collapses the melt zone. The size and types of materials that can be processed are increased in microgravity



Microgravity Enables Study of Physical Phenomena Normally Masked by Gravity



- Thermocapillary effects and surface tension effects become paramount

Soldering drop in microgravity from the ISSI investigation.

Thermocapillarity causes flux and resultant bubbles to coalesce at the junction, weakening the joint.

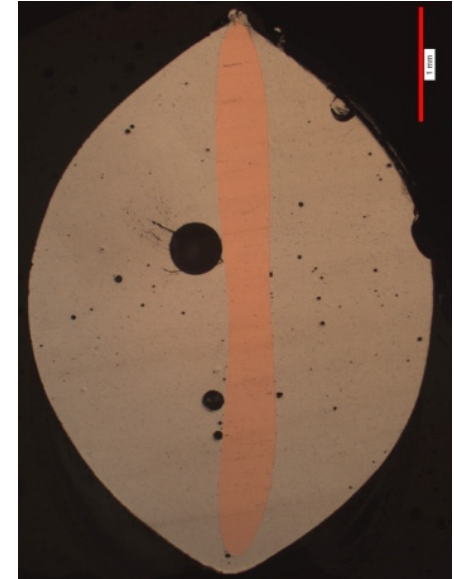

- Removal of pressure head effects allows the study of granular materials
- Absence of buoyancy convection enables the study of thermocapillary and solutocapillary effects in systems with free surfaces



Initial U.S. Materials Experiments on the ISS



Solidification Using a Baffle in Sealed Ampoules (SUBSA): MSG; Dr. Aleksander Ostrogorsky

- A series of InSb semiconductors were grown doped with Te and Zn under diffusion controlled conditions.

Pore Formation and Mobility Investigation (PFMI): MSG; Dr. Richard Grugel:

- Vapor bubble transport due to thermocapillary forces and the resultant microstructural disruption during melting

In Space Soldering Investigation (ISSI): Microgravity Workbench; Dr. Richard Grugel

Coarsening in Solid-Liquid Mixtures (CSLM): MSG; Dr. Peter Voorhees

- Observed coarsening in Pb-Sn mixtures

Dynamic Selection of Three-Dimensional Interface Patterns in Directional Solidification: DECLIC DSI; Dr. Rohit Trivedi

- Observed time dependent behavior showed cyclical patterns of expanding then contracting cellular tip radii

Comparison of Structure and Segregation in Alloys Directionally Solidified in Terrestrial and Microgravity Environments: MSRR LGF, SQF; Dr. David Poirier

- Examine the effects of growth speed and speed-changes (step increase in growth speed and step decrease in growth speed) on the primary dendrite distribution and morphology during steady-state directional solidification of single crystal dendritic arrays (Al 7%Si alloys).



Materials Science Facilities on the ISS: Materials Science Glovebox (MSG) Facilities

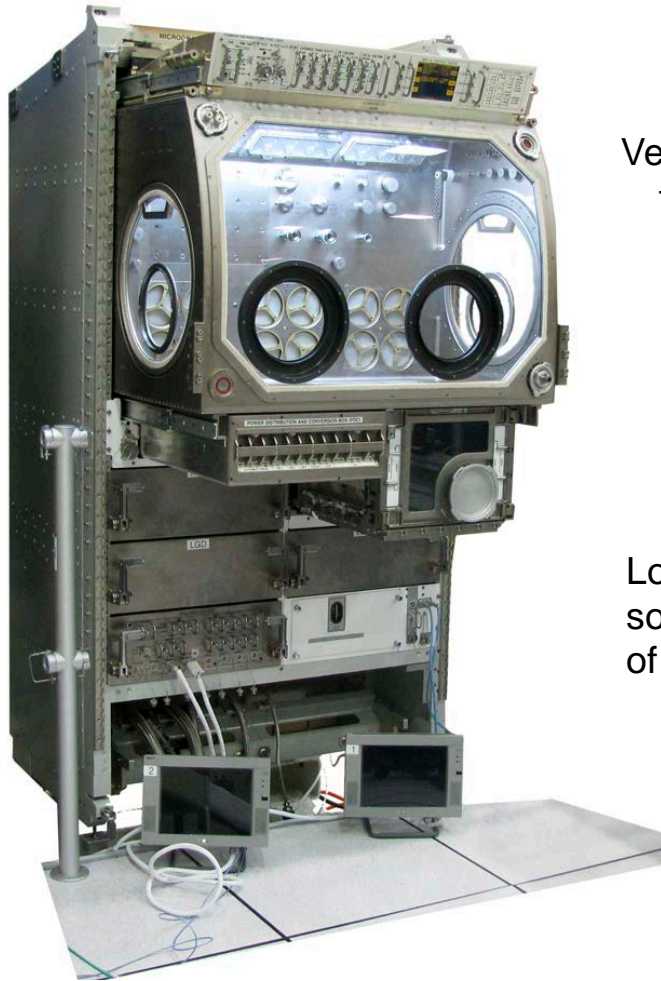

Materials Science Glovebox

SUBSA
Vertical gradient furnace with
transparent growth zone



PFMI
Low temperature furnace for
solidification and remelting
of transparent materials

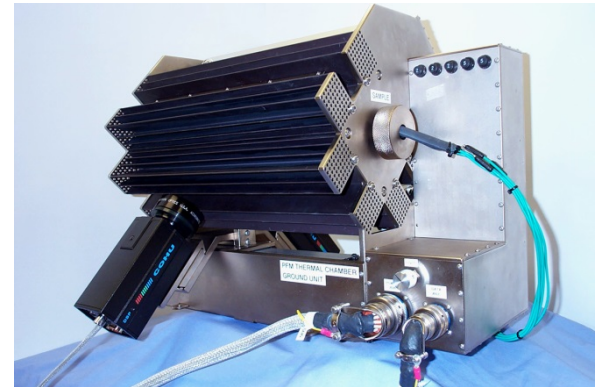

CSLM
Quench furnace used for
coarsening experiments

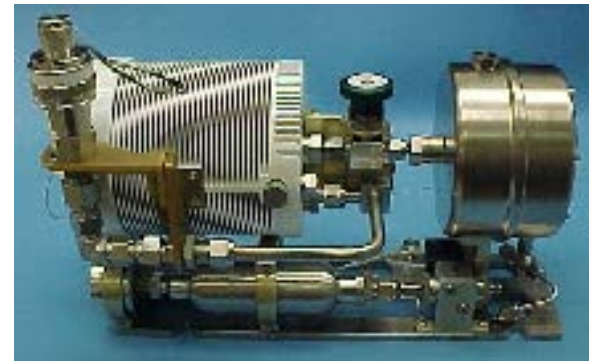



Materials Science Facilities on the ISS: Electromagnetic Levitator

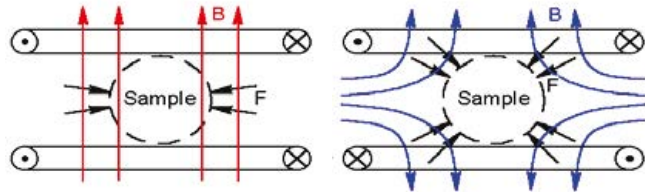
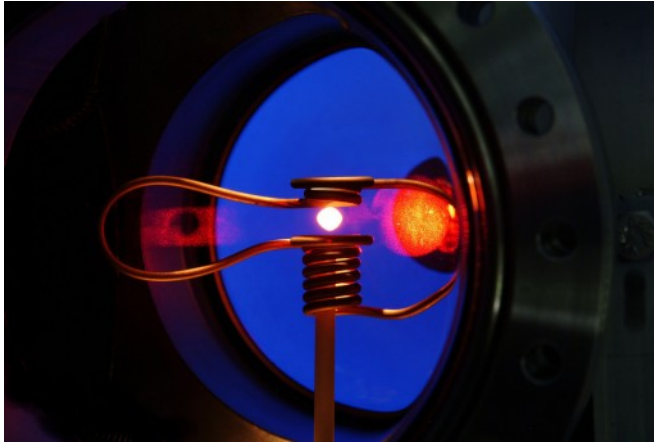

EML uses one °Ccoil for both dipole heating (red lines) and quadrupole positioning (blue lines)

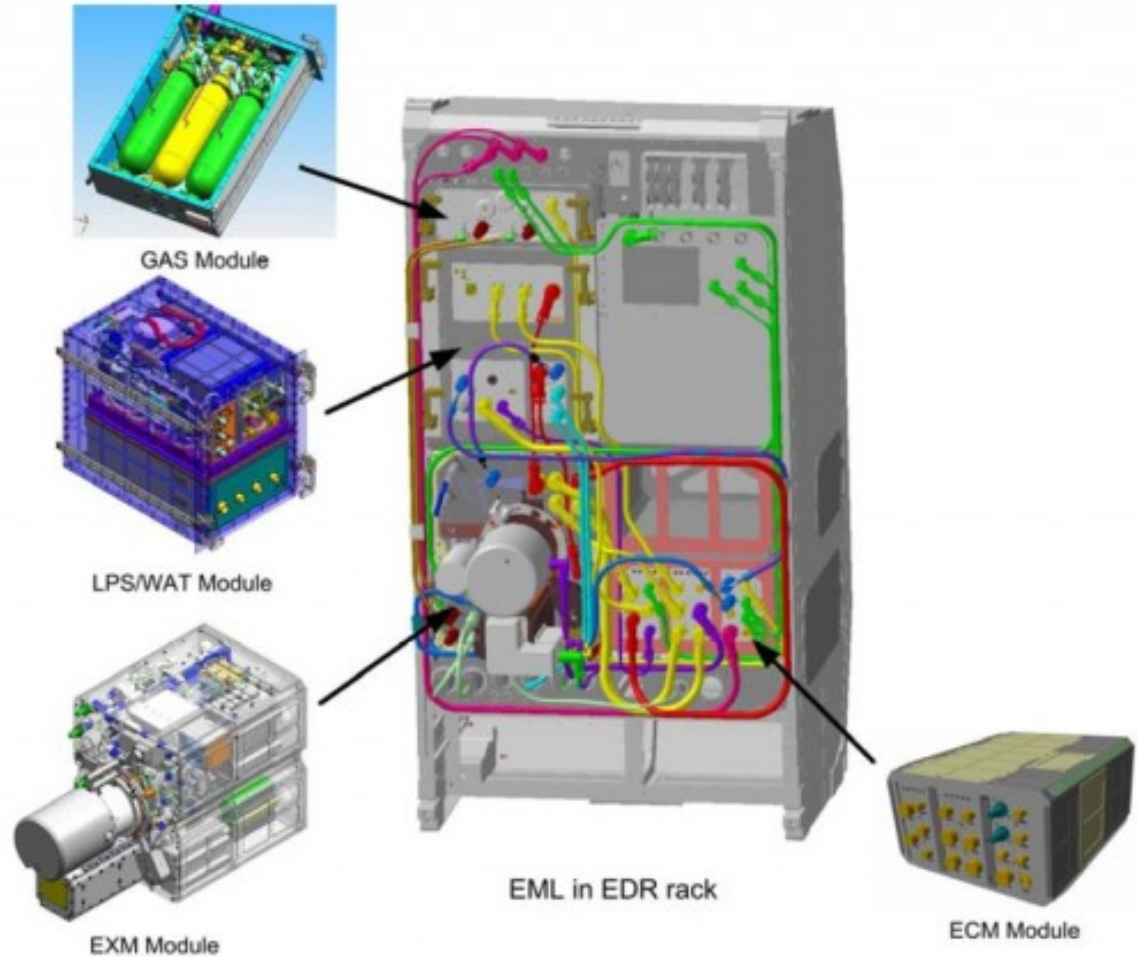



Materials Science Facilities on the ISS: Low Gradient Furnace (LGF) & Solidification Quench Furnace (SQF)



LGF and SQF Status

- LGF and SQF are furnaces on orbit that operate in the Materials Science Research Rack (MSRR)
- Sample Cartridge Assemblies (SCA)'s for both furnaces have been developed and flown by ESA
- NASA is currently developing SCA's for these furnaces

Experiment Samples and Crucibles

- PI provided
- Samples and crucible for processing

Sample Cartridge Assembly (SCA)

- Houses and provides containment for sample and crucible set
- Instrumentation sensors for monitoring temperature and cartridge integrity
- Loaded into the insert by flight crew
- Sealed to provide one level of containment

ESA's Furnace Module Insert

- Insert designed to accommodate investigation-unique processing requirements
- Replaceable on-orbit
- Provides for "Automatic" processing
- Vacuum operations

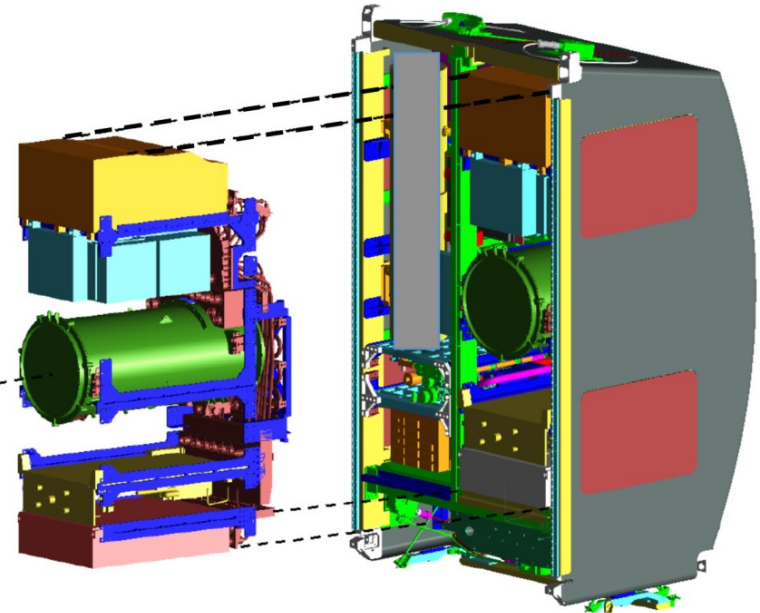

Materials Science Laboratory Experiment Module Accommodates ESA Module Insert

- ESA Provides:
- Core Facility
 - Power Supply
 - Avionics/Control System
 - Gas/Vacuum Distribution
 - Sub-system
 - Data Electronics
 - Water Pump
 - Package
 - Gas Supply

MSRR-1

- NASA provides Rack and Subsystems
- NASA integrates the Rack with Payload Experiment Hardware



MSL Facility Overview



- The Materials Science Laboratory (MSL) is a multi-user facility for high temperature research in the area of materials science. At present, main mode of operation is directional solidification of alloys and semiconductors; however MSL also supports crystal growth by zone melting or measurement of diffusion coefficients (stationary temperature profiles).
- MSL is integrated as an „Experiment Module“ in the right side of the NASA Materials Science Research Rack (MSRR-1).
- MSL was built by a European industrial consortium under ESA contract.
- MSRR-1 was launched in August 2009 and accommodated inside the US Laboratory Destiny.
- Two MSL Furnace Inserts are currently available:
 - o Low Gradient Furnace (LGF)
 - o Solidification and Quenching Furnace (SQF)



MSL Design Concept



- The Materials Science Laboratory design reflects the operational constraints of the ISS, in particular the limited up/download capabilities.
- In order to allow for a maximum of science return while consuming a minimum of transportation resources, the MSL design supports
 - o on-orbit exchangeable Furnace Inserts, providing optimized processing conditions for various experiment types (current facility configuration supports resistance heated Furnace Inserts with up to 8 individually controlled heaters.)
 - o a series of built-in diagnostics and stimuli
 - o upon request installation of experiment dedicated diagnostics and stimuli
 - o on-board maintenance and repair capability (optimized with respect to crew time and mass upload)



MSL Integrated in MSRR-1

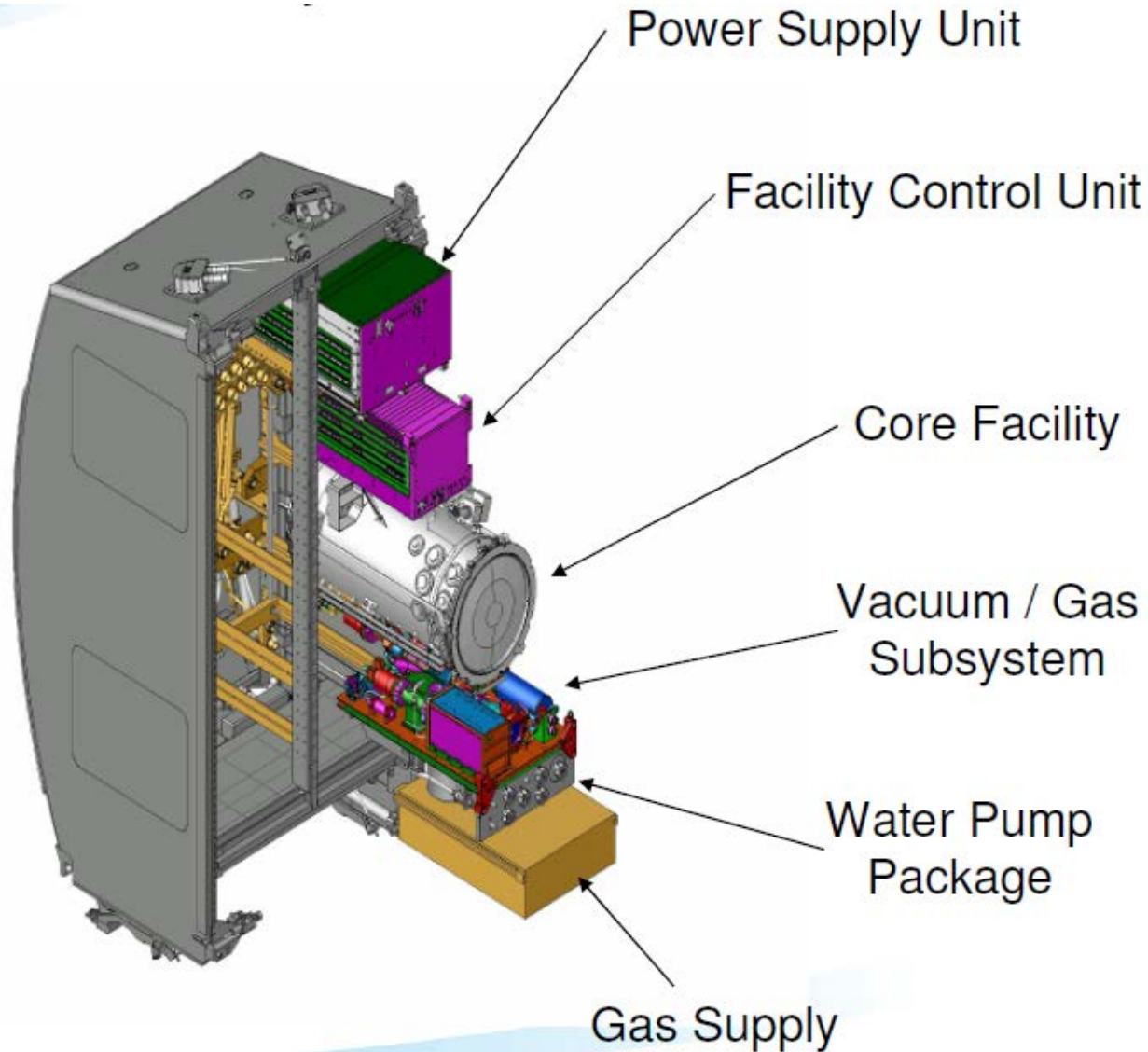

Photo of Flight Model at Marshall Space Flight Center





MSL Facility Components





MSL Core facility



- Stainless steel process chamber, access to chamber interior after opening of front lid
- process atmosphere: vacuum ($< 10^{-3}$ mbar) [or up to 300 mbar Argon]
- Furnace Inserts are installed sequentially by the flight crew.
- One Sample Cartridge Assembly (SCA) processed at a time.
- Furnace drive moves Furnace Insert along the SCA axis while SCA itself is kept stationary.
- Drive designed for two operational modes:
 - o low speed, stable displacement rates in a range of 10^{-5} to 0.2 mm/sec
 - speed variation is within $\pm 1.5\%$ of setpoint.
 - maximum displacement step of the processing drive $\sim 0.1 \mu\text{m}$.
 - o rapid furnace displacement (up to 130 mm/sec) for quenching



MSL Low Gradient Furnace (LGF)



- LGF is a Bridgman furnace that supports directional solidification of metals and growth of semiconductors at gradients in a typical range < 40 K/cm. (Isothermal temperature profiles can be established as well.)
- LGF consists of a "cold" and a "hot" cavity separated by an adiabatic zone
- Directional solidification experiments: planar solid / liquid interface established in center of adiabatic zone
- Gradient can be adjusted (within limits) by temperature of the two cavities (plus additional temperature variation of the two heater zones close to the adiabatic zone)
- Temperature of each heated zone can be controlled with any of 2 redundant WRe-thermocouples located inside the corresponding diffuser
- Inner diameter of cavities: 30 mm



MSL Low Gradient Furnace (LGF)



- Vacuum operation
- Maximum furnace displacement: 150 mm
- Maximum zone temperature: 1400 °C at the level of the diffusers.
- Minimum controllable zone temperature: 500 °C
- Carbon reinforced carbon diffusers provide for enhanced circumferential temperature uniformity
- Rotating magnetic field with maximum field strength at "hot" side of adiabatic zone





LGF Cross Section

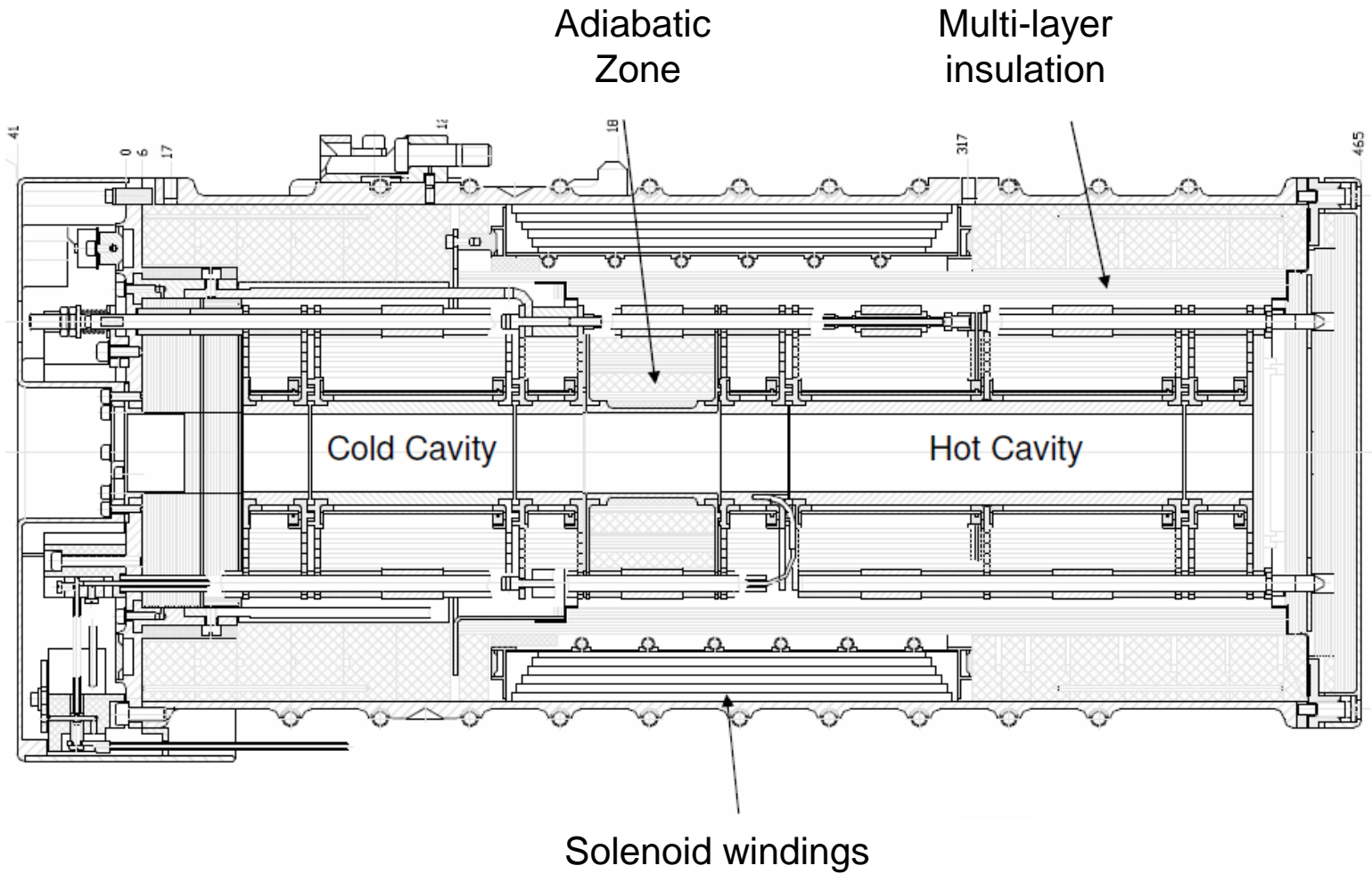



LGF Thermal Profile: Example for Al 7wt% Si

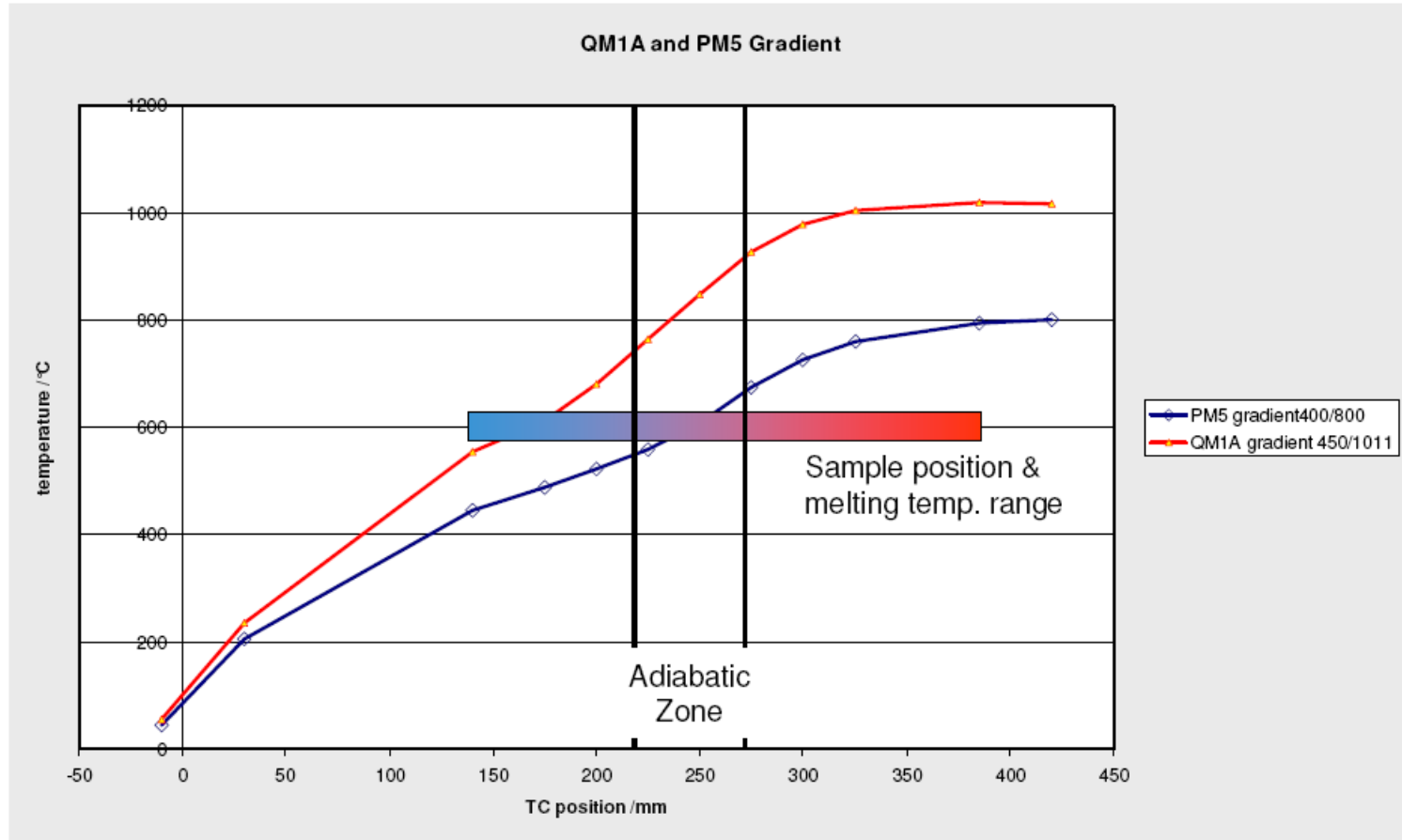



Solidification and Quenching Furnace (SQF)



- SQF is a Bridgman furnace consisting of one **hot cavity**, a water cooled chill block (**cooling zone**) acting as heat sink and an **adiabatic zone**.
(The adiabatic zone is attached to the heat sink and could be replaced on orbit).
 - Heat transfer between the cooling zone and SCA is performed by
 - o Radiation *or*
 - o a liquid metal ring (LMR) assembly that is part of the SCA but will be mechanically attached to the heat sink and moves with the SQF during translation.
 - SQF supports
 - o directional solidification of alloys at gradients in a typical range of 50 - 150 K/cm (*depending on Adiabatic Zone length, SCA design, and applied temperature range*) – SCA equipped with LMR, see below. *)
 - o directional solidification of alloys at gradients in a typical range of 20 - 30 K/cm – SCA not equipped with LMR. *)
 - o isothermal temperature profiles (inside the hot cavity)
- *) *Sample length of 254mm allows for solidification of ~ 100 mm at stable temperature gradient + furnace displacement during quenching*



Solidification and Quenching Furnace (SQF)



- Dimensions of Adiabatic Zone:
 - 50 mm length
 - 20 mm inner diameter (limits cartridge tube envelope to $\text{Ø}16.0\text{mm} + 0.5 \text{ mm}$)
- Temperature of each heated zone can be controlled with any of 3 redundant WRe-thermocouples located inside the corresponding diffuser
- Maximum zone temperature: 1400 °C at the level of the diffusers.
- Carbon reinforced carbon diffusers provide for enhanced circumferential temperature uniformity
- At the end of processing the specimen can be quenched by a rapid displacement of the furnace insert that positions the chill block over the molten portion of the specimen.
- Vacuum operation
- Maximum furnace displacement 150 mm
- Rotating magnetic field with maximum field strength at "hot" side of adiabatic zone



Solidification and Quenching Furnace (SQF)

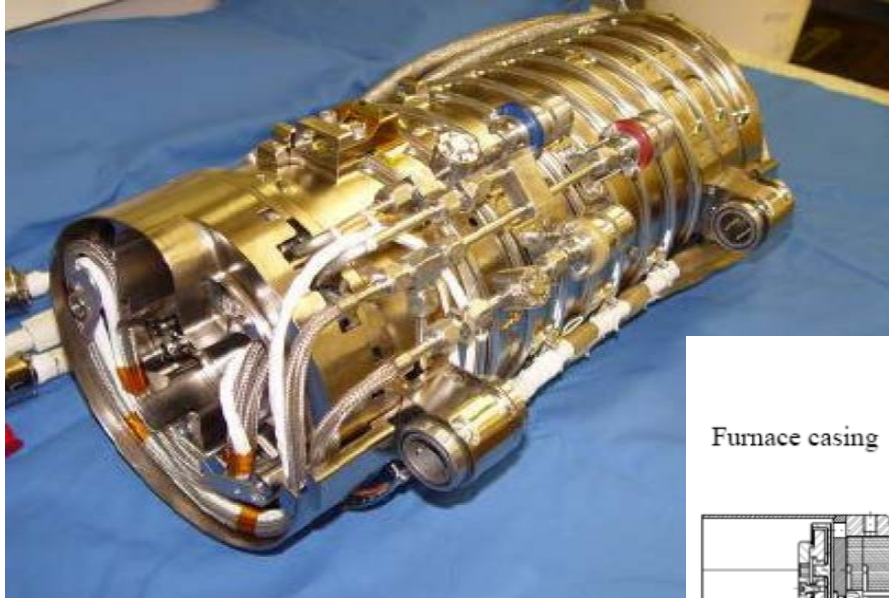

SQF Cross Section

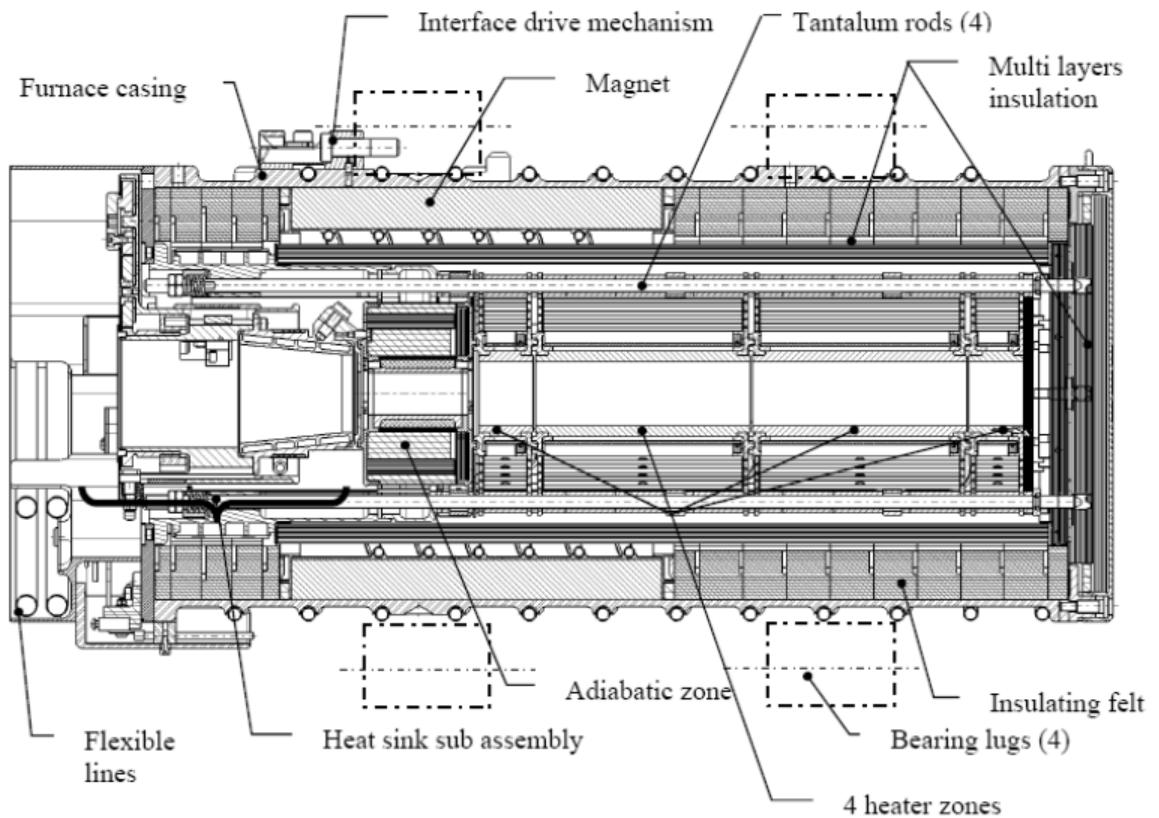



SQF Thermal Profile inside SCA

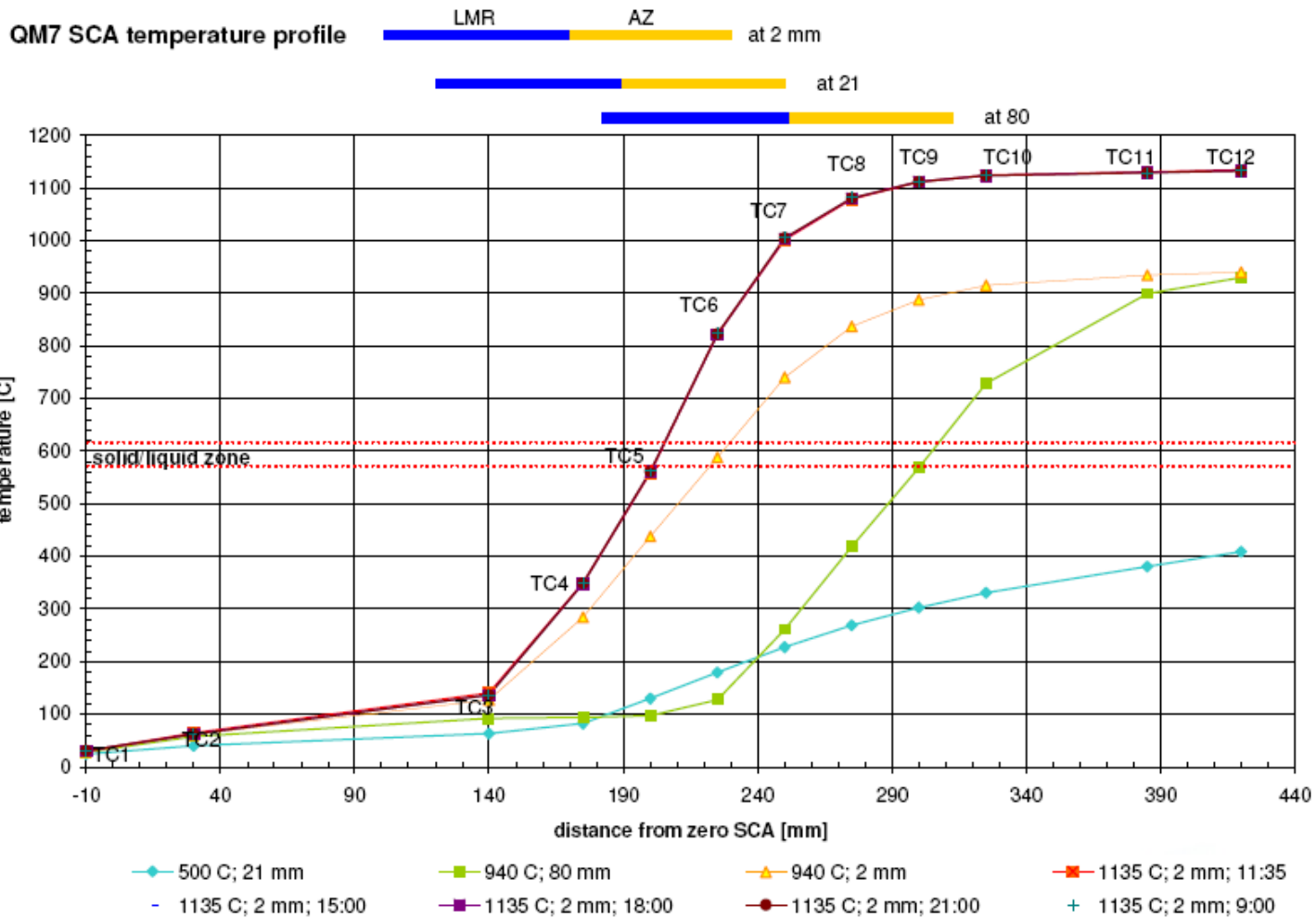



LGF and SQF Thermal Details



- Furnace temperature control range: 500 – 1400 °C
- Maximum heat-up rate: 10 K/min
- Furnace temperature stability:
 - about ± 0.05 K at $T < 1200$ °C
 - about ± 0.1 K at $T < 1400$ °C
- Temperature uniformity along the circumference of each heater zone: variation of up to ± 0.5 K
- Axial temperature uniformity of the plateau heaters (isothermal operation): better than ± 0.5 K over full length, with the exception of 10 mm at each end
- T/C electronics resolution: 16 bit
- T/C electronics accuracy: ± 30 μ V
- T/C Accuracy: 1% of temperature (batch verification)
- SQF cooling zone control range: 40 – 80 °C
- Control stability: ± 0.5 K



LGF and SQF SCA Maximum Dimensions



- SCA head maximum envelope
 - 98 mm length
 - 70 mm diameter (except diameter at mounting I/F)
 - plus volume for electrical connector and microswitch as per ICD
 - Exceptions may be agreed if compliant with MSL design and ops constraints
- Maximum tube envelope
 - Length: 470 mm
 - Diameter for LGF SCA: 26 mm + 0.5 mm
 - Diameter for SQF SCA: 16 mm + 0.5 mm



Diagnostics and Stimuli for Experiments



- Temperature monitoring for 12 thermocouples (inside SCA)
- Independent heating and temperature control of an internal reservoir (in order to control the vapor pressure of volatile elements in compound semiconductors [GaAs, CdTe]).
- Rotating Magnetic Field (RMF) with maximum field strength at "hot" side of adiabatic zone (LGF and SQF)
 - Frequency range: DC or 5 – 400 Hz in 1 Hz intervals
 - magnetic flux density: ~ 4.1 mT at 100 Hz, ~ 1.5 mT at 400 Hz
- Interface for SCA internal pressure sensor
- Stepper motor interface (e.g. shear cell actuation for diffusion experiments)
- Ultrasound diagnostics for determination of the solid/liquid interface position (transducer package to be provided as part of the sample)
- Video interface (NTSC) provided by MSRR-1
- Current Pulses
- HW Safety Inhibit interface to SCA
- 3-axes accelerometer at Core Facility
 - measurement range 10^{-6} - 10^{-3} g
 - acquisition frequency 100 Hz



The Project Lifecycle of a Materials Science Investigation on the ISS

Example: SUBSA (Solidification Using a Baffle in Sealed Ampoules)
PI: Prof. Aleksander Ostrogorsky, Illinois Institute of Technology



SUBSA Science Overview



Objectives - The objective of the SUBSA investigation is to test the performance of an automatically moving baffle in microgravity and to determine the behavior and possible advantages of liquid encapsulation in microgravity conditions. The baffle is used during directional solidification to minimize the natural convection in the melt. The baffle reduces significantly the maximum temperature difference and the characteristic size of the melt. In space, the baffle will reduce convection driven by residual acceleration, which is particularly harmful when acting normally to the axis of the ampoule (horizontal Bridgman growth). This will be investigated by growing Indium Antimonide (InSb) because of its low melting point and previous experience with this material. In addition, InSb is a good model material for the planned flight experiment.

Success Criteria

- 1. Observation (video recording) of the melting and resolidification process (including motion of the baffle)*
- 2. Demonstrating that the baffle has a measurable effect on crystal composition*
- 3. Baffle moves as planned in all ampoules which contain the baffle
- 4. The baffle reduces sensitivity to residual micro-acceleration in two systems
- 5. Steady State diffusion controlled growth and reproducibility demonstrated in all experiments with the baffle
- 6. Demonstrating that liquid encapsulation is useful in space

*Minimum success criteria

Glovebox Investigator:

Dr. Aleksandar Ostrogorsky



SUBSA Schedule



- Dec. 3, 1997 Selected by the NASA Glovebox Investigation Panel and assigned to the Glovebox Program Office at MSFC
- June 5, 2002 SUBSA launched onboard STS-111/UF-2
- July 10 – Sep. 11, 2002 Processed 8 samples during ISS Expedition 5 Increment
- Dec. 7, 2002 SUBSA Samples returned to earth on STS-113
- Jan. 13, 2003 Computed Tomography scans on SUBSA samples. Samples returned to GI
-
- April – June, 2003 Ground experiments corresponding to flight experiments
- April, 2003 - Characterization of flight and ground samples and analysis of data. Sample electrical measurements at MSFC.
- Jan., 2004 One Year Report; Final Experiment Data Management Plan (EDMP)

Deliverables

Flight Ampoules, Ground Ampoules, Final Reports



Directional Solidification With A Baffle

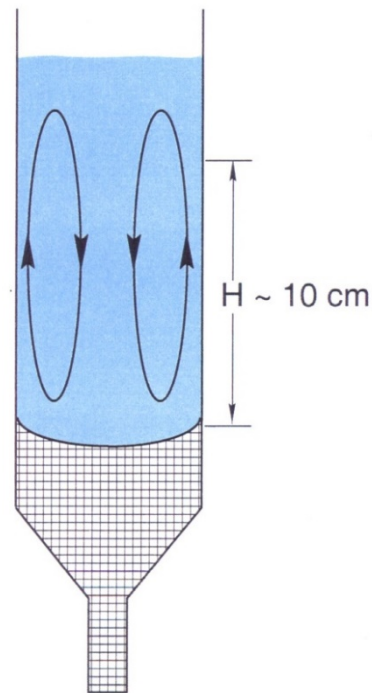

- $H(t) \sim 10 \text{ cm}$
- large dT/dr
- free surface

$$Gr = \frac{g \cdot \beta \cdot \Delta T \cdot H^3}{\nu^2}$$

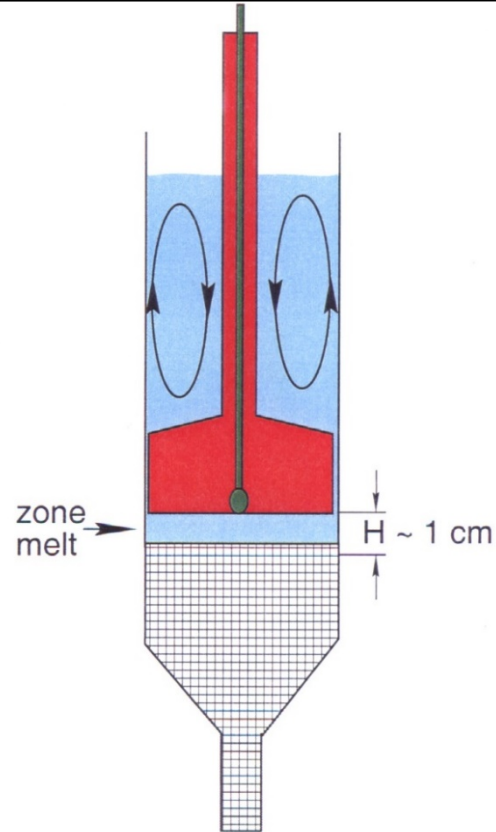

- $H \sim 1 \text{ cm}$
- low dT/dr
- no free surface
- forced convection

$$F_{\text{buoyancy}} \sim g \cdot \Delta T \cdot H^3$$

Reducing ΔT and H^3 has *the same effect* as reducing g



Advantages of a Baffle



- Established advantages of using a baffle at 1g
 - small melt zone size; L^3 is reduced, ΔT is reduced
 - no Marangoni convection
- In space, melt velocities will be low because of
 - (i) microgravity - Grashof number is reduced by $\sim 10^6$
 - (ii) small melt size - Grashof number is reduced by $\sim 10^3$

Total reduction $\sim 10^9$



Baffle Driven by Expansion During Freezing



- Baffle is attached to a piston covering the top surface of the melt
- During freezing, the melt is pushing on the piston

$$\frac{A_{piston}}{A_{baffle}} = \frac{\rho_l - \rho_s}{\rho_s} = \dots$$

| |
|-------------|
| 8.2 % GaSb |
| 12.7 % InSb |
| 8.1 % Si |
| 3.6 % Ge |

- Without active control, the distance between the baffle and crystal remains constant

T. Duffar, A. G. Ostrogorsky, "Dispositif de cristallogenese avec un Piston deplace par le liquide (Setup for crystal growth with a piston moved by liquid)", [Patent application #97-04347, France, April 1997](#)

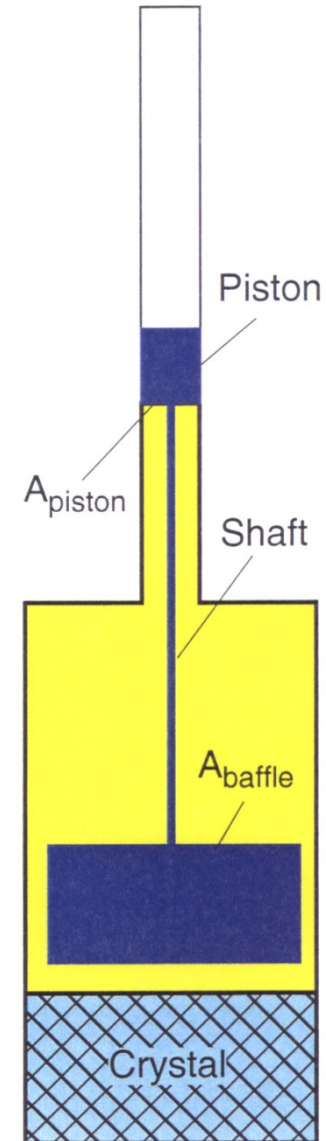



Liquid Encapsulation

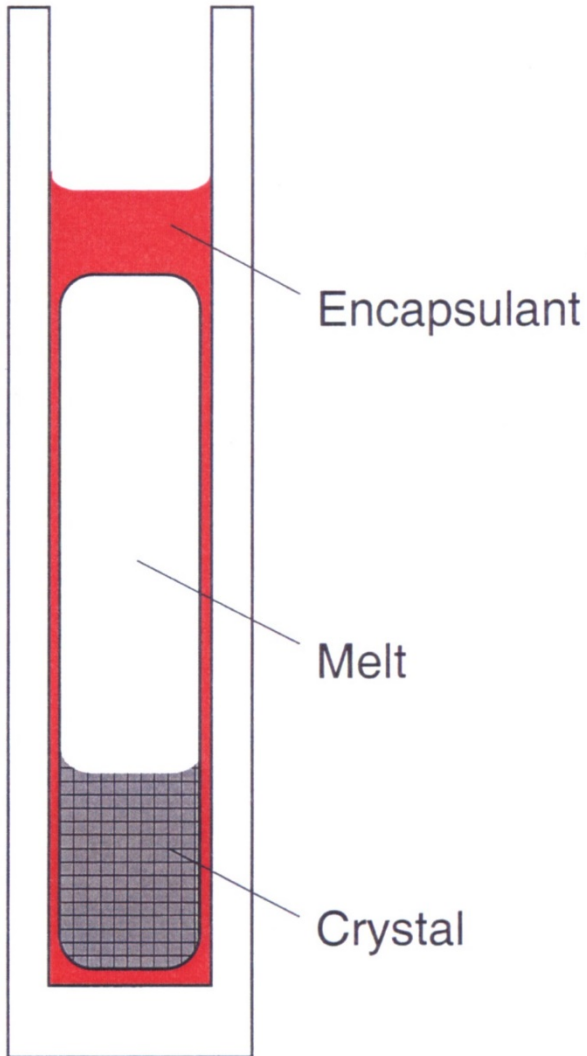

Prevents contact between the crystal and the melt

Advantages of Encapsulation

- Nucleation of grains is reduced
- Thermal stresses are reduced
- Evaporation is reduced

Encapsulents for InSb

- LiCl-KCl
- B_2O_3 - Na_3AlF_6

Properties of a good encapsulent

- Melting temperature lower than the crystal
- Low vapor pressure
- Density lower than the density of the melt
- No reaction with the melt or crucible



SUBSA Ampoule Assembly



- InSb seed
- 50g InSb, doped with Te or Zn (MP 512 C)
- Sealed under vacuum.

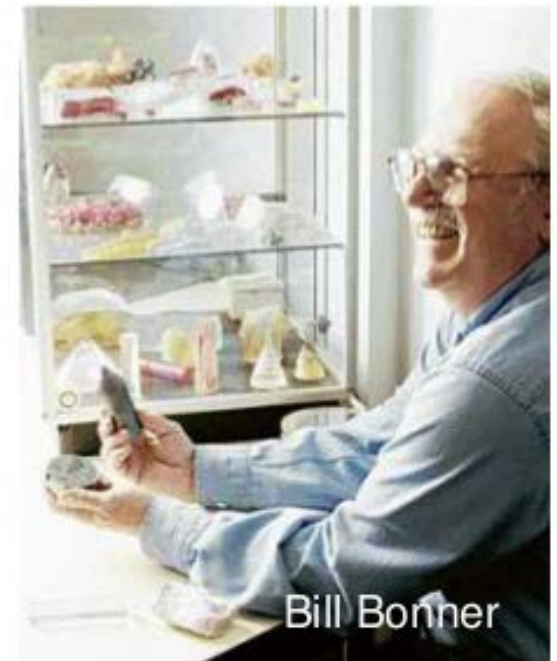



SUBSA Hardware At A Glance



Cartridge head and 4 TCs



LabVIEW 6i processes data on MSG Laptop Computer



It's a Boy!!
Born May 8, 2001 at 10:35 p.m.
Weight: 14 lbs, 9 oz; Length: 15 inches



1 DaqPad



1 Process Control



Video Camera



SUBSA Design Review



Riddable documents required for a hardware review of the original SUBSA glovebox investigation

- Engineering Testing and Certification
- Safety Testing and Certification





SUBSA Installed in MSG



PHOTO OF FLIGHT SUBSA SYSTEM IN MSG GROUND UNIT.
PHOTO TAKEN NOVEMBER 13, 2001

FLIGHT Hardware

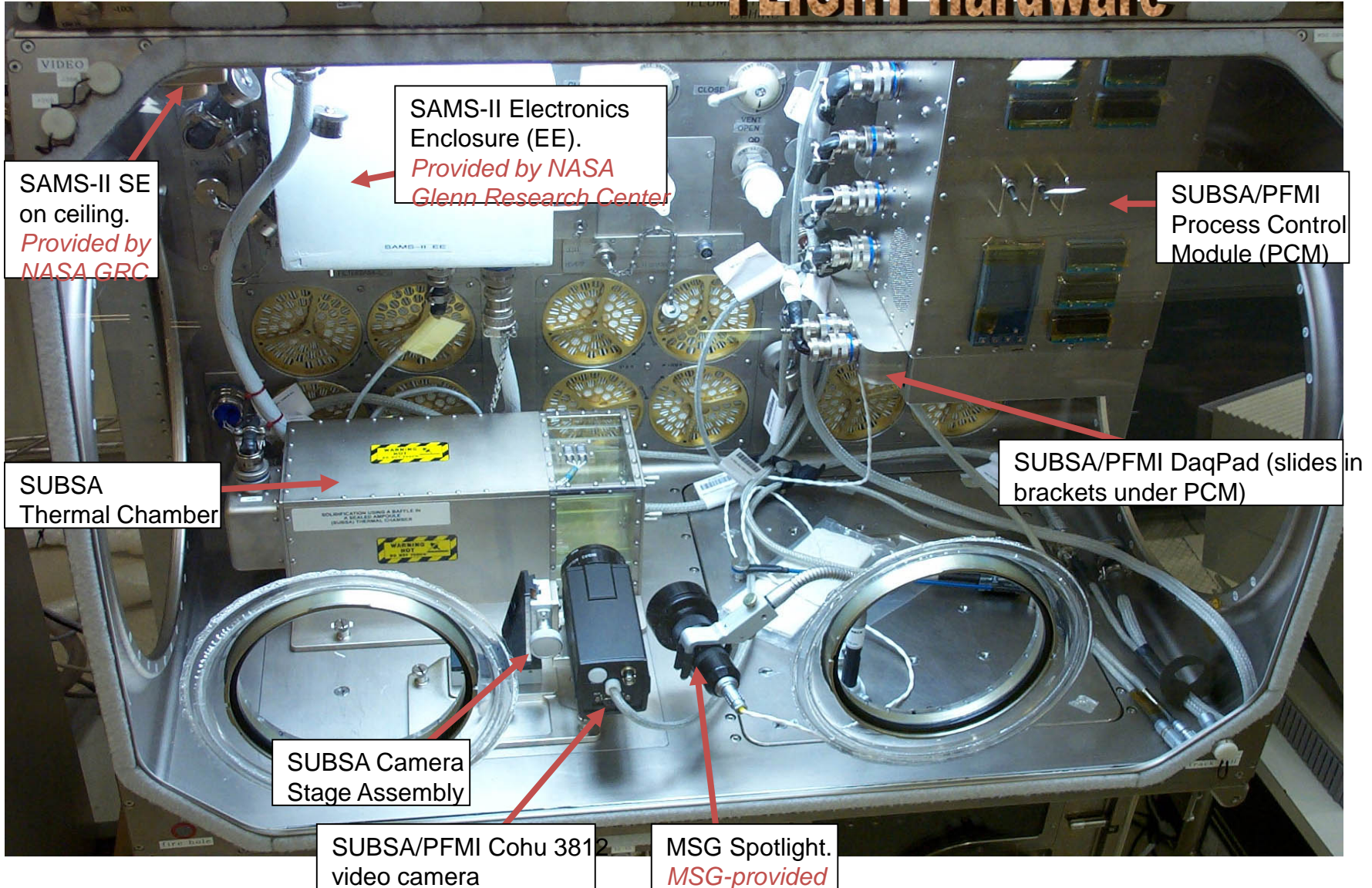



SUBSA ISS Operations

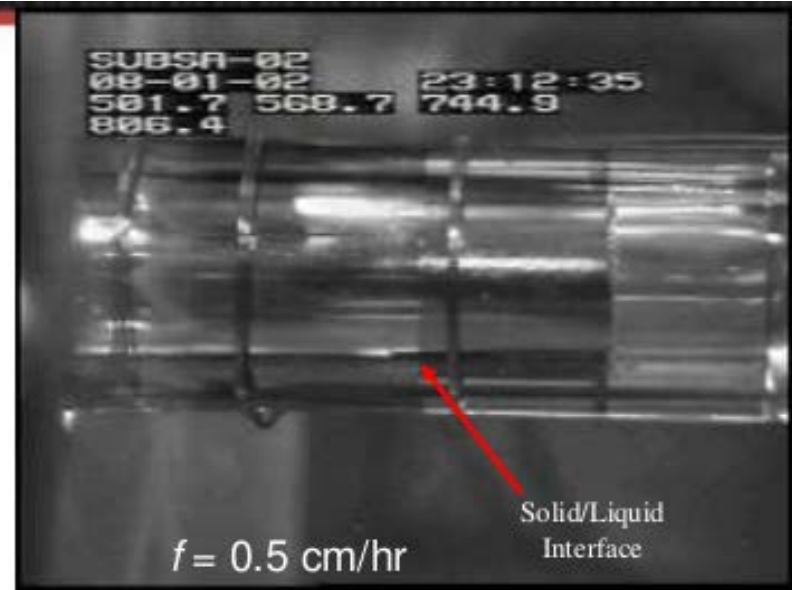
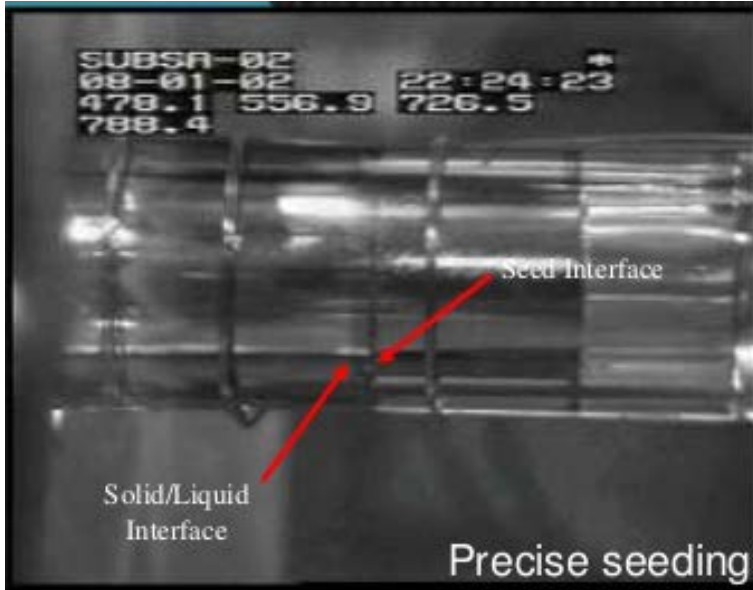



Gallium Distribution in Germanium Crystals Grown in Space and on Earth



Diffusion Controlled Growth

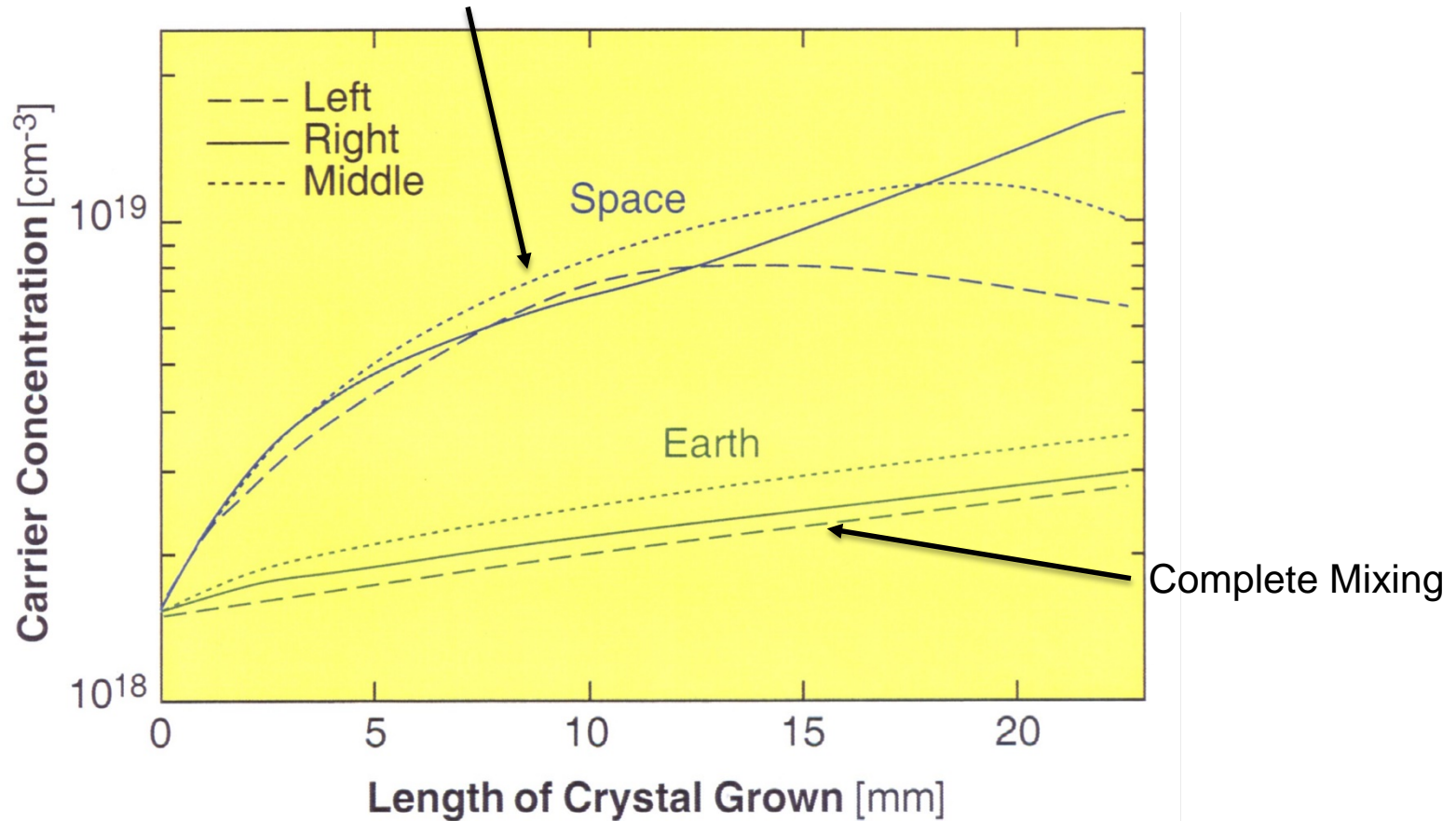

Witt et al., J. Electrochem. Soc. 125 (1978) 1832.



Results for SUBSA #10: Zinc-doped



SUBSA 10: Zn-doped; with baffle

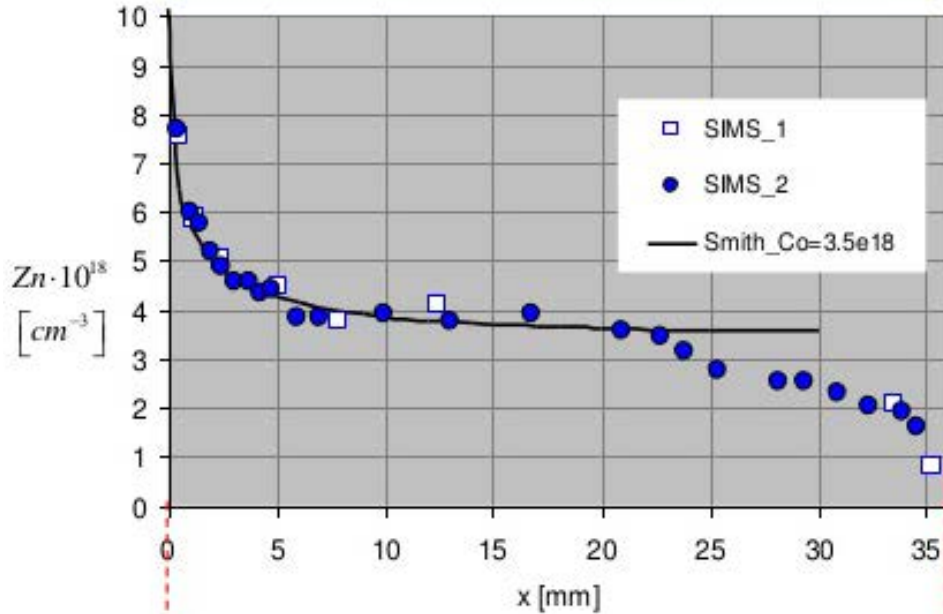

Zn-doped => $k_0=2.9$

$k_0 > 1$ is proffered for growth in microgravity.

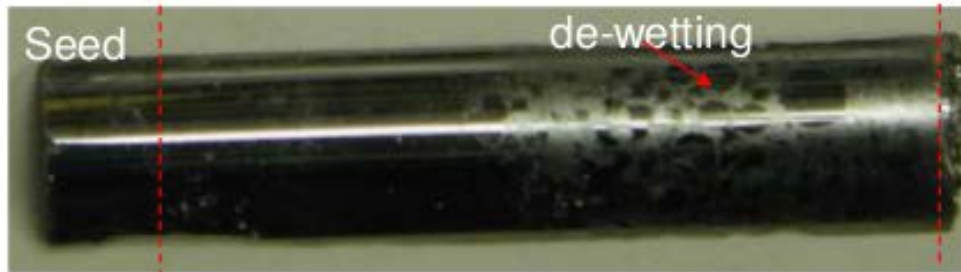

$$D = 1.2 \times 10^{-4} \text{ cm}^2/\text{s}$$



ISS Materials Program Current Status



- The microgravity materials science program investigators are developing experiments to be performed on ISS in the following facilities:
 - DECLIC (1 investigator)
 - Electro-Magnetic Levitator (3 investigators)
 - Electrostatic Levitator (ELF) (4 investigators)
 - SUBSA Furnace in MSG (5 investigators)
 - Materials Science Research Rack (4 investigators)
- Other investigators are performing calculations or modeling in support of flight investigations
- Other investigations concern Exploration (cement experiment) and biological physics (protein crystal growth and biofilms)
- ISS operations expected through at least 2024.



Backup





SUBSA/CASIS, Cs₂LiYCl₆:Ce (CLYC), Churilov



PI: Dr. Alexei Churilov, Radiation Monitoring Devices, Inc.
Co-I: Mr. Joshua Tower, Radiation Monitoring Devices, Inc.
Co-I: Dr. Martin Volz, NASA MSFC-SLPS funded
Co-I: Prof. Aleksander Ostrogorsky, Illinois Institute of Technology
PM: Donnie McCaghren, NASA, MSFC

Objective:

To utilize the microgravity conditions on the ISS to eliminate, reduce, or isolate the process parameters related to gravity towards the production of high quality crystals of Cs₂LiYCl₆:Ce (CLYC). Efforts include ground-based testing with SUBSA furnace, ampoule development, characterization of ground and flight samples, and aligning the investigation within the scope of the MaterialsLab initiative.

Benefits:

- Cs₂LiYCl₆:Ce (CLYC) is a unique new scintillator crystal which has tremendous potential in nuclear and radiological detection applications.
- CLYC combines detection of gamma-rays and neutrons in a single sensor, while providing effective identification of each.
- This feature makes CLYC a very attractive detector in homeland security and nuclear non-proliferation applications, as well as in oil and gas exploration, particle and space physics, non-destructive testing, and scientific instruments.

Partnering/Collaboration:

CASIS
Illinois Institute of Technology
NASA MSFC

Instrumentation & Experiment Summary

A series of crystal growth experiments of the scintillator crystal material Cs₂LiYCl₆:Ce will be conducted in the Solidification Using Baffles in Sealed Ampoules (SUBSA) furnace in the Microgravity Science Glovebox (MSG) on the ISS. The SUBSA furnace and associated hardware were previously used on the ISS and are now undergoing a refurbishment/recertification process.

Power spectral density plot showing the separation between gamma rays and both thermal and fast neutrons for a 2" diameter CLYC crystal produced at Radiation Monitoring Devices. This characteristic enables detection of both gamma-rays and neutrons in a single sensor.

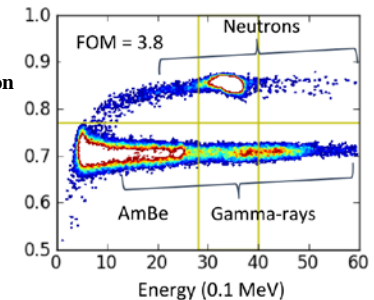

Accomplishments:

- Flight ampoules launched on OA-7 Cygnus mission to ISS on April 18, 2017
- Processing no earlier than September 2017
- Panel Member: "Research Enabling LEO Commercialization", Alexei Churilov, American Society for Gravitational Research Annual Meeting, Cleveland, Ohio, October 26-29, (2016).



SUBSA/CASIS, Indium Iodide, Ostrogorsky



Sponsor: CASIS & SLPSRA

PI: Prof. Aleksander Ostrogorsky, Illinois Institute of Technology

Co-I: Dr. Martin P. Volz, NASA, MSFC-SLPS funded

Co-I: Dr. Lodewijk van den Berg, STS Payload Specialist

Co-I: Prof. Arne Cröll, Freiburg University, Germany

Co-I: Dr. Alexei Churilov, Radiation Monitoring Devices, Inc.

PM: Donnie McCaghren, NASA, MSFC

Objective:

To utilize the microgravity conditions on the ISS to eliminate, reduce, or isolate the process parameters related to gravity towards the production of high quality crystals of InI. Efforts include use ground-based testing with SUBSA furnace, ampoule development, characterization of ground and flight samples, and aligning the investigation within the scope of the MaterialsLab initiative.

Benefits:

- InI shows great promise as an advanced material for nuclear radiation detection at room temperature.
- Advantages over current materials include larger energy gap (less leakage current), non-toxic, non-hygroscopic, low melting point, and no compositional segregation during growth from the melt.
- InI can be used at elevated temperatures, increasing the number of potential industrial applications.

Partnering/Collaboration:

CASIS

Radiation Monitoring Devices

Freiburg University, Germany

NASA MSFC

Instrumentation and Experiment Summary

The objective is to utilize the microgravity conditions on the ISS to study defect generation in InI crystals grown by both melt and vapor growth techniques. Specific goals include:

- Determine processing parameters to minimize defects
- Determine nature of defects
- Produce reference quality InI
- Compare detector

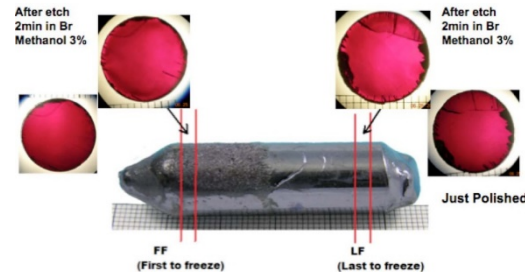

InI single crystal grown by the vertical Bridgman process and sections used for device fabrication

Accomplishments:

- Prepared and delivered all ampoules for flight
- Flight ampoules launched on OA-7 Cygnus mission to ISS on April 18, 2017
- Processing no earlier than September 2017
- Conducted several ground-based experiments at Tec-Masters and at MSFC for optimization of processing parameters
- Publication: "Wetting angles of monovalent indium iodide on different substrates", A. Cröll, J. Markert, M. P. Volz and A. Ostrogorsky, Crystal Research and Technology 52, 1600179 (2017).



SUBSA, CETSOL, Beckermann



Principal Investigator: Prof. Christoph Beckermann,
Univ. Iowa

Project Scientist: Ellen Rabenberg, NASA MSFC

Program Manager: Shawn Reagan, NASA MSFC

Engineering Team: TBD

Objective:

- Study columnar-to-equiaxed grain structure transition and effect of convection in alloys by using directional solidification with and without grain refiner, multi-scale and phase-field computer simulations.
- Efforts include collaboration with the **CETSOL** team using the transparent alloys device.
- Visual data on the solidification front of an organic system is obtained during the experiments in order to validate models of solidification.
- The columnar-to-equiaxed transition is of particular interest to the **CETSOL** team. The CETSOL-1 transparent alloys experiments will be focused on the transition at constant thermal gradient. CETSOL-2 focuses on studies with the sample cooled by radiation and thermal diffusion.

Benefits:

- Grain structure is important for all metal castings and affects defect formation and properties.
- Gravity has a large effect on the grain structure.

Team/Partnering/Collaboration

- ESA CETSOL team

Instrumentation & Experiment Summary

- Ground based work: Will be performed at MSFC under direction of Dr. Beckermann
- Flight experiments: On International Space Station (2020)
- ISS requirements: Low-gradient furnace (LGF) on Materials Science Research Rack (**MSRR**) or **SUBSA** in the Microgravity Glovebox

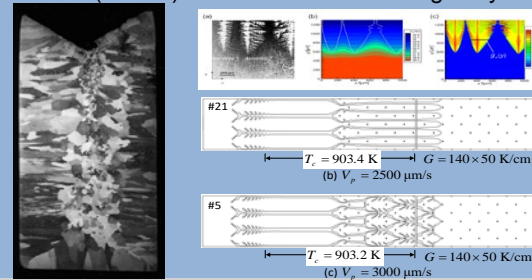

Accomplishments

Experimental Studies

- Attended two –day CETSOL meeting in Germany where progress discussed in detail.
- Cartridge assembled for SUBSA test of Aluminum-7 wt% Silicon. Sent to vendor for testing

Selected Publications

Beckermann, C., Neumann-Heyme, H., and Eckert, K., "Evolution of the Specific Solid-Liquid Interface Area in Directional Solidification," in *Frontiers in Solidification: TMS MPMD Symposium in Honor of Michel Rappaz*, eds. W. Kurz, J. Dantzig, A. Karma, J. Hoyt, EPFL Materials Science, Lausanne, Switzerland, 2016, pp. 53-57.

Založnik, M., Souhar, Y., Beckermann, C., and Combeau, H., "Upscaling from Mesoscopic to Macroscopic Solidification Models by Volume Averaging," in *Frontiers in Solidification: TMS MPMD Symposium in Honor of Michel Rappaz*, eds. W. Kurz, J. Dantzig, A. Karma, J. Hoyt, EPFL Materials Science, Lausanne, Switzerland, 2016, pp. 59-63.



SUBSA, Brazing Reference Experiment, Sekulic



Principal Investigator: Prof. Dusan Sekulic, University of Kentucky
Project Scientist: Dr. Richard Grugel, NASA MSFC
Program Manager: Donnie McCaghren, NASA MSFC
Engineering Team: MSFC

Objective:

- Improve processing based on inferior joints observed in previous microgravity experiments.
- Identify optimal materials and refine the process for joining hard metals in μG .
- Better understand processing kinetics (enhanced wetting, spreading, capillarity) in a low-gravity environments.

Benefits:

- A method for in situ repair of micrometeorite damage is highly desirable.
- Construction in space/on Mars will be necessary. Brazing can effectively join similar and dissimilar materials.
- Computational and theoretical modeling will promote our understanding of brazing science

Team/Partnering/Collaboration

- Udmurt State Univ. Russia, KU Leuven Belgium, Washington State.

Vertical coupon assembly for attempt to visualize surface melting/dynamics



Cut piece of alumina tubing showing sample and thermocouple placement. (Less cement, different design, larger samples, can obviously be implemented.)

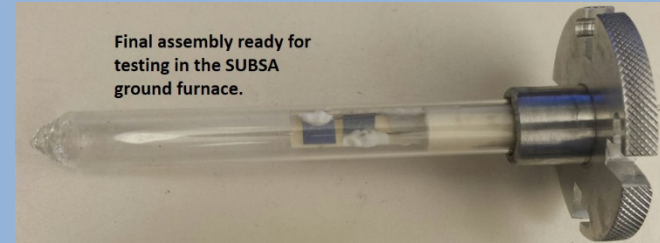

Final assembly ready for testing in the SUBSA ground furnace.

Accomplishments

- Grant is in place.
- Dialogue with the PI regarding the science, experimental procedure, and programmatic issues has been on-going.
- SCR preparations in process
- Considerable experimental development and testing with the SUBSA ground unit and mock samples is being conducted, see above.



SPADES, Trivedi, DECLIC Facility



Principal Investigator, U.S. Team: Dr. Rohit Trivedi, Iowa State University
Project Scientist, U.S. Team: Dr. Louise Strutzenberg, NASA MSFC
Program Manager, U.S. Team: Donnie McCaghren, NASA MSFC
Collaborating Principal Investigator IM2NP Team: Dr. Nathalie Bergeon, Université Paul Cézanne, Marseille, France
Engineering Team: CNES

Objective:

- Quantitatively establish the fundamental physics controlling the spatiotemporal organization of the secondary sidebranch structure and its interaction with the array structure of primary branches under directional solidification conditions.
- SPADES focuses on the origin of sidebranches that occur when columnar solidification patterns transform from cellular to dendritic as a function of thermal gradient and solidification velocity and studies the potential for the formation of an intermediate multiplet pattern.

Benefits:

- The sidebranch instability under investigation is crucial for dendritic growth and for determining the solute segregation pattern in the “mushy” zone that largely governs the properties of cast alloys.
- Development of rigorous dynamic models of microstructure formation provides insight enabling the development of advanced materials of commercial importance.
- This investigation also provides an opportunity to gain an insight into the general problem of pattern formation, as solidification patterns are recognized to be similar to those forming in many other branches of science.

Team/Partnering/Collaboration

- Northeastern University, IM2NP Université Paul Cézanne, CNES

Instrumentation & Experiment Summary

The SPADES is accommodated within the CNES-provided Directional Solidification Insert (DSI) that operates within the DECLIC Facility.

DSI has been loaded with a new sample material and is designated DSI-R.

The sample material for DSI-R is succinonitrile (SCN) – 0.5 wt% camphor

The transparent sample can be solidified multiple times with varying velocities and thermal gradients. Resulting interface pattern formation is observed in real-time and captured by interferometry and optical video microscopy.

DECLIC - Dispositif pour l'Etude de la Croissance et des Liquide Critiques

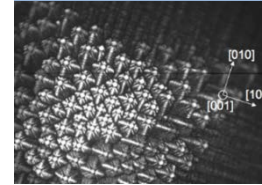

Coherent sidebranching observed in DSI with SCN-0.24 wt% camphor alloy

$V = 30 \mu\text{m/s}$ and $G = 12 \text{ }^\circ\text{K/cm}$



DSI-R Cartridge during preparation including Succinonitrile-camphor sample material

Accomplishments/Status

Flight Operations Support

- DSI-R scheduled for installation after HTI-R ops are completed.
- HTI-R issues with thermal regulation require troubleshooting. Also during previous sequence, BPL (baseplate) sensor failed which will necessitate launch of new cable before DSI-R can be operated.
- New cable currently manifested for SpaceX CRS-12.
- DSI-R insertion and science operations are expected to commence NET September 2017.
- DSI-R script requirements definition continues.

Ground Experiments and Data Analysis

- Analysis of SCN-0.5 wt% thin sample data underway. ISU summer student to work at MSFC for experiment support.
- Interface energy anisotropy: analysis of SCN-camphor data in work.



THERMOLAB / ICOPROSOL – EML, Kelton



Principal Investigator: Dr. Kenneth Kelton, Washington University in St. Louis

Project Scientist: Michael SanSoucie, NASA MSFC

Program Manager: Donnie McCaghren, NASA MSFC

Engineering Team: ESA

Objective:

- Determine the influence of liquid and solid short-range order on the nucleation barrier.
- Determination the composition dependence of nucleation rate and evaluate a new coupled flux model for nucleation.
- Correlate the nucleation kinetics with the local structure of the liquids.
- Correlate the local structure with containerless measurements of thermophysical properties.

Benefits:

- Needed for advanced computer-based modeling approaches to alloy development.
- Complimentary Beamline ESL studies will allow unprecedented measurements of high-temperature materials phase diagrams and structural properties of high temperature liquids.
- The quasicrystals studied have unique structures holding promise for exciting new alloys, with potential applications as IR detectors, hydrogen batteries, and hard, high temperature, corrosion resistant coatings.
- NIST/MGI or OGA: Thermophysical properties data
- Commercial: European commercial advisory board (THERMOLAB)

Team/Partnering/Collaboration

- UMASS, Tufts University, ESA, DLR

Instrumentation & Experiment Summary

- Utilizes ISS MSL - ESL
- Ground-based support electrostatic levitation at Washington University
- Ground-based scattering studies of levitated liquids are made at the Advanced Photon Source (Argonne National Lab) and the Spallation Neutron Source (Oak Ridge National Lab)

ESA
Electromagnetic
Levigator



nature
materials

Nature Materials, 2017 (submitted and accepted)
“Does the repulsive interatomic potential determine fragility in metallic liquids?”
C.E. Pueblo, M. Sun, K.F. Kelton

Accomplishments

Experimental Studies

- Demonstration- Liquid fragility reflects the nature of the interatomic potential
- New method developed for making a quantitative estimate of the liquid emissivity
- SNS elastic neutron scattering studies on Cu-Zr liquids (April 3-10, 2017) – in support of ISS thermophysical property measurements

Additional Publications

- “Connection of Fragility of Metallic Liquids with Cohesive Energy and High Temperature Structural Evolution,” A. K. Gangopadhyay, C. E. Pueblo, M. L. Johnson, R. Dai, and K. F. Kelton, *Journal of Chemical Physics*, 146, 154506 (2017).
- “Measurements of the Temperature-Dependent Total Hemispherical Emissivity Using an Electrostatic Levitation Facility,” A. K. Gangopadhyay and K. F. Kelton, *International Journal of Thermophysics*, 38, 3 (2017).



THERMOLAB / PARSAC – EML, Matson



Principal Investigator: Dr. Douglas Matson, Tufts University
Project Scientist: Michael SanSoucie, NASA MSFC
Program Manager: Donnie McCaghren, NASA MSFC
Engineering Team: ESA

Objective:

- Investigate the effect of fluid flow on the solidification path of peritectic structural alloys.
- Thermophysical properties of high temperature melts.
- Research the influence of convection on the formation of different microstructure in a wide range of commercial alloys.

Benefits:

- Needed for advanced computer-based modeling approaches to alloy development.
- Control of the solidification path would enable tailoring of the microstructure and properties of metal parts for applications including turbine blade directional solidification and magnetic material component motor fabrication.
- Industrial welding, spray forming and casting operations for a class of soft magnetic materials, which have commercial and aerospace applications.
- This research addresses fundamental issues relating to rapid solidification behavior, metastable phase selection and analysis of the processes governing microstructural evolution.

Team/Partnering/Collaboration

- UMASS, Washington University, ESA, DLR

Instrumentation & Experiment Summary

- Utilizes the Materials Science Laboratory – Electromagnetic Levitator (MSL – EML)
- Ground-based support at MSFC ESL lab

MSL-EML FeCrNi

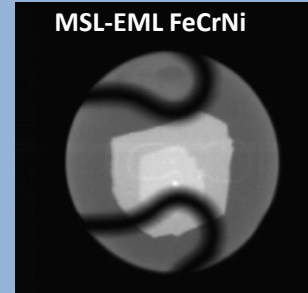

FeCrNi austenitic steel casting alloy deeply undercooled with rapid solidification of primary ferrite and subsequent conversion to secondary austenite.

Accomplishments

Experimental Studies

- Conducted ground-based growth velocity measurement testing to support future CoSi alloy tests on ISS at NASA/MSFC ESL January & March 2017 with Prof. Michael Banish (UAH)
- Performed quantitative metallographic analyses on ESL samples for baseline evaluation of CoSi microstructural evolution study

Publications

- J.E. Rodriguez and D.M. Matson, “Lateral Heat Flux during Remelt Growth into the Mushy-zone”, *Acta Materialia* 129 (2017) pp. 408-414.

Future

- Batch 3 Sample selection complete
 - Fe72Cr16Ni12 & Fe72Cr12Ni16 selected as flown on PF 2016 and STS-94 (**Processed by MSFC ESL Lab, May 2017**)
 - Collaborative shared cycles with FeCo, FeNi, and CoSi
- Special issue for JOM based on TMS 2016 Materials Research in Reduced Gravity Symposium (August 2017)
- IWG#16 28-29 August 2017 Noordwijk
- PF 4-6 September 2017 in Bordeaux FR
- ISPS-7 2-6 October 2017 near Nice FR
- ASGSR Annual Meeting, Seattle, WA, October 25-28, 2017



THERMOLAB/PARSEC/ICOPROSOL – EML, Hyers



Investigator: Dr. Robert Hyers (University of Mass. – Amherst)

Project Manager: Donnie McCaghren, NASA MSFC

Project Scientist: Dr. Paul Craven, NASA MSFC

Engineering Team: ESA

Objective:

- Provide magnetohydrodynamic (MHD) modeling support of macroconvection in various materials for three ESA sponsored projects:
- Supports Peritectic Alloy Rapid Solidification with Electromagnetic Convection (**PARSEC**).
- Supports Thermophysical Properties of Liquid Metallic Alloys – Modeling of Industrial Solidification Processes and Development of Advanced Products (**THERMOLAB – ISS**).
- Supports Thermophysical properties and solidification behavior of undercooled Ti-Zr-Ni liquids showing an icosahedral short-range order (**ICOPROSOL**).

Benefits:

- **PARSEC:** Investigating the effect of fluid flow on the solidification path of certain alloys. Control of the solidification path enables tailoring of the microstructure and properties of metal parts for specific applications.
- **THERMOLAB – ISS:** Investigating the thermophysical properties of high-temperature materials. A better understanding of the physical properties allows more efficient and more reliable production of metallic parts using these alloys.
- **ICOPROSOL:** Investigating the nucleation and growth of quasicrystals, and the effect of atomic-scale order on the macroscopic properties of these alloys. This fundamental investigation may improve our ability to tailor the microstructure of metals for commercial applications.
- Help to advance computer-based modeling approaches to alloy development.

Relevance:

- TA11.2.4: Science Modelling; TA12.1.2.1: Predictive Computational Materials; TA12.1.2.2: Predictive Computational Materials; TA12.1.4.2: High temperature materials.
- NIST/MGI or OGA: Thermophysical properties data

Team/Partnering/Collaboration

- Tufts University, ESA, DLR

Instrumentation & Experiment Summary

- Utilizes the Materials Science Laboratory – Electromagnetic Levitator (MSL – EML)

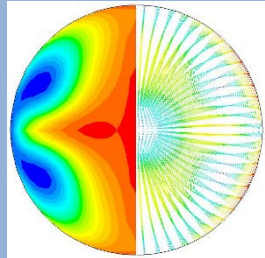

Accomplishments

- Batch 2 Zr sample used for the facility check-out experiment
- After change back to Batch 1 carousel, run Batch 1.3, including the new cycles for anomalous nucleation in Zr
- Measured thermophysical properties of additional compositions of Zr-O

Publications

- J. Zhao, J. Lee, R. Wunderlich, H. Fecht, S. Schneider, M. SanSoucie, J. Rogers, and R.W. Hyers, "Influence of Oxygen on Surface Tension of Zirconium," *Materials Processing Fundamentals*, 2017, pp. 47-54.
- K. Sumaria, R.W. Hyers, and J. Lee, "Oscillation of a Zirconium Droplet – Experiment and Simulations," *Materials Processing Fundamentals*, 2017, pp. 65-72.



EML & ELF Round Robin, Matson



Proposal Team: Douglas Matson (Tufts University), Mikhail Krivilev (Udmurt State University), Vijay Kumar (Tufts University), Masahito Watanabe (Gakushuin University), Takehiko Ishikawa (JAXA), Hiroyuki Fukuyama (Tohoku University), Shumpei Ozawa (Chiba Institute of Technology), Geun Woo Lee (KRISS), Andreas Meyer (DLR), Hans Fecht (University of Ulm), Rainer Wunderlich (University of Ulm), G. Pottlacher (TU-Graz), Kenneth Kroenlein (NIST)

Project Scientist: Michael SanSoucie, NASA MSFC

Program Manager: Karen Stephens, NASA MSFC

Objective: This proposal seeks to address two key scientific questions

1. How do we control and minimize gravity-induced systemic error in thermophysical property measurement and does theory explain the observed deviation in results?
2. For which material classes are space-based platforms delivering thermophysical property measurement results with higher accuracy and/or precision than ground-based facilities?

Benefits:

- The proposed work seeks to understand and control the sources of measurement error and to provide a baseline dataset for quantifying uncertainty in measurements (both space- and ground-based).
- The significance of this work is that we will then know the relative increase in measurement fidelity and which material works best in which facility to efficiently use the limited available space sciences resources such as, launch cost, crew time, telemetry bandwidth.

Relevance:

- Human Exploration: TA12.1.1.2: Low mass, multifunctional materials, TA12.1.2.1: Predictive Computational Materials, TA12.1.4.2: High temperature materials.
- NIST/MGI or OGA: Thermophysical properties data
- Commercial: European commercial advisory board (THERMOLAB)

Instrumentation & Experiment Summary

- Utilizes the JAXA ELF
- Ground-based support at MSFC ESL lab
- This program leverages the existing ESA International Topical Team organization to develop a strategy to compare the performance of current flight and ground facilities investigating thermophysical property measurement using levitation techniques.
- New experiments are proposed for the JAXA-ELF facility on the ISS to complement other ongoing investigations that use both the ISS-based MSL-EML and ground-based facilities.
- Microgravity is inherently required for the proposed research. It is necessary to provide quiescent samples that respond only to fluid property induced effects rather than unwanted external forces.

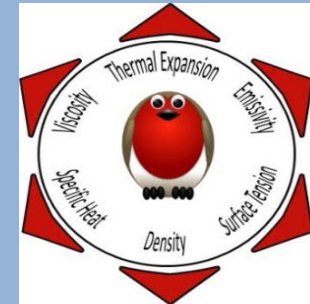

Team/Partnering/Collaboration

NIST, JAXA, DLR, KRISS, Russia, Austria, Germany

Accomplishments

Grant has been approved by NSSC and funding has been sent. TU discussions with JAXA continue.



ELF, Non-Linear Optical Materials, Hyers



Proposal Team: Robert W Hyers (University of Massachusetts), Jonghyun Lee (University of Massachusetts), Hans Fecht (University of Ulm), Geun Woo Lee (Korea Research Institute of Standards and Science), Joonho Lee (Korea University), Masahito Watanabe (Gakushuin University)

Project Scientist: Dr. Jan Rogers, NASA MSFC

Program Manager: Karen Stephens, NASA MSFC

Objective:

This proposal seeks to advance the fundamental understanding of the origins of photorefractivity in particular photorefractive crystals and the manufacturing processes needed to apply this understanding to new devices on Earth.

Benefits:

- Advance the fundamental understanding of the origins of photorefractivity in certain photorefractive crystals and the manufacturing processes needed to apply this understanding to new devices on Earth.
- Potential to enable several new kinds of photonic devices ranging from
 - holographic storage (which would compete with flash memory, CD/DVD/BluRay, and hard disks)
 - adaptive optics
 - phase-conjugate mirrors (which can passively correct images of space from Earth)
 - more precise delivery of beamed energy

Relevance:

- Human Exploration: TA5.1.5.2: Daytime Adaptive Optics, TA8.2.1: Mirror Systems, TA12.4.3.2: Optics Fabrication
- NIST/MGI or OGA: Thermophysical properties data
- Commercial: The market for hard disk drives is about \$31B/year, and the market for flash memory is about \$34B/year.

Instrumentation & Experiment Summary

- Utilizes the JAXA ELF
- Ground-based support at MSFC ESL lab
- The proposed work will address the kinetics of defect formation using high precision density and viscosity measurements under different heating/cooling/isothermal hold cycles.
- Microgravity is necessary to minimize fluid flow in the samples.
- Two of the most promising materials are
 - Bismuth Sillenite ($\text{Bi}_{12}\text{SiO}_{20}$, BSO)
 - Bismuth Germanate ($\text{Bi}_{12}\text{GeO}_{20}$, BGO).



Example of what holographic storage might look like.

Team/Partnering/Collaboration

Germany, South Korea, JAXA

Accomplishments

Grant paperwork is in approval loop with NSSC.



ELF, Supercooled Molten Oxides, Weber



Proposal Team: Richard Weber (Materials Development, Inc.), Robert Hyers (University of Massachusetts), Shinji Kohara (National Institute for Materials Science (Japan)), Jonghyun Lee (University of Massachusetts), Oliver Alderman (Materials Development, Inc.), Takehiko Ishikawa (JAXA), Anthony Tamalonis (Materials Development, Inc.)

Project Scientist: Michael SanSoucie, NASA MSFC

Program Manager: Karen Stephens, NASA MSFC

Objective:

- Precise measurements of the thermophysical properties of undercooled molten metal oxides, many of which have no thermophysical properties data.
- To investigate the properties of liquid phase metal oxides in the equilibrium and supercooled states in quiescent, diffusion-controlled (i.e. without fluid motion) conditions.
- A greater understanding of the science underlying the glass transition and of the requirements for optimizing and processing high value add oxide materials.

Benefits:

- The materials of interest are precursors to high value-added glass materials that are used in photonics, lasers, optical communications, and imaging applications.
- The global glass industry has annual sales in excess of \$100B.

Relevance:

- Human Exploration: TA5.1: Optical Communication and Navigation, TA 8.1.5: Lasers, TA8.1: Optical Components, TA9.3.3.3: Advanced sensors for terrain imaging, TA12.4.3.2: Optics Fabrication
- NIST/MGI or OGA: Thermophysical properties data
- Commercial: photonics, lasers, communication, imaging

Instrumentation & Experiment Summary

- Utilizes the JAXA ELF
- Ground-based support at MSFC ESL lab
- The work will include both ground based and flight experiments on liquids formed from aluminum, calcium, silicon and rare earth element oxide mixtures.
- Microgravity is required to provide quiescent samples that respond only to fluid property induced effects rather than unwanted external forces.

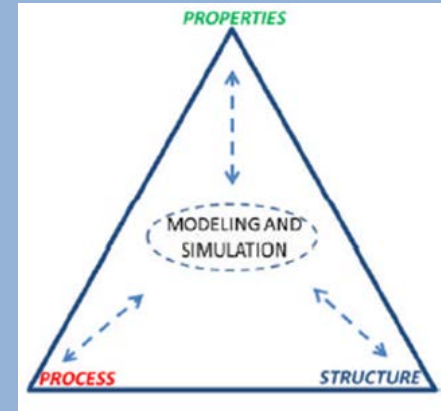

Diagram indicating the essential concept of the proposed work.

Team/Partnering/Collaboration

UMASS, Japan, JAXA

Accomplishments

Grant has been approved by NSSC and funding has been sent. TU discussions with JAXA continue.



MSRR, GEDS, German



PI: Randall M. German, San Diego State University

Co-I: Eugene A. Olevsky, San Diego State University

PS: Biliyar N. Bhat, NASA MSFC

PM: Shawn Reagan, NASA MSFC

Engineering Team: Teledyne Brown Engineering (TBE)

Objectives:

The proposed fundamental research is aimed at the achievement of two critical goals: (i) the in-depth analysis of the liquid phase sintering-induced pore-grain structure evolution by the de-convolution of the impact of gravity and (ii) exploring sintering under microgravity conditions as a promising technique for in-space fabrication and repair.

Benefits:

Future NASA missions will require development of processes that permit fabrication and repair of critical components under reduced gravity conditions. This capability is needed to reduce resource requirements and the spare parts inventory while enhancing the probability of mission success.

Team/Partnering/Collaboration: Future industry collaboration possible.

Instrumentation & Experiment Summary

Critical microgravity sintering experiments will be performed in the Low Gradient Furnace utilizing specially designed cartridges with multiple walled design. Experiment samples contained in alumina crucibles are stacked in a quartz ampoule, which is evacuated and sealed and then inserted into the cartridge – see Figure 1. Parallel experimental runs will be conducted under identical conditions, except for the presence of gravity.



Figure 1: Sample Cartridge Assembly (SCA)

After the completion of the sintering experiments and the return of the ampoules or sample cartridges, the samples will be inspected, subjected to micro-tomography to image pores, and subjected to profile measurement (distortion), density (densification), and microscopy. Cross-sectioned profiles will be imaged, subjected to quantitative microscopy for grain size distribution, pore size distribution, porosity location, and other features such as contiguity and connectivity. These experimental results will be compared to model predictions in terms of grain size, pore size, the spatial location of each, while being linked to the model and macroscopic shape distortion.



MSRR, Growth of Ternary Semiconductors, Su



PI: Dr. Ching-Hua Su, NASA MSFC

PS: Dr. Jan Rogers, NASA MSFC

PM: Shawn Reagan, NASA MSFC

Objectives:

- To establish the relative contributions of gravity-driven fluid flows to the formation mechanism of (1) the non-uniform incorporation of point defects, such as dopant, impurity, and vacancy and (2) the extended defects, such as twinning, observed in the grown crystals as the results of buoyancy-driven convection and irregular fluid-flows.
- To evaluate the additional effects of gravity on the PVT growth processes by examining (1) the growth kinetics on various seed orientations (2) dopant distribution in the Cr doped ZnSe and (3) the compositional segregation and distribution in the ternary compounds grown by PVT.
- To assess self-induced strain effects developed during processing at elevated temperatures and retained on cooling caused by the weight of the crystals

Benefits:

- To establish the relative contributions of gravity-driven fluid flows to the formation mechanism of (1) the non-uniform incorporation of point defects, such as dopant, impurity, and vacancy and (2) the extended defects, such as twinning, observed in the grown crystals as the results of buoyancy-driven convection and irregular fluid-flows.
- To evaluate the additional effects of gravity on the PVT growth processes by examining (1) the growth kinetics on various seed orientations (2) dopant distribution in the Cr-doped ZnSe and (3) the compositional segregation and distribution in the ternary compounds grown by PVT.
- To assess self-induced strain effects developed during processing at elevated temperatures and retained on cooling caused by the weight of the crystals

Partnering/Collaboration:

- Stony Brook University, University of Maryland in Baltimore County

Instrumentation & Experiment Summary

- The experiments will be processed in the Low Gradient Furnace (LGF) in the Materials Science Research Rack (MSRR), International Space Station (ISS).
- The growth ampoules will be prepared at MSFC and loaded into the flight cartridge on ground.
- The growth furnace will be heated up to the prescribed temperature settings and allowed to reach steady state.
- The cartridge will be inserted fast (>1 mm/min), into the supersaturation position previously determined on the ground.
- The crystal starts growing on top of the seed by translating the furnace or sample cartridge and stops after six days.
- The thermal profile will be cooled down slowly to room temperature.

Accomplishments

Four papers have been published in refereed journals in 2016.

Example: “Thermoelectric properties of TI-doped PbTeSe crystals grown by directional solidification”, by Ching-Hua Su, was published on *Journal of Crystal growth*, 439, 80-86 (2016).

Dr. Su has been invited as a member of Editorial Advisory Board for the journal “*Recent Patents on Materials Science*” of Bentham Science publisher.



MSRR, FAMIS, Hofmann



Principal Investigator: Dr. Douglas Hofmann, NASA-JPL
Project Scientist: Jonathan A. Lee, NASA-MSFC
Program Manager: Donnie McCaghren, NASA-MSFC
Engineering Team: NASA JPL

Objective:

Develop W-reinforced Bulk Metallic Glass (BMG) matrix composites with varying volume fraction and morphology of dense particles and demonstrate wear resistance as compared to samples made on the ground in 1-g.

Benefits:

- Metallic glasses, both in the crystalline & amorphous state, can impart unique wear properties used in applications like advanced metal coatings.
- Due to the vast density difference between the two phases for W-BMG, processing these alloys into homogeneous & predictable microstructures in the presence of gravity is difficult. Microgravity solves this problem and allows for the formation of composite microstructures that cannot be replicated on the ground.
- This BMG technology may have benefits for advanced coating applications.

Team/Partnering/Collaboration:

- NASA-JPL, Caltech, NASA-MSFC.

Instrumentation & Experiment Summary:

The MSRR Solidification & Quenching Furnace will be used to study sedimentation in W-BMG composites with varying volume fraction & morphology of dense-phase particles, such as W, as well as microstructures that cannot be attained on the ground. Samples returned from orbit will be subjected to wear testing & compared to ground-fabricated samples.

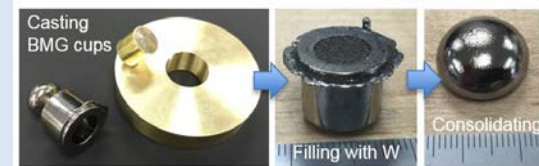

Accomplishments

Tentative dry run SCR summer 2017

Experimental Studies

- Successfully developed a technique to cast 12 mm diameter rods of W-containing Vitreloy -106 composites with varying volume fractions & performed ground truth wear resistance testing.
- Completely characterized ground samples & demonstrated the need for microgravity based on processing limitations due to sedimentation and viscosity of the alloys.

Publications

- D. Hofmann, S. Roberts, K. Accord, "Fabrication of Bulk Metallic Glass Cups and Potential Use in the development of High-Density Ex-situ Composites," paper under submission, (2017).
- D. Hofmann and S. Roberts, "Microgravity Metals Processing: From Undercooled Liquids to Bulk Metallic Glass." *Microgravity*, 15003 (2015).
- Two provisional patents filed in 2017



MSRR, Voorhees Solidification & Microstructure Reference Experiment



Principal Investigator: Prof. Peter Voorhees, Northwestern University

Project Scientist: Dr. Richard Grugel, NASA MSFC

Program Manager: Donnie McCaghren, NASA MSFC

Engineering Team: MSFC

Objective:

- Conduct a detailed statistical description of the topology of the complex two-phase dendritic mushy zone.
- Understand and predict the factors affecting the formation of grain morphology during solidification.
- Better understand the columnar to equiaxed (CET) grain transition.

Benefits:

- Provide benchmark data related to the CET and the general effects of solidification conditions on dendrite fragmentation behavior.
- Update current, or develop new, models for use in determining the solidification microstructure.
- Application of the results could lead to sounder castings with fewer defects

Team/Partnering/Collaboration

- TBD

Instrumentation & Experiment Summary

- Utilizes the SUBSA Furnace in the Microgravity Science Glovebox
- Ground-based support at MSFC

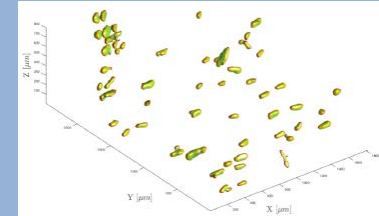
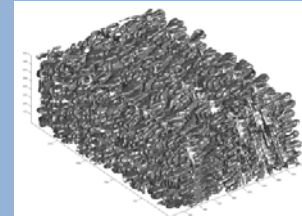

3D reconstruction of a Pb-Sn alloy, dendrite fragments revealed

State-of-the-Art Metallographic Analysis
and Modeling will be Employed

Accomplishments

- Grant is in place.
- Studies by MSFC to evaluate the feasibility of using the SUBSA furnace to conduct the planned experiments aboard the ISS are on-going. The initial results look very promising, particularly in regard to establishing an isothermal zone. One sample is presently undergoing metallographic examination and another sample ampoule has been delivered to Tec-Masters for testing. At least two additional sample ampoules are planned. CLSM is represents an additional hardware option, potentially involving refurbishment.



CSLM, Voorhees Coarsening of Dendrites



PI: Dr. Peter Voorhees, Northwestern University

PS: Dr. Jan Rogers

PM: Donnie McCaghren, NASA MSFC

Engineering Team: Zin

Objective: Understand the coarsening behavior of dendrites in two-phase solutions with a low volume fraction of solid

Benefits:

- Improved understanding of microstructure formation needed to improve understanding of evolution of microstructure and materials performance.
- The morphology of dendrites impacts material properties, but predicting and controlling the morphology of dendrites is difficult, particularly at low volumes where sedimentation and buoyancy driven fluids flows are significant.

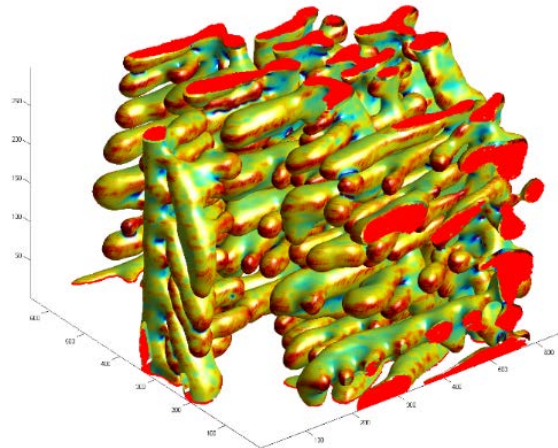

A dendritic two-phase mixture from the ISS experiments. The liquid is transparent. The solid-liquid interfaces are colored based on the mean interfacial curvature. Evident are the secondary dendrite arms and vertical primary dendrites. The experiment measures the evolution of these complex structures.

Instrumentation & Experiment Summary

The CSLM hardware will heat the samples above the eutectic temperature, thus allowing the dendrites to coarsen, and quench the samples to preserve the coarsened structures.

Accomplishments

- Peter W. Voorhees elected into the 236th class of the American Academy of Arts and Sciences, one of the nation's oldest and most prestigious honorary societies. A total of 213 leaders in the sciences, social sciences, humanities, arts, business, and public affairs were elected into the academy in 2016
- Invited talk: "Quantifying Microstructure Evolution in 3D" presented at MRS Spring Meeting, March 29, 2016 in Phoenix, AZ
- Concluding analysis