

Longitudinal Genetic Analysis of EEG Coherence in Young Twins

G. C. M. van Baal,^{1,2} D. I. Boomsma,¹ and E. J. C. de Geus¹

During middle childhood, continuous changes occur in electroencephalogram (EEG) coherence, an index of cortico-cortical connectivity of the brain. In the gradual development of EEG coherence, occasional “growth spurts” are observed which coincide with periods of discontinuous development in cognition. Discontinuous development may reflect changes in the genetic architecture of a trait over time, for instance, by the emergence of new genetic factors. To examine stability and change in genetic and environmental influences on EEG coherence from ages 5 to 7 years, intrahemispheric EEG coherences from 14 connections were collected twice in 209 twin pairs. Overall, heritabilities (h^2) were moderate to high for all EEG coherences at both ages (average: 58%). For occipito-cortical connections in the right hemisphere, h^2 increased with age due to a decrease in environmental variance. For prefronto-cortical connections in the left hemisphere, h^2 decreased with age due to a decrease in genetic variance. New genetic factors at age 7 were found for prefronto-parietal coherence, and centro-occipital and parieto-occipital EEG coherences in both hemispheres and, in the left hemisphere, for prefronto-frontal EEG coherences. Mean genetic correlation for these cortico-cortical connections over time was 0.72, indicating that at least part of the genetic influences is age-specific. We argue that this is convincing evidence for the existence of stage-wise brain maturation from years 5 to 7, and that growth spurts in EEG coherence may be part of the biological basis for discontinuous cognitive development at that age range.

KEY WORDS: Electroencephalogram; brain; endophenotype; development; heritability; reliability.

INTRODUCTION

Cognitive development in childhood depends on the formation of separate neuronal networks within neural subsystems (e.g., basal ganglia, primary sensory and motor cortex) as well as on their integration through the maturation of intracortical connectivity (Goldman-Rakic, 1987; Huttenlocher, 1990). Structural brain imaging studies (Chugani, 1994, 1998; Chugani *et al.*, 1987; Courchesne *et al.*, 2000; Giedd *et al.*, 1999; Huttenlocher, 1979; 1994; Jernigan *et al.*, 1991; Pfefferbaum *et al.*, 1994) show that from birth to adulthood a grad-

ual increase in white matter is found that reflects the ongoing myelination of the many connections between different regions of the cortex. This myelination is particularly evident in the gradual increase in size of the corpus callosum (Reiss *et al.*, 1996) and may be more substantial in the left than in the right hemisphere (Paus *et al.*, 1999). The increase in white matter is initially paired to an increase in grey matter but after age 4, grey matter gradually decreases (Pfefferbaum *et al.*, 1994). The decrease in grey matter is thought to reflect a pruning of cell bodies and synaptic contacts such that only connections incorporated into functional networks survive, whereas random connections are eliminated. This age, therefore, demarcates the onset of a better differentiation and integration of functionally distant brain areas.

However, structural imaging studies such as these do not reveal the extent to which the various brain areas become functionally connected. A noninvasive method

¹ Department of Biological Psychology, Vrije Universiteit, Amsterdam, The Netherlands.

² To whom correspondence should be addressed. Vrije Universiteit, Department of Biological Psychology, Van der Boecheorststraat 1, room 1F-42, 1081 BT Amsterdam, The Netherlands. Tel: +31.20.444.8802. Fax: +31.20.444.8832. e-mail: gcm.van.baal@psy.vu.nl

of assessing changes in connectivity is provided by electroencephalogram (EEG) coherence, which is the squared cross-correlation in the frequency domain between two EEG time series measured simultaneously at different scalp locations (Nunez, 1981). The development of EEG coherence from childhood into young adulthood has been extensively documented by Thatcher and co-workers (Thatcher, 1991; 1992; 1994a; 1994b; Thatcher *et al.*, 1986; 1987). Their EEG coherence data obtained from more than 400 children aged 1 to 17 years showed that a gradual decline in coherence with age appeared to be interspersed with periods of increased coherence. A cyclic pattern of changes in EEG coherence followed by a period of relative stability in EEG coherence was observed with a fluctuation of 2 to 4 years (Thatcher, 1994a; 1994b). A period of major change in EEG coherence was seen between ages 5 and 7 years, and another at about ages 9 to 11 years (Thatcher, 1994a). These growth spurts in EEG coherence seem to coincide with the discontinuous, stagewise transitions in cognitive developmental stages as described by Piaget (1966). The coherence growth spurt at age 6 years coincides with the transition from pre-operational to operational thinking, the growth spurt at age 10 years with the transition of operational thinking to formal logic thinking.

In addition to the association of EEG coherence with cognitive development, changes in EEG coherence have been suggested to be directly associated with shifts from synaptic outgrowth to synaptic “pruning,” and vice versa (Thatcher *et al.*, 1994; Kaiser and Gruzelier, 1996). In fact, the growth cycles of approximately 2 to 4 years may be explained as shifts from a phase of overproduction of synapses to a phase of pruning of nonfunctional synapses. It was suggested that increases in EEG coherence between distant scalp locations reflect the temporary overproduction of synapses, whereas the decline in EEG coherence reflects selective pruning of existing synaptic connections according to the demands of the environment (Thatcher, 1994a). Synaptic growth may be assumed to be mainly determined by genetic effects (Changeux and Danchin, 1976; Changeux and Dehaene, 1989; Chen and Tonegawa, 1997). During pruning, however, genetic effects interact with environmental effects that determine which synapses will be consolidated or eliminated (Greenough *et al.*, 1987; Klintsova and Greenough, 1999). Thus, during development, a phase of synaptic overproduction may coincide with increased genetic variance, whereas a phase of pruning may be associated with increased environmental variance. In addition, the genetic

factors that influence pruning are likely to be different from those that influence growth, so that new genetic factors may emerge during a maturational shift from synaptic production to pruning. The shifts from pruning to synaptic outgrowth, and vice versa, may show strong regional differences, e.g., the frontal brain could switch to pruning at the same time that other parts switch to synaptogenesis.

Changes in the relative influence of environmental and genetic influences on cortico-cortical connectivity can be studied using longitudinal EEG coherence data from genetically related subjects. In the present study, heritability will be studied at the start and at the end of a putative growth spurt, e.g., from ages 5 to 7. Previous studies measuring EEG coherence in young twins (Ibatoullina *et al.*, 1994; van Baal *et al.*, 1998) showed that for both long- and short-distance intrahemispheric coherences, a significant part of the variance was explained by genetic influences. Mean heritability over all cortico-cortical connections was 49% in a large cohort of 5-year-old twins (van Baal *et al.*, 1998). In this same cohort, the changes in these heritabilities will now be studied 1.5 years later. To allow for a topographical differentiation of brain maturation—various studies have indicated that anterior and posterior brain areas and left and right hemispheres develop at different rates (Thatcher, 1991; 1994a; 1994b; Thatcher *et al.*, 1987)—short and long distance connections along the antero-posterior axis and the postero-anterior axis (e.g., prefronto-cortical and occipito-cortical coherences) will be tested in left and right hemispheres separately. Likewise, in view of structural brain imaging findings (Gur *et al.*, 1999) sex differences in heritability will be explicitly modelled throughout.

As outlined above, discontinuity of EEG coherence in a region of the brain is thought to be paired to a switch from pruning of synapses to synaptic outgrowth in that region. Such effects should be reflected in topographically confined increases in genetic variance. The huge advantage of a longitudinal genetic analysis of EEG coherence is that it can directly test whether such increased genetic variance reflects amplification of existing gene effects or the emergence of the effects of new genes influencing EEG coherences at age 5 compared with age 7. Thus, apart from establishing topographically differentiated changes in the relative contribution of genetic and environmental influences from age 5 to 7, the model fitting approach in this paper is used to test the emergence of new genetic and environment factors at age 7 years. Newly emerging genetic factors at age 7 years would strongly support

the theoretical notion of a discontinuous development of cortico-cortical connectivity.

METHODS

Subjects

A longitudinal study of genetic and environmental influences on neural development during childhood was conducted in 209 twin pairs (mean age first measurement = 5.3 years, $SD = 0.2$ years; mean age second measurement = 6.8 years, $SD = 0.2$ years). The twins were all registered in the Netherlands Twin Register, which contains approximately 50% of all Dutch twins born after 1986 (Boomsma *et al.*, 1992). All participants were healthy, with a normal IQ (Boomsma and van Baal, 1998), and normal or corrected to normal vision. Zygosity determination for same-sex twin pairs was based either on blood typing or on DNA polymorphisms (159 pairs). For 11 same-sex twin pairs, these data were not available. These twins were assigned to a zygosity group using a discriminant analysis based on their physical appearance (hair color, hair form, on confusion of identity by acquaintances, and on confusion of identity by close friends of the family).

Of the 209 twin pairs participating in this study, 152 twin pairs had complete data on both measurement occasions. In addition, measurements of EEG coherence at a single time-point were available for fifteen 5-year-old twin pairs and thirty 7-year-old twin pairs. No coherence data could be obtained from 12 twin pairs. Data were not available because of difficulties during the experiment (children fell asleep during the experiment or showed high levels of arousal and cried) or because the twins did not agree to participate a second time. Distribution over zygosity groups for the 167 (i.e., 152 + 15) 5-year-old twin pairs was 34 monozygotic males (MZM), 33 dizygotic males (DZM), 37 monozygotic females (MZF), 32 dizygotic females (DZF), and 31 dizygotic opposite-sex twins (DOS) and for the 182 (i.e., 152 + 30) 7-year-old twin pairs 36 MZM, 37 DZM, 41 MZF, 33 DZF, and 35 DOS.

Procedure

Detailed procedures of data collection are described elsewhere (van Baal *et al.*, 1996). Briefly, an electrocap with electrodes in the 10–20 system of Jasper (1958) was used to measure brain activity on 14 scalp locations during 3 min of quiet rest with eyes closed. Vertical and horizontal eye movements were recorded

for correction afterwards. EEG was recorded unipolarly with linked ears referenced according to the method described by Pivik and colleagues (1993), that is, two separate preamplifiers with high input impedance for each of the reference electrodes were used, and their output was linked electrically. All electrode impedances were kept below 10 K Ω . EEG was recorded continuously on an 18-channel Nihon Kohden PV-441A polygraph. Time constants were set to 5 s, high frequency cut-off was 35 Hz and sample frequency was 250 Hz. Signals were converted with a 12 bits AD converter.

Data Quantification and Data Reduction

First, the EEG time series were divided into 90 two-sec epochs. Epochs with clippings and with abnormal EEG patterns (detected during visual inspection) were excluded from further analysis. Second, EOG artifacts were removed using an automatic regression procedure for EOG-EEG transfer in the frequency domain (Brillinger, 1975). Signals were converted from the time domain into the frequency domain using a Fast Fourier Transformation. At each frequency, the attenuation (or amplification) of the EEG signal was determined with a gain function and the delay between the two signals was determined by a phase function. These functions were used to correct the EEG periodograms by subtracting the weighted EOG periodogram from the EEG periodogram for each of the 90 two-sec epochs. Subsequently, the corrected EEG periodograms were further processed to obtain power spectra for every electrode position, and cross-spectra and phase-spectra for every EEG electrode combination. The power spectrum depicts the amount of variance in the EEG time series (on the y-axis) that can be attributed to cyclic fluctuations with a given frequency (indicated on the x-axis). The cross-spectra depict the covariance of two signals in these frequency bands. The phase-spectra represent the lead-lag relation between the signals at different scalp locations for every frequency band. Phase-spectra were used to determine whether the signals of two scalp locations actually had a phase difference, because zero phase differences would point to signal transport other than via the axonal fibers (i.e., volume conduction). Power-, cross-, and phase-spectra were calculated over all valid epochs (epochs with clipping or resetting were automatically excluded from analysis, epochs during which the child moved or talked were indicated during the recording session and manually excluded thereafter). The minimum number of epochs was 30. Three sets of spectra per subject and per electrode combination were

computed: one for all epochs, one for all odd, and one for all even 2-sec epochs from the total number of EEG registrations. All spectra ranged from 0.5 cycles per second (Hz) to 30 Hz with a 0.5 Hz resolution. EEG coherence spectra were calculated for every 0.5 Hz frequency band, using the formula:

$$\text{EEG coherence} = \frac{(\text{cross spectrum}_{(1,2)})^2}{\text{power spectrum}_{(1)} \times \text{power spectrum}_{(2)}}$$

As is shown in this formula, EEG coherence measures the square of the linear association between the two signals and is analogous to the square of the correlation coefficient. Thus, coherence ranges from 0 to 1. In children, largest EEG power is found in the 4.0 to 7.5 Hertz range, i.e., in the theta band (Niedermeyer and Lopes da Silva, 1993). Therefore, the mean of all 0.5 Hz EEG coherences in the theta range was calculated and then used for statistical analyses. Data were transformed using the formula $y = \log(x/1 - x)$ to obtain a normal distribution of the data, where y is transformed coherence and x is untransformed coherence.

EEG coherence was calculated intrahemispherically, because the majority of connections are within the same hemisphere (Nunez, 1981). Coherences were calculated separately over the left and right anterior-posterior axes (see Fig. 1): from prefrontal electrodes to frontal (Fp1-F3, Fp2-F4), central (Fp1-C3, Fp2-C4), parietal (Fp1-P3, Fp2-P4) and occipital electrodes (Fp1-O1, Fp2-O2), and from occipital electrodes to frontal (F3-O1, F4-O2), central (C3-O1, C4-O2) and parietal electrodes (P3-O1, P4-O2). The interelectrode

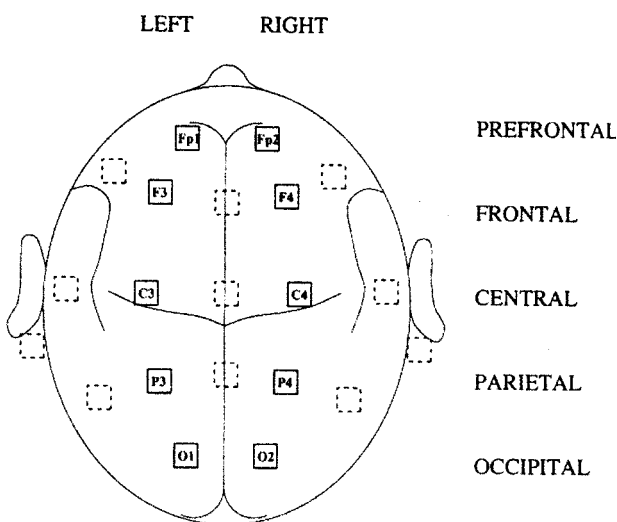

Fig. 1. EEG was measured on the following scalp locations: prefrontal (Fp1; Fp2), frontal (F3; F4), central (C3; C4), parietal (P3; P4) and occipital (O1; O2).

distances were 7, 14, 21 and 28 cm on average for Fp-F, Fp-C, Fp-P, and Fp-O coherences, respectively, and 21, 14 and 7 cm for F-O, C-O, and P-O coherences.

Statistical Analysis

For each EEG coherence, a number of tests were performed using structural equation modeling and maximum likelihood estimation of parameters in Mx (Neale *et al.*, 1999):

Means

For each electrode combination eight variables were available for a twin pair: for each twin (oldest and youngest¹), for each measurement occasion (at age 5 and at age 7) and for odd and even epochs. First, a saturated model was fitted to the data, in which variances, covariances, and means in all 5 zygosity groups (MZM, DZM, MZF, DZF, DOS) were estimated without any constraints. Second, mean values were constrained to be equal for odd and even coherences, for the oldest and youngest of a twin pair and for MZ and DZ twins within a sex. Next, sex differences in mean coherences were tested by constraining mean values of males and females to be equal. Likewise, age differences were tested by constraining mean values at age 5 to be equal to mean values at age 7. Goodness-of-fit of the more constrained model was evaluated by likelihood-ratio tests.

Split-Half Reliability and Temporal Stability; Twin- and Cross-Correlations

To obtain estimates and test for significance of reliability of the signals, split-half correlations (i.e., the correlation between odd and even coherences) were calculated using the same approach. Split-half correlations were constrained to be the same for MZs and DZs, for oldest and youngest, and for males and females, and at ages 5 and 7. Test-retest stability—that is, the phenotypic correlation between true EEG coherence at age 5 and true EEG coherence at age 7—was constrained to be equal for MZ and DZ twins, for oldest and youngest twins, and for males and females. For every measurement occasion (ages 5 and 7) and zygosity group (MZM, DZM, MZF, DZF, and DOS), twin-correlations (i.e., the correlation between true EEG coherence of twin 1 and true EEG coherence of twin 2, per zygosity group) and cross-correlations (i.e., the correlation between twin 1 at age 5 and twin 2 at age 7, or vice versa) were estimated. Sex differences in twin correlations were tested by

¹ In DOS twins, the first set of variables was for the male twin and the second set of variables for the female twin.

constraining MZM and MZF correlations to be equal, as well as DZM, DZF and DOS correlations.

Genetic Model Fitting

Genetic and environmental influences on interindividual differences in EEG coherences were tested using the path diagram in Fig. 2, which is a compilation of three different parts: a model for the decomposition of total observed variance into reliable variance and measurement error; a model which represents the twin design to decompose variance into a genetic and environmental part; and a triangular decomposition of each source of variances and covariances of EEG coherences at ages 5 and 7, to account for genetic and environmental stabilities.

The decomposition of observed variance into reliable variance and measurement error relies on the fact that EEG coherence was calculated twice at each age and for each child: once for odd-numbered epochs (coh-x) and once for even-numbered epochs (coh-y). These two variables can differ from each other only due to measurement error: All covariance between these variables is variance due to the true coherence. In our model, measurement error was the same for males and females, and for ages 5 and 7 years.

The reliable variance in the EEG coherence was decomposed into genetic (G) and environmental (E) parts. Genetic variance can be decomposed into additive and dominant genetic variance. However, dominant genetic variance cannot exist without additive genetic variance. To construct a structural model that

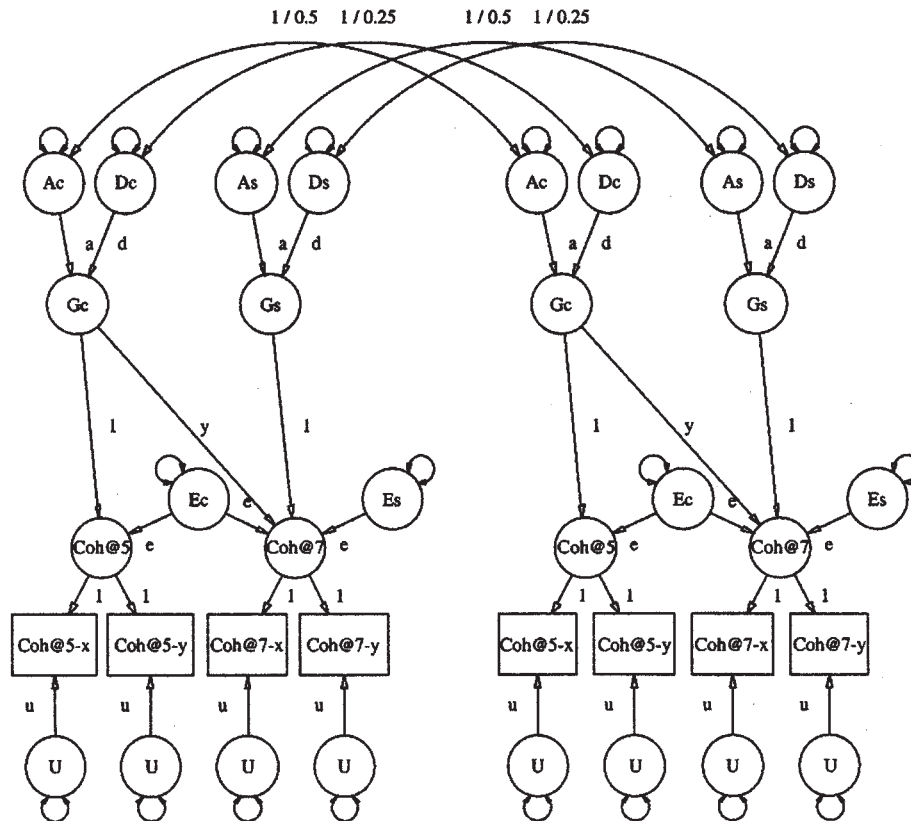

Fig. 2. Path diagram of multivariate genetic model. The model consists of three parts: the decomposition of observed variance into real variance and measurement error, the twin design, and the decomposition of real variance into genetic and environmental factors, common for both ages or specific to age 7. Phenotypes of both twins (twin 1 and twin 2) are influenced by genetic factors (G) and unique environmental factors (E). The genetic factors are influenced by additive genetic factors (A) and dominant genetic factors (D). Correlation between A_{twin1} and A_{twin2} is 1 for MZ twins and .5 for DZ twins, correlation between D_{twin1} and D_{twin2} is 1 for MZ twins and .25 for DZ twins. Factor loadings of A and D are constrained to ensure that additive genetic variance is at least twice as large as dominant genetic variance, to yield a biologically plausible model. Gc and Ec are factors common to both ages and Gs and Es are factor loadings specific to age 7 years. Coh = true coherence, coh-x and coh-y are observed coherences, a = additive genetic factor loading, d = dominant genetic factor loading, e = environmental factor loading, u = measurement error factor loading, y = loading of coherence at age 7 on common set of genes.

agrees with the biological reality, a constraint was set to the parameter estimates such that additive genetic variance was at least twice as large as dominant genetic variance (Falconer and Mackay, 1996). The correlation between additive (A) and between dominant (D) genetic factors equals 1 for MZ twins, and .5 and .25, respectively, for DZ twins (Mather and Jinks, 1977). Given the relatively small number of subjects in this study, it will probably be difficult to detect dominance (Martin *et al.*, 1978), but twin correlations for long distance coherences consistently point toward dominance and, therefore, it is included in the models. Environmental variance can be decomposed into shared and unique components. The shared environmental correlation (C) is 1 in both MZ and DZ twins. Correlations for the non-shared, unique environmental influences (E) are 0 for both types of twins. However, twin correlations did not give any indication for shared environmental influences, and C was excluded from further analyses.

For each source of variation (G and E) two factors were specified: one factor that influenced EEG coherence at ages 5 and 7 years and a factor that influenced EEG coherence at age 7 years only. The first factor is common to both ages and may contribute to the covariance (stability) between EEG coherences measured at ages 5 and 7 years. The second factor accounts for specific influences at age 7 years. If the factor loading of EEG coherence at age 7 years on the first set of factors is not significantly different from zero, then all (genetic or environmental) variance at age 7 years is due to new influences. If the factor loading of the true-coherence at age 7 on the second set of factors is not significantly different from zero, then no new influences are expressed at age 7 years.

The model in Fig. 2 was fitted to EEG coherences for each electrode combination separately. First an ADE model was fitted (parameter estimates were the same for males and for females). Then, dominant genetic variance at age 7 years was left out of the model (AcAsDc model, where Ac is common additive genetic variance, As is specific additive genetic variance, and Dc is common dominant genetic variance). After that, common dominant genetic variance was discarded from the model (AcAs) and subsequently additive genetic variance at age 7 years (Ac). If appropriate, a further reduction was accomplished, giving a model with two age-specific additive genetic influences (A5A7) or a model without genetic influences (E). For all models, specific environmental in-

fluences were represented by a triangular decomposition (Choleski decomposition).

For the best-fitting model, broad heritabilities (h^2) were calculated as the percentage of (additive and dominant) genetic variance over total reliable variance. In addition, genetic and environmental correlations between coherences at ages 5 and 7 years were calculated. In the final model, maximum likelihood based 95% confidence intervals (CI) of all estimates were obtained (Neale and Miller, 1997).

Structural equation modeling using the computer program Mx (Neale *et al.*, 1999) was applied to obtain the best-fitting model. Maximum likelihood was used for parameter estimation. The goodness-of-fit of the ADE model was compared with the goodness-of-fit of a saturated model. Thus, a χ^2 which indicates the goodness-of-fit of this model was obtained. To compare the fit of two nested models, hierarchic χ^2 tests were used. With these tests, the log-likelihood of a nested model is subtracted from the log-likelihood of a more general model. Twice this difference is χ^2 distributed, with the difference of *df*'s of the two models as degrees of freedom. When a constrained model does not describe the data significantly worse than the more general model, the most parsimonious model (i.e., with the least parameters) is chosen. Because the sample contains missing data, the data could not be summarized in dispersion matrices, and the models had to be fitted directly to the raw data. The likelihood of each pedigree is calculated separately and the product of these likelihoods (i.e., the sum of the log-likelihood) is maximized (Neale and Cardon, 1992).

RESULTS

Means

Except for 1 electrode pairing out of 14 (Fp2-F4), EEG coherences were the same for the oldest and youngest of the twins, for MZ and DZ twins, and for the odd and even coherences. Hence, results below will not consider zygosity or birth order effects. Table I gives the mean values of EEG coherences for males and females at both ages and model fitting results for tests of sex and age differences are reported. Significantly lower short-distance coherences in males were found for Fp1-F3, Fp1-C3, P3-O1, and Fp2-F4. This difference was most obvious in 5-year-old children. Coherences of males and females became more similar at age 7 years. Anterior short-distance coherences were largely the same at age 5 and age 7. Posterior short-

Table I. Mean EEG Coherences for Males and Females at Ages 5 and 7. Three Models were Fitted to the Data: (1) A Model in Which Means of Odd- and-Even-Averaged Coherences for Oldest and Youngest and for MZ and DZ Twins of the Same Sexes were Constrained to be Equal; (2) A Model for Which, in Addition to the Equality Constraints, Male and Female Coherences were Constrained to be Equal, but for which Coherences at Ages 5 and 7 Were Allowed to Differ; and (3) A Model for Which Coherences at Ages 5 and 7 were the Same, but Different for Males and Females. Significance of Age and Sex Effects ($p < .05$) is Indicated

Left	Age 5 years		Age 7 years		<i>sex diff?</i>	<i>Age diff?</i>
	Male	Female	Male	Female		
Fp-F	0.57	0.62	0.60	0.62	m < f	no
Fp-C	0.22	0.25	0.22	0.23	m < f	no
Fp-P	0.09	0.09	0.08	0.08	no	5 > 7
Fp-O	0.05	0.05	0.04	0.04	no	5 > 7
F-O	0.08	0.07	0.06	0.05	no	5 > 7
C-O	0.19	0.19	0.17	0.16	no	5 > 7
P-O	0.52	0.56	0.52	0.52	m < f	5 > 7

Right	Age 5 years		Age 7 years		<i>sex diff?</i>	<i>Age diff?</i>
	Male	Female	Male	Female		
Fp-F	0.60	0.64	0.63	0.65	m < f	5 < 7
Fp-C	0.22	0.25	0.23	0.24	no	no
Fp-P	0.09	0.09	0.08	0.08	no	5 > 7
Fp-O	0.05	0.05	0.04	0.04	no	5 > 7
F-O	0.07	0.07	0.06	0.05	no	5 > 7
C-O	0.18	0.19	0.15	0.15	no	5 > 7
P-O	0.53	0.56	0.52	0.52	no	5 > 7

distance coherences and all long-distance coherences decreased from age 5 to 7 years.

Split-Half Reliability and Temporal Stability

Fig. 3 shows split-half correlations across even and odd epochs and temporal stability of EEG coherence without and with correction for split-half correlations. Split-half correlations were the same for males and females and for ages 5 and 7 (exceptions were slightly higher correlations for males at P4-O2 and lower correlations for both sexes at age 7 for Fp1-O1 and F3-O1). Split-half correlations became lower with increasing distance, indicating larger measurement errors for longer distances. Lowest split-half reliability was found for coherence between Fp2 and O2 (0.58), highest reliability was found for P3-O1 (0.92).

When stability was calculated without taking the differences in split-half reliabilities into account, no clear pattern emerged (correlations ranged from 0.30 to 0.46). However, when temporal stability was corrected for split-half reliabilities, low to moderate sta-

bilities were found (0.34 to 0.71), which increased with increasing interelectrode distance, indicating that EEG coherence at age 5 years is a better predictor of EEG coherence at age 7 years for long-distance connectivity. Sex differences in stabilities were not significant.

Twin- and Cross-Correlations

Correlations of latent phenotypes (i.e., corrected for measurement errors) are shown in Table II. Sex differences in twin correlations were never significant (with the possible exception of P3-O1 coherence, for which the difference in χ^2 ($df = 6$) was 12.62, $p = 0.050$). MZ correlations were always higher than DZ correlations, indicating the importance of genetic factors. In fact, MZ correlations for long-distance coherences were mostly more than twice the DZ correlations, pointing to non-additive genetic influences. For a number of electrode combinations, MZ correlations seemed to change with age, suggesting different heritabilities over time. MZ cross-correlations

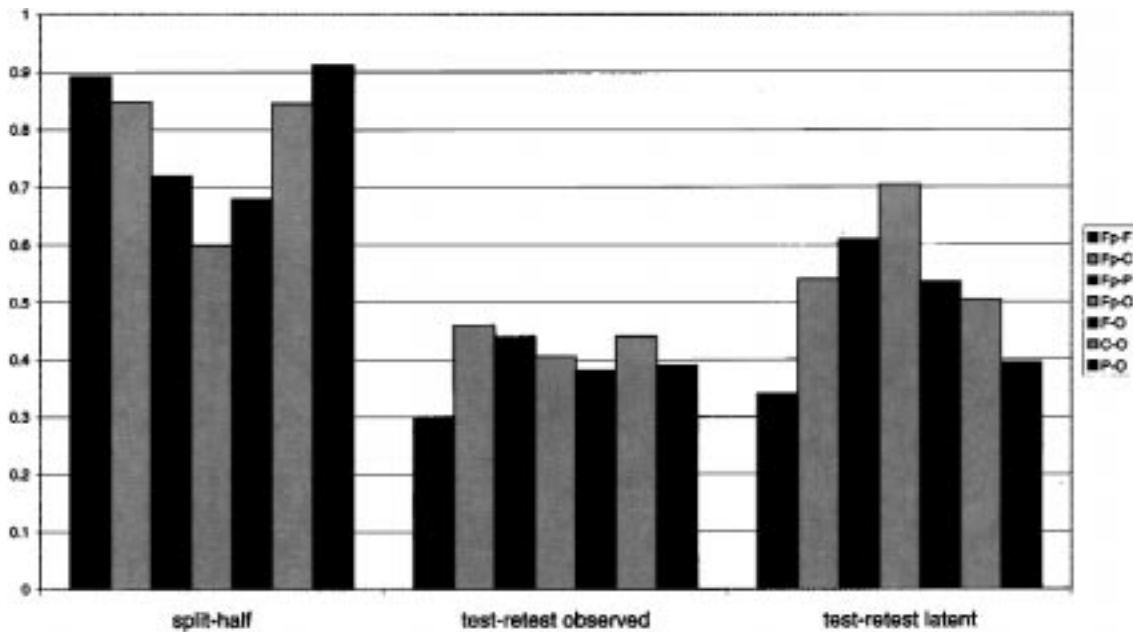

Fig. 3. Split-half correlations of observed phenotypes (reliability) and test-retest correlations of observed phenotypes (test-retest observed) and of latent phenotypes (test-retest latent) for different EEG coherences. Interelectrode distances for the EEG coherences are 7, 14, 21, 28, 21, 14, and 7 cm, respectively.

were slightly lower than test-retest correlations and higher than DZ cross-correlations, which indicates that the stability between first and second measurement is largely genetic in origin. Again, the much higher cross-correlations in MZ twins compared with DZ twins suggests non-additive genetic influences. All mentioned effects were formally tested using structural equation modelling.

Genetic Model Fitting

The model summarized in Fig. 2 was used to study the effects of genetic and environmental influences on EEG coherence. First, the model with additive genetic, dominant genetic and unique environmental factors (common for ages 5 and 7 years and specific for age 7 years) was fitted to the data. Because twin correlations were not significantly different for males and females, parameter estimates were constrained to be equal for both sexes.

For all EEG coherences dominance influences, that is, D_s (specific at age 7 years) and D_c (common for ages 5 and 7 years), could be discarded from the analyses without significantly reducing the fit of the models. The latter factor, which accounts for stability in EEG coherence, showed a trend toward dominant genetic influences for long-distance coherences (χ^2 -differences ranging

from 2.45 to 3.38), but was never significant. Specific additive genetic influences at age 7 years could not be left out of the models: Table III shows that for a number of cortico-cortical connections, significant χ^2 values ranging from 4.48 to 17.80 ($df = 1$) were found between a model with common specific and additive specific genetic factors (AcAs) and a model with only a common additive genetic factor (Ac). This was not the case for prefronto-frontal, prefronto-central, and prefronto-occipital EEG coherences: For these EEG coherences the specific additive genetic factor could be discarded from the models. The common genetic influences could never be discarded from the analyses without a significant reduction in goodness-of-fit, indicating genuine genetic influences on individual differences in connectivity.

Heritabilities

Fig. 4 displays heritability estimates of left and right hemispheric EEG coherences at ages 5 and 7 years (second column). Heritabilities were moderate to high, ranging from 25% to 85%. There was an increase in heritability with increasing distance which was most obvious in the anterior to posterior direction. Heritabilities of EEG coherences in the posterior to anterior direction were more alike and did not vary substantially with

Table II. Twin-Correlations and Cross-Correlations (i.e., correlations between EEG coherences of twin 1 at age 5 and twin 2 at age 7 and vice versa) for Five Sex by Zygosity Groups (corrected for reliabilities at both ages)

Left hemisphere		MZM	MZF	DZM	DZF	DOS
N (pairs)	5 years	34	33	37	32	31
	7 years	36	37	41	33	35
Fp-F	5 years	.58	.55	-.02	.44	.54
	7 years	.37	.23	.24	.07	-.12
	Cross	.20	.19	-.01	.16	.19
Fp-C	5 years	.58	.76	.07	.18	.16
	7 years	.40	.51	.16	.17	-.28
	Cross	.32	.43	.04	.10	.09
Fp-P	5 years	.87	.75	.17	.10	-.07
	7 years	.61	.61	.09	.21	-.30
	Cross	.53	.46	.10	.06	-.04
Fp-O	5 years	.83	.77	.23	.01	.13
	7 years	.83	.64	-.04	-.01	-.09
	Cross	.56	.52	.15	.01	.09
F-O	5 years	.71	.81	.02	.05	.02
	7 years	.73	.42	.53	.17	.17
	Cross	.37	.42	.01	.02	.01
C-O	5 years	.68	.70	-.03	.16	.29
	7 years	.71	.50	.45	.21	.20
	Cross	.34	.35	-.01	.08	.14
P-O	5 years	.32	.73	-.17	.38	.15
	7 years	.44	.62	.18	.34	.21
	Cross	.11	.25	-.06	.13	.05
Right hemisphere		MZM	MZF	DZM	DZF	DOS
Fp-F	5 years	.48	.26	-.08	.40	.42
	7 years	.39	.03	-.06	-.12	-.10
	Cross	.16	.09	-.03	.13	.14
Fp-C	5 years	.37	.43	.22	.25	.30
	7 years	.37	.27	.06	.05	-.12
	Cross	.19	.22	.11	.13	.15
Fp-P	5 years	.73	.74	.32	-.06	-.19
	7 years	.61	.70	-.07	.33	-.14
	Cross	.44	.45	.20	-.04	-.12
Fp-O	5 years	.93	.72	.06	.19	-.21
	7 years	.96	.80	-.09	.13	.00
	Cross	.68	.53	.04	.14	-.15
F-O	5 years	.65	.74	-.10	.10	-.37
	7 years	.70	.72	.26	.36	-.10
	Cross	.35	.40	-.05	.05	-.20
C-O	5 years	.52	.71	.15	.07	.11
	7 years	.70	.68	.59	.33	.08
	Cross	.26	.36	.08	.03	.06
P-O	5 years	.38	.48	.06	.02	.04
	7 years	.69	.60	.29	.29	.33
	Cross	.17	.21	.03	.01	.02

distance. The distance-related increase in heritability of EEG coherence in the anterior to posterior direction was most obvious at age 7 years, but was already present at age 5 years. Heritabilities for left and right homologous EEG coherences were mostly the same, except for

prefronto-frontal and prefronto-central coherences at age 5 years. For these coherences, left hemispheric coherences showed larger heritabilities.

Based on confidence intervals, heritabilities for left hemispheric coherences in the anterior to posterior

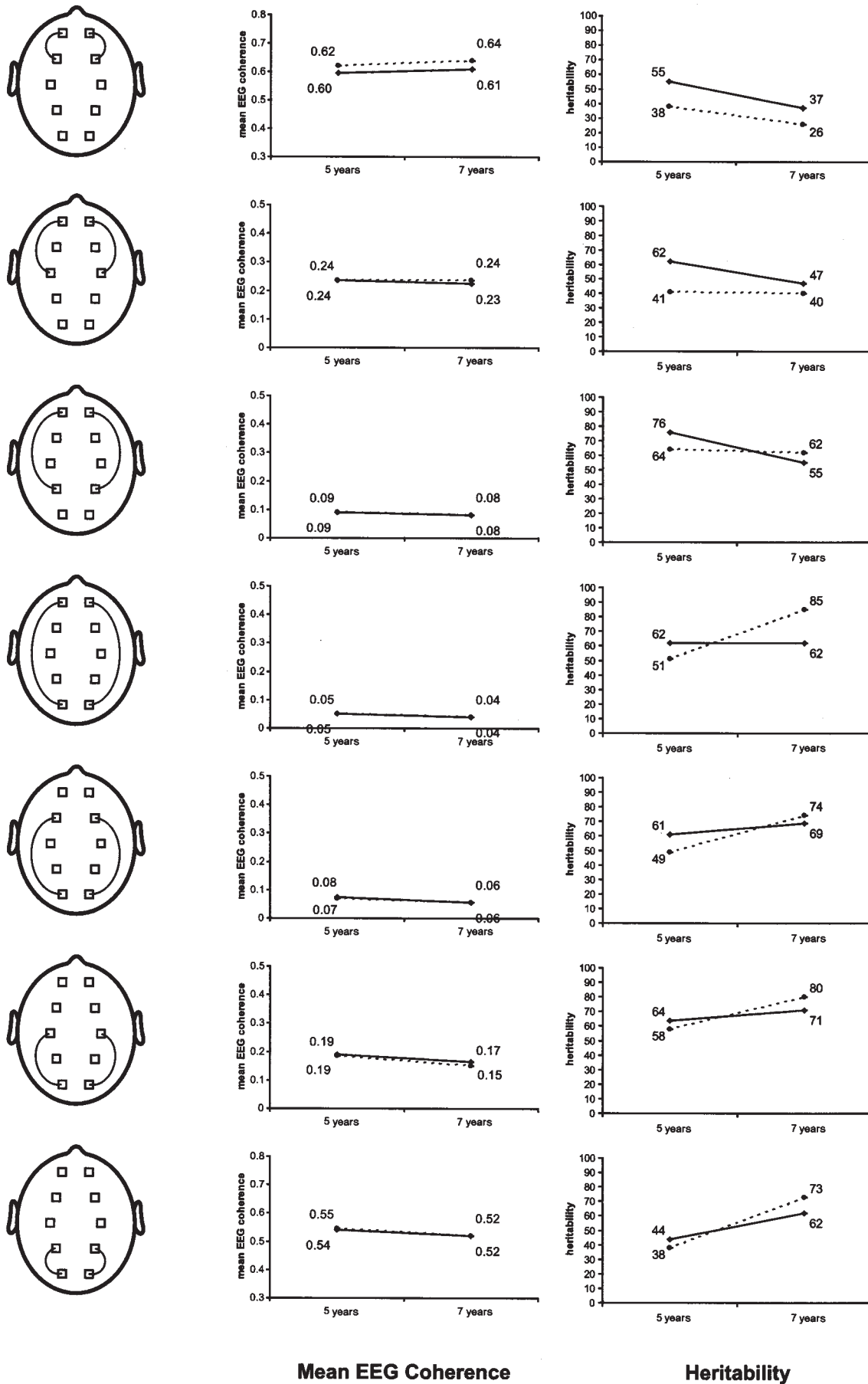
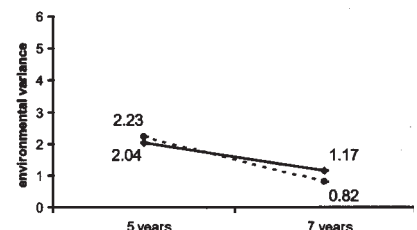
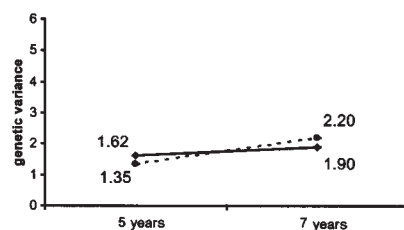
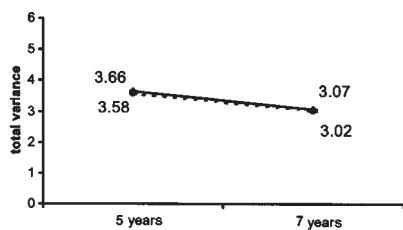
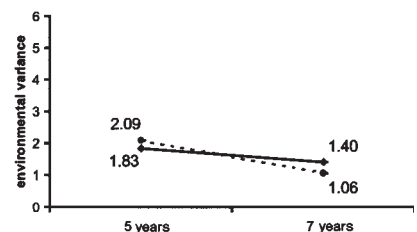
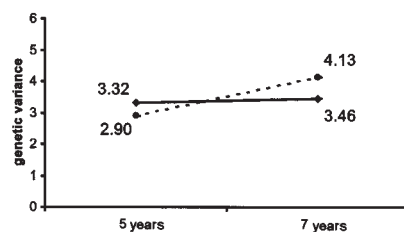
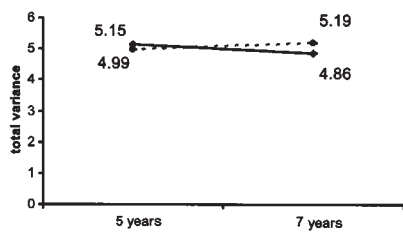
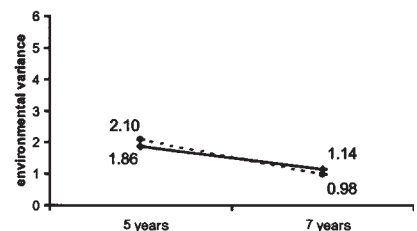
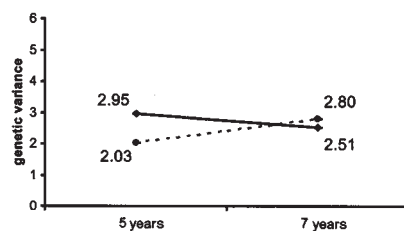
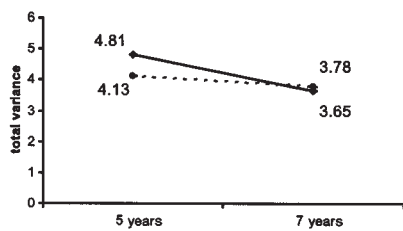
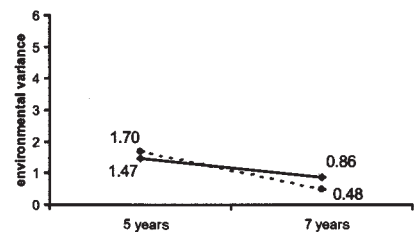
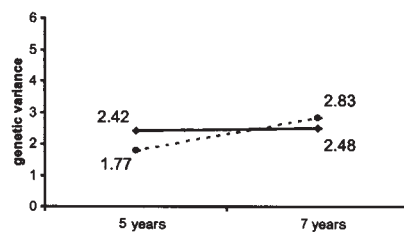
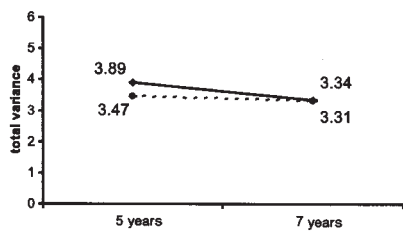
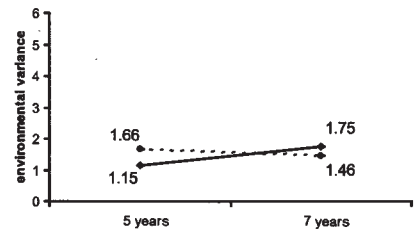
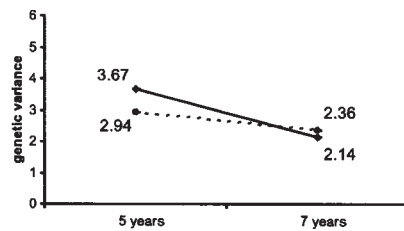
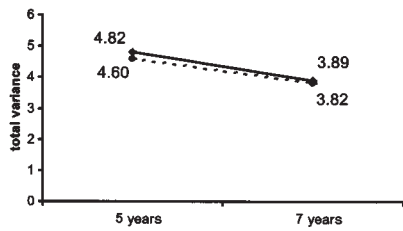
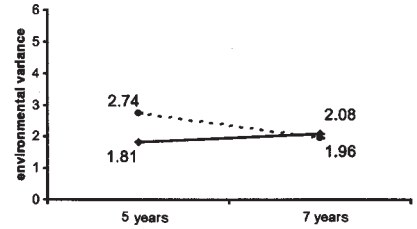
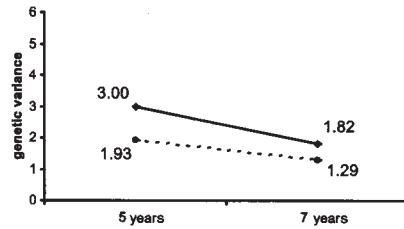
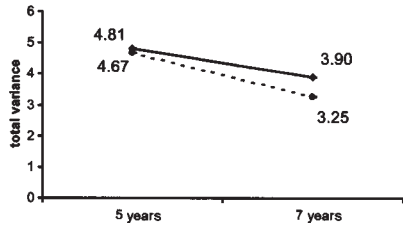
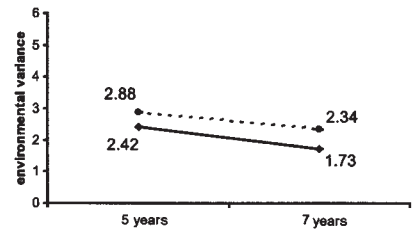
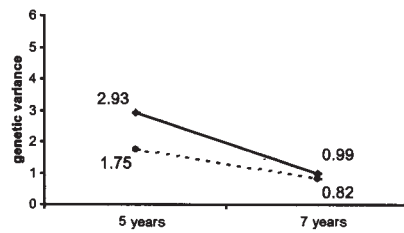
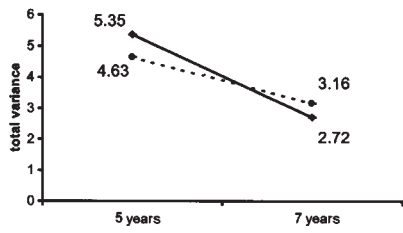

Fig. 4. Age-related changes in mean values of EEG coherence, heritabilities, total reliable variances, genetic variances, and environmental variances for left hemisphere (solid line) and for right hemisphere (dashed line).



Total Variance

Genetic Variance

Environmental Variance

Fig. 4. (Continued)

Table III. The First Column $\Delta\chi^2 df = 1$, between a Model with Common and Specific Additive Genetic Influences (AcAs) and a Model Without Specific Influences (Ac). The Second Column Shows Estimates of (Additive) Genetic Correlations Between EEG Coherences at Ages 5 and 7 Years Based on a Model with Common and Specific Additive Genetic Influences

		χ^2 differences ($df = 1$)	Genetic correlations
Fp-F	Left	3.77	.66 (.36–1.00)
	Right	0.04	.92 (.47–1.00)
Fp-C	Left	2.87	.82 (.59–1.00)
	Right	0.10	.94 (.65–1.00)
Fp-P	Left	6.23*	.76* (.56–.94)
	Right	4.82*	.78* (.56–.97)
Fp-O	Left	0.10	.98 (.78–1.00)
	Right	0.16	.96 (.74–1.00)
F-O	Left	3.20	.83 (.62–1.00)
	Right	4.23*	.75* (.50–.99)
C-O	Left	9.70*	.74* (.56–.90)
	Right	17.09*	.65* (.47–.80)
P-O	Left	6.05*	.65* (.37–.92)
	Right	8.97*	.58* (.34–.79)

*Significant age specific genetic influences, $\alpha = .05$.

direction (Fp-F and Fp-P) decreased from age 5 to age 7 years. Corresponding right hemispheric coherence heritabilities, however, did not change with age. Heritabilities in the right hemisphere increased for all posterior to anterior coherences (Fp-O, F-O, C-O and P-O), but showed no significant age-related change in heritabilities for the corresponding left hemispheric coherences (except for occipital to parietal EEG coherence, which reached significance exactly at the 0.05 level).

These age-related changes in heritabilities largely reflect changes in genetic and environmental variances (see columns 4 and 5 of Fig. 4). Genetic variances decreased strongly in left hemispheric anterior to posterior coherences (prefrontal to frontal, central and parietal connections) but increased in right hemispheric posterior to anterior coherences (occipital to parietal, central and prefrontal connections). No differences (based on confidence intervals of estimates) of genetic variances of other EEG coherences were found (except a decrease in right prefronto-frontal genetic variance). Environmental variances decreased substantially for right hemispheric posterior to anterior EEG coherences, as well as for left parieto-occipital, prefronto-frontal, and right prefronto-central EEG coherences.

These changes in genetic and environmental variances result in changes in total variances, as shown in the column 3 of Fig. 4. One might expect that these differences in total variances reflect differences in mean

values of EEG coherences, thus asking for joint modelling of means and variances (Dolan *et al.*, 1991). However, the age-related changes in mean coherences (column 1, Fig. 4) show a different pattern than age related changes in total variances, and most certainly a different pattern than age-related changes in genetic and environmental variances. Therefore, we did not pursue this type of analyses.

Genetic Correlations Between Ages 5 and 7 Years

In the last column of Table III, genetic correlations between EEG coherences at ages 5 and 7 are shown. The significant estimates of genetic correlations (for prefronto-parietal, centro-occipital, parieto-occipital, and right fronto-occipital EEG coherences) ranged from 0.58 to 0.78.

DISCUSSION

This study examined EEG coherence in 209 young twin pairs at age 5 and again 1.5 years later, at approximately 7 years. Thatcher and colleagues (1987; 1991; 1994a; 1994b) have shown this to be a period of major changes in cortico-cortical connectivity, as indexed by EEG coherence. This was largely substantiated by the results of the present study: We found increasing right prefronto-frontal coherences, no changes in prefronto-central connections, and decreases in all longer distance and posterior EEG coherences. Thatcher *et al.* (1987) showed that during the entire development of coherence from year 1 to 17, the coherence changes from age 5 to age 7 appear to constitute a clear “growth spurt.” This ties in well with the idea that in early development, a genetically mediated overabundance of synaptic contacts is followed by a “pruning” of the nonfunctional part of these synaptic contacts (Changeux and Danchin, 1976; Changeux and Dehaene, 1989; Chugani, 1998). The main goal of this paper was to study the changes in genetic and/or environmental contributions to EEG coherence in this period by using the twin methodology.

Heritability of EEG Coherence

As a first step, we established heritability at both ages. At age 5, heritabilities ranged from 44% to 76% in the left hemisphere (average $h^2 = 61\%$) and from 38% to 64% in the right hemisphere (average $h^2 = 49\%$). At age 7 heritabilities ranged from 37% to 74% in the left hemisphere (average $h^2 = 59\%$), and from 25% to 85% in the right hemisphere (average $h^2 =$

62%). The evidence of substantial heritability of coherence conforms with previous studies by others in groups of children of the same age (Ibatoullina *et al.*, 1994) or in adolescents (van Beijsterveldt *et al.*, 1998). The genetic effects on coherence may take many forms. They could operate through proteins (e.g., oligodendrocyte-specific proteins) affecting axon diameter, ion channel density and myelination (Griffiths *et al.*, 1995; Ikenaka and Kagawa, 1995), or through proteins (e.g., growth factors) affecting various aspects of synaptic connectivity like synaptogenesis, axonal sprouting, expansion of existing synaptic terminals (Klintsova and Greenough, 1999; Thatcher, 1994a).

At both ages, the strength of the genetic influences increased with electrode distance. A previous report on EEG coherence at age 5 years (van Baal *et al.*, 1998) had already hinted at this. Assessment of measurement error in that study, however, was not integrated in the structural models as was done in the analyses of the present paper. It proved necessary to take reliability into account when comparing heritabilities of long- and short-distance coherences: Split-half correlations ranged from .92 for the shortest cortico-cortical connections to .57 for longest cortico-cortical connections. When measurement error was accounted for, higher heritabilities were found for longer-distance coherences compared to shortest-distance coherences at both ages. A possible explanation for the different heritabilities is a fundamental difference in the nature of short and long EEG coherences. The “two-compartment” model of EEG coherence (Szentagothai, 1978; Thatcher *et al.*, 1986), based on the structural properties of the human cortex, proposes a compartment A that receives input from the short fiber system, that is, from axonal connections of neighboring pyramidal cells. Compartment B receives input from the long fiber system, which contains long-distance axonal connections from other parts of the brain and represents the majority of the white matter fibers. Both systems contribute to EEG coherence at relatively short distances (i.e., a few centimeters), whereas EEG coherence at the longer distances is influenced by the long-distance fiber system only.

Our data suggest that, apart from the extent of their influence, the nature of the genetic factors may also differ for short- and long-distance connections. Inspection of twin- and cross-correlations and model-fitting results suggests that, mainly for longer-distance connections of the prefrontal cortex to other areas of the brain, the genetic influences were not entirely additive in nature. Interactions between alleles at the same locus (dominance) or interaction between alleles at different loci (epistasis) may be important. Such non-additive genetic

influences are difficult to detect. Although the number of subjects in the present study is substantial for a psychophysiological study, substantially more subjects would be needed to gain statistical power to detect dominance (Posthuma and Boomsma, 2000). This might be achieved using a multivariate approach with EEG coherences from many more electrode combinations, preferably using a more dense electrode array.

Change in Genetic Architecture From Ages 5 to 7

In the 1.5 years between the first and second measurements, heritabilities significantly increased for anterior to posterior connections in the left prefrontal cortex, whereas they decreased for all posterior to anterior connections in the right occipital cortex (see Table III). The decrease in heritabilities in the left hemisphere was driven by a strong reduction in the genetic variance from age 5 to 7, possibly reflecting a decrease in synaptogenesis for these connections. The increase in heritabilities in the right hemisphere reflected a reduction in environmental variance paired to an increase in genetic variance, which might be interpreted as a shift from substantial reorganization through pruning to a more static state of the brain. In addition to these topographically differentiated changes in heritabilities of EEG coherence, impressive changes in the genetic architecture were found. We demonstrated the emergence of new additive genetic factors at age 7 for central-occipital and parietal-occipital coherences in both left and right hemispheres. The topography of the emerging factors suggest that they could reflect the maturation of the visual “dorsal stream” (Ungerleider and Haxby, 1994), i.e., the connection of somatosensory and motor areas to the visual association cortices in the posterior parietal cortex. In line with this explanation, the newly emerging additive genetic factors at age 7 found for left and right prefronto-parietal coherences could reflect the spatiovisual rehearsal loop connecting the dorsal stream to the dorsolateral prefrontal cortex (Ungerleider *et al.*, 1998). Taking this even further, the maturation of the dorsal stream of the visual system could be a necessary qualitative change in brain architecture for the development of the Piagetian concepts of conservation ability and object permanence that arise around this age (Piaget, 1966; Piaget and Inhelder, 1969). This is mere conjecture at present. However, the topographically differentiated changes in heritability and the emergence of new genetic factors do clearly support the idea of a growth spurt in brain connectivity in this age period.

EEG Coherence as an Endophenotype

EEG coherence could be a valuable endophenotype for future genomic searches on cognitive ability. In this study, we have now provided extensive documentation of short-term (split-half) reliability, long-term (1.5 year test-retest) stability and heritability of intrahemispheric EEG coherence. Reliability (split-half) appears excellent for short distances. It is somewhat lower for long distances but still compares favorably to reliability of behavioral measures, such as questionnaire data. Although stability (over 1.5 years) was low to moderate for some of the EEG coherences, genetic modeling and explicitly taking measurement error into account showed that the influence of the common genetic factors was highly stable over time. This also applied to the parieto-occipital connections despite the emergence of additional genetic factors. Indeed, estimates of genetic correlations between both ages were 0.72 on average and always above 0.58. The major criticism of EEG coherence—that it only reflects volume conduction (French and Beaumont, 1984)—is very difficult to reconcile with the topographic differences in genetic architecture. For instance, if EEG coherence reflects only volume conduction, changes in heritability from age 5 to age 7 should have been equal for the same distances, regardless of which brain areas are involved. Clearly, they were not. Our study, therefore, provides further cause to accept intrahemispheric EEG coherence as a trait of interest to the study of brain development.

Although reliable and heritable, a crucial test of its content validity, e.g., the existence of a causal relationship between EEG coherence and cognitive function, is still missing. In the longitudinal data from the Colorado Adoption Project (Cherny and Cardon, 1994) heritability of childhood IQ was shown to increase after 4 years of age. More important, their data showed that new genetic factors were emerging somewhere between ages 4 and 7. This led us to expect that the newly emerged genetic factors in EEG coherence could be related to those seen in the genetic determination of IQ. However, genetic analyses of full scale IQ in this sample at ages 5 and 7 did not yield evidence of new genetic factors (Boomsma and van Baal, 1998). At the same time, preliminary results show low but consistent negative correlations between prefronto-cortical EEG coherences and various (performal) IQ subtests exist at ages 5 and 7 years (van Baal *et al.*, in press). Future bivariate longitudinal studies should resolve this apparent discrepancy.

In summary, from age 5 to age 7 changes in heritabilities of EEG coherence were found that showed clear differentiation as a function of area (prefronto-cortical versus occipito-cortical connections) and hemisphere. These changes are compatible with the idea that different functional modules in the brain follow a different maturational program. In addition, our data also show that new genetic influences emerge at age 7 years that were not yet present at 5 years. This adds to evidence for a genuine, qualitative growth spurt in brain development during this period. EEG coherence is a promising endophenotype to detect genes that influence the maturation of brain connectivity.

ACKNOWLEDGMENTS

The authors would like to express their appreciation to Prof. Dr. N.G. Martin and Dr. A.P. Anokhin for their comments on an earlier draft of this manuscript. We are also very grateful to Prof. Dr. P.G.M. Molenaar and Drs. R.Th. Nieuwboer for resolving methodological and technical issues. Finally, we owe a special debt of gratitude to S. Kramer and C. Woudstra, who assisted in data collection. This research was supported by a grant of the Netherlands Organization for Scientific Research (NWO), no. 575-65-052, by the Human Frontier Science Project Organization (HFSP), no. rg0154/1998-B and by a grant of the Van Coeverden Adriani Stichting.

REFERENCES

- Boomsma, D. I., and van Baal, G. C. M. (1998). Genetic influences on childhood IQ in 5- and 7-year old Dutch twins. *Dev. Neuropsychol.* **14**:115–126.
- Boomsma, D. I., Orlebeke, J. F., and van Baal, G. C. M. (1992). The Dutch Twin Register: Growth data on weight and height. *Behav. Gen.* **22**:247–251.
- Brillinger, D. (1975). *Time series. Data analyses and theory*. London, Holt, Rinehart and Winston.
- Changeux, J., and Danchin, A. (1976). Selective stabilisation of developing synapses as a mechanism for the specification of neuronal networks. *Nature* **264**:705–712.
- Changeux, J., and DeHaene, S. (1989). Neuronal models of cognitive functions. *Cognition* **33**:63–109.
- Chen C., and Tonegawa S. (1997). Molecular genetic analysis of synaptic plasticity, activity-dependent neural development, learning, and memory in the mammalian brain. *Ann. Rev. Neurosci.* **20**:157–184.
- Cherny, S., and Cardon, L. (1994). General cognitive ability. In J. DeFries, R. Plomin and D. Fulker (eds.), *Nature and nurture during middle childhood*. Oxford, Blackwell Publishers, pp. 46–50.
- Chugani, H., Phelps, M., and Mazziotta, J. (1987). Positron emission tomography study of human brain functional development. *Ann. Neurol.* **22**:487–497.

- Chugani, H. (1994). Development of regional brain glucose metabolism in relation to behavior and plasticity. In G. Dawson, and K. Fischer (eds.), *Human behavior and the developing brain*. New York, Guilford, pp. 153–175.
- Chugani, H. (1998). Biological basis of emotions: Brain systems and brain development. *Pediatrics* **102**:1225–1229.
- Courchesne, E., Chisum, H. J., Townsend, J., Cowles, A., Covington, J., Egaas, B., Harwood M., Hinds, S., and Press, G. A. (2000). Normal brain development and aging: Quantitative analysis at in vivo MR imaging in healthy volunteers. *Radiology* **216**(3):672–682.
- Dolan, C. V., Molenaar, P. C. M., and Boomsma, D. I. (1991). Simultaneous genetic analysis of longitudinal means and covariance structure in the simplex model using twin data. *Behav. Gen.* **21**:49–65.
- Falconer, D. S., and Mackay (1996). *Introduction to quantitative genetics* (4th ed.). New York, Wiley.
- French, C., and Beaumont, J. (1984). A critical review of EEG coherence studies of hemispheric function. *Int. J. Psychophysiol.* **1**:241–254.
- Giedd, J. N., Blumenthal, J., Jeffries, N. O., Castellanos, F. X., Liu, H., Zijdenbos, A., Paus, T., Evans, A. C., and Rapoport, J. L. (1999). Brain development during childhood and adolescence: A longitudinal MRI study. *Nat. Neurosci.* **2**:861–863.
- Goldman-Rakic, P. (1987). Development of cortical circuitry and cognitive function. *Child Dev.* **58**:601–622.
- Greenough, W., Black, J., and Wallace, C. (1987). Experience and brain development. *Child Dev.* **58**:539–559.
- Griffiths, I. R., Montague, P., and Dickinson, P. (1995). The proteolipid protein gene. *Neuropathol. Appl. Neurobiol.* **21**:85–96.
- Gur R. C., Turetsky B. I., Matsui, M., Yan, M., Bilker, W., Hughett, P., and Gur, R. E. (1999). Sex differences in brain gray and white matter in healthy young adults: correlations with cognitive performance. *J. Neurosci.* **19**:4065–4072.
- Huttenlocher, P. (1979). Synaptic density in human frontal cortex: Developmental changes and effects of aging. *Brain Res.* **163**:195–205.
- Huttenlocher, P. (1990). Morphometric study of human cerebral cortex development. *Neuropsychologia* **28**:517–527.
- Huttenlocher, P. (1994). Synaptogenesis in human cerebral cortex. In G. Dawson and K. Fischer, W. (eds.), *Human behavior and the developing brain*. New York, Guilford, pp. 137–152.
- Ibatoullina, A., Vardaris, R., and Thompson, L. (1994). Genetic and environmental influences on the coherence of background and orienting response EEG in children. *Intelligence* **19**:65–78.
- Ikenaka, K., and Kagawa, T. (1995). Transgenic systems in studying myelin gene expression. *Dev. Neurosci.* **17**:127–136.
- Jasper, H. (1958). Report of the committee on methods of clinical examination in electroencephalography. *Electroenceph. Clin. Neurophysiol.* **10**:370–375.
- Jernigan, T., Archibald, S., Berhow, M., Sowell, E., Foster, D., and Hesselink, J. (1991). Cerebral structure on MRI: I, Localization of age-related changes. *Biol. Psychiat.* **29**(1):55–67.
- Kaiser, J., and Gruzelier, J. (1996). Timing of puberty and EEG coherence during photic stimulation. *Int. J. Psychophysiol.* **21**:135–149.
- Klintonova, A. Y., and Greenough, W. T., (1999). Synaptic plasticity in cortical systems. *Curr. Opin. Neurobiol.* **9**:203–208.
- Martin, N. G., Eaves, L. J., Kearsley, M. J., and Davies, P. (1978). The power of the classical twin study. *Heredity* **40**:97–116.
- Mather, K., and Jinks, J. L. (1977). *Introduction to biometrical genetics*. London, Chapman and Hall.
- Neale, M. C., and Cardon, L. R. (1992). Methodology for genetic studies of twins and families. In *Series D: Behavioral and Social Sciences*. Dordrecht: Kluwer Academic Publishers.
- Neale, M., and Miller, M. (1997). The use of likelihood-based confidence intervals in genetic models. *Behav. Gen.* **27**:113–120.
- Neale, M. C., Boker, S. M., Xie, G., and Maes, H. H. (1999). *Mx: Statistical Modeling*. (5th ed.). Box 126 MCV, Richmond, VA 23298: Department of Psychiatry.
- Niedermeyer, E., and Lopes da Silva, F. (1993). *Electroencephalography: Basic principles, clinical applications and related fields* (3rd ed.). Baltimore: Williams and Wilkins.
- Nunez, P. (1981). *Electric fields of the brain. The neurophysics of EEG*. New York, Oxford University Press.
- Paus, T., Zijdenbos, A., Worsley, K., Collins, D. L., Blumenthal, J., Giedd, J. N., Rapoport, J. L., and Evans, A. C. (1999). Structural maturation of neural pathways in children and adolescents: In vivo study. *Science* **283**:1908–1911.
- Pfefferbaum, A., Mathalon, D., Sullivan, E., Rawles, J., Zipursky, R., and Lim, K. (1994). A quantitative magnetic resonance imaging study of changes in brain morphology from infancy to late adulthood. *Arch. Neurol.* **51**(9):874–887.
- Piaget, J. (1966). *The psychology of intelligence*. Totowa, NJ, Littlefield, Adams.
- Piaget, J., and Inhelder, B. (1969). *The psychology of the child*. New York: Basic Books.
- Pivik, R., Broughton, R., Coppola, R., Davidson, R., Fox, N., and Nuwer, M. (1993). Guidelines for the recording and quantitative analysis of electroencephalographic activity in research contexts. *Psychophysiology* **30**:547–558.
- Posthuma D., and Boomsma, D. I. (2000). A note on the statistical power in extended twin designs. *Behav. Gen.* **30**:147–158.
- Reiss, A. L., Abrams, M. T., Singer, H. S., Ross, J. L., and Denckla M. B. (1996). Brain development, gender and IQ in children: A volumetric imaging study. *Brain* **119**:1763–1774.
- Szentagothai, J. (1978). The neural network of the cerebral cortex: A functional interpretation. *Proc. Royal Soc. London* **201**:219–248.
- Thatcher, R. W., Krause, P., and Hrybyk, M. (1986). Cortico-cortical associations and EEG coherence: A two-compartmental model. *Electroenceph. Clin. Neurophysiol.* **64**:123–143.
- Thatcher, R. W., Walker, R., and Guidice, S. (1987). Human cerebral hemispheres develop at different rates and ages. *Science* **236**:1110–1113.
- Thatcher, R. W. (1991). Maturation of the human frontal lobes: Physiological evidence for staging. *Dev. Neuropsychol.* **7**(3):370–394.
- Thatcher, R. W. (1992). Cyclic cortical reorganization during early childhood. *Brain Cog.* **20**:24–50.
- Thatcher, R. W. (1994a). Psychopathology of early frontal lobe damage: Dependence on cycles of development. *Dev. Psychopathol.* **6**:565–596.
- Thatcher, R. W. (1994b). Cyclic cortical reorganization, origins of human cognitive development. In G. Dawson and K. Fischer (eds.), *Human behavior and the developing brain*. New York, Guilford, pp. 232–266.
- Ungerleider, L. G., and Haxby, J. V. (1994). What and where in the human brain. *Curr. Opin. Neurobiol.* **4**:157–165.
- Ungerleider, L. G., Courtney, S. M., and Haxby, J. V. (1998). A neural system for human visual working memory. *Proc. Natl. Acad. Sci. USA* **95**:883–890.
- van Baal, G. C. M., de Geus, E. J. C., and Boomsma, D. I. (1996). Genetic architecture of EEG power spectra in early life. *Electroenceph. Clin. Neurophysiol.* **98**(6):1–13.
- van Baal, G. C. M., de Geus, E. J. C., and Boomsma, D. I. (1998). Genetic influences on EEG coherence in 5-year-old twins. *Behav. Gen.* **28**:9–19.
- van Baal, G. C. M., Boomsma, D. I., and de Geus, E. J. C. (in press). Genetics of electroencephalographic coherence and intelligence in young twins (abstract). *Behav. Gen.*
- van Beijsterveldt, C. E. M., Molenaar, P. C. M., de Geus, E. J. C., and Boomsma, D. I. (1998). Genetic and environmental influences on EEG coherence. *Behav. Gen.* **20**:443–453.