

10-7-2014

Self-Control and Alcohol Expectancies

John M. Ray

University of South Florida, jmray3@mail.usf.edu

Follow this and additional works at: <https://scholarcommons.usf.edu/etd>

Part of the [Clinical Psychology Commons](#)

Scholar Commons Citation

Ray, John M., "Self-Control and Alcohol Expectancies" (2014). *Graduate Theses and Dissertations*.
<https://scholarcommons.usf.edu/etd/5567>

This Dissertation is brought to you for free and open access by the Graduate School at Scholar Commons. It has been accepted for inclusion in Graduate Theses and Dissertations by an authorized administrator of Scholar Commons. For more information, please contact scholarcommons@usf.edu.

Self-Control and Alcohol Outcome Expectancies

by

John M. Ray

A dissertation submitted in partial fulfillment
of the requirements for the degree of
Doctor of Philosophy
Department of Psychology
College of Arts and Sciences
University of South Florida

Major Professor: Mark Goldman, Ph.D.
David Drobles, Ph.D.
James Epps, Ph.D.
Paul Greenbaum, Ph.D.
Geoff Potts, Ph.D.
Kevin Thompson, Ph.D.

Date of Approval:
October 7, 2014

Keywords: alcohol expectancies, self-control, decision making, regulation, moderated mediation

Copyright © 2014, John M. Ray

Table of Contents

List of Tables	vi
List of Figures	vii
Abstract	viii
Introduction	1
The Resource Model of Self-Control	2
A Process Model of Self-Control	4
Expectancies as Process	5
Theoretical Convergence	6
Self-Control and Drinking Research	9
Conditional Relationships	12
Summary	14
The Present Study	15
Specific Aims and Hypotheses	20
Method	21
Experimental Design and Overview	22
Participants	22
Measures	23
Phase 1: Screening measures	23
Demographics Questionnaire	23
Drinking Style Questionnaire	23
Alcohol Expectancy Multiaxial Assessment – Short Form	23
Phase 2: Laboratory Measures	23
Affect Grid	23
Memory Association Task	24
Emotion Suppression Manipulation Check	24
Exertion Assessment	24
Phase 3: Taste Test	25
Effects of Alcohol Questionnaire	25
Alcohol Expectancy Questionnaire	25
UPPS Impulsive Behavior Scale	25
Temptation and Restraint Inventory	26
Procedure	26
Recruitment	26
Phase 1: Online/Field Screening	27
Phase 2: Laboratory Study	27
Self-Control Manipulations	28

Manipulation Checks	29
Expectancy Manipulation	29
Phase 3: Taste Test	30
Expectancy Measure	30
Taste test	30
Results	33
Recruitment and Screening	33
Sample Characteristics	37
Manipulation Checks	38
Aim 1	39
Hypothesis 1	39
Hypothesis 2	41
Aim 2	42
Hypothesis 3	42
Hypothesis 4	43
Aim 3	44
Hypothesis 5	44
Hypothesis 6	46
Exploratory Analyses	46
Aim 4	53
Hypothesis 7	53
Discussion	59
Power Concerns	61
Limitations	65
Conclusion	66
References	68
Appendices	77
Appendix A: Demographics Questionnaire	78
Appendix B: Drinking Style Questionnaire	79
Appendix C: Alcohol Expectancy Multi-Axial Assessment – Short	80
Appendix D: Affect Grid	81
Appendix E: Memory Association task (Expectancy Prime)	84
Appendix F: Emotion and Thought Suppression Manipulation Check	85
Appendix G: Exertion Assessment	86
Appendix H: Effects of Alcohol/Soda/Sports Drinks	87
Appendix I: Alcohol Expectancy Questionnaire	90
Appendix J: UPPS-P	93
Appendix K: The Temptation and Restraint Inventory	96
Appendix L: Recruitment Flyer	97
Appendix M: Informed Consent Documents	98
Appendix N: Self-Control Task Instructions	107
Appendix O: Taste Test Script	108

Appendix P: Beverage Evaluation Form
Appendix Q: Debriefing Script

110
112

List of Tables

Table 1:	Experimental Conditions	17
Table 2:	Total Recruitment Numbers	36
Table 3:	Chi-Square tests of group independence	38
Table 4:	Correlation/Covariance Matrix for Self-Reported Alcohol Consumption and Expectancies	39
Table 5:	One -Way ANOVA with Planned Comparisons	40
Table 6:	Conditional indirect effect at each level of the moderator with bootstrap 95% confidence intervals	64

List of Figures

Figure 1: Hypothesized relationships to be tested between primary variables of interest	16
Figure 2: 2 (self-control) by 2 (expectancy) design, with alcohol consumption as the outcome variable	19
Figure 3: Hypothesized consumption in the taste test by group and temptation; SC: self-control depletion; Exp: expectancy prime; TT: trait temptation to drink	19
Figure 4: Schematic timeline of study procedures with approximate duration in minutes	28
Figure 5: Total drink consumed by self-control condition	41
Figure 6: Total drink consumed by Expectancy condition	42
Figure 7: Total drink consumed by Condition	43
Figure 8: Total drink consumed by Condition, showing ceiling effect	45
Figure 9: Difficulty Controlling on Total Drink Consumed by Self-Control	48
Figure 10: Total drink consumed on effect of alcohol ratings by depletion condition	49
Figure 11: Additive effects of condition on total drink consumed by alcohol effects ratings	50
Figure 12: Unexpected pattern of Difficulty Controlling to Expectancies relationship by Condition	51
Figure 13: Causal steps mediation analysis	53
Figure 14: Mediation effect bar plot showing the mediation effect size against the direct effect on a scale of zero to the maximum mediation effect possible	56
Figure 15: Conditional indirect effect at each level of the moderator with bootstrap 95% confidence band	58

Abstract

Research on self-control suggests that people do not do as well at self-control after they have already exerted self-control on something else. Despite the obvious importance of self-control in drinking behavior, few studies have examined alcohol consumption as an outcome measure in the context of self-control depletion and the potential role of cognitive processes in the self-control to drinking relationship remains largely unexplored. Although it is widely agreed that alcohol expectancies play an important role in one's decision to drink, no study has examined the role of expectancies in self-control's influence on drinking. This study addresses this important gap in the research by testing whether positive expectancies for alcohol influence the relationship between self-control depletion and placebo alcohol consumption in the laboratory. Results offer support for the resource model of self-control depletion in the context of drinking decisions; participants in the depleted self-control condition drank more placebo alcohol despite being reminded to be ready for an upcoming memory task. Hypotheses of conditional and indirect effects consistent with a process model of self-control were not supported. Using nonparametric analytic techniques, patterns in the data emerged suggestive of conditional indirect effects, though they appear to be very small in scale. Findings support the further exploration of the primary hypotheses, given the consideration of current limitations.

Introduction

Lack or loss of control is a hallmark of addiction, particularly when it happens despite deliberate efforts to refrain from the use of alcohol or other drugs. Even strong, conscious intentions to avoid substance use appear to be undermined by impaired self-control (Hull & Slone, 2004). Although the study of self-control is not new (e.g., Mischel et al., 1989), research on the phenomenon has been prolific since the introduction of Baumeister's resource model, which predicts that exercising self-control consumes a limited energy reserve, leaving the person depleted and prone to subsequent self-control failure (ego depletion; Baumeister, Bratslavsky, Muraven & Tice, 1998). Tests of the resource hypothesis typically utilize a sequential-task paradigm, or some variation, in which an initial self-control task is followed by a second, different one. This design has since become the model's most frequently used methodology and has demonstrated impaired self-control effects on a range of tasks and across various domains (Hagger et al., 2010). Relatively few of these studies have examined self-control in the context of substance use (e.g., alcohol), but their findings have been consistent with the broader literature, suggesting that at-risk (moderately heavy/binge-type) drinkers are more likely to consume more alcohol after exercising self-control, even if they have been provided with incentive not to drink (Christiansen, Cole & Field, 2012; Friese, Hofmann & Wanke, 2008; Muraven, Collins & Nienhaus, 2002; Ostafin, Marlatt & Greenwald, 2008).

The lion's share of self-control research in the last decade-and-a-half has been focused on characterizing the resource model and establishing the range of domains to which it applies.

More recently, some research within this line has been focused on the process of self-control depletion effects. For example, one new theoretical approach posits that self-control impairment may be a function of automatic information processing biases that shift motivation and attention away from restraint and toward immediate reward (see Inzlicht & Schmeichel, 2012). The mechanisms proposed to underlie this process view of self-control effects are consistent with the anticipatory processing mechanisms at the core of expectancy theory. This study aims to contribute to the study of self-control processes by examining the role of alcohol expectancies in the self-control – drinking relationship. A clearer understanding of these processes and related individual differences may help addiction researchers develop more effective prevention and intervention techniques.

The Resource Model of Self-Control

Over the past fifteen years, research using the sequential-task self-control depletion paradigm has demonstrated consistently that self-control exertion leads to impaired self-control on a later, unrelated task and these results have most often been attributed to a theoretical, depletable resource (Baumeister, 2003). One prominent hypothesis holds that self-control consumes glucose, which is also needed for other executive functioning processes, and that this leads to observed indices of self-control impairment, such as impulsive behavior (Gaillot & Baumeister, 2007). The glucose hypothesis intuitively fits with the findings on self-control depletion effects, but evidence suggests that glucose consumption is not reliably related to self-control processes per se (Beedie & Lane, 2012).

An alternative explanation to glucose mediation comes from studies examining self-control expectancy as a potential mediator of depletion effects. In these models, participants' expectancies about their ability to control their own behavior are thought to be the causal factor

in self-control depletion effects. Indeed, several studies suggest that self-control depletion may be “all in one’s head.” First, depletion effects have been shown to occur only for those who expect a task to be depleting (Martijn, Tenbult, Merckelbach, Dreezens & de Vries, 2002). Then, beyond expectations related to task characteristics, Ackerman et al. (2009) found that leading participants to believe that self-control itself is limitless effectively eliminated depletion effects. Finally, simply suggesting to participants that their self-control has been restored appears to even reverse the effects of self-control depletion (Job, Dweck & Walton, 2010). Put briefly, the reliably replicated effects seen in the sequential-task self-control depletion paradigm appears to be dependent upon participants’ expectancies about self-control availability and efficacy, which themselves do not depend on a depletable resource.

The studies just described point to a role for cognitive processes in self-control effects. Specifically, and perhaps more importantly, they hint at an instance of anticipatory information processing posited to be ubiquitous in reinforcement learning (Goldman, Darkes, Reich, & Brandon, 2006). Whereas evidence of a causal role for anticipatory cognitive processes in self-control has yet to be demonstrated, theory and extant research from other domains suggests it may be found (Bolles, 1972; Goldman, 2002). Self-control availability and one’s perceptions of it, for example, may behave similarly to critical processes to which humans develop non-volitional response expectancies, such as emotion and cues for sexual opportunity (Kirsch, 1995). In this way, information processing in a self-control context should be sensitive to environmental cues and expectations about associated outcomes, just like situations involving social interactions (Rotter, 1982), food (Smith, Simmons, Flory, Annus, & Hill, 2007) or alcohol (Goldman, Darkes, & Del Boca, 1999); indeed, perhaps especially such situations.

A Process Model of Self-Control

Although the self-control depletion research effort has struggled to provide reliable evidence for the resource model (Hagger, Wood, Stiff & Chatzisarantis, 2010; Molden et al., 2012), some intriguing findings from this line have pointed to an important role for information processing in the influence of self-control exertion on subsequent self-control effort. Research reviewed by Inzlicht & Schmeichel (2012) suggests that self-control may lead to a shift away from restraint and toward gratification via motivation and/or attention.

Self-control requires intent to inhibit (motivation) and discrepancy monitoring (attention) between current and desired states, both of which can operate consciously and automatically (Carver & Scheier, 1981). On one hand, shifts in motivation are hypothesized to occur in self-control studies because the hard work of self-control is often not rewarded; participants may implicitly “see no benefit” in continuing to work for no pay, or “feel” entitled then to reduce their effort generally, analogous to taking a break or doing something fun. But consecutive self-control tasks can include competing reward contingencies (e.g., immediate reward paired with incentive to delay gratification), which comprise a burden on decision making processes that may induce a cognitive state thought to engage more efficient, automatic processing strategies biased toward more proximal reward (Bargh & Chartrand, 1999; Shiffrin & Schneider, 1977). If self-control exertion prompts a motivational shift toward gratification, as in either case above, people might be especially sensitive to individually preferred rewards, such as cookies for dieters (e.g., Baumeister et al., 1998) or alcohol for drinkers (e.g., Muraven et al., 2002), as a function of their associations with pleasure, or reward.

On the other hand, self-control may lead to a shift of attention from discrepancy monitoring to reward-associated cues. Self-control is goal-oriented and attention serves to track movement toward or away from a goal (Wegner, 1994). If self-control shifts attention toward

reward-cues in the environment, attention cannot then also track discrepancies (errors) between the goal and behavior, potentially leaving self-control effectively abandoned. Again, attention may be more sensitive under such conditions to individually salient reward (e.g., escape, food, alcohol).

One important implication of an information processing hypothesis is that it does not require that anything be depleted – people still have the ability to self-control even if they are motivated not to. Another is that the ostensibly orthogonal constructs of motivation and attention are handled parsimoniously by expectancy theory as interdependent components of broader anticipatory processing (Goldman et al., 2006).

Expectancies as Process

Alcohol expectancies represent anticipatory associations between drinking and its consequences, negative and positive, and have been shown to predict alcohol consumption via both deliberative (explicit) and automatic (implicit) measures. Automatic mental processes, as defined by cognitive psychology (Shiffrin & Schneider, 1977), feature prominently in contemporary models of addiction (Goldman et al., 2006; Tiffany, 1990; Wiers & Stacy, 2006). Several studies have shown the proximal influence of expectancy (and similar constructs) priming on drinking behavior, even outside the awareness of participants; that is, automatically (e.g., Roehrich & Goldman, 1995; Stein et al., 2003).

Expectancies are thought to increase in strength and accessibility as a function of repeated drinking paired with desired outcomes (Goldman, 2002; Robinson & Berridge, 2003). In turn, the improved predictability of alcohol-related outcome events may decrease the deliberative input needed to activate the underlying associations and increase their likelihood of being engaged automatically (Tiffany, 1990). If the brain shifts processing strategies toward

automatic processes under conditions of high self-control load, thereby reducing the impact of deliberative processing, then the likelihood of implicit alcohol expectancy activation for heavier and/or more frequent drinkers should increase concomitantly. Put another way, the relationship between self-control and reward-based behavior may reflect a rheostatic influence on the associations, or expectancies, that link the two.

Theoretical Convergence

If self-control exertion triggers a cognitive-attentional shift toward immediate gratification, it may also serve as an interoceptive cue to activate behavioral pathways associated with positive affective states, including alcohol contingencies among heavier drinkers.

Expectancy theory predicts that alcohol-behavior associations are sensitive to internal and external cues, a position consistent with several other reinforcement models of substance use. Repeated pairings of external or internal contextual cues with alcohol consumption can link the anticipated effects of alcohol to the cue itself, as put forward by incentive-sensitization theory (Berridge & Robinson, 2003), so that alcohol effects come to be anticipated in response to the mere presence of the cue (Wise, 2002).

Similarly, a state of self-control depletion may trigger processes comparable to those described in negative reinforcement models of substance use (Baker, 2004). According to this model, initially substance-neutral interoceptive cues (e.g., negative affect) may become associated with substance use, capable of activating biased motivational and attentional (expectancy) processes that invoke pathways to learned negative affect amelioration strategies (e.g. having a drink). Although self-control depletion does not appear to be associated with self-reported changes in affect (Hagger et al., 2010), if the resulting “depleted” state is seen

(organismically) as a condition to be remedied akin to negative affect, then implicit response processes may be very similar.

That each of these models counts affect as a critical component is not surprising. Alcohol is frequently used as a vehicle to feeling better, even if among young adults this is most commonly sought via social mechanisms, to which alcohol is of course also a vehicle. The majority of the words used to describe the anticipated effects of alcohol among young adults are indicative of an affective state (e.g., happy). Even social expectancies (e.g., sociable), the most commonly cited among heavy drinking young adults, can be seen to reference affective states (i.e., those associated with social interaction; Goldman & Darkes, 2004). Thus, expectancies measured as free associate responses to a sentence stem (e.g., Drinking alcohol makes me...) can be rated on dimensions of valence and arousal to get an estimate of the word's affective value in the context of alcohol. A free associate expectancy measure may provide an advantage over other measures of alcohol association (e.g., the IAT) by allowing for person-specific words and affective ratings that add a more directly measured motivational aspect to pure association (Reich, 2005).

Just as affect is a critical component of reward contingency processes and related self-control, so is motivation. Theoretically, the expectancy construct overlaps considerably with motivation. Whereas motivation entails the process or processes that engage, guide and sustain goal-directed behavior, expectancies encompass the cognitive and affective representation of the pathway through which it operates (Goldman et al., 2006). Similarly, self-control can be seen to act as a switch at the crossover in the pathway between controlled and 'free' behavior, where motivation moves from one target to another as a function of the expected outcome and its desirability. In the context of depletion, then, self-control moderates motivation; that is, under

self-control demand, people tend to be less motivated to engage in what Inzlicht, Schmeichel & Macrae (2014) refer to intuitively as ‘have-to’ tasks, and more so in ‘want-to’ tasks.

Another approach to self-control is based in behavioral economics theory, in which self-control under demand is conceptualized as a utility function, i.e., self-control becomes untenable when its cost comes to outweigh its benefit. That is, research supports the hypothesis that self-regulation lapses not because of inability, due perhaps to depletion, but because a person makes the decision, often unconsciously, to avoid demand due to its intrinsic cost (Kool, McGuire, Wang & Broderick, 2013). This perspective is further supported by recent work drawing from economic labor supply theory. In a high- v. low-cognitive control demand context, Kool and Botvinick (2014) tested the labor supply hypothesis that, when asked to work, people tend to weigh the value of income and leisure equally. Participants worked on one intensive cognitive task, for which they were paid a wage of candies, and one leisurely task, for which they received nothing. All participants were told to spend time on each task as they pleased. After a first session, wages were adjusted and differences made up with lump-sum payments calibrated to allow the previous labor/leisure strategy to yield identical results. Despite the levelling payment, participants spent less time working and more time on the leisurely task when wages were decreased, and vice versa. Economic labor supply theory explains this finding with the joint utility function of labor and leisure, which predicts a bias toward balance of the two. But these results can also be interpreted in light of self-control theories, in that self-control decisions are may not necessarily be made according to a linear function in which cost is subtracted from benefit. Rather, the “value added” by cognitive control may vary with context, such that leisure, or the payoff of immediate reward, assumes greater value when one has already been hard at work.

Self-Control and Drinking Research

The constructs of motivation and expectancy are, of course, central to the study of addiction, a problem apparently well-suited to the exploration of self-control processes, as well. In the first study to test the self-control depletion paradigm in a substance use context (Muraven et al., 2002), male drinkers were assigned to a self-control depletion group in which they suppressed the thought of a white bear or to a control group that completed simple arithmetic. Participants were told they could win a prize by performing well on a later task and that alcohol consumption would impair their performance. All participants then completed a beer taste rating task. Results showed that the experimental group consumed more alcohol than the control group, despite the prize incentive. Further, there was an interaction of group and self-reported trait temptation to drink – within the depleted self-control group, participants higher in trait temptation consumed more beer.

The moderating effect of trait temptation to drink has a couple of important implications: First, it suggests that self-control may be at least influenced by cognitive processes. If self-control effects can be attributed to a depleted resource, how might a person's thoughts about their ability to control drinking affect that resource's levels? Second, the experimental group's focus on immediate reward suggests a shift in motivation from distal to proximal reward contingencies. Participants high in trait temptation to drink were apparently willing to sacrifice almost guaranteed but briefly delayed reward for the immediate reward of more alcohol even though, presumably, they could obtain the desired drinks on their own as soon as the experiment was over. Broadly, these implications point toward a significant role for cognitive processes in self-control depletion effects. Specifically, the moderating effect of temptation to drink in Muraven et al. (2002) may reflect the automatic influence of well-learned reward properties of

alcohol among at-risk drinkers. This is consistent with information processing theories of learning (Tversky & Kahneman, 1981) and dual processing models (Deutsch & Strack, 2006; Hasher & Zacks, 1979; Oei & Baldwin, 1994), both of which make similar predictions to those made by expectancy theory (Goldman, Darkes & Del Boca, 1999; Kirsch, 1985).

Self-control depletion researchers have acknowledged a potential role for expectancy-like constructs. Ostafin, Marlatt and Greenwald (2008) looked for evidence of “automatic alcohol-motivation associations”, which they measured using an alcohol cue version of the Implicit Association Test (IAT). Alcohol-motivation association in this study was indexed by response latency to alcohol cues paired with approach words, as opposed to non-alcohol cues and avoidance words. The motivational component of alcohol-motivation association was inferred from reduced reaction time. Ostafin et al. replicated the self-control depletion effect of Muraven et al. (2002) and, consistent with their hypotheses, IAT scores were positively related to alcohol taste test consumption in the depleted self-control condition but not in the full self-control condition. The authors concluded that, when at-risk drinkers are faced with conflicted alcohol intentions and self-control resources are low, consumption decisions are more strongly influenced by automatic than deliberative processes.

The Ostafin results suggest an important role for automatic processing in self-control effects on drinking and fit well with predictions from expectancy theory. In fact, it is not unreasonable to think that alcohol expectancies and automatic alcohol-motivation associations would behave in very similar ways in this context (indeed, they have been treated as identical constructs elsewhere; Jajodia & Ealrywine, 2003). In accordance with broader learning theory (Bandura, 1977), expectancy theory posits that associational automaticity increases with experience as a function of prior predictive accuracy (Bolles, 1972; Goldman, 2002).

Presumably, increased reaction speed is a consequence of stronger associations between the paired alcohol cues and approach-related words (Weirs, van Woerden, Smulders & De Jong, 2002b), many of which are identical to or share associative space with commonly reported alcohol expectancy words. Thus, as noted above, free associate expectancy generation may provide a more complete index of alcohol-to-outcome association.

Conditional Relationships

Whereas Ostafin et al. (2008) showed that their implicit measure of alcohol associations predicted drinking when self-control resources were limited, they found that their explicit measure of alcohol motivation did not predict drinking. Friese, Hoffman and Wanke (2008) argued that explicit evaluation of alcohol and motivation to restrict its intake are distinct constructs, i.e., restraint motivation can operate independently of whether one likes the object in question. The authors tested this hypothesis by replicating the Ostafin et al. (2008) study with the addition of a measure of drinking restraint standards. Consistent with that study, the authors found a main effect of depletion condition and no effect of explicit alcohol evaluation on drinking in either condition (although they reported a statistical trend toward prediction of alcohol consumption in the control condition). Restraint standards predicted less drinking in the control condition, suggesting an interaction of cognitive processing and self-control state – whereas controlled processes impacted drinking decisions under normal self-control load, automatic processes appeared to exert greater influence under depleted self-control conditions.

Importantly, the drinking restraint measure used in Friese et al. (2008) was comprised of restraint-specific items from the Temptation and Restraint Inventory (Collins & Lapp, 1992a), the full version of which also includes the temptation-related items used by Muraven et al. (2002). Recall that the Muraven study showed a moderating effect of trait temptation on drinking

under depleted self-control conditions, which suggested an influence of reward-sensitive implicit cognition. The restraint items from the same measure can be seen to represent an opposing force to temptation in conflicted alcohol decision-making; that is, they may be a different index of the same underlying self-control phenomenon (Collins & Lapp, 1992). This study is important because it demonstrated empirically that drinking restraint motivation and evaluation of alcohol can operate independently (a person may be motivated to avoid something they like). In this way, the Friese et al. study supports the use of an alcohol association measure that incorporates an evaluative component. Additionally, the degree of automatic processing in a decision making situation seems to depend on perceived level of self-control, with which automaticity appears to be inversely related. Further, self-control, which is dependent on deliberative processing, may be more likely to yield under such conditions to more immediate reward.

Although the studies discussed so far provide evidence of a moderating influence of alcohol cognition on self-control, one study was designed with the specific aim of causal explication. Christiansen, Cole and Field (2012) provided some support for cognitive process mediation of self-control effects by testing several hypothesized causal mechanisms: cognitive biases (alcohol-approach tendencies); executive functioning (inhibitory control, brain fatigue and impaired working memory); and self-control expectancy (self-reported effort expended). They found main effects of depletion and cognitive bias but no interaction, suggesting independent effects, and executive functioning impairment indices were unrelated to self-control depletion and alcohol consumption. None of the authors' hypothesized mediated effects were significant. However, the authors found that the effect of self-control depletion on drinking was mediated by self-reported amount of effort expended in the self-control task. This last finding suggests that cognitive factors involved in self-control's effects are multidimensional and may apply across

domains; that is, all anticipated outcomes associated with self-control, including one's perception of self-control ability, may affect any actual self-control related outcome. Indeed, expectancy theory predicts this to be the case across behavioral domains, including alcohol consumption and its anticipated outcomes (Goldman et al., 1999).

Summary

The preceding review discussed a novel information processing view of the effects observed in studies using the sequential-task self-control depletion paradigm. It was argued that these anticipatory motivational and attentional shifts away from restraint and toward more immediate reward can be conceptualized as the activation of reward-related expectancy pathways. Further, it was predicted that they should be stronger and more likely to impair self-control when a contingent reward is salient due to a history of reliable reinforcement. Put another way, it was argued that one may be more likely to violate restraint goals under ongoing self-control demand because working hard to resist temptation may implicitly move a person from deliberative decision making toward more efficient information processing strategies, especially in situations where personally salient reward is made available. For example, as a function of their expectancies, heavy drinkers should be more likely to violate drinking restraint goals and do so to a greater degree when they have exerted self-control. And this should be especially true among those who report greater difficulty resisting the temptation to drink.

The relatively few studies that have tested self-control depletion effects on drinking were reviewed and their findings summarized: (a) heavy drinkers tend to consume more alcohol ad lib when under self-control demand; (b) this effect is negatively related to a drinker's perception of his ability to resist the temptation to drink; (c) the sequential-task paradigm appears to obtain depletion effects only among those who believe that their self-control has been "used up" (the

self-control – drinking relationship may be mediated by self-control efficacy expectancies); (d) implicit measures of alcohol-related cognition appear to be positively related to ad lib drinking, while explicit measures do not; (e) drinking under self-control demand does not appear to be related to more general measures of inhibitory of control, brain fatigue, or working memory impairment. Together these findings suggest that, when measured using the sequential-task paradigm, self-control depletion effects in general occur because a participant believes he does not have any more self-control left and this leads to automatic reward bias. More specifically, because the reward bias in heavy drinkers appears to be sensitive to alcohol when it is made available following self-control exertion, it should have a stronger influence on drinking behavior among those with stronger positive expectancies for alcohol's effects. The following study is the first to test the hypothesis that alcohol expectancies mediate the temptation-moderated relationship between self-control and alcohol consumption as demonstrated in studies using the sequential-task paradigm.

The Present Study

The aim of the present study is to investigate the role of expectancies in the effect of self-control depletion on alcohol consumption. This complex relationship is modeled as moderated mediation, in which self-control depletion and trait temptation to drink interact to influence drinking through alcohol expectancies (see Figure 1).

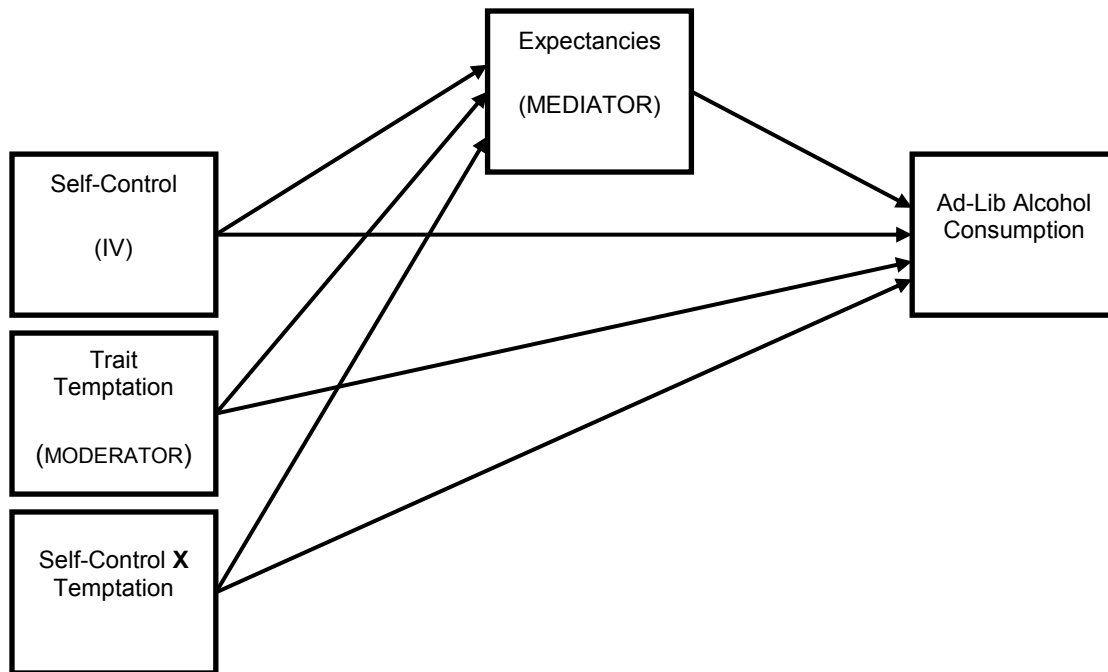

Figure 1. Hypothesized relationships to be tested between primary variables of interest.

This model was tested using a 2 (self-control) x2 (expectancy prime) factorial design, including an experimental group (Self-Control-plus-Expectancy), a self-control depletion only group, an expectancy prime only group, and a control group that received no treatment (see Table 1). This simple design was chosen because it was expected to allow for testing of all direct and indirect effects of self-control depletion and expectancies with a moderate sample size.

Although evidence suggests that expectancies play an important part in self-control's effect on alcohol-related decision making, there is a dearth of research measuring expectancies in a self-control context, i.e., under conflicted motivation (Hagger et al., 2010). Thus, several possibilities of a specific expectancy function in the self-control – drinking relationship present themselves. Self-control may moderate the

Table 1

Experimental Conditions

	<u>Depleted</u>	<u>Non-depleted</u>	
<u>Primed</u>	Self-Control-plus-Expectancy	Expectancy-only	<i>Exposed to alcohol homonyms during the memory list task</i>
<u>Non-primed</u>	Self-Control-only	No-Treatment	<i>Memory list task included only alcohol-neutral words</i>
	<i>Controlled emotions during the emotional video task and thoughts during thought-listing task</i>	<i>Video task and thought-listing task included no special instructions</i>	

effect of expectancies on drinking. In this case, given a main effect of self-control depletion, expectancies would positively predict drinking under conditions of depleted self-control. Or expectancies may moderate self-control, so that depletion effects are stronger among those with stronger expectancies for alcohol. Alternatively, expectancies may mediate the relationship between self-control and drinking, similar to dynamic relationships suggested by research on other antecedents of risky drinking (Goldman et al., 1999; Jones, Corbin & Fromme, 2001).

There is little reason to believe that strong positive expectancies alone should be sufficient to activate drinking behavior in a restraint-motivated context. For example, a heavy drinker may wish to drink, expecting it to improve his affective state, and yet be motivated to

refrain for an upcoming important business meeting. Such conflicted motivations define self-control dilemmas. However, if the same drinker on his way to an important business meeting has already spent a great deal of time and energy controlling his mood at work, he may find his ability to maintain conscious deliberation about drinking compromised; decision making previously mediated by deliberative processing may become mediated by automatic expectancy-based responses to internal or external cues as a function of reduced resources or a strategic shift to more efficient processing. That is, the effect of self-control on drinking is hypothesized to occur because a “depleted” state triggers cognitive shifts that potentiate, or “free up”, expectancy pathways that influence consumptive behavior given the opportunity to drink. Based on the predictions of expectancy theory and evidence from the studies reviewed above, this study proposes a moderated mediation model in which self-control affects drinking via alcohol expectancies, and trait temptation to drink moderates this relationship (see Figure 2).

If, as hypothesized, self-control depletion exerts its influence on drinking through the activation of expectancies, a stepped pattern of drinking should emerge (Figure 3), reflecting cumulative effects of drinking influences. Specifically, the group that receives both manipulations (Self-Control-plus-Expectancy) should consume the most alcohol as a result of the compound cueing of that condition. The Self-Control-only and Expectancy-only groups should drink similar amounts, which should be greater than the control

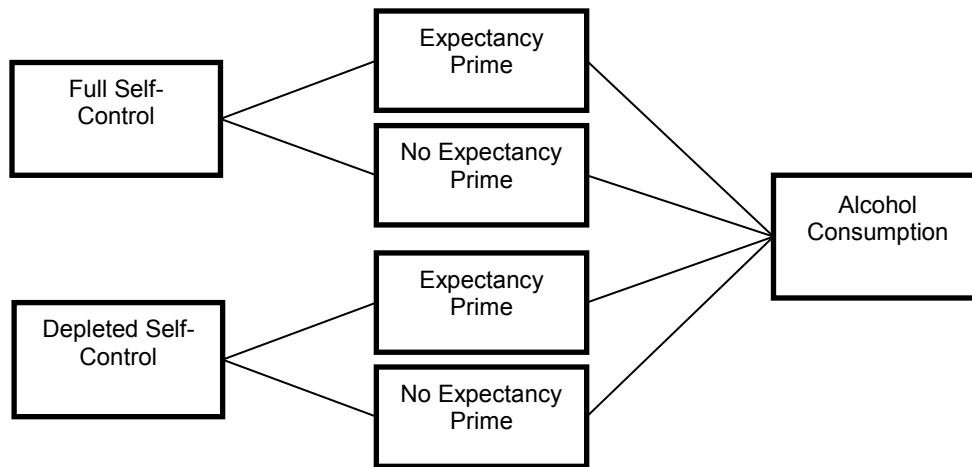

Figure 2. 2 (self-control) by 2 (expectancy) design, with alcohol consumption as the outcome variable. condition (No-Treatment). In this case, regression should reveal significant paths between self-control and drinking, expectancies and drinking, and self-control and expectancies. Additionally, the path between self-control and drinking should be moderated by trait temptation to drink, i.e., the self-control by trait temptation interaction should be related to drinking. This interaction should also be related to expectancies. Finally, the path from

Hypothesized Placebo Alcohol Consumption by Groups

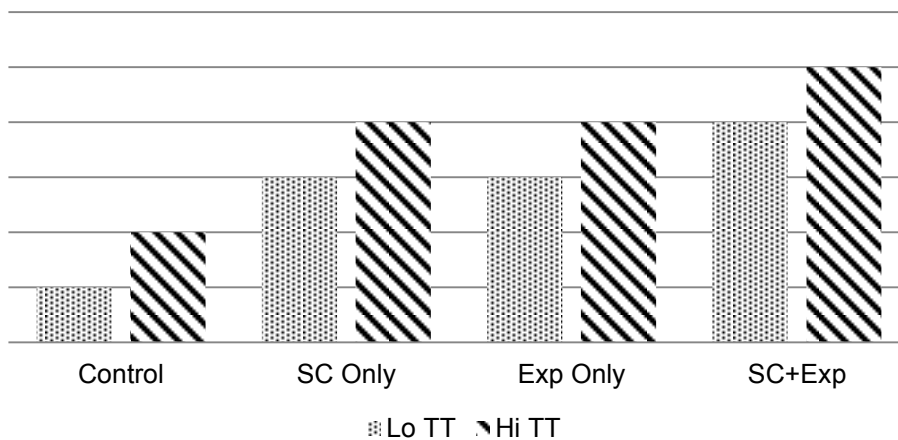

Figure 3. Hypothesized consumption in the taste test by group and temptation; SC: self-control depletion; Exp: expectancy prime; TT: trait temptation to drink

the self-control by trait temptation interaction to drinking is expected to be reduced when the indirect path through expectancies is taken into account, thereby demonstrating moderated mediation.

Specific Aims and Hypotheses

Aim 1. To replicate the main effect of self-control depletion on alcohol consumption, as well as its interaction with trait temptation to drink, within the sequential-task self-control depletion paradigm.

Hypothesis 1. There will be a main effect of self-control condition. Participants in the depleted self-control condition will drink more placebo alcohol than those in the full self-control condition.

Hypothesis 2. The main effect of condition will be qualified by an interaction between condition and trait temptation to drink. In the depleted self-control condition, but not in the full self-control condition, self-reported temptation scores will be positively related to total amount of placebo alcohol consumed.

Aim 2. To replicate the main effect of alcohol expectancy priming on alcohol consumption.

Hypothesis 3. There will be a main effect of expectancy condition. Participants in the expectancy prime condition will drink more placebo alcohol than those in the no prime condition.

Hypothesis 4. The primary independent variables will have additive effects. Participants in the self-control – expectancy prime combined group will consume more placebo alcohol than either the self-control depletion only or expectancy prime only group, and the control group should consume least of all.

Aim 3. To demonstrate the conditional relationships between self-control, trait temptation to drink, alcohol expectancies and alcohol consumption.

Hypothesis 5. Alcohol expectancy free associate ratings (valence and arousal) will be positively related to total amount of placebo alcohol consumed in the depleted self-control condition but not in the full self-control condition.

Hypothesis 6. The self-control – trait temptation to drink interaction will be positively related to alcohol expectancy free associate ratings (valence and arousal).

Aim 4. To demonstrate the mediational role of expectancies in the moderated relationship between self-control, trait temptation to drink and alcohol consumption.

Hypothesis 7. Alcohol expectancy free associate ratings (valence and arousal) will mediate the relationship between the self-control – trait temptation to drink interaction and placebo alcohol consumption.

Method

Experimental Design and Overview

This study utilized a 2 (self-control) x 2 (expectancy prime) factorial design (see Table 1), including an experimental group (Self-Control-plus-Expectancy), a Self-Control-only group, an Expectancy-only group, and a control group (No-Treatment; see Figure 1). Independent variables included self-control condition (depleted v full) and expectancy activation (primed v not primed; memory association task). Manipulation checks were conducted on self-control manipulations (emotion and thought suppression, ESM; self-perceived exertion, EA), and included a post-self-control task state affect check (Affect Grid). Dependent variables, including alcohol expectancy free associates and total volume of placebo alcohol consumed, were measured following the self-control manipulation and expectancy prime. Other variables

included demographics (age, race/ethnicity, education, annual income); self-reported alcohol consumption (quantity, frequency); alcohol expectancy endorsement; and trait temptation to drink. The combined study took approximately 60 minutes to complete.

Participants

Participants included male drinkers between 21 and 28 years old, recruited from the University of South Florida and its surrounding community. Drinkers were defined as those who reported at least two drinking occasions per week and at least three drinks per occasion, criteria consistent with the studies of self-control and drinking described above. Participants were recruited via one of three channels, including the Psychology Department Research Participation Pool (SONA), on-campus solicitation, and off-campus solicitation. Depending on recruitment mode, interested students completed screening questionnaires via SONA or Survey Monkey, or with a research assistant, if in person. Screening items included demographic information and measures of alcohol consumption behavior and expectancies. For completing the questionnaires online, participants received one-half research participation credit, using SONA, or a chance to win a \$50.00 gift card, if using Survey Monkey or in-person. All eligible participants received an invitation to participate in an ostensibly unrelated laboratory study at the University of South Florida Psychology Department for more SONA credit or another chance to win a gift card, plus a \$10.00 digital gift card from a business of their choice (from among 30). Finally, during a planned delay in the laboratory portion of the study, participants were invited to take part in a third, ostensibly unrelated study in the lab (described below), for which they would receive another chance to win a \$50.00 gift card.

Measures

Phase 1: Screening measures.

Demographics Questionnaire (DQ). The DQ is a brief questionnaire that asks for the participant's age, gender, race and ethnicity, and education level (See Appendix A).

Drinking Style Questionnaire (DSQ). The DSQ contains items assessing alcohol consumption behavior, including frequency and average quantity (See Appendix B).

Alcohol Expectancy Multiaxial Assessment – Short Form (AEMax-Short). This measure includes a list of 24 expectancy words which participants select to complete the phrase, “Alcohol makes one_____.” Participants then indicate how frequently they believe the newly constructed statement is true (7-point Likert: never to always). The AEMax has been shown to be both reliable and valid, and adequately predicts later alcohol use (Goldman & Darkes, 2004). This study will utilize the positive (higher order factor) subscales of the AEMax-short (See Appendix C).

Phase 2 Laboratory Measures.

Affect Grid (Russell et al., 1989). The Affect Grid is a single item, 9X9 grid with affect descriptors placed at each corner and in the middle of each side. Participants are asked to place an X in the square that best represents their current affective state. Based on Russell's affective circumplex (Russell, 1980), the descriptors placed around the grid define the general dimensions of Pleasure-Displeasure and Arousal-Sleepiness. These major dimensions represent bipolar opposites, with the descriptors arranged to represent combined states (stress, high arousal, excitement, pleasant feelings, relaxation, sleepiness, depression, unpleasant feelings). The center square of the grid represents “a neutral, average, everyday feeling.” This measure was selected because it is brief and intuitive, and has acceptable psychometric properties. The Affect Grid has been shown to have adequate interrater reliability, good divergent validity, and good convergent validity with other affect scales (Russell et al., 1989; See Appendix D).

Memory Association Task (*Expectancy Prime Word List*). This instrument is a list of 20 words based on memory association research by Stacy and colleagues (1997). The experimental group version of the list will contain five homophones shown to be associated with alcohol for at-risk drinkers (draft, pitcher, mug, tap, shot), whereas the control group version will consist of only non-alcohol-related words (See Appendix E).

Emotion Suppression Manipulation Check (ESM; Gross, 1998). The ESM is a three item measure designed to assess the degree to which participants comply with instructions to suppress emotion during video viewing (i.e., emotional suppression vs. “act natural”). Respondents indicate level of agreement with three statements (“during the film, I tried not to feel anything at all,” “during the film, I felt emotions, but tried to hide them,” and “during the film, I reacted completely spontaneously”) on a 7-point Likert-type scale. The third item is reverse coded and the item total averaged ($\alpha = .84$). These items have been used in previous emotion research to assess the degree to which participants followed instructions (Gross, 1998; See Appendix F).

Affect Grid (see Above).

Exertion Assessment (EA; Muraven et al., 1998). The EA is a three item measure designed to assess the amount of effort expended by participants in the emotion suppression viewing condition. Respondents indicate level of effort expended using a Likert-type scale (0 = no effort to 6 = extreme effort) to assess the degree of effort, difficulty, and fatigue experienced as a result of the depletion manipulation. Items averaged to create an index ($\alpha = .85$) of energy expenditure in emotional suppression condition (See Appendix G).

Phase 3: Taste Test.

Effects of Alcohol Questionnaire (EAQ; Rather & Goldman, 1994). The EAQ is a five item measure that collects free associate responses to the stem, “Alcohol makes one _____.” Response-specific ratings are collected, as well, using the valence and arousal dimensions of the Affect Grid (See Appendix H).

Alcohol Expectancy Questionnaire (AEQ; Brown, Christiansen & Goldman, 1987; Goldman, Greenbaum & Darkes, 1997). The AEQ consists of 68 true/false statements to which the participant responds regarding the effects of alcohol. Items correlate with alcohol consumption and related behavior, as well as alcohol abuse, with a mean reliability of 0.84. This measure is comprised of six factors: global positive changes, sexual enhancement, physical and social pleasure, increased social assertiveness, relaxation and tension reduction, and arousal and aggression (See Appendix I).

UPPS Impulsive Behavior Scale (UPPS; Whiteside & Lynam, 2001). The UPPS is a measure of impulsivity that includes 45-items within 4 reliable subscales (urgency, lack of premeditation, lack of persistence, and sensation seeking; α 's range from .82 to .91). Factors on this measure are sensitive to cognitive impulsivity (premeditation), as well as the tendency to act rashly in response to negative emotion (urgency), associated with alcohol use and related problems (Magid & Colder, 2005). Impulsivity is an important piece of the drinker profile hypothesized here to be sensitive to the association of negative affect and decisions to drink. (See Appendix J).

Temptation and Restraint Inventory (TRI; Collins & Lapp, 1992). The TRI is a measure of preoccupation with controlling alcohol consumption. Items are rated on a 9-point scale from 1 (Not at All; lack of preoccupation) to 9 (Very Much; a high degree of preoccupation). The 15 items form five first-order factors: Govern (difficulty controlling alcohol intake); Restrict

(attempts to limit drinking); Emotion (negative affect as a reason for drinking); Concern about Drinking (plans to reduce drinking/worry about controlling drinking); Cognitive Preoccupation (thoughts about drinking). These five factors form two internally consistent second-order factors; Cognitive and Emotional Preoccupation (CEP; $\alpha = .91$) and Cognitive and Behavioral Concern (CBC; $\alpha = .79$). The CEP higher-order factor is composed of Govern, Emotion, and CP. It measures the temptation to drink. The CBC higher-order factor is composed of Restrict and CAD. It measures the control/restriction of alcohol intake. All factors exhibit adequate levels of internal consistency (alphas = .78 to .91; see Appendix K).

Procedure

Recruitment.

USF psychology student participants were recruited via SONA, the Psychology Department Research Participation Pool. The principal investigator and research assistants recruited students around the USF campus and community participants from the local community surrounding the university (i.e., 15 mile radius). Recruiters approached males who appeared to be between 21 and 28 and handed them a flyer (see Appendix L) that referred them to a website at which they could fill out a survey on what young men think about various products and marketing trends. Contact information was also collected at this time. Potential participants were contacted via phone and/or email up to three times following initial contact. Campus and community participants were given the opportunity to complete the screening survey at the point of initial contact. Research assistants reviewed a paper version of the online informed consent document at that time, obtained written consent, and handed a paper version of the survey, including contact information, which the participant completed at that time. Ultimately, this method turned out to be the most effective.

Phase 1: Online/Field Screening. Phase 1 consisted of screening procedures for the study proper. Student participants interested in class credit completed the informed consent document, DQ, DSQ, and AEMax-Short instruments online via SONA. Campus and community participants completed the same instruments online via Survey Monkey or, if they chose, in person at the point of live recruitment contact. All participants who completed the online study via SONA or Survey Monkey were shown a new screen with an invitation to participate in the lab study (Phase 2), which was described as a study of the effect of thought and emotion on concentration. Participants whose reported alcohol consumption suggests risk for substance use dependence will not see an invitation but a screen with a message suggesting help with alcohol-related problems for those who wish it, along with contact information for area substance use dependence treatment providers. Campus and community participants who completed the survey in person and met eligibility criteria were contacted by phone and invited to participate in Phase 2.

Phase 2: Laboratory Study. Upon arrival to the lab, participants were given the informed consent document (See Appendix M). Everybody was encouraged to read the consent, to ask questions and to consult any person they wished, and then to either sign the form or withdraw from the study. They were reminded that there would be no penalty for withdrawing, even if the study was only partially completed. Participants were told that they would view a video on a computer and then complete a couple of memory tasks. Figure 4 depicts the procedural timeline, with estimated duration denoted in minutes.

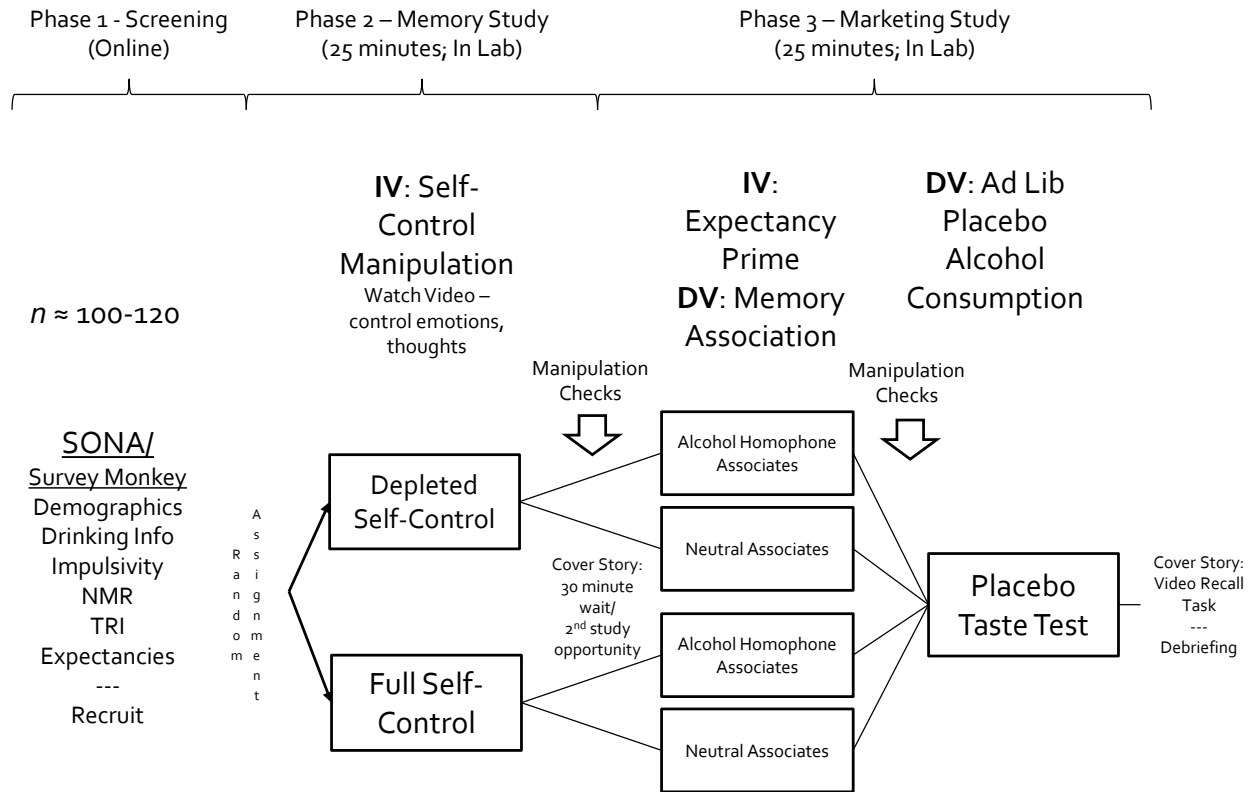

Figure 4. Schematic timeline of study procedures with approximate duration in minutes.

Self-Control Manipulations. This study adhered closely to previous studies using the sequential-task self-control depletion paradigm with alcohol consumption outcome (e.g., Muraven et al., 2002). Participants were randomly assigned to one of the four conditions described above. They watched an emotionally provocative video ("The Champ", Lovell, 1979), and then completed a thought listing exercise. Self-control conditions were identical to each other except for instructions (see Appendix N). The Depleted self-control group was instructed to avoid experiencing any emotion while they watched the video, and to avoid thinking of the video while listing thoughts (cf. Wegner et al., 1987). Participants in this condition were told to "...remain completely neutral on the inside and out. Please try your best not to let any feelings or

responses you may have show on your face, and to the best of your ability, try to keep all of your internal reactions suppressed.” This video has been shown to be very effective at inducing negative affect (sadness) among adults in a wide variety of settings (Rottenberg, Ray & Gross, 2007). Suppressing the expression of strong emotion, such as that elicited by this video, requires a great deal of inhibition and has been shown to reduce self-control strength (Muraven et al., 1998). The full self-control (control) group was told to watch the video and then to list thoughts, with no other instructions.

Manipulation Checks. Each of the experimental tasks was subjected to a manipulation check to verify its effectiveness, including measures of emotion suppression (ESM), quality and intensity of state affect (Affect Grid), and level of exertion (EA).

Expectancy Manipulation. After the video viewing and thought listing tasks, participants were randomly assigned to an expectancy prime (experimental) group or a no prime (control) group. Each expectancy group completed a memory association task consisting of 20 words to which participants responded with the first word that came to mind. The expectancy prime group’s list included five homophones that have been shown to be strongly associated with alcohol among at-risk drinkers (draft, pitcher, tap, mug, shot; Stacy & Leigh, 1997). All the words on the control group’s list were alcohol-neutral.

Phase 3: Taste Test. Following the first portion of the lab study (self-control and expectancy manipulations), participants were told they would need to wait 30 minutes before a final memory task could be administered. They were then offered the chance to participate in an ostensibly unrelated study in a nearby lab room. This second study was described as a psychological marketing study that included a beverage rating task, and which actually consisted

of the alcohol-placebo administration portion of this study. Participants were reminded before transfer to the other study remember the upcoming memory task.

Expectancy Measure. Free associate expectancies were collected using the Effects of Alcohol Questionnaire as part of a larger battery of otherwise irrelevant paperwork, and total volume consumed served as the larger study's primary dependent variable. No mention of the second study was made prior to completion of the self-control manipulation.

Taste test. Upon entering the new study area, participants completed a new informed consent document. Then they were handed a description of the new study, which was presented as an alcopop beverage rating task. Alcopop is a class of flavored alcoholic beverages sold in single serving cans or bottles (e.g., hard lemonade, spiked iced tea) that is popular among college age drinkers (Johnston et al., 2012). The taste of alcohol in most standard drink types is difficult to mimic but alcopops are easier to fake because they are designed to minimize the taste of alcohol while maintaining its effects. The drinks were packaged and prepared to resemble common store-bought alcopop drinks but were, in fact, non-alcoholic. Because many of this type of drink contain caffeine, an attribute that may affect both expectancy and drinking behavior, participants were told explicitly that the drinks did not contain caffeine. Amount consumed was measured as the dependent variable (Marlatt, Deming & Reid, 1973; Roehrich & Goldman, 1995).

This study was designed in accordance with recommendations for placebo administration studies (Sclauch et al., 2010; Testa et al., 2006). Several procedural elements were included that have been shown to yield largely equivalent effect sizes across studies utilizing alcohol and placebo experimental conditions. These included verification of legal drinking age, keeping actual alcoholic beverage containers in view of the participant, opening the test container in view

of the participant, and providing false BAC feedback. Along with bogus breath analysis prior to and following the main task, participants also witnessed a bogus BAC administered to a confederate participant. Finally, because it also appears to be important to keep the participant's focus on something other than the alcohol content of the drink, participants rated the flavor and other characteristics of the drink as a means to distract them from focusing too much on whether the drinks were actually alcoholic.

To maintain the independent study cover story, each participant was asked to complete a second consent form. Participants were told they would take part in a commercial beverage taste test that might include flavored water, colas, energy drinks, or flavored alcoholic drinks. The RA gave the appearance of checking notes before telling the participant that he or she had been designated to taste the alcoholic beverage. Participants were then asked to provide legal proof of age. At this point, the RA politely asked the participant's patience as they administered a fake breath alcohol test to a confederate participant, covertly read a BAC of .04 and advised the confederate to spend at least thirty minutes in the waiting area before they could leave the lab. After the consent process, a pair of 12 oz (355 ml) bottles of the placebo beverage were opened and placed on the table in front of the seated participant.

The experimenter then read the instructions (Appendix O) aloud to each participant and gave them the beverage rating form (Appendix P). Clear statements to "take your time" and "feel free to sample as much of each beverage as you need in order to arrive at a decision" were included. To reduce social constraints on drinking, the experimenter exited the room but told the participant he or she would be back to check on them. Participants were not told that the RA would be timing the procedure to last exactly 15 minutes. Halfway through the 15-minute period, the experimenter returned to check progress. At the end of 15 minutes, the rating form was

collected and bottles removed. Participants then estimated their level of intoxication and again rated their mood using the Affect Grid. After completing the taste test portion of the experiment, participants will complete the impulsivity (UPPS), expectancy (AEQ), and drinking restraint (TRI) instruments.

To maintain the credibility of the unrelated experiment paradigm, including subsequent credibility checks and debriefing procedures, participants were returned to the original testing area to complete a final memory recognition task.

Finally, the participant was debriefed (See Appendix Q) and released. Once the participant left the survey site, consumption was measured as the amount remaining subtracted from the total available (709.77 ml) using a graduated cylinder.

Results

Recruitment and Screening

The hypotheses proposed in this study assume a cognitive network sensitive to alcohol stimuli and in which such stimuli are evaluated to be reliably rewarding. Such a network is presumed to develop as a result of drinking history defined by reinforcement and, importantly, the relative absence of major negative life consequences; that is, younger, heavier drinkers. Alcohol consumption research indicates that drinking occurs most frequently and at the highest levels among young adults (Sher et al., 2005), and expectancy research suggests that males in this age range who drink tend to associate alcohol with rewarding outcomes more than do females (Nolen-Hoeksema, 2004). Accordingly, this study's sampling strategy was focused on the population of young men of legal drinking age at the University of South Florida and in its surrounding community. The targeted age range was fixed at 21-28, as research suggests that most drinkers begin to reduce alcohol intake in response to changing life demands around the

mid- to late-twenties (Dawson, Grant, Stinson & Chou, 2006). Because one's cognitive network shares a direct reciprocal influence with behavior, participants were targeted for moderate to heavy current drinking behavior, defined as self-reported typical weekly drinking of two occasions per week and three drinks per occasion (National Institutes of Health, 2004).

To increase the chances of participation, early recruitment strategy included financial incentive in the form of a random lottery, for which the winner would receive a \$50 gift card. This incentive was offered at each phase of the study, i.e., each participant had an equal chance to win up to three \$50 gift cards, for a total of \$150. Participants were made aware of each potential reward only after they agreed to participate in the preceding phase of the study.

Recruitment began in the Spring semester of 2013 and included SONA, the USF campus, and the surrounding community. The community recruitment strategy focused on temporal and geographic factors associated with gatherings of young adult males, including sporting and music events, video game and comic book stores, and areas of generally high foot traffic, such as malls, as well as restaurants, bars, and clubs during later hours, especially late in the week. The first recruitment iteration involved identifying young men, providing them with a flyer and critical information, and inviting them to participate by completing the screening survey by using the link on the flyer. Initial response rates were poor. Among other common public recruitment problems, such as competition with like-minded information gatherers, very few participants who took this study's materials followed through later to complete the online survey.

To increase the value of contact with potential participants and minimize the influence of the intervening time, research assistants began administering the screening survey in-person to those who were willing. Response rates improved only slightly, with particularly slow improvement in the community. In response to continued frustrations, the research team

conducted a brief verbal survey of the target population to assess the reasons for poor reception of recruitment efforts. Among the most consistent responses were that people did not appreciate being “bothered” while they were out with friends or family, and that the screening survey was too long. As a result, efforts were shifted to concentrate more heavily on the late afternoon and evening hours when people were less likely to expect to be left alone, and the screening survey was reduced from 10-15 minutes to 3-5 minutes (many survey items were moved to the end of the taste test portion of the study). Campus recruitment response rates improved moderately, almost entirely as a result of in-person screening, whereas community results changed little and SONA continued to yield very poor response rates (< 15% of overall response through Fall, 2013, and less than 20% of these were eligible for the study).

When a potential participant was successfully screened, he was told his participation in the screening survey made him eligible for other studies for which he could win another \$50 gift card and that with his permission he would be contacted later by phone. Among those successfully recruited and scheduled to participate in the second phase of the study, the overwhelming majority simply did not show for the appointment. Of those who answered follow-up calls, many said they were not interested and that they had scheduled simply to appease the caller, but others said that an immediate financial incentive would likely be more alluring than a chance to win money later. Several participants said they simply forgot. In response, further changes made to recruitment strategies included the addition of a \$10 gift card incentive paid immediately upon completion of the lab portion, and the movement of phone and text reminders from the night before to the day of a participant’s appointment.

In addition to the items described above, protocol fidelity measures were implemented from the beginning of the study, which covered all aspects of the study, including adherence to

recruitment scripts, voice tone and delivery, and customer service behaviors such as respect, flexibility and accommodation. Interventions included discussion at weekly research team meetings and bi-weekly supervisor meetings, as well as weekly training exercises in which research assistants enacted protocol with a mock participant for the team’s training supervisor. The session was recorded digitally and shared with the principal investigator, who reviewed each session and discussed its outcome with the research assistants involved.

Although participant contact and screening improved significantly and scheduling rates were generally encouraging, no-show rates remained high throughout the study. Table 2 shows the final recruitment and screening numbers, including no-show rates. At the study’s briskest recruitment and scheduling pace, just over 5 participants were being run successfully per month. At that rate, it would have taken until September, 2015, to obtain the study’s proposed sample size which was infeasible given the academic timeline constraints on the principal investigator.

Table 2

Total Recruitment Numbers

<u>Recruitment Category</u>	<u>Total</u>	<u>Percent of Parent Level</u>
Screening surveys administered	1243	-
Number eligible	403	32% of those screened
Number scheduled	217	54% of those eligible
Number run	61	28% of those scheduled
Number of no-shows	157	72% of those scheduled

Note. Does not include cancellations and rescheduled sessions

Sample Characteristics

In total, 61 participants were eligible, agreed to participate in the study, and showed for their appointments. Of these, five were removed from the final sample because they did not complete all aspects of the protocol (e.g., chose not to participate in the taste test portion; refused to complete questionnaires). The final sample ($n = 56$) consisted of males between the ages of 21 and 28 ($M = 23.7$, $SD = 3.11$), 89% of whom reported being full-time students. 18% of the sample reported Hispanic ethnicity, and 22% reported being non-white. 73% of the sample reported being employed full- or part-time. 58% of participants reported making between zero and \$24,999 per year, whereas 25% reported making between \$25,000 and \$99,999, and 17% reported making more.

Table 3 shows the comparison of demographic variables for participants across the four experimental conditions, which revealed no significant differences between the groups, suggesting successful random assignment. An additional test of group equivalence was run to assess the effect of adding the immediate \$10 gift card incentive early in the study. The chi-square statistic for each demographic variable, as well as the drinking variables and the incentive difference, was non-significant, meaning the null hypothesis of no differences between groups could not be ruled out.

Table 4 provides correlation and covariance information for self-reported drinking and alcohol expectancy variables. The data from the alcohol consumption and expectancy measures suggest a sample whose frequency and quantity of drinking are high but not tied to each other ($r = -.21$, $p = .13$). The sample also appears to be motivated primarily by the sexual (AEQ – Sexual Enhancement; $r = .40$, $p < .01$) and physical (AEQ – Sexual and Physical Pleasure; $r = .28$, $p < .05$) effects associated with alcohol. This is a common

Table 3

Chi-Square tests of group independence

							Chi-Square	p-value	
	<i>n</i> =	SC+E	SC-only	E-only	No-Treat	Lottery	Gift Card		
		15	15	13	13	23	33		
<i>Demographic</i>									
	Age	24	23.93	22.5	25.15	24.13	23.75	9.66	0.21
	Student Status (% Student)	100%	100%	92%	77%	96%	91%	10.90	0.09
	Employment Status (% Employed)	53%	73%	54%	77%	61%	64%	11.75	0.23
	Race (% White)	67%	80%	85%	69%	83%	70%	4.25	0.64
	Ethnicity (% Non-Hispanic)	67%	73%	69%	92%	74%	76%	12.79	0.17
	Income (% < 50,000)	67%	80%	46%	69%	65%	70%	12.54	0.92
<i>Alcohol Consumption</i>									
	Frequency (Drink days per week)	3.13	3.07	3.58	2.31	3.35	2.78	11.02	0.89
	Quantity (Drinks per occasion)	4.13	4.07	4	4.08	4.35	3.88	9.22	0.87

Note. SC+E = Self-Control-plus-Expectancy; SC-only = Self-Control-only; E-only = Expectancy-only; No-Treat = No-Treatment; Lottery = \$50 gift card drawing for each phase; Gift Card = \$10 gift card paid immediately

pattern of expectancies for college-aged males (Ham & Hope, 2003), although in this sample, the relationship is with reported frequency of drinking (see Table 3), which is somewhat unexpected but not entirely unusual (Leigh, 1989). For ease of reading and as a means to introduce each analytic step, the study's aims and respective hypotheses are repeated in the section below.

Following presentation of the results for each hypothesis, exploratory analyses will be described.

Manipulation Checks. Each of the experimental tasks was subjected to a manipulation check to verify its effectiveness, including measures of emotion and thought suppression (ESM), level of exertion (EA), and quality and intensity of state affect (Affect Grid). As expected, independent sample t-tests revealed that the Depleted self-control condition, $M = 13.67$ (4.64), reported significantly higher emotion suppression scores than the Non-Depleted condition, $M = 9.04$ (4.09), $t(54) = 3.929$, $p < 0.001$; $d = 1.07$, *Mean Difference* = 4.63, 95% CI [2.27, 6.99]. This was true for exertion levels, as well, as the Depleted self-control condition, $M = 14.77$ (4.34), reported significantly higher thought suppression scores than the Non-Depleted condition, $M =$

7.73 (3.16), $t(54) = 6.837$, $p < 0.001$; $d = 1.86$, *Mean Difference* = 7.04, 95% CI [4.97, 9.10].

Also as expected, the Depleted self-control condition, $M = 14.30$ (6.04), reported significantly higher exertion scores than the Non-Depleted condition, $M = 10.65$ (3.29), $t(54) = 2.775$, $p < 0.01$; $d = 0.76$, *Mean Difference* = 3.68, 95% CI [1.02, 6.35]. regarding the affect grid, independent samples t-tests revealed no significant difference between self-control manipulation groups on either self-reported pleasantness, $t(53) = -0.313$, $p = 0.756$; $d = 0.09$, *Mean Difference* = -0.13, 95% CI [-0.93, 0.68], or arousal, $t(53) = 0.140$, $p = 0.889$; $d = 0.04$, *Mean Difference* = 0.07, 95% CI [-0.97, 1.11], suggesting that current mood was not significantly influenced by the self-control manipulation and should not, therefore, exert differential influence on outcome measures. Thus, all experimental manipulations appear to have performed as expected.

Aim 1. To replicate the main effect of self-control depletion on alcohol consumption, as well as its interaction with trait temptation to drink, within the sequential-task self-control depletion paradigm.

***Hypothesis 1.** There will be a main effect of self-control condition. Participants in the Depleted condition will drink more placebo alcohol than those in the Non-Depleted condition.*

An independent-samples t-test revealed that the Depleted self-control groups consumed significantly more alcohol in the taste test, $M = 530.52$ ml (210.31), than the Non-Depleted groups, $M = 398.08$ ml (194.85), $t(54) = 2.431$, $p < 0.05$; $d = 0.65$, *Mean Difference* = 201.16, 95% CI [105.12, 297.19], (see Figure 5).

Table 4

Correlation/Covariance Matrix for Self-Reported Alcohol Consumption and Expectancies

	Alcohol Consumption		AEMAX			AEQ					
	1	2	3	4	5	6	7	8	9	10	11
	<u>Freq</u>	<u>Quant</u>	<u>Pos-Arous</u>	<u>Sedat</u>	<u>Neg</u>	<u>Glo-Pos</u>	<u>Sex</u>	<u>Sex-Phys</u>	<u>Soc-Assert</u>	<u>Tens-Red</u>	<u>Agg-Arous</u>
1	2.17	-0.21	0.09	0.06	0.05	0.23	0.40**	0.28*	0.20	0.20	0.17
2	-0.50	2.70	0.11	0.16	0.09	-0.09	-0.17	-0.09	-0.10	-0.17	0.00
3	0.10	0.14	0.64	-0.01	0.20	0.30*	0.26	0.18	0.17	0.22	0.39**
4	0.08	0.24	-0.01	0.83	0.48**	0.09	0.00	0.03	0.15	0.27*	0.25
5	0.07	0.15	0.16	0.44	1.05	0.08	0.05	0.09	-0.09	0.09	0.26
6	1.82	-0.76	1.25	0.41	0.44	27.49	0.51**	0.58**	0.55**	0.57**	0.62**
7	1.21	-0.56	0.43	0.01	0.10	5.48	4.26	0.44**	0.40**	0.22	0.58**
8	0.41	-0.14	0.14	0.03	0.09	2.99	0.89	0.96	0.32*	0.40**	0.56**
9	0.65	-0.38	0.29	0.30	-0.20	6.80	1.96	0.74	5.62	0.30*	0.38**
10	0.47	-0.45	0.28	0.40	0.14	4.81	0.73	0.63	1.15	2.57	0.44**
11	0.51	0.00	0.65	0.47	0.55	6.62	2.45	1.14	1.88	1.48	4.26
Mean	3.02	4.07	3.80	3.07	3.19	9.70	2.50	8.14	7.95	6.79	5.18
SD	1.47	1.64	0.80	0.91	1.03	5.24	2.06	0.98	2.37	1.60	2.06

$N = 56$; * $p < .05$, ** $p < .01$;

Note. AEQ was administered after experimental manipulation; no significant difference between conditions was observed on any AEQ scale. Correlations are listed above the diagonal, Variances on the diagonal, and Covariances below the diagonal. Freq = Frequency; Quant = Quantity; Pos-Arous = Positive Arousing Scale; Sedat = Sedating Scale; Neg = Negative Scale; Glo-Pos = Global Positive Scale; Sex = Sexual Enhancement Scale; Sex-Phys = Sexual and Physical Pleasure Scale; Soc-Assert = Social Assertion Scale; Tens-Red = Tension Reduction Scale; Agg-Arous = Aggression/Arousal Scale

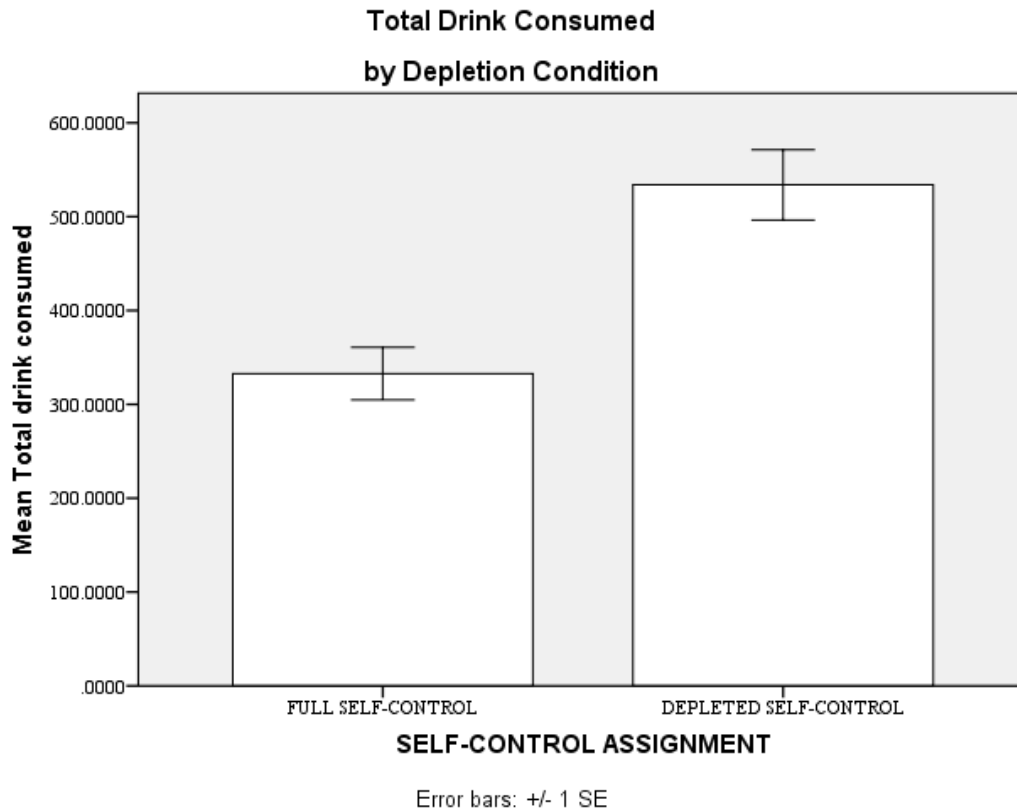

Figure 5. Total drink consumed by self-control condition

Hypothesis 2. *The main effect of Condition will be qualified by an interaction between Condition and the Cognitive-Emotional Preoccupation scale of the Trait Temptation to Drink measure. In the Depleted condition, but not in the Non-Depleted condition, self-reported Cognitive-Emotional Preoccupation scores will be positively related to Total Drink Consumed.*

A hierarchical regression was run on Total Drink Consumed, with Condition, the cognitive and emotional preoccupation factor score, and their interaction as predictors. The overall model was significant, $F(2, 53) = 9.56, p < .001, R^2 = .26$. Condition was significantly related to Total Drink Consumed, $\beta = .493; t(54) = 4.19, p < .001, 95\% \text{ CI } [52.10, 147.87]$, whereas Cognitive-Emotional Preoccupation was not, $\beta = .138; t(54) = 1.16, p = .25, 95\% \text{ CI } [-1.94, 7.36]$. Contrary to Hypothesis 2 and the Muraven et al. (2002) findings, but unsurprising in

light of the null finding for Cognitive-Emotional Preoccupation, the interaction term was not significant, $\beta = -.049$; $t(54) = -.168$, $p = .87$, 95% CI [-5.17, 4.37], providing no increase in explained variance ($R^2\text{change} = .00$).

Aim 2. To replicate the main effect of alcohol expectancy priming on alcohol consumption.

Hypothesis 3. *There will be a main effect of expectancy condition. Participants in the Primed condition will drink more placebo alcohol than those in the Non-Primed condition.*

An independent-samples t-test revealed the expected pattern for Hypothesis 3, in which the Primed condition ($M = 489.50$ ml, $SD = 185.06$) consumed more taste test drink than did the Non-Primed condition ($M = 391.42$ ml; $SD = 213.43$), but the effect did not reach statistical significance, $t(54) = 1.837$, $p = 0.07$, $d = .49$, 95% CI [-8.94, 205.12], (see Figure 6).

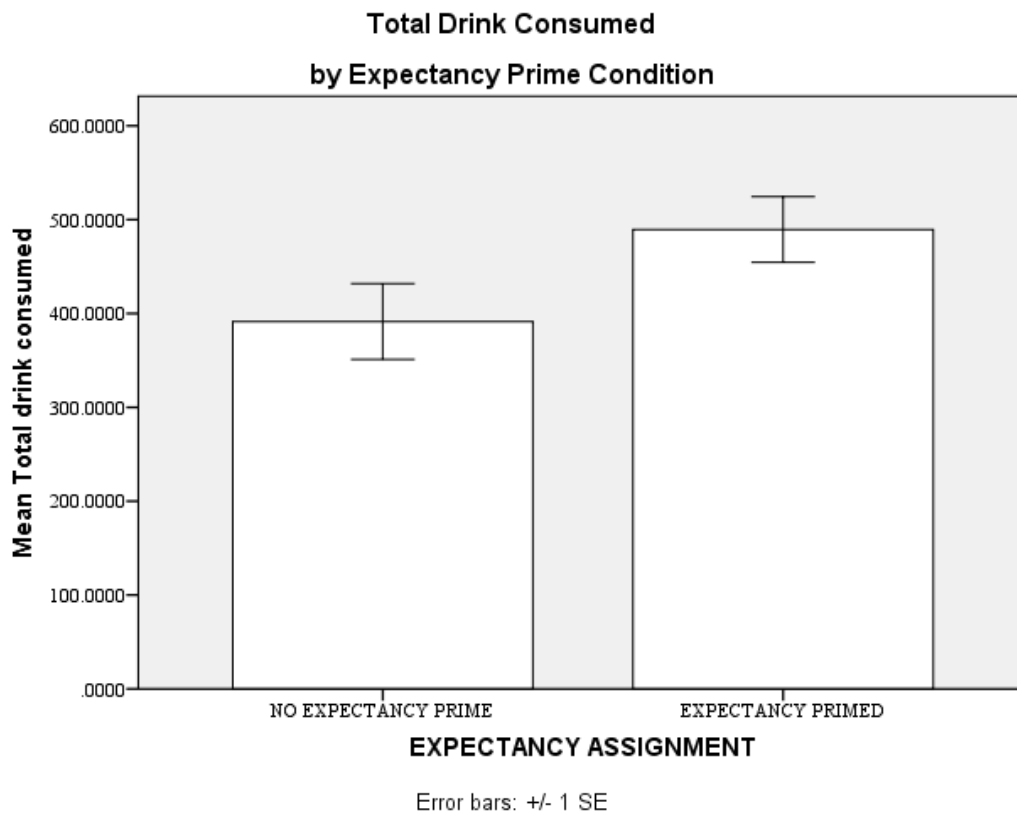

Figure 6. Total drink consumed by Expectancy condition

Hypothesis 4. *The primary independent variables will have additive effects. Participants in the Self-Control-plus-Expectancy group will consume more placebo alcohol than either the Self-Control-only or Expectancy-only group, and the No-Treatment group is expected to consume least of all.*

A one-way between subjects ANOVA was conducted to test the prediction that the effect of Condition on Total Drink Consumed would be additive across groups. There was a significant overall effect of Condition, $F(3,52) = 7.62, p < .001$, whereas follow-up tests revealed partial support for the additive effects hypothesis (see Figure 7).

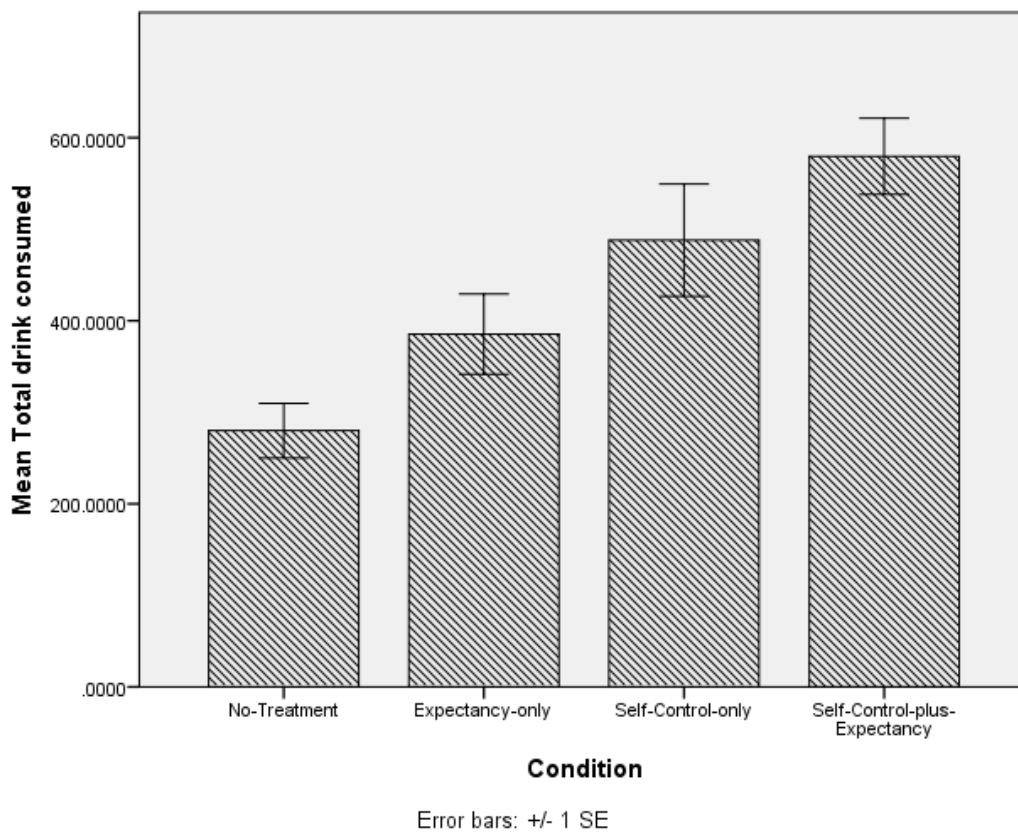

Figure 7. Total drink consumed by Condition

Post hoc comparisons using the Tukey HSD test indicated that the mean score for the Self-Control-plus-Expectancy condition ($M = 579.66, SD = 161.05$) was significantly greater

than the Expectancy-only condition ($M = 385.48$, $SD = 157.85$), and the Control condition ($M = 271.92$, $SD = 107.80$). The mean score for the Self-Control-only condition ($M = 488.05$, $SD = 237.37$) was significantly greater than the No-Treatment condition ($M = 271.92$, $SD = 107.80$). No other differences were observed among the four levels of manipulation (see Table 5).

Table 5

One -Way ANOVA Planned Comparisons

Condition	Comparison	Mean	Standard	Sig.	95% Conf. Interval	
		Difference	Error		Lower	Upper
Self-Control-plus-Expectancy	Self-Control-only	91.62	63.86	0.48	-77.87	261.10
	Expectancy-only	194.19*	66.27	0.03	18.31	370.07
	No-Treatment	299.74*	66.27	0.00	123.86	475.63
Self-Control-only	Expectancy-only	102.57	66.27	0.42	-73.31	278.45
	No-Treatment	208.13*	66.27	0.01	32.25	384.01
Expectancy-only	No-Treatment	105.56	68.59	0.42	-76.50	287.61

* The mean difference is significant at the 0.05 level.

Aim 3. To demonstrate the conditional relationships between self-control, trait temptation to drink, alcohol expectancies and alcohol consumption.

***Hypothesis 5.** Alcohol expectancies will be positively related to total amount of placebo alcohol consumed in the Depleted condition but not in the Non-Depleted condition.*

Participants provided five word associations to complete the phrase, “Alcohol makes me...”, as well as Pleasantness (valence) and Arousal ratings for each word on a 1 to 7 scale. The Expectancies variable was derived from the product of valence and arousal ratings.

Examination of scatterplots for Expectancies and Total Drink Consumed revealed a ceiling effect of Total Drink Consumed that may affect the validity of the data related to Hypothesis 5 (see Figure 8). Data bunched at the uppermost bound of a variable's range (its ceiling) are said to be censored, because they provide limited information at that level (Cox & Oakes, 1984), which contributes to biased parameter estimates in common statistical models that use ordinary least squares (OLS) estimators. The Tobit model of regression is one available solution to the problem of censoring and involves the use of a modified maximum likelihood estimation (MLE) to obtain regression coefficients equivalent to those in OLS while avoiding the biases attendant to the latter method (McBee, 2010).

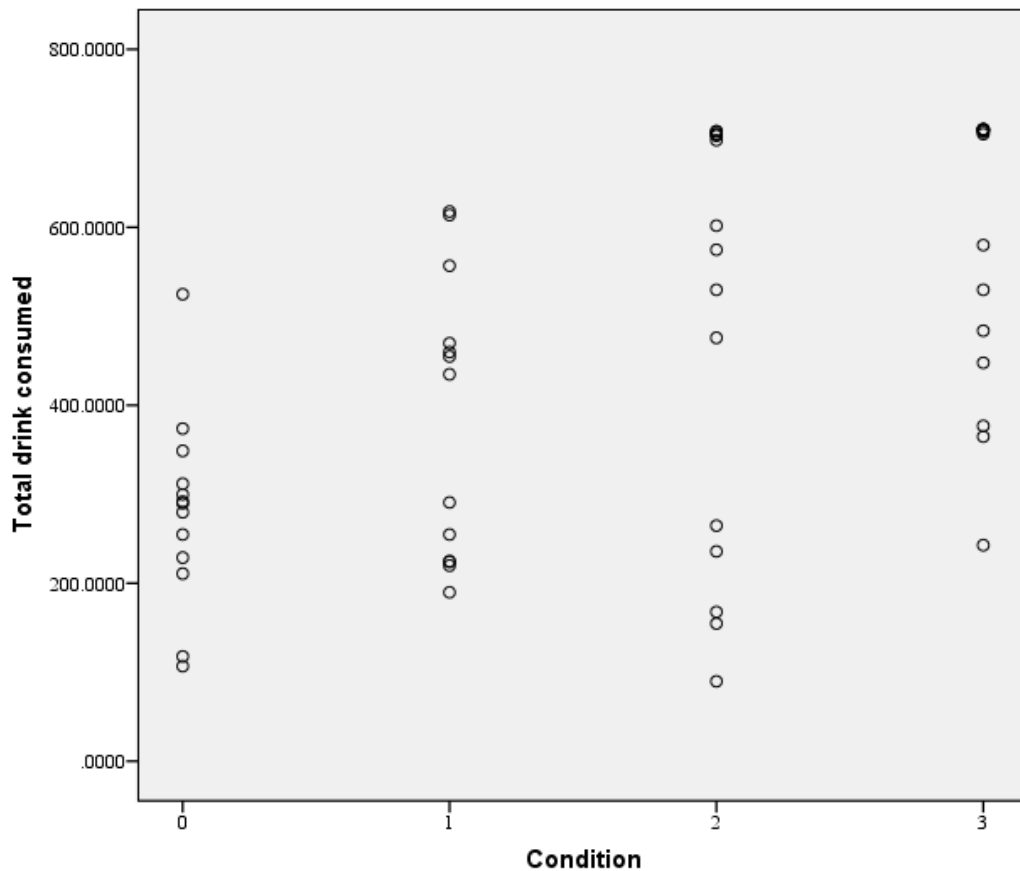

Figure 8. Total drink consumed by Condition, showing ceiling effect.
 Note. 0 = No-Treatment; 1= Expectancy-only; 2 = Self-Control-only; 3= Self-Control-plus-Expectancy

Using the Tobit model provided in the censReg package (Henningsen, 2010) for the R software environment (R Development Core Team, 2007b), linear regression was run on Total Drink Consumed with Expectancies as the predictor. The full model was significant, showing Expectancies to be positively related to Total Drink Consumed across conditions, $B = 4.42$ (1.97), $t(54) = 2.24$, $p < .05$ (the censReg package provides only unstandardized regression coefficients). As predicted, Expectancies for those in the Non-Depleted conditions failed to predict Total Drink Consumed, $B = 1.83$ (2.09), $t(54) = 0.87$, $p = .38$. Contrary to prediction, ratings in the Depleted conditions also were not significantly related to Total Drink Consumed, $B = 2.73$ (3.01), $t(54) = 0.91$, $p = .36$.

Hypothesis 6. *The self-control – trait temptation to drink interaction will be positively related to alcohol expectancy free associate ratings (valence and arousal).*

As an intermediate step in testing the overarching prediction that the interactive effect of self-control and trait temptation to drink operates via alcohol expectancies to influence alcohol consumption, Hypothesis 6 involves the conditional effect of Condition and Cognitive-Emotional Preoccupation on Expectancies. Multiple linear regression showed the interaction model to be non-significant, $F(2, 52) = 1.82$, $p = .16$, $R^2 = .10$. In the main effects model, Condition was positively related to Expectancies, $\beta = .289$, $t(54) = 2.20$, $p < .05$, whereas Cognitive-Emotional Preoccupation was not, $\beta = .036$, $t(54) = 0.28$, $p = .78$.

Exploratory Analyses

Analysis of hypotheses 1 – 6 demonstrate that requisite conditions for the hypothesized moderated mediation effect were not met. For example, none of the hypothesized constituent conditional effects emerged. Given the absence of fundamental findings, the primary hypothesis was not analyzed. However, some unexpected findings observed in the course of analyses

offered information pertinent to a variation on this study's primary hypothesis, and so these were explored.

Regarding Hypothesis 2, Muraven et al. (2002), found that the Cognitive-Emotional Preoccupation factor of the Trait Restraint Inventory moderated the relationship between self-control manipulation and alcohol consumed in a taste test. That is, participants in the self-control condition consumed more alcohol in the taste test when they also reported a higher degree of preoccupation with drinking. That interaction effect did not replicate in this sample. To clarify this inconsistency, Cognitive-Emotional Preoccupation and its relation to Total Drink Consumed were examined more closely. The Cognitive-Emotional Preoccupation scale is made up of three subscales, including Difficulty Controlling drinking, Negative Affect as a Reason for drinking, and Cognitive Preoccupation with drinking. Whereas this sample's endorsement of Cognitive Preoccupation was weak ($M = 4.76$, $SD = 2.88$, range = 3 – 15), its endorsement of Negative Affect as a Reason ($M = 9.04$, $SD = 5.65$, range = 3 – 25) and Difficulty Controlling ($M = 9.55$, $SD = 4.90$, range = 3 – 23) were stronger. Although the Difficulty Controlling and Negative Affect as a Reason scales were similarly endorsed by this sample, they were dissimilar in their relationships with Total Drink Consumed directly ($r = .27$, $p < .05$ and $r = .16$, $p = .25$, respectively), and as a function of self-control. Specifically, the Negative Affect as a Reason scale showed no pattern of relationship between self-control and drinking, whereas the Difficulty Controlling scale showed the expected, albeit non-significant interaction pattern with self-control (see Figure 9).

With information about the Cognitive-Emotional Preoccupation subscales in mind, a hierarchical regression was run on Total Drink Consumed again, this time with Condition, the Difficulty Controlling score, and their interaction as predictors. The overall model was

significant, $F(2, 53) = 10.23, p < .001, R^2 = .28$ but again, the interaction was not, $\beta = .337, t(54) = 1.25, p = .22, R^2 \text{ change} = .021$.

Despite non-significant findings of Hypothesis 5 that Expectancies would be positively related to Total Drink Consumed in the Depleted Self-Control condition, it is worth noting the pattern of relationship between Expectancies and Total Drink Consumed as a function of

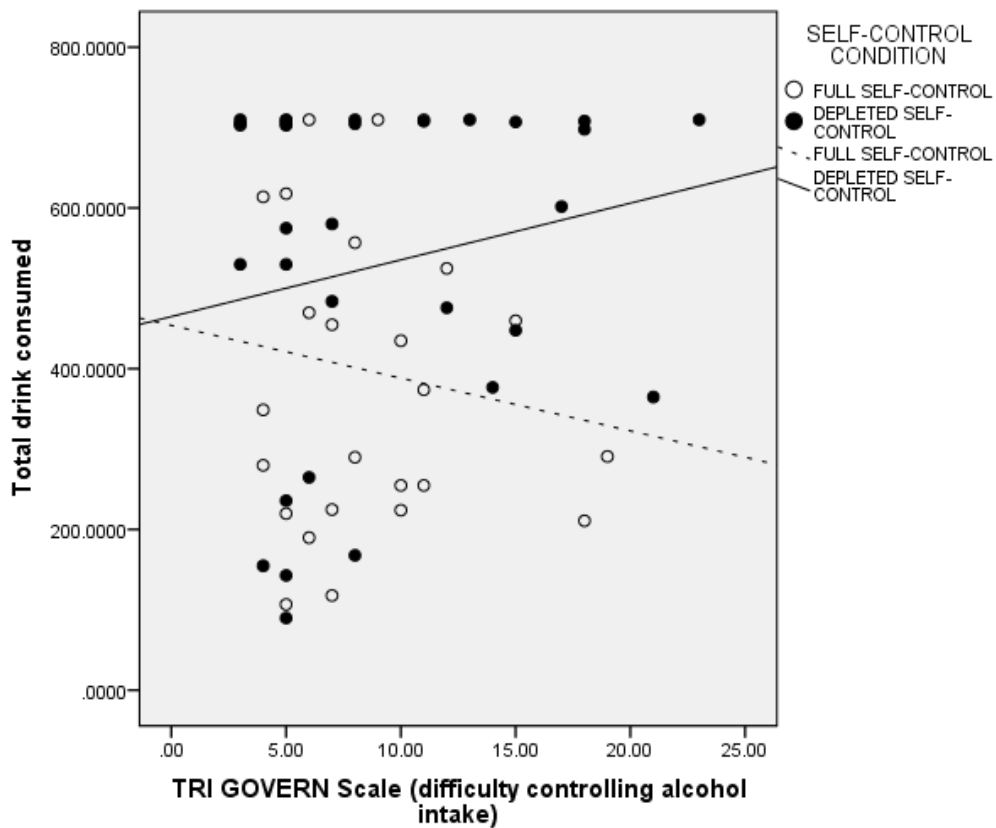

Figure 9. Difficulty Controlling on Total Drink Consumed by Self-Control

experimental group. Figure 10 shows a relationship between Expectancies and Total Drink Consumed in the Depleted condition that is likely attenuated by both the ceiling effect described above, and power concerns. The nature of this relationship is made clearer when examined as a

function of all experimental groups. Figure 11 shows a pattern of increase between variables that reflects the additive effects found in the earlier ANOVA results. The No-Treatment group shows virtually no relationship, whereas the Expectancy- and Self-Control-only groups show a stronger relationship respectively, and the Self-Control-plus-Expectancy group shows the strongest relationship of all.

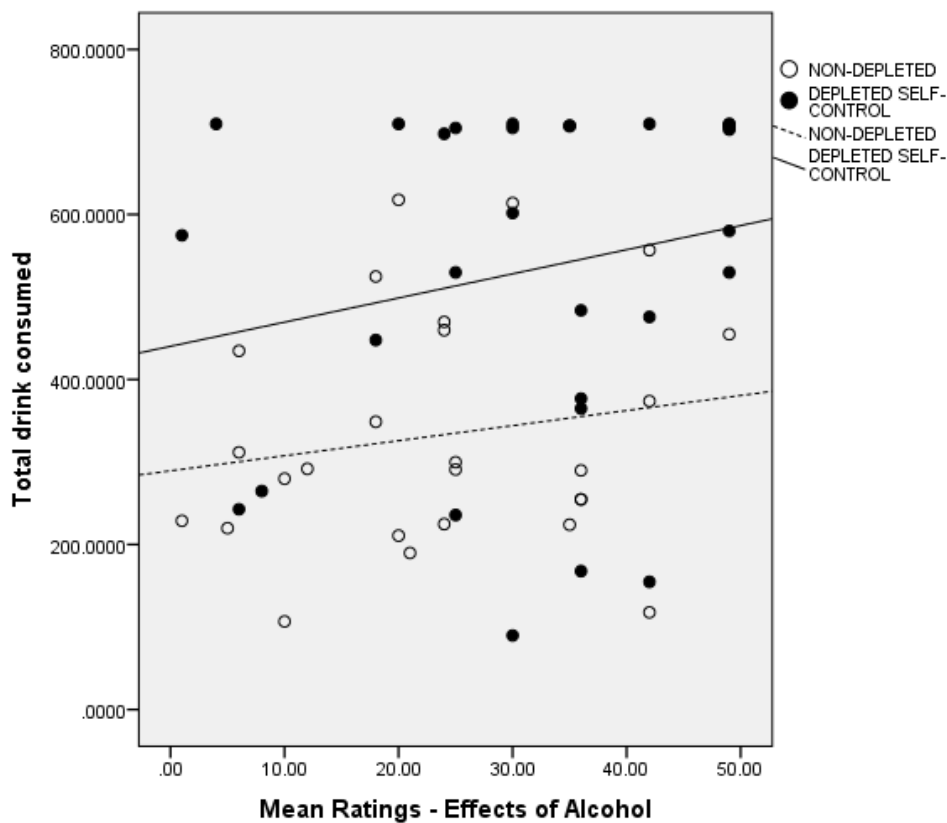

Figure 10. Total drink consumed on effect of alcohol ratings by depletion condition

Again, power is likely a strong influence here, as is the ceiling effect, but these patterns at least suggest that a mediational role for Expectancies is plausible.

As detailed above in the analysis of Hypothesis 6, the trait temptation to drink scale used in the Muraven et al. (2002) study, Cognitive-Emotional Preoccupation, was not influential in this sample, whereas the subscale Difficulty Controlling, which was related to Total Drink Consumed in this study, was more so. Accordingly, Hypothesis 6 was modified to include the

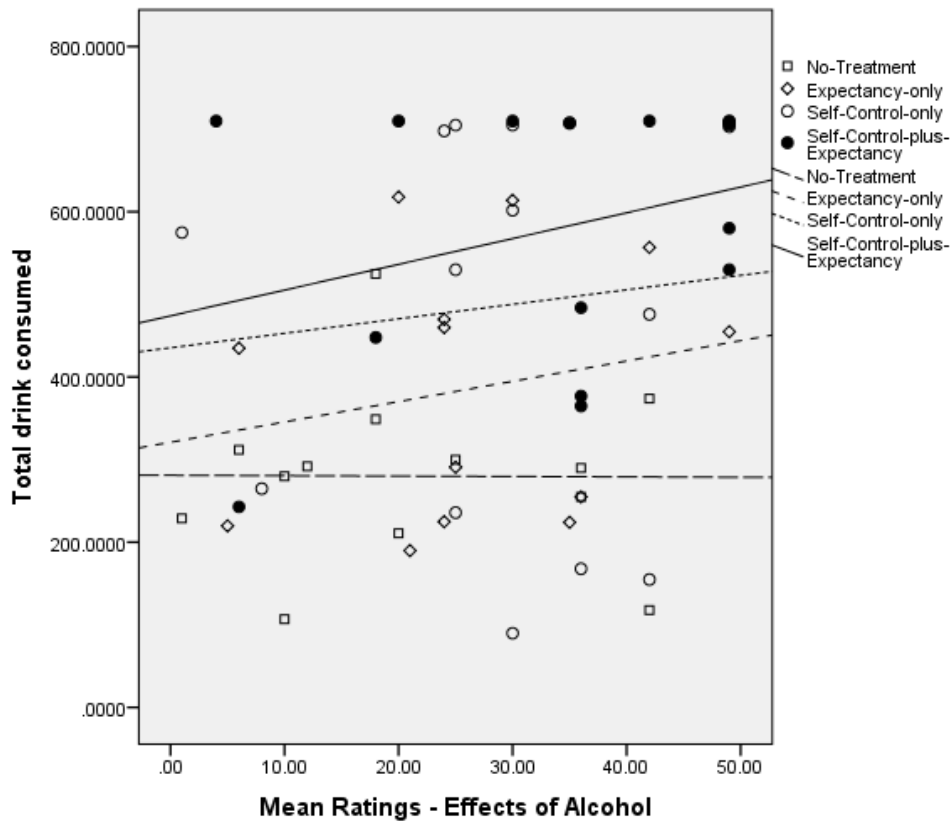

Figure 11. Additive effects of condition on total drink consumed by alcohol effects ratings

predicted moderating influence of Difficulty Controlling; specifically that the relationship between Condition and Expectancies would increase in strength with increased scores on Difficulty Controlling.

Multiple linear regression showed the interaction model to be significant, $F(2, 53) = 3.32$, $p < .05$, $R^2 = .11$, and $R^2\text{Change} = .05$ over the main effect model. Condition was positively related to Expectancies, $\beta = .785$, $t(54) = 2.72$, $p < .01$, whereas Difficulty Controlling was not, $\beta = .433$, $t(54) = 1.69$, $p = .09$). The interaction was also non-significant, $\beta = -.716$, $t(54) = -1.80$, $p = .08$).

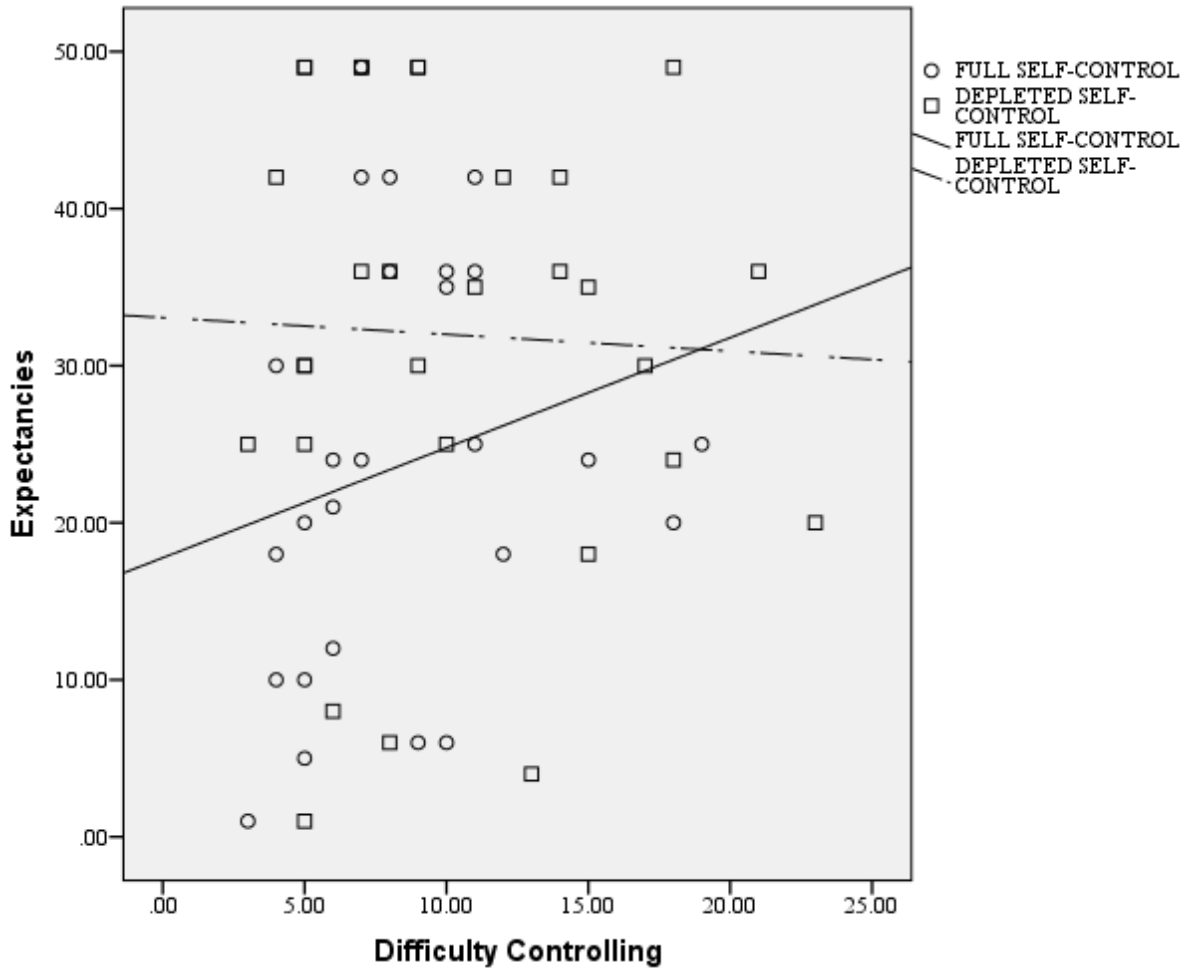

Figure 12. Unexpected pattern of Difficulty Controlling to Expectancies relationship by Condition

The lack of relationship between Difficulty Controlling and Expectancies, as well as their interaction suggests that, in this sample, reporting difficulty controlling one's alcohol intake is

not associated with having higher positive and arousing expectancies for alcohol, but this may again be a result of low power. A closer look at the scatterplot for Difficulty Controlling and Expectancies (see Figure 12) shows that whereas those who reported more difficulty drinking tended to generate more positive expectancies for alcohol in general, this did not occur under conditions of self-control depletion.

This pattern was unexpected but not theoretically implausible, as it suggests that the predicted moderating role of Difficulty Drinking may be there after all, but, in this sample, operating in a way contrary to expectation. That is, in light of this observation, it could be that although difficulty controlling drinking and higher alcohol expectancy ratings tend to “go together” in general terms because people who drink more than intended think of drinking outcomes in more positive ways, under conditions of self-control depletion, Expectancies operate independently of Difficulty Drinking. Ultimately, it appears that both Expectancies and Difficulty Controlling are positively related to the outcome variable, Total Drink Consumed, even though they may be unrelated to each other in this sample. This finding runs contrary to hypotheses, but is interesting nonetheless because it may suggest independent effects of alcohol expectancies and self-control on drinking.

Although constituent conditional relationships were not borne out in this sample, unexpected and interesting observations suggest that independent effects may partially explain the lack of findings for conditional effects. Further, the potential for differential effects of Expectancies and Difficulty Controlling depending on Depletion condition suggests that the hypothesized conditional indirect effects may exist in some form related to but directionally different from the proposed model. These questions provided the impetus for exploration of the study’s primary hypothesis in the revised context of this new information.

Aim 4. To demonstrate the mediational role of expectancies in the moderated relationship between self-control, trait temptation to drink and alcohol consumption.

Hypothesis 7. Alcohol expectancy free associate ratings (valence and arousal) will mediate the relationship between the self-control – trait temptation to drink interaction and placebo alcohol consumption.

A necessary step in testing the primary hypothesis that self-control and temptation to drink work together via alcohol expectancies to affect drinking was to show that Expectancies mediate the effect of Condition on Total Drink Consumed. Traditional mediation analysis provided further support for an independent process hypothesis. A series of regressions were conducted in accordance with Baron & Kenny (1986), which revealed that Condition was positively related to Total Drink Consumed (path c), $\beta = .496, t(54) = 4.20, p < .001$.

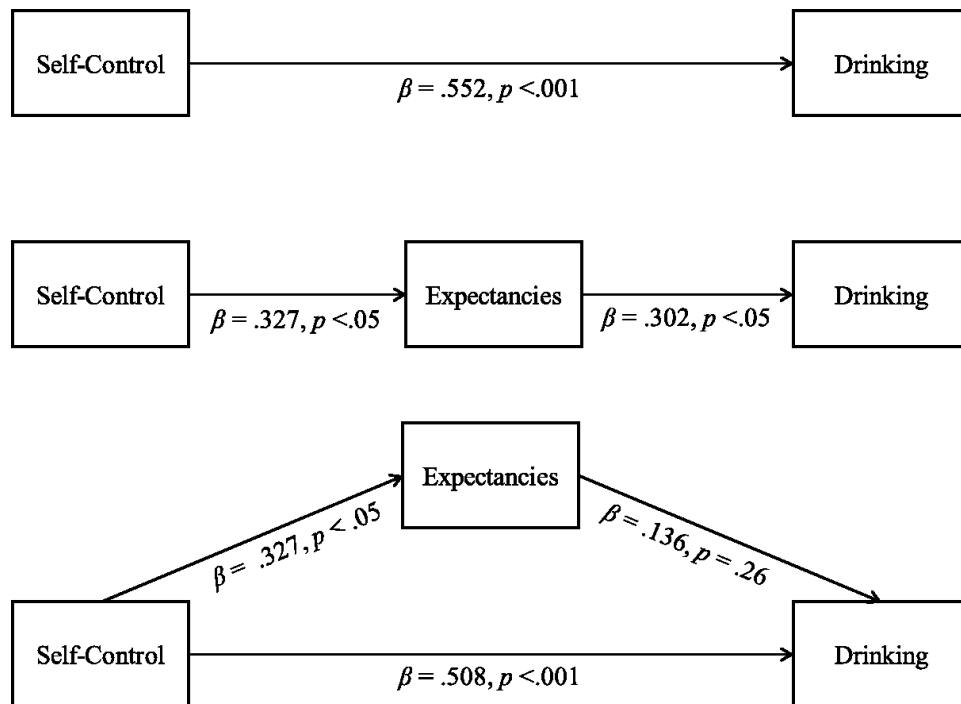

Figure 13. Causal steps mediation analysis

In addition, Condition was positively related to Expectancies (path a), $\beta = .289$, $t(54) = 2.22$, $p < .05$, and Expectancies was positively related to Total Drink Consumed (path b), $\beta = .302$, $t(54) = 2.33$, $p < .05$. In the final test of mediation, in which Total Drink Consumed was regressed onto both Condition and Expectancies, Expectancies was no longer significant after controlling for Condition (path b), $\beta = .173$, $t(54) = 1.41$, $p = .16$, (see Figure 13), perhaps reflecting a common factor underlying both Expectancies and Total Drink Consumed. The causal steps approach to mediation testing (Baron & Kenny, 1986) is the simplest and most well-known method of testing for indirect effects. However, it is not without its limitations. One problem is that the causal steps approach is not designed to test the significance of the indirect pathway, but rather sets up the logical boundaries from within which to infer the presence of an indirect effect. It does this through a series of separate tests, resulting in a threat to parsimony, whereas methods with fewer tests may be more desirable (Hayes, 2009). Additionally, and most important for this study, the causal steps approach suffers from very low power (MacKinnon et al., 2002). As this study's hypotheses depend on a mediation effect, ie, self-control's effects on drinking carried in part indirectly through intervening expectancies, the causal steps approach is least likely among methods for testing indirect effects to detect that effect. Due to this study's small sample size, the power problem inherent in the causal steps approach compounds the difficulty of quantifying the indirect effects associated with the self-control – expectancy – alcohol consumption model under study.

Preacher & Kelley (2011) observed that too little attention has been paid to mediation effect sizes despite recommendations to include them at least as far back as Baron & Kenny (1986). Kelley & Preacher (2012) compile evidence from across experts in the field to conclude that effect size should be considered apart from the null hypothesis significance test (NHST)

approach altogether and instead used to provide a substantive quantification of a phenomenon under study, and in answering a question of interest. The authors offer their own index, κ^2 , for communicating indirect effects in mediation models, which is the proportion of the value of the observed indirect effect to its maximum attainable value, given the sample variances and magnitudes of relationships between constituent variables. This allows a meaningful interpretation of the indirect effect in the context of its full range of possible values. For example, a mediation effect of $ab = .50$ might be considered weak when its maximum possible effect is .90, but stronger when its maximum is .60. The benefits of the κ^2 metric include that it is standardized (i.e., scale-independent), interpretable (0-1), insensitive to sample size, and allows the construction of confidence intervals via bootstrapping. Regarding interpretation, Preacher & Kelley (2011) recommend following Cohen's (1988) guidance on proportions of variance accounted for in one variable by another; that is, because of their similarities, κ^2 can be interpreted against the same benchmarks as r^2 (i.e., .01 = small, .09 = medium, .25 = large). To this end, and considering the smaller sample size of this study, data were analyzed using this procedure to generate a meaningful mediation effect size, independent of sample size, along with confidence intervals to illustrate uncertainty of the point estimate and aid in interpretation (Preacher & Kelley, 2011).

Using MBESS (Kelley, 2010), an open source package for the R statistical programming language and environment (R Development Core Team, 2007b), the mediation model was run again to obtain the κ^2 mediation effect size and bootstrapped confidence intervals. Consistent with results of the causal steps approach, all paths were significant except the final mediation. The direct effect, Total Drink Consumed on Condition, was significant (path c), $B = 100.08$, $t(54) = 4.87$, $p < .001$, 95% CI [58.86, 141.30]. Expectancies regressed onto Condition, was also

significant (path a), $B = 4.17$, $t(54) = 2.55$, $p < .01$, 95% CI [0.89, 7.45]. The mediation effect, Total Drink Consumed regressed onto both Expectancies and Condition, was not significant when controlling for Condition (path b), $B = 1.93$, $t(54) = 1.13$, $p = 0.26$, 95% CI [-1.49, 5.35]; (path c'), $B = 92.03$, $t(54) = 4.24$, $p < .001$, 95% CI [48.51, 135.56].

As discussed above, the MBESS procedure also provides a mediation effect size and bootstrapped confidence intervals. The maximum value attainable by the mediation effect in this model was 153, whereas the observed mediation effect was 8.046 (see Figure 14),

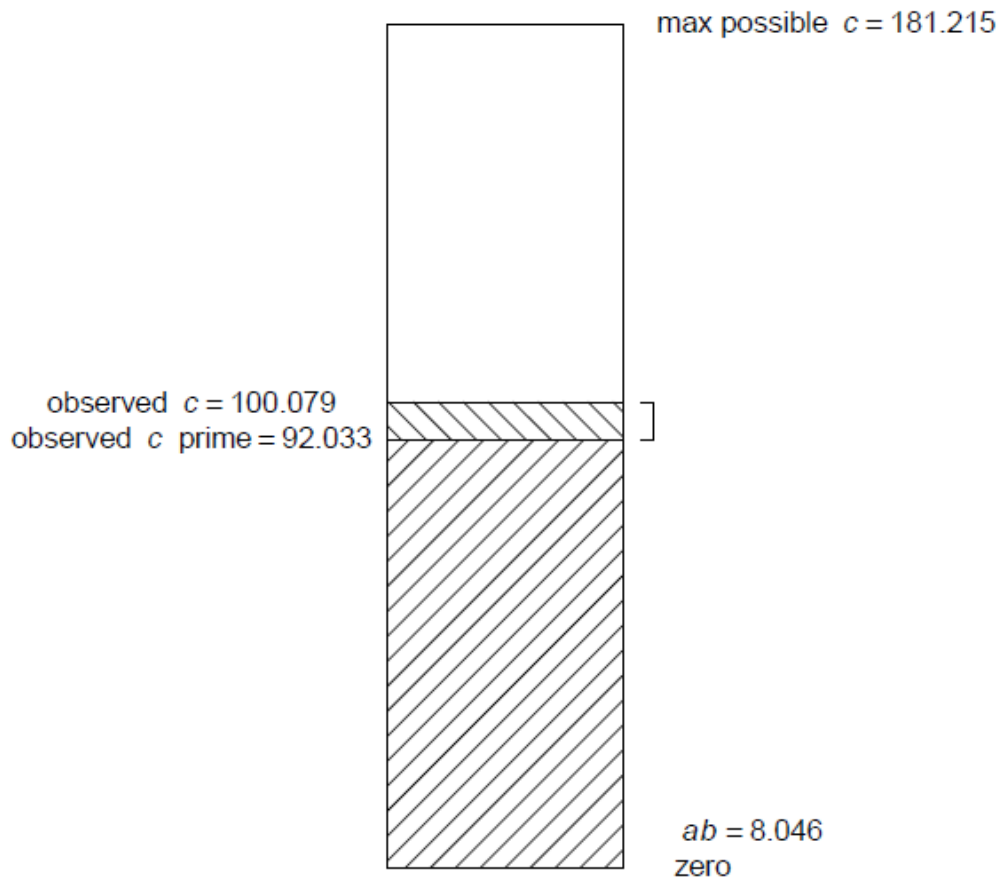

Figure 14. Mediation effect bar plot showing the mediation effect size against the direct effect on a scale of zero to the maximum mediation effect possible.

from which κ^2 was calculated to be 0.052, a small effect size (between Cohen's small, .01, and medium, .09). Confidence intervals were constructed for the mediation effect, 95% CI [-4.64 – 28.19], as well as the maximum effect possible, 95% CI [-160, 197.72], and κ^2 , 95% CI [0.001, .163].

Though perhaps unintuitive, but importantly for this study, the presence of a statistically significant unconditional indirect effect is not necessary to the presence of a conditional indirect effect (Preacher, Rucker & Hayes, 2007). Hypothesis 7 predicted Expectancies would mediate the relationship between the Condition by Difficulty Controlling interaction and Total Drink Consumed, or put another way, the strength of the indirect effect of Condition on Total Drink Consumed via Expectancies depends on the level of Difficulty Controlling.

Using a procedure designed by Preacher, Rucker and Hayes (2007; MODMED macro for SPSS) to test for conditional indirect effects, the moderated mediation model was run to estimate the effect of Condition on Total Drink Consumed through Expectancies at conditional values of Difficulty Controlling, as well as bootstrapped confidence intervals to provide an index of uncertainty and to aid interpretation. Except in very large samples, the product of coefficients is not normally distributed, and so for smaller samples the recommendation is to use bootstrapping (Preacher, Rucker & Hayes, 2007). Like the MBESS mediation procedure above, the MODMED procedure capitalizes on bootstrapping's advantages, including that it does not require the assumption that the mediation effect (i.e., ab , the product of coefficients) be normally distributed, to assess indirect effects.

Estimations were made of coefficients for the indirect effect of Condition on Total Drink Consumed via Expectancies and moderated by Difficulty Controlling. The conditional indirect

effect model was not significant, a finding that was somewhat expected following the results of the mediation model.

When the analytical aim is hypothesis significance testing, the null hypothesis of no indirect effect is rejected if confidence intervals do not contain zero, at the α significance level. But the confidence intervals approach can also be used to infer the magnitude of the effect, even when it isn't statistically significant. As in the case of the mediation model above, the moderated mediation model was examined in the context of confidence intervals. In this case, the range of plausible values of the conditional indirect effect was evaluated across levels of the moderator variable in order to assess the magnitude of the effect, independent of sample size. As can be seen in Figure 15, the confidence band includes zero at all levels of Difficulty Controlling, while the lower bound approaches zero near the moderator's mean ($M = 9.44, SE = 8.43$).

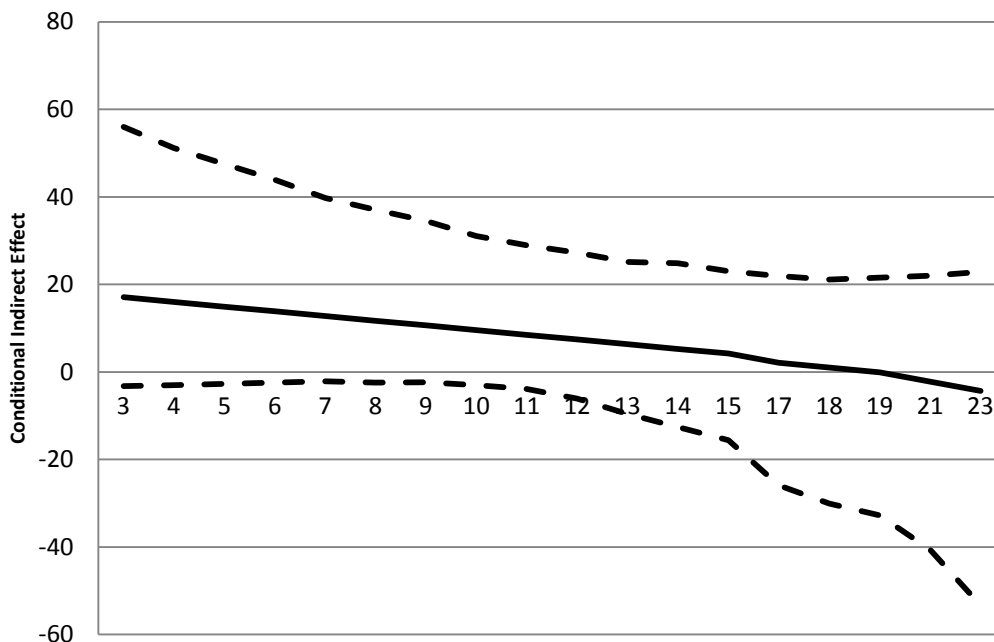

Figure 15. Conditional indirect effect at each level of the moderator with bootstrap 95% confidence band.

Discussion

The current study investigated the effects of self-control depletion on ad-lib alcohol consumption and the role of Cognitive-Emotional Preoccupation (originally referred to as Trait Temptation to Drink) and alcohol expectancies in these effects. Participants completed a pair of tasks in which they were instructed either to behave in a way that required self-control or to simply do the tasks (control manipulation). Then participants completed an alcohol expectancy manipulation or control manipulation before taking part in a taste test to measure their ad-lib placebo alcohol consumption. It was predicted that self-control depletion would increase ad-lib drinking and that Cognitive-Emotional Preoccupation would moderate this relationship so that within the Depleted self-control condition, participants higher in Cognitive-Emotional Preoccupation would drink more. Hypotheses predicted further that under self-control manipulation, changes in expectancy would mediate the moderated relationship between self-control and placebo alcohol consumption. Findings provided support for some predictions but not others and, whereas some results simply did not bear out, others warranted further consideration as data conformed to predicted patterns while falling short of statistical significance and these were subjected to exploratory analyses.

As predicted, and consistent with previous research, results revealed that self-control depletion led to increased drinking in a taste test. Contrary to hypotheses and previous findings, self-control effects did not appear to depend on levels of Cognitive-Emotional Preoccupation. Consistent with predicted patterns of data but not statistically significant, more drinking was observed among those exposed to expectancy primes than those who were not, and participants exposed to both manipulations drank the most. In contrast with predictions, self-control effects did not appear to operate through expectancies. Rather, in this study and by conventional

standards, these variables reflected patterns of relationship that suggest independent influence on drinking behavior. Using a more liberal, confidence interval-based approach to data interpretation, findings suggest hypothesized conditional indirect effects may be present but very small and beyond the detection capacity of the current design.

The findings of main effects are consistent both with the growing literature showing self-control depletion to be related to impaired self-control behavior and the smaller body of research linking it to drinking. The absence of clear conditional effects is more complicated. Muraven et al. (2002) found that Cognitive-Emotional Preoccupation moderated the relationship between self-control and drinking, whereas Christiansen, Cole and Field (2012) replicated the main effect and not the interaction. It seems that while the self-control depletion effect is rather robust, the effect of temptation to drink may be more sensitive to individual difference and contextual factors. In this sample, whereas the Cognitive-Emotional Preoccupation factor did not relate to self-control and drinking, its lower order factor, Difficulty Controlling drinking, showed a pattern of relationship that was consistent with hypotheses while falling short of statistical significance. Cognitive-Emotional Preoccupation may have been less influential in this sample than in Muraven et al. (2002), whose sample included older males (21-35 years of age, $M = 25.2$, $SD = 4.11$). And, even though the Difficulty Controlling by self-control interaction was not significant, it is worth noting that the interaction model resulted in a 2.1% increase in variance explained. Together with this study's small sample size and the outcome variable's relatively large variability ($SD = 204.02$, which equates to 6.90 ounces, or nearly 1/3 of available drink), these data suggest there may be an interaction effect after all, albeit a very small one. As to what might explain the difference in outcomes between studies, it may be that this study's sample of younger, heavier drinkers just does not think a lot about not drinking, which is what the

Cognitive-Emotional Preoccupation items probe. This group may recognize that they sometimes drink more than they intend (Difficulty Controlling drinking) without having yet developed nuanced insight into the thoughts and feelings associated, in effect missing the connection that may be evident to an older, more experienced heavy drinking sample.

Power Concerns

Insufficient power to detect small effects is a critical limitation of this study. Indeed, power is a problem for the field (Hayes, 2009). As psychology's body of research knowledge grows, questions become more complex, necessitating more degrees of freedom and larger samples, which are often difficult to obtain. In an effort to reduce uncertainty with a well-defined sample, the sampling strategy used in this study targeted participants most likely to have the drinking experience and attendant cognitive network presumed to underlie hypothesized effects; that is, young men who drink a lot. Unfortunately, those same qualities are associated with characteristics problematic for recruitment and scheduling reliability, both of which proved difficult in this study, resulting in low n and an underpowered study.

Despite power problems, some effects were relatively strong, especially in consideration of mitigating factors. For example, regarding the hypothesis that Depleted self-control groups would drink more, the 132.44 ml group difference that emerged is equivalent to 4.88 ounces, or 41% of a standard drink. Similarly, though it was not significant, group difference on the Expectancies manipulation was nonetheless 107.08 ml, which is equivalent to 3.62 ounces, or 30% of a standard drink. In real terms, these are non-trivial amounts, suggesting along with the effect's medium size that the lack of significant effect is likely due to low power in this study.

Low power probably played a role, as well, in the non-significant findings of Hypothesis 5, that Expectancies would relate to Total Drink Consumed in the Depleted but not in the Non-

Depleted condition. Two aspects of the Depleted condition's Expectancies to Total Drink Consumed relationship are notable: First, it is in the expected direction (Figure 12), with higher Expectancies increasing together with Total Drink Consumed, though not significantly ($r = .21$, $p = .27$). The Non-Depleted subsample also was non-significant ($r = .17$, $p = .41$). Importantly, the full sample's Expectancies to Total Drink Consumed relationship was significant ($r = .30$, $p < .05$), likely due in large part to its large size ($n = 56$) relative to the Depleted and Non-Depleted subsamples ($n = 30$ and $n = 26$, respectively).

Another potentially important aspect of the power problem for Hypothesis 5 involves the range of responses on the dependent variable. Examination of the scatterplot for Expectancies and Total Drink Consumed by self-control condition highlights the ceiling effect of Total Drink Consumed in the Depleted conditions (see Figure 8), in which five participants consumed the maximum 709.765 ml of drink available in the taste test and 9 others consumed within 12 ml of the maximum. Total Drink Consumed was calculated from the amount of liquid remaining in each of the two taste test bottles. The amount left by these drinkers represents just what is considered to be a "sip" of liquid, or half a sip per bottle (Pfaff, 1985). Importantly, all of those participants who consumed within a sip of the maximum were in the Depleted self-control conditions, whereas the next highest amount measured 80 ml less and was in the Expectancy-only condition (full self-control). In a test of independence on Ceiling Status (whether or not the participant drank within a sip of the max available) and Condition, the chi square statistic was significant, $\chi^2(3) = 16.36$, $p < .01$, suggesting that the alternative hypothesis of Ceiling Status' dependence on Condition cannot be ruled out. These data suggest that a larger sample drawn from this population is likely to generate a distribution of Total Drink Consumed at or near the maximum in the taste test as this study is currently designed. Future versions of this study should

adjust the maximum available drink accordingly to allow for higher volume consumption and elimination of the ceiling effect seen here.

The power problem is related to a similar problem under increasing scrutiny in psychology research, which is that of the utility of null hypothesis significance testing (NHST) as a scientific strategy. Concerns over the appropriateness of NHST are not new, but have been gaining more traction as statistical methodology develops the means to provide useful information that does not depend on NHST (Clark-Carter, 2003). For example, recent advances in computing technology have enabled the average investigator to make use of confidence intervals via bootstrapping as an alternative means of inference, a strategy recommended for decades but historically unavailable to many researchers due to the cost of necessary computing power. The NHST approach is scientifically useful because it reduces the likelihood of Type I error, but it provides information about what the hypothesized parameter is not likely to be and nothing about what it is likely to be. A common inference about the failure to reject the null is that the null is true, a statistically invalid conclusion that is also inconsistent with the real world in that any difference that equals exactly zero is unlikely (Aberson, 2002).

Results from this study illustrate the potential of nonparametric strategies such as bootstrapping to provide valuable information that a strict NHST approach would necessarily omit by using confidence intervals to provide additional valuable information about the hypothesized effect. For example, regarding the study's primary hypothesis of moderated mediation, NHST indicates that there is a greater than acceptable probability that the indirect effect equals zero. In this study, confidence intervals provided information that suggested that a non-zero conditional indirect effect is more likely than effect of zero, when considering moderator values at the mean or below. Table 6 shows precise confidence interval values at each

level of Difficulty Drinking. At a Difficulty Drinking score of 5, for instance, the conditional indirect effect is predicted to be 14.92, but could plausibly be as small as -2.69 or as large as 47.50. This pattern of values holds for levels of the moderator approaching and including the mean, at which point the confidence band shifts to include more and more negative range. This is important because it illustrates both the plausibility of mediation by Expectancies and the conditional nature of it as a function of Difficulty Controlling. Because the confidence band almost misses zero, it is reasonable to guess that increased sample size will reduce variability enough to narrow that gap around zero and yield statistically significant results.

Table 6.

Conditional indirect effect at each level of the moderator with bootstrap 95% confidence band.

<u>Moderator (Difficulty Controlling)</u>	<u>Lower Bound</u>	<u>Indirect Effect (<i>ab</i>)</u>	<u>Upper Bound</u>
3	-3.2554	17.0609	56.0104
4	-2.9942	15.9901	51.1482
5	-2.6906	14.9192	47.5003
6	-2.4406	13.8483	43.894
7	-2.1308	12.7775	39.7714
8	-2.4555	11.7066	37.0218
9	-2.3397	10.6358	34.4908
10	-2.9803	9.5649	31.0436
11	-3.9128	8.494	28.9199
12	-6.0583	7.4232	27.2558
13	-9.5793	6.3523	25.1196
14	-12.6124	5.2814	24.8434
15	-15.5682	4.2106	23.0188
17	-25.8699	2.0689	21.8896
18	-30.0785	0.998	21.099
19	-32.7767	-0.0729	21.5871
21	-40.5996	-2.2146	21.9999
23	-53.3136	-4.3563	22.8612

Assuming the presence of the conditional indirect effect, what does the data say about its validity? The graphic representation in Figure 15 suggests that self-control affects drinking through its effects on expectancies for those who report low levels of difficulty controlling their drinking and increasingly less so among those who report greater difficulty controlling their drinking. Put another way, for those who have more difficulty controlling drinking, self-control and expectancies operate relatively independently, whereas self-control acts through expectancies among those with less difficulty. Practically (and admittedly speculatively) speaking, it may mean that, in this sample, drinking control problems stem from a disconnect between what a young man expects to happen when he drinks and his ability to manage that outcome when his self-control is low. In other words, higher rated expectancies tend to reflect desirable outcomes, whereas situations involving the assessment that one drank “too much” are presumably associated with less positive outcomes. It may be that those who tend to drink within their limits predict more positive experiences because they tend to experience more positive outcomes, while those with difficulty controlling their drinking expect outcomes that are less positive due to overconsumption, but then tend to drink more than intended anyway. This may be an example of the complexity of addiction; the early picture of the young drinker on the path to becoming one who continues to drink excessively despite negative life outcomes.

Limitations

This study has several limitations, not the least of which is low power, which was discussed at length above. Other limitations include a probably unrepresentative sample. Although this study’s selection strategy was intentional, future studies will want to consider the role of expectancies in self-control-related drinking decisions among other populations, as well, including females, older and younger participants. This study’s primarily white, non-Hispanic

sample was not intentional and the field would benefit from attention to these questions among minority populations, as well.

Also, there is reason to wonder whether any laboratory-based exercise in self-control exercise, such as the one described here, can sufficiently approximate real-world situations. Our protocol set the situation up to mimic a legitimate self-control scenario, but the participants were present of their own accord and it cannot be known how well each had taken stock of his responsibilities and potential outcomes related to the in-lab drink consumption. The field should continue to develop externally valid measures of self-control, especially that can simulate the important outcomes associated with potentially dangerous self-control decisions, such as alcohol consumption.

Finally, it would certainly be of great benefit to be able to use the information from this study's confidence bands to estimate the sample size necessary to generate clearly meaningful results, but this would require an estimate of power to detect conditional indirect effects and, unfortunately, this relatively new area of methodological study has not yet developed the means to do so (Hayes, 2009; Preacher, Rucker & Hayes, 2007).

Conclusion

In summary, this study's results offer support for the resource model of self-control depletion in the context of drinking decisions. Participants in the depleted self-control condition drank more placebo alcohol despite being reminded to be ready for an upcoming memory task. Hypotheses of conditional and indirect effects consistent with a process model of self-control were not supported. Using nonparametric analytic techniques, patterns in the data emerged suggestive of conditional indirect effects, though they appear to be very small in scale. Findings

support the further exploration of the primary hypotheses, given the consideration of current limitations.

References

- Ackerman, J. A., Goldstein, n. J., Shapiro, J. R., & Bargh, J. A. (2009). You wear me out: The vicarious depletion of self-control. *Psychological Science, 20*, 326-332.
- Baker, T. B., Piper, M. E., McCarthy, D. E., Majeskie, M. R., & Fiore, M. C. (2004). Addiction motivation reformulated: An affective processing model of negative reinforcement. *Psychological Review, 111*, 33-51.
- Bandura, A. (1977). Self-efficacy: Toward a unifying theory of behavioral change. *Psychological Review, 84*, 191-215.
- Bargh, J. A. (1994). The Four Horsemen of automaticity: Awareness, efficiency, intention, and control in social cognition. In R. S. Wyer, Jr., & T. K. Srull (Eds.), *Handbook of social cognition (2nd ed., pp. 1-40)*. Hillsdale, NJ: Erlbaum.
- Bargh, J. A., & Chartrand, T. L. (1999). The unbearable automaticity of being. *American Psychologist, 54*, 462-479.
- Baumeister, R. F., & Heatherton, T. F. (1996). Self-regulation failure: An overview. *Psychological Inquiry, 7*, 1-15.
- Baumeister, R. F. (2002). Yielding to Temptation: Self-Control Failure, Impulse Purchasing, and Consumer Behavior. *Journal of Consumer Research, 28*, 670-676.
- Baumeister, R. F. (2003). Ego Depletion and Self-Regulation Failure: A Resource Model of Self-Control. *Alcoholism: Clinical and Experimental Research, 27*(2), 1-4.
- Baumeister, R. F., Bratslavsky, E., Muraven, M., & Tice, D. M. (1998). Ego depletion: Is the active self a limited resource? *Journal of Personality and Social Psychology, 74*(5), 1252-1265.
- Baumeister, R. F., Vohs, K. D., & Tice, D. M. (2007). The strength model of self-control. *Current Directions in Psychological Science, 16*, 351-355.
- Beck, A. T. (1967). *Depression: Clinical experimental and theoretical aspects*. New York: Harper & Row.
- Beedie, C. J., & Lane, A. M. (2012). The role of glucose in self-control: Another look at the evidence and an alternative conceptualization. *Personality and Social Psychology Review, 16*, 143-153.

- Berridge, K.C. & Robinson, T.E. (2003). Parsing reward. *Trends in Neuroscience*, 26(9), 507–513.
- Bolles, R. C. (1972). The avoidance learning problem. In G. Bower (Ed.), *The psychology of learning and motivation*. Vol. 6. New York: Academic Press.
- Brady Reynolds, Amanda Ortengren, Jerry B. Richards, and Harriet de Wit. Dimensions of impulsive behavior: Personality and behavioral measures. *Personality and individual differences* 40 (2):305-315, 2006.
- Broadbent, D. E. (1958). *Perception and communication*. New York: Oxford University Press.
- Carver, C. S., & Scheier, M. F. (1981). *Attention and self-regulation: A control theory approach to human behavior*. New York: Springer.
- Carver, C. S., & Scheier, M. F. (1990). Origins and functions of positive and negative affect: A control-process view. *Psychological Review*, 97, 19-35.
- Catanzaro, S. J., & Mearns, J. (1990). Measuring generalized expectancies for negative mood regulation: Initial scale development and implications. *Journal of Personality Assessment*, 54, 546-563.
- Chen, A.C., Porjesz, B., Rangaswamy, M., Kamarajan, C., Tang, Y., Jones, K.A., Chorlian, D.B., Stimus, A.T., Begleiter, H. (2007). Reduced frontal lobe activity in subjects with high impulsivity and alcoholism. *Alcoholism: Clinical and Experimental Research*, 31(1), 156–165.
- Chris Aberson. Interpreting null results: Improving presentation and conclusions with confidence intervals. *Journal of Articles in Support of the Null Hypothesis* 1 (3):36-42, 2002.
- Christiansen, P., Cole, J., & Field, M. (2012). Ego depletion increases ad-lib alcohol consumption: investigating cognitive mediators and moderators. *Experimental and Clinical Psychopharmacology*, 20(2), 118-128.
- Cohen, J. (1988). *Statistical power analysis for the behavioral sciences (2nd Ed.)*. Hillsdale, NJ: Erlbaum.
- Collins, R. L., & Lapp, W. M. (1992). The Temptation and Restraint Inventory for measuring drinking restraint. *British Journal of Addiction*, 87, 625–633.
- Cox, D. R., & Oakes, D. (1984). *Analysis of survival data (Vol. 21)*. CRC Press.
- Cox, W. M., & Klinger, E. (1988). A motivational model of alcohol use. *Journal of Abnormal Psychology*, 97, 168-180.

- Crawford, J. R., & Henry, J. D. (2004). The Positive and Negative Affect Schedule (PANAS): Construct validity, measurement properties and normative data in a large non-clinical sample. *British Journal of Clinical Psychology*, *43*, 245–265.
- D. Clark-Carter. Effect size-The missing piece in the jigsaw. *Psychologist* *16* (12):636-638, 2003.
- Darkes, J. & Goldman, M. S. (1998) Expectancy challenge and drinking reduction: Process and structure in the alcohol expectancy network. *Experimental and Clinical Psychopharmacology*, *6*, 64–76.
- Darkes, J. & Goldman, M.S., (1993). Expectancy challenge and drinking reduction: Experimental evidence for a mediational process. *Journal of Consulting And Clinical Psychology*, *61*, 344-353.
- Deborah A. Dawson, Bridget F. Grant, Frederick S. Stinson, and Patricia S. Chou. Maturing out of alcohol dependence: The impact of transitional life events. *Journal of Studies on Alcohol and Drugs* *67* (2):195, 2006.
- Deutsch, R., & Strack, F. (2006). Duality models in social psychology: From dual processes to interacting systems. *Psychological Inquiry*, *17*, 166-172.
- Dunn, M. E. & Goldman, M. S. (1998) Age and drinking-related differences in the memory organization of alcohol expectancies in 3rd-, 6th-, 9th-, and 12th-grade children. *Journal of Consulting and Clinical Psychology*, *66*, 579–585.
- Dunn, M.E., Lau, H.C., & Cruz, I.Y. (2000). Changes in Activation of Alcohol Expectancies in Memory in Relation to Changes in Alcohol Use After Participation in an Expectancy Challenge Program. *Experimental and Clinical Psychopharmacology*, *8*, 566-575.
- Dylan D. Wagner, Myra Altman, Rebecca G. Boswell, William M. Kelley, and Todd F. Heatherton. Self-regulatory depletion enhances neural responses to rewards and impairs top-down control. *Psychological science* :0956797613492985, 2013.
- Friese, M., Hofmann, W., & Wanke, M. (2008). When impulses take over: Moderated predictive validity of implicit and explicit attitude measures in predicting food choice and consumption behavior. *British Journal of Social Psychology*, *47*, 397-419.
- Gailliot, M. T., Baumeister, R. F., DeWall, C. n., Maner, J. K., Plant, E. A., Tice, D. M., et al. (2007). Self-control relies on glucose as a limited energy source: Willpower is more than a metaphor. *Journal of Personality and Social Psychology*, *92*(2), 325-336.
- Goldman, M. S. & Rather, B. C. (1993). Substance use disorders: cognitive models and architecture, in: Dobson, K. S. & Kendall, P. C. (Eds) *Psychopathology and Cognition*, (pp. 254–292) London, Academic Press, Inc.

- Goldman, M. S., & Darkes, J. (2004). Alcohol expectancy multiaxial assessment: A memory network-based approach. *Psychological Assessment, 16*, 4–15.
- Goldman, M. S., Brown, S. A., & Christiansen, B. A. (1987). Expectancy theory: Thinking about drinking. In H. T. Blane & K. E. Leonard (Eds.), *Psychological theories of drinking and alcoholism* (pp. 181- 226). New York: Guilford Press.
- Goldman, M.S. (2002). Expectancy and risk for alcoholism: The unfortunate exploitation of a fundamental characteristic of neurobehavioral adaptation. *Alcoholism: Clinical And Experimental Research, 26*(5), 737-746.
- Goldman, M.S., Darkes, J. & Del Boca, F.K. (1999). Expectancy mediation of biopsychosocial risk for alcohol use and alcoholism. In I. Kirsch (Ed.), *How Expectancies Shape Experience* (pp. 233-262). Washington, D.C: American Psychological Association.
- Goldman, M.S., Darkes, J., Reich, R.R., & Brandon, K.O. (2006). From DNA to conscious thought: The influence of anticipatory processes on human alcohol consumption. In: Munafò, M., Albery, I.P. (Eds.), *Cognition and addiction*. Oxford University Press; New York, NY.
- Gray, J. A. (1981). A critique of Eysenck's theory of personality. In H. J. Eysenck (Ed.), *A model for personality* (pp. 246–276). Berlin: Springer-Verlag.
- Greeley, J., & Oei, T. (1999). Alcohol and tension reduction. In: Leonard, K.E., Blane, H.T., (Eds.), *Psychological theories of drinking and alcoholism: Second edition* (pp. 14–53). New York: Guilford Press.
- Gross, J. J. (1998). Antecedent- and response-focused emotion regulation: Divergent consequences for experience, expression, and physiology. *Journal of Personality and Social Psychology, 74*(1), 224-237.
- Hagger, M. S., Wood, C., Stiff, C., & Chatzisarantis, n. L. D. (2010). Ego-depletion and the strength model of self-control: A meta-analysis. *Psychological Bulletin, 136*, 496-525.
- Hasher, L., & Zacks, R. (1979). Automatic and effort full, processes in memory. *Journal of Experimental Psychology: General, 108*, 356-388.
- Henningsen, A. (2010). Estimating Censored Regression Models in R using the censReg Package. *R package vignettes*.
- Hull, J. G., & Slone, L.B. (2004). Alcohol and Self-regulation. In R. F. Baumeister & K. D. Vohs, *Handbook of Self-regulation: Research, Theory, and Applications* (pp. 467-492). New York: Guilford Press.
- Inzlicht, M., & Schmeichel, B. J. (2012). What is ego depletion? Toward a mechanistic revision of the resource model of self-control. *Perspectives on Psychological Science, 7*, 450-463.

- Jajodia, A., & Earleywine, M. (2003). Measuring alcohol expectancies with the implicit association test. *Psychology of Addictive Behaviors, 17*, 126-133.
- Jennifer L. Burden and Stephen A. Maisto. Expectancies, evaluations and attitudes: Prediction of college student drinking behavior. *Journal of Studies on Alcohol and Drugs* 61 (2):323, 2000.
- Job, V., Dweck, C., & Walton, G. (2010). Ego depletion: Is it all in your head? Implicit theories about willpower affect self-regulation. *Psychological Science, 21*, 1686–1693.
- Johnston, L. D., O'Malley, P. M., Bachman, J. G., & Schulenberg, J. E. (2012). *Monitoring the Future national survey results on drug use, 1975-2011. Volume I: Secondary school students*. Ann Arbor: Institute for Social Research, The University of Michigan, 760 pp.
- Kanfer, F. H., & Karoly, P. (1972). Self-control: A behavioristic excursion into the lion's den. *Behavior Therapy, 3*, 398-416.
- Kelley, K. (2010). MBESS. In n. Salkind (Ed.), *Encyclopedia of research design*. (pp. 779-780). Thousand Oaks, CA: SAGE Publications, Inc. doi: <http://dx.doi.org/10.4135/9781412961288.n234>
- Kenneth J. Sher, Emily R. Grekin, and Natalie A. Williams. The development of alcohol use disorders. *Annu.Rev.Clin.Psychol.* 1:493-523, 2005.
- Kirsch, I. (1985). Response expectancy as a determinant of experience and behavior. *American Psychologist, 40*, 1189–202.
- Kramer, D.A. & Goldman, M.S. (2003). Using a modified Stroop task to implicitly discern the cognitive organization of alcohol expectancies. *Journal of Abnormal Psychology, 112*(1), 171-175.
- MacKinnon, D. P., Lockwood, C. M., Hoffman, J. M., West, S. G., & Sheets, V. (2002). A comparison of methods to test mediation and other intervening variable effects. *Psychological Methods, 7*(1), 83.
- Maddux, J.E. (1999). Expectancies and the Social-Cognitive Perspective: Basic Principles, Processes, and Variables. In I. Kirsch (Ed.), *How Expectancies Shape Experience* (pp. 17-40). Washington, D.C: American Psychological Association.
- Magid, V., Colder, C.R. (2007). The UPPS impulsive behavior scale: Factor structure and associations with college drinking. *Personality and Individual Differences, 43*(7), 1927–1937.
- Marc A. Schuckit. An overview of genetic influences in alcoholism. *Journal of substance abuse treatment* 36 (1):S5-14, 2009.

- Martijn, C., Tenbült, P., Merckelbach, H., Dreezens, E., & de Vries, n.K. (2002). Getting a grip on ourselves: Challenging expectations about loss of energy after self-control. *Social Cognition, 20*, 441–460.
- Matthew McBee. Modeling outcomes with floor or ceiling effects: An introduction to the Tobit Model. *Gifted Child Quarterly 54* (4):314-320, 2010.
- McEvoy, P. M., Stritzke, W. G. K., French, D. J., Lang, A. R. and Ketterman, R. (2004), Comparison of three models of alcohol craving in young adults: a cross-validation. *Addiction, 99*, 482–497.
- Michael Inzlicht, Brandon J. Schmeichel, and C. Neil Macrae. Why self-control seems (but may not be) limited. *Trends in cognitive sciences 18* (3):127-133, 2014.
- Mischel, W., Ebbesen, E.B., & Zeiss, A.R. (1972). Cognitive and Attentional Mechanisms in Delay of Gratification. *Journal of Personality and Social Psychology, 21*(2), 204-218.
- Mischel, W., Shoda, Y., & Rodriguez, M. L. (1989). Delay of gratification in children. *Science, 244*, 933-938.
- Molden, D. C., Hui, C. M., Noreen, E. E., Meier, B. P., Scholer, A. A., D'Agostino, P. R., & Martin, V. (2012). The motivational versus metabolic effects of carbohydrates on self-control. *Psychological Science, 23*, 1130–1137.
- Muraven M, Baumeister RF (2000) Self-regulation and depletion of limited resources: does self-control resemble a muscle? *Psychological Bulletin, 126*,247–259.
- Muraven, M., Collins, R. L., & Nienhaus, K. (2002). Self-control and alcohol restraint: An initial application of the self-control strength model. *Psychology of Addictive Behaviors, 16*, 113–120.
- Muraven, M., Collins, R. L., Shiffman, S., & Paty, J. A. (2005). Daily fluctuations in self-control demands and alcohol intake. *Psychology of Addictive Behaviors, 19*, 140–147.
- Muraven, M., Shmueli, D., & Burkley, E. (2006). Conserving self-control strength. *Journal of Personality and Social Psychology, 91*, 524–537.
- Muraven, M., Tice, D. M., & Baumeister, R. F. (1998). Self-control as a limited resource: Regulatory depletion patterns. *Journal of Personality and Social Psychology, 74*, 774–789.
- Murray, K., & Kochanska, G. (2002). Effortful control: Factor structure and relation to externalizing and internalizing behaviors. *Journal of Abnormal Child Psychology, 30*, 503–514.

- National Institutes of Health: *Task Force of the National Advisory Council on Alcohol abuse and Alcoholism. A Call to Action: Changing the Culture of Drinking at U.S. Colleges.* Available online: www.collegedrinkingprevention.gov, 2004.
- Oei TPS & Baldwin A. (1994). Expectancy Theory: A Two Process Model of Alcohol Use and Abuse. *Journal of Studies on Alcohol*, 55, 525-34.
- Ostafin, B. D., Marlatt, G. A., & Greenwald, A. G. (2008). Drinking without thinking: An implicit measure of alcohol motivation predicts failure to control alcohol use. *Behaviour Research and Therapy*, 46, 1210-1219.
- Pfaff, D. W. (1985). *Taste, olfaction, and the central nervous system. A festschrift in honor of Carl Pfaffmann.* Donald W. Pfaff, Editor, Rockefeller University Press, New York, pp. 197.
- R Development Core Team (2007b). R: A language and environment for statistical computing [Computer software and manual]. *R Foundation for Statistical Computing*. Retrieved from www.r-project.org.
- Rather, B. C. and Goldman, M.S., (1994). Drinking-related differences in the memory organization of alcohol expectancies. *Experimental and Clinical Psychopharmacology*, 2, 167–183.
- Rather, B. C., Goldman, M. S., Roehrich, L., & Brannick, M. (1992). Empirical modeling of an alcohol expectancy memory network using multidimensional scaling. *Journal of Abnormal Psychology*, 101, 174-183.
- Reich R. R., Below M. C., Goldman M. S. (2010). Explicit and implicit measures of expectancy and related alcohol cognitions: a meta-analytic comparison. *Psychology of Addictive Behaviors*, 24, 13–25.
- Reich, R.R., Goldman, M.S. & Noll, J.A. (2004). Using a false memory paradigm to test two key elements of alcohol expectancy theory. *Experimental and Clinical Psychopharmacology*, 12(2), 102-110.
- Robinson, T.E. & Berridge, K.C. (1993). The neural basis of drug craving: An incentive-sensitization theory of addiction. *Brain Research Reviews*, 18, 247 – 291.
- Roehrich, L., & Goldman, M. S. (1995). Implicit priming of alcohol expectancy memory processes and subsequent drinking behavior. *Experimental and Clinical Psychopharmacology*, 3, 402-410.
- Rothbart, M. K., & Bates, J. E. (1998). Temperament. In W. Damon (Series Ed.) & n. Eisenberg (Vol. Ed.), *Handbook of child psychology: Vol. 3. Social, emotional and personality development (5th ed., pp. 105-176)*. New York: Wiley.

- Rotter, J. B. (1982). *The development and application of social learning theory. Selected papers*. New York: Praeger.
- Russell, J. A. (1980). A circumplex model of affect. *Journal of Personality and Social Psychology*, *39*, 1161-1178.
- Russell, J. A. (1989). Measures of emotion. In R. Plutchik & H. Kellerman (Eds.), *Emotion: Theory, research, and experience (Vol. 4, pp. 83-111)*. San Diego, CA: Academic Press.
- Russell, J. A. (2003). Core affect and the psychological construction of emotion. *Psychological Review*, *110*, 145–172.
- Sayette, M.A. (1993). An appraisal-disruption model of alcohol's effects on stress responses in social drinkers. *Psychological Bulletin*, *114*, 459-476
- Schmeichel, B., Vohs, K., & Baumeister, R.F. (2003). Intellectual Performance and Ego Depletion: Role of the Self in Logical Reasoning and Other Information Processing. *Journal of Personality and Social Psychology*, *85*(1), 33-46.
- Shiffrin, R. M., & Schneider, W. (1977). Controlled and automatic human information processing. II. Perceptual learning, automatic attending and a general theory. *Psychological Review*, *84*(2), 127–190.
- Smith, G. T., Simmons, J. R., Flory, K., Annus, A. M., & Hill, K. K. (2007). Thinness and eating expectancies predict subsequent binge-eating and purging behavior among adolescent girls. *Journal of Abnormal Psychology*, *116*, 188–197.
- Stein, K. D., Goldman, M. S., & Del Boca, F. K. (2000). The influence of alcohol expectancy priming and mood manipulation on subsequent alcohol consumption. *Journal of Abnormal Psychology*, *109*, 106–115.
- Susan Nolen-Hoeksema. Gender differences in risk factors and consequences for alcohol use and problems. *Clinical psychology review* *24* (8):981-1010, 2004.
- Theresa Dahm, Hamid Taher Neshat-Doost, Ann Marie Golden, Elizabeth Horn, Martin Hagger, and Tim Dalgleish. Age shall not weary us: deleterious effects of self-regulation depletion are specific to younger adults. *PloS one* *6* (10):e26351, 2011.
- Tice, D. M., Bratslavsky, E., & Baumeister, R. F. (2001). Emotional distress regulation takes precedence over impulse control: If you feel bad, do it! *Journal of Personality and Social Psychology*, *80*(1), 53-67.
- Tiffany, S.T. (1990). A cognitive model of drug urges and drug-use behavior: Role of automatic and nonautomatic processes. *Psychological Review*, *97*, 147-168.

- Tolman, E.C. (1932). *Purposive behavior in animals and men*. New York: Appleton-Century-Crofts.
- Tversky, A.; Kahneman, D. (1981). The framing of decisions and the psychology of choice. *Science*, 211(4481): 453–458.
- Watson, D., Clark, L.A., & Tellegen, A. (1988). Development and validation of brief measures of positive and negative affect: The PANAS scales. *Journal of Personality & Social Psychology*, 54, 1063-1070.
- Wegner, D. M. (1994). Ironic processes of mental control. *Psychological Review*, 101, 34–52.
- Wenzlaff, R. M., & Wegner, D. M. (2000). Thought suppression. *Annual Review of Psychology*, 51, 59-91.
- Whiteside, S. P., & Lynam, D. R. (2001). The Five Factor Model and impulsivity: using a structural model of personality to understand impulsivity. *Personality and individual differences*, 30, 669-689.
- Wiers, R. W., & Stacy, A. W. (2006). Implicit cognition and addiction. *Current Directions in Psychological Science*, 15, 292-296.
- Wiers, R.W., van Woerden, n., Smulders, F.T., de Jong, P.J. (2002). Implicit and explicit alcohol-related cognitions in heavy and light drinkers. *Journal of Abnormal Psychology*, 111, 648-658.
- Wise, R. A. (2002). Brain reward circuitry: Insights from unsensed incentives. *Neuron*, 36(2), 229-240.
- Wouter Kool and Matthew Botvinick. A labor/leisure tradeoff in cognitive control. *Journal of Experimental Psychology: General* 143 (1):131, 2014.
- Wouter Kool, Joseph T. McGuire, Gary J. Wang, and Matthew M. Botvinick. Neural and behavioral evidence for an intrinsic cost of self-control. *PloS one* 8 (8):e72626, 2013.

Appendices

Appendix A: Demographics Questionnaire

1. What is your age? _____
2. What is your gender? _____
3. Which of the following best describes you?
 - i. Native American/American Indian
 - ii. Asian
 - iii. Pacific Islander
 - iv. African-American/Black, not of Hispanic origin
 - v. African-American/Black, and of Hispanic origin
 - vi. Caucasian/White, not of Hispanic origin
 - vii. Caucasian/White, and of Hispanic origin
 - viii. Hispanic/Latino origin
 - ix. Other
4. What was the highest level of education that you attained?
 - i. Grade 8 or less
 - ii. Some high school
 - iii. High school graduate or GED
 - iv. Vocational training or certificate
 - v. Some college
 - vi. College graduate
 - vii. Some college past BA or BS (graduate school)
 - viii. Attained Master's Degree (e.g., M.A., M.S.W., M.B.A.)
 - ix. Attained Doctoral (Ph.D.) or professional degree (e.g., M.D.)

Appendix B: Drinking Style Questionnaire

1. Which of the following best describes you?

- (0) Used to drink in the past, but now abstain from alcohol
- (1) Light drinker
- (2) Social drinker
- (3) Moderate drinker
- (4) Regular drinker
- (5) Heavy drinker
- (6) Recovering alcoholic

2. During the past month, about how frequently did you drink alcohol? Please indicate the response below which comes closest to describing your drinking pattern.

- (0) Never
- (1) Once
- (2) 2 or 3 times
- (3) Once or twice a week
- (4) 3 or 4 times a week
- (5) 5 or more times per week

3. On occasions when you drink, about how many drinks do you typically consume? Please estimate the actual number of drinks, where:

1 drink = approximately: 1 can of beer, or 1 glass of wine or wine cooler, or 1 serving of liquor or a mixed drink

- (0) None; I don't drink
- (1) One drink
- (2) 2 drinks
- (3) 3 drinks
- (4) 4 drinks
- (5) 5 drinks
- (6) 6-8 drinks
- (7) 9-12 drinks
- (8) 13-16 drinks
- (9) 17 or more drinks

Appendix C: Alcohol Expectancy Multi-Axial Assessment – Short



THE MEN'S PERSPECTIVE INITIATIVE
Lifestyle Questionnaire

Alcohol Expectancy Multi-Axial Assessment (AEMax)

This page contains words describing possible effects of alcohol. For each word, imagine it completing the sentence: "DRINKING ALCOHOL MAKES ONE _____." Then, for each word **mark the number that indicates how often you think that this effect happens or would happen after drinking several drinks of alcohol.** "Drinking alcohol" refers to drinking any alcoholic beverage such as beer, wine, wine coolers, whiskey, scotch, vodka, gin, or mixed drinks.

There are no right or wrong answers. Answer each item quickly according to your first impression and according to your own personal beliefs about the effects of alcohol. Please mark your answers on the space to the right of each item.

0	1	2	3	4	5	6
Never	Very Rarely	Rarely	Occasionally	Frequently	Very Frequently	Always

"DRINKING ALCOHOL MAKES ONE _____."

- | | | | |
|-----------------|-------|------------------|-------|
| 1. Appealing | _____ | 13. Horny | _____ |
| 2. Arrogant | _____ | 14. Ill | _____ |
| 3. Attractive | _____ | 15. Light-headed | _____ |
| 4. Beautiful | _____ | 16. Lustful | _____ |
| 5. Cocky | _____ | 17. Nauseous | _____ |
| 6. Dangerous | _____ | 18. Outgoing | _____ |
| 7. Deadly | _____ | 19. Sick | _____ |
| 8. Dizzy | _____ | 20. Sleepy | _____ |
| 9. Drowsy | _____ | 21. Sociable | _____ |
| 10. Egotistical | _____ | 22. Social | _____ |
| 11. Erotic | _____ | 23. Tired | _____ |
| 12. Hazardous | _____ | 24. Woozy | _____ |

Appendix D: Affect Grid

The “affect grid” is used to describe feelings. It is in the form of a square - a kind of “map” for feelings. **The center of the square (marked by X in the grid to the right) represents a neutral, average, everyday feeling. It is neither positive nor negative.**

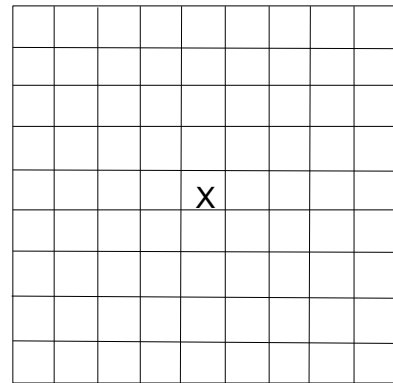

Horizontal Dimension (left to right)

This dimension represents pleasantness. The right half of the grid represents pleasant feelings. **The farther to the right, the more pleasant.** The left half of the grid represents unpleasant feelings. **The farther to the left, the more unpleasant.**

Vertical Dimension (up and down)

This dimension represents arousal. Arousal has to do with how awake, alert, or activated a person feels –**independent of whether the feeling is positive or negative.** The top half is for feelings that are above average in arousal. The lower half is for feelings below average. **The bottom of the grid represents sleep. The higher you go on the grid, the more awake you feel.**

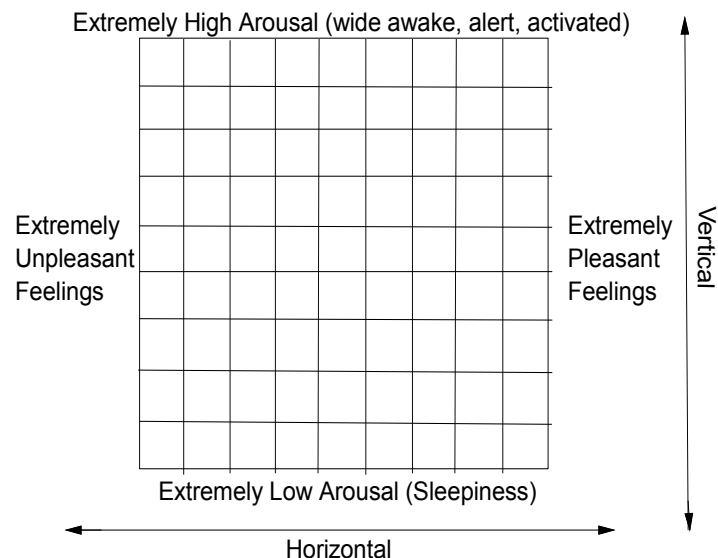

EXAMPLE: Suppose you go to your friend's house. When you arrived, you were very surprised to learn that your friends were throwing a party for your birthday. Because you like surprise parties, you found this experience very pleasant. You might put your mark as shown below.

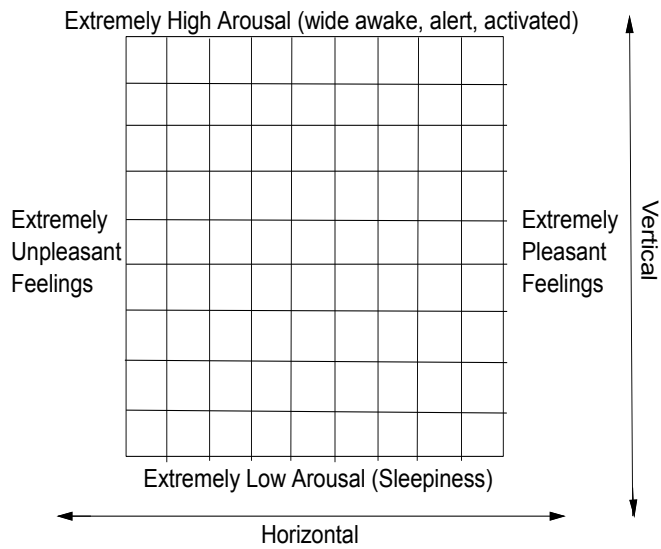

Please place a mark inside the square of the grid that best describes how you feel right now.

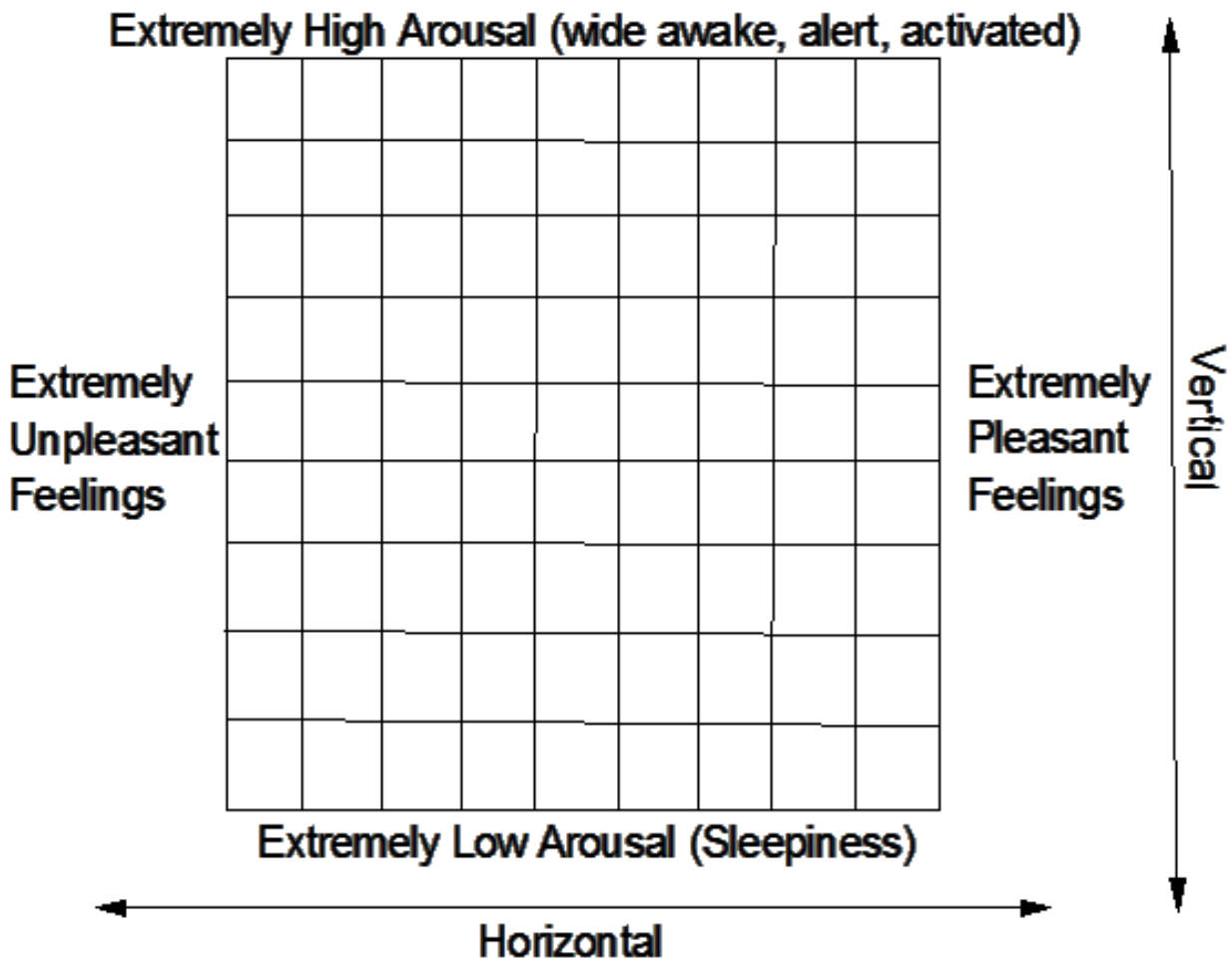

Appendix E: Memory Association task (Expectancy Prime)

Write next to each word the first word it makes you think of. For example, if the word is 'doctor' you might write 'nurse.' Work quickly!

sample: dog: cat

1. hand: _____
2. draft: _____
3. line: _____
4. cap: _____
5. pitcher: _____
6. trunk: _____
7. tap: _____
8. wing: _____
9. book: _____
10. issue: _____
11. try: _____
12. honey: _____
13. clip: _____
14. mug: _____
15. vault: _____
16. return: _____
17. hold: _____
18. scrub: _____
19. shot: _____
20. blue: _____

Appendix F : Emotion Suppression Manipulation Check

Please indicate the extent to which you agree or disagree with the statements below using the following scale.

0	1	2	3	4	5	6
Strongly disagree			Somewhat agree			Strongly agree

1. During the film, I tried not to feel anything at all. 0 1 2 3 4 5 6

2. During the film, I felt emotions, but tried to hide them. 0 1 2 3 4 5 6

3. During the film, I reacted completely spontaneously. 0 1 2 3 4 5 6

4. During the film, I was motivated to conceal my emotions. 0 1 2 3 4 5 6

Thought Suppression Manipulation Check Please indicate the extent to which you agree or disagree with the statements below using the following scale.

0	1	2	3	4	5	6
Strongly disagree			Somewhat agree			Strongly agree

1. During thought listing, I tried not to think about the video. 0 1 2 3 4 5 6

2. During thought listing, I thought of the video, but ignored it. 0 1 2 3 4 5 6

3. During thought listing, I reacted completely spontaneously. 0 1 2 3 4 5 6

4. During thought listing, I was motivated to control my thoughts. 0 1 2 3 4 5 6

Appendix G: Exertion Assessment

1. While watching the movie, how much effort did it take to follow the instructions?

0	1	2	3	4
5	6			
No Effort			Some Effort	
Extreme Amount				
	Of Effort			

2. While watching the movie, how difficult was it to follow the instructions?

0	1	2	3	4
5	6			
Not			Somewhat	
Very				
Difficult				
Difficult				

3. While watching the movie, how fatiguing was it to follow the instructions?

0	1	2	3	4	5
			6		
Not			Somewhat		
Very Fatiguing					
			Fatiguing		

4. While watching the movie, how motivated were you to follow the instructions?

0	1	2	3	4
5	6			
Not			Somewhat	
Very Motivated				
Motivated				

5. While watching the movie, how motivated were you to control your emotions?

0	1	2	3	4
5	6			
Not			Somewhat	
Very Motivated				
Motivated				

Appendix H: Effects of Drinks

Effects of Alcohol

In the blank spaces provided below, please write down the words or short phrases you would use to complete the phrase “Alcohol makes me _____.” If you do not drink alcohol, please indicate what you think would happen if you did drink. Please write your responses in order, starting with the top blank and working down toward the bottom or last (fifth) blank. Please write whatever first comes to mind. Do not think too long. Respond as quickly as you can, but please write legibly.

1. _____

2. _____

3. _____

4. _____

5. _____

Now that you have provided these responses, on a 1 - 7 scale please rate each response on how pleasant it is and how arousing it is below. For example, a response that you would consider extremely pleasant might be rated as 6 or 7, while one that was extremely unpleasant might be 2 or 1. A high arousal response (alert, active, or wide awake) might be scored 6 or 7, while one that was low arousal (sleep, bored), might be scored 2 or 1. Each number below corresponds to the response you provided above.

		<u>Pleasantness (1 – 7)</u>	<u>Arousal (1 – 7)</u>
Response	1.	_____	_____
Response	2.	_____	_____
Response	3.	_____	_____
Response	4.	_____	_____
Response	5.	_____	_____

Effects of Sports Drinks

In the blank spaces provided below, please write down the words or short phrases you would use to complete the phrase “Sports drinks make me _____.” If you do not drink sports drinks, please indicate what you think would happen if you did drink them. Please write your responses in order, starting with the top blank and working down toward the bottom or last (fifth) blank. Please write whatever first comes to mind. Do not think too long. Respond as quickly as you can, but please write legibly.

1. _____

2. _____

3. _____

4. _____

5. _____

Now that you have provided these responses, on a 1 - 7 scale please rate each response on how pleasant it is and how arousing it is below. For example, a response that you would consider extremely pleasant might be rated as 6 or 7, while one that was extremely unpleasant might be 2 or 1. A high arousal response (alert, active, or wide awake) might be scored 6 or 7, while one that was low arousal (sleep, bored), might be scored 2 or 1. Each number below corresponds to the response you provided above.

		<u>Pleasantness (1 – 7)</u>	<u>Arousal (1 – 7)</u>
Response	1.	_____	_____
Response	2.	_____	_____
Response	3.	_____	_____
Response	4.	_____	_____
Response	5.	_____	_____

Effects of Soda

In the blank spaces provided below, please write down the words or short phrases you would use to complete the phrase “Soda makes me _____.” If you do not drink soda, please indicate what you think would happen if you did. Please write your responses in order, starting with the top blank and working down toward the bottom or last (fifth) blank. Please write whatever first comes to mind. Do not think too long. Respond as quickly as you can, but please write legibly.

1. _____

2. _____

3. _____

4. _____

5. _____

Now that you have provided these responses, on a 1 - 7 scale please rate each response on how pleasant it is and how arousing it is below. For example, a response that you would consider extremely pleasant might be rated as 6 or 7, while one that was extremely unpleasant might be 2 or 1. A high arousal response (alert, active, or wide awake) might be scored 6 or 7, while one that was low arousal (sleep, bored), might be scored 2 or 1. Each number below corresponds to the response you provided above.

		<u>Pleasantness (1 – 7)</u>	<u>Arousal (1 – 7)</u>
Response	1.	_____	_____
Response	2.	_____	_____
Response	3.	_____	_____
Response	4.	_____	_____
Response	5.	_____	_____

Appendix I: Alcohol Expectancy Questionnaire (AEQ)

This is a questionnaire about the effects of alcohol. Read each statement carefully and respond according to your own personal feelings, thoughts, and beliefs about alcohol **now**. We are interested in what **you** think about alcohol, regardless of what other people might think.

If you think that the statement is true, or mostly true, or true some of the time, then mark the number 1, for "AGREE", on your scantron sheet. If you think the statement is false, or mostly false, then mark the number 0, for "DISAGREE" on your scantron sheet. When the statements refer to drinking alcohol, you may think in terms of drinking any alcoholic beverage, such as beer, wine, whiskey, liquor, rum, scotch, vodka, gin, or various alcoholic mixed drinks. Whether or not you have had actual drinking experiences yourself, **you are to answer in terms of your beliefs about alcohol**. It is important that you respond to **every question**.

PLEASE BE HONEST. REMEMBER, YOUR ANSWERS ARE CONFIDENTIAL.

**RESPOND TO THESE ITEMS ACCORDING TO WHAT YOU PERSONALLY
BELIEVE TO BE TRUE ABOUT ALCOHOL**

**PUT ALL RESPONSES ON YOUR SCANTRON
SHEET:**

0=DISAGREE 1=AGREE

- 1) Some alcohol has a pleasant, cleansing, tingly taste.
- 2) Drinking adds a certain warmth to social occasions.
- 3) When I'm drinking, it is easier to open up and express my feelings.
- 4) Time passes quickly when I'm drinking.
- 5) Drinking makes me feel flushed.
- 6) I feel powerful when I drink, as if I can really influence others to do what I want.
- 7) Drinking gives me more confidence in myself.
- 8) Drinking makes me feel good.
- 9) I feel more creative after I've been drinking.
- 10) Having a few drinks is a nice way to celebrate special occasions.
- 11) When I'm drinking I feel freer to be myself and do whatever I want.
- 12) Drinking makes it easier to concentrate on the good feelings I have at the time.
- 13) Alcohol allows me to be more assertive.
- 14) When I feel "high" from drinking, everything seems to feel better.

- 15) I find that conversing with members of the opposite sex is easier for me after I've had a few drinks.
- 16) Drinking is pleasurable because it's enjoyable to join in with people who are enjoying themselves.
- 17) I like the taste of some alcoholic beverages.
- 18) If I'm feeling restricted in any way, a few drinks make me feel better.
- 19) Men are friendlier when they drink.
- 20) After a few drinks, it is easier to pick a fight.
- 21) If I have a couple of drinks, it is easier to express my feelings.
- 22) Alcohol makes me need less attention from others than I usually do.
- 23) After a few drinks, I feel more self-reliant than usual.
- 24) After a few drinks, I don't worry as much about what other people think of me.
- 25) When drinking, I do not consider myself totally accountable or responsible for my behavior.
- 26) Alcohol enables me to have a better time at parties.
- 27) Drinking makes the future seem brighter.
- 28) I often feel sexier after I've had a couple of drinks.
- 29) I drink when I'm feeling mad.
- 30) Drinking alone or with one other person makes me feel calm and serene.
- 31) After a few drinks, I feel brave and more capable of fighting.
- 32) Drinking can make me more satisfied with myself.
- 33) My feelings of isolation and alienation decrease when I drink.
- 34) Alcohol helps me sleep better.
- 35) I'm a better lover after a few drinks.
- 36) Alcohol decreases muscular tension.
- 37) Alcohol makes me worry less.
- 38) A few drinks makes it easier to talk to people.
- 39) After a few drinks I am usually in a better mood.
- 40) Alcohol seems like magic.
- 41) Women can have orgasms more easily if they've been drinking.
- 42) Drinking helps get me out of a depressed mood.

- 43) After I've had a couple of drinks, I feel I'm more of a caring, sharing person.
- 44) Alcohol decreases my feelings of guilt about not working.
- 45) I feel more coordinated after I drink.
- 46) Alcohol makes me more interesting.
- 47) A few drinks makes me feel less shy.
- 48) Alcohol enables me to fall asleep more easily.
- 49) If I'm feeling afraid, alcohol decreases my fears.
- 50) Alcohol can act as an anesthetic, that is, it can deaden pain.
- 51) I enjoy having sex more if I've had some alcohol.
- 52) I am more romantic when I drink.
- 53) I feel more masculine/feminine after a few drinks.
- 54) Alcohol makes me feel better physically.
- 55) Sometimes when I drink alone or with one other person it is easy to feel cozy and romantic.
- 56) I feel like more of a happy-go-lucky person when I drink.
- 57) Drinking makes get togethers more fun.
- 58) Alcohol makes it easier to forget bad feelings.
- 59) After a few drinks, I am more sexually responsive.
- 60) If I'm cold, having a few drinks will give me a sense of warmth.
- 61) It is easier to act on my feelings after I've had a few drinks.
- 62) I can discuss or argue a point more forcefully after I've had a drink or two.
- 63) A drink or two makes the humorous side of me come out.
- 64) Alcohol makes me more outspoken or opinionated.
- 65) Drinking increases female aggressiveness.
- 66) A couple of drinks makes me more aroused or physiologically excited.
- 67) At times, drinking is like permission to forget problems.
- 68) If I am tense or anxious, having a few drinks makes me feel better.

Appendix J: UPPS-P

Below are a number of statements that describe ways in which people act and think. For each statement, please indicate how much you agree or disagree with the statement. If you **Agree Strongly** circle **1**, if you **Agree Somewhat** circle **2**, if you **Disagree somewhat** circle **3**, and if you **Disagree Strongly** circle **4**. Be sure to indicate your agreement or disagreement for every statement below. Also, there are questions on the following pages.

1.	I have a reserved and cautious attitude toward life.	1	2	3	4
2.	I have trouble controlling my impulses.	1	2	3	4
3.	I generally seek new and exciting experiences and sensations.	1	2	3	4
4.	I generally like to see things through to the end.	1	2	3	4
5.	When I am very happy, I can't seem to stop myself from doing things that can have bad consequences.	1	2	3	4
6.	My thinking is usually careful and purposeful.	1	2	3	4
7.	I have trouble resisting my cravings (for food, cigarettes, etc.).	1	2	3	4
8.	I'll try anything once.	1	2	3	4
9.	I tend to give up easily.	1	2	3	4
10.	When I am in great mood, I tend to get into situations that could cause me problems.	1	2	3	4
11.	I am not one of those people who blurt out things without thinking.	1	2	3	4
12.	I often get involved in things I later wish I could get out of.	1	2	3	4
13.	I like sports and games in which you have to choose your next move very quickly.	1	2	3	4
14.	Unfinished tasks really bother me.	1	2	3	4
15.	When I am very happy, I tend to do things that may cause problems in my life.	1	2	3	4
16.	I like to stop and think things over before I do them.	1	2	3	4
17.	When I feel bad, I will often do things I later regret in order to make myself feel better now.	1	2	3	4
18.	I would enjoy water skiing.	1	2	3	4
19.	Once I get going on something I hate to stop.	1	2	3	4
20.	I tend to lose control when I am in a great mood.	1	2	3	4
21.	I don't like to start a project until I know exactly how to proceed.	1	2	3	4

Please go to the next page

22.	Sometimes when I feel bad, I can't seem to stop what I am doing even though it is making me feel worse.	1	2	3	4
23.	I quite enjoy taking risks.	1	2	3	4
24.	I concentrate easily.	1	2	3	4
25.	When I am really ecstatic, I tend to get out of control.	1	2	3	4
26.	I would enjoy parachute jumping.	1	2	3	4
27.	I finish what I start.	1	2	3	4
28.	I tend to value and follow a rational, "sensible" approach to things.	1	2	3	4
29.	When I am upset I often act without thinking.	1	2	3	4
30.	Others would say I make bad choices when I am extremely happy about something.	1	2	3	4
31.	I welcome new and exciting experiences and sensations, even if they are a little frightening and unconventional.	1	2	3	4
32.	I am able to pace myself so as to get things done on time.	1	2	3	4
33.	I usually make up my mind through careful reasoning.	1	2	3	4
34.	When I feel rejected, I will often say things that I later regret.	1	2	3	4
35.	Others are shocked or worried about the things I do when I am feeling very excited.	1	2	3	4
36.	I would like to learn to fly an airplane.	1	2	3	4
37.	I am a person who always gets the job done.	1	2	3	4
38.	I am a cautious person.	1	2	3	4
39.	It is hard for me to resist acting on my feelings.	1	2	3	4
40.	When I get really happy about something, I tend to do things that can have bad consequences.	1	2	3	4
41.	I sometimes like doing things that are a bit frightening.	1	2	3	4
42.	I almost always finish projects that I start.	1	2	3	4
43.	Before I get into a new situation I like to find out what to expect from it.	1	2	3	4
44.	I often make matters worse because I act without thinking when I am upset.				
45.	When overjoyed, I feel like I can't stop myself from going overboard.				

Please go to the next page

46. I would enjoy the sensation of skiing very fast down a high mountain slope.	1	2	3	4
47. Sometimes there are so many little things to be done that I just ignore them all.	1	2	3	4
48. I usually think carefully before doing anything.	1	2	3	4
49. Before making up my mind, I consider all the advantages and disadvantages.	1	2	3	4
50. When I am really excited, I tend not to think of the consequences of my actions.	1	2	3	4
51. In the heat of an argument, I will often say things that I later regret.	1	2	3	4
52. I would like to go scuba diving.	1	2	3	4
53. I tend to act without thinking when I am really excited.	1	2	3	4
54. I always keep my feelings under control.	1	2	3	4
55. When I am really happy, I often find myself in situations that I normally wouldn't be comfortable with.	1	2	3	4
56. I would enjoy fast driving.	1	2	3	4
57. When I am very happy, I feel like it is ok to give in to cravings or overindulge.	1	2	3	4
58. Sometimes I do impulsive things that I later regret.	1	2	3	4
59. I am surprised at the things I do while in a great mood.	1	2	3	4

Appendix K: The Temptation and Restraint Inventory

For each item, use this scale to select your response and write the number on the line next to it:

1	2	3	4	5	6	7	8	9
Not at all				Very Much				

1. How much effort does it take for you to keep your drinking under control? -----
2. How much difficulty do you have controlling your drinking? -----
3. Do you find that once you start drinking it is difficult for you to stop? -----
4. Do you ever cut back on your drinking in an attempt to change your drinking habits? -----
5. How often do you attempt to cut down the amount you drink? -----
6. Do feelings of guilt about drinking too much help you to control your alcohol intake? -----
7. When you feel anxious, are you more likely to drink? -----
8. When you feel lonely, are you more likely to drink? -----
9. Do you ever feel so nervous that you really need a drink? -----
10. At times, do you find yourself unable to stop thinking about drinking? -----
11. Is it hard to distract yourself from thinking about drinking? -----
12. Do thoughts about drinking intrude into your daily activities? -----
13. Does the sight and smell of alcohol make you think about limiting your drinking? -----
14. Does seeing alcohol-related commercials, magazine ads., and/or signs for liquor stores stimulate concerns about the need to limit your drinking? -----
15. Does seeing other people drink remind you of your efforts to control your alcohol consumption? -----

Appendix L : Recruitment Flyer

WHICH MAN ARE YOU?
CALLING ALL MEN AGES 21-28 LIVING IN THE TAMPA BAY AREA



WIN A \$25 GIFT CARD



THE MEN'S PERSPECTIVE INITIATIVE
A USF RESEARCH PROJECT THAT EXPLORES WHAT YOUNG MEN THINK IS IMPORTANT IN THEIR LIVES

[HTTP://ALTURL.COM/Q4X67](http://alturl.com/q4x67)



PRINCIPAL INVESTIGATOR: JOHN RAY CONTACT AT 813-974-6963 USF IRB # 10962

Appendix M: Informed Consent Documents

Phase 1: Online Screening Survey (via SurveyMonkey)

Consent Survey

The purpose of this research project is to find out how young men think and feel about themselves and important aspects of young men's lives. This is a research project being conducted by John Ray, MA, at the University of South Florida. You are invited to participate in this research project because you are a young man and we would like to know what you think!

Your participation in this research study is voluntary. You may choose not to participate. If you decide to participate in this research survey, you may withdraw at any time. If you decide not to participate in this study or if you withdraw from participating at any time, you will not be penalized.

The procedure involves completing an online survey that will take approximately 30 minutes. Your responses will be confidential and identifying information such as your name, email address or IP address will be protected by encryption and kept separate from all other data. The survey questions will be about products you use and things you do in your free time.

We will do our best to keep your information confidential. All data is stored in a password protected electronic format. To help protect your confidentiality, the surveys will not contain information that will personally identify you. The results of this study will be used for scholarly purposes only and may be shared with University of South Florida representatives.

You will receive a chance to win a \$25.00 gift card for taking part in this study. Your name will be entered in a drawing that will take place upon completion of the study (no later than July 1st, 2013). The winner will be notified using the email address and/or phone number provided to the study's investigators.

If you have any questions about the research study, please contact John Ray, MA, at 813-974-6963. This research has been reviewed according to University of South Florida IRB procedures for research involving human subjects.

ELECTRONIC CONSENT: Please select your choice below.

Clicking on the "agree" button below indicates that:

- you have read the above information
- you voluntarily agree to participate
- you are at least 18 years of age

If you do not wish to participate in the research study, please decline participation by clicking on the "disagree" button.

Phase 2: In-lab Experimental Protocol



Informed Consent to Participate in Research Information to Consider Before Taking Part in this Research Study

IRB Study # _____

You are being asked to take part in a research study. Research studies include only people who choose to take part. This document is called an informed consent form. Please read this information carefully and take your time making your decision. Ask the researcher or study staff to discuss this consent form with you, please ask him/her to explain any words or information you do not clearly understand. We encourage you to talk with your family and friends before you decide to take part in this research study. The nature of the study, risks, inconveniences, discomforts, and other important information about the study are listed below.

Please tell the study staff if you are taking part in another research study.

We are asking you to take part in a research study called: **The effects of thought and emotion on concentration.**

The person who is in charge of this research study is John Ray, M.A. This person is called the Principal Investigator. However, other research staff may be involved and can act on behalf of the person in charge. He is being guided in this research by Mark Goldman, Ph.D.

The research will be conducted at PCD 2101, Department of Psychology, University of South Florida.

Purpose of the study

The purpose of this study is to examine some of the ways that thinking and feeling can influence how we remember some things. You are being asked to participate because, as a college student, you are regularly engaged in activities that involve memory. This study is being conducted by a graduate student as part of the requirements for a dissertation.

Study Procedures

If you take part in this study, you will be asked to:

- 1) Complete some questionnaires
- 2) Complete one of the following:
 - a. Watch a brief video
 - b. Engage in a thought exercise
 - c. Do some math problems
- 3) View words on a computer screen and describe their characteristics
- 4) Complete a memory task

You will complete your assigned set of tasks only once and the time to complete all activities should be no more than 60 minutes. This is a onetime study to be completed today; you will not be asked to return at a later date. All of the tasks will take place in this laboratory, PCD 2101, USF.

Total Number of Participants

About 120 individuals will take part in this study at USF.

Alternatives

You do not have to participate in this research study.

Benefits

We are unsure if you will receive any benefits by taking part in this research study.

Risks or Discomfort

This research is considered to be minimal risk. That means that the risks associated with this study are the same as what you face every day. There are no known additional risks to those who take part in this study.

Compensation

You will receive a chance to win a \$25.00 gift card for taking part in this study. Your name will be entered in a drawing that will take place upon completion of the study (no later than July 1st, 2013). The winner will be notified using the email address and/or phone number provided to the study's investigators.

Cost

There will be no costs to you as a result of being in this study.

Privacy and Confidentiality

We will keep your study records private and confidential. Certain people may need to see your study records. By law, anyone who looks at your records must keep them completely confidential. The only people who will be allowed to see these records are:

- The research team, including the Principal Investigator, study coordinator, and all other research staff.
- Certain government and university people who need to know more about the study. For example, individuals who provide oversight on this study may need to look at your records. This is done to make sure that we are doing the study in the right way. They also need to make sure that we are protecting your rights and your safety.
- Any agency of the federal, state, or local government that regulates this research. This includes the Food and Drug Administration (FDA), Florida Department of Health, and the Department of Health and Human Services (DHHS) and the Office for Human Research Protection (OHRP).
- The USF Institutional Review Board (IRB) and its related staff who have oversight responsibilities for this study, staff in the USF Office of Research and Innovation, USF Division of Research Integrity and Compliance, and other USF offices who oversee this research.

We may publish what we learn from this study. If we do, we will not include your name. We will not publish anything that would let people know who you are.

Voluntary Participation / Withdrawal

You should only take part in this study if you want to volunteer. You should not feel that there is any pressure to take part in the study. You are free to participate in this research or withdraw at any time. There will be no penalty or loss of benefits you are entitled to receive if you stop taking part in this study. Your decision to participate or not to participate will not affect your student status (e.g., course grade).

New information about the study

During the course of this study, we may find more information that could be important to you. This includes information that, once learned, might cause you to change your mind about being in the study. We will notify you as soon as possible if such information becomes available.

You can get the answers to your questions, concerns, or complaints

If you have any questions, concerns or complaints about this study, or experience an adverse event or unanticipated problem, call John Ray at 813-974-6963.

If you have questions about your rights as a participant in this study, general questions, or have complaints, concerns or issues you want to discuss with someone outside the research, call the USF IRB at (813) 974-5638.

Consent to Take Part in this Research Study

It is up to you to decide whether you want to take part in this study. If you want to take part, please sign the form, if the following statements are true.

I freely give my consent to take part in this study. I understand that by signing this form I am agreeing to take part in research. I have received a copy of this form to take with me.

Signature of Person Taking Part in Study

Date

Printed Name of Person Taking Part in Study

Statement of Person Obtaining Informed Consent

I have carefully explained to the person taking part in the study what he or she can expect from their participation. I hereby certify that when this person signs this form, to the best of my knowledge, he/ she understands:

- What the study is about;
- What procedures/interventions/investigational drugs or devices will be used;
- What the potential benefits might be; and
- What the known risks might be.

I can confirm that this research subject speaks the language that was used to explain this research and is receiving an informed consent form in the appropriate language. Additionally, this subject reads well enough to understand this document or, if not, this person is able to hear and understand when the form is read to him or her. This subject does not have a medical/psychological problem that would compromise comprehension and therefore makes it hard to understand what is being explained and can, therefore, give legally effective informed consent. This subject is not under any type of anesthesia or analgesic that may cloud their judgment or make it hard to understand what is being explained and, therefore, can be considered competent to give informed consent.

Signature of Person Obtaining Informed Consent / Research Authorization

Date

Printed Name of Person Obtaining Informed Consent / Research Authorization

Phase 3: In-lab Taste-Test/Outcome Measure Protocol



Informed Consent to Participate in Research Information to Consider Before Taking Part in this Research Study

IRB Study # _____

You are being asked to take part in a research study. Research studies include only people who choose to take part. This document is called an informed consent form. Please read this information carefully and take your time making your decision. Ask the researcher or study staff to discuss this consent form with you, please ask him/her to explain any words or information you do not clearly understand. We encourage you to talk with your family and friends before you decide to take part in this research study. The nature of the study, risks, inconveniences, discomforts, and other important information about the study are listed below.

Please tell the study staff if you are taking part in another research study.

We are asking you to take part in a research study called: **The psychological effects of taste on purchasing decisions for flavored beverages.**

The person who is in charge of this research study is John Ray, M.A. This person is called the Principal Investigator. However, other research staff may be involved and can act on behalf of the person in charge. He is being guided in this research by Mark Goldman, Ph.D.

The research will be conducted at PCD 2101, Department of Psychology, University of South Florida.

Purpose of the study

The purpose of this study is to examine some of the ways that consumption of flavored alcoholic malt beverages can influence the decisions we make. You are being asked to participate because, as a college student, you are regularly engaged in activities that involve decision-making. This study is being conducted by a graduate student as part of the requirements for a dissertation.

Study Procedures

If you take part in this study, you will be asked to:

1. Complete some questionnaires
2. Consume a beverage (may be flavored water, flavored carbonated beverage/soda, or flavored alcoholic malt beverage)
3. Complete a decision making task
4. If part of alcohol taste test: Complete a breath analysis to ensure safe BAC before leaving

You will complete your assigned set of tasks only once and the time to complete all activities should be no more than 30 minutes. This is a onetime study to be completed today; you will not be asked to return at a later date. All of the tasks will take place in this laboratory, PCD 2101, USF.

Total Number of Participants

About 120 individuals will take part in this study at USF.

Alternatives

You do not have to participate in this research study.

Benefits

We are unsure if you will receive any benefits by taking part in this research study.

Risks or Discomfort

This research is considered to be minimal risk. That means that the risks associated with this study are the same as what you face every day. There are no known additional risks to those who take part in this study.

Compensation

You will receive a chance to win a \$25.00 gift card for taking part in this study. Your name will be entered in a drawing that will take place upon completion of the study (no later than July 1st, 2013). The winner will be notified using the email address and/or phone number provided to the study's investigators.

Cost

There will be no costs to you as a result of being in this study.

Privacy and Confidentiality

We will keep your study records private and confidential. Certain people may need to see your study records. By law, anyone who looks at your records must keep them completely

confidential. The only people who will be allowed to see these records are:

- The research team, including the Principal Investigator, study coordinator, and all other research staff.
- Certain government and university people who need to know more about the study. For example, individuals who provide oversight on this study may need to look at your records. This is done to make sure that we are doing the study in the right way. They also need to make sure that we are protecting your rights and your safety.
- Any agency of the federal, state, or local government that regulates this research. This includes the Food and Drug Administration (FDA), Florida Department of Health, and the Department of Health and Human Services (DHHS) and the Office for Human Research Protection (OHRP).
- The USF Institutional Review Board (IRB) and its related staff who have oversight responsibilities for this study, staff in the USF Office of Research and Innovation, USF Division of Research Integrity and Compliance, and other USF offices who oversee this research.

We may publish what we learn from this study. If we do, we will not include your name. We will not publish anything that would let people know who you are.

Voluntary Participation / Withdrawal

You should only take part in this study if you want to volunteer. You should not feel that there is any pressure to take part in the study. You are free to participate in this research or withdraw at any time. There will be no penalty or loss of benefits you are entitled to receive if you stop taking part in this study. Your decision to participate or not to participate will not affect your student status (e.g., course grade).

New information about the study

During the course of this study, we may find more information that could be important to you. This includes information that, once learned, might cause you to change your mind about being in the study. We will notify you as soon as possible if such information becomes available.

You can get the answers to your questions, concerns, or complaints

If you have any questions, concerns or complaints about this study, or experience an adverse event or unanticipated problem, call John Ray at 813-974-6963.

If you have questions about your rights as a participant in this study, general questions, or have complaints, concerns or issues you want to discuss with someone outside the research, call the USF IRB at (813) 974-5638.

Consent to Take Part in this Research Study

It is up to you to decide whether you want to take part in this study. If you want to take part, please sign the form, if the following statements are true.

I freely give my consent to take part in this study. I understand that by signing this form I am agreeing to take part in research. I have received a copy of this form to take with me.

Signature of Person Taking Part in Study

Date

Printed Name of Person Taking Part in Study

Statement of Person Obtaining Informed Consent

I have carefully explained to the person taking part in the study what he or she can expect from their participation. I hereby certify that when this person signs this form, to the best of my knowledge, he/ she understands:

- What the study is about;
- What procedures/interventions/investigational drugs or devices will be used;
- What the potential benefits might be; and
- What the known risks might be.

I can confirm that this research subject speaks the language that was used to explain this research and is receiving an informed consent form in the appropriate language. Additionally, this subject reads well enough to understand this document or, if not, this person is able to hear and understand when the form is read to him or her. This subject does not have a medical/psychological problem that would compromise comprehension and therefore makes it hard to understand what is being explained and can, therefore, give legally effective informed consent. This subject is not under any type of anesthesia or analgesic that may cloud their judgment or make it hard to understand what is being explained and, therefore, can be considered competent to give informed consent.

Signature of Person Obtaining Informed Consent / Research Authorization

Date

Printed Name of Person Obtaining Informed Consent / Research Authorization

Appendix N: Self-Control Task Instructions

Emotion Suppression

For this task, you will watch a five minute video. Please remain completely neutral on the inside and out. Please try your best not to let any feelings or responses you may have show on your face, and to the best of your ability, try to keep all of your internal reactions suppressed.

Thought Listing Task

For this task, you will write down your thoughts on the piece of paper provided as they come to mind. Anything that comes to mind (anything at all), write it down. This can be in sentence form or just in terms of single words that come to mind. Do this task for the next five minutes continuously. Please do not stop until the five minutes are up and the experimenter comes in and tells you to stop.

While writing your thoughts down, you are to avoid thinking of the video you just watched. When you think of the video, try to change your thoughts to something else immediately. However, every time that a thought of the video comes to mind, please put a check mark down on the paper. Remember though, it is important that you not think about the video and you should immediately change your thoughts to something else. But when you do, put a check mark down. Go ahead and begin.

Control (Neutral) Condition

Video Viewing: For this task, you will watch a five minute video. Please make yourself comfortable and watch it the way you normally would..

Thought Listing Task: For this task, you will write down your thoughts on the piece of paper provided as they come to mind. Anything that comes to mind (anything at all), write it down. This can be in sentence form or just in terms of single words that come to mind. Do this task for the next five minutes continuously. Please do not stop until the five minutes are up and the experimenter comes in and tells you to stop.

Appendix O: Taste Test Script

Introduction

[As the participant is waiting, enter and administer bogus BAC to confederate. Tell them their BAC is low enough now so they can go home (don't show them the BAC). Then address the participant]

Hi! I'm ____ Thank you for agreeing to participate in our study on the psychological effects of taste on decisions to purchase flavored beverages.

[Check your notes]

You have been assigned to the alcoholic drink condition. Your task will involve tasting and rating a flavored alcoholic malt beverage, sometimes known as alcopop or ready-to-drink cocktail. Some popular varieties include hard cola, hard lemonade and hard iced tea. Our taste test will use hard lemonade.

Pre-task BAC

Since you've been selected for the alcoholic drink taste test, we'll need to make sure you haven't already had alcohol recently. In a moment, I am going to hold this breathalyzer near your mouth. When you hear the beep, take a deep breath and place your mouth on the tube here [point without touching], making sure you get an airtight seal with your lips. Then exhale strongly until you here another beep. Do not stop exhaling until you here the beep, or you'll have to do it again. It should take about five seconds. Are you ready? Begin.

Taste Task Instructions

[Open container in front of participant and place it on the table; place the glass with ice and unopened bottles to the side] Please take your time and drink as much of each beverage as you like. I am going to leave for a little while, but I'll be back to check on you.

After you are done drinking, please answer the questions on this form. I will measure your BAC again and you will wait in another room until your breath alcohol concentration returns to normal.

[Allow the participant to perform the taste test uninterrupted but stay close]

Post-task BAC

Now we just need to measure your BAC again so we know how long you'll need to wait before we can let you leave the building. Do you need me to repeat the instructions for the breathalyzer?
[If so, repeat pre-task instructions]

[Take them back to the computer/video room where they will be debriefed and released]

Appendix Q: Debriefing Script

The Effects of Self-Control Depletion on Alcohol Expectancies and Drinking

Before we go on to talk about this experiment:

Do you have any questions or comments about anything so far?

Did anything strike you as particularly interesting or unusual?

The study actually is over now, but before I tell you more about it, I need to ask you some questions about your experience.

First, do you have any ideas about what we were specifically interested in studying?

Do you think that anything you did on one task affected what you did on any other task? YES NO

IF YES, how exactly did it affect you?

The purpose of the experiment is not only for us to collect data, but also for you to learn what psychological research is like. It gives you a chance to see how experiments really work and an opportunity to learn how we test hypotheses. I only gave you a brief idea at the beginning of the study of what the experiment's purpose was. Sometimes when we are studying how people think about certain things, we don't give them a full description of what we are interested in. That way we are able to get natural responses. Not every psychology study does this. However, there are a few things about this experiment that I would like to explain.

The first thing I need to tell you is that the two studies you took part in today were actually two parts of one larger study.

Did you ever suspect that the studies were related?

If so, what tipped you off?

The tasks you participated in (video and thought exercise) were designed to make you use self-control. The word list memory task included words that people use to describe the effects of alcohol, which may have affected your thoughts about alcohol in the moment. Then we had you actually consume an alcoholic drink. We believe that if we understand how self-control affects the way people think about alcohol, we can better understand the decisions people make about drinking. You can see that this has many real world applications such as drunk driving, alcohol use disorders, etc.

Did you ever suspect that the drinks were non-alcoholic?

If so, what tipped you off?

Although we are doing things at a very low level here, we'd like to be able to address more serious conditions like alcohol use disorders. Therefore, it really is important that we do get people's natural reactions. For that reason, please do not talk to anyone about the details of the study, especially any of your friends who are in Psychology classes. We will be running this study for at least a couple of terms, and sometimes if people know what the study is about it can bias their responses even when they don't mean for it to. If your friends have already been in the study, then that's fine, and you can talk all you want. But with your friends who haven't been in the study yet, we just ask that you refrain for giving them the details about the study or the relationship between the two experiments. Like I said, it really is important that we know how people actually respond if we want to be able to say anything about these more serious conditions. Any questions?

If you feel concerned or uncomfortable about the fact that you were intentionally deceived, you may tell us to withdraw your data from the sample. Remember that your results are confidential to me and my supervisor, and that all results are published anonymously as group data. If participating in this experiment has caused sufficient distress that you wish to speak to a counselor, or if you think you may have a drinking problem, please contact one of the following:

USF Counseling Center	813-974-2831
USF Student Health Services	813-974-2331
Hillsborough Crisis Line	2-1-1

If you have any complaints, concerns, or questions about this research, please feel free to contact the USF Institutional Review Board at 813-974-5638, or the Chair of the Department of Psychology 813-974-0478.

If you would like to learn more about this experiment and its results, please contact John Ray, M.A., 813-974-6963, jmray3@mail.usf.edu. In addition, you might want to read the following articles available at the USF Library or on-line through PsycARTICLES:

Goldman, M.S. (2002). Expectancy and risk for alcoholism: The unfortunate exploitation of a fundamental characteristic of neurobehavioral adaptation. *Alcoholism: Clinical and Experimental Research*, 26, 737-746.

Muraven, M., Collins, R. L., & Nienhaus, K. (2002). Self-control and alcohol restraint: An initial application of the self-control strength model. *Psychology of Addictive Behaviors*, 16, 113–120.

Thank you for helping us in this research!