

Design of a high efficiency wide input range isolated Ćuk Dc-Dc converter for grid connected regenerative active loads.

F. Galea, M. Apap, C. Spiteri Staines, J. Cilia

Industrial Electrical Power Conversion Department, University of Malta, Malta

Abstract: The objective of this research is to build a regenerative active load unit with a very wide input voltage range in order to support a wide variety of dc supply equipment such as dc power supplies and batteries. These are usually tested by active or passive load units (resistive loads) for long periods of time to detect early failures and reliability issues. The power drawn from the devices under test are dissipated into heat by the resistive loads. The system being proposed in this paper will consist of a grid connected inverter and an efficient wide input voltage range dc-dc converter. This system will allow the energy drawn from the devices under test to be fed back to the grid. The only energy consumed corresponds to the losses within the system.

The aim of the project is concerned with the construction of a 1kW regenerative active load unit. The dc-dc converter, irrespective of the input voltage will feed power at a constant voltage of 200V to the grid connected inverter. An input voltage ranging from 35V up to 400V will be supported by the regenerative active load unit with a handling power of 1kW throughout the whole range.

This paper shall present the results obtained during the testing of the 1kW regenerative active load unit.

Keywords: Isolated-Ćuk, Regenerative Load, Dc-Dc Converter, Grid-connected Inverter, Active Load

Introduction

The objective of this research is to build a regenerative active load unit with a very wide input voltage range in order to support a wide variety of dc supply equipment such as dc power supplies and batteries. These are usually tested by active or passive load units (resistive loads) for long periods of time in order to detect early failures and reliability issues. The power drawn from the devices under test are dissipated into heat by the resistive loads. The purpose of the regenerative active load unit will be to feed back the energy to the grid, thus losing only a small percentage of the energy.

The regenerative active load is made up from a Dc-Dc Converter connected to a Grid-connected Inverter. In order to implement the Dc-Dc Converter, an initial study was done in order to choose the most suitable topology for this converter. The specifications of this converter are outlined in Table 1. Following an investigation and simulations of the Dc-Dc

converter topologies, the isolated Ćuk converter was found to be the most advantageous topology which best fits the required specifications.

Input Voltage (V)	35 – 400
Max Input Current (A)	25
Max Input Power (W)	1000
Output Voltage (V)	200
Max Output Current (A)	<5
Max Output Power (W)	<1000
Switching Frequency (kHz)	75

Table 1: Required Dc-Dc converter specifications

The next section, briefly explains the operation of the isolated Ćuk converter. It specifies the design techniques involved to obtain such a high input voltage range Dc-Dc converter and its control, in order to interface with the grid-connected inverter. The results section includes the waveforms obtained from the full simulation done on the circuit. The paper shall present practical results of open loop and closed loop control of the converter feeding a grid-connected inverter. The efficiency figures and savings obtained from the regenerative active load unit are also presented.

Methods

The isolated Ćuk converter is shown in **Error! Reference source not found.**. This Dc-Dc converter topology has a number of advantages when compared to other similar topologies. It has very low input and output current ripples since inductors L_1 and L_2 , and capacitors C_{IN} and C_2 filter out such ripples. According to the Ćuk converter's equation, it needs a high duty cycle in order to step up the voltage and a lower duty cycle in order to step down the voltage. The converter's operation avoids high peak input currents, making it less difficult to find the appropriate high current capable switches.

In this converter, current flows in both directions through the transformer. This means that the transformer will be fully utilised and more power can be transmitted through it. Another advantage when using a transformer in such converters is that the input circuit is totally isolated from the output circuit and this is essential for high power applications in case of a fault. The transformer's turns ratio can be used in order to centralise the duty cycle around 50% so that it does not go either close to 0% causing high peak currents nor close to 100% which may reach instability. Unlike other converters which make use of a transformer, the isolated Ćuk converter can never obtain saturation in the transformer because no Dc current can pass through the series capacitors C_{1a} and C_{1b} [1]. Further unlike the bridge converter, this converter does not need a high turns ratio for this application. The bridge converter would need a turns ratio larger than 1:5.71 to step up 35V to 200V. This will result to a peak secondary voltage in excess of 2.3kV when the input voltage is 400V. The isolated Ćuk converter is able to obtain these voltages at a much lower turns ratio.

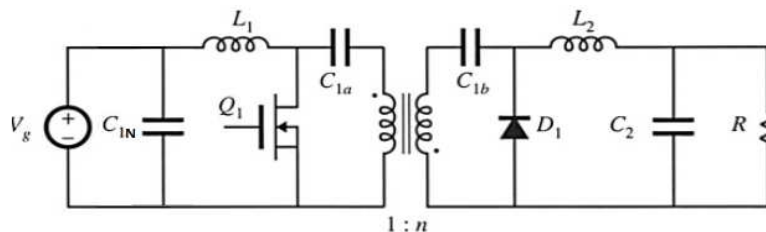

Figure 1: Isolated Ćuk converter

The isolated Ćuk converter operates via capacitive energy transfer [1]. Capacitor C_{1a} stores the source energy and when switch Q_1 switches on, this energy is transferred through the transformer forming a negative current (current out of the dot) on the transformer's primary winding, which in turn forms a positive current (current into the dot) on the secondary winding, passing through capacitor C_{1b} and finally released in inductor L_2 , capacitor C_2 and to the load R . Concurrently, while the switch is switched on and capacitor C_{1a} is supplying its energy to the load, the inductor L_1 is being charged from the source V_g . When switch Q_1 is switched off, both the source and the energy stored in L_1 passes their energy through C_{1a} , into a positive current (current into the dot) on the primary winding of the transformer. A negative current (current out of the dot) is formed on the secondary winding forward biasing diode D_1 and finally released in inductor L_2 , capacitor C_2 and to the load R .

Dc-Dc converters can operate in two different modes of operation which are the Continuous Conduction Mode (CCM) and Discontinuous Conduction Mode (DCM). This converter's output voltage equation given that it is operating in CCM is:

$$V_o = V_{IN} \times N \times \frac{\delta}{1 - \delta}$$

The duty cycle needs to be lower when operating in Discontinuous Conduction Mode (DCM). A Dc-Dc converter enters the DCM operation when the load decreases beyond a certain threshold or is unloaded. This is not a problem if the converter's control is designed to operate in CCM because it will remain stable if it shifts to DCM but one designed to operate in DCM tends to become unstable once it shifts to CCM. A CCM converter can never remain operating always in CCM unless it is always loaded. Once a converter's output is open circuit, it always shifts to DCM. When designing a converter to operate in CCM, the design is straight forward because the input to output voltage gain depends only on the Duty Cycle [2]

In the case of the isolated Ćuk topology used, the turns ratio N was calculated to be 1:1.58. This was in order for the duty cycle to be kept far from the extremes being 0% and 100% which normally leads to instability and experiences high peak currents. This results into a duty cycle of 76% when $V_{IN} = 40V$, and 24% when $V_{IN} = 400V$. It can be noticed that the duty cycle range obtained with the calculated turns ratio is centred on 50%.

Design Methods

The design of the Dc-Dc converter involved the selection of the switching frequency, the magnetic component design (two inductors and transformer), turn-off and over voltage snubbers (which are partly regenerative), the gate drive circuits, suitably rated Mosfet switches, power diode, their respective thermal heat sinks and the capacitors. During design stage, the three main important criteria were maximum efficiency, size and minimal voltage and current ripples.

When designing the magnetic components a compromise was reached between their inductance which affects directly the current ripples, their resistance which increases its operating temperature and affects the converter's efficiency and their physical size. During the design of the inductor, the current handling capability was found to be a limiting factor on the inductance due to the fact that a high current requires thick windings and thus limits the number of turns available in the core. Since the inductance varies with the square of the number of turns, its value is limited. This results in higher ripples especially at higher input voltages.

The capacitor sizes were determined taking into account the voltage ripple, the equivalent series resistance (ESR) and the physical size. Low ESR capacitors like

polypropylene ones have a limited capacitance while capacitors having high capacitance like electrolytic capacitors, have high ESR. In order to obtain both low ESR and high capacitance, electrolytic capacitors were paralleled with low ESR polypropylene capacitors.

Since the converter is designed to operate at 75 kHz, Mosfet transistors have to be used. Mosfets are normally rated for high voltage but low current or for high current but low voltage applications. In this application, the switch will have a voltage stress higher than 500V and a current rating of 25A, thus three 650V IPW60R045CP n channel Mosfets were paralleled together to obtain both high voltage and high current capability. When designing the gate drive, care was taken not to introduce any delays between simultaneously Mosfet switching, and as a precaution, a separate gate resistor for each Mosfet was implemented. The switching of the power electronic circuit can result in voltage stresses higher than the power semiconductors ratings, which may result in their destruction. In this respect, an over voltage snubber and a turn off snubber were both employed in order to reduce these stresses to safe levels [3-5]. Both snubbers are partly regenerative which allow energy to be discharged to V_{IN} rather than discharging it to ground, thus achieving better performance with a considerable decrease in the losses incurred.

Diode D_1 was chosen to be a Silicon Carbide (SiC) diode. These types of diodes have a zero reverse recovery current and zero forward recovery current resulting in no dynamic/switching losses and lower voltage drop and lower leakage current resulting in lower static/conductive losses. Also, the temperature coefficient of such devices is positive and thus paralleling of these diodes is supported. The maximum reverse voltage on the diode was theoretically calculated to be around 800V and so a single 1200V C2D05120 SiC diode was used.

The required thermal conductivity required from the thermal heat sinks was calculated for both the Mosfets and diode. Also a cooling blower was used to cool snubber resistors to decent temperatures [5].

Control Methods

The converter's control is made up from two separate blocks, the voltage control block and the current control block each of which have a PI controller to control the set value of voltage and current. In the case of the voltage control block, a constant voltage reference is used to control the output voltage to be fixed at 210V. In the case of the input current controller (constant current), the current reference is set via a pot so that the input current is maintained at a settable value of 0A to 25A. If the set current value is exceeded, the output voltage declines in order to maintain an input current equal to the set value. The voltage and current control systems drive a PWM Controller in order to switch the Mosfets at 75 kHz. The PWM controller used which is UC3823A is also responsible of soft starting the circuit. The input current is fed back by means of a current transducer and the output voltage is fed back by means of a voltage transducer. The PWM signal from the Control circuit is then fed to the Gate Drive through an opto-coupler.

In order to obtain a regenerative active load unit, an SMA Sunny Boy SB1100 grid-connected inverter was connected to the output of the isolated Ćuk converter. The grid-connected inverter was set to operate with a Constant Voltage Mode of 200V. Thus the inverter synchronises to the grid once a voltage of 200V or higher is applied on its DC link. Once it synchronises to the grid, it will start to increase the power fed to the grid until the DC link voltage declines to 200V. This happens when the input current to the Dc-Dc converter reaches the set value. A block diagram of the Device under test and the regenerative active load unit together with its control is shown in Figure 2.

Apart from the control circuit, a protection circuit was implemented. This circuit is able to shut down the converter within 1µs in order to protect it from certain abnormal conditions that may result in damaging the circuit. All the protection circumstances present in the protection circuit are listed in Table 2.

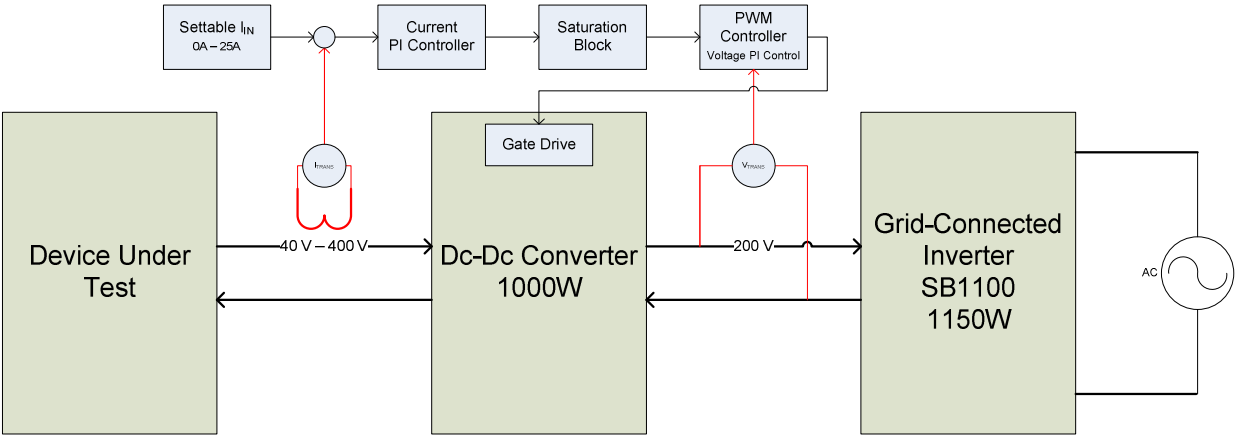

Figure 2: Block diagram of the Device under test loaded with the Regenerative Active Load unit

Error	Condition	Action
Low/No Input Voltage Present	$V_{IN} < 40V$	Shut Down
High Input Voltage	$V_{IN} > 400V$	Shut Down
High Output Voltage	$V_O > 250V$	Shut Down and Latch
High Snubber Voltage	$V_{OVS} > 580V$	Shut Down and Latch
High Input Current	$I_{IN} > 30A$	Shut Down and Latch

Table 2: Protection Circuit checks

Results

Simulation Results

The circuit in Figure 3 was used to make a full simulation of the circuit. In order to obtain accurate results, the circuit included a considerable number of parameters such as the magnetic components' resistances, the magnetising and leakage inductances of the transformer, both over voltage and turn-off snubber circuits, the diode's forward voltage and the on-resistances of both the diode and Mosfet. The simulation in Figure 4 (left) shows the waveforms with an input voltage of 50V and a duty cycle of 72%. This gives out an output power of 854W which means that a conversion efficiency of 85% was expected in the experimental results. This simulation also gives some indications of voltage overshoots that will be experienced in the actual circuit. In **Error! Reference source not found.** (right), the circuit is operating in Continuous Conduction Mode with a duty cycle of 24%. This matches the result of the converter's equation. With an input power of 1kW, an output power of 912W was obtained resulting in a conversion efficiency of 91%.

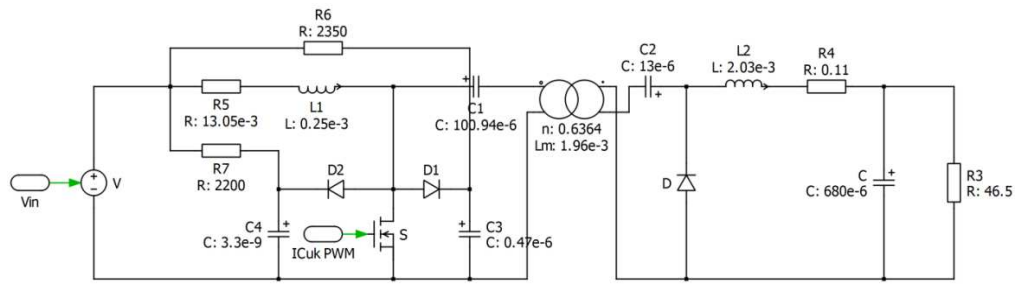

Figure 3: Simulation circuit of the isolated Ćuk converter carried out by PLECS software

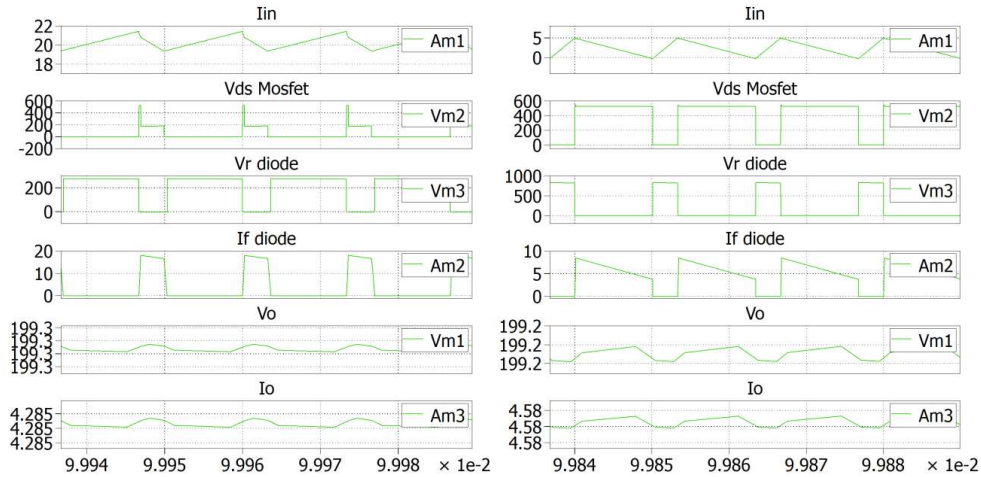

Figure 4: Simulation results $V_{IN} = 50V$; $I_{IN} = 20A$ (left); Simulation results $V_{IN} = 400V$; $I_{IN} = 2.5A$ (right)

Practical Results

The isolated Ćuk converter was built on printed circuit boards as shown in

Figure 5 and Figure 6. The input and output circuits are totally isolated from each other by the transformer. The protection, control and gate drive circuits are also isolated from each other by means of current and voltage transducers and opto-couplers.

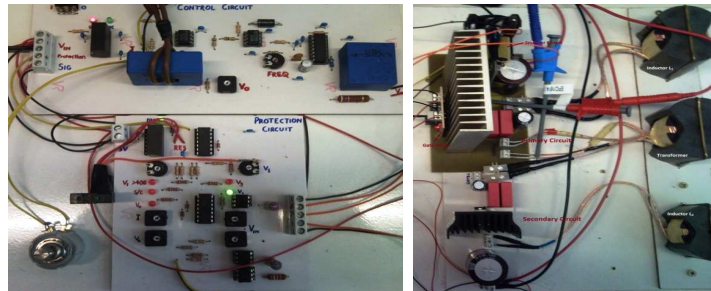

Figure 5: Control and Protection Circuits (left); Gate Drive, Snubber, Primary and Secondary Circuits connected to the Magnetic components (right)

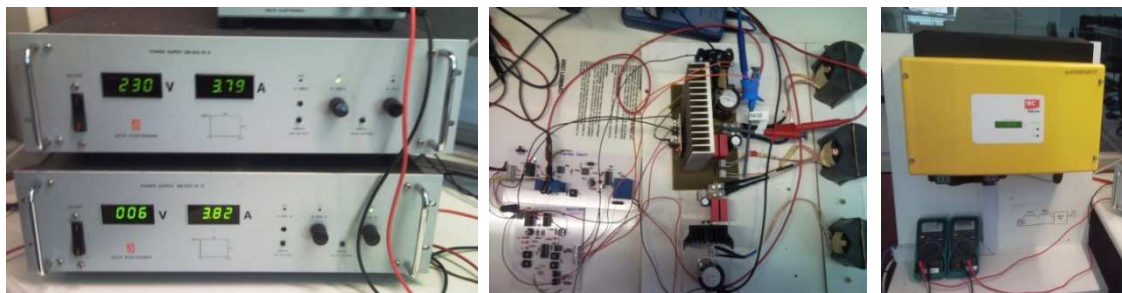

Figure 6: Devices under test (left); Isolated Ćuk Dc-Dc converter (centre); Grid-connected Inverter (right)

The Dc-Dc converter was first tested in open loop meaning that it was given a fixed duty cycle from a signal generator and loaded with a passive load resistor. Parameters like input voltage and output voltage were measured by a voltmeter while the input current and output current by an ammeter. Transients like snubber voltage, diode's reverse voltage and Mosfet's drain to source voltages, were monitored on a Le Croy Wave runner oscilloscope by differential voltage probe. Table 3 shows a series of testing results recorded from the Dc-Dc converter tested at different input voltages. The efficiency of the converter ranged from 80% up to 96%. The efficiency tends to decline at higher input currents (low input voltages). The left picture shown in Figure 7 displays the Mosfets' Drain to Source voltage and the Turn-off snubber voltage obtained in Test 1. The right picture shown in Figure 7 displays the Mosfets' Drain to Source voltage and the voltage on the over voltage snubber obtained in Test 8. The test parameters are shown in Table 3. Figure 8 displays the Mosfets' Drain to Source voltage, the turn off snubber voltage, the voltage on the over voltage snubber and the input current. The left waveforms were obtained in Test 10 while the waveforms on the right figure were obtained in Test 3.

Test	V _{IN}	I _{IN}	V _O	I _O	Duty cycle	P _{IN}	P _O	Eff _{CONV}
1	32 V	10.28 A	168 V	1.66 A	76%	329 W	280 W	85%
2	42 V	18.5 A	160 V	3.9 A	72%	777 W	624 W	80%
3	84 V	10.28 A	179 V	4.38 A	56%	864 W	784 W	91%
4	114 V	6.3 A	201 V	3.33 A	50%	718 W	669 W	93%
5	118 V	9.12 A	200 V	4.93 A	50%	1076 W	987 W	92%
6	172 V	4.81 A	178 V	4.38 A	37%	827 W	781 W	94%
7	179 V	5.87 A	200 V	4.94 A	39%	1051 W	989 W	94%
8	243 V	2.86 A	164 V	4.03 A	27%	695 W	662 W	95%
9	309 V	1.37 A	200 V	2. A	25%	423 W	400 W	94%
10	309 V	3.32 A	199 V	4.88 A	27%	1026 W	971 W	95%
11	350 V	2.77 A	195 V	4.77 A	23%	970 W	930 W	96%
12	375 V	2.18 A	178 V	4.4 A	20%	818 W	783 W	96%

Table 3: Testing of the Dc-Dc Isolated Ćuk converter in open loop



Figure 7: V_{DS} (Yellow) V_{TOS} (Red) (left); V_{DS} (Yellow) V_{OVS} (Red) (right)

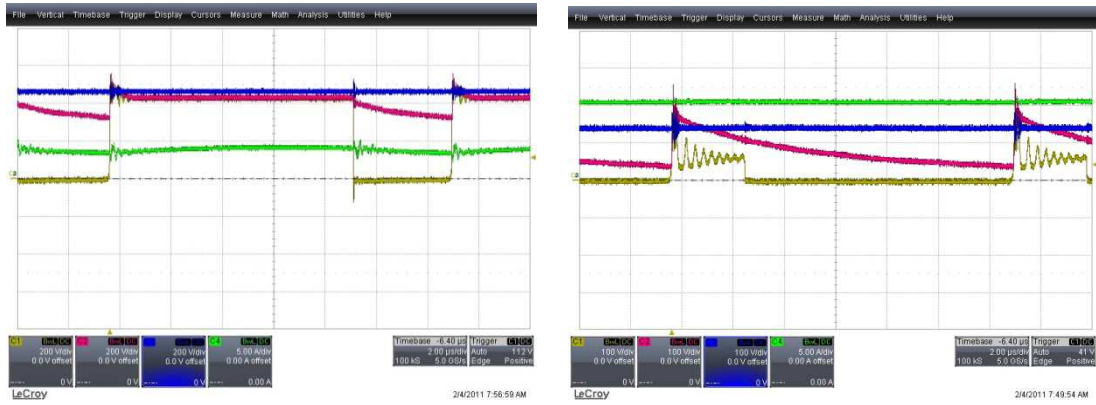

Figure 8: V_{DS} (Yellow) V_{TOS} (Red) V_{OVS} (Blue) I_{IN} (Green)

The dc-dc converter was then connected to the grid connected inverter to be tested in closed loop. The input voltage was kept at 200V and the power was increased gradually by increasing the input current setting. The data taken is listed in Table 4. I_{IN} is the input current of the Dc-Dc converter while I_O is the output current that is being fed to the grid-connected inverter. The dc-dc converter's efficiency ranged from 82% to 91%. The overall efficiency of the regenerative active load unit is found by multiplying both efficiencies together. The overall efficiency of the regenerative active load unit ranged from 62% at a loading power of 100W to 83% at a full loading power of 1kW. Figure 9 shows the waveforms of the Dc-Dc converter operating in Test 18. The yellow trace is the Drain to Source voltage on the Mosfets, the red trace is the output voltage of the Dc-Dc converter connected to the Dc link of the grid-connected inverter and the green trace is the input current fed from the device under test to the Dc-Dc converter.

Test	V_{IN}	I_{IN}	I_O	P_{IN}	P_O	P_{AC}	Eff_{CONV}	Eff_{INV}	Eff_{TOT}
13	200	0.5	0.41	100	82	62	82%	76%	62%
14	200	1	0.91	200	182	157	91%	86%	79%
15	200	2	1.81	400	362	324	91%	90%	81%
16	200	3	2.73	600	546	491	91%	90%	82%
17	200	4	3.65	800	730	661	91%	91%	83%
18	200	5	4.55	1000	910	825	91%	91%	83%

Table 4: Regenerative Active Load tested at different power levels



Figure 9: Dc-Dc converter operating at full load with an input voltage of 200V V_{DS} (Yellow) V_O (Red) I_{IN} (Green)

The Regenerative Active Load unit was then tested at full load throughout the whole range of input voltages which range from 400V down to 35V. Due to hardware limitations, the input current was limited to 20A. The Dc-Dc converter's efficiency ranged from 86% up to 94%. The inverter's efficiency was found to be constant at around 90% because of the small variations on its input voltage and input current. The overall efficiency of the regenerative active load unit ranged from 77% up to 85%.

Test	V_{IN}	I_{IN}	I_O	P_{AC}	P_{IN}	P_O	Eff_{CONV}	Eff_{INV}	Eff_{TOT}
19	400	2.5	4.6	830	1000	920	92%	90%	83%
20	350	2.8	4.6	830	980	920	94%	90%	85%
21	300	3.3	4.6	830	990	920	93%	90%	84%
22	250	4	4.6	830	1000	920	92%	90%	83%
23	200	5	4.55	825	1000	910	91%	91%	83%
24	150	6.6	4.34	788	990	868	88%	91%	80%
25	100	10	4.6	840	1000	920	92%	91%	84%
26	50	19.5	4.3	760	975	860	88%	88%	78%
27	35	19.5	3.35	528	683	587	86%	90%	77%



Figure 10: Dc-Dc converter operating at full load at an input voltage of 400V
 V_{DS} (Yellow) V_O (Red) I_{IN} (Green)

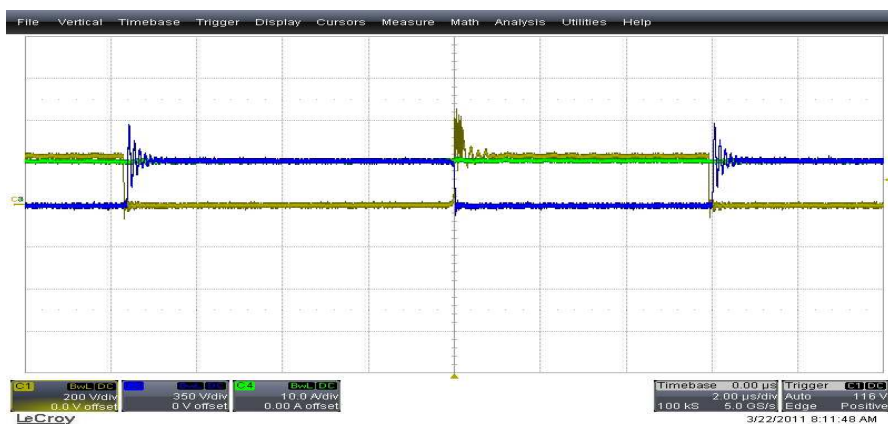

Figure 11: Dc-Dc converter operating at full load at an input voltage of 100V
 V_{DS} (Yellow) V_{DIODE} (Blue) I_{IN} (Green)

Conclusion

The results obtained from the converter corresponded with the results obtained in the Simulation section. In fact when an input voltage of 50V was applied, the efficiency expected from the simulation was 85% while from the converter it was 3% higher being 88%. On the other hand, when an input voltage of 400V was applied, the efficiency in the simulation was 91% while in practice it was found to be 92%.

The overall efficiency of the Regenerative active load unit ranged from 77% up to 85%. If instead of using active and passive loads, industrial organisations opt to use such regenerative active load units, a considerable amount of electrical energy will be saved. Apart from the fact that they will also save even more if the load units are located in air-conditioned areas since the air-conditions will have less load to cool all the wasted energy.

For example, a local company producing Dc power supplies apply a 24 hour full load burn-in test to each power supply. If a 1kW power supply is loaded with an active or passive load, then 24kWh of electricity consumption will be wasted. On the other hand, if they are loaded with such a regenerative active load unit, 80% of the consumption can be saved thus consuming less than 5kWh.

Another local company producing Battery Management Units (BMUs) tests such devices by charging and discharging batteries. If a battery bank of 72V 100Ah battery is discharged to passive loads, 7200Wh of energy would be wasted. Using a regenerative active load unit, 80% of the energy, equating to 5800Wh would be fed back to the grid.

The Regenerative Load units found on the market have a limited voltage range thus limiting their flexibility and practicality. The regenerative active load unit designed and developed in this research has a wide input voltage range which is able to support more Dc electrical supply equipment making it flexible. The design of such a wide input voltage and current range converter introduces problems especially in finding Mosfets and diodes with both high voltage and high current characteristics. The design of inductors shall cater for both high current and low ripples at both extremes of voltages and currents. Also, snubber circuits have to introduce low losses at all input voltages but must be most effective at high input currents which result in high voltage overshoots possibly damaging the switches.

Further Recommendations

The turn on delay of the diode resulted into high voltage overshoots on the Mosfets. If a faster diode is used or a snubber is placed across it, the circuit will perform better with less voltage overshoots and the input current of the dc-dc converter can be increased further.

If the voltage overshoots on the Mosfets is decreased, the snubbers can be designed for less losses thus obtaining a more efficient Dc-Dc converter.

The input voltage range can be widened by developing another converter and connecting them either in parallel, to obtain higher input current or in series, to obtain higher input voltage. Hence, this Dc-Dc converter will have a power handling of 2kW with input voltage (current) ranging from 35V (50A) to 800V (2.5A).

References

- [1] Robert W. Erickson, Dragan Maksimović, 2004, Fundamentals of Power Electronics Second Edition, Converter Circuits (6), pp. 168-171.
- [2] Hang-Seok Choi, 2003, Design Guidelines for Off-line Flyback Converters Using Fairchild Power Switch (FPS), pp. 3.
- [3] Marty Brown, 1990, Practical Switching Power Supply Design, pp. 123-124.

- [4] Abraham I. Pressman, 1991, Switching Power supply Design, Turn on, Turnoff Switching Losses and Snubbers (11), pp. 413-425.
- [5] Ned Mohan, Tore M. Undeland, William P. Robbins, 2003, Power Electronics, Converters, Applications and Design Third Edition.