

## Durham Research Online

---

### Deposited in DRO:

08 March 2011

### Version of attached file:

Published Version

### Peer-review status of attached file:

Peer-reviewed

### Citation for published item:

Gallant, A.J. and Levitt, J.A. and Kaliteevski, M. and Wood, D. and Petty, M.C. and Abram, R.A. and Brand, S. and Chamberlain, J.M. (2007) 'Artificial plasmonic materials for THz applications.', in Terahertz and gigahertz electronics and photonics VI ; proceedings. Bellingham WA: SPIE, 647206 -647216. Proceedings of the SPIE. (6472).

### Further information on publisher's website:

<http://dx.doi.org/10.1117/12.712716>

### Publisher's copyright statement:

Copyright 2007 Society of Photo-Optical Instrumentation Engineers. One print or electronic copy may be made for personal use only. Systematic electronic or print reproduction and distribution, duplication of any material in this paper for a fee or for commercial purposes, or modification of the content of the paper are prohibited.

### Additional information:

## Use policy

---

The full-text may be used and/or reproduced, and given to third parties in any format or medium, without prior permission or charge, for personal research or study, educational, or not-for-profit purposes provided that:

- a full bibliographic reference is made to the original source
- a [link](#) is made to the metadata record in DRO
- the full-text is not changed in any way

The full-text must not be sold in any format or medium without the formal permission of the copyright holders.

Please consult the [full DRO policy](#) for further details.

# Artificial plasmonic materials for THz applications

A.J. Gallant<sup>\*a</sup>, J.A. Levitt<sup>b</sup>, M. Kaliteevski<sup>b</sup>, D. Wood<sup>a</sup>, M.C. Petty<sup>a</sup>, R.A. Abram<sup>b</sup>, S. Brand<sup>b</sup>,  
G.P. Swift<sup>b</sup>, D.A. Zeze<sup>a</sup> and J.M. Chamberlain<sup>b</sup>

<sup>a</sup>School of Engineering, Durham University, South Road, Durham, DH1 3LE, UK

<sup>b</sup>Physics Department, Durham University, South Road, Durham, DH1 3LE, UK

## ABSTRACT

This paper reports on the development of micromachined pillar arrays for the filtering of terahertz radiation. These pillar arrays are fabricated using ultraviolet based processing of thick SU8. This micromachining technique enables the array patterns, dimensions, and consequently the filter characteristics, to be readily defined. In particular, we demonstrate that by combining individual filter arrays with either different periods or pillar diameters we can isolate individual pass bands in the 1 to 2 THz region.

**Keywords:** SU8, micromachining, filters, THz

## 1. INTRODUCTION

The terahertz region of the electromagnetic spectrum (300 GHz to 10 THz) has attracted considerable attention in recent literature. However, when compared to the optical and microwave regions, it is still relatively unexplored. The so-called ‘terahertz’ gap has now been bridged through the development of efficient generation and detection systems [1]. Applications are rapidly emerging in the fields of imaging and spectroscopy for biomedical, security and manufacturing control. However, the continued development of THz based systems is reliant upon the implementation of new techniques to effectively guide, focus and filter the radiation. Artificial materials have engineered properties which may be difficult to obtain or even unavailable in nature, such as negative refractive indices [2]. This paper reports on the development and testing of artificial material based filters.

Micromachining is the fabrication of three dimensional surfaces and structures at scales from submicron to millimetre and is therefore well suited to the fabrication of terahertz artificial materials (where 1 THz = 300  $\mu\text{m}$ ). Both surface and bulk techniques are well established for the fabrication of three dimensional topologies at micron resolution. These processes are adapted from those used in the integrated circuit industry and therefore can be readily implemented in production environments.

In 2003, Wu *et al* [3] demonstrated a high pass pillar array filter using a direct write microstereolithography based fabrication process. Subsequently, Shew *et al* [4] have used x-ray exposure of SU8 and Torosyan *et al* [5] manually positioned wires into machined grooves to form the devices.

In this paper we investigate the terahertz response of arrays of high aspect ratio gold coated SU8 polymer pillars fabricated with the readily available UV exposure technique. We have shown previously that single period square grid based arrays exhibit a clear pass and stop bands in the THz region (fig. 1) [6]. Here we build upon this work by demonstrating more complex arrays which can isolate and even sharpen specific pass bands. This provides a new type of filtering technology in a region where traditional electrical techniques are difficult to implement.

\*[a.j.gallant@durham.ac.uk](mailto:a.j.gallant@durham.ac.uk), phone +44 191 334 2525 fax +44 191 334 2407

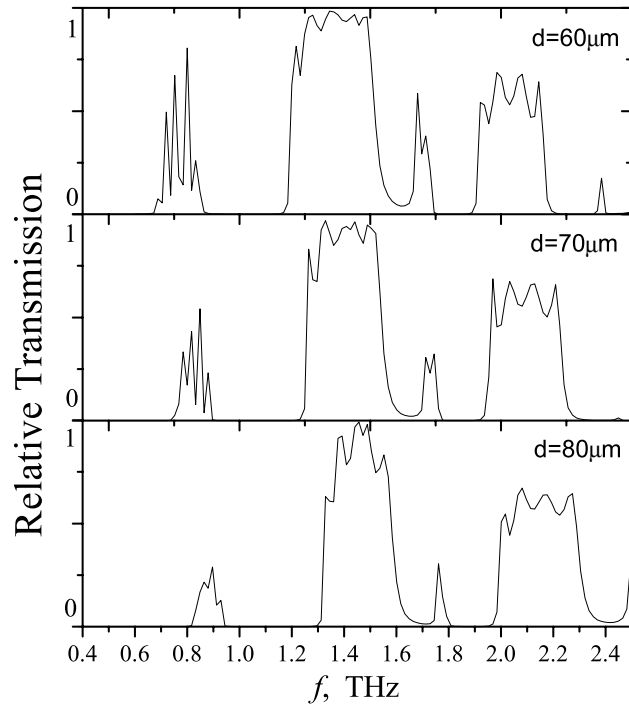

Fig. 1 The FDTD simulated relative transmission of pillar arrays with periods of  $200\mu\text{m}$ , 6 layers deep and various diameters as indicated

## 2. PILLAR ARRAY FILTERS

Fig. 2 shows the principle of operation of the pillar array based filter. It is important to ensure that the incident beam is polarised such that the E field is parallel to the pillars and also well focused. All of the arrays presented in this paper are at least 20 pillars wide with a square based grid arrangement.

The pillar array acts as a diluted metal with an artificially lowered plasma frequency [7]. We have shown previously that, in the region of the artificial plasma frequency, clear pass and stop bands exist. In the pass bands a relative transmission of up to 97% has been achieved [6] which is sufficiently high to enable individual arrays to be combined. This introduces the potential for a multiple filtering approach without significantly impairing the transmission.

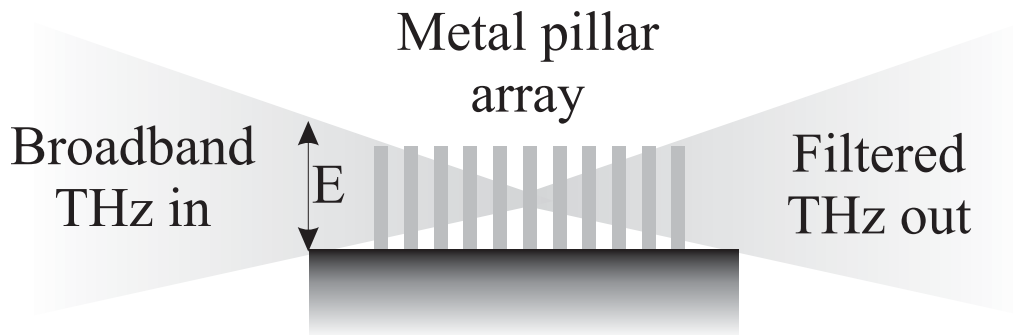

Fig. 2 The filter is placed in a focused THz beam with the E field orientated parallel to the direction of the pillars.

### 3. MEASUREMENT TECHNIQUES

The measurements are performed in a THz time domain spectroscopy system as shown in fig. 3. This has a usable bandwidth of approximately 3 THz. A Ti:sapphire laser produces a 600 mW pulse of 20 fs duration with a repetition rate of 76 MHz. This is separated into a THz generating and a gating beam with a 70:30 beam splitter. The generating beam is focused onto an LT-GaAs photoconductive strip-line emitter which is dc biased to 250V. Parabolic mirrors are used to focus the THz signal onto the pillar array sample.

The beam diameter is approximately 1 mm and is comparable to the height of the pillars. At lower frequencies (hundreds of GHz) the beam is more divergent and can therefore pass over the top of the pillars leading to some unfiltered leakage.

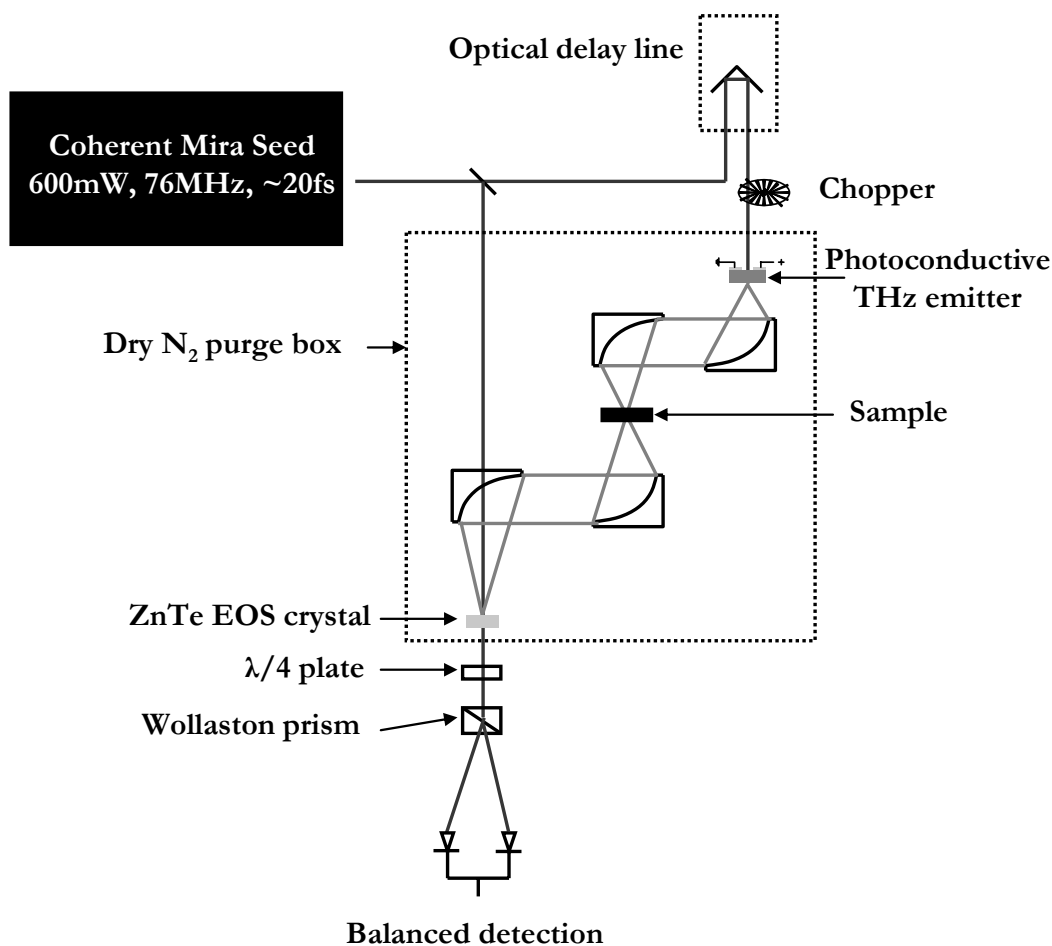

Fig. 3 A schematic of the broadband THz – Time Domain Spectroscopy system

The gating and the THz beam are focused onto a 1 mm thick ZnTe electrooptic crystal. This, in conjunction with a balanced detector, is used to detect the transmitted THz. A delay line on the generation signal allows the electric field of the THz pulse to be scanned in the time domain. A Fast Fourier Transform is then used to obtain a frequency spectrum. This system provides a usable bandwidth of approximately 3 THz.

For relative transmission measurements, the sample scan is divided by a free space scan in the frequency domain. This effectively deconvolves any reflected signals associated with the measurement setup.

The pillar arrays have to be treated as another element in the THz time domain system and therefore, as with a more conventional part of an optical/THz system, require careful optimisation in terms of position. This optimisation is easily

achieved by observing changes in the time domain signal. Fig. 4 shows the clear difference between a free space THz time domain signal and one that has been filtered by the pillar array. A poorly positioned filter leads to a significant low frequency leakage signal.

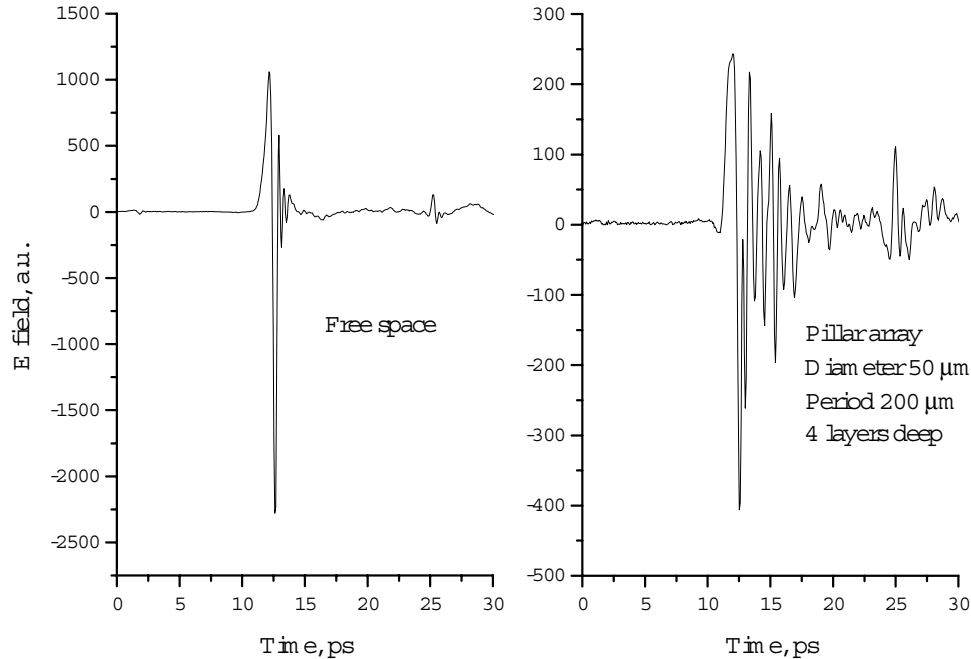

Fig. 4. A measured time domain signal in free space (left) and after pillar array filtering (right)

#### 4. FABRICATION

The fabrication of high aspect ratio pillar arrays is achieved via an SU8 fabrication process. First, an optically opaque metal such as gold is evaporated onto a glass wafer. This metal is then patterned with holes where the SU8 should remain to form the pillars. Then, a layer of SU8-50 is drop dispensed onto the glass wafer and confined by an o-ring during its soft bake stage. This bake is performed for 5 hours at 120 °C.

After cooling, the wafer is flipped over and exposed with broadband UV in order to partially cross link the SU8. Full cross linking is achieved after a post exposure bake of 1 hour at 120 °C. The wafer is then developed in EC solvent and air dried to release the micropillar arrays. Using this technique pillars can readily be fabricated with diameters as small as 40 μm and heights in excess of 1 mm. SU8 layers of several mm can be effectively cured using this technique. However, smaller pillar diameters (i.e. smaller apertures in the gold layer) restrict the incident UV and act to limit the final pillar height.

The SU8 is fairly transparent to the incident THz radiation, and therefore it is necessary to sputter coat the pillars with gold (approximately 0.3 μm). The pillars can, since this is thicker than the skin depth, be treated as metal rods [4]. This fabrication technique is very adaptable since complex pillar arrays can be created by simply changing the photolithographic mask which defines the metal pattern on the glass substrate.

## 5 TESTING

### 5.1 Varying the periodicity

The pillar height is fixed by the fabrication process and primarily acts to effectively confine the beam. Therefore the pillar periodicity and diameter represent the two main variable parameters available for the filter design. We have reported previously the response of individual grid based pillar arrays with various pillar diameters but at a constant period of  $200\ \mu\text{m}$ .

Fig. 5 shows the measured relative transmission for pillar arrays with a range of periods. A clear band structure is evident in the results. The effect of decreasing the period is to increase the fill factor of the structures. Hence the gold becomes less diluted and therefore the band features shift to higher frequencies, closer to the plasma frequency of bulk gold. However, the presence of these multiple bands is undesirable if, for example, it is necessary to excite a sample at a specific single frequency from a broadband source. This is unachievable through the single period or diameter type arrays.

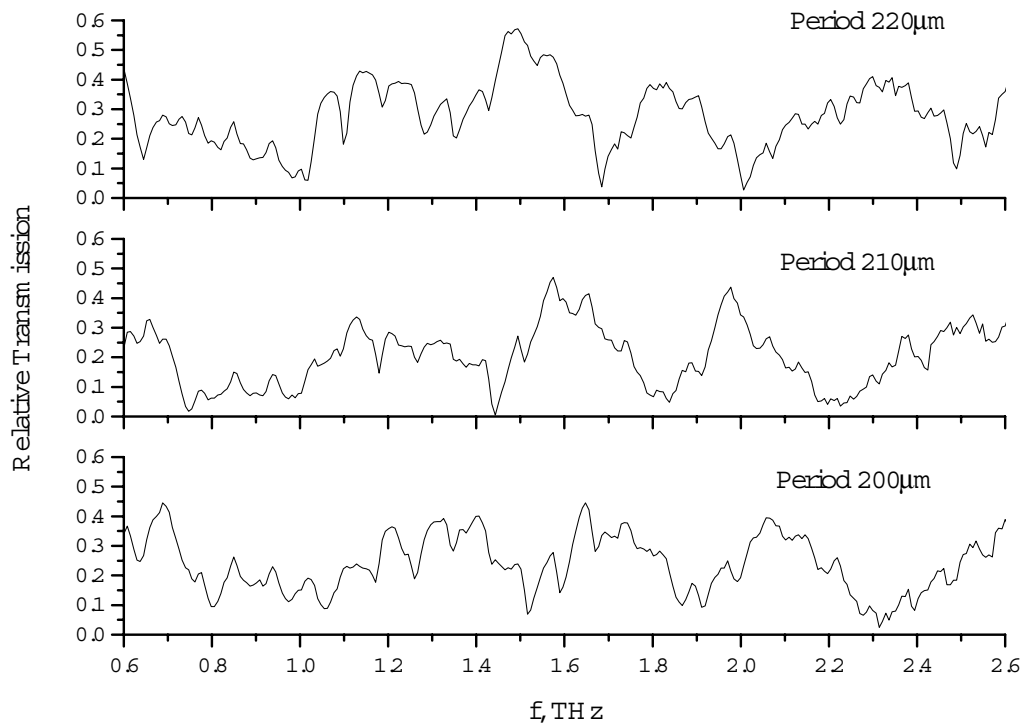

Fig. 5 Relative transmission for pillar arrays with pillar diameter of  $50\ \mu\text{m}$ , 4 layers deep and various periods as indicated

### 5.2 Compound filters: periodicity

As discussed in section 2 it is possible to use the existing fabrication process to produce a compound filter which combines two pillar arrays with, for example, different periodicities. However, as more layers are added it becomes more difficult to fully confine the beam in all of the layers. Fig. 6 shows the relative transmission for three different compound filters. In the  $200\ \mu\text{m}/210\ \mu\text{m}$  and  $200\ \mu\text{m}/220\ \mu\text{m}$  period filters only one pass clear pass band is evident. This can be sharpened by increasing the difference between the periods. However, if the period difference between the two filters is increased too much then the main pass band can be fully extinguished as demonstrated for the  $200\ \mu\text{m}/250\ \mu\text{m}$  period filter shown in fig 6.

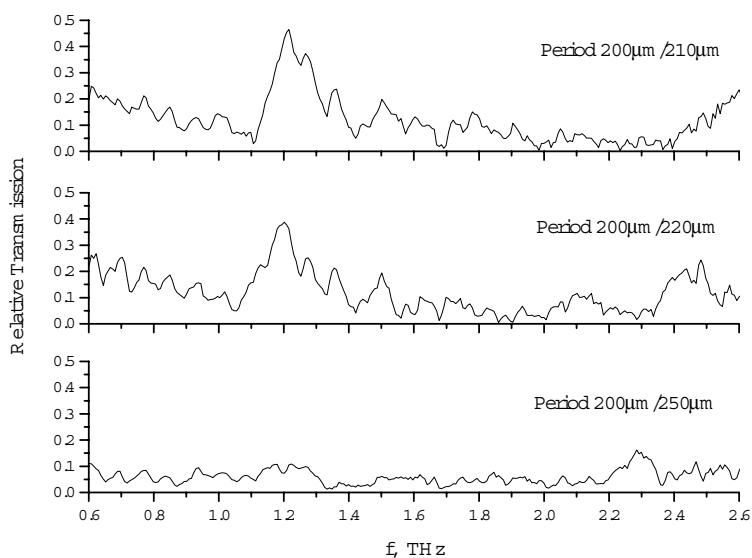

Fig. 6 Relative transmission for compound filters. Each filter consists of two arrays with  $70\ \mu\text{m}$  diameters, 4 layers arranged back-to-back, separated by a gap of  $270\ \mu\text{m}$  with various period combination as indicated.

### 5.3 Compound filters: diameter

The compound filter can also be produced by using arrays of two different pillar diameters. Fig. 7 shows the relative transmission for a device with  $50\ \mu\text{m}$  and  $70\ \mu\text{m}$  diameter pillars. Again, a single pass band is observed which is centred at  $1.38\ \text{THz}$ .

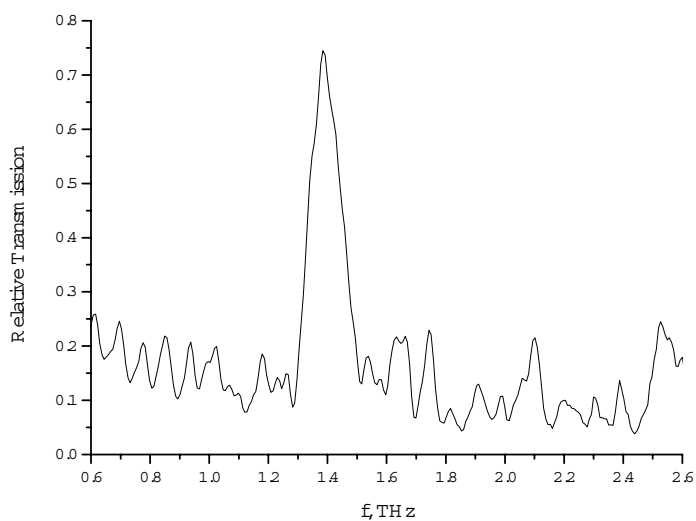

Fig. 7. Relative transmission for a compound filter which consists of 2 pillar arrays with diameters of  $50\ \mu\text{m}$  and  $70\ \mu\text{m}$ . These are separated by a gap of  $300\ \mu\text{m}$  and both have a period of  $200\ \mu\text{m}$ .

When fabricating the compound filters another parameter to consider is the gap between the two pillar arrays. Fig. 8 shows the effect of varying the gap between the  $60\ \mu\text{m}/70\ \mu\text{m}$  pillar arrays. This has a negligible effect on the main pass

band until the gap becomes sufficiently large to make beam confinement difficult. In this situation, if low frequency leakage is to be avoided, then the beam has to be confined by focusing it closer to the substrate. This has the effect of partially chopping the beam and reducing the observed relative transmission in the pass bands.

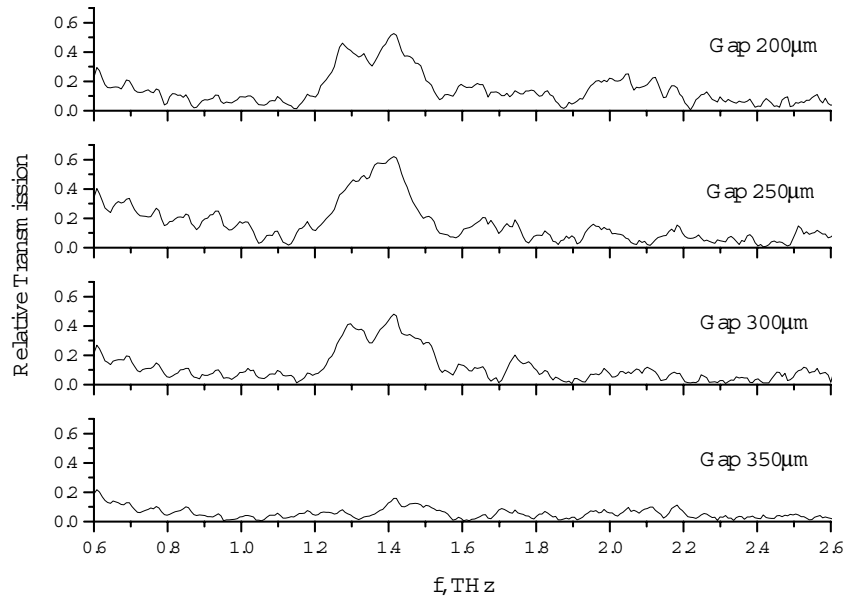

Fig 8. Relative transmission for compound filters consisting of 60µm/70µm diameter arrays both with a period of 200µm, 4 layers deep and separated by a range of gaps as indicated

A further type of filter characteristic can be obtained by varying the pillar diameter, or period within the individual arrays. The effect of this is shown in fig. 9, where the array consists of 4 layers with diameters of 40 µm /50 µm /60 µm /70 µm and a fixed period of 200 µm. A well defined main pass band is appears in the 1.15 to 1.68 THz region. However, unlike the devices shown in figs. 6-8, a secondary pass band between 1.9 and 2.3 THz is also prominent.

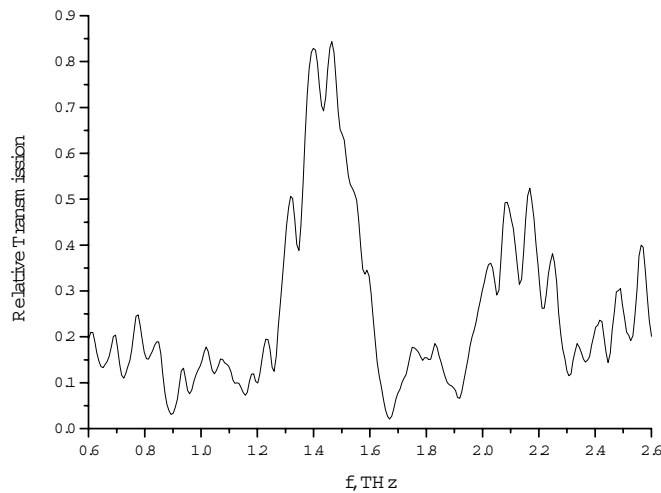

Fig 9. The relative transmission of a pillar array with a period of 200 µm, 4 layers deep with pillar diameters of 40/50/60/70µm



## 6. CONCLUSIONS

The use of micromachining for the fabrication of high aspect ratio pillar array based filters enables a wide variety of filter characteristics to be demonstrated. By combining individual arrays with different periodicities or pillar diameters then single narrow pass bands can be isolated and sharpened. Furthermore, the time domain signal has been shown to be an effective method of optimising the filter elements in the time domain spectrometry system.

The ability to create specific filter characteristics and, in particular, to isolate particular pass bands through the techniques presented in this paper open up a wide variety of filtering possibilities for the THz region. Furthermore, since all of the filters presented in this paper can be fabricated on a single substrate, using a single mask, then tuning can be achieved by simply moving the filter in the THz beam onto another filter type.

## ACKNOWLEDGEMENTS

This project has been funded by the UK Engineering and Physical Sciences Research Council (EPSRC). The authors would like to thank the THz group at Leeds University for the provision of LT-GaAs material and their assistance with the development of the THz time domain spectrometer system.

## REFERENCES

1. P.C.M. Planken, C.E.W.M. van Rijmenam, R.N. Schouten, "Opto-electronic pulsed THz systems", *Semicond. Sci. Technol.*, 20, S121-S127 (2005)
2. D.R. Smith, J.B. Pendry, M.C.K. Wiltshire, "Metamaterials and negative refractive index", *Science*, 305(5685), 788-792 (2004)
3. D.M. Wu, N. Fang, "Terahertz plasmonic high pass filter", *Appl. Phys. Lett.*, 83(1), 201-203 (2003)
4. B.Y. Shew, H.C. Li, C.L. Pan, C.H. Ko, "X-ray micromachining SU-8 resist for a terahertz photonic filter", *J. Phys. D - Appl. Phys.*, 38 (7), 1097-1103 (2005)
5. G. Torosyan, C. Rau and R. Beigang, "Generation and propagation of surface plasmons in periodic metallic structures", *Appl. Phys. Lett.* 85 3372-3374 (2004)
6. A. J. Gallant, D. Wood, J. A. Levitt, M. Kaliteevski, M. C. Petty, S. Brand, R. A. Abram and J. M. Chamberlain, "The Fabrication of High Aspect Ratio THz Metamaterials", *Proc. IET Seminar on Metamaterials for Microwave and (Sub) Millimetrewave Applications*, London, 19 September, 117-120 (2006)
7. S. Brand, M. Kaliteevski, R.A. Abram. "THz frequency studies of metallic structures", *Proc. of SPIE Optics & Photonics - Nanotechnology*, San Diego, CA August, 6328-21 (2006)