

PAPER • OPEN ACCESS

## An Innovative Enhanced Wall to Reduce the Energy Demand in Buildings

To cite this article: F Fantozzi *et al* 2017 *J. Phys.: Conf. Ser.* **796** 012043

View the [article online](#) for updates and enhancements.

### Related content

- [Thermosyphon assisted melting of PCM inside a rectangular enclosure: A synergistic numerical approach](#)  
R Srikanth, Rohit S Nair and C Balaji
- [Experimental study of stability and transients in a horizontally heated boiling helium thermosyphon](#)  
H Furci, A Four and B Baudouy
- [Experiments and simulations on a thermosyphon solar collector with integrated storage](#)  
P Toninelli, A Mariani and D Del Col

# An Innovative Enhanced Wall to Reduce the Energy Demand in Buildings

F Fantozzi<sup>1</sup>, S Filippeschi<sup>1</sup>, M Mameli<sup>1</sup>, S Nesi<sup>1</sup>, G Cillari<sup>1</sup>, M B H Mantelli<sup>2</sup>, F H Milanez<sup>2</sup>

<sup>1</sup>Department of Energy, Systems, Land and Construction Engineering - University of Pisa, Largo L. Lazzarino, 56122, Pisa, Italy

<sup>2</sup> Dr., Mechanical Engineering Department, Federal University of Santa Catarina UFSC, Brazil

Corresponding author: Sauro Filippeschi- [s.filippeschi@ing.unipi.it](mailto:s.filippeschi@ing.unipi.it)

**Abstract.** Energy saving in buildings is one of most important issues for European countries. Although in the last years many studies have been carried out in order to reach the zero-consumption house the energy rate due to passive solar heating could be further enhanced. This paper proposes a method for increasing the energy rate absorbed by opaque walls by using a two phase loop thermosyphon connecting the internal and the external façade of a prefabricated house wall. The evaporator zone is embedded into the outside facade and the condenser is indoor placed to heat the domestic environment. The thermosyphon has been preliminary designed and implanted into a wall for a prefabricated house in Italy. An original dynamic thermal model of the building equipped with the thermosyphon wall allowed the evolution of the indoor temperature over time and the energy saving rates. The transient behaviour of the building has been simulated during the winter period by using the EnergyPlus™ software. The annual saving on the heating energy is higher than 50% in the case of a low consumption building.

## 1. Introduction

Energy saving in buildings is one of the most important issues in European countries. There are several strategies to reduce the energy demand in buildings, such as ventilation, thermal insulation, passive heating and cooling plants. One of the most effective methods is indeed the use of passive solar energy, which is directly supplied to buildings through the windows and through the opaque walls. An interesting research trend in this topic at the moment is the use of "smart envelopes" that are able to exploit the solar energy for the production of both active and passive heating.

This paper proposes an innovative method to increase the energy rate coming from the solar opaque elements by using a loop two phase thermosyphon which directly connects the internal and the external house wall surfaces. Zhang et al. [1] presented a paper on a loop-heat-pipe based solar thermal facade (LHP-STF) installed in a reference residential building. They studied the technical evaluation and the economic advantages of applying this solution in three typical European climates, including North Europe (Stockholm), West Europe (London) and South Europe (Madrid). The research results indicated that the LHP-STF could contribute to the hot water heat load throughout the year, with substantially reduced heating



load in the winter, and yet a slight increased cooling load in the summer. However it is well known that when the gravity field can be exploited, the two-phase loop thermosyphons perform better and they are cheaper than capillary loops [2] [3] and therefore they seem to be more attractive for this kind of applications.

As a first attempt to recover energy from unglazed wall, a new concept with heat pipes or thermosyphons integrated into the facade of a building has been presented by Sun et al. in 2014 [4] and tested by Zhang et al. in 2015 [5] for Chinese climates.

The basic idea consists of a two phase device, named microgravity heat pipe, which presents the evaporator implanted in the outdoor plaster and the condensing section implanted in the inner surface. The main advantage of this solution is the two-phase device efficient unidirectional heat transfer characteristics given by natural convection. The device, indeed, works like a thermal diode that transfers heat directly into the building during winter if the temperature difference between indoor and outdoor is positive and, at the same time, prevents the heat losses in the opposite case. Sun et al in 2014 [4] propose to insert an intelligent manual valve to stop the natural circulation inside the two-phase device. This allows for preventing building heating in summer and consequently increasing the demand on cooling energy.

In 2015, Zhang et al. [5] tested a Wall Implanted Heat Pipe WIHP made of an evaporator section built with 24 capillary pipes (ID=2.7 mm, 600 mm long) implanted into a mortar plaster and a similar sized condenser implanted into the internal plastering layer. This device has been filled with R600a. They have tested a 1720x1720 mm<sup>2</sup> surface facing south at different outside temperature, with an internal air temperature of 18°C. They found out that heat transfer transmittance value of the wall with WIHP ranges from 0.76 to 0.987 W/m<sup>2</sup> K as the outside surface temperature increases from 24 °C to 42 °C. They affirm that this solution decreases the annual energy heating demand by approximately 15% in Jinan climate.

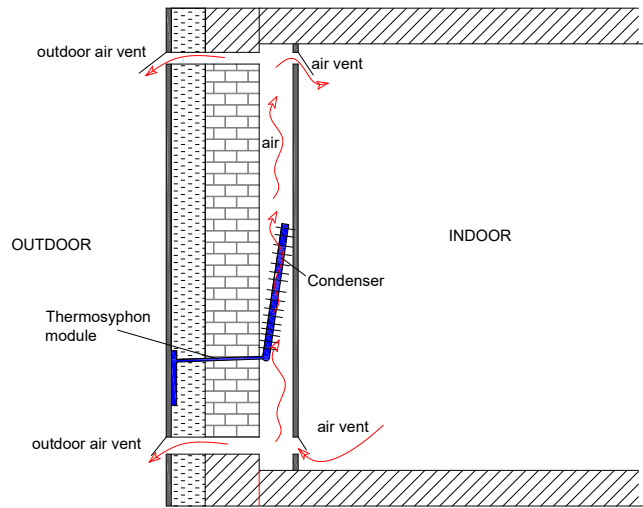
In 2016 Fantozzi et al. [6] proposed a totally new concept two-phase device to enhance the heat transfer performance in prefabricated houses with metallic case. The new device has been modeled and applied to a low consumption house sited in Pisa. The paper shows that the Wall Thermosyphon (WT) is able to enhance the building thermal comfort by keeping the indoor temperature close to the thermal comfort standard for most of the day. The energy saving rates were very high and overcomes rates of 23% of the heating demand during the winter period in the case of a low consumption building.

However, this preliminary analysis presented in [6] is very basic and relative to the specific house described in the paper. In order to understand the real impact of this device on the energy saving rates in Italy a large analysis must be made taking into account more general aspects. The role of the exposition and the surface extension, the impact of the ratio between the heated volume and the WT surface on the global saving rates, the amount of the energy that must be rejected by the systems and other important issues has been analyzed in this paper.

## 2. The Wall Thermosyphon

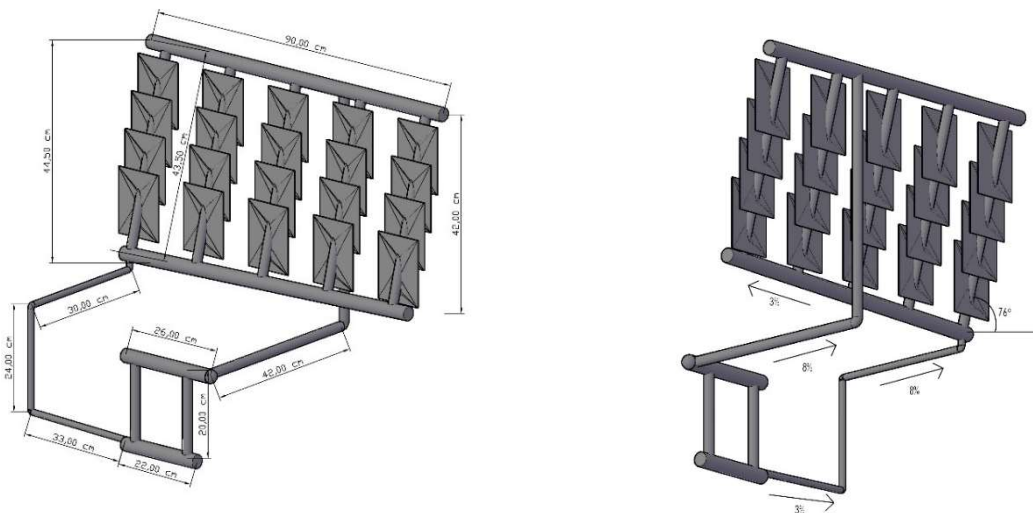
### 2.1. The Working principle

The actual device [6] aims at enhancing the performances of the device proposed by Sun et al. [4]. A loop thermosyphon has been embedded into a wall of prefabricated house as schematically shown in Figure 1. A loop thermosyphon consists of an evaporator (hot source), a condenser (cold source) and two adiabatic arms [7]. In the proposed solution the evaporator is brazed or welded to a metallic façade. This solution can be applied to several prefabricated houses because the use of metallic façades has found a large diffusion in modern architecture. As described in [6] the metallic plate is irradiated by the sun and the loop thermosyphon directly transfers the heat inside the room through the condenser. As the metallic plate temperatures overcomes the inside air temperature the loop thermosyphon transfer heat into the room. This device cannot be switched off as the inside temperature overcomes the standard comfort temperatures. In this case a large amount of heat should be rejected outside through a hollow space inside the internal façade where a finned condenser tube is placed (Figure 1). This cavity is connected both to indoor and outdoor through four opening and closing air vents. The working principle scheme is shown in [6]: as the inside temperature is too high the outdoor vents are opened and the indoor vents are closed and as the indoor temperature is too low, the indoor vents are opened and the outdoor vents are closed.



**Figure 1.** Wall Thermosyphon working principle scheme.

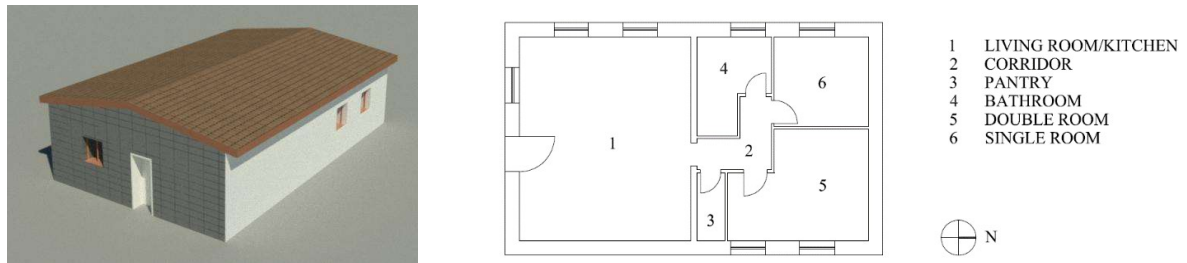
The wall loop thermosyphon designed for this application is similar to the devices described by Milanez and Mantelli [8] and it is shown in Figure 2. The evaporator consists of two vertical aluminum pipes (ID=12 mm) connected with two manifolds (ID=32 mm). The condenser is made of two horizontal manifolds and 5 tilted pipes equipped with 20 rectangular fins 10 mm interspaced. The working fluid is the refrigerant R141. All the dimensions of the loop thermosyphon are shown in Fig. 2.



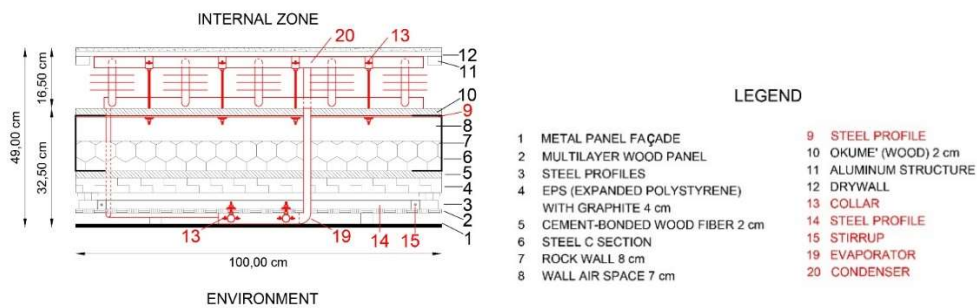
**Figure 2.** Loop Thermosyphon dimensions.

## 2.2 The reference building

The paper proposes to apply this innovative device in a prefabricated wall of a single floor reference house shown in Fig. 3. The reference house has been realized with high efficiency solutions and could be labeled as “low consumption house” in the Italian standard certification labeling procedure with an energy demand lower than 2000 kWh per year.



**Figure 3.** Sample Built House, Rendering and Reference House Map.



**Figure 4.** Vertical wall with the embedded wall thermosyphon.

Such low consumption rates have been reached by using highly insulated walls. The heat transfer transmittances of all the elements are reported in Table 1 and their surfaces are reported in Table 2.

**Table 1.** Heat Transfer Transmittances

Envelopes elements	Total Heat Transfer Transmittance H [W/m <sup>2</sup> K]
Outside Wall	0,21
Inside Wall	0,39
Roof	0,27
Window	1,59
Floor	0,5
Door	1,18

**Table 2.** Surfaces of envelope elements case 1

Envelopes elements	Dimension 1 [m]	Dimension 2 [m]	Surface [m <sup>2</sup> ]	Window surface [m <sup>2</sup> ]	Door Surface [m <sup>2</sup> ]
Floor	7	12	84	-	-
Roof	7	12	84	-	-
South Wall	7	3	21	1,08	2,4
Nord Wall	7	3	21	-	-
Est Wall	12	3	36	2,16	-
West Wall	12	3	36	4,32	-

Being the reference building a prefabricated house, the walls are previously made in a factory and assembled together on site to realize the building. The walls are therefore made of several modules 1 m wide and 3 m high. Each module is equipped with 3 wall thermosyphons as shown in [6].

### 3. Simulation tools and dynamic building analysis

#### 3.1 Dynamic simulation building criteria

The whole prefabricated house has been simulated during its transient behavior by using the software EnergyPlus™ based on a finite difference approach. The implemented algorithm uses an implicit finite difference scheme which is also coupled with an enthalpy-temperature function able to account for the phase change energy phenomena. The building simulated in EnergyPlus™ has no internal gains (people, lights or electric equipment) except ventilation gain with a flow rate of 0,35 V/h (a slightly higher value than that imposed by the Italian legislation for the people comfort standard that is 0,3 V/h) uniformly distributed during a day.

The wall thermosyphon passive plant has been simulated as a dynamic external heating load affected by the outdoor façade temperature and the indoor air temperature. This load hourly changes along the winter period as well as the solar heat flux and the temperature changes. The simulation criterion is detailed in [6] and here briefly summarized. The heat power directly transferred by the WT is positive as the difference between the outdoor façade temperature and the indoor air temperature is positive and it is equal to:

$$q = \frac{T_{SW} - T_{IA}}{R_{wth}} \quad (1)$$

where  $R_{wth}$  is the WT thermal resistance of the wall module.

$$R_{wth} = R_{th} + R_{air} \quad (2)$$

where  $R_{th}$  is the thermal resistance of the two-phase devices,  $R_{wall}$  is the thermal resistance of the wall and  $R_{air}$  is the thermal resistance of the free convection heat transfers at the condensing section. The thermal resistance and the thermal capacitance of the loop thermosiphon are negligible in comparison with the wall. The thermal resistance of the thermosyphon ( $R_{th}$ ) has been estimated with the model described by Milanez and Mantelli [8] and it is considered constantly equal to  $0.03 \text{ m}^2\text{KW}^{-1}$ . If the thermal resistance of the finned condenser section is equal to  $0.05 \text{ m}^2\text{KW}^{-1}$  the thermal resistance of the device is therefore  $0.08 \text{ m}^2\text{KW}^{-1}$ . The total power that the WT is able to transfer inside the building for each hour is given by the heat flux coming from Eq. (s) multiplied for the relative surface. The power transferred by the WT in an hour has been inserted into the EnergyPlus™ platform as a simple convective heat load. The WT energy rate is therefore highly affected by the climate conditions. The energy rates have been calculated by referring to a standard day for each month.

#### 3.2 Monthly Standard Day selection

The energy rates saved during a whole year have been hourly calculated starting for a standard day each month. The energy rates of each day has been therefore multiplied by the number of days of each month comprised in the standard winter season (1st November-15th April for Pisa city). The software EnergyPlus™ uses weather data coming from more than 2100 locations in the world. The weather data are arranged by World Meteorological Organization region and different Country: "Pisa-S. Giusto" is the climate database used in these simulations. These data have been collected from meteorological measuring stations for a year without any filters and post processing activity. They show a wide spreading. In order to limit the error due to the spreading of the weather data a standard day has been defined for each month starting from the original weather database. The standard day selection has been made by comparing the EnergyPlus™ weather database with those coming from the standard UNI EN

10349-1:2016 which reports the average value of several climatic parameters for a standard day of each month. Only the parameters affecting the WT performances have been considered for the selection:

- Site Outdoor Air Dry-bulb Temperature ( $T_{\text{air}}$  [°C])
- Incident Solar Radiation Rate per Area on South Wall ( $W_{\text{south}}$  [W/m<sup>2</sup>])
- Incident Solar Radiation Rate per Area on East-West Wall ( $W_{\text{east-west}}$  [W/m<sup>2</sup>])

**Table 3.** Discrepancy between the EnergyPlus™ database and the standard UNI EN 10349-1:2016

Selected Standard day	Relative Error $T_{\text{air}}$ [%]	Relative Error $W_{\text{south}}$ [%]	Relative Error $W_{\text{east-west}}$ [%]	Average Error [%]
<b>29/01</b>	32,39	5,92	17,61	18,64
<b>6/02</b>	6,96	7,99	39,13	18,03
<b>29/03</b>	10,21	0,12	13,58	7,97
<b>26/04</b>	6,95	18,15	12,28	6,41
<b>20/11</b>	3,94	16,63	36,75	19,11
<b>15/12</b>	9,28	15,32	34,58	19,73

The relative error between the average value of each single parameter listed above and the daily average value shown in UNI EN 10349-1:2016 has been calculated for every day in a month. The selection of the standard climatic parameter is an essential element of most building energy efficiency programs, however there is no widely accepted scientific technique for its delineation. A wide review of this technique is shown in [9]. In this paper the standard day is the day that minimize the average error calculated among the relative errors of each single parameter listed above. Table 3 reports the selected day and shows the minimum average error join with the relative errors of each single parameter.

Table 3 shows that the relative errors of each single parameter are quite high even for the selected day. The highest errors are relative to the parameter  $W_{\text{east-west}}$  going from 12,28% (April) up to 39,16 % (February). The relative errors of  $T_{\text{air}}$  are low and they are generally lower than 10% for all the warming period except for January.

Note that the parameter  $W_{\text{east-west}}$  has however a minor impact on the WT performance of the other two parameters because it is generally lower than  $W_{\text{south}}$  and the east west surface have been consider only in a simulation scenario.

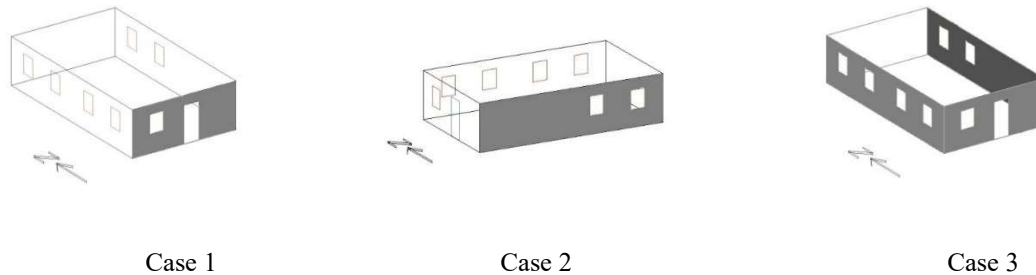
### 3.3 Building simulation cases

The wall thermosyphon has been applied to the building described above. The main aim of this paper is to evaluate the energy rated saved as the wall thermosyphons are applied to the reference building. Previous simulations [6] showed that a building can have very high energy saving rates (ranging from 20% up to 40%) for warming period at Pisa. These energy saving percentages have been obtained without any thermal control systems applied to the building and the indoor air temperature can reach temperatures higher than those recommended to maintain the thermal comfort.

In order to maintain the indoor thermal comfort, the temperature control system above described must be activated. The thermosyphon cannot be switched off so it continuously transfers heat indoor, the control system decides if the heat must be used or rejected outdoor. The temperature control system proposed in this paper is totally passive. Furtherly it has been assumed that the thermal control system is able to naturally remove any amount of energy. The efficiency of this system will be experimentally verified in future. In order to evaluate the impact of the wall thermosyphon on the energy demand in a building is therefore fundamental calculated both the energy saving rates and the energy rates that must be rejected outdoor. The energy rates are highly affected by both the orientation and the surface cover

by the thermosyphon for this reason the building has been simulated in three different significant configurations:

- Case 0: building without any WT
- Case 1: building with WT embedded into the south wall ( $S=7 \times 3 \text{ m}^2$ )
- Case 2: building  $90^\circ$  clockwise rotation with WT embedded into the south wall ( $S=12 \times 3 \text{ m}^2$ )
- Case 3: Case 0 with WT embedded into the south, east and west walls ( $S=31 \times 3 \text{ m}^2$ )

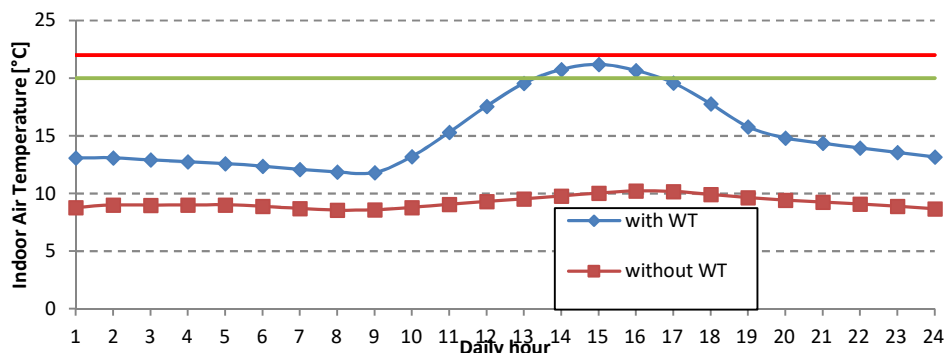


**Figure 5:** Different façade orientations and different WT surfaces studied in the simulations

#### 4. Results and discussions

##### 4.1 Temperature evolution along a standard day for each month

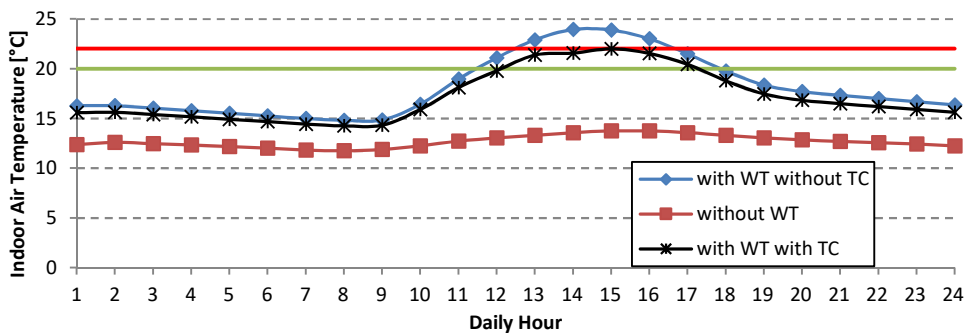
The WT thermosyphon module functioning can be well understood by observing the evolution of the indoor air temperatures along the standard day for each month. Figures 6 and 7 show the hourly evolution of the indoor air temperature  $T_{IA}$  along the selected day of February and November, respectively. Both the figures show the indoor air temperature with and without the wall thermosyphon embedded in the wall and the minimum and the maximum air temperature value recommended to maintain the indoor thermal comfort (20 and 22 °C). The indoor air temperature in the case of WT embedded shown in Figures 6 and 7 are both referred to the case 1. The effect of the wall thermosyphon is evident in both the months.



**Figure 6.** Daily evolution of the indoor air temperatures for the selected day February in case 1 simulation with and without thermosyphons

In February the indoor air remains constantly under the maximum standard comfort temperature threshold and no energy rate must be rejected from the building. In November (Figure 7) the indoor air temperature overcomes the maximum temperature threshold from 12.30 to 15.30 p.m if none thermal control system is active. In this time the heat transferred by the thermosyphon must be removed from the building and outdoor rejected. The hourly temperature evolution with the temperature control systems active for the standard day of November is shown in Figure 7.

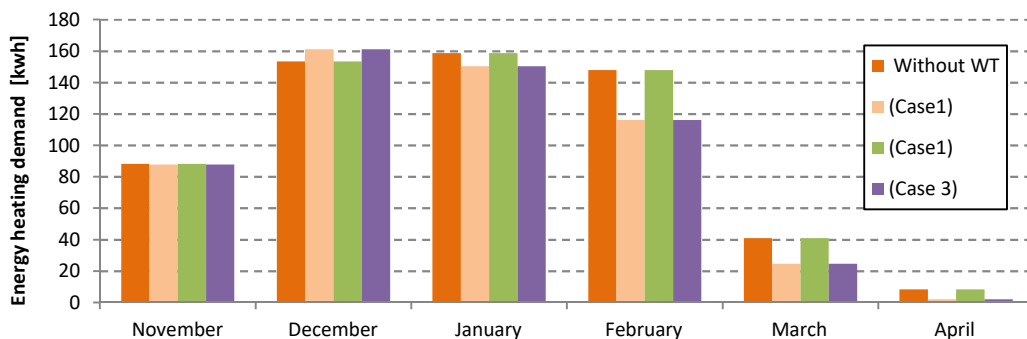




**Figure 7.** Daily evolution of the indoor air temperatures for the selected day of November in case 1 simulation with and without wall thermosyphon (WT) e Thermal Control System (TC)

4.2 Energy saving

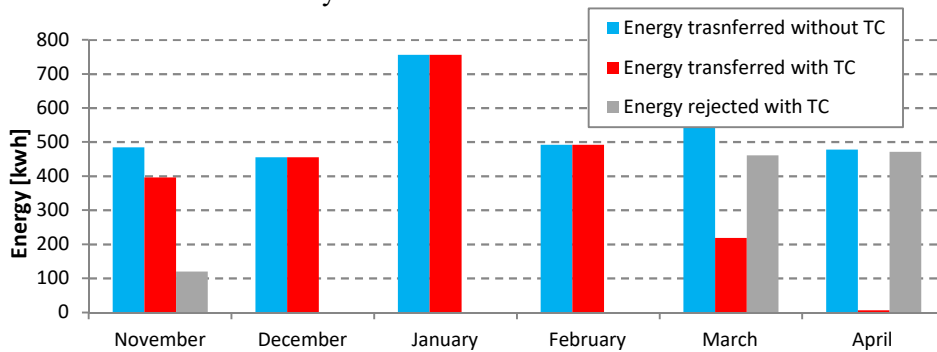
The energy saving rates have been calculated with the temperature control system activated. Figure 8 shows the monthly energy heating demands with the thermosyphon is embedded into the wall compared with those without Thermosyphon for case 1, case 2 and case 3. The wall thermosyphon module allows high energy saving rates by decreasing the energy demand down to 50-55 % even if the reference building is a low consumption house (heating energy annual demand lower than 20 kWh/m<sup>2</sup>). Figure 8 shows that the energy heating demand slightly decreases as the WT module surface faced at south increases (case 2). The energy demand furtherly decrease as the WT module surface is extended at east and west facades. The energy saved percentage with respect the case 0 (without WT) is 52.11% for case 1 and 60.33 % for case 2.



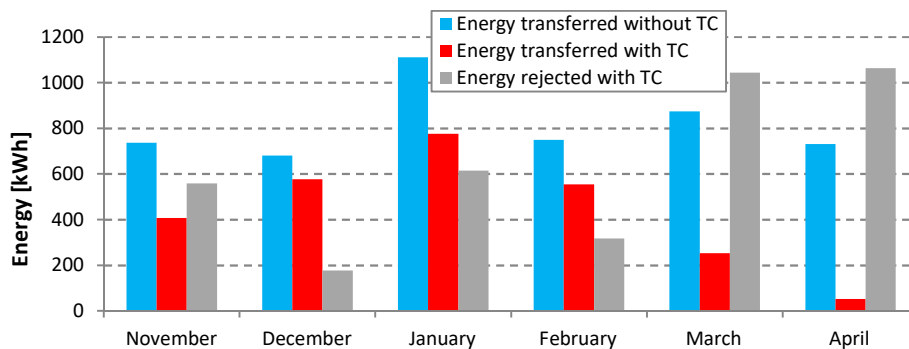
**Figure 8.** Monthly energy heating demand for the house with or without the wall thermosyphon system for cases 1, 2 e 3.

This behavior is due to the effect of the thermal comfort control system that limits the energy saving rates because rejects the most of heat transferred by the thermosyphon along a day (Figure 7). However even if the WT surface (Case 3) grows up to 93 m<sup>2</sup> in comparison with 21 m<sup>2</sup> (Case 1) the energy demands slightly decreases during an year. Even if the most of the surface are east and west faced, the surface enhancement is rather relevant. In this case the energy saved percentages in a whole year grows up to 64.25%. The energy saving is not the only parameter that allows the efficiency characterization of this module. The heat in excess must be rejected because it could make the indoor temperature higher than the thermal comfort limitation. For each month the energy rates that the thermosyphon transfers inside the room (transferred energy)has been evaluated as well as the energy rates that must be outside rejected (rejected energy). These energies have been compared with the energy that WT transfers inside the rooms without any Temperature Control system (TC).

These energy rates are monthly shown in Figg. 9, 10 and 11 for case 1, case 2 and case 3, respectively. Note that the energy rate transferred into the building without any temperature control system (TC) is lower than the sum of the energy really transferred into the house and the energy outdoor rejected. This behavior is due to thermal control system. If none temperature control system is activated the indoor temperature freely raises and the heat transferred by the WT decreases as the inside temperature decreases. On the other hand if the indoor temperature is constantly maintained at 22°C the heat losses are constant and the heat transferred by the WT is lower.

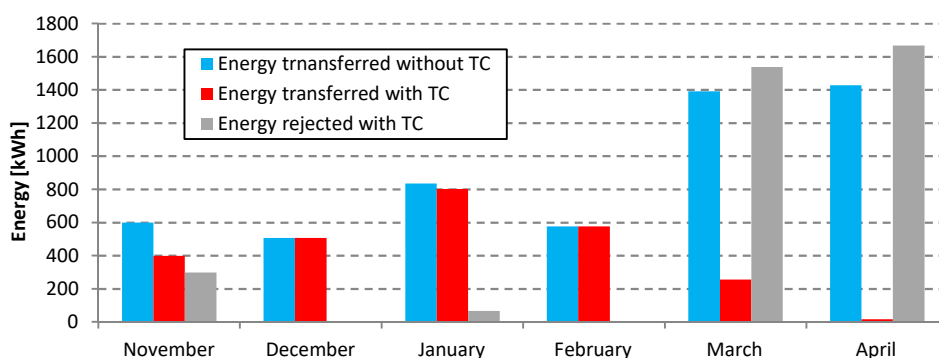


**Figure 9.** Monthly energy rates for the house with or without the temperatures control system for case 1 simulation.



**Figure 10.** Monthly energy rates for the house with or without the temperatures control system for case 2 simulation.

Figures 9, 10 and 11 furtherly show that as the WT surface increases the heat transferred into the buildings increases as well as the heat outdoor rejected. The systems works so efficiently that the energy rates that must be removed increases as the surface south faced increases (case 2 – Fig. 11).



**Figure 11.** Monthly energy rates for the house with or without the temperatures control system for case 3 simulation.

Figure 10 shows that for the case 2 the energy must rejected from the building during all the warming period even in January and December. In April the rates that must be removed only for 15 days is more than 400 kWh. It is really high and if the TC system no efficiently works a real discomfort could be really observed. The problem becomes huge for case 3 simulation, as shown in Fig. 11. The energy rates that must be removed by the TC system are higher than 1000 kWh for March and April and the temperature inside the TC system could reach a really high value. This paper shows that the efficiency of the TC system is crucial for the Wall thermosyphon systems because it transfers so efficiently the sun radiation inside the building that the discomfort condition could be quickly reached.

If the efficiency of the TC systems is known, each building could be optimized by calculating the WT surface in order to conjugate the maximum high saving rate performance with a good thermal comfort standard inside the rooms.

## 5. Conclusions

This paper presents an innovative systems that reduce the energy heating demand in the prefabricated houses in Italy. The system is totally passive and consists of a loop thermosyphon that is embedded inside a wall of a building. The wall thermosyphon has a low inertia and quickly and efficiently transfers the heat irradiated by the sun inside the building. The wall thermosyphon works so efficiently that in the case of a low consumption prefabricated house (heating energy demand lower than 20 kWh/m<sup>2</sup>) the energy saving rates are higher than 50% in all the cases simulated. Unfortunately, the paper shows that energy that must be rejected during the warmer months could reach very large rates that could create discomfort conditions inside the building. If the WT thermosyphon cover the surface south, east and west faced, for example, the energy saving percentage is 62%, but the amount of energy that must be removed is higher than 3400 kWh per year (40 kWh/m<sup>2</sup> year). This paper shows that the efficiency of the TC system is crucial for the Wall thermosiphon systems because it transfer so efficiently the sun radiation inside the building that the discomfort condition could be quickly reached.

## 6. References

- [1] Zhang X, Shen J, Adkins D, Yang T, Tang L, Zhao X, He W, Xu P, Liu C, Luo H 2015 The early design stage for building renovation with a novel loop-heat-pipe based solar thermal facade (LHP-STF) heat pump water heating system: Techno-economic analysis in three European climates, *Energy Conversion and Management*, **106** 964–986.
- [2] Filippeschi S 2011 Comparison between miniature periodic two-phase thermosyphons and miniature LHP applied to electronic cooling equipment, *Applied Thermal Engineering* **31** 795–802.
- [3] Jafari D, Franco A, Filippeschi S, Di Marco P 2016 Two-phase closed thermosyphons: A review of studies and solar applications, *Renewable and Sustainable Energy Reviews* **53** 575–593
- [4] Sun Z, Zhang Z, Duan C 2015 The applicability of the wall implanted with heat pipes in winter of China, *Energy and Buildings* **104** 36–46.
- [5] Zhang Z, Sun Z, Duan C 2014 A new type of passive solar energy utilization technology—The wall implanted with heat pipes, *Energy and Buildings* **84** 111–116.
- [6] Fantozzi F, Filippeschi S, Mameli M, Mantelli M B H Milanez F H 2016 How a wall thermosyphon can enhance the energy savings in a prefabricated house in Italy, *Joint 18th IHPC and 12th IHPS conference Jeju South Korea June 12-16*.
- [7] Franco A., Filippeschi S. 2010 Experimental analysis of Closed Loop Two Phase Thermosyphon (CLTPT) for energy systems, *Exp. Thermal and Fluid Science* **51** 302-311.
- [8] Milanez F H, Mantelli M B H, 2010 Heat transfer limit due to Pressure drop of a two-phase loop Thermosyphon, *Heat Pipe Science and Technology, An International Journal* **1(3)** 237–250 .
- [9] Walsh A, Cóstola D, Chebel Labaki L 2017 Review of methods for climatic zoning for building energy efficiency programs, *Building and Environment*, **112**, 337-350.
- [10] Caruso G Fantozzi F Leccese F 2013 Optimal theoretical building form to minimize direct solar irradiation *Solar Energy* **97** 128-137.