



**CARDIORESPIRATORY FITNESS, PHYSICAL ACTIVITY, SEDENTARY BEHAVIOUR AND
VASCULAR HEALTH IN MALE ADOLESCENTS**

Sinead E. Sheridan, BSc.

PhD

January 2016

**CARDIORESPIRATORY FITNESS, PHYSICAL ACTIVITY, SEDENTARY BEHAVIOUR AND
VASCULAR HEALTH IN MALE ADOLESCENTS**

Sinead E. Sheridan, BSc.

Submitted for the award of PhD.

Dublin City University

School of Health and Human Performance

Supervisor: Prof Niall M. Moyna

Submitted: January 2016

Volume 1 of 1

Declaration

I hereby certify that this material, which I now submit for assessment on the programme of study leading to the award of PhD is entirely my own work, that I have exercised reasonable care to ensure that the work is original, and does not to the best of my knowledge breach any law of copyright, and has not been taken from the work of others save and to the extent that such work has been cited and acknowledged within the text of my work.

Signed: _____ **ID No.** 57878834 **Date** _____

Acknowledgements

I would like to sincerely thank the following people who have been influential and have greatly contributed to my experience over the past four years in DCU:

Prof. Niall Moyna for providing me with this life-changing opportunity for which, I am truly grateful. An inspirational person, a wonderful teacher and a great friend, he has provided me with the skills and confidence to pursue an independent career in research. Although this journey has come to an end, I look forward to collaborating with him in the coming years.

To former postgraduate students Mickey, Paul, David, Cathal, Sarah, Crionna, Bróna and Bryan for your support and friendship along the way

A special thanks to Mickey for his wisdom, kindness and prayers. Thank you for helping me “keep the faith”.

To new postgraduate students Clare and Eoin. Your friendship and support has helped my sanity and made my final months in the Vascular Research Unit all the more enjoyable.

The rest of my fellow postgrads, the staff in the School of Health and Human Performance, a massive thank you for your kindness and support throughout.

A special word of thanks to Aisling, for always being there when needed. Your friendship and support was invaluable. The school is truly blessed to have you.

To Mary in Invent, for your motherly nature and for *always* making me smile. It’s true that the best things in life come in small packages!

Thank you to Paul, Rob and Laura for assisting with blood sampling and analysis throughout my studies. Your contribution to my research was invaluable.

Dr. Cleona Gray, for her guidance and tuition. An exceptional ultrasonographer and teacher she has enabled me to perform my research to the highest standard and to pass on this skill to fellow PhD students.

Dr. Kieran Dowd, who volunteered his time so generously. Your guidance and advice was invaluable.

To all at Waterford Institute of Technology for assisting with blood analysis.

To Nicola, for your assistance with my research during your INTRA placement. A true friend, I am so grateful for having got to know you during this time.

To my funding sources: The Daniel O' Hare Faculty of Science and Health Research Scholarship and INSIGHT, for supporting me throughout my studies and affording me the opportunity to pursue my research to the highest standard.

A huge thank you to all of my participants and the schools involved in my research A heartfelt thank you to Alan O' Neill, for always facilitating me with participant recruitment and for being a great friend.

To Tracey, for being such loyal and understanding friend and for *always* being there.

To Michael and Enda and all in DCU GAA/Athletics academy. Thank you for all your help, kindness and friendship over the past number of years.

A word of thanks to all of my friends outside of DCU. A constant source of support and love, I am truly blessed to have you all in my life.

To my sister Niamh, for *always* being there and *always* understanding.

To my parents, Martin and Gertie, for their unconditional love. I would not have achieved all that I have in life without your support. I am eternally grateful for everything that you have both done for me.

Finally, from the bottom of my heart, I would like to thank my beloved boyfriend John. Despite being on the other side of the world, his love, patience, encouragement and understanding over the past few months has been instrumental in this achievement. As this journey draws to an end, I look forward to embarking on the next chapter of my life with him, both in research and love.

Table of Contents

Declaration _____	iii
Acknowledgements _____	iv
Table of Contents _____	vi
List of Figures _____	xii
List of Tables _____	xiii
Abstract _____	xvi
Abbreviations _____	xviii
Chapter I INTRODUCTION _____	1
Rationale _____	1
Study Aims _____	5
Hypotheses _____	5
Chapter II REVIEW OF LITERATURE _____	7
Cardiovascular Disease _____	7
Blood Vessel Structure _____	7
Pathophysiology of Atherosclerosis _____	8
Origin of Atherosclerosis _____	10
Cardiovascular Disease Risk Factors _____	11
Risk Factors and Early Atherosclerosis _____	12
Clustering of CVD Risk Factors _____	14
Tracking of CVD Risk factors _____	14
Childhood Risk factors and Subclinical Atherosclerosis in Adulthood _____	15
Vascular Biology _____	17
Endothelial Function _____	17
Vascular Endothelium – Structure _____	17
Vascular Smooth Muscle Contraction _____	17
Vascular Smooth Muscle Relaxation _____	19
Vascular Endothelial Dysfunction _____	21
Assessment of Endothelial Function _____	22
Brachial Artery Flow Mediated Dilation (FMD) _____	23
Peripheral Arterial Tonometry _____	24
Normative Brachial Artery FMD Values _____	25
Endothelial Function and Puberty _____	26
Endothelial Function and CVD Risk Factors in Children _____	27
Exercise/Physical Activity and Endothelial Function _____	35
Endothelial Function and Cardiorespiratory Fitness - Cross Sectional Studies _____	36
Endothelial Function, cIMT and Cardiorespiratory Fitness - Training Studies _____	37
Endothelial Function - Diet and Exercise _____	40
Endothelial Function – Physical Activity _____	41
Endothelial function – Sedentary Behaviour _____	42
Mechanisms for Exercise-induced Improvements in Endothelial Function _____	42
Carotid Intima Media Thickness _____	44
cIMT – Measurement _____	45

cIMT Values in Healthy Children _____	46
Vascular Aging _____	46
cIMT and CVD Risk Factors _____	47
cIMT and Obesity _____	48
cIMT and Hypertension _____	49
cIMT and Type 1 Diabetes Mellitus _____	50
cIMT and Type 2 Diabetes Mellitus _____	50
cIMT and Familial Hypercholesterolemia _____	51
cIMT – Cardiorespiratory Fitness _____	52
cIMT- Physical Activity _____	55
CIMT- Sedentary Behaviour _____	55
Aortic Intima Media Thickness _____	56
Inflammation and CVD _____	59
High Sensitivity C-Reactive Protein (hsCRP) _____	60
Serum Amyloid A (SAA) _____	63
Interleukin-6 (IL-6) _____	63
TNF- α _____	64
Interleukin 1 (IL-1) _____	65
Vascular Adhesion Molecules _____	65
INF- γ _____	66
Inflammation, Endothelial function and cIMT _____	66
Exercise and Inflammation _____	68
Exercise, Diet and Inflammation _____	70
Cardiorespiratory Fitness _____	75
Determinants of Cardiorespiratory Fitness _____	76
Measurement of Cardiorespiratory Fitness _____	76
Cardiorespiratory Fitness and All-cause and CVD Mortality _____	78
Mechanisms linking CRF and Reduction in All-Cause and CVD mortality _____	80
Cardiorespiratory Fitness and CVD risk in Youth _____	81
Cardiorespiratory Fitness Classification in Youth _____	87
Cardiorespiratory Fitness in Adolescence and CVD risk factors in Adulthood _____	89
Tracking of CVD Risk Factors from Adolescence to Adulthood _____	91
Limitations of Maximal Exercise Testing _____	91
Ventilatory Anaerobic Threshold _____	92
Oxygen Uptake Efficiency Slope _____	93
Calculation of OUES _____	93
Prognostic Value of OUES _____	95
OUES in children _____	95
OUES in overweight/ obese children _____	97
OUES and Vascular Function _____	101
Physical Activity _____	101
Physical Activity Recommendations _____	102
Measurement of Physical Activity _____	102
Physical Activity and CVD risk factors in Children and Adolescents _____	103
Physical Activity in Adolescence and CVD risk factors in Adulthood _____	108
Tracking of Physical Activity _____	109
Sedentary Behaviour _____	109

Measurement of Sedentary Behaviour _____	110
Sedentary Behaviour and Cardiometabolic Health _____	111
Sedentary Behaviour and Insulin Action _____	112
Sedentary Behaviour and Vascular Function _____	114
Sedentary Behaviour in Children and Adolescents _____	115
Sedentary Behaviour and CVD Risk Factors in Children and Adolescents _____	115
Chapter III _____	123
STUDY 1 _____	123
MAXIMAL AEROBIC CAPACITY, SELECTED CVD RISK FACTORS AND VASCULAR HEALTH IN MALE ADOLESCENTS _____	123
Rationale _____	123
Study Purpose _____	126
Specific Aims _____	126
Hypothesis _____	126
Methodology _____	128
Study Overview _____	128
Participants _____	128
20-MST _____	129
Study Visit _____	129
Body Mass Index _____	130
Waist-to-hip ratio _____	131
Body Fat _____	131
Maturation _____	131
Blood Pressure _____	132
Blood Sampling _____	132
Biochemical Analysis _____	132
Insulin Sensitivity _____	133
Proinflammatory cytokines _____	133
Markers of Vascular Injury _____	133
Overview of Endothelial Function Assessment _____	134
Participant Preparation _____	135
Ultrasound Technique and Image Acquisition _____	136
M Mode Imaging _____	136
Doppler Imaging _____	137
Endothelial -Dependent Dilation (EDD) _____	138
Endothelial-Independent Dilation _____	139
Off-line Arterial Measurement Software _____	140
Carotid Intima Media Thickness _____	141
Maximal Aerobic Capacity ($\dot{V}O_2\text{max}$) _____	142
Cardiorespiratory and Metabolic Measures _____	143
Mass Flow Sensor Heated Wire Anemometer- Mode of Operation _____	143
Mass Flow Sensor Calibration _____	144
Gas Analysers _____	145
Calibration of CO ₂ and O ₂ Analysers _____	146
Statistical Analysis _____	146
RESULTS _____	148

Participant characteristics _____	148
Physiological and Perceptual Responses at Maximal Exercise _____	149
Blood Lipids _____	149
Insulin sensitivity _____	150
Cytokines and Vascular Adhesion Molecules _____	151
Endothelial Function _____	151
Carotid Intima media thickness _____	153
Univariate Correlations - EDD _____	153
Univariate Correlations – cIMT _____	155
Summary of Results _____	158
Chapter IV _____	159
STUDY 2 _____	159
OXYGEN UPTAKE EFFICIENCY SLOPE AND VASCULAR HEALTH IN MALE ADOLESCENTS _____	159
Rationale _____	159
Study Purpose _____	162
Specific Aims _____	162
Hypothesis _____	162
Methodology _____	164
Overview of Study Design _____	164
Participants _____	164
Participant Recruitment _____	164
Body Mass Index _____	164
Body Surface Area _____	164
Maturation _____	164
Endothelial Dependent Dilation and Endothelial Independent Dilation Assessment _____	165
Carotid Intima Media Thickness _____	165
Maximal Aerobic Capacity ($\dot{V}O_2\text{max}$) _____	165
Oxygen Uptake Efficiency Slope (OUES) _____	165
Ventilatory Anaerobic Threshold _____	166
Cardiorespiratory and Metabolic Measures _____	166
Mass Flow Sensor Heated Wire Anemometer- Mode of Operation _____	166
Mass Flow Sensor Calibration _____	167
Gas Analysers _____	167
Calibration of CO_2 and O_2 Analysers _____	167
Statistical Analysis _____	167
RESULTS _____	168
Participant characteristics _____	168
OUES and $\dot{V}O_2\text{max}$ _____	168
OUES and EDD _____	169
OUES and cIMT _____	172
Maximal and Submaximal OUES values _____	174
Summary of Results _____	179

Chapter V	180
STUDY 3	180
PHYSICAL ACTIVITY, SEDENTARY BEHAVIOUR, SELECTED CVD RISK FACTORS AND VASCULAR HEALTH IN MALE ADOLESCENTS	180
Rationale	180
Study Purpose	183
Specific Aims	183
Hypothesis	183
Methodology	185
Study Overview	185
Participants	185
Participant recruitment	185
Body Mass Index	185
Waist-to-Hip Ratio	185
Body fat	185
Maturation	185
Blood Pressure	186
Blood Sampling	186
Biochemical Analysis	186
Insulin Sensitivity	186
Pro-inflammatory cytokines assays	186
Vascular Adhesion molecules assays	186
Endothelial Dependent Dilatation and Endothelial Independent Dilatation Assessment	186
Carotid Intima Media Thickness	186
Physical Activity and Sedentary Behaviour Measurement	187
Data Processing	188
Sedentary Behaviour	189
Statistical Analysis	190
RESULTS	191
Participant characteristics	191
Blood Lipids	192
Insulin Sensitivity	192
Inflammatory Markers and Adhesion Molecules	193
Physical Activity and Sedentary Behaviour	193
Total Time in Physical Activity and Sedentary Behaviour	193
Waking/Sleeping hours	194
Percentage of Waking Hours Spent Sitting/Lying and in PA Behaviours	194
Number of sedentary bouts	195
Sedentary bout duration	196
PA behaviours and $\dot{V}O_2\text{max}$	197
Sedentary behaviours and $\dot{V}O_2\text{max}$	197
Sedentary time and CVD risk factors	200
Endothelial Function	200
EDD and EID – Group Comparisons	200
Physical Activity and Endothelial Function	201

$\dot{V}O_2$ max and Endothelial Function _____	203
Sedentary Behaviour and Endothelial Function _____	204
Carotid Intima Media Thickness _____	206
cIMT - Group Comparisons _____	206
Physical Activity and cIMT _____	206
$\dot{V}O_2$ max and cIMT _____	209
Sedentary Behaviour and cIMT _____	209
Summary of Results _____	212
Chapter VI DISCUSSION _____	213
Overview _____	213
Study 1 _____	214
Study 2 _____	220
Study 3 _____	225
Study Limitations _____	235
Future Directions _____	236
Chapter VII CONCLUSION _____	237
References _____	239
Appendices _____	277
Appendix A _____	277
Appendix B _____	302
Appendix C _____	303
Appendix D _____	304
Appendix E _____	307

List of Figures

- Figure 2.1: Structure of large and medium sized arteries
- Figure 2.2: Vascular smooth muscle contraction
- Figure 2.3: Vascular smooth muscle relaxation
- Figure 2.4: Effect of circuit training on brachial artery FMD in obese adolescents in comparison to lean age-matched controls
- Figure 2.5: Calculation of oxygen uptake efficiency slope (OUES)
- Figure 3.1: Order of tests undertaken by participants during the study visit
- Figure 3.2: Sonosite MicroMaxx® ultrasound system and 12.0 MHz linear array transducer
- Figure 3.3: Arm position and cuff placement.
- Figure 3.4: M mode ultrasound image of the brachial artery
- Figure 3.5: Frozen screen shot of a Doppler image
- Figure 3.6: Overview of the protocol used to assess endothelial-dependent dilation
- Figure 3.7: Overview of the protocol used to assess endothelial-independent dilation
- Figure 3.8: Standard Dialog box
- Figure 3.9: Participant position for cIMT measurement
- Figure 3.10: Measurement of cIMT
- Figure 3.11: Percent change in EDD (A) and EID (B) in HF, MF and LF
- Figure 3.12: Relation between $\dot{V}O_2\text{max}$ and percent change in EDD
- Figure 4.1: Example of how the VAT was determined
- Figure 4.2: Relation between maximal OUES/kg and percent change in EDD
- Figure 4.3: Relation between submaximal OUES/kg and percent change in EDD
- Figure 5.1: ActivPAL3™ triaxial physical activity logger
- Figure 5.2: ActivPAL3™ placement

List of Tables

- Table 2.1: Cross sectional studies comparing EDD and EID responses in overweight/obese children and healthy children and adolescents
- Table 2.2: Cross sectional studies comparing EDD and EID responses in children and adolescents with T1DM/T2DM and healthy children and adolescents
- Table 2.3: Cross sectional studies comparing EDD and EID responses in children and adolescents with familial hypercholesterolemia and healthy children and adolescents
- Table 2.4. Cross-sectional studies examining the relation between CRF and cIMT in healthy children and adolescents
- Table 2.5: Studies examining the effect of exercise on flow mediated dilation, cIMT, CVD risk factors and CRF in children and adolescents
- Table 2.6: Studies examining the effect of exercise on markers of inflammation, flow mediated dilation, cIMT, CVD risk factors and CRF in children and adolescents
- Table 2.7: Cross-sectional studies examining the relation between CRF and clustering of cardiometabolic disease risk factors in healthy children and adolescents
- Table 2.8: Proposed CRF classification in children and adolescents
- Table 2.9: Studies that examined the OUES in healthy and overweight/obese children and adolescents.
- Table 2.10: Cross sectional studies that examined the relation between objectively measured PA and clustered metabolic risk factors in children and adolescents.
- Table 2.11: Cross sectional studies that examined the relation between objectively measured sedentary behaviour and clustered metabolic risk factors in children and adolescents.
- Table 3.1: Physical characteristics and resting blood pressure in participants
- Table 3.2: Physiological and perceptual responses at maximal exercise
- Table 3.3: Fasting serum levels of circulating blood lipids
- Table 3.4: Fasting serum levels of glucose, insulin and HOMA-IR
- Table 3.5: Pro-inflammatory cytokines and vascular adhesion molecules
- Table 3.6: Brachial artery diameter, absolute change in EDD and EID and peak blood flow velocity

- Table 3.7: Near and far wall cIMT measurements of right and left CCA
- Table 3.8: Univariate relation between EDD and selected CVD risk factors
- Table 3.9: Univariate analysis between selected CVD risk factors and cIMT
- Table 4.1: Physical characteristics in participants
- Table 4.2: Univariate analysis between maximal and submaximal OUES parameters and absolute $\dot{V}O_2\text{max}$ and $\dot{V}O_2\text{max}$ relative to body weight and BSA
- Table 4.3: Univariate relations between EDD and selected submaximal and maximal physiological parameters
- Table 4.4: Univariate analysis between physiological characteristics during exercise and cIMT
- Table 4.5: Maximal and submaximal OUES in participants
- Table 4.6: Exercise parameters during the graded exercise test
- Table 4.7: Univariate analysis between OUES and anthropometric parameters
- Table 5.1: Physical characteristics, blood pressure and maximal aerobic capacity in participants
- Table 5.2: Fasting serum levels of circulating blood lipids in participants
- Table 5.3: Fasting serum levels of glucose, insulin and HOMA-IR in participants
- Table 5.4: Pro-inflammatory cytokines and vascular adhesion molecules
- Table 5.5: Total time spent in sitting/lying, standing, LIPA and MVPA and the number of steps per day
- Table 5.6: Percentage of waking hours spent in sitting/lying, standing, LIPA and MVPA per day
- Table 5.7: Number of daily bouts spent in sedentary categories
- Table 5.8: Duration of daily sedentary bouts spent in sedentary categories
- Table 5.9: Summary of the relation between PA behaviours and $\dot{V}O_2\text{max}$
- Table 5.10: Relation between sedentary behaviours and $\dot{V}O_2\text{max}$
- Table 5.11: Correlation coefficients between PA behaviours during waking hours and CVD risk factors
- Table 5.12: Resting brachial artery diameter and absolute and percentage change in EDD and EID
- Table 5.13: Correlation coefficients between PA behaviours and EDD

Table 5.14: Correlation coefficients between sedentary behaviours and EDD

Table 5.15: Near and far wall cIMT measurements of right and left CCA

Table 5.16: Correlation coefficients between PA behaviours and cIMT

Table 5.17: Correlation coefficients between sedentary behaviours and cIMT

Abstract

Sheridan, Sinead E. Cardiorespiratory Fitness, Physical Activity, Sedentary Behaviour and Vascular Health in Male Adolescents

Study 1: A high cardiorespiratory fitness (CRF) level is positively associated with a more favorable cardiometabolic health profile in adolescents. Limited information exists on the relation between CRF and vascular health in healthy adolescents. The purpose of this study was to compare cardiovascular disease (CVD) risk factors and vascular health in healthy low fit (LF), moderate fit (MF) and high fit (HF) male adolescents. LF male adolescents had significantly poorer endothelial dependent dilation (EDD) and cardiovascular health profile and significantly higher carotid intima media thickness (cIMT) compared to both MF and HF. There was a significant positive relation between $\dot{V}O_2\text{max}$ and EDD and a significant inverse association between $\dot{V}O_2\text{max}$ and cIMT in healthy male adolescents.

Study 2: The oxygen uptake efficiency slope (OUES) has been proposed as an objective and effort independent submaximal measure of CRF and may serve as an alternative to $\dot{V}O_2\text{max}$ when assessing CRF in adolescents. This study evaluated OUES and vascular health in LF, MF and HF healthy male adolescents with low, moderate and high CRF. Maximal and submaximal OUES expressed relative to body weight were significantly higher in HF than both MF and LF. There was a significant positive relation between both maximal and submaximal OUES and EDD and a significant inverse relation between maximal and submaximal OUES and cIMT. In a stepwise

multiple linear regression analysis that included $\dot{V}O_{2\max}$, maximal OUES and submaximal OUES, only $\dot{V}O_{2\max}$ was a significant predictor of EDD.

Study 3: This study compared physical activity (PA) levels, sedentary behaviour, CVD risk factors and vascular health in LF, MF and HF apparently healthy male adolescents. Time spent in moderate-to-vigorous PA (MVPA) was significantly higher and time spent sitting/lying was significantly lower in HF than both MF and LF. Time spent in light intensity PA (LIPA) was significantly higher in HF than LF. Time in MVPA and LIPA were both significantly and positively related with EDD and inversely related to cIMT. There was a significant inverse relation between time sitting/lying and EDD and a significant positive relation between time sitting/lying and cIMT.

Conclusion: cIMT was significantly higher and EDD was significantly lower in LF than both MF and HF. While OUES, PA and sedentary time were all significantly related to markers of vascular health, a more robust relation was observed between $\dot{V}O_{2\max}$ and vascular health. Furthermore, $\dot{V}O_{2\max}$ was independently related to EDD and cIMT.

Abbreviations

ACh	Acetylcholine
ACVD	Atherosclerotic cardiovascular disease
ADAMA	Asymmetric dimethylaminohydrolase
AHA	American heart association
AIT	Aerobic interval training
aIMT	Aortic intima media thickness
ApoA1	Apo lipoprotein A-1
ApoB	Apo lipoprotein B
ATP	Adenosine triphosphate
AWV	Aortic wave velocity
BF	Blood flow
BH ₄	Teretrahydrobiopterin
BMI	Body mass index
BP	Blood pressure
BSA	Body surface area
CAD	Coronary artery disease
CCA	Common carotid artery
CDE	Conjugated diene
cGMP	Cyclic guanosine monophosphate

CHD	Coronary heart disease
cIMT	Carotid intima media thickness
CMD	Cardiometabolic disease
CRF	Cardiorespiratory fitness
CT	Circuit training
CVD	Cardiovascular disease
d	Day
DAG	Diacylglycerol
DBP	Diastolic blood pressure
DHEAS	Dehydroepiandrosterone sulphate
EC	Endothelial cells
EDD	Endothelial-dependent dilation
EID	Endothelial-independent dilation
EMP	Extracellular matrix proteins
eNOS	Endothelial derived nitric oxide synthase
FFM	Fat free mass
FH	Familial hypercholesterolemia
FMD	Flow-mediated dilation
GAGs	Glycosaminoglycans
GTN	Glyceryl trinitrate
GTP	Guanosine triphosphate

h	Hour
HbA _{1c}	Glycosylated hemoglobin
HDL-C	High-density lipoprotein cholesterol
HF	High Fit
HIIT	High-intensity interval training
HOMA-IR	Homeostasis model assessment of insulin resistance
HR	Heart rate
HRmax	Maximal heart rate
hsCRP	High sensitivity C reactive protein
Hx	History
Ig	Immunoglobulin
IL-10	Interleukin-10
IL-1ra	Interleukin- 1 receptor antagonist
IL-1 β	Interleukin-1 beta
IL-6	Interleukin-6
IMT	Intima media thickness
INF- γ	Interferon gamma
IP3	Inositol 1,4,5-triphosphate
IR	Insulin resistance
LDL-C	Low-density lipoprotein cholesterol
LF	Low fit

LIPA	Light intensity physical activity
LP	Late puberty
LPL	Lipoprotein lipase
LT	Lactate threshold
LTPA	Leisure time physical activity
LVH	Left ventricular hypertrophy
M-CSF	Macrophage colony-stimulating factor
MCP-1	Monocyte chemotactic protein-1
MDA	Malondialdehyde
MET	Metabolic equivalent of Task
MetS	Metabolic syndrome
MF	Moderately Fit
MHC	Myosin heavy chain
MI	Myocardial infarction
MLC	Myosin light chain
MLCK	Myosin light chain kinase
MLCP	Myosin light chain phosphatase
MP	Mid puberty
MPO	Myeloperoxidase
mRNA	Messenger ribonucleic acid
MVPA	Moderate to vigorous physical activity

NAPDH	Nicotinamide adenine dinucleotide phosphate-oxidase
NO	Nitric oxide
Non HDL-C	Non high-density lipoprotein cholesterol
OR	Odd ratio
OUES	Oxygen uptake efficiency slope
oxLDL	Oxidized LDL-cholesterol
PA	Physical activity
PAD	Peripheral arterial disease
PAR-Q	Physical activity readiness questionnaire
PAT	Peripheral arterial tonometry
PG12	Prostacyclin
PIP2	Phosphatidylinositol 4.5-bisphosphate
PP	Pre-pubertal
PWV	Pulse wave velocity
RER	Respiratory exchange ratio
ROS	Reactive oxygen species
RPE	Rate of perceived exertion
SAA	Serum amyloid A
SBP	Systolic blood pressure
SDMA	Symmetric dimethylarginine
sec	Second

sICAM-1	Soluble intracellular adhesion molecule-1
SMC	Smooth muscle cell
SR _{AUC}	Shear rate area under the curve
SR _{peak}	Peak shear rate
sVCAM-1	Soluble vascular cell adhesion molecule-1
T1DM	Type 1 diabetes mellitus
T2DM	Type 2 diabetes mellitus
TC	Total cholesterol
TC: HDL-C	Total cholesterol HDL-cholesterol ratio
TG	Triglycerides
TNF- α	Tumor necrosis factor alpha
VA	Vascular aging
VAT	Ventilatory anaerobic threshold
VCO ₂	Carbon dioxide elimination
V _E	Minute Ventilation
V _E max	Maximum minute ventilation
$\dot{V}O_2$	Oxygen uptake
$\dot{V}O_{2max}$	Maximal oxygen uptake
$\dot{V}O_{2peak}$	Peak oxygen uptake
VPA	Vigorous physical activity
VSMC	Vascular smooth muscle cell contraction

VT	Ventilatory threshold
WHO	World health organisation
yr	Year
% $\dot{V}O_2$ max	Percentage of maximal oxygen uptake
% $\dot{V}O_2$ VT	Percentage of maximal oxygen uptake at ventilatory threshold
%VT	Percentage of maximal heart rate at ventilatory threshold
20MST	20 m multi-shuttle run test

Chapter I

INTRODUCTION

Rationale

Cardiovascular disease (CVD) is the leading cause of death among Europeans and is responsible for over 4 million deaths per year (Nichols et al., 2014). In 2014, close to 50% of all deaths in Europe were attributable to CVD (Nichols et al., 2014). Annually, 1.48 million deaths occur before the age of 75, equating to 37% of premature deaths (Nichols et al., 2014). Atherosclerosis, a slow progressive chronic, inflammatory, fibroproliferative disease involving large and medium-sized conduit arteries, is the primary underlying cause of CVD.

There is growing evidence that functional impairment of the endothelium, a physical barrier between the blood and tissues is one of the first recognizable signs of the development of atherosclerosis and is present prior to angiographic detection or clinical manifestations of CVD. Shear stress plays a central role in regulating endothelial cell function. High shear stress helps to maintain endothelium homeostasis by the up-regulation of endothelial derived nitric oxide synthase (eNOS) expression and subsequent increase in the synthesis and release of nitric oxide (NO) (Green et al., 2004). In contrast, a low shear stress environment can negatively alter endothelium homeostasis resulting in endothelial dysfunction. Although the underlying cause of endothelial dysfunction is multifactorial, a key factor is impairment of the bioavailability of NO (Deanfield et al., 2007).

Although the clinical manifestations of CVD occur in middle and late adulthood, the atherosclerotic process begins in childhood and is accelerated by exposure to established CVD risk factors and their persistence over time (Berenson et al., 1998). Non-invasive imaging techniques such as echo-Doppler measurement of carotid intima media thickness (cIMT) and flow-mediated dilation (FMD) of the brachial artery are now commonly used to identify sub-clinical atherosclerosis in asymptomatic children and adolescents (Berenson, 2002). Impaired brachial artery FMD and increased cIMT are present in obese children and adolescents with atherosclerotic cardiovascular disease (ACVD) risk factors (Meyer et al., 2006, Farpour-Lambert et al., 2009).

High levels of CRF are positively associated with a more favorable CVD risk factor profile in asymptomatic adolescents compared to their inactive, unfit counterparts (Ruiz et al., 2007, Ekelund et al., 2007, Anderssen et al., 2007). Both short and long-term exercise training has proved efficacious in improving CVD risk factor profile, restoring endothelial function, decreasing cIMT and improving CRF in overweight and obese children with ACVD risk factors (Watts et al., 2004, Meyer et al., 2006, Farpour-Lambert et al., 2009). Limited cross-sectional studies in children have found a positive relation between CRF and endothelial dependent dilation (EDD) (Hopkins et al., 2009, Treiber et al., 1997) and an inverse relation between CRF and cIMT (Silva et al., 2014). To date, no published studies have investigated the relation between objectively measured CRF and brachial artery FMD and cIMT in adolescents. The fact that CVD risk factors cluster in children and adolescents with low levels of

CRF and physical activity (PA) (Anderssen et al., 2007, Andersen et al., 2006) and track from childhood into adulthood (Juhola et al., 2011, Steinberger et al., 2001, Nicklas et al., 2002) indicates that a critical window of opportunity may exist for early risk identification and lifestyle intervention.

Maximal oxygen uptake ($\dot{V}O_{2max}$) is a measure of the integrated capacity of the pulmonary, cardiovascular and muscular systems to uptake, transport and utilize oxygen at maximal exercise (Poole et al., 2008) and is considered the gold standard measurement of CRF. Attainment of $\dot{V}O_{2max}$ requires a plateau in oxygen uptake, defined as an increase in $\dot{V}O_2 < 2.0 \text{ ml}\cdot\text{kg}^{-1}\cdot\text{min}^{-1}$ with increasing workload during the final minute (min) of a maximal exercise test (Rowland & Cunningham, 1992). The inability to achieve a plateau in $\dot{V}O_2$ during maximal exercise testing, particularly in overweight and obese pediatric populations has resulted in a number of secondary criterion being used to verify attainment of $\dot{V}O_{2max}$. These include respiratory exchange ratio (RER) > 1.0 , heart rate (HR) >200 bpm and volitional fatigue (RPE 18-20) (Breithaupt et al., 2012). Exercise performance at submaximal intensities may be better tolerated and more reflective of the intensity of ambulatory activities undertaken by adolescents (Akkerman et al., 2010). The oxygen uptake efficiency slope (OUES), derived from the linear relation between oxygen uptake and the logarithm of minute ventilation (\dot{V}_E) during incremental exercise has been proposed as an objective and effort independent submaximal measure of CRF (Baba et al., 1996). OUES is positively related to $\dot{V}O_{2max}$ in both healthy normal weight (Marinov et al., 2007) and obese children and adolescents (Breithaupt et al., 2012, Marinov et

al., 2003) and in children with congenital heart disease (Baba et al., 1996). In apparently healthy middle-aged adults, OUES is inversely associated with large artery stiffness (Arena et al., 2009). To date, no published studies have examined the relation between OUES and vascular health in children and adolescents.

Low levels of PA are independently associated with increased cardiometabolic disease risk factors in children and adolescents (Andersen et al., 2006, Ekelund et al., 2006, Ekelund et al., 2007) while findings from studies examining the independent relation between sedentary behaviour and cardiometabolic disease risk factors in this cohort have been equivocal (Tremblay et al., 2014). To date, the relation between both objectively measured PA and sedentary behaviour and sub-clinical atherosclerosis in adolescents is unknown. In the only study to examine objectively measured PA and vascular function in children, time spent in moderate to vigorous levels of physical activity (MVPA) was positively related to brachial artery FMD (Hopkins et al., 2009). A recent study found no relation between sedentary behaviour and brachial artery FMD in pre-pubertal children (Hopkins et al., 2012). Currently, 81% of Irish children and 88% of Irish adolescents do not meet the PA recommendations of 60 min of daily MVPA (Woods et al., 2010). In addition, it is estimated that European children aged 12-18 years spend on average 9 h per day or 71% of their waking hours in sedentary behaviours (Ruiz et al., 2011).

To date, no published studies have simultaneously evaluated the effect of CRF, PA and sedentary behaviour on sub-clinical atherosclerosis in adolescents. The purpose of the following series of studies was to determine the influence of CRF, PA

and sedentary behaviour on CVD risk factors and vascular health in apparently healthy male adolescents.

Study Aims

- 1.** To compare CVD risk factors, endothelial function and cIMT in LF, MF and HF healthy male adolescents and examine the relation between $\dot{V}O_2\text{max}$ and vascular health.
- 2.** To determine the value of the OUES as an objective measure of CRF in adolescents and to examine its relation with vascular health.
- 3.** To examine the influence of PA and sedentary behaviours on vascular health in healthy male adolescents and to compare PA and sedentary behaviours in LF, MF and HF healthy male adolescents.

Hypotheses

- 1.** LF adolescents will have a significantly poorer CVD risk factor profile and significantly greater sub-clinical atherosclerotic CVD than MF and HF adolescents and $\dot{V}O_2\text{max}$ will be positively related to vascular health.
- 2.** The OUES will be a suitable and valid objective measure of CRF in adolescents and will be positively related to vascular health.
- 3.** PA will be positively related to vascular health and sedentary behaviour will be inversely related to vascular health, PA behaviours will be significantly

lower and sedentary behaviours will be significantly higher in LF than MF and HF healthy male adolescents.

Chapter II

Chapter II

REVIEW OF LITERATURE

Cardiovascular Disease

Cardiovascular disease (CVD) collectively refers to diseases of the heart and the circulatory system and includes coronary artery disease (CAD), peripheral arterial disease (PAD), cerebrovascular disease, rheumatic heart disease, congenital heart disease, aortic aneurysm, pulmonary embolism and deep venous thrombosis. Approximately 17.5 million deaths worldwide were attributed to CVD in 2012 (WHO, 2015). It is estimated that by 2030 almost 23.6 million people will die annually from CVD (WHO, 2015). In Europe, over 4 million people die from CVD each year with an estimated cost of €192 billion per year (Nichols et al., 2012) In Ireland, a total of 6% of the healthcare budget in 2009 was spent on the treatment of CVD (McGee, 2010).

Blood Vessel Structure

Arterial blood vessels are comprised of three distinct layers called the intima, media and adventitia (figure 2.1). The intima contains endothelial cells that rest on a basement membrane. The media layer consists primarily of smooth muscle cells (SMC) and is bordered by the internal and external elastic lamina. The adventitia is the outermost layer of the blood vessel.

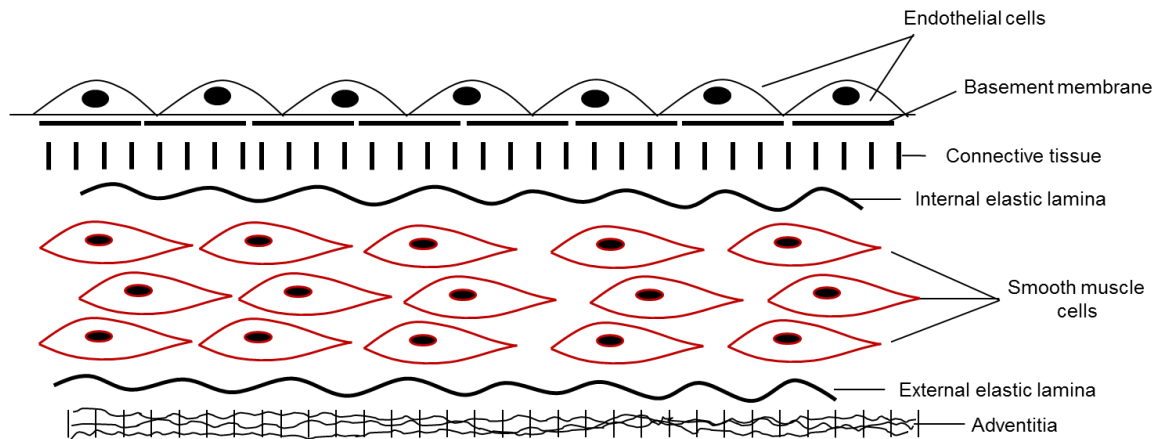

Figure 2.1. Structure of large and medium sized arteries

Pathophysiology of Atherosclerosis

Atherosclerosis, the most common cause of CVD, is a chronic inflammatory vascular disease occurs in response to alterations in lipid homeostasis and endothelial cell injury. The disease is characterized by progressive lipid accumulation and the proliferation of smooth muscle and connective tissue within the sub-endothelial space of primarily large, and medium sized systemic arteries (Libby et al., 2010). A long incubation period exists between the initial development of atherosclerosis and clinical manifestations.

Vascular endothelial cells are not only targets, but are also the effectors that actively participate in inflammatory processes associated with arteriosclerosis. Healthy endothelial cells are selectively permeable and are primarily antithrombotic, anti-inflammatory and antioxidant due in part, to their production and release of NO. High circulating levels of low density lipoprotein cholesterol (LDL-C) and their subsequent oxidation and accumulation in the subendothelial matrix has been

identified as a major triggering event in the initiation of atherosclerosis. LDL-C normally diffuses passively through endothelial cell junctions, and its retention in the vessel wall involves interactions between the LDL-C constituent Apo lipoprotein B (ApoB) and matrix proteins including proteoglycans and other intimal glycosaminoglycans (GAGs), which have a high affinity for Apo B. This entrapment increases the residence time of LDL-C in the artery and renders them more susceptible to oxidation.

Oxidized LDL-C (oxLDL) inhibits the production of NO and stimulates the overlying endothelial cells to produce endothelial leukocyte adhesion molecules (ELAMs), chemotactic proteins such as monocyte chemoattractant protein-1 (MCP-1), and growth factors such as macrophage colony-stimulating factor (M-CSF), resulting in the recruitment of monocytes to the vessel wall and their subsequent proliferation and differentiation into macrophages. Soluble vascular cell adhesion molecule-1 (sVCAM-1) is responsible for the recruitment of monocytes and T-lymphocyte by binding to its cognate ligand VLA4 on the leukocyte. Other adhesion molecules that play a role in the development of atherosclerosis include soluble intercellular adhesion molecule-1 (sICAM-1), P-selectin and E-selectin.

The monocytes and T-lymphocytes recruited to the sub-intima space are responsible for the progression of the atherosclerotic lesions and their subsequent complications. In response to stimulation by macrophage derived IL-1 and TNF- α endothelial cells increase their permeability, produce more adhesion molecules and become more thrombogenic. T-lymphocyte derived INF- γ stimulates macrophages

and SMC to express scavenger receptors that bind and internalise oxLDL resulting in the formation of lipid-rich arterial foam cells. These nascent atherosclerotic lesions are the precursor of more complex plaques. They are called foam cells because of the foamy appearance under the microscope, due accumulation of lipid droplets within the cytoplasm. Vascular smooth muscle cells lose their ability to contract and develop the capacity to proliferate, migrate and to synthesise and secrete extracellular matrix proteins (EMP). Over time, SMCs migrate to the sub-endothelial layer where they undergo mitosis and synthesise and release collagen to form a fibrous cap. Macrophages and lymphocytes may also be present in the fibrous cap.

Macrophages and SMC within foam cells become necrotic and rupture. Their fat content accumulates and a fibrotic lipid core, a site of chronic inflammation, is formed. Fibrous plaques eventually increase in size and undergo calcification to become advanced lesions. The dense fibrous cap may weaken overtime resulting in hemorrhage within the plaque and ultimately plaque rupture. Thrombosis may result in partial or full occlusion of the artery, the clinical consequence being myocardial ischemia, infarction or sudden death.

Origin of Atherosclerosis

Although the clinical manifestation of CVD occurs in middle and late adulthood, evidence of atherosclerotic disease is evident from autopsy studies in children and young adults (Enos et al., 1953, McNamara et al., 1971, McGill et al., 2000). The onset of atherosclerosis in childhood was first documented by Holman *et al.*, (1957) who reported that grossly visible fatty streaks were present in the aorta

and coronary arteries of US children after the ages of 3 and 10 years respectively, and that these lesions advanced to fibrous plaques by young adulthood (Holman, 1957). Stary *et al.*, (1989) found that 65% of 12 to 14 year old children had coronary artery lesions containing foam cells and lipid droplets, and an additional 8% had developed more advanced pre-atheroma or atheroma stage of atherosclerosis (Stary *et al.*, 1989). A nation-wide pathology study of atherosclerosis in Japanese youth found that fatty streaks were present in the aortas of 29% of children <1 year old and 3.1% in the coronary arteries of children aged between 1 and 9 years of age (Tanaka *et al.*, 1988).

The findings of pathology studies are consistent with the findings from *in-vivo* studies examining atherosclerosis in youth (Berenson, 2002, Goar *et al.*, 1992 , Morrison *et al.*, 2010, Tuzcu *et al.*, 2001). An intravascular ultrasound study on the characterization of atherosclerosis in young heart transplant recipients found that coronary artery plaques >0.5 mm were present in 17% of 262 asymptomatic heart donors under the age of 20 years (Tuzcu *et al.*, 2001). More recently, studies using non-invasive ultrasonography to evaluate atherosclerotic plaque development, have found increased intima media thickness (IMT) of the carotid arteries of both children and young adults (Berenson, 2002, Morrison *et al.*, 2010).

Cardiovascular Disease Risk Factors

Epidemiological studies in adults have identified a number of individual characteristics known as risk factors that predict the probability of an individual developing clinical manifestations of CVD (Dawber *et al.*, 1950). These risk factors are

commonly classified as modifiable and non-modifiable. Non-modifiable risk factors include age, race, gender and family history. Hypertension, smoking, low levels of high density lipoprotein cholesterol (HDL-C), high levels of LDL-C, glucose intolerance, obesity and a sedentary lifestyle are the most common modifiable risk factors. More recently, elevated levels of high sensitivity serum C-reactive protein (hsCRP), interleukin 6 (IL-6) and TNF- α have been associated with the development of CVD.

Risk factors for CVD track from childhood into adulthood (Juhola et al. 2011, Laurer et al., 1989, Steinberger et al. 2001) and are strong predictors of sub-clinical atherosclerosis in early adulthood (Davis et al., 2001, Li et al., 2003; Raitakari et al., 2003). The extent of sub-clinical atherosclerosis increases as the number of childhood risk factors increase (Berenson, 2002, Raitakari et al., 2003). The American Heart Association (AHA) guidelines for the primary prevention of ACVD in children and adolescents encourage the screening of modifiable risk factors to identify those at high risk for future CVD (Kavey et al., 2003).

Risk Factors and Early Atherosclerosis

Large prospective observational studies examining the relation between childhood CVD risk factors and the development of early atherosclerosis found a strong association between both antemortem and postmortem CVD risk factors and atherosclerotic changes in the aorta and coronary arteries of young individuals. The Bogalusa Heart Study, a long-term epidemiological study of CVD risk factors in individuals from 2 to 38 years of age, examined the relation between antemortem risk factors and the development of aortic and coronary atherosclerosis in 204 young

individuals who died from accidental causes (Berenson et al., 1998). Almost 100% of children between the age of 2 and 15 years had evidence of fatty streaks in the aorta on gross examination. Coronary fatty streaks were present in 50% of children between 2 and 15 years and increased to 85% between 21 and 39 years of age. The prevalence of raised fibrous plaque in the aorta increased with age, particularly after 15 years, and was evident in 60% of study participants between the age of 26 and 39 years. Similarly, the prevalence of raised fibrous plaque in the coronary arteries increased from 8% in children under-15 years to 69% in 26 to 39 years old adults. There was a significant relation between the prevalence and extent of atherosclerotic lesions in the aorta and coronary arteries and systolic blood pressure (SBP), diastolic (DBP), body mass index (BMI) total cholesterol (TC), LDL-C and triglycerides (TG).

The Pathological Determinants of Atherosclerosis in Youth (PDAY) study investigated the relation between postmortem risk factors and the extent of flat fatty streaks, raised fatty streaks and raised lesions in the aorta and right coronary artery of individuals between the age of 15 and 34 years who died of non-cardiovascular causes (McGill et al., 2000). Raised fatty streaks were detected in the abdominal aorta in 20% of 15 to 19 year old adolescents and increased to 40% between the age of 30 and 34 years. The presence of raised fatty streaks was 10% and 30% in the same two age cohorts. The percentage of intimal surface involvement of raised fatty streaks was positively associated with hypertension, obesity, impaired glucose tolerance, high levels of non-HDL-C and low HDL-C (McGill et al., 2000).

Clustering of CVD Risk Factors

Individual CVD risk factors correlate with each other and the co-existence of multiple risk factors in an individual is known as clustering (Berenson, 2002). Clustering of CVD risk factors is associated with the presence of early atherosclerotic lesions in adolescents and young adults. Berenson (2002) found a curvilinear relation between the severity of atherosclerotic disease in children and the number of CVD risk factors (Berenson, 2002). Autopsy and antemortem risk factor data on asymptomatic individuals aged between 2 and 39 years who died from non-cardiovascular events, indicate a significant relation between the number of CVD risk factors and the presence and extent of atherosclerotic lesions in the aorta and coronary arteries. The extent of fatty streaks and fibrous plaque in the coronary arteries was 8.5 and 12 times higher in individuals with greater than 4 CVD risk factors than those with no risk factors. IMT of the common carotid artery (CCA), carotid bulb and internal carotid artery is also related to the number of CVD risk factors in young asymptomatic adults between the age of 20 and 38 years (Berenson 2002).

Tracking of CVD Risk factors

The progression and increasing severity of atherosclerosis is not only associated with the presence and extent of CVD risk factors but also their persistence over time (Berenson et al., 1998). CVD risk factor levels for an individual tend to persist or track over time in a given rank within the distribution of the population (Berenson & Srivivasan, 2005). Elevated blood pressure (BP), TC, HDL-C, ratio

(TC:HDL-C), plasma insulin, and BMI have been found to track from childhood to adulthood (Laurer and Clarke, 1988, Laurer et al., 1989, Juhola et al., 2011, Nicklas et al., 2002, Steinberger et al., 2001).

Multiple risk factors tend to track better than individual risk factors (Nicklas et al., 2002) and the tracking of multiple risk factors is stronger with advancing age (Juhola et al., 2011). Nicklas *et al.*, (2002) tracked TC: HDL-C, SBP and insulin from childhood to adulthood over a 14 to 20 year period and found a significant association between the composite risk index score of the 3 risk factors between year 1 and year 8. The association was weaker when the risk factors were analyzed individually (Nicklas et al., 2002).

Childhood Risk factors and Subclinical Atherosclerosis in Adulthood

Epidemiological studies utilizing non-invasive imaging have found that childhood CVD risk factors, in particular elevated LDL-C and BMI, contribute to the development of sub-clinical atherosclerosis in young adults (Davis et al., 2001, Li et al., 2003, Raitakari et al., 2003). Risk factor measurements obtained during childhood are stronger predictors of pre-clinical atherosclerosis than measurements obtained during young adulthood. Raitakari *et al.*, (2003) examined the relation between CVD risk factors measured at 3 and 18 years of age and between 24 and 39 years (Raitakari et al., 2003). Adult cIMT was significantly associated with childhood LDL-C, SBP, BMI and smoking. The number of risk factors including elevated levels of LDL-C, SBP, BMI and cigarette smoking measured in 12-18 year old adolescents was

significantly related to cIMT measured between the ages of 33 and 39 years and remained significant, after adjusting for the number of adult risk factors.

The extent of pre-clinical atherosclerosis increases as the number of childhood CVD risk factors increase. While controlling for current CVD risk factors, Juonala *et al.*, (2010) found that there was a significant relation between the number of childhood risk factors and the 6 year change in adult cIMT (Juonala *et al.*, 2010). A recent analysis of 4380 participants in 4 longitudinal cohort studies found that risk factor measurements (high [highest quintile] TC, TG, BP and BMI) obtained at, or after 9 years of age are predictive of sub-clinical atherosclerosis in adulthood. In addition, the extent of pre-clinical atherosclerosis increased as the number of childhood risk factors increased (Juonala *et al.*, 2010).

Until recently, information on the role of CVD risk factors in the development of sub-clinical atherosclerosis was limited to observations from pathological studies and risk factor profiles. While a profile of CVD risk factors is useful in predicting cardiovascular events, measurement of functional and structural markers of sub-clinical atherosclerosis by non-invasive imaging techniques such as echo-Doppler studies of the carotid arteries or FMD of the brachial artery provides a powerful approach to determine the extent and severity of asymptomatic disease, and potential future risk in young populations (Berenson, 2002).

Vascular Biology

Endothelial Function

Vascular Endothelium – Structure

The vascular endothelium is a 0.2 to 4.0 μm -thick monolayer of squamous endothelial cells that line the entire vasculature and form a permeable biological interface between circulating blood elements and the various systems in the body. Once viewed as an inert barrier between the blood and tissues, the endothelium is now recognized as a key regulator of vascular homeostasis by acting as an active signal transducer for circulating influences that modify the vessel wall phenotype (Deanfield et al., 2007). It plays an important role in regulating vascular tone, smooth muscle cell (SMC) proliferation, inflammation, haemostasis, platelet aggregation and thrombus formation. A normal healthy endothelium maintains vascular haemostasis by synthesizing and releasing an array of biological substances in response to various physical, chemical and mechanical stimuli (Vita, 2011). Due to its location, the endothelium is subject to injury from mechanical forces and processes related to CVD risk factors.

Vascular Smooth Muscle Contraction

The primary role of vascular smooth muscle is to regulate blood vessel tone. Vascular smooth muscle contraction (VSMC) is regulated by the phosphorylation/dephosphorylation of the 20-kDa myosin light chain (MLC). MLC is phosphorylated by the Ca^{2+} -calmodulin-activated myosin chain light kinase (MLCK)

and dephosphorylated by the Ca^{2+} independent myosin light chain phosphatase (MLCP) (Sauzeau et al., 2000). Increases in cytosolic $[\text{Ca}^{2+}]$ induced by either electromechanical coupling or pharmacomechanical coupling mechanisms result in MLCK activation and consequent phosphorylation of MLC. Cytosolic $[\text{Ca}^{2+}]$ is increased by an influx of Ca^{2+} from the extracellular space through both voltage and receptor operated Ca^{2+} channels or by the controlled release of Ca^{2+} from intracellular storage sites.

Binding of agonists such as norepinephrine, angiotensin II and endothelin to the Gq protein linked receptor, increases cytosolic $[\text{Ca}^{2+}]$ through opening of Ca^{2+} surface membrane operated channels or the stimulation of phospholipase C. Phospholipase C catalyzes the hydrolysis of phosphatidylinositol 4,5-bisphosphate to inositol 1, 4, 5-triphosphate (IP_3) and diacylglycerol (DAG). The binding of IP_3 to its specific receptor on the sarcoplasmic reticulum results in the controlled release of Ca^{2+} into the cytosol (Webb, 2003). Cytosolic Ca^{2+} binds with calmodulin forming a calcium-calmodulin complex, which activates MLCK. MLCK phosphorylates MLC in the presence of ATP resulting in cross-bridge formation between myosin head and actin filaments and subsequent VSMC.

In addition to the Ca^{2+} dependent activation of MLCK, MLC phosphorylation is further regulated by changes in the sensitivity of the contractile apparatus to $[\text{Ca}^{2+}]$ (Sauzeau et al., 2000). MLCP removes the high-energy phosphate from the myosin light chain, resulting in vascular smooth muscle relaxation (Webb, 2003). Increased Ca^{2+} sensitivity of the contractile apparatus inhibits the activity of MLCP by Rho-

kinase, allowing increased MLC phosphorylation and tension at a constant Ca^{2+} concentration (Sauzeau et al., 2000).

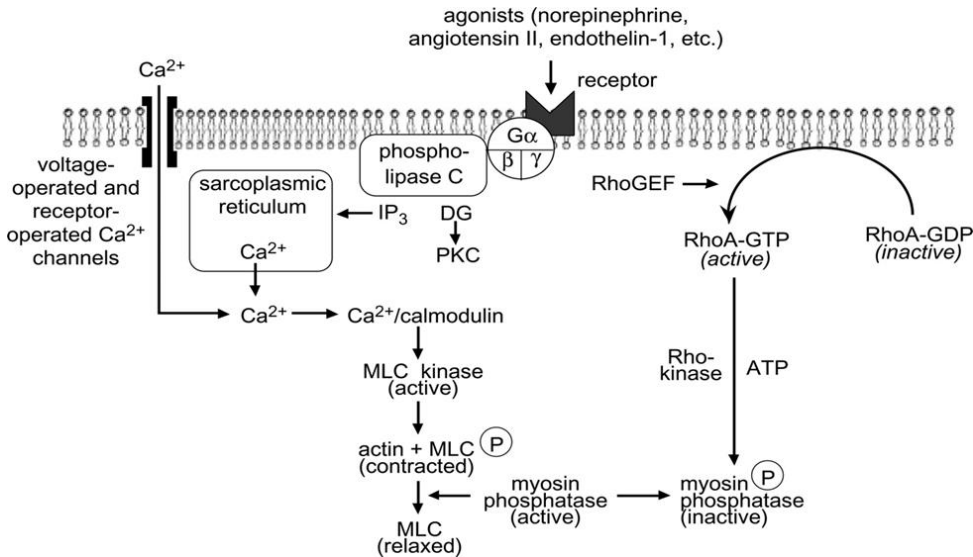

Figure 2.2: Vascular smooth muscle contraction

P₃, inositol 1,4,5-triphosphate; DAG, diacylglycerol; Ca²⁺, calcium; MLC, myosin light chain; P, phosphate; ATP, Adenosine Triphosphate. An increase in free intracellular [Ca²⁺] can result from increased flux of [Ca²⁺] into the cell through calcium channels or by the release of [Ca²⁺] from internal stores (e.g., SR). The cytosolic [Ca²⁺] binds to a calcium-binding protein called calmodulin. Calcium-calmodulin activates MLCK, an enzyme that phosphorylates MLC in the presence of ATP. MLC phosphorylation leads to cross-bridge formation between the myosin heads and the actin filaments resulting in smooth muscle contraction. Increased Ca²⁺ sensitivity of the contractile apparatus inhibits the activity of MLC phosphatase by Rho-kinase, allowing increased MLC phosphorylation and tension at a constant Ca²⁺ concentration (Diagram as in Webb 2003)

Vascular Smooth Muscle Relaxation

Vascular smooth muscle cell relaxation occurs as a result of a decrease in cytosolic [Ca²⁺] and/or an increase in MLCP activity (Sauzeau et al.,2000). During relaxation, receptor and voltage-operated calcium channels in the vascular smooth muscle plasma membrane close, resulting in a reduced Ca²⁺ entry into the cell. Calcium is also re-sequestered to the sarcoplasmic reticulum by Ca²⁺,Mg²⁺-ATPases or removed from the cell by Ca²⁺Mg²⁺-ATPases and Na⁺/Ca²⁺ exchangers in the plasma membrane (Webb, 2003).

The vascular endothelium also assists in the regulation of SMC relaxation by synthesizing and releasing vasoactive substances in response to mechanical or humoral stimuli. Furchgott and Zawadzki (1980) first demonstrated that a healthy intact endothelium was necessary to induce vascular smooth muscle cell relaxation in isolated rabbit aorta in response to acetylcholine (ACh) (Furchgott & Zawadzki, 1980). The endothelium-dependent response to exogenously administered ACh was attributable to the production and diffusion of the hydrophobic, diatomic gas NO, produced by the enzyme eNOS in response to changes in shear forces or binding of a variety of endothelial cell receptor agonists.

Shear stress, the force exerted by blood flow on vascular endothelial cells (Davies et al., 2005) increases NO production by the phosphorylation of eNOS. In particular, shear stress activates specialized Ca^{2+} -activated K^+ channels on the endothelial surface resulting in K^+ efflux and Ca^{2+} influx (Sandoo et al., 2010). Cytosolic Ca^{2+} attaches to calmodulin, which activates eNOS resulting in the synthesis of NO from L-arginine. Once synthesized, NO diffuses across the endothelium into the adjacent vascular smooth muscle where it binds and activates guanylyl cyclase resulting in the conversion of guanosine triphosphate (GTP) to cyclic guanosine monophosphate (cGMP). cGMP inhibits calcium influx into the smooth muscle cell and decreases calcium-calmodulin stimulation of MLCK, which in turn decreases phosphorylation of MLC resulting in a reduction in smooth muscle tension development and inducing vasodilation.

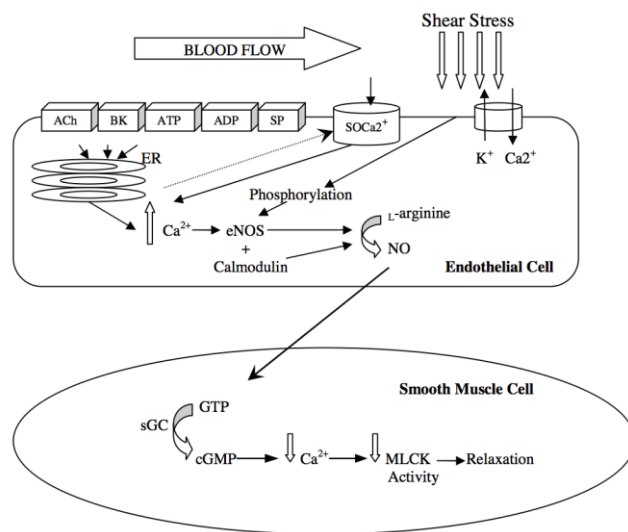

Figure 2.3: Vascular smooth muscle relaxation

ACh=acetylcholine; BK, bradykinin; ATP, adenosine triphosphate; ADP, adenosine diphosphate; SP, substance P; Ca^{2+} , calcium; K^+ , potassium; $SOCa^{2+}$, store-operated calcium channel; ER, endoplasmic reticulum; eNOS, endothelial derived nitric oxide synthase; L-arg, L-arginine; NO, nitric oxide; GC, guanylyl cyclase; GTP, guanosine triphosphate; cGMP, cyclic guanosine monophosphate; MLCK, myosin light chain kinase. Increases in hemodynamic shear result in $[Ca^{2+}]$ efflux from the endoplasmic reticulum into the cytoplasm. $[Ca^{2+}]$ binds to calmodulin and activates eNOS resulting in the synthesis of NO from, L-arginine. The NO molecule diffuses abluminally into the adjacent vascular smooth muscle, where it binds GC, leading to activation of the enzyme, and the production of cGMP. This intercellular signaling molecule leads to the inhibition of $[Ca^{2+}]$ influx into the smooth muscle cell, and decreases calcium-calmodulin stimulation of MLCK. This in turn decreases the phosphorylation of MLC, decreasing smooth muscle tension development and causing vasodilation. In addition, when Ca^{2+} stores of the ER are depleted a signal is sent to the $SOCa^{2+}$ channel which allows extracellular Ca^{2+} into the endothelial cell. (Diagram as in Sandoo *et al.*, 2010)

Vascular Endothelial Dysfunction

Impairment to the normal function of the vascular endothelium is termed endothelial dysfunction and represents one of the earliest events in the pathogenesis of atherosclerosis (Anderson *et al.*, 1995). Endothelial dysfunction is related to CVD progression (Halcox *et al.*, 2002) and is predictive of CV events (Suwaidi *et al.*, 2000, Halcox *et al.*, 2002). A key manifestation of endothelial dysfunction is a reduction in the bioavailability of vasodilators, most notably NO, resulting in impaired EDD

(Flammer et al., 2012). Endothelial dysfunction is also characterized by proliferative, pro-inflammatory and pro-coagulant states that favour all stages of atherogenesis (Anderson, 1999).

An alteration in the redox balance in endothelial cells leads to increased superoxide anion production and oxidative stress that degrades NO (Kofler et al., 2005). This can occur by three distinct mechanisms. Firstly, superoxide can react with NO to form peroxynitrite anions resulting in consumption of NO and loss of its activity. Secondly, reactive oxygen species (ROS) increase the concentration of asymmetric dimethylaminohydroxylase (ADAMA) an endogenous inhibitor of eNOS and finally, superoxide anions can result in uncoupling of eNOS due to degradation of tetrahydrobiopterin (BH₄).

Assessment of Endothelial Function

Quantitative coronary angiography, venous occlusion plethysmography, and a cold pressor test are invasive tests that are commonly used to assess endothelial function. Quantitative coronary angiography measures the vasomotor response to intracoronary administration of Ach or other endothelial dependent agonists such as bradykinin and substance P (Halcox et al., 2002). Venous occlusion plethysmography involves measuring changes in forearm resistance and blood flow following the infusion of endothelial dependent and endothelial independent dilators such as ACh and sodium nitroprusside, respectively (Spieker et al., 2002). The cold pressor test is used to assess endothelial dependent coronary vasomotor function. Submersion of an extremity in ice water for 90 sec induces sympathetic stimulation and subsequent

EDD, which is measured using quantitative angiography (Zeicher et al., 1991). The invasive nature of these methods limits their widespread use to assess endothelial function in children and adolescents.

Advances in non-invasive techniques, in particular ultrasound imaging, has allowed for the assessment of endothelial function in asymptomatic children and adolescents with or without CVD risk factors (Järvisalo & Raitakari, 2005). The most commonly used non-invasive techniques for assessing endothelial function in children and adolescents are brachial artery FMD and peripheral arterial tonometry.

Brachial Artery Flow Mediated Dilation (FMD)

Flow mediated dilation (FMD) of the brachial artery is the most widely used non-invasive technique to measure endothelial function in both adults and children. High-resolution ultrasonography is used to measure brachial artery blood flow velocity and vessel diameter at rest and in response to reactive hyperemia following a brief period of arterial occlusion. The change in artery diameter is normally expressed as a percentage change from baseline diameter. Shear stress induced brachial artery FMD is believed to occur in response to an increased release of endothelial derived NO. Brachial artery FMD can be used as a surrogate for coronary artery function due to the similarity in vasomotor response of both the coronary arteries to pharmacological agents and the brachial artery to hemodynamic shear stress (Anderson et al., 1995, Takase et al., 1998). Brachial artery FMD is related to the extent and severity of coronary atherosclerosis (Neunteufl et al., 1997) and is an independent predictor of CV events in adults (Gokce et al., 2003).

Pharmacological agents such as glyceryl-trinitrate (GTN) cause vasodilation by acting directly on vascular smooth muscle cell and are therefore commonly used to assess endothelial-independent dilation (EID). Measuring EID serves as a control for FMD measurement to ensure that low percentage change in FMD is as a result of impaired endothelial function and not a reflection of underlying smooth muscle dysfunction (Järvisalo & Raitakari, 2005). Relatively few studies have measured EID in children due to the potential side effect of GTN.

Peripheral Arterial Tonometry

The measurement of endothelial function in children and adolescents using peripheral arterial tonometry (PAT) has recently grown in popularity (Mahmud et al., 2009, Metzsig et al., 2011, Tryggestad et al., 2012). PAT measures microvascular endothelial function. It involves the measurement of pulsatile arterial volume changes by finger plethysmography (Flammer et al., 2012). Probes are placed on one fingertip on both hands and are subsequently inflated to produce a sub-diastolic counter-pressure equal to approximately 70 mm Hg. Pressure differences secondary to dilating arterioles in the fingers are measured. Similar to brachial artery FMD, a pressure cuff is placed on the arm. The BP cuff is inflated above SBP and deflated after 5 min to induce reactive hyperemia (Flammer et al., 2012). The reactive hyperemia index defined as the ratio of the mean pulse amplitude between 90 and 150 sec after deflation divided by a pre-occlusion period 210 sec before occlusion is calculated. This ratio is then divided by the same ratio for the control arm and multiplied by a baseline correction factor. In contrast to FMD, the response is only

partially mediated by NO (Bruyndonckx et al., 2013). Other mediators that contribute to vasodilation include prostacyclin (PGI₂) and endothelial derived hyperpolarizing factor (Bruyndonckx et al., 2013).

Normative Brachial Artery FMD Values

FMD responses vary considerably between studies primarily due to different populations, location of measurement, duration of occlusion and other technical aspects related to measurement (Bots et al., 2005). An analysis of 16,680 individuals from 412 study groups found that mean FMD response varied from 0.20 to 19.2% in healthy populations, -1.3% to 14.0 % in coronary heart disease (CHD) populations and 0.75 to 12.0% in individuals with type 1 diabetes mellitus (T1DM) (Bots et al., 2005).

A number of studies have found no change in endothelial function in healthy asymptomatic children throughout childhood (Kaufman et al., 2007, Tounian et al., 2001, Woo et al., 2004, Meyer et al., 2006). Mean FMD response in healthy non-obese children and adolescents is typically 8% to 11% (Järvisalo et al., 2002, Järvisalo et al., 2004, Woo et al., 2004). However, large variability exists between studies (Fernhall & Agiovlasitis, 2008).

Limited population based studies involving children, differences in technical aspects relating to FMD measurement between studies and a large range of FMD values makes it challenging to define abnormal FMD responses in children (Fernhall & Agiovlasitis, 2008). Jarvisalo *et al.*, reported a mean FMD response of 8.7% in healthy asymptomatic 11 year old children (Järvisalo et al., 2004) and 7.7% in healthy children

between the age of 9 and 16 years (Järvisalo et al., 2002). Similarly, Celermajer *et al.*, (1992) reported a mean percentage change in FMD of 8.0% in healthy 8 to 16 year old children and adolescents (Celermajer et al., 1992). Woo *et al.*, (2004) measured brachial artery FMD in 36 non-obese healthy children and reported a mean FMD response of 9.7% (Woo et al., 2004).

The majority of pediatric studies investigating endothelial function in children and adolescents report FMD as being reduced or impaired, with relatively few studies defining what percentage change in FMD response constitutes impairment. Impaired FMD response has been pre-defined in healthy and disease-based adult populations as a peak FMD response of $\leq 8\%$ from baseline (Kitta et al., 2009, Corretti et al., 2002, Gokce et al., 2003) with some studies, particularly in patients with CAD, defining impaired FMD as $< 5.5\%$ (Kitta et al., 2009). Meyer *et al.*, (2006) defined impaired FMD as $< 5.5\%$ in obese children (Meyer et al., 2006) while others used a value $> 3.3\%$ in children with T1DM (Järvisalo et al., 2004) based on the bottom 10th percentile for healthy 9 to 16 year olds (Järvisalo et al., 2002).

Endothelial Function and Puberty

Measurement of endothelial function in children and adolescents can be confounded by anthropometric and physiological changes that occur with puberty (Bruyndonckx et al., 2013). During puberty, there is an increase in the circulating levels of the steroid hormones, estrogen and dehydroepiandrosterone sulphate (DHEAS) (Bhangoo et al., 2011). Both of these hormones bind to their specific receptors on the vascular endothelium and upregulate eNOS concentration and

activity, resulting in an increase in NO and subsequent enhanced EDD (Duckles & Miller 2010). Bhangoo *et al.*, (2011) found that endothelial derived NO mediated vasodilation, measured by PAT was significantly higher in children who were at mid (Tanner II-III) and late stages of puberty (Tanner IV-V) than pre-pubertal children (Tanner 1) (Bhangoo *et al.*, 2011). Endothelial derived NO mediated vasodilation was significantly correlated with estrogen, DHEAS and age (Bhangoo *et al.*, 2011). In contrast, a recent large cross-sectional study examining the effect of pubertal development on EDD found no difference in the percentage change in brachial artery FMD across the pubertal Tanner stages (Marlatt *et al.*, 2013). The equivocal findings may be related to the inherent differences between large conduit and small arteries.

Endothelial Function and CVD Risk Factors in Children

Impaired endothelial function is present in children and adolescents with ACVD risk factors including overweight (Woo *et al.*, 2004), obesity (Meyer *et al.*, 2006, Kapiotis *et al.*, 2006, Zhu *et al.*, 2005, Yilmazer *et al.*, 2010, Peña *et al.*, 2006, Tounian *et al.*, 2001, Aggoun *et al.*, 2008, Farpour-Lambert *et al.*, 2009), T1DM (Järvisalo *et al.*, 2004, Singh *et al.*, 2003, Wiltshire *et al.*, 2002, Babar *et al.*, 2011, Glowinska-Olszewska *et al.*, 2013), T2DM (Naylor *et al.*, 2011) and familial hypercholesterolemia (FH) (Celermajer *et al.*, 1992, de Jongh *et al.*, 2002, Vlahos *et al.*, 2014, Sorensen *et al.*, 1994).

Childhood obesity, a key independent risk factor for CVD is associated with impaired endothelial function and greater arterial stiffness from as early as the first decade of life (Singhal, 2005). The effect of obesity on vascular function is partly

mediated by the prolonged exposure of arteries to high circulating insulin levels and adipokines (Singhal, 2005). Several cross-sectional studies (Table 2.1) have found that obese children and adolescents have lower FMD compared to their healthy normal weight counterparts (Meyer et al., 2006, Kapiotis et al., 2006, Zhu et al., 2005, Yilmazer et al., 2010, Peña et al., 2006, Tounian et al., 2001, Aggoun et al., 2008, Farpour-Lambert et al., 2009). A number of these studies have found a strong association between the percentage change in FMD and BMI (Zhu et al., 2005, Yilmazer et al., 2010, Peña et al., 2006, Woo et al., 2004, Aggoun et al., 2008), weight (Peña et al., 2006), waist circumference (Yilmazer et al., 2010), body fat (Aggoun et al., 2008), TC (Zhu et al., 2005), LDL-C (Zhu et al., 2005), Apo-B (Zhu et al., 2005), BP, (Aggoun et al., 2008), apolipoprotein A1 (ApoA1) (Tounian et al., 2001) and fasting insulin concentration (Tounian et al., 2001).

Some studies have found that both EDD and EID were lower in obese than lean children (Tounian et al., 2001, Peña et al., 2006, Aggoun et al., 2008, Farpour-Lambert et al., 2009), whereas others have reported no difference in the percentage change in EID between these two groups (Woo et al., 2004, Karpoff et al., 2009). The impaired EID may be due to functional changes in vascular smooth muscle cells in response to obesity such as decreased activity of intracellular guanylyl cyclase, cyclic GMP or calcium dependent relaxation or accelerated inactivation of NO by increased oxidative stress. In these studies, BMI (Peña et al., 2006, Aggoun et al., 2008), weight (Peña et al., 2006), body fat (Aggoun et al., 2008) and BP (Aggoun et al., 2008) were inversely associated with the percentage change in EID.

Table 2.1. Cross-sectional studies comparing EDD and EID responses in overweight/obese and healthy children and adolescents

Author (y)	Age (y)	Cohort	%FMD	%GTN
Tounian <i>et al.</i> , (2001)	Obese 12.6 /Healthy 12.0	Obese (n=42)/Healthy (n=21) matched for age and puberty	sig ↓ in obese vs. healthy (5.0 vs. 9.0%)	sig ↓ in obese vs. healthy (15.6 vs. 23.0%)
Woo <i>et al.</i> , (2004)	10.3 ± 0.9	OW (n=36)/Healthy (n=36) matched for age and gender	sig ↓ in obese vs. healthy (6.6 vs. 9.7%)	↔ in obese vs. healthy (19.6 vs. 20.6 %)
Zhu <i>et al.</i> , (2005)	12.0 (7-12)	Obese (n=43)/Healthy (n=28) matched for age	sig ↓ in obese vs. healthy (10.9 vs. 18.8%)	—
Kapiotis <i>et al.</i> , (2006)	Obese 12.0 ± 2.9/Healthy 12.0 ± 5.0	Obese (n=77)/Healthy (n=15) matched for age	sig ↓ in obese vs. healthy (7.7 vs. 11.1%)	—
Meyer <i>et al.</i> , (2006)	Obese 13.7/Healthy 14.7	Obese (n=32)/Healthy (n=20) matched for age	sig ↓ in obese vs. healthy (5.8 vs. 9.3 %)	—
Meyer <i>et al.</i> , (2006b)	Obese 14.2 ± 1.9 /Healthy 14.7 ± 2.2	Obese (n=67)/Healthy (n=35) matched for age	sig ↓ in obese vs. healthy (4.1 vs. 10.7%)	—
Pena <i>et al.</i> , (2006)	Obese 13.3/Healthy 14.1	Obese (n=58)/non-obese (n=53)/T1DM (n=159) All matched for age	sig ↓ in obese/T1DM vs. healthy (4.9 /3.8 vs.7.8%)	sig ↓ in obese/T1DM vs. healthy (21.7 /20.5 vs. 27.7%)
Aggoun <i>et al.</i> , (2008)	Obese 8.9 ± 1.5/Healthy 8.3 ± 1.5	Obese (n=48)/Healthy (n=23) matched for age	sig ↓ in obese/T1DM vs. healthy (4.5 vs. 8.3 %)	sig ↓ in obese vs. healthy (19.0 vs. 25.8 %) ↔ in obese vs. healthy
Karpoff <i>et al.</i> , (2009)	11.6 ± 0.6	Obese (n=12)/Healthy (n=13) matched for age and PA levels	sig ↓ in obese vs. healthy (4.6 vs. 8.8 %)	(17.4 vs. 20.4%)

Author (y)	Age (y)	Cohort	%FMD	%GTN
Yilmazer <i>et al.</i> , (2010)	Obese 11.5/Healthy 9.8 (7-16)	Obese (n=77)/Healthy (n=40) matched for age	sig↓ in obese vs. healthy (9.7 vs. 14.8%)	—
Farpour-Lambert <i>et al.</i> , (2009)	8.9 ± 0.5	Obese (n=44)/Healthy (n=22) matched for age	sig↓ in obese vs. healthy (4.1 vs. 7.8%)	sig ↓ in obese vs. healthy (17.1 vs. 25.0%)

%FMD, percent change in diameter following flow mediated dilation; %GTN, percent change in diameter following glyceryl trinitrate mediated dilation; sig, significant

Cross-sectional studies have found that FMD is significantly lower in children with T1DM and T2DM than healthy controls (Table 2.2) (Järvisalo et al., 2004, Singh et al., 2003, Wiltshire et al., 2002, Głowińska-Olszewska et al., 2013, Babar et al., 2011, Naylor et al., 2011). Järvisalo *et al.*, (2004) reported that 36% of children with T1DM had endothelial dysfunction defined as a peak FMD of $\leq 3.3\%$ (Järvisalo et al., 2004) below the 10th percentile cutoff for healthy children aged 9-16 years (Järvisalo et al., 2002). Among the CVD risk factors measured in these studies, blood glucose (Singh et al., 2003) duration of diabetes (Singh et al., 2003), TC (Singh et al., 2003) LDL-C (Singh et al., 2003) and circulating levels of endothelial progenitor cells (CD34, CD309) (Glowinska-Olszewska et al., 2013) and glycated hemoglobin (HBA1c) (Babar et al., 2011) were inversely associated with percentage change in FMD. In each of the studies, there was no difference in EID between children with T1DM and healthy controls (Järvisalo et al., 2004, Singh et al., 2003, Glowinska-Olszewska et al., 2013, Babar et al., 2011).

Naylor *et al.*, (2011) compared brachial artery FMD responses in adolescents with T2DM, obese non-insulin resistant adolescents, and healthy lean controls. FMD was significantly decreased in adolescents with T2DM than lean healthy controls. Although FMD in the obese non-insulin resistant group was intermediate between T2DM and lean healthy controls subjects, there was no significant difference between the obese and T2DM group (Naylor et al., 2011).

Table 2.2. Cross sectional studies comparing EDD and EID responses in children and adolescents with T1DM and T2DM and healthy children and adolescents

Author (y)	Cohort	Age (y)	%FMD	%GTN%
Jarvisalo <i>et al.</i> , (2004)	T1DM (n=45)/healthy (n=30) matched for age	11 ± 2	sig↓ in T1DM vs. healthy (4.4 vs. 8.7 %)	↔ in T1DM vs. healthy (9.7 ± 5.0 vs. 11.5 ± 4.5%)
Babar <i>et al.</i> , (2011)	T1DM (n=21)/healthy siblings (n=15) matched for age	8.3 ± 0.3 (T1DM) 7.6 ± 0.3 (healthy siblings)	sig↓ in T1DM vs. healthy (7.1 vs. 9.8 %)	—
Singh <i>et al.</i> , (2003)	T1DM (n=31)/healthy (n=35) matched for age	15.0 ± 2.4 (T1DM) 15.7 ± 2.7 (healthy)	sig↓ in T1DM vs. healthy (4.2 vs. 8.2 %)	↔ in T1DM vs. healthy (17 vs. 18 %)
Glowinska-Olszewska <i>et al.</i> , (2013)	T1DM (n=52)/healthy (n=36) matched for age	14.5	sig↓ in T1DM vs. healthy (6.9 vs. 10.5%)	—
Wiltshire <i>et al.</i> , (2002)	T1DM (n=36)/healthy (n=20) matched for age and gender	13.7 ± 2.3	sig↓ in T1DM vs. healthy (5.2 vs. 9.1%)	↔ in T1DM vs. healthy (19.5 vs. 23.3 %)
Naylor <i>et al.</i> , (2011)	T2DM (n=15)/Healthy (n=13) matched for age	14	sig↓ in T2DM vs. healthy (8.0 vs. 10.4%)	—

T1DM, type 1 diabetes mellitus; T2DM, type 2 diabetes mellitus; %FMD, percent change in diameter following flow mediated dilation; %GTN, percent change in diameter following glyceryl trinitrate mediated dilation; sig, significant

Impaired endothelial function has been found in children as young as 7 years with FH (Table 2.3) (Sorensen et al., 1994). In the first published study to examine endothelial function in children using non-invasive ultrasound, Celermajer *et al.*, (1992) measured brachial artery FMD in children with FH between the age of 8 and 16 years and found that FMD was significantly reduced or absent compared to 6 aged-matched healthy controls. There was no difference in EID between the groups (Celermajer et al., 1992). Others, (de Jongh et al., 2002, Vlahos et al., 2014, Sorensen et al., 1994) have also found significantly lower brachial artery FMD responses in children and adolescents with FH compared to healthy controls. FMD was found to be inversely related to TC in both healthy children and those with FH and was inversely related to ApoA1 level in hypercholesterolemic children (Sorensen et al., 1994).

Table 2.3. Cross sectional studies comparing EDD and EID responses in children and adolescents with familial hypercholesterolemia and healthy children and adolescents

Author (y)	Age (y)	Cohort	%FMD	%GTN
Sorensen <i>et al.</i> , (1994)	7-17	FH (n=30)/healthy (n=30) matched for age and gender	sig↓ in FH vs. healthy (1.2 vs. 7.5 %)	sig↓ in FH vs. healthy (12.4 vs. 10.0 %)
de Jongh <i>et al.</i> , (2002)	9-18	FH (n=50)/Healthy (n=19) matched for age	sig↓ in FH vs. healthy (11.7 vs. 15.6%)	—
Celermajer <i>et al.</i> , (1992)	8-16	FH (n=10)/Healthy (n=6)	sig↓ in FH vs. healthy	↔ in FH vs. healthy
Vlahos <i>et al.</i> , (2014)	12	FH (n=30)/Healthy (n=30) matched for age and gender	sig↓ in FH vs. healthy (6.2 vs. 9.5 %)	—

FH, familial hypercholesterolemia; %FMD, percent change in diameter following flow mediated dilation; %GTN, percent change in diameter following glyceryl trinitrate mediated dilation; sig, significant.

Exercise/Physical Activity and Endothelial Function

Regular exercise training and moderate to high levels of PA reduce the risk of CVD (Blair & Morris, 2009). In a landmark study, Morris *et al.*, (1953) found significantly lower rates of CVD in physically active bus conductors than sedentary bus drivers. The conductors climbed approximately 600 steps per day (Morris *et al.*, 1953). Similarly, physically active postmen were found to have a significantly lower rate of CHD than sedentary office clerks and telephone operators (Morris 1953 *et al.*, 1953). The Harvard alumni study, one of the first large scale studies of self-reported PA and chronic disease found that adults who expended <2000 kcal per week had a 64% increased risk of MI compared to those who expended >2000 kcal·wk⁻¹ (Paffenbarger *et al.*, 1978).

The mechanisms for the beneficial effect of exercise on CVD risk are multifactorial. The Nurses' Health Study found that among 27,000 women, those who expended >1500 kcal·wk⁻¹ in PA had a 40% overall reduction in CVD risk than women who expended <200 kcal·wk⁻¹ (Mora *et al.*, 2007). Only 59% of the risk reduction for CVD could be attributed to the effects of PA on traditional risk factors, indicating that that other putative mechanisms such as alterations in the autonomic nervous system and a direct effect of exercise on the vascular wall may also be responsible for the risk reduction (Joyner & Green, 2009).

Autonomic dysfunction is associated with CVD. Exercise training improves heart rate variability by enhancing vagal tone. Enhanced endothelial function associated with exercise favors vasodilation and contributes to enhanced peripheral

baroreflex function by limiting the increases in vascular stiffness associated with age and CVD risk factors (Joyner & Green, 2009). Furthermore, positive interactions between enhanced endothelial function and sympathetic outflow limit the effects of high levels of baseline sympathetic outflow on BP.

Endothelial Function and Cardiorespiratory Fitness - Cross Sectional Studies

A number of cross-sectional studies have investigated the relation between CRF and endothelial function in healthy children (Hopkins et al., 2009, Treiber et al., 1997). Hopkins *et al.*, (2009) examined the relation between brachial artery FMD, percentage body fat and $\dot{V}O_{2peak}$ in 129 healthy asymptomatic 10 year old children (Hopkins et al., 2009). Brachial artery FMD was normalized for shear rate area under the curve (%FMD/SR_{AUC}). Overall, there was a significant relation between %FMD/SR_{AUC} and percentage body fat and $\dot{V}O_{2peak}$. However, when participants were classified into tertiles according to both percentage change in FMD (%FMD), and %FMD/SR_{AUC} there was no relation between $\dot{V}O_{2peak}$ and %FMD or %FMD/SR_{AUC}. There was a significant difference in $\dot{V}O_{2peak}$ between the lower and upper tertile for %FMD/SR_{AUC}. A cross-sectional study examining the relation between CRF, body fat and femoral artery FMD in asymptomatic healthy 11 to 14 year olds found that FMD was inversely related to percentage body fat and positively related to CRF (Treiber et al., 1997). In stepwise multiple regression analysis, CRF and SBP response to exercise accounted for 31% of the variance in femoral EDD (Treiber et al., 1997).

Aortic elasticity, another marker of vascular health is positively related to estimated $\dot{V}O_2\text{max}$ in 17 year olds (Pahkala et al., 2013). Reed *et al.*, (2005) found that performance on a 20 m multistage shuttle run test (20 MST) accounted for 15% and 7% of the variance in large and small artery compliance in 9 to 11 years old children. Arterial compliance was 34% greater in the highest CRF quartile than the bottom two quartiles (Reed et al., 2005).

Endothelial Function, cIMT and Cardiorespiratory Fitness - Training Studies

A number of studies have investigated the effect of short-term training on CRF and obesity-related vascular dysfunction in children and adolescents (Table 2.5) (Watts et al., 2004, Watts et al., 2005, Murphy et al., 2009). Compared to age and weight-matched non-exercising controls, 12 weeks of aerobic-active video-gaming improved brachial artery FMD by 22% in overweight 10 year old children with impaired endothelial function (Murphy et al., 2009). Using a crossover study design, Watts *et al.*, (2004) evaluated the effect of circuit training (CT) on brachial artery FMD in obese adolescent boys and girls (Watts et al., 2004). A matched group of lean boys and girls who did not train were recruited for cross-sectional comparisons. The CT sessions were performed three times per week for 8 weeks and consisted of a combination of cycle ergometry and resistance training (RT). Baseline brachial artery FMD was 67% lower in obese than lean adolescents and normalized relative to the lean group following eight weeks of CT. Submaximal exercise HR responses were significantly lower in obese adolescents at matched workloads post training, indicating an improvement in CRF.

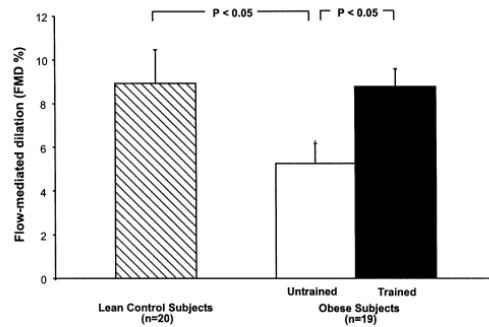

Figure 2.4. Effect of circuit training on brachial artery FMD in obese adolescents in comparison to lean age-matched controls (Watts et al., 2004).

In a prepubescent cohort of lean and obese boys and girls matched for age and physical activity levels, Watts *et al.*, (2005) found that brachial artery FMD was 105% higher in the lean children (Watts et al., 2005). Despite no change in BMI, body fat, and HR responses at matched workloads, brachial artery FMD increased by 23% in the obese group following 8 weeks of monitored aerobic training (Watts et al., 2005). Brachial artery FMD did not however, normalize after training relative to the age and PA matched lean control group. Since EID was not assessed in either study (Watts et al., 2004, Watts et al., 2005) it is not possible to determine whether the improvement in EDD was due to improved endothelium-dependent function or improvements in vascular smooth muscle sensitivity. Using a randomized control design Kelly *et al.*, (2004) found no change in brachial artery FMD or GTN mediated EID following 8 weeks of endurance training program in 11-year old overweight children (Kelly et al., 2004). Despite a 6% increase in $\dot{V}O_2$ max and a significant decrease in SBP, BMI and abdominal fat, Farpour-Lambert *et al.*, (2009) also found no change in brachial artery FMD or GTN mediated EID in obese pre-pubertal children

following 3 and 6 months of moderate intensity exercise training. Both arterial stiffness and cIMT decreased significantly at 6 months (Farpour-Lambert et al., 2009).

Exercise interventions ranging from 6 to 12 months in duration have been found to improve CRF, restore endothelial function and decrease cIMT in overweight and obese youth and children (Meyer et al., 2006b, Woo et al., 2004, Tjonna et al., 2008) and with T1DM (Seeger et al., 2011) Meyer *et al.*, (2006b) found a significant improvement in radial artery FMD accompanied by a significant decrease in cIMT after 6 months of aerobic exercise training in 15 year old obese adolescents. The improvements in vascular health were related to reductions in BMI, body fat mass, waist-to-hip ratio, SBP, fasting insulin, TG, LDL-C/HDL-C ratio, hsCRP and fibrinogen (Meyer et al., 2006b).

Tjonna *et al.*, (2008) compared the effect of a 12 month high-intensity aerobic interval training (AIT) program and a multi-treatment program on endothelial function and CVD risk factors in 14 year old overweight adolescents. The multi-treatment group had activity sessions and group meetings involving a physician, psychologist, physiotherapist, clinical nutritionist and physiologist. Improvements in $\dot{V}O_2\text{max}$ and endothelial function were significantly greater in the AIT than the multi-treatment group at both 3 and 12 months. Furthermore, AIT was more effective than the multi-treatment intervention in reducing traditional CVD risk factors (Tjonna et al., 2008). In children aged 11 years with T1DM, eighteen weeks of exercise training resulted in a 6.8% and 39% increase in $\dot{V}O_2\text{peak}$ and brachial artery FMD,

respectively. There were no significant change in cIMT, BMI and waist circumference post training (Seeger et al., 2011).

Endothelial Function - Diet and Exercise

Two studies have assessed the combined effect of diet and exercise on obesity-related vascular dysfunction and cIMT in youth (Woo et al., 2004, Kelishadi et al. 2008). Kelishadi *et al.*, (2008) examined the effect of a 6 week exercise and diet intervention on endothelial function, cIMT and CVD risk factors in obese children ranging in age from 12 to 18 years (Kelishadi et al., 2008). Participants performed 60 min of aerobic based MVPA 3 d·week⁻¹ for 6 weeks while adhering to a recommended diet. Following the 6-week intervention, brachial artery FMD was significantly greater than baseline and there was no change in cIMT. Training induced changes in CVD risk factors including BMI, waist circumference, fat mass, oxLDL, malondialdehyde, hsCRP, insulin and HOMA-IR were inversely related to the mean percentage change in FMD after adjustment for age and sex.

Woo *et al.*, (2004) compared the effect of 6 weeks and subsequently 1 year of dietary modification or a combined diet and exercise program on endothelial function, cIMT and CVD risk factors in overweight children aged 9-12 years. Both group consumed a 900-1200 kcal hypo-caloric diet (Woo et al., 2004). In addition, the exercise group undertook two weekly 75 min bouts of circuit-based exercise combining resistance, aerobic and agility training. Although brachial artery FMD increased significantly in both groups after 6 weeks, the improvement was greater in the combined diet and exercise group than the diet only group. Further

improvements in EDD were found in both groups from 6 weeks to 1 year. Both interventions resulted in a significant decrease in the waist-to-hip ratio and TC level.

Endothelial Function – Physical Activity

In 13 year-old boys, maximum FMD and area under the dilation curve 40-180 sec after hyperemia were found to be directly associated with self-reported leisure time physical activity (LTPA) (Pahkala et al., 2008). These associations remained significant after adjusting for baseline brachial artery diameter, BMI, HDL-C, LDL-C, TG, hsCRP and SBP. A difference in MVPA between sedentary and active boys of approximately 40 MET/h wk⁻¹ was associated with a 1% unit difference in maximal FMD.

Objectively measured time spent in moderate and high intensity PA has also been found to be significantly related to %FMD and %FMD corrected for shear rate (%FMD/SR_{AUC}) in pre-pubertal healthy children (Hopkins et al., 2009). Participants were split into tertiles according to FMD% and %FMD/SR_{AUC}. While MVPA and vigorous physical activity (VPA) were significantly related to %FMD/SR_{AUC} across the entire cohort, the strongest relation was found between PA and FMD in the lowest %FMD/SR_{AUC} tertile. Seasonal decreases in objectively measured high intensity PA have also been associated with a decrease in brachial artery FMD in 11 year old children (Hopkins et al., 2011). Abbott *et al.*, (2002) found that PA was related to the percentage change in brachial artery FMD in normal weight 5 to 10 year old children and FMD was significantly lower in the least active tertile compared to the most active tertile (Abbott et al., 2002).

In a longitudinal study, self-reported LTPA measured as MET/h wk⁻¹ in 13 to 17 years adolescents was independently related to both maximum brachial artery FMD and total FMD_{AUC} response (Pahkala et al., 2011). Maximum FMD increased in the sedentary adolescents who increased their LTPA from <5 MET/h wk⁻¹ to >30 MET/h wk⁻¹ between the age of 13 and 17 years compared with those who remained sedentary during that time.

Endothelial function – Sedentary Behaviour

To date only one published study has examined objectively measured sedentary behavior and endothelial function in healthy children. Hopkins *et al.*, (2012) measured baseline brachial artery FMD and total sedentary time over 7 days using a uniaxial accelerometer in 116 healthy children aged 10.7 years in summer and again 6 months later. At baseline, there was no association between FMD and sedentary time. While a significant decrease in brachial artery FMD and a significant increase in sedentary behaviour was observed between the seasons, the lack of association between brachial artery FMD and objectively measured total sedentary time remained (Hopkins et al., 2012).

Mechanisms for Exercise-induced Improvements in Endothelial Function

Exercise induced improvements in vascular function are attributed to a combination of enhanced vasodilatory capacity and arterial remodeling, risk factor modification and a reduction in ROS. Improvements in vasodilatory capacity normally proceed structural remodeling (Green et al., 2004). Repetitive increases in vascular

wall shear stress that accompany regular exercise training are associated with an increased up-regulation of eNOS expression (Green et al., 2004). This subsequently increases the synthesis and release of NO and improves endothelial function. Improvements in endothelial function may also be mediated through CVD risk factor modification. Compared with sedentary controls, lower cholesterol levels were related to an enhanced forearm dilation response to ACh in highly trained athletes (Kingwell et al., 1996).

Improvements in endothelial function in response to exercise training may occur independent of changes in traditional CVD risk factors. Green *et al.*, (2003) found that 8 weeks of exercise training in adults with CV risk factors did not significantly alter plasma lipids, BP, blood glucose, waist-to-hip ratio or BMI despite an improvement in endothelial function in conduit and resistance vessels (Green et al., 2003). Similarly, improvements in brachial artery FMD following 8 weeks of aerobic exercise training were not associated with changes in BMI, BP and plasma lipids in obese children and adolescents (Watts et al., 2005).

Improvements in endothelial function may also be mediated by a reduction in ROS and a restoration of NO bioavailability (Durand & Gutterman, 2014). Repeated up-regulation of eNOS in response to exercise training may increase the half-life of NO by reducing its degradation by free radicals (Fukai et al., 2000), or by directly inhibiting free radical production (Adams et al., 2005). Paradoxically, 12 weeks of exercise training, 5-7 times per week for 30 min at 75% $\dot{V}O_2$ max increased oxidative stress but failed to improve ACh mediated forearm vasodilation in healthy young

men, whereas training at 50% $\dot{V}O_2$ max improved the vasodilatory response to ACh in the absence of oxidative stress (Goto et al., 2003). These findings indicate that there may be an intensity threshold beyond which exercise negatively impacts endothelial function due to increased generation of ROS.

Carotid Intima Media Thickness

Carotid intima media thickness (cIMT) is the distance between the lumen intima interface and the media adventitia interface of the carotid artery wall (Pignoliet al., 1986). It is a commonly used index of arterial structure and is measured using ultrasonography. cIMT is regarded as valid indicator for generalised atherosclerosis as it is associated with atherosclerosis in other areas of the arterial tree (Bots & Grobbee, 2002).

The validity of ultrasonographically determined cIMT as a non-invasive surrogate marker for atherosclerotic CVD has been well established (Bots & Grobbee, 2002). Compared with angiography, measurement of cIMT using B-mode ultrasonography demonstrates greater sensitivity in detecting early atherosclerosis (Bots & Grobbee, 2002). The measurement of cIMT is increasingly used for risk stratification and as a surrogate end point in clinical trials to assess the efficacy of interventions against atherosclerosis. As vascular events in young individuals are rare, cIMT is an attractive end point in epidemiological and intervention studies in young asymptomatic populations (Lorenz et al., 2007).

cIMT – Measurement

The measurement of cIMT is routinely undertaken at the near and/or far wall of arterial segments including the carotid bulb, internal carotid artery and the CCA. Images of the CCA are easier to obtain and are highly reproducible compared to other carotid arterial segments (Nambi et al., 2012). Furthermore, IMT at the CCA is associated with adverse CV events (Fernhall & Agiovlasitis, 2008). The majority of pediatric studies examining the relation between CVD risk factors and cIMT have measured IMT of the CCA far wall (Urbina et al., 2009). Compared with histological examination, CCA far wall measurements more accurately represent the thickness of the intima media complex than near wall measurements (Urbina et al., 2009). Furthermore, Espeland *et al.*, (1999) found a stronger relation between CVD risk factors and far wall cIMT than near wall cIMT measurements (Espeland et al., 1999).

Large follow-up trials including the Atherosclerosis Risk in Communities (AIRC) study and the Rotterdam study found that cIMT is an independent predictor of future clinical vascular events such as stroke and MI in asymptomatic adults (O'Leary et al., 1999, Bots et al., 1997). A meta-analysis of longitudinal studies examining the relation between cIMT and future CV events found that a 0.1 mm increase in cIMT was associated with an 18% and 15% increase in age and sex-adjusted relative risk for future stroke and MI, respectively (Lorenz et al., 2007). The addition of cIMT to traditional risk factor score has been found to improve CHD risk prediction in middle-aged and older adults (Nambi et al., 2012).

cIMT Values in Healthy Children

Based on arbitrary-chosen cut-off points, normal values for cIMT in adults range between 0.5-1.2 mm. Increased cIMT is associated with both CAD and with several CVD risk factors (Le et al., 2010). The presence of carotid plaque is demonstrated by cIMT values > 1.2 mm (Bots & Grobbee, 2002).

Normative cIMT values for children and adolescents are limited (Le et al., 2010). Normal cIMT mean values in healthy children and adolescents have been reported to range between 0.32 mm to 0.50 mm (Urbina et al., 2009). Doyon *et al.*, (2013) recently published the first pediatric sex and age reference values for cIMT based on the measurement of 1155 healthy European children between the age of 6 and 18 years (Doyon et al., 2013). The 50th percentile of cIMT increased in boys from 0.37 mm at 6 years of age to 0.41 mm at 18 years of age (Doyon et al., 2013). In contrast, Sass *et al.*, (1998) found that cIMT was not affected by age or gender until after 18 years in a large cohort of 10 to 25 year olds. After the age of 18 years, cIMT increased significantly in males compared to females of similar age (Sass et al., 1998).

Vascular Aging

The Framingham Risk score is a gender-specific algorithm used to estimate the 10-year CV risk of an individual. CVD risk is calculated on points awarded depending on the presence of a number of risk factors including age, BP, diabetes, smoking and cholesterol levels. More recently, the SCORE-CARD evaluation system was introduced which is based on data from a large number of European countries.

Risk factors including age, gender, smoking and TC are used in the prediction model. Scoring systems such as The Framingham Risk Score and the SCORE-CARD are strongly influenced by chronological age and do not consider that the atherosclerotic burden of individuals with the same chronological age and similar risk profiles can greatly differ (Stein et al., 2004).

The concept of “Vascular aging” (VA) has more recently been integrated with existing risk stratification paradigms into CHD risk assessment. VA evaluates cIMT measurements against percentile charts for race and gender matched adult population (Stein et al., 2004). Although normative values in children are currently limited, VA estimation, and the ability to relate cIMT measurements to adult measurements may serve as a useful adjunct to stratify children at risk of developing premature atherosclerosis (Le et al., 2010). In the only published study to estimate VA in children, Le *et al.*, (2010) reported that 75% of children aged 6-19 years with obesity and CVD risk factors including dyslipidemia, hypertension, insulin resistance and tobacco exposure had advanced VA, defined as having a mean cIMT similar to that of a race and sex-matched 45 year old (Le et al., 2010). The average cIMT was 0.07 mm higher in children with advanced VA compared to children with age appropriate cIMT.

cIMT and CVD Risk Factors

Observational studies have reported increased cIMT in children with obesity (Zhu et al., 2005, Yilmazer et al., 2010, Iannuzzi et al., 2004,, Meyer et al.,2006, Woo et al., 2004, Reinehr et al., 2006, Stabouli et al., 2012), FH (Pauciullo et al., 1994,

Tonstad et al., 1996, Virkola et al., 1997, Wiegman et al., 2004), hypertension (Lande, et al., 2006, Litwin et al., 2006, Litwin et al., 2004), T1DM (Jarvisalo et al., 2004, Jarvisalo et al., 2002, Pozza et al., 2007) and T2DM (Naylor et al., 2011, Urbina, et al., 2009) compared to healthy children. Among the risk factors examined in children, cIMT is positively associated with age (Stabouli et al., 2012), level of obesity (Stabouli et al., 2012), BMI and waist circumference (Yilmazer et al., 2010), glucose and hsCRP (Reinehr et al., 2006), TC, LDL-C, Apo-B (Zhu et al., 2005), homocysteine, LDL-C and ApoA1 (Litwin et al., 2004), hyperinsulinemia and hypertriglyceridemia (Yilmazer et al., 2010), SBP (Stabouli et al., 2012, Litwin et al., 2004) 24 h SBP (Litwin et al., 2006) and pulse pressure (Stabouli et al., 2012, Litwin et al., 2004, Litwin et al., 2006).

cIMT and Obesity

Childhood obesity is associated with an increased risk of atherosclerotic disease in adulthood (Must et al., 1992). The adverse effect of obesity on the structure of large conduit arteries appears to be mediated in part by exposure to risk factors particularly SBP and insulin resistance (Iannuzzi et al., 2004). A number of cross-sectional studies in children and adolescents have found that, after adjustment for potential confounders, cIMT is increased in children who are overweight (Woo et al., 2004) or obese (Iannuzzi et al., 2004, Reinehr et al., 2006, Meyer et al., 2006, Zhu et al., 2005, Yilmazer et al., 2010) compared to healthy lean age-matched controls. A small number of studies however, failed to find a significant difference in cIMT between obese and healthy children and adolescents (Tounian et al., 2001, Aggoun et al., 2008, Farpour-Lambert et al., 2009).

Overweight/obese children with increased cIMT have also significantly greater arterial stiffness (Iannuzzi et al., 2004, Yilmazer et al., 2010) and lower FMD (Yilmazer et al., 2010, Woo et al., 2004). Children with elevated IMT defined as IMT > 0.48 mm also have significantly lower physical fitness levels (Meyer et al., 2006) Others have found no significant difference in cIMT between obese children and adolescents with impaired endothelial function and healthy age- matched controls (Tounian et al., 2001, Aggoun et al., 2008, Farpour-Lambert et al., 2009). Farpour-Lambert *et al.*, (2009) found no significant difference in IMT of the CCA in prepubertal obese children and in lean age-matched healthy controls despite obese children having significantly lower EDD, EID, $\dot{V}O_2$ max and PA levels and significantly higher BP, BMI, body weight, abdominal fat, insulin resistance indexes, hsCRP and arterial stiffness (Farpour-Lambert et al., 2009). The disparate findings may be due in part to the fact that arterial stiffness was not advanced enough to produce IMT and that changes in vascular function occur much earlier than structural changes (Cote et al., 2013). Furthermore, the effect of age, puberty and body fat distribution on cIMT in children remains uncertain (Cote et al., 2013).

cIMT and Hypertension

cIMT has emerged as a potential marker of hypertensive vascular damage (Lande et al., 2006). Increased cIMT has been found in obese hypertensive children (Lande et al., 2006, Litwin et al., 2006, Litwin et al., 2004, Stabouli et al., 2012). Some studies have however, failed to demonstrate an increased cIMT in hypertensive children and adolescents after adjusting for BMI while others did not find BP to be an

independent predictor of cIMT (Litwin et al., 2006, Litwin et al., 2004, Stabouli et al., 2012).

cIMT and Type 1 Diabetes Mellitus

A number of cross-sectional studies have compared CCA IMT in children and adolescents with T1DM and healthy controls. The majority of these studies found that CCA IMT was significantly higher in children with T1DM than healthy controls (Järvisalo et al., 2004, Jarvisalo et al., 2002, Rodriguez et al., 2007, Pozza et al., 2007 (Głowińska-Olszewska et al., 2013). Järvisalo *et al.*, (2002) also found that children with T1DM and impaired brachial artery FMD had significantly higher far wall CCA IMT than children with T1DM and normal FMD (Järvisalo et al., 2002). One study found no significant difference in CCA IMT between children with T1DM and low FMD and their healthy siblings (Babar et al., 2011). Diabetic state (Jarvisalo et al., 2002, Järvisalo et al., 2004), age at onset of diabetes (Pozza et al., 2007), daily insulin dose (Pozza et al., 2007), SBP (Jarvisalo et al., 2002, Rodriguez et al., 2007, Pozza et al., 2007), TC (Pozza et al., 2007), LDL-C (Jarvisalo et al., 2002, Rodriguez et al., 2007, Järvisalo et al., 2004) and brachial artery FMD (Järvisalo et al., 2004) were independently related to CCA IMT in children with T1DM.

cIMT and Type 2 Diabetes Mellitus

Only two published studies have examined cIMT in children and adolescents with T2DM (Naylor et al., 2011, Urbina, et al., 2009). CCA far wall IMT was significantly higher in children with T2DM than both lean aged-matched healthy

controls and obese non-insulin resistant controls (Naylor et al., 2011). Urbina *et al.*, (2009) compared IMT of the CCA, carotid bulb and ICA in lean, obese and T2DM individuals between the ages of 10 and 24 years. Individuals with T2DM had significantly higher IMT of the CCA than both lean and obese controls and significantly higher IMT of the ICA and carotid bulb than lean controls (Urbina et al., 2009).

cIMT and Familial Hypercholesterolemia

Findings from cross-sectional studies comparing cIMT in children and adolescents with FH and healthy children have been equivocal with some studies reporting increased cIMT in children with FH (Virkola et al., 1997, Pauciullo et al., 1994, Wiegman et al., 2004, Kusters et al., 2014, Tonstad et al., 1996) while others have found no difference in cIMT between the two groups (Vlahos et al., 2014, Riggio et al., 2010). In a recent study, Vlahos *et al.*, (2014) found that brachial artery FMD was significantly lower and TC, LDL-C, ApoB and ApoA1 levels were significantly higher in 12-year-old children with heterozygous FH than healthy age and gender-matched controls. However, there was no difference in cIMT between the two group (Vlahos et al., 2014). Similarly, Riggio *et al.*, (2010) found no difference in cIMT between children with FH, untreated hypercholesterolemia and primary hypercholesterolemia and age and sex-matched controls (Riggio et al., 2010).

cIMT – Cardiorespiratory Fitness

A number of cross-sectional studies have found an inverse association between CRF and cIMT in obese and normal weight children and adolescents (Table 2.4) (Meyer et al., 2006, Kim et al., 2011, Silva et al., 2014, Melo et al., 2014). Low levels of CRF were found to be associated with increased IMT of the CCA and carotid bifurcation in obese 9 to 16 year old children with impaired radial artery FMD (Meyer et al., 2006). More recently, Silva *et al.*, (2014) also found that IMT of the CCA was inversely associated with objectively measured $\dot{V}O_2\text{max}$ in obese and non-obese 10 to 16 year old boys and girls (Silva et al., 2014). Kim *et al.*, (2011) found that estimated $\dot{V}O_2\text{max}$ was inversely related with maximum cIMT in 17-year-old Korean males with an average BMI of 21 kg·m² (Kim et al., 2011). This relation was no longer significant, after adjusting for BMI. In a sample of children aged 11-13 years, Melo *et al.*, (2014) also found a significant inverse relation between estimated $\dot{V}O_2\text{max}$ and cIMT independent of MVPA and sedentary behaviour. Estimated $\dot{V}O_2\text{max}$ was however, no longer associated with cIMT after adjusting for waist circumference (Melo et al., 2014). These findings suggest that perhaps the effect of CRF on cIMT is mediated by adiposity.

In contrast, a number of cross-sectional studies involving approximately 800 children and adolescents have failed to find a significant relation between CRF and cIMT (Pahkala et al., 2013, Ried-Larsen et al., 2013). Although Pahkala *et al.*, (2013) found that estimated $\dot{V}O_2\text{max}$, was independently and inversely associated with aortic IMT and young elastic modulus, a measure of arterial elasticity, there was no

relation with cIMT (Pahkala et al., 2013). The equivocal findings may be related to the fact that some studies measured $\dot{V}O_2$ max while in others, it was estimated.

Table 2.4. Cross-sectional studies examining the relation between CRF and cIMT in healthy children and adolescents

Author (year)	Age (y)	Cohort	Measurement of CRF	Results
Meyer <i>et al.</i> , (2006)	13.7 ± 2.1 (obese) 14.7 ± 2.2 (healthy)	32 obese /20 healthy	$\dot{V}O_2$ max Maximal CE test	Low levels of CRF positively associated with increased cIMT
Silva <i>et al.</i> , (2014)	10-16	35 obese/18 healthy m/f=28/7	$\dot{V}O_2$ max Maximal TM test	$\dot{V}O_2$ max was inversely associated with cIMT
Kim <i>et al.</i> , (2011)	16.96 ± 0.23	225 healthy males	Estimated $\dot{V}O_2$ max One mile run test	$\dot{V}O_2$ max was inversely associated with cIMT
Melo <i>et al.</i> , (2015)	11-13	265 healthy m/f= /130135	Estimated $\dot{V}O_2$ max Maximal CE test	$\dot{V}O_2$ max inversely associated with cIMT
Ried-Larsen <i>et al.</i> , (2013)	15.6 ± 0.4	336 healthy m/f=179/219	Estimated $\dot{V}O_2$ max Maximal CE test	No association between $\dot{V}O_2$ max and cIMT
Pahkala <i>et al.</i> , (2013)	17 years	m/f=189/179 Fitness tertiles; m(LF=63, MF=63, HF=63) f (LF=60, MF=59, HF=60)	Estimated $\dot{V}O_2$ max Maximal CE test	No association between $\dot{V}O_2$ max and cIMT

CRF, cardiorespiratory fitness; $\dot{V}O_2$ max, maximal oxygen uptake; m/f, male/female; LF, low fit; MF, moderately fit; HF, high fit; CE, cycle ergometer; TM, treadmill

cIMT- Physical Activity

Findings from studies that have evaluated the relation between PA and cIMT in children and adolescents have been equivocal (Ried-Larsen et al., 2013, Ried-Larsen et al., 2014, Pahkala et al., 2011). PA intensity, measured using accelerometry was not associated with cIMT in a large sample of 16 year old Danish adolescents (Ried-Larsen et al., 2013). Similarly, a 6 year prospective study found no association between exposure to, or changes in minutes spent in higher PA intensities between the age of 8 and 10 years and cIMT during adolescence (Ried-Larsen et al., 2014). In contrast, studies that have employed self-reported measures to assess PA have found inverse associations between PA and IMT. Pahkala *et al.*, (2011) using a prospective study design found that after adjusting for age, sex, BMI, HDL: TC, SBP, hsCRP and brachial artery diameter, LTPA assessed by questionnaire was inversely associated with aortic IMT (aIMT) in the same cohort measured at 13, 15 and 17 years of age. Sedentary adolescents who increased their LTPA from <5 to >5 METS $\text{h}\cdot\text{wk}^{-1}$ between 13 and 17 years had a significantly decreased progression of aIMT than those who maintained LTPA at <5 METS/ $\text{h}\cdot\text{wk}^{-1}$. Individuals who remained physically active had a significantly lower rate of aIMT progression than those who remained sedentary (Pahkala et al., 2011). These equivocal findings may be due to the inherent differences in methods employed to measure PA.

CIMT- Sedentary Behaviour

To date, only one published study has examined the association between objectively measured sedentary behavior and cIMT in 265 children aged 11-13 years

(Melo et al., 2014). Using 100 counts per min as a sedentary cut-point,, 4 days of total sedentary time measured using an Actigraph uniaxial accelerometer was not associated with CCA far wall IMT with or without adjustment for waist circumference (Melo et al., 2014). In contrast, waist circumference was positively associated with cIMT suggesting that adiposity may perhaps be a stronger determinant of cIMT in children and adolescents.

Aortic Intima Media Thickness

Autopsy studies have found that changes in vascular structure occur in the intima of abdominal aorta prior to the coronary and carotid arteries (McGill et al., 2000). Measurement of aIMT may therefore provide a better index of preclinical atherosclerosis. Compared to cIMT, measurement of aIMT has been found to provide greater sensitivity in identifying subclinical atherosclerosis in high risk children (Jarvisalo et al., 2001). While both aIMT and cIMT measurements were higher in children with T1DM and hypercholesterolemia than healthy controls, the increase in IMT was relatively greater in the aorta than the carotid artery (Jarvisalo et al., 2001). A study examining both aIMT and cIMT found a significant increase in aIMT only, in children with T1DM compared to healthy controls. Measures of aIMT were significantly related to CVD risks factors (Harrington et al., 2010). Among adolescents, Dawson *et al.*, (2009) found a stronger association between CVD risk factors and aIMT than cIMT (Dawson et al., 2009).

Table 2.5: Studies examining the effect of exercise training on flow mediated dilation, cIMT, CVD risk factors and CRF in children and adolescents

Author	Cohort	Age(Y)	Intervention	FMD	cIMT	CVD risk factors	CRF
Watts <i>et al.</i> , (2004)	Obese Ex (N=19) Obese CTL(N = 20)	14.3 ± 1.5	ET + RT 60 min 3d/wk/8wk	↑	—	↓ BF, ↔ Lipids, homocysteine, HbA _{1c} , BP	↑
Watts <i>et al.</i> , (2004)	Obese Ex (N=14) Obese CTL (N = 7)	8.9 ± 0.4	ET 60 min 3d/wk/8wk	↑	—	↓ HbA _{1c} ↔ BW, BMI, BF, lipids, homocysteine, glucose, BP	↔
Kelly <i>et al.</i> , (2004)	OW Ex (N=10) OW CTL (N = 20)	10.9 ± 0.4	ET 30-50 min 4d/wk/8wk	↔	—	↑ HDL-c vs. con	↔
Murphy <i>et al.</i> , (2009)	OW Ex (N=23) OW CTL (N= 12)	7-12	ET 10-30 min 5d/wk/12wk	↑	—	↓ BW, MAP	↑
Fapour Lambert <i>et al.</i> , (2009)	Obese Ex (N=22) Obese CTL (N = 22)	8.5 ± 1.5	ET 60 min/3d/wk/12wk ET 60 min/2d/wk/6mo	↔ at 3 & 6 mo	↔ at 3 mo ↓ at 6 months	↓ BP, BMI, BF	↑
Meyer <i>et al.</i> , (2006)	Obese Ex (N=33) Obese CTL (N = 34)	14.7 ± 2.2	ET 60 min/2d/wk + 90min/1d/wk/6mo	↑ vs. con	↓	↓ BMI, BF, W:H, insulin, insulin resistance, TG, LDL: HDL, fibrinogen, hsCRP	↑
Tjonna <i>et al.</i> , (2009)	OW AIT (N=20) OW MTG (N = 22)	14.0 ± 0.3	AIT: 4x4 min/2d/wk/3mo MTG: Group Meeting 2d/wk/	AIT↑ (6.3%) MTG ↑ (3.9)	—	AIT: ↓ BMI, BF, SBP, DBP, MAP, insulin, glucose, HOMA, HbA _{1c} ↑ HDL-c	↑

Seeger <i>et al.</i> , (2011)	T1DM Ex (N=9)	10.9 ± 1.5	ET 30-60 min 2d/wk/18wk	↑	↔	MTG: ↓ SBP, insulin, HOMA, HbA _{1c} ↑ HDL-c ↔ BMI, WC	↑
Kelishadi <i>et al.</i> , (2008)	Obese Ex+ Diet (N=35)	12-18	ET 60 min 3d/wk/6wk	↑	↔	↓ BMI, BF, WC, W:H,TC, LDL-C, TG, Insulin, HOMA-IR, hsCRP, oxLDL-c, MDA	—
Woo <i>et al.</i> , (2004)	Obese Ex + Diet (N=41) Obese Diet(N = 41)	9-12 y	ET 75min 2d/wk/6wk	↑	↔	Ex +Diet:↓ W:H, TC,LDL-c, LDL:HDL, glucose. Diet: ↓ W:H,TC,HDL-c, LDL:HDL	—
Woo <i>et al.</i> , (2004)	Obese Ex + Diet (N=22) Obese Diet(N = 41)	9-12 y	ET 75min 1d/wk/1yr	↑	↓	Ex +Diet:↓ BF, LDL-c, HDL-c, LDL:HDL Diet: ↓ TC,HDL-c, LDL:HDL	—

FMD, flow mediated vasodilation; CRF, cardiorespiratory fitness; Ex, exercise group; CTL; control group; ET, endurance training; RT, resistance training; BF, body fat; BP, blood pressure; OW, overweight; BW, Body weight; BMI, body mass index; W: H, waist-to-hip ratio; WC, waist circumference; MAP, mean arterial pressure; hsCRP, High sensitivity C-reactive protein; SBP, systolic blood pressure; DBP, diastolic blood pressure; triglycerides; TC, total cholesterol; AIT, aerobic interval training, MTG; multidisciplinary approach; OxLDL-c, oxidized LDL-cholesterol; MDA, malondialdehyde; HbA_{1c}, glycosylated hemoglobin, HOMA, Homeostasis model assessment of insulin resistance;

Inflammation and CVD

Although traditional CVD risk factors such as age, male sex, hypercholesterolemia, hypertension, and smoking, account for most of the risk of coronary heart disease approximately one-third of individuals with ≤ 1 risk factor develop CHD, 15% to 20% occur in individuals with none of the major traditional risk factors and close to 50% occur in individuals with no overt evidence of hyperlipidemia (Khot et al., 2003, Greenland et al., 2003).

The role of inflammation in the propagation of atherosclerosis and susceptibility to CV events is well established (Ridker et al., 2000). In response to endothelial damage, a complex intracellular network of T-lymphocytes, macrophages and smooth muscle cells secrete an array of growth factors and pro-inflammatory cytokines that mediate functional and structural changes in the vasculature (Kofler et al., 2005). Upon activation, endothelial cells also secrete vascular adhesion molecules to which circulating leukocytes adhere. High circulating levels of pro-inflammatory cytokines including IL-1, IL-6 and TNF- α , further add to the expression of adhesion molecules (Bruyndonckx et al., 2013), increase oxidative stress, down-regulate eNOS bioactivity and cause endothelial cell apoptosis (Kofler et al., 2005).

A number of systemic inflammatory proteins have been identified as potential indicators of subclinical atherosclerosis and have been used in the prediction of risk of CV events including hsCRP, serum amyloid A (SAA), cytokines such as IL-6, and adhesion molecules such as soluble intracellular adhesion molecule-1 (sICAM-1)

(Ridker et al., 2000). A number of these markers have been found to impair endothelial function either directly by reducing NO production or indirectly by increasing ROS generation.

High Sensitivity C-Reactive Protein (hsCRP)

High sensitivity C-reactive protein (hsCRP) is an acute phase reactant and non-specific marker of inflammation produced predominantly in hepatocytes in response to several cytokines. Of the wide array of inflammatory biomarkers that have been studied, CRP has received the most attention for its use in screening and risk. Systemic low-grade inflammation, as assessed by measuring serum concentrations of hsCRP, has been found to be an independent risk factor of future cardiovascular events in a large number of studies involving both men and women. Although hsCRP is associated with increased CVD risk, definitive randomized evidence for its role as a causative factor in atherothrombosis is lacking (Yousuf et al., 2013)

As a predictor of this risk, high sensitivity measurements are needed, and hsCRP assays have been developed. Circulating hsCRP values $> 3.0 \text{ mg}\cdot\text{L}^{-1}$, $1.0\text{-}3.0 \text{ mg}\cdot\text{L}^{-1}$ and $< 1.0\text{-}\text{mg}\cdot\text{L}^{-1}$ are associated with a high, moderate and low risk of CVD, respectively (Ridker, 2005). Phenotypes that portend accelerated atherosclerosis, including obesity, metabolic syndrome and insulin resistance, are associated with elevated levels of hsCRP. CRF and adiposity may influence CVD risk through their effects on inflammation.

Circulating hsCRP levels are significantly higher in overweight than normal weight children and adolescents (Peña et al., 2006, Kapiotis et al., 2006, Meyer et al., 2006, Peña et al., 2010, Akinci et al., 2008, Farpour-Lambert et al., 2009, Jarvisalo et al., 2002). hsCRP has also been associated with impaired brachial artery FMD and increased CIMT in healthy children and adolescents (Jarvisalo et al., 2002).

In the first study to evaluate hsCRP levels in a population-based sample of apparently healthy children, Cook *et al.*, (2000) found that adiposity was the important determinant of hsCRP levels among the characteristics measured in English and Welsh children aged 9-11 years (Cook et al., 2000). The fall in hsCRP levels with increasing levels of PA was only of borderline significance. This may be due in part to the crude nature of the PA questionnaire employed in the study. In contrast, resting HR, which is a reasonable marker of aerobic fitness in children, was significantly related to hsCRP levels. HsCRP was correlated with several CVD risk factors, but only fibrinogen, HDL-C, resting HR and SBP remained statistically significant after adjustment for the confounding effect of adiposity. Adiposity was independently related to all CVD risk factors independent of hsCRP. Adjustment for hsCRP had little effect on the relation between adiposity and CVD risk except for that with fibrinogen, indicating that while adiposity has effects on hsCRP, the effect of adiposity on some CVD risk factors is via a separate pathway. The study findings suggest that, with the possible exception of fibrinogen, hsCRP does not mediate the effects of obesity.

Other studies have found evidence of a state of low-grade systemic inflammation in overweight children. In a sample of 3512 children from the NHANES

III, a higher prevalence of elevated hsCRP was found in overweight than normal weight children, even after controlling for disease and other factors known to influence hsCRP concentrations (Visser et al., 2001). Another NHANES III study involving 2846 boys and girls 3 to 17 years of age found that among the measured socio-demographic and CVD risk factors, BMI was the most consistent and strongest predictor of hsCRP concentration (Ford, 2003). A recent study involving healthy preschool boys and girls between the age of 3 to 5 years, found that obese children presented with inflammatory and metabolic alterations (Carmona-Montesinos et al., 2015). Preschool children who were classified as obese had significantly higher circulating levels of hsCRP, TG, LDL-C and glucose levels as well as decreased levels of HDL compared with eutrophic children.

Currently, limited information exists on the role of CRF on hsCRP in children and adolescents. Among US children 12 to 16 years of age, percent body fat correlated positively and physical fitness and inversely with hsCRP concentration. However, 8 months of physical training had little effect on CRP concentrations despite weight loss and improved fitness (Barbeau et al., 2002). Sun *et al.*, (2014) found that higher childhood CRF is associated with lower levels of hsCRP and fibrinogen 20 years later when the participants were young adults. Higher childhood adiposity and an increase in adiposity from childhood to adulthood were associated with higher adult hsCRP levels, independent of fitness (Sun et al., 2014). With the majority of studies demonstrating a positive relation between measures of adiposity on hsCRP and a limited studies examining the mediating role of CRF in this

relationship, adiposity appears to be a stronger determinant of hsCRP. However, the inverse relation observed between hsCRP and CRF suggests that CRF may play a protective role on low-grade inflammation through reductions in adiposity.

Serum Amyloid A (SAA)

Similar to hsCRP, serum amyloid (SAA) is an acute phase protein synthesized in the liver in response to infection, injury, inflammation or stress. Specifically, its expression is upregulated in response to pro-inflammatory cytokines including interleukin-1 beta (IL-1 β), IL-6 and TNF- α . Circulating SAA associates predominately with HDL-C. It displaces ApoA1, the major Apo lipoprotein of HDL-C, particularly during the acute phase response and alters reverse cholesterol transport.

Elevated levels of SAA have been found to predict CVD events (Johnson et al., 2004, Ridker et al., 2000) even better than hsCRP (Kosuge et al., 2007). Obese children and adolescents have increased levels of SAA compare to their lean healthy counterparts (Gomez-Ambrosi et al., 2008).

Interleukin-6 (IL-6)

Interleukin-6 is a cytokine that has both pro-inflammatory and anti-inflammatory properties (Scheller et al., 2011). In addition to inflammation, IL-6 is involved in the regulation of metabolism, neural and regenerative processes (Scheller et al., 2011.) As a proinflammatory cytokine, IL-6 stimulates the production of acute-phase proteins, including hsCRP, in the liver (Ridker et al., 2000). Higher adipose tissue content of IL-6 has been associated with higher serum hsCRP concentrations in

obese persons. The release of interleukin-6 from adipose tissue may induce elevated hsCRP concentrations in individuals with excess body fat. In addition to the stimulation of acute phase proteins, IL-6 also stimulates the production of angiotensin II in vascular smooth muscle cells and the subsequent production of ROS (Wassmann et al., 2004). Increased production of ROS results in decreased NO production, an uncoupling of eNOS and paradoxical increased ROS generation (Landmesser et al., 2003). Higher levels of circulating IL-6 have been found in obese children with lower FMD and increased cIMT compared to healthy children (Kapiotis et al., 2006, Murphy et al., 2009).

TNF- α

Tumor necrosis factor alpha (TNF- α), a pro-inflammatory cytokine is primarily produced by activated macrophages in adipocytes. Its production contributes to the further expression of adhesion molecules including sICAM-1 and IL-6 and MCP-1 which promote diapedesis of monocytes from the circulation to adipose tissue (Bruyndonckx et al., 2013). High levels of TNF- α are positively associated with impaired EDD through their increased stimulation of the production of ROS and decreased bioavailability of NO (Zhang et al., 2009). In addition, TNF- α is associated with insulin resistance with deficiencies in TNF- α or its receptors associated with increased insulin sensitivity (Hotamisligil, 1999).

Interleukin 1 (IL-1)

The interleukin 1 gene family consists of 3 proteins involved in systemic inflammation; interleukin-1 (IL-1), interleukin-1 beta (IL-1 β) and IL-1 receptor antagonist (IL-1ra). Both IL-1 and IL-1ra are produced by endothelial cells, smooth muscle cells and macrophages and are mediators for the secretion of (IL-1 β) a pro-inflammatory cytokine that is associated with CVD risk factors including obesity diabetes mellitus, hypertension, smoking and dyslipidemia (Fearon & Fearon, 2008). In addition, increased levels of IL-1 result in the secretion and expression of IL-6 and other cytokines, activation of endothelial and smooth muscle cell proliferation, macrophage activation and increased vascular permeability (Fearon & Fearon, 2008). Elevated circulating levels of cytokines of the IL-1 family have been found in overweight adolescents (Jung et al., 2010).

Vascular Adhesion Molecules

Soluble intracellular adhesion molecule 1 (sICAM-1) and soluble vascular adhesion molecule 1 (sVCAM-1) are transmembrane glycoprotein members of the immunoglobulin (Ig) gene superfamily (Fotis et al., 2012) that participate in atherosclerosis by stimulating monocyte accumulation in the arterial intima. Increased levels of sICAM-1 have been reported in overweight/obese children compared to healthy children (Jarvisalo et al., 2002, Desideri et al., 2005, Caballero et al., 2008) whereas others have found no difference in sICAM-1 or sVCAM-1 between obese and healthy children (Kapiotis et al., 2006, Peña et al., 2010). Brachial artery

FMD was inversely related to sICAM-1 in healthy and obese adolescents (Jarvisalo et al., 2002, Glowinska-Olszewska et al., 2007).

INF- γ

Interferon gamma (IFN- γ) is a pro-inflammatory cytokine that is synthesized by T-cells and released locally in the blood vessel intima in response to vascular injury (Vaddi et al., 1994). Together with TNF- α , IFN- γ increases the i) expression of intracellular adhesion molecules (Vaddi et al., 1994), ii) activity of plasminogen activator inhibitor and iii) synthesis of tissue plasminogen activator (Schleef et al., 1988).

Risk factors for CVD risk including obesity and the metabolic syndrome (MetS) are associated with a low-grade pro-inflammatory status in childhood (Christodoulos et al., 2012, Kapiotis et al., 2006) and are associated with the development of insulin resistance, atherosclerosis and other obesity comorbidities (Metzig et al., 2011).

Inflammation, Endothelial function and cIMT

Among obese children, brachial artery FMD was found to be 40% lower and cIMT was 8% higher than healthy normal weight controls. Circulating hsCRP, IL-6 and E-selectin were also significantly higher in the obese children than the healthy controls (Kapiotis et al., 2006). Although circulating hsCRP was positively associated with BMI, IL-6, sICAM-1, sVCAM-1 and E-selectin in obese children there was no relation between hsCRP and brachial artery FMD or cIMT. There was no difference in sICAM-1 and sVCAM-1 between the groups. In contrast, hsCRP was found to be a

significant and independent predictor of brachial artery FMD and cIMT in healthy children aged 10.5 years (Jarvisalo et al., 2002). Compared to children with hsCRP levels under the detection limit (<0.1 mg/L), children with higher hsCRP (≥ 0.1 to ≤ 0.7 mg·L⁻¹) or (> 0.7 mg·L⁻¹) both had significantly lower brachial artery FMD and significantly higher cIMT (Jarvisalo et al., 2002).

Others have also found significantly higher hsCRP levels in obese children with impaired EDD and EID than normal weight children (Peña et al., 2010, Farpour-Lambert et al., 2009). Children with normal endothelial function but at risk for being overweight also have significantly higher levels of hsCRP (Akinci et al., 2008, Farpour-Lambert et al., 2009, Meyer et al., 2006). Elevated levels of E-selectin, thrombomodulin and fibrinogen are also present in obese children and adolescents with impaired EDD and with low $\dot{V}O_2\text{max}$ (Meyer et al., 2006). The majority of studies that have reported increased levels of circulating inflammatory markers have been conducted in overweight/obese children and adolescents suggesting that excess body fat may prerequisite for the expression and release of inflammatory markers since adipocytes partially mediate the inflammatory response. While a number of studies have reported a significant association between inflammatory markers and vascular health in children and adolescents with impaired EDD and increased cIMT, others have found no association (Kapiotis et al., 2006). This may be due to differences in the cohort between studies and also may be that the measurement of inflammatory markers are perhaps not as sensitive of a marker of vascular health in children and

adolescents compared to the direct measurement of vascular health using non-invasive ultrasound.

Exercise and Inflammation

Regular exercise exerts a positive anti-inflammatory effect (Pedersen, 2006). The release of IL-6 by the muscle fibers during exercise stimulates the production of anti-inflammatory cytokines IL-1ra and IL-10 and inhibits the production of the pro-inflammatory cytokine, TNF- α (Pedersen, 2006). A number of studies have examined the effect of exercise training alone or in combination with diet on markers of inflammation and vascular health (Table 2.6). Six months of aerobic exercise training 3 times a week for 60 min decreased BMI, waist-to-hip ratio, cIMT, hsCRP and fibrinogen and improved brachial artery FMD in 67 obese adolescents (Meyer et al., 2006).

Nitric oxide generation can be assessed by measuring the serum levels of nitrite/nitrate (NOx). In contrast, ADMA an endogenous inhibitor of nitric oxide synthase (NOS), may be related to reduced biosynthesis of NO and ACVD. The closely related compound symmetric dimethylarginine (SDMA) does not inhibit NOS, but may compete with arginine for cellular uptake, thereby limiting substrate availability for NOS. In overweight 12 year olds, 10-30 min of aerobic dance 5 days a week for 12 weeks significantly increased $\dot{V}O_2$ peak, NOx and adiponectin levels, and significantly improved brachial artery FMD compared to non-exercise controls (Murphy et al., 2009). There were no significant within group or between group differences in the ADMA, SDMA or pro-inflammatory cytokines at any time. Similarly, 3 months of high-

intensity aerobic interval training twice a week for 3 months significantly increased NO production, $\dot{V}O_{2\max}$, brachial artery FMD and significantly decreased percentage body fat in obese 14-year-old adolescents (Tjønnna et al., 2009). There was no significant difference in adiponectin levels following the exercise program. Using a randomized cross-over study design Kelly *et al.*, (2004) also found a significant improvements in $\dot{V}O_{2\text{peak}}$, HDL-C and brachial artery FMD/SR_{AUC} in 20 overweight children aged 11 years following an 8 week exercise program consisting of stationary cycling (Kelly et al., 2004). These improvements occurred independent of changes in body weight and body composition and hsCRP.

In contrast, Farpour-Lambert *et al.*, (2009) found that despite a significant reduction in BMI and body fat, aerobic exercise training three times a week for 3 months had no effect on brachial artery FMD, cIMT and hsCRP in pre-pubertal obese children (Farpour-Lambert et al., 2009). Similarly, 40 min of aerobic based training three times per week for 12 weeks improved CRF and insulin sensitivity in the absence of weight loss, percentage body fat and changes in adiponectin, IL-6, hsCRP, sICAM-1 and sVCAM-1 in 19 overweight and obese girls aged 13 years (Nassis et al., 2005). In a younger cohort of overweight children with a mean age of 10.8 years Kelly *et al.*, (2007) found that four weekly 30-50 min sessions of supervised stationary cycling at 50-80% $\dot{V}O_{2\max}$ for 8 weeks improved $\dot{V}O_{2\max}$ but had no effect on body weight, body fat, hsCRP, IL-6, adiponectin, leptin, resistin or 8-isoprostane (Kelly et al., 2007). Collectively the majority of the studies that have examined the effect of exercise training on vascular health and inflammation have reported improved

vascular health and weight loss but an inconsistent decrease of inflammatory markers while others have demonstrated improvements of vascular health independent of changes in body weight.

Exercise, Diet and Inflammation

In obese children and adolescents aged 12-18 years, a combined 6-week exercise and dietary intervention increased brachial artery FMD and reduced hsCRP and markers of oxidative stress including oxLDL (malondialdehyde (MDA) and conjugated diene (CDE) (Kelishadi et al., 2008). Circulating insulin, HOMA-IR, body weight, BMI, percentage body fat, waist circumference also improved significantly, but subcutaneous fat did not change. After adjusting for age and gender, the exercise induced improvements in insulin, HOMA-IR BMI, waist circumference, fat mass, LDL_{ox}, MDA, hsCRP were inversely related to improvements in brachial artery FMD (Kelishadi et al., 2008).

Similarly, a 2 week high-fibre low-fat diet combined with 2.0 -2.5 h of daily aerobic exercise significantly reduced the circulating levels of 8-isoprotaglandin F2alpha, a maker of oxidative stress, myeloperoxidase (MPO) and the inflammatory markers sICAM-1, E-selectin, hsCRP and total matrix metalloproteinase-9 in overweight children and adolescents aged 8-17 years (Roberts et al., 2007). Additionally, there was a significant decrease in the production of superoxide hydrogen peroxide, MCP-1 and a concomitant increase in NO production.

Table 2.6: Studies examining the effect of exercise on markers of inflammation, flow mediated dilation, cIMT, CVD risk factors and CRF in children and adolescents

Author	Cohort	Age (Y)	Intervention	Inflammation	FMD	cIMT	CVD risk factors	CRF
Watts <i>et al.</i> , (2004)	Obese Ex (N=19) Obese CTL (N = 20)	14.3 ± 1.5	ET + RT 60 min 3d/wk/8wk	↔ homocysteine	↑	—	↓ BF, ↔Lipids, homocysteine, HBA _{1c} , BP	↑
Watts <i>et al.</i> , (2004)	Obese Ex (N=14) Obese CTL (N = 7)	8.9 ± 0.4	ET 60 min 3d/wk/8wk	↔ homocysteine	↑	—	↓ HbA _{1c} ↔ BW, BMI, BF, lipids, homocysteine, glucose, BP	↔
Kelly <i>et al.</i> , (2004)	OW Ex (N=10) OW CTL (N = 20)	10.9 ± 0.4	ET 30-50 min 4d/wk/8wk	↔ hsCRP ↑ adiponectin vs. con, sig ↓ in IL-6 in females Ex vs. CTL	↔	—	↑ HDL-c vs. con	↔
Murphy <i>et al.</i> , (2009)	OW Ex (N=23) OW CTL (N= 12)	7-12	ET 10-30 min 5d/wk/12wk	↔ in hsCRP, TNF- α	↑	—	↓ BW, MAP vs.con	↑
Nassis <i>et al.</i> , (2005)	OW/OB girls (N=19 girls only)	13 years	ET 40 min/3d/wk/12wk	↔ hsCRP, IL-6, adiponectin, sICAM-1, sVCAM-1	—	—	↑ insulin sensitivity ↔ body weight, body fat	↑
Fapour Lambert <i>et al.</i> , (2009)	Obese Ex (N=22) Obese CTL (N = 22)	8.5 ± 1.5	ET 60 min/3d/wk/12wk ET 60 min/2d/wk/6mo	↔ hsCRP	↔ at 3 & 6 mo	↔ at 3 mo ↓ at 6 months	↓ BP, BMI, BF vs con	↑
Meyer <i>et al.</i> , (2006)	Obese Ex (N=33) Obese CTL (N = 34)	14.7 ± 2.2	ET 60 min/2d/wk + 90min/1d/wk/6mo	↓ hsCRP, fibrinogen vs con	↑ vs. con	↓	↓ BMI, BF, W:H, insulin, insulin resistance, TG,	↑

							LDL: HDL vs.con	
Tjonna <i>et al.</i> , (2009)	OW AIT (N=20) OW MTG (N = 22)	14.0 ± 0.3	AIT: 4x4 min/2d/wk/3mo MTG: Group Meeting 2d/wk/	↔ in adiponectin	AIT↑ (6.3%) MTG ↑ (3.9)	—	AIT: ↓ BMI, BF, SBP, DBP, MAP, insulin, glucose, HOMA, HbA _{1c} ↑ HDL-c MTG: ↓ SBP, insulin, HOMA, HbA _{1c} ↑ HDL-c	↑
Kelly <i>et al.</i> , (2007)	OW EX=9 OW con=10	OW Ex 10.8 ± 0.67 OW con 11.0 ±0.71	ET 30-50 min 4d/wk/8wk	↔hsCRP, IL-6, adiponectin leptin, resistin	—	—	↔ body weight, body fat	↑
Kelishadi <i>et al.</i> , (2008)	Obese Ex+ Diet (N=35)	12-18	ET 60 min 3d/wk/6wk	↓ hsCRP	↑	↔	↓ BMI, BF, WC, W:H,TC, LDL-C, TG, Insulin, HOMA-IR, hsCRP, oxLDL-c, MDA	—
Roberts <i>et al.</i> , (2007)	OW Ex + Diet (n=19)	8-17	ET 180-210 min/7d/wk/2wk	↓ hsCRP, sICAM- 1, E-selectin, MMP-9	*↑ NO			—

FMD, flow mediated vasodilation; CRF, cardiorespiratory fitness; Ex, exercise group; CTL; control group; ET, endurance training; RT, resistance training; BF, body fat; BP, blood pressure; TG, triglycerides, OW, overweight; BW. Body weight; BMI, body mass index; W:H, waist-to-hip ratio; WC, waist circumference; MAP, mean arterial pressure; hsCRP, C-reactive protein; SBP, systolic blood pressure; DBP, diastolic blood pressure;; TC, total cholesterol; AIT, aerobic interval training, MTG; multidisciplinary approach oxLDL-c, oxidized low density lipoprotein cholesterol; , IL-6, interleukin-6; sICAM, soluble intracellular adhesion molecule; sVCAM-1, soluble vascular adhesion molecule; MMP-9, matrix metalloproteinase; HOMA, homeostatic model assessment of insulin resistance; HbA_{1c}, glycated hemoglobin; wk, week; d, day; TNF- α , tumor necrosis factor alpha; MDA, malondialdehyde.

Cardiorespiratory Fitness and inflammation in Children and Adolescents

CRF has a protective role in the development of CVD and low-grade inflammation. Currently little is known about the mediating effect of adiposity on the relation between CRF, CVD and inflammation in children (Christodoulos et al., 2012). In univariate analysis, a stronger association has been found between body fat and the MetS than between CRF and MetS. Christodoulos *et al.*, (2012) found a significant relation between CRF and both MetS and hsCRP in 112 healthy children aged 11.4 years. Children with low CRF estimated using a 20 MST had significantly higher MetS risk and hsCRP levels than children with high CRF. The relation between CRF and both MetS and hsCRP was attenuated after adjusting for measures of adiposity including waist circumference and BMI (Christodoulos et al., 2012).

Similarly, a cross-sectional study involving of 142 prepubertal children aged 9-10 years examined the association of hsCRP, fibrinogen and complement factors C3 and C4 with CRF, PA and body fat (Ruiz et al., 2007). After controlling for sex, age and pubertal development, hsCRP and C3 were inversely associated with estimated $\dot{V}O_2\text{max}$ and positively associated with body fat. However, the association between $\dot{V}O_2\text{max}$ and hsCRP and C3 were no longer significant after adjustment for body fat. In contrast, both hsCRP and C3 were positively associated with body fat after controlling for sex, age and pubertal status. When both CRF and body fat were included in the regression model, only the association between body fat and hsCRP and C3 remained significant. There was no significant relation between objectively measured total time spent in physical activity and in MVPA and VPA

and inflammatory markers despite a significant relation between total time in PA, MVPA and VPA and $\dot{V}O_2\text{max}$.

A cross-sectional study involving 197 children aged 10-15 found that obese children had significantly higher skinfold thickness, LDL-C, fibrinogen, ferritin, IL-6 and TNF- α and lower HDL-C than non-obese children (Halle et al., 2004). When the children were divided into 4 groups based on CRF (< 5 MET, \geq 5 MET) and BMI (BMI <22.5 kg·m² or BMI \geq 22.5 kg·m²) the Unfit/High BMI group had the highest concentrations of IL-6 and TNF- α than the other groups. There was no significant difference in IL-6 and TNF- α between the Fit/High BMI and Fit/Normal BMI groups. These findings suggest that inflammatory markers are increased in obese children and that CRF attenuates this association. Furthermore, TNF- α values were significantly higher in the unfit children independent of BMI demonstrating the importance of CRF rather than obesity in reducing this marker of inflammation.

Sedentary Behaviour, inflammation and endothelial function biomarkers in children

In 164 healthy 7-10 year old children, Gabel *et al.*, (2015) found that each additional hour per week of TV viewing was associated with 4.4% increase in hsCRP and 0.6% increase in sVCAM-1 after adjustment for sex, waist circumference, MVPA and diet (Gabel et al., 2015). There was no association between total sedentary time and markers of inflammation and endothelial dysfunction. Furthermore, there was no significant relation between sedentary bouts between 5-10 min or >10 min and any of the markers of inflammation and endothelial dysfunction. Self-reported TV viewing time but not

objectively measured sedentary time, was found to be positively associated with sICAM-1, sVCAM-1, L-selectin and E-selectin concentrations, after controlling for sex, age, pubertal status, MVPA, BMI and total sedentary time in 183 adolescents aged 13 to 17 years (Martinez-Gomez et al., 2012). In addition, those that watched TV for ≥ 3 h per day had significantly higher concentrations of cellular adhesion molecules compared to those who watched TV for ≤ 1 h per day.

Saunders *et al.*, (2013) compared the effect of 8 h of uninterrupted sitting (SIT), 8 h of sitting interrupted with a 2 min light intensity walk every 20 min and 8 h of sitting interrupted with a 2 min of light intensity walk break every 20 min as well as 2 x 20 min of MVPA on circulating levels of insulin, glucose, TG, HDL-C and LDL-C in 11 healthy males and 8 healthy females aged 10-14 years. There was no significant difference in CMD risk factors across the three experimental conditions (Saunders et al., 2013). Of the limited studies that have examined the relation between sedentary behaviour, the majority have reported a positive relation between sedentary behaviour and inflammatory makers in children. However, these studies used self-reported measures such as TV viewing time to assess sedentary behavior. More objective measures of sedentary behaviour are required to further investigate the association between sedentary behaviour and inflammation in children and adolescents.

Cardiorespiratory Fitness

Cardiorespiratory fitness (CRF), also termed cardiovascular fitness or aerobic

capacity, is the ability to perform large-muscle, whole-body exercise at moderate to high intensities (Saltin et al., 1973). It reflects the overall ability of the cardiovascular and respiratory systems to support skeletal muscle activity through high rates of aerobic metabolism (Pate et al., 2012). Low CRF levels are associated with an increased risk of CVD (Blair et al., 1989, Sandvik et al., 1993), certain site specific cancers (Lee et al., 2002, Breithaupt et al., 2012, Peel et al., 2009) and premature mortality from all causes (Blair et al., 1989, Blair et al., 1995).

Determinants of Cardiorespiratory Fitness

Although information on the role of the genotype on CRF is limited, findings from the HERITAGE family study involving 700 healthy, sedentary men and women found that approximately 50% of the intra-individual variance in CRF was explained by genetic factors (Bouchard et al., 1999, Rankinen et al., 2010). Maximal aerobic capacity values are generally attained between the ages of 20-30 years, (Fleg et al., 2005, Jackson et al., 2009) after which they begin to decline at a rate of 3% to 6% per decade during the third and fourth decades and 20% per decade after 70 years in both healthy men and women (Fleg et al., 2005). Age associated decreases in PA and increases in weight gain exacerbate the process (Fleg et al., 2005).

Measurement of Cardiorespiratory Fitness

CRF is usually expressed in metabolic equivalents (METs) or maximal oxygen uptake ($\dot{V}O_2\text{max}$) measured during exercise testing. Maximal oxygen consumption ($\dot{V}O_2\text{max}$)

attained during a graded maximal exercise test is considered the gold standard measurement of CRF and represents the integrated capacity of the pulmonary, cardiovascular and muscle systems to uptake, transport and utilize oxygen, respectively (Poole et al., 2008). It reflects the exercise intensity beyond which $\dot{V}O_2$ fails to increase further. This leveling off or plateau in oxygen uptake with increasing workload during the final minute of exercise has been used as the primary criterion for determining $\dot{V}O_2$ max (Taylor et al., 1955). However, a number of other secondary criteria are used to verify attainment of $\dot{V}O_2$ max. In children and adolescents, these include respiratory exchange ratio (RER) > 1.0, heart rate (HR) >200 bpm and volitional fatigue (Breithaupt et al., 2012).

Maximal oxygen consumption can be expressed as the absolute volume of oxygen consumed per unit of time ($L \cdot \text{min}^{-1}$) or relative to body mass ($\text{ml} \cdot \text{kg}^{-1} \cdot \text{min}^{-1}$). It can be measured directly from expired gas analysis or estimated through various maximal or submaximal laboratory and field-based exercise tests. The most commonly used laboratory tests include treadmill walking and/or running and cycle ergometry. Commonly used field-tests for estimating CRF include distance or timed runs and graded paced shuttle run tests.

The 20 MST developed by Leger *et al.*, (1988) is a commonly employed field test for estimating CRF in youth. The test consists of a number of 1 min stages called levels and comprises of a number of 20 m laps, called shuttles. The participants running velocity is controlled by an audio “bleep” which signals the completion of a stage. Stage 1 starts at a speed of $8.0 \text{ km} \cdot \text{h}^{-1}$, stage two starts at $9.0 \text{ km} \cdot \text{h}^{-1}$ after which the speed increases by $0.5 \text{ km} \cdot \text{h}^{-1}$ at the end of each stage (Léger et al., 1988) . The test has excellent validity and

reliability for measuring CRF in youth (Léger et al., 1988, Boreham et al., 1990). In youth, performance in the 20MST is more highly correlated with both relative $\dot{V}O_2$ max and CVD risk factors than field based measures such as the 12-min Cooper run and 1.5 mile run (Pate et al., 2012). Improved performance in the 20 MST in children and adolescents is also associated with improvements in a number of CVD risk factors including BP, insulin resistance and body weight (Reed et al., 2008, Puder et al., 2011, Kim et al., 2005).

Cardiorespiratory Fitness and All-cause and CVD Mortality

Epidemiological studies have found an inverse relation between CRF and both all-cause and CVD mortality in both asymptomatic men and women independent of other conventional risk factors (Blair et al., 1989, Gulati et al., 2003, Kokkinos et al., 2008). In an epidemiological study involving 40,451 men and 12,831 women ranging in age from 20 to 100 years, Blair *et al.*, (1989) found that men and women in the highest quintile for CRF had a 43% and 53% lower risk for all-cause mortality and a 47% and 70% lower risk of CVD mortality, respectively (Blair et al., 1989).

In addition to healthy individuals, high levels of CRF in individuals with CVD risk factors including overweight, obesity, MetS, and diabetes mellitus have been found to be cardioprotective, and largely negate the adverse effects of traditional risk factors on subsequent CVD and mortality (Blair et al., 1996, Lysterly et al., 2008, Lysterly et al., 2010, Church et al., 2004). In these studies, individuals with CVD risk factors and high levels of CRF had lower mortality than those with CVD risk factors and low levels of CRF.

Improvements in exercise capacity have been associated with substantial reductions in CVD and all-cause mortality in both healthy asymptomatic (Gulati et al., 2003, Lee et al., 2011, Kodama et al., 2009) and clinical populations (Meyer et al., 2002). A recent-meta analysis of 33 studies found that a 1 MET increase in CRF was associated with a 13% reduction in all-cause mortality and a 15% reduction in CV events (Kodama et al., 2009). In addition, individuals with low CRF had a significantly higher risk of all-cause mortality and CVD events than individuals with moderate and high CRF. A small increase in CRF in individuals in the lowest CRF quintile was associated with a substantial reduction in CVD events and all-cause mortality (Kodama et al., 2009). Similarly, Lee *et al.*, (2011) found that a 1 MET increase in CRF between two examinations separated by an average of 6.9 years was associated with a 15% reduction in all-cause and a 19% reduction in CVD mortality (Lee et al., 2011). A major limitation of these epidemiological studies is the use of a single baseline CRF measurement.

A number of prospective studies in men have found an inverse association between changes in CRF and mortality risk (Blair et al., 1995, Erikssen et al., 1998). Blair *et al.*, (1995) measured CRF on two occasions over a period of 4.9 years in almost 10,000 healthy and unhealthy men aged 20-82 years who were followed for an average of 5.1 years (Blair et al., 1995). Men who improved their CRF classification from unfit to fit between the two examinations had a 44% reduction in mortality risk compared to men who remained unfit at both visits. Individuals who had a low level of CRF on both visits had the highest risk of mortality compared to men who had a high level of CRF at both visits. Each one-minute

increase in maximal treadmill time performance was associated with a 7.9% reduction in mortality risk (Blair et al., 1995). Improvements in CRF over a 7 year period in 2014 healthy men who were 40-60 years of age at baseline was associated with a significantly lower risk of all-cause mortality during a 15 year up follow-up, regardless of the initial CRF level and independent of changes in body weight (Erikssen et al., 1998).

Findings from studies in adults regarding the relative contributions of CRF and obesity to mortality are equivocal. Some studies have found that CRF eliminates the detrimental effects of obesity on mortality (Lee et al., 1999, Sui et al., 2007, McAuley et al., 2010) while others have found that although high CRF can substantially ameliorate the risk of obesity, it cannot eliminate it (Stevens et al., 2004).

Mechanisms linking CRF and Reduction in All-Cause and CVD mortality

Putative biological mechanisms proposed to explain the positive effect of CRF on both all-cause and CVD mortality include the direct effect of CRF on the vasculature or indirectly through risk factor modification. Improvements in CRF that accompany regular exercise training are associated with enhanced endothelial vasomotor function. Repetitive increases in vascular wall shear stress during exercise are associated with an increased up-regulation of eNOS expression (Green et al., 2004). This subsequently increases the synthesis and release of NO and improves endothelial function. Exercise induced improvements in endothelial function may also be mediated through CVD risk factor modification (Kingwell et al., 1996).

Risk Factor Modification

Studies in adults have found that improvements in CRF are associated with improvements in insulin sensitivity (Leite et al., 2009), blood lipid and lipoprotein profile (Arsenault et al., 2007), body composition (Arsenault et al., 2007), inflammation (Aronson et al., 2004, Church et al., 2002, Kuo et al., 2007) and BP (Carnethon et al., 2005). In addition, others (LaMonte et al., 2005, Hassinen et al., 2008) have shown an inverse association between CRF and the risk of developing MetS in adults.

Cardiorespiratory Fitness and CVD risk in Youth

High levels of CRF are associated with a more favorable cardiovascular health profile in children (Ruiz et al., 2007, Ekelund et al., 2007, Anderssen et al., 2007). A number of studies have examined the relation between CRF and CVD risk factors in children and adolescents (Table 2.7). Some of these studies have examined this relation independent of adiposity (Shaibi et al., 2005, Ekelund et al., 2007, Rizzo et al., 2007) while others have failed to take adiposity into account (Andersen et al., 2007, Ruiz et al., 2007, Bailey et al., 2012). Of these studies, some have found a relation between CRF and CVD risk independent of adiposity (Ekelund et al., 2007, Ruiz et al., 2007, Eisenmann et al., 2007) while others have failed to find a significant relation between CRF and CVD risk factors independent of adiposity (Shaibi et al., 2005, Rizzo et al., 2007) (Table 2.7) suggesting that the association between CRF and CVD risk in children and adolescents may be mediated by adiposity.

Andersen *et al.*, (2007) examined the relation between CRF and clustered CVD risk in a large sample of boys and girls between the age of 9 and 15 years and found that after adjusting for country, age, sex, socio-economic status, pubertal stage, family history of CVD and diabetes there was a significant inverse relation between estimated $\dot{V}O_2\text{max}$ expressed relative to body mass and the clustering of CVD risk factors. Compared to those in the highest quartile for CRF, the odds ratio for the clustering of metabolic risk factors was 10.4 for girls and 15.8 for boys in the lowest CRF quartiles (Anderssen *et al.*, 2007). Similarly, Ruiz *et al.*, (2007) examined the association between CRF and cardiometabolic disease (CMD) risk factor clustering in 873 children aged 9 and 15 years and found that the CRF level associated with low metabolic risk classification was $37.0 \text{ ml}\cdot\text{kg}^{-1}\cdot\text{min}^{-1}$ and $42.1 \text{ ml}\cdot\text{kg}^{-1}\cdot\text{min}^{-1}$ in 9-10 year old boys and girls, respectively (Ruiz *et al.*, 2007). Using health related CRF threshold values proposed by Ruiz *et al.*, Bailey *et al.*, (2012) found that CMD risk was significantly higher in unfit compared to fit boys and girls aged 10-14 years and that CRF was inversely associated with clustered CMD risk (Bailey *et al.*, 2012)

To date, only one published study has examined the association between directly measured $\dot{V}O_2\text{max}$ and CVD risk factors in children and adolescents (Shaibi *et al.*, 2005). The relation between $\dot{V}O_2\text{max}$ and MetS was examined in 11-year-old overweight Latino boys and girls with a family history of T2DM (Shaibi *et al.*, 2005). MetS was defined as having three or more of the following risk factors; abdominal obesity, high BP, low HDL-C, high TG and impaired glucose tolerance. Absolute $\dot{V}O_2\text{max}$ was not significantly correlated with any of the MetS risk factors after adjusting for gender, age, total fat mass and fat free mass.

Furthermore, there was no significant difference in absolute $\dot{V}O_2$ max values between children with no risk factors or those with one, two, three or more risk factors. In contrast, $\dot{V}O_2$ max expressed relative to both body mass and fat free mass (FFM) decreased as the number of risk factors for MetS increased. Children with no MetS risk factors had a significantly higher $\dot{V}O_2$ max relative to body weight and FFM than those with two, three or more MetS risk factors (Shaibi et al., 2005). These findings suggest that the relation between CRF and cardiometabolic health is a function of body composition.

As part of the European Youth Heart Study, Ekelund *et al.*, (2007) examined the association between CRF with CVD risk factors in boys and girls between the age of 9 and 10 years and 15 and 16 years and found that CRF estimated from an incremental cycle ergometer test was significantly associated with clustered risk and remained independently associated after adjustment for adiposity (Ekelund et al., 2007). In contrast, after controlling for body fat, Rizzo *et al.*, (2007) found no significant association between CRF estimated from a cycle ergometer test and metabolic risk score in boys and girls between the age of 9 and 15 years (Rizzo et al., 2007).

As part of the Aerobics Center Longitudinal Study, Eisenmann *et al.*, (2007) investigated differences in CVD risk factors across four cross-tabulated groups of CRF and BMI (HF/Low BMI, LF/Low BMI, HF/High BMI and LF/High BMI) in 16 year old boys and girls (Eisenmann et al., 2007). The HF/Low BMI boys had significantly lower TC, LDL-C and TC: HDL-C values than LF/High BMI boys. The LF/Low BMI males had a lower SBP and mean arterial pressure than both HF/High BMI and LF/High BMI males. LF/High BMI females had

higher TG levels than their LF/Low BMI counterparts. In both males and females, the LF/High BMI groups had the highest MetS score. In males, MetS score for HF/Low BMI and LF/Low BMI group were similar suggesting body fatness may be more associated with MetS than CRF. While inherent differences exist in the findings between studies, it would appear that the association between CRF and CVD risk in children and adolescents appears to be mediated in part by adiposity.

Table 2.7: Cross-sectional studies examining the relation between CRF and clustering of cardiometabolic disease risk factors in healthy children and adolescents

Author	Cohort	Measurement of CRF	Measure of Clustered Metabolic risk	Confounders adjusted for	Findings
Shaibi <i>et al.</i> , (2005)	n (m/f)=91/72 Age: 11 yr	Maximal TTM $\dot{V}O_2\text{max}$ ($\text{L}\cdot\text{min}^{-1}$) $\dot{V}O_2\text{max}$ ($\text{ml}\cdot\text{kg}^{-1}\cdot\text{min}^{-1}$) $\dot{V}O_2\text{max}$ ($\text{ml}\cdot\text{kg}^{-1}\cdot\text{FFM}^{-1}\cdot\text{min}^{-1}$)	WC, TG, HDL-C, BP, fasting glucose, No. of components of the MetS (0,1, 2 or ≥ 3)	Sex, age, fat mass and FFM	No association between $\dot{V}O_2\text{max}$ ($\text{L}\cdot\text{min}^{-1}$) and number of MetS risk factors. $\dot{V}O_2\text{max}$ ($\text{ml}\cdot\text{kg}^{-1}\cdot\text{min}^{-1}$) and $\dot{V}O_2\text{max}$ ($\text{ml}\cdot\text{kg}^{-1}\cdot\text{FFM}^{-1}\cdot\text{min}^{-1}$) inversely associated with number of risk factors ($p<0.001$)
Ekelund <i>et al.</i> , (2007)	n (m/f)= 838/908 Age: 9 yr and 15 yr	Maximal CE test ($\text{W kg FFM}^{-1}\cdot\text{min}^{-1}$)	WC, BP, glucose, insulin HDL-C, TG zMS, non-Ob zMS	Sex, age, study location, birth weight, pubertal status, smoking, maternal BMI, parental SES, PA, waist circumference (when zMS is the outcome)	Significant associations between zMS and CRF and between non-OB zMS and CRF
Rizzo <i>et al.</i> , (2007)	n (m/f)= 264/265 Age: 9 yr and 15 yr	Maximal CE test (estimated $\text{ml O}_2\cdot\text{kg}^{-1}\cdot\text{min}^{-1}$)	Insulin, glucose, TG, TC, HDL-C, BP, sum of skinfolds zMS, non-OB zMS	Pubertal status, height, SES and parental smoking and PA	CRF inversely associated with zMS in 9 and 15 year old girls and boys. No association between non-OB zMS and CRF in 9-year-old boys and girls. Inverse association between non-OB zMS and CRF in 15 year old girls and boys

Ruiz <i>et al.</i> , (2007)	n (m/f)=429/444 Age: 9-10 yr	Maximal CE test (estimated ml O ₂ ·kg ⁻¹ ·min ⁻¹)	Insulin, glucose, HDL-C, TG, skinfolds, BP, zMS <75 th percentile= lower risk			Inverse association between CRF quartiles with zMS. Girls CRF > 37 ml O ₂ ·kg ⁻¹ ·min ⁻¹ increased OR of a low zMS score compared to girls ≤ 37 ml O ₂ ·kg ⁻¹ ·min ⁻¹ . Boys CRF > 42.1 ml O ₂ ·kg ⁻¹ ·min ⁻¹ increased OR of a low zMS score compared to boys < 42.1 ml O ₂ ·kg ⁻¹ ·min ⁻¹
Anderssen <i>et al.</i> , (2007)	n=(m/f) 1391/1454 Age: 9 and 15 years	Maximal CE test (W kg)	TC: HDL-C, sum of 4 skinfolds, SBP, TG, HOMA, zMS, non-Ob zMS	Pubertal status, SES, family history if CVD and diabetes, country, age and sex		OR (ascending quartiles of fitness) for having risk 13.0, 4.8 and 2.5. Similar association when age, group sex and country where adjusted
Eisenmann <i>et al.</i> , (2007)	n=(m/f) 296/188 Age: 8-18 yr	Maximal TTM (min)	Glucose, MAP, HDL-C, TG, WC, zMS	Age standardized BMI and CRF		In both males and females, no significant difference in zMS between high fit/low BMI and low fit/low BMI
Bailey <i>et al.</i> , (2012)	n=(m/f) 41/59 Age: 10-14	Maximal CE (estimated ml O ₂ ·kg ⁻¹ ·min ⁻¹)	WC, BP TC: HDL-C ratio, TG'S, glucose	Age, sex, ethnicity, and socioeconomic status		Clustered CMD risk significantly higher in unfit than fit boys and girls. CRF was inversely associated with clustered CMD risk.

CE, cycle ergometer; TM, treadmill; CMD, cardiometabolic disease; FFM, fat free mass; zMS, standardized metabolic risk score; non-Ob zMS, standardized metabolic risk score excluding adiposity; OR, odds ratio; MetS, metabolic syndrome; SES, socioeconomic status; m/f, male/female; MAP, mean arterial pressure; MetS, metabolic syndrome; WC, waist circumference; TC: HDL-C, total cholesterol HDL-C ratio, HOMA; homeostasis model assessment; TG, triglycerides; TC, total cholesterol; BP, blood pressure

Cardiorespiratory Fitness Classification in Youth

A number of cut-off values for optimal CRF values for cardiometabolic health in youth have been proposed (Table 2.8). Ruiz *et al.*, (2007) found that a CRF level of $> 37.0 \text{ ml}\cdot\text{kg}^{-1}\cdot\text{min}^{-1}$ and $> 42.1 \text{ ml}\cdot\text{kg}^{-1}\cdot\text{min}^{-1}$ in adolescent girls and boys respectively, was associated with an increased odds ratio of having a lower metabolic risk (Ruiz *et al.*, 2007). In another sample of 4500 children, CRF values of $< 37.4 \text{ ml}\cdot\text{kg}^{-1}\cdot\text{min}^{-1}$ and $< 33.0 \text{ ml}\cdot\text{kg}^{-1}\cdot\text{min}^{-1}$ were used to identify 9 and 15 year old girls at metabolic risk. Higher cut-off values of $< 43.6 \text{ ml}\cdot\text{kg}^{-1}\cdot\text{min}^{-1}$ and $< 46.0 \text{ ml}\cdot\text{kg}^{-1}\cdot\text{min}^{-1}$ were used to identify 9 and 15 year old boys, at metabolic risk (Adegboye *et al.*, 2011). Similarly, Lobelo *et al.*, (2009) found that optimal CRF values for identifying children with high CVD risk was $< 44.1 \text{ ml}\cdot\text{kg}^{-1}\cdot\text{min}^{-1}$ and $< 40.3 \text{ ml}\cdot\text{kg}^{-1}\cdot\text{min}^{-1}$ in 12-15 year old and 16-19 year old boys, respectively, and $< 36.0 \text{ ml}\cdot\text{kg}^{-1}\cdot\text{min}^{-1}$ and $< 35.5 \text{ ml}\cdot\text{kg}^{-1}\cdot\text{min}^{-1}$ among 12-15 and 16-19 year old girls, respectively (Lobelo *et al.*, 2009). These optimal CRF were similar to age and gender-specific CRF values for adolescents known as healthy zones proposed by FITNESSGRAM (The Cooper Institute for Aerobic Research, 2004).

Table 2.8: Proposed CRF classification in children and adolescents

Author	Cohort	Measure of CRF	Proposed optimal CRF values
Ruiz <i>et al.</i> , (2005)	n=873 Age: 9-10 yr	Maximal CE test (estimated ml O ₂ ·kg ⁻¹ ·min ⁻¹)	$\dot{V}O_2\text{max}$ ml·kg ¹ ·min ¹ Males: >42.1 ml·kg ¹ ·min ¹ Females: >37.0 ml·kg ¹ ·min ¹ Associated with an increased odds ratio of having a lower metabolic risk than those with CRF below these levels
Lobelo <i>et al.</i> , 2009	n =1247 Age: 12-18 years	Submaximal TM test (estimated ml O ₂ ·kg ⁻¹ ·min ⁻¹)	$\dot{V}O_2\text{max}$ ml·kg ¹ ·min ¹ Males 12-15 years : <44.1 ml·kg ¹ ·min ¹ Males 16-19 years: < 40.3 ml·kg ¹ ·min ¹ Females 12-15 years : <36.0 ml·kg ¹ ·min ¹ Females 12-15 years : <35.5 ml·kg ¹ ·min ¹ Optimal CRF values for identifying individuals with high risk
Adegboye <i>et al.</i> , (2011)	n=4500	TM test (Estimated ml O ₂ ·kg ⁻¹ ·min ⁻¹)	$\dot{V}O_2\text{max}$ ml·kg ¹ ·min ¹ Males 9 years: <43.6 ml·kg ¹ ·min ¹ Males 15 years: < 46.0 ml·kg ¹ ·min ¹ Female 9 years: <37.4 ml·kg ¹ ·min ¹ Females 15 years: <35.0 ml·kg ¹ ·min ¹ Optimal levels for identifying individuals at high risk

$\dot{V}O_2\text{max}$, maximal oxygen uptake; CRF, cardiorespiratory fitness; CE, cycle ergometer; TTM, treadmill;

Cardiorespiratory Fitness in Adolescence and CVD risk factors in Adulthood

A number of longitudinal studies have examined the relation between CRF in adolescence and CVD risk factors in adulthood (Twisk et al., 2000, Ferreira et al., 2002, Hasselstrom et al., 2002, Andersen et al., 2004, Eisenmann et al., 2005). Maximal oxygen uptake and maximal slope determined from a graded treadmill exercise test in 13-16 males and females were both significantly and inversely related to sum of four skinfolds, waist circumference and total cholesterol at 32 years of age (Twisk et al., 2000). In contrast, Andersen *et al.*, (2004) found no significant relation between $\dot{V}O_2\text{max}$ measured between the age of 16-19 years and adult clustered CVD risk (TC: HDL-C, TG, SBP and body fat) measured 8 years later in males and females (Andersen et al., 2004). Using the top fitness quartile as a reference, the odds ratio at baseline for having ≥ 2 risk factors was 3.1, 3.8 and 4.9 for quartiles two, three and four, respectively. At the second examination the odds ratio was 0.7, 3.5 and 4.9 for quartiles two, three and four, respectively. The probability for “a case” i.e (≥ 2 risk factors) at baseline to be a case at the second examination was 6.0.

In a similar age cohort, Hasslestrom *et al.*, (2002) found that the change in CRF between adolescence and adulthood measured over an 8-year period rather than the level measured in adolescence was more strongly related to both the total number and the changes in CVD risk factors in adulthood (Hasselstrom et al., 2002). The $\dot{V}O_2\text{max}$ score in adolescence was significantly related to $\dot{V}O_2\text{max}$ 8 years later in both men and women and to circulating TG levels and % body fat in women. The change in $\dot{V}O_2\text{max}$ over the 8-year period was related to TC, TG, waist girth, $\dot{V}O_2\text{max}$,

PA, HDL-C and risk score in adult men and TG, PA and percentage body fat in adult women at follow up . There was also a significant relation between changes in $\dot{V}O_2\text{max}$ and changes in TC, TG and HDL-C in men and between the changes in $\dot{V}O_2\text{max}$ and changes in SBP, TG, risk score and % body fat in women.

To examine the relation between both CRF and body fatness during adolescence and CVD risk factors in adulthood, Eisenmann *et al.*, (2005) evaluated CRF and body fat at 15.8 years and again at 26.6 years in 48 men and women (Eisenmann et al., 2005). Adolescent treadmill time was associated with adult BMI, waist circumference and % body fat, and changes in body fat. The change in treadmill time was associated with the change in body fat. There was no significant relation between treadmill time during adolescence and BP, TC, HDL-C, TG and glucose in adulthood. Adolescent waist circumference was significantly related to adult BP. BMI, percentage body fat and waist circumference in adolescence was significantly related to adult treadmill time. Change in waist circumference was significantly related to the change in both treadmill time and HDL-C. The change in BMI was significantly related to the change in both BP and HDL-C. Twisk et al., (2000) measured CRF on 6 occasions between the ages of 13-27 years in 181 individuals and examined the longitudinal relation between CRF and CVD risk factors in adulthood. There was an inverse relation between $\dot{V}O_2\text{max}$ and TC: HDL-C and the sum of four skinfolds in adulthood (Twisk et al., 2000).

Tracking of CVD Risk Factors from Adolescence to Adulthood

Prospective studies have found that CRF tracks better than PA from adolescence into adulthood (Twisk et al., 1997, Kemper et al., 1990, Soric et al., 2014). A recent study tracked CRF and body fatness in 50 individuals from 15 years of age into middle adulthood (37-43 yr) and found that the tracking of $\dot{V}O_2$ peak was low to moderate ($r=0.30$) (Soric et al., 2014). Similarly, Twisk *et al.*, (1997) reported moderate stability ($r=0.31$) for the tracking of CRF over a 15 year period from 13 years to 27 years in 181 apparently healthy individuals (Twisk et al., 1997). Kemper *et al.*, (1990) tracked serum cholesterol, BP, % body fat, $\dot{V}O_2$ max, smoking, PA, type A behaviour in 93 males and 107 females annually between 13 and 21 years of age and found that that CRF had the high stability (Kemper et al., 1990).

Limitations of Maximal Exercise Testing

Cardiopulmonary exercise testing (CPET) is widely used in to assess the response to exercise in both healthy and disease-based populations. Although $\dot{V}O_2$ max is recognized as the gold standard measurement of CRF, a true plateau in $\dot{V}O_2$ during CPET is seldom attained particularly in overweight and obese pediatric populations. The application of $\dot{V}O_2$ max testing may therefore be limited to healthy, trained and motivated individuals. The ability to attain $\dot{V}O_2$ peak during CPET is strongly influenced by the individual's effort, motivation, the experience of the tester and the exercise protocol. Norman *et al.*, (2005) found that 24% of overweight and 12% of normal weight adolescents did not achieve $\dot{V}O_2$ peak during a graded maximal

exercise test (Norman et al., 2005). Furthermore, maximal exhaustive exercise testing does not mimic the submaximal daily activities of children.

Ventilatory Anaerobic Threshold

During incremental exercise, lactic acid, a product of anaerobic glycolysis, readily dissociates into lactate and hydrogen ions. Buffering of the hydrogen ions in the blood by sodium bicarbonate, results in the formation of carbonic acid, which is further broken down into carbon dioxide and water. The disproportionate increase in arterial carbon dioxide production is detected by central and peripheral chemoreceptors, stimulating an increase in pulmonary ventilation. The exercise intensity at which \dot{V}_E increases disproportionately in relation to oxygen consumption during incremental exercise is called the ventilatory anaerobic threshold (VAT) and is a commonly used submaximal measure of CRF.

A number of methods are commonly used to determine the VAT. The V-slope method examines the change in the relation between $\dot{V}CO_2$ and $\dot{V}O_2$. Specifically, it involves identifying the breakpoint in which $\dot{V}CO_2$ begins to increase more rapidly than $\dot{V}O_2$. Alternatively, the ventilatory equivalents method defines VAT as the exercise intensity at which the ventilatory equivalent of oxygen ($\dot{V}_E/\dot{V}O_2$) increases without a concurrent rise in the ventilatory equivalents of carbon dioxide ($\dot{V}_E/\dot{V}CO_2$). A major limitation of the VAT is that its measurement is largely dependent on the exercise protocol and is often not identifiable (Akkerman et al., 2010). Furthermore, the subjective nature of its measurement means that VAT is subject to inter-evaluator variability (Akkerman et al., 2010).

Oxygen Uptake Efficiency Slope

The oxygen uptake efficiency slope (OUES) is an objective and effort independent submaximal measure of cardiopulmonary reserve (Baba et al., 1996). It represents the rate of increase in $\dot{V}O_2$ in response to a given \dot{V}_E during incremental exercise, indicating how effectively oxygen is taken in by the lungs, transported and used in the periphery (Baba et al., 1996). The OUES therefore integrates cardiovascular, musculoskeletal and respiratory function during incremental exercise into a single index (Hollenberg & Tager, 2000). Physiologically, the OUES is influenced by the onset of exercise induced metabolic acidosis which is determined by a variety of factors including blood flow distribution to the working muscles, muscle mass, oxygen extraction and utilization, physiologic pulmonary dead space and the arterial PCO_2 set point (Hollenberg & Tager, 2000).

Calculation of OUES

OUES is derived from the linear relation of $\dot{V}O_2$ (y-axis) versus the logarithm of \dot{V}_E (x-axis) during incremental exercise (Baba et al., 1996). It is calculated using the equation; $\dot{V}O_2 = a \log \dot{V}_E + b$; where $\dot{V}O_2$ represents oxygen uptake ($ml \cdot min^{-1}$), the constant 'a' represents the rate of increase in $\dot{V}O_2$ in response to an increasing \dot{V}_E (OUES), $\log \dot{V}_E$ is the common logarithm of \dot{V}_E and the constant 'b' represents the intercept (figure 2.1) (Bongers, 2013). The logarithm transformation of \dot{V}_E results in the linearization of the relation of $\dot{V}O_2$ versus \dot{V}_E during incremental exercise making the OUES theoretically effort independent (Mezzani et al., 2009). A number of

studies involving both healthy and disease based populations have reported similar maximal

OUES and submaximal OUES values (using 50%-75% of exercise data) calculated from maximal exercise tests indicating that OUES is independent of effort during exercise (Hollenberg & Tager, 2000, Baba et al., 1996, Baba et al., 1999, Davies et al., 2006). OUES is highly reproducible (Baba et al., 1999) and is significantly correlated with other exercise parameters including $\dot{V}O_2\text{max}$ ($r=0.94$), $\dot{V}O_2\text{peak}$ ($r=0.91-0.92$) and VAT ($r=0.86$) (Akkerman et al et al., 2010). Given its strong positive correlation with $\dot{V}O_2\text{max}$ (Baba et al., 1996, Davies et al., 2006, Bongers et al., 2012, Breithaupt et al., 2012), the OUES may be of clinical utility and may be used in addition to, or as a substitute for $\dot{V}O_2\text{max}$ in the assessment of CRF in populations unable to perform maximal exercise.

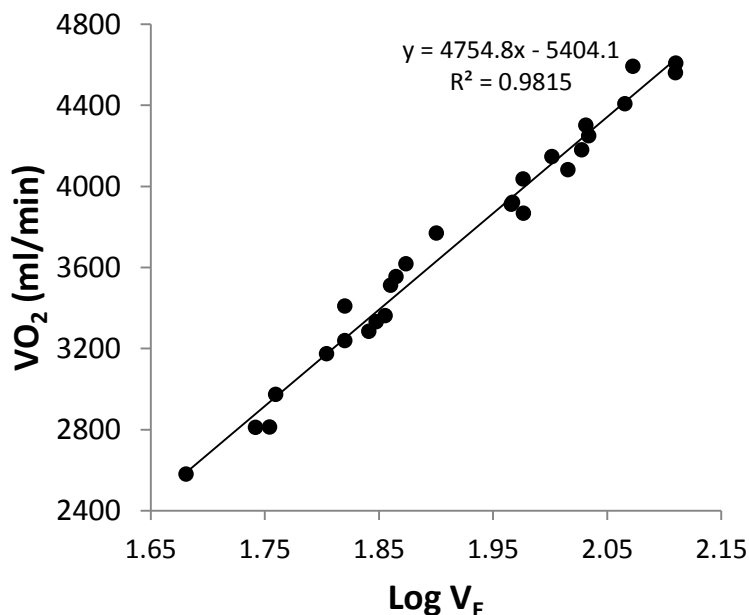

Figure 2.5. Calculation of oxygen uptake efficiency slope (OUES)

Prognostic Value of OUES

OUES has been found to have prognostic value in both CAD (Coeckelberghs et al., 2015) and HF populations (Davies et al., 2006, Arena et al., 2007). In a recent study, Coeckelberghs *et al.*, (2015) assessed the prognostic value of OUES in a large sample of CAD patients with a mean age of 61 years. OUES was calculated in participants who underwent maximal exercise testing at baseline and again at follow-up 7.4 ± 3.2 years later. OUES was significantly related to all-cause (hazard ratio 0.57, $p < 0.001$) and CV mortality (0.46, $p < 0.001$) and remained significantly related to mortality after adjusting for other submaximal exercise parameters (Coeckelberghs et al., 2015). Similarly, a 9 year follow up study in HF patients found that OUES, calculated from maximal treadmill exercise testing was the only significant independent predictor of mortality in multivariate analysis that included both $\dot{V}O_2$ peak and VAT (Davies et al., 2006). Arena *et al.*, (2007) found that OUES calculated from 50% (OUES₅₀) and 100% of the exercise data (OUES₁₀₀) collected during a ramp exercise treadmill test at baseline and 3 years later was a significant predictor of mortality in heart failure patients (Arena et al., 2007).

OUES in children

The utility of the OUES was initially examined in a cohort of healthy children and children with congenital heart disease (Baba et al., 1996) and has since been investigated in both healthy normal weight and overweight/obese children and adolescents (Breithaupt et al., 2012, Drinkard et al., 2007, Marnivov et al., 2007, Marnivov et al., 2003, Akkerman et al., 2010).

To determine if the OUES is independent of effort, a number of studies have compared maximal and submaximal values in children and adolescents. Cross sectional studies involving healthy normal weight children between the age of 7 and 18 years found no difference in submaximal OUES calculated using exercise data up to VAT, and maximal OUES calculated using 100% of the data from the graded exercise test (Akkerman et al., 2010, Marniov et al., 2007). In contrast, Drinkard et al., (2007) reported a significant increase in OUES with increasing exercise intensity in both normal weight and severely overweight 12-17 year old adolescence showing a dependence of OUES on exercise intensity (Drinkard et al., 2007).

Studies in children and adolescents have also shown that the OUES is highly correlated with $\dot{V}O_2$ peak (Akkerman et al., 2010, Marniov et al., 2007). Akkerman *et al.*, (2010) reported that submaximal OUES, calculated using exercise data up to the VAT was highly correlated with $\dot{V}O_2$ peak ($r=0.88$, $p<0.01$) in 46 healthy children and adolescents aged between 7-17 years. The strength of the association however, declined after submaximal OUES was normalized for BSA ($r=0.67$, $p<0.01$), body mass ($r=0.62$, $p<0.01$) and FFM ($r=0.49$, $p<0.01$) (Akkerman et al., 2010). This is not surprising considering that the OUES is significantly related to age and anthropometric variables including height, BSA, weight, FFM and BMI (Akkerman et al., 2010, Marniov et al., 2007). In a similar aged cohort, Marinov *et al.*, (2007) also reported a strong correlation between OUES and $\dot{V}O_2$ peak ($r=0.92$) in 58 and 56 healthy boys and girls respectively (Marinov et al., 2007). Others studies examining the OUES in overweight and obese children and adolescents have also reported a

strong correlation between OUES and $\dot{V}O_2$ peak (Drinkard et al., 2007, Breithaupt et al., 2012).

OUES in overweight/ obese children

A number of studies have compared the OUES in overweight/obese children and adolescents and healthy normal weight age matched controls (Marinov et al., 2003, Breithaupt et al., 2012, Drinkard et al., 2007). Using a maximal cycle ergometer test, Drinkard *et al*, (2007) compared the OUES at the intensity corresponding to the lactate threshold (OUES LT), 150% LT (OUES 150) and $\dot{V}O_2$ peak (OUES peak) in severely overweight 12 to 17 year old adolescents and aged matched non-overweight controls. There was no significant difference between absolute values of $\dot{V}O_2$ peak, OUES peak, OUES LT and OUES 150 between the overweight and normal weight adolescents. $\dot{V}O_2$ peak, OUES peak and OUES LT were significantly higher in the overweight than normal weight controls but when expressed relative to lean body mass, $\dot{V}O_2$ peak, OUES peak, OUES 150 and OUES LT were significantly lower in the overweight than the control group (Drinkard et al., 2007). Similarly, Breithaupt *et al.*, (2012) found that both maximal OUES ($L \cdot \text{min}^{-1}$) and submaximal OUES ($L \cdot \text{min}^{-1}$) values were significantly higher in obese 7-18 year children than healthy normal weight children but were significantly lower in obese children when adjusted for body mass, body surface area (BSA) and FFM (Breithaupt et al., 2012).

In contrast, Marinov *et al.*, (2003) found no significant difference between OUES values in obese 11-year-old children and normal-weight, age, sex and height matched controls during an incremental maximal treadmill test (Marinov et al.,

2003). Obese children had greater $\dot{V}O_{2\text{peak}}$ values ($\text{L}\cdot\text{min}^{-1}$) than the controls, but when normalized for body weight, $\dot{V}O_{2\text{peak}}$, was significantly lower in the obese group than the control group (Marinov et al., 2003). Findings from these studies would indicate that absolute $\dot{V}O_{2\text{peak}}$ values and OUES values are higher in obese children than normal weight children but are lower when expressed relative to anthropometric variables including body mass, BSA and FFM.

Table 2.9: Studies that examined the OUES in healthy and overweight/obese children and adolescents

Author	Cohort	Age	Exercise parameters measured	Measurement of CRF	Findings
Akkerman <i>et al.</i> , (2010)	Healthy N=46 (m/f)=27/19	7-17	Submaximal OUES (data up to VAT), Maximal OUES (100% data from test) VO ₂ peak, VE peak, VAT	Maximal CE test	No difference in submaximal OUES, and maximal OUES OUES sig correlated with $\dot{V}O_2$ peak, VE peak and VT - correlations declined after OUES was normalized for BSA, body mass and FFM OUES was significantly correlated with age height, BSA, weight, FFM and BMI
Marinov <i>et al.</i> , (2007)	Healthy N=114 (m/f)= 58/56	7-18	Submaximal OUES (data up to VT), Maximal OUES (100% data from test) $\dot{V}O_2$ peak, $\dot{V}O_2$ max, RER	Maximal TM test	No sig difference in submaximal OUES, and maximal OUES OUES was significantly correlated with $\dot{V}O_2$ peak OUES was significantly correlated with age height, BSA, weight, FFM and BMI
Drinkard <i>et al.</i> , (2007)	Overweight vs. Healthy N=107 OW m/f=55/52 N=43 healthy m/f=17/26 Age: 8-15	12-17	OUES LT, OUES 150, $\dot{V}O_2$ peak (OUES peak)	Maximal CE test	No sig difference in absolute $\dot{V}O_2$ peak /OUES peak, OUES LT and OUES 150 between groups. $\dot{V}O_2$ peak/OUES peak and OUES LT significantly higher in the overweight than normal weight but when expressed relative to lean body mass, $\dot{V}O_2$ peak /OUES peak, OUES 150 and OUES LT were significantly lower in the overweight than the non-overweight group. OUES at all exercise intensities for both groups were significantly related to

$\dot{V}O_2$ peak. Significant increase in OUES with increasing exercise intensity in both groups

Breithaupt <i>et al.</i> , (2012)	Obese N=56 (m/f)=25/31	7-18	Submaximal OUES (data up to VT), Maximal OUES (100% data from test) $\dot{V}O_2$ peak, VE, VT	Maximal TTM test	Maximal and submaximal OUES were significantly correlated with each other and to $\dot{V}O_2$ peak, VE peak and VT. Following adjustment for BSA and body mass, the relation between both maximal and submaximal OUES and $\dot{V}O_2$ peak, VE and VT was attenuated but remained significant. After adjustment for FFM, this relation was no longer significant.
Marinov <i>et al.</i> , (2003)	Obese vs. healthy n=obese 30(m/f)=15/15 n=healthy 30(m/f) 15/15	11 ± 1.1	Submaximal OUES (data up to VT), Maximal OUES (100% data from test) $\dot{V}O_2$ peak	Maximal TM test	No sig. difference in OUES values between obese and normal-weight controls. Obese children had greater absolute $\dot{V}O_2$ peak than controls but when normalized for body weight, $\dot{V}O_2$ peak, was significantly lower in the obese group than the control group. OUES was strongly correlated with $\dot{V}O_2$ peak and height, BSA, FFM, age, weight and BMI Submaximal OUES and maximal OUES were strongly correlated with each other, with submaximal OUES differing by 1.1% from maximal OUES.

OUES, oxygen uptake efficiency slope; VT, Ventilatory threshold; $\dot{V}O_2$ peak, peak oxygen uptake; VE peak, peak minute ventilation; BSA, body surface area; CE, cycle ergometer; TM, treadmill; sig, significant; BMI, body mass index; LT, lactate threshold; VE, minute ventilation, OUES LT, oxygen uptake efficiency slope calculated up to lactate threshold, OUES peak, oxygen uptake efficiency slope at peak exercise, OUES 100, oxygen uptake efficiency slope calculated using 100% of exercise data; $\dot{V}O_2$ max, maximal oxygen uptake

OUES and Vascular Function

To date, only one published study has investigated the relation between OUES and vascular function (Arena et al., 2009). This study examined the relation between OUES, $\dot{V}O_2\text{max}$ and large artery compliance in healthy middle-age men and women. Aortic wave velocity (AWV) was assessed using magnetic resonance imaging. OUES was calculated using data up to 50% (OUES₅₀) and 100% (OUES₁₀₀) $\dot{V}O_2\text{max}$ determined during an incremental treadmill exercise test. $\dot{V}O_2\text{max}$, OUES₅₀, and OUES₁₀₀ were significantly related to AWV. However, only $\dot{V}O_2\text{max}$ was retained in a linear regression analysis developed to predict aortic wave velocity (Arena et al., 2009).

Physical Activity

Physical activity (PA) is defined as any bodily movement produced by skeletal muscle that results in the expenditure of energy (Caspersen et al., 1985) and can be classified as light intensity PA (LIPA), moderate to vigorous intensity PA (MVPA), and vigorous intensity PA (VPA). LIPA, MVPA and VPA are defined as energy expenditure between 1.6-2.9 METs, 3.0-6.0 METs and >6 METs, respectively (Fisher et al., 2015). Once considered a sedentary behaviour, standing is now also recognized as a PA behaviour due to its positive association with cardiometabolic health, in particular its association with changes in skeletal muscle enzyme lipoprotein lipase (LPL) (Owen, 2010).

Physical Activity Recommendations

The health benefits associated with increased MVPA are well documented (Paffenbarger et al., 1986, Blair et al., 1989, Lee et al., 2012). Current PA guidelines for children and adolescents recommend a minimum of 60 min of accumulated MVPA each day (CDC, 2015). Currently, only 19% of Irish primary school children and 12% of post primary students meet these recommendations (Woods et al., 2010). It has been suggested that recommendations for LIPA be included in PA guidelines as this behaviour accounts for the majority of daily energy expenditure rather than MVPA, and may therefore be more attainable (Levine et al., 2006, Owen et al., 2010).

Measurement of Physical Activity

PA can be measured subjectively using self-reported techniques including questionnaires, diaries and proxy reports. It can also be objectively measured using motion sensors including pedometers and accelerometers (Troost, 2007). Self-report is the most utilized measurement of PA because of low cost and low participation burden (Troost, 2007). The validity of self-reported PA measurements in children and adolescents varies significantly across validation methodology and measurement protocol (Troost, 2007, Sallis & Saelens, 2000). The major limitations of self-report measures of PA include recall bias and their unsuitability for use in children under-10 years of age (Troost, 2007).

Accelerometry is currently the most commonly used objective method for measuring PA (Troost, 2007, Reilly et al., 2008). It measures the acceleration of an

object relative to free fall and the output generated produces accelerometer/activity counts. These accelerometer counts provide an objective measure of movement intensity (Troost, 2007). The advantages associated with the use of accelerometry measured PA include their small size, robust design, modest cost and their ability to measure intensity, frequency and duration of PA (Troost, 2007). Limitations include positioning of the monitor, compliance, output analysis and the inability to measure PA during inclined activities such as stair-walking and during water based activities, upper body exercises and cycling (Troost, 2007). In children and adolescents, moderate to high correlations have been found between activity counts generated by accelerometry and energy expenditure using indirect calorimetry (Troost et al., 2005, Freedson et al., 2005).

Physical Activity and CVD risk factors in Children and Adolescents

A number of studies have examined the independent association between objectively measured PA and the clustering of CMD risk factors in healthy children and adolescents (Table 2.10) (Ekelund et al., 2006, Rizzio et al., 2007). As part of the European Youth Heart Study, Andersen *et al.*, (2006) examined the association between objectively measured PA and clustering of CMD risk factors in 9 to 15 year old boys and girls (Andersen et al., 2006). The risk factors included in the clustered CVD risk score were SBP, TG, TC: HDL-C, insulin resistance, sum of four skinfolds and CRF. There was a graded inverse relation between PA quintiles and clustered CVD risk after adjusting for age and gender. The highest CVD risk was found in the lowest three PA quintiles. The odds ratio for the presence of clustered CVD risk for

ascending quintile of PA was 3.29, 3.13, 2.51 and 2.03 compared to the most active quintile.

After adjusting for confounders including adiposity and CRF, Ekelund *et al.*, (2006) found a significant association between total minutes spent in PA and clustered CVD risk score in 9 to 10 and 15 to 16 year old boys and girls (Ekelund *et al.*, 2006). In similar aged cohorts, Ekelund *et al.*, (2007) also found that total time in PA, and the time in LIPA, MPA, and VPA was significantly associated with CVD risk score in both boys and girls. The association between total time in PA and clustered CMD risk score remained unchanged after adjusting for waist circumference and CRF adiposity. The same study found no independent association between CRF and CVD risk score suggesting that PA is more strongly related to CVD risk in children and adolescents. In contrast, after adjustment for CRF and body fat, Rizzo *et al.*, (2007) did not find an independent association between total and VPA and either clustered CVD risk score in 9 and 15 year olds boys and girls (Rizzo *et al.*, 2007). In contrast to Ekelund *et al.*, (2007) this study found that CRF was more strongly related to clustered CVD risk than PA.

Others have also found no associated between time spent in LIPA, MVPA and VPA and total time in PA and clustered CMD risk in healthy 9 year old (Brage *et al.*, 2004) and 10-14 year old children, respectively (Bailey *et al.*, 2012) after controlling for confounders including age, sex, ethnicity, socioeconomic status (Bailey *et al.*, 2012), sexual maturation and adiposity (Brage *et al.*, 2004).

Table 2.10: Cross sectional studies that examined the relation between objectively measured PA and clustered metabolic risk factors in children and adolescents

Author	Cohort	Measurement of PA	Measure of Clustered Metabolic risk	Confounders adjusted for	Findings
Andersen <i>et al.</i> , (2006)	n (m/f)=817/915 Age: 9 and 15 yr	Uni-axial Accelerometer > 3 days Total PA	SBP, TG, TC-HLC-C, HOMA, sum of 4 skinfolds, CRF zMS	Age, sex, country	OR for having clustered risk for ascending quartiles of total PA were 3.29, 3.13, 2.51 and 2.03 respectively compared with the most active quintile
Ekelund <i>et al.</i> , 2007	n (m/f)= 838/908 Age: 9 yr and 15 yr	Uni-axial accelerometer ≥ 3days, TPA, LIPA, MPA and VPA (min/day)	WC, BP, glucose, insulin HDL-C, TG zMS, non-Ob zMS	Sex, age, study location, birth weight, pubertal status, smoking, maternal BMI, parental SES, CRF and adiposity (when non-Ob zMS is the outcome)	Significant associations between zMS and total physical activity, LIPA, and VPA. Significant associations for non-Ob zMS and total PA, LIPA, MPA and VPA
Rizzo <i>et al.</i> , (2007)	n (m/f)= 264/265 Age: 9 yr. and 15 yr.	Uni-axial accelerometer ≥ 3days, TPA, MPA, VPA and MVPA (min/day)	Insulin, glucose, TG, TC, HDL-C, BP, sum of skinfolds zMS, non-OB zMS	Pubertal status, body height, SES and parental smoking, age, gender and CRF	Total PA inversely associated with zMS and non-zMS in 15-year-old girls. No significant association between total PA and zMS or no-Ob zMS for all other age and sex

groups. MPA, VPA and MVPA all associated with with non-OB zMS in 15-year-old adolescents only (results for zMS not reported. When CRF was adjusted for, total PA was not associated with zMS or non-Ob zMS in any group. MPA, VPA and MVPA not associated with non-Ob zMS (results for zMS not reported)

Ekelund <i>et al.</i> , (2006)	n (m/f)=911/1010 Age: 9 and 15 yr	Uni-axial Accelerometer > 3 days Total PA	BMI, sum of skinfolds, BP glucose, HDL-C, TG, insulin zMS, non-Ob zMS	Sex, age, study location, birth weight, maturity, smoking, parental SES, CRF (and adiposity when outcome non-Ob zMS)	Inverse association total PA and zMS and non-ob zMS
Brage <i>et al.</i> , (2004)	n=(m/f) 279/310 Age: 9 and 15 yr	Uni-axial Accelerometer > 3 days Total PA	BP, sum of 4 skinfolds, insulin, glucose, TG and HDL-C zMS, non-ob zMS	Age, sex sexual maturation, ethnicity, parental smoking, SES (and adiposity when outcome non-Ob zMS)	Total PA inversely related to zMS and non-Ob zMS

Bailey <i>et al.</i> , (2012)	n=(m/f) 41/59 Age: 10-14	Tri-axial Accelerometer 3days LIPA, MVPA and VPA	>	WC, BP, TC: HDL-C ratio, TG, glucose	Age, sex, ethnicity, and socioeconomic status	No association between spent in LIPA, MVPA and VPA and clustered CMD risk
-------------------------------	-----------------------------	---------------------------------------------------------------	---	-----------------------------------------	-----------------------------------------------------	------------------------------------------------------------------------------------

PA, physical activity; m/f, male/female; LIPA, light intensity physical activity; MVPA, moderate intensity physical activity; VPA, vigorous intensity physical activity ;CMD, cardiometabolic disease; zMS, standardized metabolic risk score; non-Ob zMS, standardized metabolic risk score excluding adiposity; OR, odds ratio; SES, socioeconomic status; CRF, cardiorespiratory fitness; WC, waist circumference; TC: HDL-C, total cholesterol HDL-C ratio, HOMA; homeostasis model assessment; TG, triglycerides; TC, total cholesterol; BP, blood pressure

Physical Activity in Adolescence and CVD risk factors in Adulthood

In contrast to studies that found a significant inverse association between CRF during adolescence and CVD risk factors in adulthood (Twisk et al., 2000, Ferreira et al., 2002, Hasselstrom et al., 2002, Andersen et al., 2004, Eisenmann et al., 2005), a number of prospective studies have found no association between PA during childhood and adolescence and CVD risk factors in adulthood (Boreham et al., 2002, Hasselstrom et al., 2002, Lefevre et al., 2002). The relation between PA at 12 and 15 years of age and CVD risk factor profile in young adulthood (mean age 22.5 years) was examined as part of the Northern Ireland Young Hearts Project. No significant relation was found between self-reported PA during adolescence and TC, HDL-C, TC:HDL-C, SBP, DBP and the sum of four skinfolds in young adulthood (Boreham et al., 2002). Similarly, Hasselstrom *et al.*, (2002) found no association between PA levels measured during adolescence and CVD risk score in adulthood. However, PA in males during adolescence was significantly related to waist girth and TG levels in adulthood. A significant relation was found between the changes in PA and CVD risk factors. No association was found between PA levels at 13-18 years of age and CVD risk factors at 40 years in the Leuven Longitudinal Study on Lifestyle, Fitness and Health (Lefevre et al., 2002). PA levels measured during childhood and adolescence are not associated with CVD risk factors in adulthood. CRF level obtained during adolescence is more predictive of CVD health profile in adulthood.

Tracking of Physical Activity

In terms of physical activity, tracking refers to the tendency of individuals to maintain their relative PA level rank over time (Malina, 1996). The majority of studies that have tracked PA from childhood to adolescence have used self-reported measures and have reported consistently low to moderate tracking of PA (Janz et al., 2000, Mc Murray et al., 2003, Pate et al., 1999). Studies that have tracked PA between the ages of 11-42 years, 8-34 years and 9-30 years using self-reported measures have reported correlations of ranging from 0.03 to 0.35 (Parson et al, 2006) (Telema et al., 2005). In one of the relatively few studies to track objectively measures PA using, Kristensen *et al.*, (2008) found that the tracking of PA was very low, but increased when the coefficients were adjusted for random error due to day to day variation and within instrumental measurement error (Kristensen et al., 2008).

Sedentary Behaviour

Sedentary behaviour describes activities that do not substantially increase energy expenditure above the resting level of approximately 1.0 MET (Pate et al., 2008). Such activities include sleeping, sitting and lying (Sedentary Behaviour Research Network, 2012). Sedentary behaviour is distinct to physical inactivity which refers to the lack of engagement in leisure time PA or failure to meet daily PA recommendations (Pate et al., 2008). Epidemiological evidence has demonstrated that engagement in prolonged periods of sedentary behaviours can have negative effects on metabolic health, even in adults who meet the daily PA recommendations (Owen et al., 2010). Such observations have led to the emergence of sedentary

behaviour as a distinct risk factor for CVD and all-cause mortality independent of PA levels.

Measurement of Sedentary Behaviour

Similar to PA, sedentary behaviour can be assessed using a variety of self-report measures or objective measures such as accelerometers. While the Actigraph GT1M and GT3X are valid measures of PA, their measurement of sedentary behaviour is based on thresholds (Dowd et al., 2012). A threshold of 100 counts per min is most commonly used to discriminate between sedentary behaviour and LIPA (Pate et al., 2008). The use of such thresholds may not accurately calculate sedentary time as it has been suggested that their analysis may include other activities such as standing (Owen et al., 2010). This limitation in their use has led to the development of Inclinometer based activity monitors that can distinguish between sitting and standing and are therefore a more accurate measure of sedentary behaviour in children and adolescents (Dowd et al., 2012, Aminian & Hinckson, 2012). The ActivPAL Professional Physical Activity Monitor (PAL Technologies Ltd., Glasgow, UK) is a tri-axial accelerometer with an inbuilt inclinometer that can distinguish between changes in posture in addition to the examination of ambulation (Dowd et al., 2012). As a result, its use in the examination of total sedentary time in addition to more detailed variables of sedentary behaviours including breaks in sedentary time and sedentary bout duration has been recommended (Bassett Jr et al., 2010).

Sedentary Behaviour and Cardiometabolic Health

Sedentary behaviour has emerged as a distinct risk factor for CVD and premature mortality, independent of PA (Owen et al., 2010). For example, self-reported television viewing time is positively associated with an increased risk of cardiovascular and all-cause mortality (Dunstan et al., 2010, Grøntved & Hu, 2011, Katzmarzyk et al., 2009).

Using a rodent model, Bey and Hamilton (2003) compared the effect of acute, (12 h) and chronic, (10 h·d⁻¹ for 11 days) hind limb unloading on heparin-releasable LPL activity to ambulating controls (Bey & Hamilton, 2003). LPL activity was significantly reduced after 4 h of unloading. A recovery period of 4 h of normal cage activity and low-intensity treadmill walking following acute unloading resulted in a reversal of LPL activity reduction. Reductions in skeletal muscle LPL activity were localized to the immobilized skeletal muscle and were paralleled with significant reductions in [³H]TG-derived fatty acid uptake locally in hind limb muscles and a significant decrease in HDL-C after both acute and chronic unloading. Changes in LPL protein content and activity were not accompanied by changes in LPA mRNA concentration.

In contrast, both LPL mRNA expression and LPL activity were significantly increased following 14-20 d of run training in rodents (Hamilton et al., 1998). There was a ≥ 2.5 fold increase in LPL activity compared to a 10-fold decrease in activity following 10 h of inactivity (Hamilton et al., 1998). The findings of these studies in rodents highlight the difference in the magnitude of LPL activity response to exercise

and inactivity. Inactivity induced reductions in LPL activity occurred more readily than increases in LPL activity in response to exercise training. Furthermore, decreases in LPL activity occur in the absence of change in LPL mRNA concentration despite decreases in LPL protein content.

Sedentary Behaviour and Insulin Action

Sedentary time is positively associated with insulin resistance and the risk of T2DM (Stephens et al., 2011). Reductions in insulin mediated glucose uptake have been found following prolonged periods of muscular unloading using hind limb suspension in rodents, and bed rest in humans (Mikines et al., 1991, Seider, et al., 1982). Stephens *et al.*, (2011) measured insulin action in 14 healthy men and women during a continuous infusion of [6,6-2H]-glucose the morning after each of the following 24 h conditions; a) active, non-sitting with a high energy expenditure and matched energy intake (NO SIT), b) sitting with low energy expenditure and no reduction in energy intake (SIT) and c) sitting with low energy expenditure and a reduction in energy intake to match expenditure (SIT BAL) (Stephens et al., 2011). Insulin action, defined as whole-body rate of glucose disappearance normalized to mean plasma insulin, was decreased by 39% in SIT group and 18% SIT group compared to NO SIT group. Insulin action was significantly lower in the SIT group than the SIT-BAL group. One day of sitting substantially reduced insulin action and this effect was attenuated, but not prevented, when energy intake was decreased to match expenditure.

Interrupting sedentary time has a beneficial effect on insulin action (Dunstan et al., 2012). Interrupting 5 h of uninterrupted sitting with 2 min bouts of light ($3.2 \text{ km}\cdot\text{h}^{-1}$) or moderate-intensity ($5.8\text{-}6.4 \text{ km}\cdot\text{h}^{-1}$) treadmill walking every 20 min significantly reduces the glucose incremental area under the curve (iAUC) and insulin iAUC in middle-age overweight men and women. Similar reductions in glucose and insulin were observed following interruption with either light or moderate-intensity exercise (Dunstan et al., 2012).

As demonstrated in the above studies, sedentary behavior has deleterious effects on cardiometabolic health and is associated with increased TG, decreased HDL-C and decreased insulin sensitivity (Tremblay et al., 2010). These effects are partially mediated by changes in LPL activity, an enzyme that is synthesized primarily by muscle cells and adipocytes, is present on the luminal surface of endothelial cells and facilitates the uptake of free fatty acids into skeletal muscle and adipose tissue (Hamilton et al., 2004). LPL binds to circulating ApoB containing lipoproteins and mediates triglyceride lipolysis. The regulation of LPL in skeletal muscles is highly dependent on physical activity/inactivity levels. Loss of local contractile stimulation induced by acute and chronic sedentary behaviour results in the suppression of skeletal muscle LPL activity and reduced tissue specific uptake of free fatty acids. This results in an increase in circulating levels of TG and associated CVD risk (Hamilton et al., 2004).

Sedentary Behaviour and Vascular Function

It has been postulated that low shear stress in the vasculature in response to sedentary behaviour may have a deleterious effect on vascular function (Thosar et al., 2012). Low shear stress results in a direct reduction of nitric bioavailability by decreasing eNOS phosphorylation or indirectly by producing endothelial microparticles and subsequent oxidative stress (Thosar et al., 2012). Inactivity increases NAPDH oxidase activity in mice resulting in increased oxidative stress (Laufs et al., 2005).

Limited studies have investigated the effect of sedentary behaviour on vascular function in adults with the majority of studies involving bed rest or periods of microgravity. Consequently, these studies do not accurately represent sedentary behaviour as there is no postural activity associated with such activities. Hamburg *et al.*, (2007) examined the effect of 5 days of bed rest on insulin sensitivity and vascular function in 20 healthy adults with a mean age of 31 years (Hamburg et al., 2007). The study participants were permitted to get out of bed for up to 30 min within a 24 h period. Brachial artery FMD and reactive hyperemic responses was assessed using ultrasound at baseline and on day 3 and day 5. Venous occlusion plethysmography was used to measure lower limb blood flow at baseline and on day 3 and day 5. After bed-rest, reactive hyperemia was reduced by 20% and 30% in lower and upper limbs, respectively indicating impaired microvascular function. Insulin resistance increased by 67% following bed rest. There was also a significant increase in BP and brachial artery diameter suggesting increases in basal arterial tone.

Protocols that simulate microgravity have also been used to examine the effect of sedentary behavior on vascular function (Demiote et al., 2007). Findings of the WISE study found that 56 days of head down bed rest resulted in a decrease in EDD and increased endothelial cell damage in healthy women (Demiote et al., 2007).

Sedentary Behaviour in Children and Adolescents

Common sedentary behaviours among children and adolescents include television viewing, computer gaming, surfing the Internet and motorized transport. A recent study found that European children between the ages of 12-18 years spend on average 9 h per day or 71% of their waking hours in sedentary behaviour (Ruiz et al., 2011). Sedentary behaviour increases from childhood to adolescence (Trang et al., 2013, Brodersen, et al., 2007) with 11-14 and 15-19 year olds spending approximately 1.3 h and 2.0 h respectively, more per week than children under the age of 11 years (Colley et al., 2011). The American Academy of Pediatrics recommends that screen-time should be limited to $2 \text{ h} \cdot \text{d}^{-1}$ day in children and adolescents (American Academy of Pediatrics 2001). One third of European teenagers exceed these recommendation on a weekday and 60% at the weekend (Ruiz et al., 2011).

Sedentary Behaviour and CVD Risk Factors in Children and Adolescents

While self-reported screen time has been consistently associated with increased adiposity and CMD risk factors in children and adolescents independent of PA (Tremblay et al., 2011 , Chaput et al., 2013, Martinez-Gomez et al., 2012) results from studies examining the relation between objectively measured sedentary time

and CMD risk factors (Table 2.11) have been equivocal (Carson & Janssen, 2011, Colley et al., 2013, Ekelund et al., 2012, Mitchell et al., 2009, Steele et al., 2009, Hsu et al., 2011, Atkin et al., 2013, Henderson et al., 2012).

A number of cross-sectional studies have found no independent association between sedentary time and CMD risk factors in healthy children and adolescents. After adjusting for age, sex, race, socioeconomic status, smoking, total fat, saturated fat, cholesterol and sodium and MVPA, Carson and Janssen (2011) found no relation between sedentary time measured using accelerometry and clustered CMD risk in a large cohort of 6 to 19 year old children and adolescents (Carson & Janssen, 2011). In a similar cohort of 1608 children, no association was found between sedentary time measured using accelerometry and BMI, waist circumference, non HDL-C, SBP and DBP after adjusting for age, wear time and MVPA (Colley et al., 2013). Similarly, after adjustment for sex, age, BMI, MVPA and pubertal status, sedentary time measured using an Actigraph accelerometer was not associated with CRP, adiponectin or other adipokines in adolescents between the ages of 13-17 years (Martinez-Gomez et al., 2012).

In contrast to self-reported studies that found a strong association between adiposity and sedentary behaviour (Ekelund et al., 2006, Goldfield et al., 2013), two recent studies that used accelerometers to objectively measure sedentary behaviour did not find a significant relation between sedentary time and fat mass in 8-15 year olds after adjusting for height and MVPA (Kwon et al., 2013) or between sedentary

time and percentage body fat and waist-to-hip ratio with or without adjustment for confounding factors including MVPA in children aged 8-10 years (Chaput et al., 2012).

Some recent studies have found a significant relation between sedentary time and CMD risk factors independent of PA but not adiposity (Atkin et al., 2013, Henderson et al., 2012). In a recent study involving 9 and 15 year old children and youth, Atkin *et al.*, (2013) found that sedentary time, calculated using 4 different threshold cut-off points was associated with an increased clustered CMD risk independent of age group, sex, study location, sexual maturity, day of week, season, wear time, adiposity and total PA. The relation however was however, no longer significant after adjusting for adiposity (Atkin et al., 2013). Similarly, a cross-sectional study involving 8 to 11 year old children with a family history of obesity found that sedentary time was positively associated with insulin resistance after adjustment for sex, age, pubertal stage, fitness and MVPA but not after additional adjustment for adiposity (Henderson et al., 2012).

A large study examining sedentary behavior and CMD risk factors in 20,870 children from 10 different countries ranging in age from 4 to 18 years found that after adjustment for age, sex, adiposity and diet, sedentary time was associated with fasting insulin but not with waist circumference, SBP, TG or HDL-C. The relation between sedentary time and fasting insulin was no longer significant after additional adjustment for MVPA (Ekelund et al., 2012). Similarly, Mitchell *et al.*, (2009) found no relation between sedentary time and increased risk of obesity in 5,434 youth with a mean age of 12 years after adjustment for MVPA (Mitchell et al., 2009) In a

younger cohort of healthy 9-10 year old children, objectively measured sedentary time was positively associated with waist circumference and fat mass. Sedentary time remained associated with fat mass after adjusting for age, sex, socioeconomic status, and birth weight, sleep duration and maternal BMI. However, this association was not significant after adjusting for MVPA (Steele et al., 2009). Hsu *et al.*, (2011) also found that sedentary time was no longer positively associated with waist circumference and SBP after adjustment for MVPA in 8-19 year old healthy children (Hsu et al., 2011). The relation between sedentary behaviour and cardiometabolic disease factors independent of MVPA and adiposity in children and adolescents remains unclear with studies presenting equivocal findings. While sedentary behaviour has been proposed as an independent risk factor for CVD in adults, further investigation on sedentary behaviour as a risk factor for CVD independent of MVPA in children and adolescents is warranted.

Table 2.11: Cross sectional studies that examined the relation between objectively measured sedentary behaviour and cardiometabolic disease risk factors in children and adolescents

Author	Cohort	Measurement of sedentary behaviour	Measure of Metabolic risk	Clustered Confounders adjusted for	Findings
Carson and Janssen (2011)	n (m/f)=1284/1243 Age: 6-19 yr	Actigraph accelerometer < 100 cpm Total sedentary time	WC, SBP, non HDL-C, hsCRP	Age, sex, race, SES, smoking, total fat, saturated fat, cholesterol, sodium, MVPA	No association between sedentary time and clustered metabolic risk after adjustment for confounders and additional adjustment for MVPA
Colley <i>et al.</i> , (2013)	n (m/f)= 809/799 Age: 6-19 yr	Actical accelerometer < 100 cpm Total sedentary time	BMI, WC, SBP, DBP, non HDL-C	Age, wear time and MVPA	Sedentary time was not associated with BMI, WC, non HDL-C, SBP and DBP independent of age, wear time and MVPA
Kwon <i>et al.</i> , (2013)	n (m/f)= 277/277 Age: 8-15 yr	Actigraph accelerometer < 100 cpm Total sedentary time	Fat mass	Height, physical maturity, MVPA	No association between sedentary time and fat mass after adjustment for height and MVPA
Chaput <i>et al.</i> , (2012)	n (m/f)=299/251	Actigraph	% body fat and waist-to-	Age, sex, sleep	No association between

	Age: 8-11 yr with a family hX of obesity	accelerometer < 100 cpm Total sedentary time	height ratio	duration, energy intake, sexual maturation, parental SES and BMI or MVPA	sedentary time and % body fat or waist height ratio with or without adjustment for confounders
Ekelund <i>et al.</i> , (2012)	n=(m/f) 10,097/10,773 Age: 4-18 yr	Actigraph accelerometer < 100 cpm Total sedentary time	WC, SBP, TG, HDL-C and insulin	Age, sex, monitor wear time, WC, MVPA, height	Sedentary time was related to fasting insulin but not to WC, SBP, TG, HDL-C when adjusted for age, sex, monitor wear time and height. After additional adjustment for MVPA, there was no relation between sedentary time and any of the measured CMD risk factors
Mitchell <i>et al.</i> , (2009)	n=(m/f) 2950/2844 Age: 12 yr	Actigraph accelerometer ≤ 199 cpm Total sedentary time	Fat mass, BMI	Gender, SES, pubertal status and early life sleep and TV habits	Sedentary time was significantly associated with increased risk of obesity independent of potential confounders. This association was no longer significant after adjustment for MVPA
Steele <i>et al.</i> , (2009)	n=(m/f) 820/1042	Actigraph accelerometer	BMI, WC and fat mass index	Age, sex, SES, birth weight, sleep duration, maternal	Sedentary time was significantly related to WC and fat mass index but not

	Age: 9-10	< 100 cpm		BMI	BMI and this relation remained significant after adjustment for confounders. This relation was no significant after additional adjustment for MVPA.
		Total sedentary time			
Hsu <i>et al.</i> , (2011)	n=(m/f) 26/79 Age: 8-19 yr	Actigraph accelerometer < 100 cpm Total sedentary time	WC, fat and lean tissue mass, SBP, DBP, TG, fasting glucose	Age, sex, ethnicity, fat and lean tissue mass, and pubertal tanner stage	Sedentary time was positively associated with WC and SBP but not TG, fasting glucose or DBP after adjustment of confounders. After adjustment for MVPA, Sedentary time was not associated with any outcome
Henderson et al., (2012)	n=(m/f) 222/202 Age: 8-11 yr	Actigraph accelerometer < 100 cpm Total sedentary time	HOMA, oral glucose tolerance test	Age, sex pubertal status, CRF, MVPA, percent fat mass	Sedentary time was positively associated with with insulin resistance after adjustment for age, sex, puberty, CRF and MVPA but not after additional adjustment for percent fat mass
Atkin <i>et al.</i> , (2013)	n=(m/f) 1059/1268	Actigraph accelerometer <100, <500, <800	BP, insulin resistance, sum of skinfolds, HDL-C	Age, group age, sex, study location, day of week, season,	Sedentary time was associated with clustered metabolic risk but not

Age: 9 and 15 yr and <110 cpm
Total sedentary time

wear time adiposity with adiposity
and total PA independent of
confounders. The
strongest relations
between sedentary time
and clustered CMD risk
were observed at high
accelerometry thresholds

PA, physical activity; m/f, male/female; cpm, counts per minute; LIPA, light intensity physical activity; MVPA, moderate intensity physical activity; VPA, vigorous intensity physical activity ;CMD, cardiometabolic disease; SES, socioeconomic status; CRF, cardiorespiratory fitness; WC, waist circumference; TC: HDL-C, total cholesterol HDL-C ratio, HOMA; homeostasis model assessment; TG, triglycerides; BP, blood pressure, SBP, systolic blood pressure; DBP, diastolic blood pressure; HDL-C, high density lipoprotein cholesterol; BMI, body mass index; hsCRP, high sensitivity C-Reactive protein

Chapter III

STUDY 1

MAXIMAL AEROBIC CAPACITY, SELECTED CVD RISK FACTORS AND VASCULAR

HEALTH IN MALE ADOLESCENTS

Rationale

CVD is the leading cause of morbidity and premature mortality in Ireland accounting for 32% of all deaths (Irish Heart Foundation 2015). Atherosclerosis, a chronic inflammatory disease, is the most common cause of CVD and begins early in life. Clinical manifestations of the disease usually occur in middle and late adulthood. In 2009, CVD accounted for approximately 6% of total Irish health care expenditure (McGee, 2010), most of which was spent on surgical interventions and treatment of risk factors.

The vascular endothelium is an active paracrine organ that plays an important role in maintaining vascular homeostasis and is intimately involved in the initiation and progression of atherosclerosis. Damage to the vascular endothelium represents one of the earliest events in the pathogenesis of atherosclerosis and precedes structural changes in the vascular wall such as IMT (Deanfield et al., 2007).

The severity of atherosclerosis is not only associated with the presence and extent of CVD risk factors but also to the persistence of risk factors over time (Berenson et al., 1998). Childhood risk factors track into adulthood (Juhola et al., 2011, Nicklas et al., 2002) and contribute to the development of sub-clinical atherosclerosis in young adulthood (Davis et al., 2001, Li et al., 2003, Raitakari et al., 2003). Considering the long latent phase of atherosclerotic progression prior to clinical manifestation, the ability to non-invasively measure structural and functional markers of sub-clinical atherosclerosis during childhood is a critical aspect of early detection and risk classification (Berenson, 2002). Studies have reported increased cIMT and impaired endothelial function in young children with established ACVD risk factors such as overweight (Woo et al., 2004), obesity (Meyer et al., 2006, Zhu et al., 2005), and T1DM (Järvisalo et al., 2004).

Low CRF is an independent risk factor for CVD and all-cause mortality (Blair, et al., 1989, Blair et al., 1995). In contrast, a high level of CRF is cardioprotective and largely negates the adverse effects of traditional risk factors on subsequent CVD and mortality (Blair et al., 1996, Church et al., 2004, Lysterly et al., 2008, Lysterly et al., 2010). Studies in asymptomatic children and adolescents have found that high levels of CRF are positively associated with a more favorable cardiometabolic health profile compared to their unfit counterparts (Ruiz et al., 2007, Ekelund et al., 2007, Anderssen et al., 2007). High levels of CRF during adolescence are predictive of a healthier CVD risk factor profile in adulthood (Twisk et al., 2002). Despite the wealth

of evidence linking high levels of CRF to a reduced risk of CVD mortality, its measurement is often neglected in CVD risk assessment.

Improvements in CRF, that accompany regular exercise training have been found to improve endothelial function and CVD risk factor profile and decrease cIMT in obese adolescents (Watts et al., 2004, Meyer et al., 2006). Exercise induced increases in shear stress enhances EDD by increasing the up-regulation of eNOS and subsequent bioavailability of NO (Hambrecht, 2003). To date, no published study has examined the relation between objectively measured CRF, CVD risk factors and vascular structure and function in healthy adolescents.

Study Purpose

The purpose of this study was to compare selected CVD risk factors and vascular health in LF, MF and HF healthy male adolescents, and to examine the relation between CRF, CVD risk factors and vascular health.

Specific Aims

1. To compare serum blood lipids, fasting glucose, insulin, HOMA-IR, pro-inflammatory cytokines, vascular adhesion molecules, BP, body composition, EDD and cIMT in LF, MF and HF healthy male adolescents.
2. To examine the bivariate relation between CRF and EDD in healthy male adolescents.
3. To examine the bivariate relation between CRF and cIMT in healthy male adolescents.

Hypothesis

1. HDL-C and EDD will be significantly lower and TC, LDL-C, TG, fasting glucose, insulin, HOMA-IR, BP, pro-inflammatory cytokines, sICAM-1, sVCAM-1, sum of skinfolds, waist-to-hip ratio, body weight, BMI and cIMT will be significantly higher in LF than MF and HF male adolescents.
2. There will be a significant positive linear relation between $\dot{V}O_2\text{max}$ and EDD in healthy male adolescents.

3. There will be a significant inverse relation between $\dot{V}O_2\text{max}$ and cIMT in healthy male adolescents.

STUDY 1

Methodology

Study Overview

A total of 350 post-primary school students in the Greater Dublin region undertook a multistage shuttle run test (20-MST) to estimate their aerobic fitness level as part of a screening process. The test was undertaken during a scheduled physical education class. Based on the number of shuttle runs completed, participants were classified as low fit (LF) (0-40th percentile), MF (MF) (40-70th percentile), and (HF) (70th-100th percentile) in accordance with European age and gender specific percentiles for aerobic fitness (Ortega et al., 2011). A random sample was selected from each of the 3 fitness groups to participate in the study.

The selected participants wore an accelerometer for 7 d and made a single visit to the Vascular Research Unit in Dublin City University (DCU) during which a fasting blood sample was drawn and body composition, pubertal status, BP, endothelial function, cIMT, and $\dot{V}O_2$ max were measured.

Participants

A total of 82 healthy male adolescents (LF n=26 LF, MF n=30, HF=26) aged 13-17 years participated in the study. Participants and their parents were fully informed of the experimental procedures and were provided with a plain language statement before written assent and informed consent were obtained in accordance with the

Research Ethics Committee at DCU (Appendix A). A physical activity readiness questionnaire (PAR-Q) was also completed by each participant prior to commencing the study (Appendix B). Participants were excluded if they were current smokers, had a condition that precluded them from exercising, uncontrolled hypertension (SBP >180 mmHg, diastolic BP >100 mmHg), failed to reach a heart rate $\geq 90\%$ of their age predicted maximal value during the 20-MST or did not obtain informed consent from a parent or guardian.

20-MST

The test involved running back and forth between two lines 20 m apart, while keeping time to a series of audio signals. The initial velocity was $8.0 \text{ km}\cdot\text{hr}^{-1}$ and increased by $0.14 \text{ m}\cdot\text{s}^{-1}$ each min. The test was terminated if the participant voluntarily dropped out, or was unable to maintain the set pace by failing to reach either end-line before or on two consecutive bleeps. The total number of shuttle runs completed and the total distance achieved were recorded. Participants wore a heart rate monitor (Polar team 2 Pro, Polar Electro Inc., NY, USA) during the test. The purpose of the 20-MST was to screen participants for aerobic fitness and subsequent study recruitment.

Study Visit

Participants abstained from strenuous PA for 24 h, and abstained from food, alcohol and caffeine for at least 12 h before the visit. During the visit, a fasting blood sample was drawn, pubertal status was self-reported and body composition, blood

pressure, endothelial function, cIMT and maximal aerobic capacity ($\dot{V}O_{2\max}$) were measured. The order of testing is outlined in Figure 3.1.

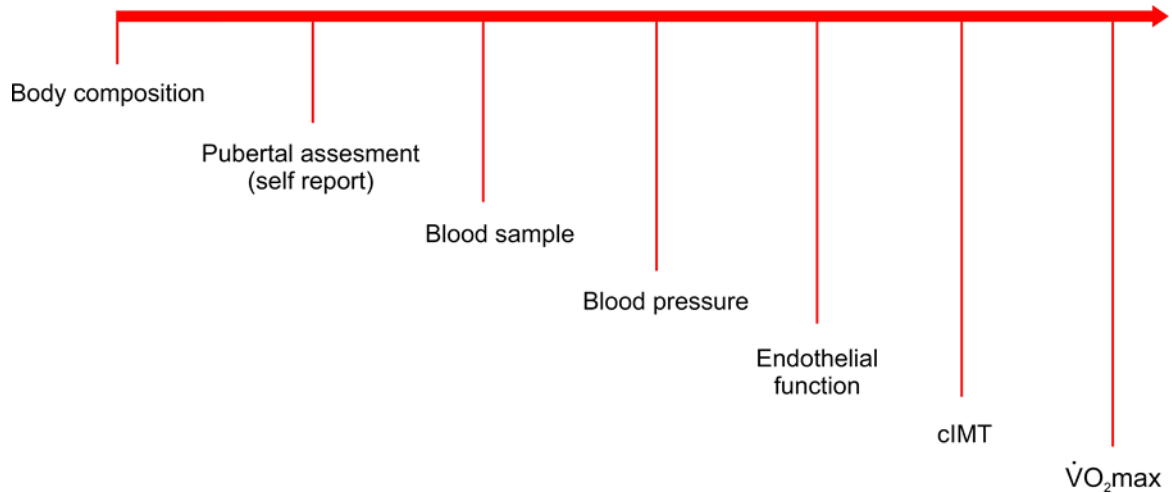

Figure 3.1: Order of tests undertaken by participants during the study visit

Body Mass Index

Height and body mass were measured using a wall stadiometer and electronic balance (Seca 797, USA), respectively. Footwear was removed prior to the measurement. Height was measured to the nearest 0.1 cm and body mass was measured to the nearest 0.1 kg. Body mass index (BMI) was calculated by dividing body weight in kilograms by height in meters squared ($\text{kg}\cdot\text{m}^{-2}$). Age and gender specific BMI percentiles were calculated and Centers for Disease Control and Prevention (CDC) standards were used to classify participants as normal weight (BMI < 85th percentile), overweight (BMI \geq 85th and < 95th percentile) and obese (BMI \geq 95th percentile)(Kuczmarski et al., 2002).

Waist-to-hip ratio

Waist and hip circumferences were measured in duplicate using a non-elastic flexible standard measuring tape (RollFix, Hoechstmass, Germany). Measurements were recorded to the nearest 0.1 cm. Waist circumference was measured at the minimum circumference between the iliac crest and the rib cage (Taylor et al., 2000). Hip circumference was recorded at the maximum circumference over the buttocks (Taylor et al., 2000). Waist-to-hip ratio was calculated by dividing the mean waist measurements by the mean hip measurements.

Body Fat

Double thickness subcutaneous adipose tissue was measured on the right side of the body using skinfold calipers (Harpenden, Cambridge Scientific Industries, MD). Chest, abdomen and thigh skinfold measurements were recorded to the nearest 0.1 cm. A minimum of two measurements was taken at each site and a third was taken if the initial two measurements varied by > 1.0 cm. The sum of the chest, abdomen and thigh skinfold thickness was used as an overall measure of subcutaneous body fat.

Maturation

Participants self-reported their genital and pubic hair development using standardized Tanner drawings representing different stages of sexual maturity (Tanner et al., 1962) (Appendix C). Participants were classified as pre-pubertal (PP,

Tanner Stage 1), mid-pubertal (MP, Tanner Stages 2-4) or late-pubertal (LP, Tanner Stage 5) (Marlatt et al., 2013).

Blood Pressure

Prior to blood pressure measurements, participants rested in an upright-seated position for 5 min in a quiet, temperature controlled room. Blood pressure was measured using a mercury sphygmomanometer (Dekamet Model Accoson Sphygmomanometers, Harlo Essex) and stethoscope (Classic II 3M Littmann, St. Paul, MN). SBP and DBP readings were categorized based on gender, age and height specific percentiles for BP evaluation in children and adolescents; normal (<90th percentile); prehypertension (SBP and/or DBP between the 90th and 95th percentiles); hypertension (SBP and/or DBP \geq 95th percentile) (NIH, 2005).

Blood Sampling

Participants rested in a seated position for 5 min with legs uncrossed in order to minimize plasma volume shifts. Blood samples were drawn from the antecubital vein. Serum vacutainers were allowed to stand for 20 min before centrifugation at 3000 rpm (1600 g) for 15 min at 4°C.

Biochemical Analysis

Serum TG, TC, HDL-C, LDL-C levels were determined using spectrophotometric assays, performed on an automated bench-top clinical chemistry system (Randox RX Daytona, Randox Laboratories, UK) using the appropriate reagents, calibrators and

controls. Haematocrit, haemoglobin concentrations and circulating leukocytes were determined from an EDTA whole blood sample using an automated haematology analyzer (AcTdiff2, Beckman Coulter, USA).

Insulin Sensitivity

Fasting glucose was analyzed using a YSI 2300 STAT Plus™ Glucose and Lactate Analyzer. Fasting Insulin was analyzed using an ultrasensitive insulin assay, which is a simultaneous one step immunoenzymatic “Sandwich “ assay (UniCek Dxl 8000, access immunoassay system, S/N 602530, Version 5.1) HOMA-IR was calculated using the following equation; $HOMA-IR = \text{Glucose (mmol/L)} \times \text{Insulin (mIU/ml)} / 22.5$ (Wallace, Levy, & Matthews, 2004). A HOMA-IR value ≥ 3.16 was used to diagnose the presence of insulin resistance (Keskin et al., 2005).

Proinflammatory cytokines

Pro-inflammatory cytokines IL-1 β , IL-6, INF- γ and TNF- α were measured using the V-Plex Human Proinflammatory Panel 1 (4-plex) immunoassay (Mesoscale Discovery, Maryland, USA) using the appropriate reagents, calibrators and controls. The results were analyzed using a Mesocale Discovery sector imager 2400 (Mesoscale Discovery, Maryland, USA).

Markers of Vascular Injury

sICAM-1, sVCAM-1 and hsCRP and SAA were analyzed using the V-Plex Plus Vascular Injury Panel 2 (human) Kit immunoassay (Mesocale Discovery, Maryland

USA) using the appropriate reagents, calibrators and controls. The results were analyzed using a Mesocale Discovery sector imager 2400 (Mesoscale Discovery, Maryland, USA).

Overview of Endothelial Function Assessment

Brachial artery FMD was determined using high-resolution ultrasonography. Measurements were performed by the same investigator using a SonoSite, MicroMaxx® (Sonosite Inc., Bothell, Washington, US) ultrasound system with a linear array transducer, operating at a frequency of 12.0 MHz (Figure 3.2).



Figure 3.2: Sonosite MicroMaxx® ultrasound system and 12.0 MHz linear array transducer

Brachial artery images were acquired with the participants in a supine position in a quiet, temperature-controlled room, with their right arm rested on an examination table perpendicular to the bed and extended and externally rotated to permit imaging of the right brachial artery. An automated pneumatic cuff was placed on the right forearm, distal to the brachial artery (Figure 3.3) and electrodes for a 3-lead ECG were placed on their chest. The ECG tracing was activated on the

ultrasound system and settings adjusted to ensure clear identification of the R wave, which corresponds to the end of diastole in the cardiac cycle.

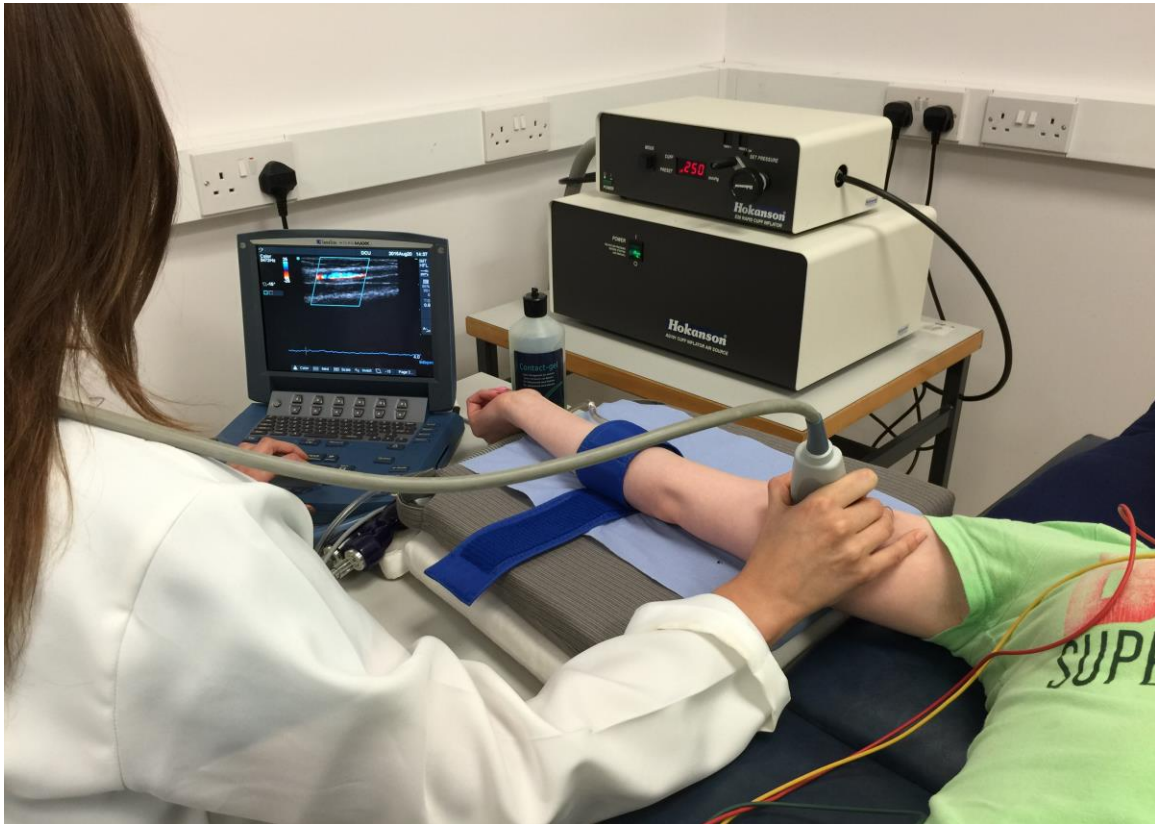

Figure 3.3: Arm position and cuff placement

Participant Preparation

Participants were tested between 9 and 11 am, by the same experienced investigator, in a quiet, temperature-controlled room (Vascular Research Unit). Participants arrived to the Vascular Research Unit, DCU after a 9 h overnight fast. Only water consumption was permitted prior to the test. Participants were not permitted to exercise, or ingest substances that might affect FMD such as caffeine and vitamin C or use tobacco for at least 6 h before the study.

Ultrasound Technique and Image Acquisition

Anatomic landmarks such as veins and fascial planes were noted and used to ensure that all M-mode images and Doppler measurements were recorded at the same site. A longitudinal image of the brachial artery was obtained using B mode ultrasound. The brachial artery was insonated 3-7 cm above the antecubital crease. Great care was taken to ensure that the anterior and posterior intimal interfaces between the lumen and the arterial wall were clearly visible. Depth and gain settings were optimized to delineate the lumen-arterial interface optimally on both the near (anterior) and far (posterior) wall. The boundaries were clearly visualized with the angle of insonation perpendicular to the vessel. It is recommended that the imaging plane should bisect the vessel in the longitudinal direction to ensure that diameter measurements obtained from the images reflect the true diameter of the vessel (Corretti et al., 2002). Images were magnified using a “zoom” function.

M Mode Imaging

The brachial artery was imaged using M mode function to facilitate arterial diameter measurements at appropriate time points (Figure 3.4). Brachial artery diameter was assessed in real time using the in-built ultrasound calipers (SonoSite MicroMaxx®). Each image acquired incorporated a minimum of 2 and a maximum of 3 consecutive ECG R waves. The brachial artery diameter measurements were obtained at cross sections corresponding to the R waves.

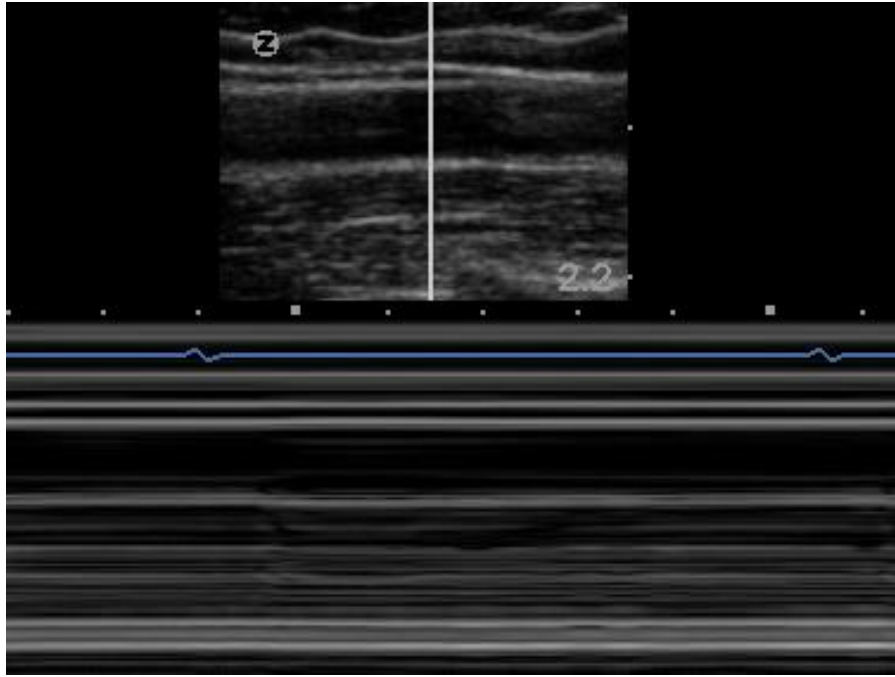

Figure 3.4: M mode ultrasound image of the brachial artery

Doppler Imaging

Doppler imaging was used to measure blood flow velocity ($\text{cm}\cdot\text{s}^{-1}$) in the brachial artery. The Doppler scale was adjusted to accommodate the spectral signal and the expected increase in blood flow following cuff release. The scale was maintained at the minimum range to decrease measurement error. The Doppler gate was set to minimum (1.5 mm) and was positioned in the centre of the artery lumen. The Doppler gate was aligned with the direction of flow and the transducer was adjusted to achieve an angle of insonation of 70° (Harris, Nishiyama, Wray, & Richardson, 2010). The insonation angle between the pulsed-wave Doppler beam and the vessel walls was adjusted by manipulation of the transducer, to allow the beam to be steered and the angle corrected in alignment with the vessel orientation/parallel, and blood flow axis at a discrete segment of 70° (Harris et al.,

2010). The Doppler function traced the spectral wave-form (Figure 3.5). The image was frozen and peak systolic velocity was manually measured using the in-built ultrasound calipers (SonoSite MicroMaxx®).

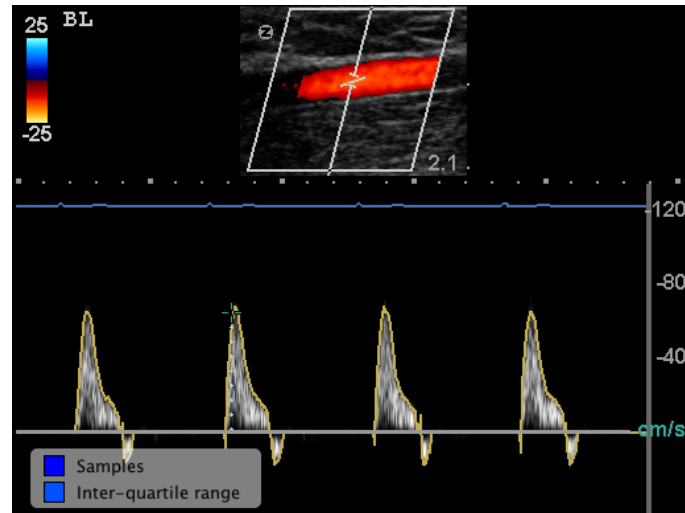

Figure 3.5 Frozen screen shot of a Doppler image

Endothelial -Dependent Dilation (EDD)

Figure 3.6 illustrates the endothelial-dependent dilation assessment protocol. Following a 10 min rest period a pneumatic cuff was inflated to 250 mmHg for 5 min (Corretti et al., 2002). Following 5 min of occlusion, the cuff was rapidly released resulting in reactive hyperemia and a subsequent increase in brachial artery blood flow. Post-deflation peak systolic velocity was measured using Doppler within 15 sec of cuff release (Corretti et al., 2002). M-mode images of the brachial artery were recorded every 30 sec post-deflation for 5 min for the off-line analysis of brachial artery diameter from which the peak diameter was obtained. The percent change in vessel diameter (%FMD) was calculated using the following equation; % FMD= Peak diameter (cm) - Baseline diameter (cm)/Baseline diameter (cm)*100

(Harris et al., 2010). Peak shear rate (SR_{peak}), an estimate of shear stress without blood viscosity was assessed prospectively and was calculated using the formula; $4 \times$ maximal velocity/vessel diameter at the time of peak velocity (Parker et al., 1985). This measure of shear rate is significantly correlated with % change in FMD and highly correlated with SR_{AUC} (Gibbs et al., 2011), which is most commonly used method to normalize FMD responses for shear rate.



Figure 3.6: Overview of the protocol used to assess endothelial-dependent dilation

Endothelial-Independent Dilation

Figure 3.7: illustrates the endothelial-independent dilation assessment procedure. Participants rested for 15 min to eliminate endothelium-dependent effects on the brachial artery diameter. Following this period, a new baseline brachial artery image was recorded. Glyceryl trinitrate (GTN; 400 μ g) was then administered sublingually. M-mode images were named and recorded every 30 s for 5 min following GTN administration for the off-line analysis of brachial artery diameter from which the peak diameter was obtained.

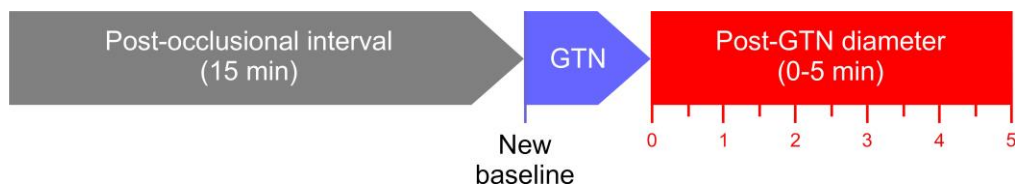

Figure 3.7: Overview of the protocol used to assess endothelial-independent dilation

Off-line Arterial Measurement Software

Brachial artery diameter was determined by the off-line analysis of ultrasound images using custom-designed, semi-automated ultrasound arterial measurement software. Measurements were performed in a blinded fashion. Images were selected for analysis using a standard dialog box (Figure 3.8). For each image, the artery was located and the area between the anterior and posterior arterial walls was manually selected. The software used this point to segment the arterial boundary using a constrained region-growing algorithm, and the result was depicted visually in that the segmented arterial lumen was highlighted using grey shading. The segmentation of the artery was updated in real-time. The automated values could be overridden by selecting a new seed point or by using a slider to adjust the threshold intensity values of the segmentation until a satisfactory diameter estimate was obtained. Gated measurements of the brachial artery diameter were recorded using a minimum of 2 and maximum of 3 consecutive R waves on the ECG tracing. The mean of the 2-3 measurements was taken as the brachial artery diameter.

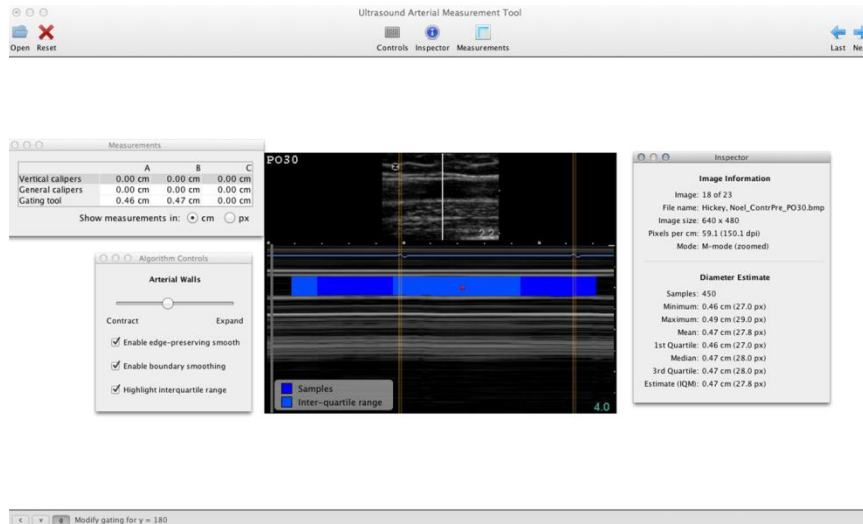

Figure 3.8: Standard Dialog box

Carotid Intima Media Thickness

Carotid intima media thickness (cIMT) was assessed using a 12.0 MHz linear-array transducer (SonoSite, MicroMaxx). Images were obtained with the participant resting in a supine position, with the head turned slightly to the contralateral side. (Figure 3.9)



Figure 3.9: Participant position for cIMT measurement

The CCA, including the carotid bulb, was visualized, and longitudinal B-mode images of the left and the right CCA were recorded and electronically stored. Measurement of cIMT were taken 0.5 cm, 1.0 cm and 2.0 cm proximal to the carotid

bulb in the near and far wall of the right and left CCA (Figure 3.10). Near and far wall measurements at each of the 3 sections of CCA were combined to calculate mean near and far wall CIMT. Advanced Vascular aging was defined as having a mean far wall IMT of the right CCA and left CCA $\geq 25^{\text{th}}$ percentile for race and sex matched healthy 45 year old (Howard et al., 1993).



Figure 3.10: Measurement of CIMT

Maximal Aerobic Capacity ($\dot{V}O_2\text{max}$)

Maximal aerobic capacity ($\dot{V}O_2\text{max}$) was assessed on a treadmill (Marquette 2000, General Electric, USA) using 1 of 3 incremental protocols (Appendix D), depending on the individual's level of fitness. Participants in the LF, MF and HF group undertook a 2 min warm up on a 0% grade, which consisted of 2 min at 6.0, 7.0 and 9.0 $\text{km}\cdot\text{hr}^{-1}$ respectively, After the warm-up the treadmill velocity was increased to 7.0, 8.0 and 11.0 $\text{km}\cdot\text{hr}^{-1}$ in the respective groups for 1 min and then was increased to 8.0, 10.0 and 12.0 or 13 $\text{km}\cdot\text{hr}^{-1}$ in the LF, MF and HF respectively after which the speed remained constant and the grade was increased by 0.5% every 30 sec until volitional exhaustion. The protocol was designed to ensure that participants reached volitional exhaustion between 8 to 12 min. Participants were verbally encouraged to give their maximal effort.

Respiratory metabolic measures were monitored continuously throughout the test and $\dot{V}O_2$ max was determined by averaging the three highest consecutive 20-sec values. Rating of perceived exertion (RPE) was recorded during the last 15 sec of each min using the Borg 16 point category rating scale. Heart rate was continuously recorded throughout the test using heart rate telemetry (Polar team 2 Pro, Polar Electro Inc., NY, USA). The test was deemed maximal if at least two of the following four criteria were satisfied: (i) a plateau in oxygen consumption (defined as a ≤ 2.0 ml.kg.min⁻¹ change in $\dot{V}O_2$ during the last minute of exercise) (ii) heart rate >200 bpm, (iii) RER >1.0 or (iv) volitional fatigue (Breithaupt et al., 2012).

Cardiorespiratory and Metabolic Measures

Respiratory metabolic responses were determined using standard open-circuit spirometry techniques (Sensormedics Vmax 229, Sensormedics Corp., CA). Prior to testing, the gas analysers were calibrated with standard gases of known concentration. A mass flow sensor (Sensormedics, Loma Linda, CA, USA) was used to collect breath-by-breath measurement of ventilation. A 3 L volume syringe (Sensormedics, Loma Linda, CA, USA) was used to calibrate the mass flow sensor prior to each test.

Mass Flow Sensor Heated Wire Anemometer- Mode of Operation

The mass flow sensor is a low resistance tube with a tapered internal diameter extending from both ends of a laminar flow throat. A cold and hot stainless steel wire electrically heated to -180°C and -240°C respectively, are centered in the

flow stream. These wires are elements in a servo-controller bridge circuit that maintain the resistance ratio of the two wires at a constant value. If only the temperature of the inspired gases changes then both wires lose heat at the same rate and no current change is required to keep the bridge balanced. As air flows across the wires, the hot air loses heat more rapidly than the cold air and current must be added to keep the bridges balanced at a 3:4 ratio. The amount of current required is proportional to the mass flow of the gas. This method ensures that the sensor measures only the heat loss from the molecular convection of the moving gas stream, and not the artifact due to cooling of the gas as it passes through a breathing assembly. The mass flow meter responds to instantaneous flow rates between 0-16 L·sec⁻¹ and integrated flow between 0-350 L·min⁻¹ with flow resistance <1.5 cmH₂O·L⁻¹·sec⁻¹. The mass flow sensor was outputted to the analyser module of the Vmax 229 and was sampled at a rate of 125 Hz.

Mass Flow Sensor Calibration

A 3.0 L volume syringe (Sensormedics, Loma Linda, CA, USA) was connected to the mass flow sensor, and stroked four times in order to measure inspired and expired volumes. The volumes were calculated by expressing 3 L as a fraction of each measured inspired and expired volume achieved during calibration. An average correction factor was calculated for inspired and expired volumes, and used to fine-tune the volume measurement.

A verification procedure was performed. This involved stroking the 3 L volume syringe four times. Inspired and expired volumes were measured using the newly calculated correction factors. In order to pass the calibration procedure, one of the four strokes had to have an average flow rate $< 0.5 \text{ L}\cdot\text{sec}^{-1}$, and at least one of the four strokes had to have an average flow $> 3.0 \text{ L}\cdot\text{sec}^{-1}$.

Gas Analysers

The Vmax 229 utilizes a rapid response infrared measurement technique. An O_2 and CO_2 analyser is integrated with the Vmax 229. A small sample of inspired air is drawn through a sample cell, and exposed to an infrared light through an optical that is passed through a band pass filter and the sample cell. An infrared detector responds to the amount of infrared light that passes through the sample cell. The amount of light that passes through the sample cell varies according to the concentration of CO_2 in the sample cell. Based on measured levels of infrared light intensity, the analyser computes the PCO_2 in the gas sample. The CO_2 analyser is linearly scaled across the 0-100% range with a resolution of 0.01% CO_2 , and a response time of $< 130 \text{ ms}$ (10-90%) at $500 \text{ ml}\cdot\text{min}^{-1}$ flow. The O_2 analyser is based on the high paramagnetic susceptibility of O_2 . A diamagnetic glass dumbbell suspended in a magnetic field rotates in proportion to the PO_2 . The analyser is linearly scaled across the 0-100% range with a resolution of 0.01% O_2 and a response time of $< 130 \text{ ms}$ (10-90%) at $500 \text{ ml}\cdot\text{min}^{-1}$ flow.

Calibration of CO₂ and O₂ Analysers

The gas analysers were calibrated with standard gases of known concentration (BOC gases, Dublin, Ireland). The first calibration gas contained 26.00 ± 0.02% oxygen and the balance nitrogen (N₂). The second calibration gas contained 4.00 ± 0.02% carbon dioxide, 16.00 ± 0.02% O₂, and the balance N₂. A small bore drying tube connected to the CO₂ and O₂ analysers sampled the calibration gases. The absorption and evaporative properties of the drying tube ensured that the relative humidity of the calibration gas was equilibrated to ambient conditions prior to sampling by the O₂ and CO₂ analysers. The calibration gas was sampled at a rate of 125 Hz. The response time was similar between O₂ and CO₂ analyser.

Statistical Analysis

Prior to statistical analysis the data was checked for normality using the Kolmogorov- Smirnov (K-S) test. A one-way ANOVA (parametric) and a Kruskal-Wallis test (non-parametric) were used to compare selected CMD risk factors, endothelial function, cIMT and physiological and perceptual responses during maximal exercise between LF, MF and HF groups. Significant main effects were probed using a Bonferroni post hoc test (parametric, equal variances assumed) or Games-Howell post hoc test (parametric, equal variances not assumed) and Mann-Whitney U test (non-parametric). Statistical significance was accepted at the p <0.05 level of confidence. Univariate analysis was undertaken using the Pearson product-moment correlation. Statistical significance was accepted at the p<0.05 level of confidence. Partial

correlations were undertaken using Pearson product-moment correlation. SPSS for Windows statistical software (V21.0, SPSS Inc, IL) was used to perform the statistical analysis

RESULTS

Participant characteristics

Participant physical characteristics and resting BP are summarized in table 3.1. Weight, BMI, waist circumference, hip circumference, sum of skinfolds, SBP and DBP were significantly lower in HF and MF than LF. 48% and 16% of LF were obese or overweight respectively. Within MF, 3% and 17% were classified as obese or overweight respectively. No HF participants were obese. 12% of HF were overweight. Waist-to-hip ratio was significantly higher in HF than both MF and LF. Tanner stage was significantly higher in HF and MF than LF. With the exception of waist-to-hip ratio and SBP, there were no significant differences in any of the measured parameters between HF and MF.

Table 3.1 Physical characteristics and resting blood pressure

	Group		
	HF	MF	LF
Age (y)	15.81 ± 0.49	15.70 ± 0.53	15.32 ± 0.85
Height (cm)	172.71 ± 6.10	175.49 ± 6.36	175.95 ± 6.73
Weight (kg)	63.29 ± 7.65‡	66.51 ± 10.72‡	82.87 ± 18.62
BMI (kg·m ⁻²)	21.19 ± 2.11‡	21.54 ± 2.90‡	26.88 ± 6.31
Waist circumference (cm)	71.06 ± 4.12*	68.04 ± 14.22*	80.32 ± 19.76
Hip circumference (cm)	75.73 ± 5.68*	75.12 ± 15.80*	88.93 ± 21.06
Waist-to-hip ratio	0.94 ± 0.04 ^c	0.91 ± 0.04	0.91 ± 0.08
Sum of skinfolds	29.26 ± 10.25‡	40.33 ± 19.95‡	83.72 ± 38.93
Tanner Stage	4.10 ± 0.45*	4.17 ± 0.53*	3.70 ± 0.68
SBP (mmHg)	113.81 ± 6.25 ^a	122.23 ± 6.04‡	131.32 ± 7.70
DBP (mmHg)	75.00 ± 4.66‡	76.63 ± 4.66‡	81.68 ± 4.34

Values are means ± SD; ‡p < 0.001 vs. LF, *p < 0.05 vs. LF; ^ap < 0.001 vs. MF; ^cp < 0.05 vs. MF

Physiological and Perceptual Responses at Maximal Exercise

The mean physiological and perceptual responses during the maximal graded exercise test are presented in table 3.2. Relative $\dot{V}O_{2\max}$ ($\text{ml}\cdot\text{kg}^{-1}\cdot\text{min}^{-1}$) was significantly higher in HF than MF and LF and in MF than LF. Absolute $\dot{V}O_{2\max}$ ($\text{L}\cdot\text{min}^{-1}$) was significantly higher in HF than MF and LF. Minute ventilation at maximal exercise was significantly higher in HF and MF than LF. There were no significant differences in maximum heart rate and maximal RPE between the three groups.

Table 3.2 Physiological and perceptual responses at maximal exercise

	Group		
	HF	MF	LF
$\dot{V}O_{2\max}$ ($\text{ml}\cdot\text{kg}^{-1}\cdot\text{min}^{-1}$)	$63.58 \pm 3.67\ddagger^a$	$53.17 \pm 3.99\ddagger$	39.99 ± 5.11
$\dot{V}O_{2\max}$ ($\text{L}\cdot\text{min}^{-1}$)	$4.03 \pm 0.50\ddagger^a$	3.47 ± 0.50	3.25 ± 0.61
HR max ($\text{beats}\cdot\text{min}^{-1}$)	199.65 ± 5.30	199.90 ± 7.70	197.54 ± 11.36
V_E max ($\text{L}\cdot\text{min}^{-1}$)	$104.83 \pm 13.56\ddagger$	$95.63 \pm 14.07^*$	82.19 ± 16.19
RER	1.13 ± 0.03	1.11 ± 0.08	1.13 ± 0.14
RPE	19.00 ± 1.20	18.87 ± 1.46	19.05 ± 1.33

Values are means \pm SD; $\ddagger p < 0.001$ vs. LF, $*p < 0.05$ vs. LF; $^a p < 0.001$ vs. MF

Blood Lipids

Fasting serum levels of blood lipids are presented in Table 3.3. Fasting TG were significantly lower in HF and MF than LF. With the exception of 1 participant in MF, TG values were within the acceptable normal range of $< 90 \text{ mg}\cdot\text{dL}^{-1}$ for participants in both MF and HF. In contrast, 41% of LF had borderline to high TG values classified as $> 90 \text{ mg}\cdot\text{dL}^{-1}$ (American Academy of Pediatrics, 2011). Circulating

HDL-C was significantly higher in HF and MF than LF. There were no significant differences in non HDL-C and TC between the groups.

Table 3.3 Fasting serum levels of circulating blood lipids

	Group		
	HF	MF	LF
Total cholesterol (mg·dL ⁻¹)	137.62 ± 25.09	134.38 ± 24.32	141.04 ± 28.53
HDL-cholesterol (mg·dL ⁻¹)	43.03 ± 11.26*	42.67 ± 8.52*	35.45 ± 10.06
LDL-cholesterol (mg·dL ⁻¹)	76.90 ± 16.98	72.50 ± 20.20*	89.82 ± 24.96
Non-HDL-cholesterol (mg·dL ⁻¹)	94.60 ± 17.67	91.71 ± 19.93	105.59 ± 23.56
Triglycerides (mg·dL ⁻¹)	51.46 ± 13.24‡	55.95 ± 16.44†	78.18 ± 24.50

Values are means ± SD; ‡p < 0.001 vs. LF, † p<0.01 vs. LF, *p <0.05 vs. LF;

Insulin sensitivity

Fasting glucose, insulin and HOMA-IR are presented in table 3.4. Glucose and insulin levels were significantly lower in HF and MF than LF. HOMA-IR was significantly lower in HF and MF than LF and in HF than MF. No participant in MF or HF was classified as insulin resistant based on a HOMA-IR value > 3.16. In contrast, 37% of LF participants were classified as insulin resistant.

Table 3.4 Fasting serum levels of glucose, insulin and HOMA-IR

	Group		
	HF	MF	LF
Glucose (mg·dL ⁻¹)	78.32 ± 7.18†	79.12 ± 5.92†	85.04 ± 7.70
Insulin (mIU L ⁻¹)	4.27 ± 1.31‡	5.83 ± 1.67‡	11.04 ± 5.16
HOMA-IR	0.85 ± 0.29‡ ^c	1.15 ± 0.35‡	2.34 ± 1.17

Values are means ± SD; ‡p < 0.001 vs. LF; †p < 0.01 vs. LF; ^cp <0.05 vs. MF

Cytokines and Vascular Adhesion Molecules

Circulating levels of pro-inflammatory cytokines and vascular adhesion molecules are presented in table 3.5. There was no significant difference in any of the measured pro-inflammatory cytokines and vascular adhesion molecules between the groups.

Table 3.5 Pro-inflammatory cytokines and vascular adhesion molecules

	Group		
	HF	MF	LF
IL-1 (ng·mL ⁻¹)	0.10 ± 0.14	0.10 ± 0.13	0.09 ± 0.12
IL-6 (ng·mL ⁻¹)	0.34 ± 0.25	0.44 ± 0.47	0.38 ± 0.21
TNF- α (ng·mL ⁻¹)	1.41 ± 0.69	1.68 ± 0.80	1.80 ± 0.59
INF-γ (ng·mL ⁻¹)	6.10 ± 4.58	5.57 ± 4.46	5.75 ± 3.79
SAA (ng·mL ⁻¹)	3644.32 ± 4046.23	5097.33 ± 7022.89	3134.99 ± 1774.05
hsCRP (mg·L ⁻¹)	0.83 ± 0.72	0.91 ± 1.06	1.28 ± 1.43
sICAM-1 (ng·mL ⁻¹)	691.59 ± 87.74	706.69 ± 120.49	838.90 ± 255.84
sVCAM-1 (ng·mL ⁻¹)	823.54 ± 173.51	850.8 ± 226.87	925.63 ± 185.27

Values are means ± SD

Endothelial Function

Resting brachial artery diameter was significantly higher in HF than LF (Table 3.6). The percentage change in EDD and EID is illustrated in figures 3.11. The percent change in EDD was significantly higher in HF (12.4%) and MF (9.7%) than LF (7.1%) and in HF than MF (figure 3.11A). There was no significant difference in percent change in EID between the three groups (figure 3.11B).

The absolute change in EDD and EID is presented in table 3.6. The absolute change in EDD was significantly higher in HF and MF than LF and in HF than MF. The absolute change in EID was significantly higher in HF than LF. There was no significant difference in absolute change in EID between either the HF and MF and the MF and LF groups. There was no significant difference in peak blood flow (BF) velocity following reactive hyperemia between the three groups (Table 3.6). There was also no difference in peak shear rate (SR_{peak}) between the three groups.

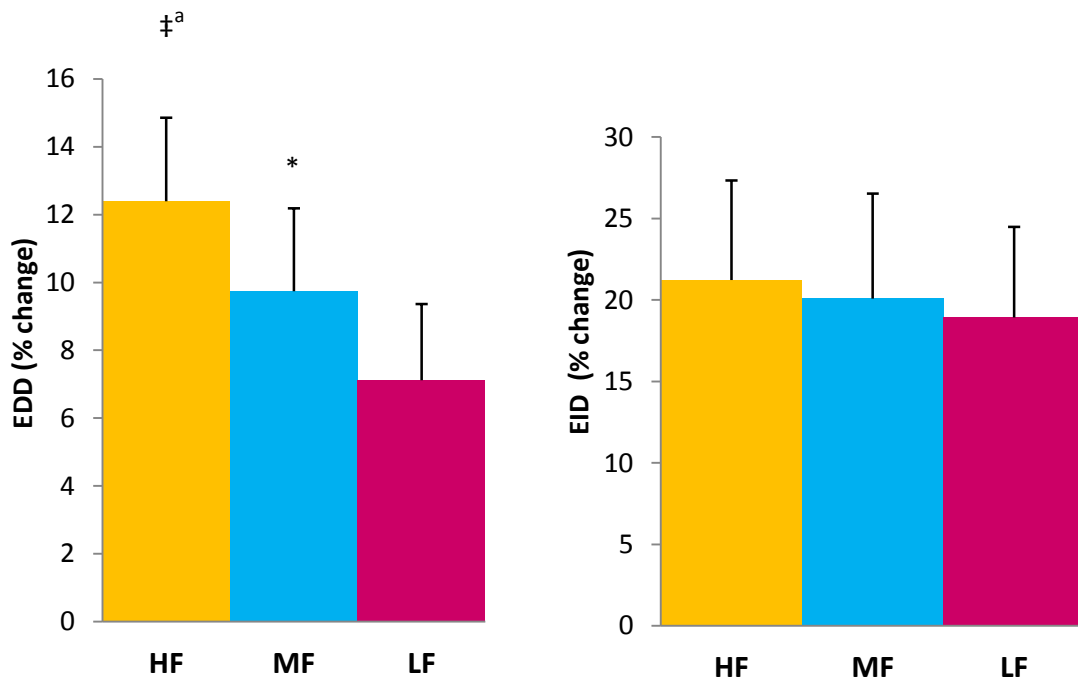

Figure 3.11 Percent change in EDD (A) and EID (B) in HF, MF and LF. Values are means \pm SD. ‡ $p < 0.001$ vs. LF; * $p < 0.05$ vs LF; ^a $p < 0.001$ vs. MF

Table 3.6 Brachial artery diameter, absolute change in EDD and EID and peak blood flow velocity

	Group		
	HF	MF	LF
Brachial artery diameter (cm)	0.40 ± 0.05*	0.37 ± 0.04	0.36 ± 0.04
EDD (cm)	0.40 ± 0.05*	0.37 ± 0.04	0.36 ± 0.04
EID (cm)	0.05 ± 0.01‡ ^a	0.04 ± 0.01‡	0.03 ± 0.01
Peak BF velocity (cm·s ⁻¹)	0.08 ± 0.02*	0.07 ± 0.02	0.07 ± 0.02
Peak Shear Rate	174.93 ± 25.96	170.09 ± 28.80	180.97 ± 20.39

Values are means ± SD; ‡p < 0.001 vs. LF, *p < 0.05 vs. LF; ^ap < 0.001 vs. MF

Carotid Intima media thickness

Near and far wall IMT measurements of the right and left CCA are presented in table 3.7. Right CCA near wall IMT, left CCA near wall IMT, right CCA far wall IMT and left CCA far wall IMT were significantly lower in HF and MF than LF and in HF than MF.

Table 3.7 Near and far wall cIMT measurements of right and left CCA

	Group		
	HF	MF	LF
Right near wall cIMT (mm)	0.39 ± 0.04‡ ^c	0.44 ± 0.08‡	0.52 ± 0.07
Left near wall cIMT (mm)	0.38 ± 0.03‡ ^c	0.44 ± 0.08‡	0.53 ± 0.08
Right far wall cIMT (mm)	0.39 ± 0.05‡ ^a	0.49 ± 0.07‡	0.57 ± 0.05
Left far wall cIMT (mm)	0.39 ± 0.04‡ ^a	0.49 ± 0.07*	0.55 ± 0.07

Values are means ± SD; ‡p < 0.001 vs. LF, *p < 0.05 vs. LF; ^ap < 0.001 vs. MF, ^cp < 0.05 vs. MF

Univariate Correlations - EDD

There was a significant positive relation between Tanner stage and percent change in EDD (r=0.25, p=0.013) and Tanner stage and absolute change in EDD (r=0.238, p=0.019). There was a significant positive relation between $\dot{V}O_2$ max (ml·kg⁻¹·min⁻¹) and percent change in EDD (r=0.25, p=0.013) and Tanner stage and absolute change in EDD (r=0.238, p=0.019).

1·min⁻¹) and the percent change in EDD ($r=0.70$, $p<0.001$) (Figure 3.2). After adjustment for baseline brachial artery diameter, pubertal stage, SBP, sum of skinfolds, insulin, HOMA-IR and TG, the strength of the association between $\dot{V}O_2\text{max}$ (ml·kg⁻¹·min⁻¹) and percent change in EDD decreased ($r=0.56$, $p=0.000$) but remained significant.

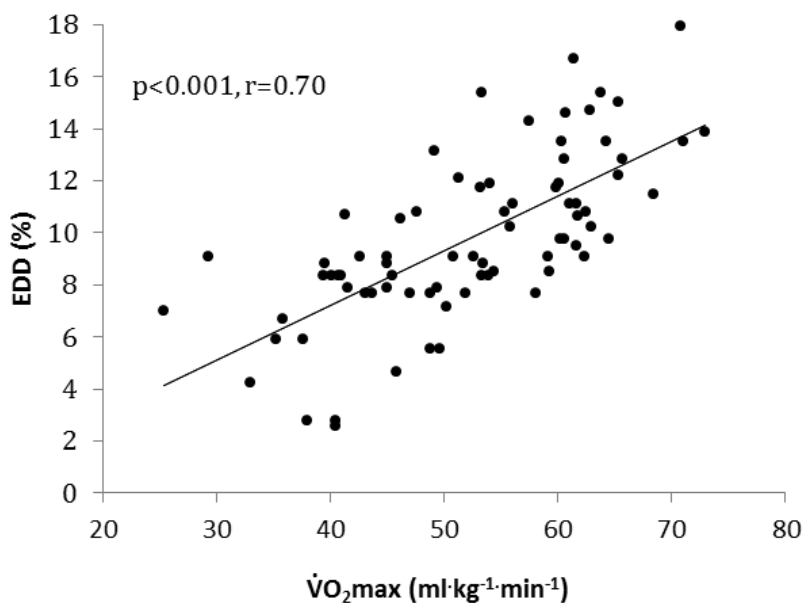

Figure 3.12 Relation between $\dot{V}O_2\text{max}$ and percent change in EDD

There was a significant positive relation between $\dot{V}O_2\text{max}$ (ml·kg⁻¹·min⁻¹) and HDL-C ($r=0.32$, $p=0.003$). There was a significant inverse association between $\dot{V}O_2\text{max}$ (ml·kg⁻¹·min⁻¹) and weight ($r=-0.61$, $p=0<001$), BMI ($r=-0.61$, $p<0.001$), SBP ($r=-0.79$, $p<0.001$), DBP ($r=-0.49$, $p<0.001$), waist circumference ($r=-0.40$, $p<0.001$), hip circumference ($r=-0.46$, $p<0.001$), sum of skinfolds ($r=-0.69$, $p<0.001$), glucose ($r=-0.39$, $p<0.001$), insulin ($r=-0.72$, $p<0.001$), HOMA-IR ($r=-0.71$, $p<0.001$), LDL-C ($r=-0.29$,

p=0.007), non HDL-C (r=-0.26, p=0.014), TG (r=-0.57, p<0.001) sICAM-1 (r=-0.38, p=0.001) and sVCAM-1 (r=-0.23, p=0.044).

Table 3.8 summarizes the significant univariate relation between EDD and selected CVD risk factors. The strongest correlation coefficients were found for the association between EDD and SBP (r=-0.60), sum of skinfolds (r=-0.57), BMI (r=-0.47), insulin (r=-0.44), HOMA-IR (r=-0.41) and TG (r=-0.46). There was a significant positive relation between HDL-C and the percent change in EDD (r=0.24, p=0.022).

Table 3.8: Univariate relation between EDD and selected CVD risk factors

	Correlation Coefficient	P value
Weight (kg)	r=-0.45	p=0.000
BMI (kg·m ²)	r=-0.47	p=0.000
SBP (mmHg)	r=-0.60	p=0.000
DBP (mmHg)	r=-0.36	p=0.000
Waist circumference (cm)	r=-0.23	p=0.047
Hip circumference (cm)	r=-0.27	p=0.016
Sum of skinfolds	r=-0.57	p=0.000
Glucose (mmol·L ⁻¹)	r=0.31	p=0.007
Insulin (mIU·L ⁻¹)	r=-0.44	p=0.001
HOMA-IR	r=-0.41	p=0.002
LDL-cholesterol (mg·dL ⁻¹)	r=-0.28	p=0.010
HDL-cholesterol (mg·dL ⁻¹)	r=0.24	p=0.022
Non HDL-cholesterol (mg·dL ⁻¹)	r=-0.22	p=0.039
Triglycerides (mg·dL ⁻¹)	r=-0.46	p=0.000

Univariate Correlations – cIMT

There was a significant inverse relation between Tanner stage and right CCA far wall cIMT (r=-0.24, p=0.018) and Tanner stage and left CCA far wall cIMT (r=-0.25, p=0.01). There was a significant inverse relation between $\dot{V}O_2\text{max}$ (ml·kg⁻¹·min⁻¹)

and right near wall cIMT ($r=-0.69$, $p<0.001$), left near wall cIMT ($r=-0.67$, $p<0.001$) right far wall cIMT ($r=-0.76$, $p<0.001$) and left far wall cIMT ($p<0.001$, $r=-0.67$) of the CCA.

Table 3.9 summarizes the univariate analysis between selected CVD risk factors and near and far wall cIMT of the right and left CCA. The strongest associations were found between right far wall cIMT of the CCA and SBP ($r=0.75$, $p=0.000$), sum of skinfolds ($r=0.60$, $p=0.000$), insulin ($r=0.56$, $p=0.000$) and HOMA-IR ($r=0.54$, $p=0.000$).

After adjustment for pubertal stage, SBP, sum of skinfolds, TG, insulin and HOMA-IR, the strength of the relation between $\dot{V}O_2\text{max}$ ($\text{ml}\cdot\text{kg}^{-1}\cdot\text{min}^{-1}$) and right CCA far wall IMT ($r=-0.47$, $p=0.001$) and left far wall cIMT of the CCA ($r=-0.44$, $p=0.001$) was reduced, but remained significant.

Table 3.9 Univariate analysis between selected CVD risk factors and cIMT

	cIMT			
	RT near wall	LT near wall	RT far wall	LT far wall
$\dot{V}O_2\text{max}$ ($\text{ml}\cdot\text{kg}^{-1}\cdot\text{min}^{-1}$)	$r=-0.69, p=0.000$	$r=-0.67, p=0.000$	$r=-0.76, p=0.000$	$r=-0.72, p=0.000$
$\dot{V}O_2\text{max}$ ($\text{L}\cdot\text{min}^{-1}$)	$r=-0.26, p=0.022$	$r=-0.31, p=0.006$	$r=-0.34, p=0.002$	$r=-0.27, p=0.017$
Weight (kg)	$r=0.50, p=0.000$	$r=0.45, p=0.000$	$r=0.53, p=0.000$	$r=0.53, p=0.000$
BMI ($\text{kg}\cdot\text{m}^{-2}$)	$r=0.51, p=0.000$	$r=0.43, p=0.000$	$r=0.51, p=0.000$	$r=0.53, p=0.000$
SBP (mmHg)	$r=0.67, p=0.000$	$r=0.62, p=0.000$	$r=0.75, p=0.000$	$r=0.67, p=0.000$
DBP (mmHg)	$r=0.40, p=0.000$	$r=0.36, p=0.001$	$r=0.40, p=0.000$	$r=0.39, p=0.000$
Waist circumference (cm)	$r=0.45, p=0.000$	$r=0.36, p=0.001$	$r=0.39, p=0.000$	$r=0.46, p=0.000$
Hip circumference (cm)	$r=0.47, p=0.000$	$r=0.42, p=0.000$	$r=0.43, p=0.000$	$r=0.48, p=0.000$
Sum of skinfolds	$r=0.54, p=0.000$	$r=0.49, p=0.000$	$r=0.60, p=0.000$	$r=0.56, p=0.000$
Glucose ($\text{mg}\cdot\text{dL}^{-1}$)	$r=0.27, p=0.019$	$r=0.27, p=0.021$	$r=0.34, p=0.003$	$r=0.34, p=0.002$
Insulin ($\text{mIU}\cdot\text{L}^{-1}$)	$r=0.53, p=0.000$	$r=0.54, p=0.000$	$r=0.56, p=0.000$	$r=0.53, p=0.000$
HOMA-IR	$r=0.49, p=0.000$	$r=0.51, p=0.021$	$r=0.54, p=0.000$	$r=0.53, p=0.000$
LDL-cholesterol ($\text{mg}\cdot\text{dL}^{-1}$)	ns	ns	$r=0.27, p=0.011$	$r=0.19, p=0.058$
HDL-cholesterol ($\text{mg}\cdot\text{dL}^{-1}$)	$r=-0.26, p=0.014$	$r=-0.32, p=0.003$	$r=-0.25, p=0.019$	$r=-0.24, p=0.023$
Non HDL-cholesterol ($\text{mg}\cdot\text{dL}^{-1}$)	ns	ns	$r=0.26, p=0.014$	$r=0.19, p=0.059$
Triglycerides ($\text{mg}\cdot\text{dL}^{-1}$)	$r=0.43, p=0.000$	$r=0.32, p=0.004$	$r=0.47, p=0.000$	$r=0.50, p=0.000$
IL-6 ($\text{ng}\cdot\text{mL}^{-1}$)	$r=0.27, p=0.025$	$r=0.35, p=0.003$	ns	$r=0.28, p=0.0017$
IL-6 ($\text{ng}\cdot\text{mL}^{-1}$)	ns	$r=0.30, p=0.022$	ns	ns
TNF- α ($\text{ng}\cdot\text{mL}^{-1}$)	$r=0.23, p=0.047$	ns	$r=0.23, p=0.045$	ns
ICAM-1 ($\text{ng}\cdot\text{mL}^{-1}$)	ns	ns	$r=0.30, p=0.011$	ns
VCAM-1 ($\text{ng}\cdot\text{mL}^{-1}$)	$r=0.21, p=0.041$	ns	ns	$r=0.25, p=0.019$
hsCRP ($\text{mg}\cdot\text{L}^{-1}$)				

Summary of Results

EDD was significantly higher and cIMT was significantly lower in HF and MF than LF. CVD risk factors including obesity, hypertension, and insulin resistance and elevated circulating TG were present in a large majority of LF participants. A large proportion of LF had advanced VA of both left and right CCA and impaired EDD.

In univariate analysis, CVD risk factors including SBP, HOMA-IR, insulin and TG were significantly related to EDD and cIMT. However, the strongest association was between $\dot{V}O_2\text{max}$ ($\text{ml}\cdot\text{kg}^{-1}\cdot\text{min}^{-1}$) and both EDD and cIMT. $\dot{V}O_2\text{max}$ was independently related to EDD and cIMT after adjustment for potential confounding variables.

Chapter IV

STUDY 2

OXYGEN UPTAKE EFFICIENCY SLOPE AND VASCULAR HEALTH IN MALE

ADOLESCENTS

Rationale

Cardiopulmonary exercise testing (CPET) is commonly used in clinical settings to assess the response to exercise in both healthy and diseased populations (Akkerman et al., 2010). Maximal oxygen uptake ($\dot{V}O_{2max}$) obtained during a progressive exercise test is recognized as the gold standard measurement of CRF. However, due to its effort dependency, a true plateau in $\dot{V}O_2$ during maximal exercise testing is seldom attained, particularly in overweight and obese pediatric populations (Marinov et al., 2003). The application of $\dot{V}O_{2max}$ testing may therefore be limited to healthy, trained and motivated individuals.

Maximal exhaustive exercise testing does not mimic the daily activities of children. Exercise performance at submaximal intensities may be better tolerated and more reflective of the intensity of activities undertaken by adolescents (Akkerman et al., 2010). The OUES derived from the linear relation between oxygen uptake and the logarithm of minute ventilation during incremental exercise has been proposed as an objective and effort independent submaximal measure of CRF (Baba et al., 1996). It is calculated using the equation; $\dot{V}O_2 = a \log \dot{V}_E + b$; where $\dot{V}O_2$ represents oxygen uptake ($\text{ml} \cdot \text{min}^{-1}$), the constant 'a' represents the rate of increase

in $\dot{V}O_2$ in response to an increasing \dot{V}_E (OUES), $\log \dot{V}_E$ is the common logarithm of \dot{V}_E and the constant 'b' represents the intercept (figure 2.1) (Bongers, 2013). The logarithm transformation of \dot{V}_E results in the linearization of the relation of $\dot{V}O_2$ versus \dot{V}_E during incremental exercise making the OUES theoretically effort independent (Mezzani et al., 2009). OUES reflects the integrative capacity of the respiratory, cardiovascular and musculoskeletal systems during aerobic exercise, but unlike $\dot{V}O_{2max}$, is independent of subject effort, and can be obtained during submaximal exercise (Arena et al., 2009). Children with higher $\dot{V}O_{2peak}$ values exhibit greater OUES values, reflecting greater oxygen uptake during exercise, than children with lower $\dot{V}O_{2peak}$ values (Akkerman et al., 2010).

Given its prognostic value in CAD and HF patients (Coeckelberghs et al., 2015, Davies et al., 2006) and its strong positive correlation with $\dot{V}O_{2max}$ in healthy children (Marinov et al., 2007, Akkerman et al., 2010) overweight/obese children (Breithaupt et al., 2012) and in children with chronic conditions such as cystic fibrosis and congenital heart disease (Bongers et al., 2012, Baba et al., 1996), OUES may be of clinical utility and may be used as a surrogate for $\dot{V}O_{2max}$ in the assessment of CRF. Cross-sectional studies in healthy children and adolescents have found a positive relation between $\dot{V}O_{2max}$ and cardiovascular health profile (Anderssen et al., 2007, Ekelund et al., 2007, Ruiz et al., 2007) and vascular health (Hopkins et al., 2009, Silva et al., 2014). In the only published study to examine OUES and vascular health, a significant inverse relation was found between OUES and arterial stiffness in healthy

middle-aged adults (Arena et al., 2009). To date, no published studies have examined the relation between OUES and vascular health in children and adolescents.

Study Purpose

The purpose of this study was to examine the relation between OUES and vascular health and to compare OUES in LF, MF and HF healthy male adolescents and to.

Specific Aims

1. To determine the relation between maximal OUES/submaximal OUES and $\dot{V}O_2\text{max}$ in healthy male adolescents and whether the OUES can be used as an alternative to $\dot{V}O_2\text{max}$ in the assessment of CRF in adolescents.
2. To examine the relation between both maximal OUES and submaximal OUES and EDD in healthy male adolescents.
3. To examine the relation between both maximal OUES and submaximal OUES and cIMT in healthy male adolescents.
4. To determine the predictors of EDD in a multivariate analyses.
5. To compare maximal OUES and submaximal OUES in LF, MF and HF adolescents.

Hypothesis

1. Both maximal OUES and submaximal OUES will be significantly related to $\dot{V}O_2\text{max}$ in healthy male adolescents and are suitable alternative measures to $\dot{V}O_2\text{max}$ in the assessment of CRF in adolescents.

2. There will be a significant positive linear relation between both maximal OUES and submaximal OUES and EDD in healthy male adolescents.
3. There will be a significant inverse relation between both maximal OUES and submaximal OUES and cIMT in healthy male adolescents.
4. $\dot{V}O_2\text{max}$ will be the primary predictor of EDD in a multiple linear regression analysis that includes $\dot{V}O_2\text{max}$ and OUES.
5. Maximal OUES and submaximal OUES will be significantly lower in LF than MF and HF healthy male adolescents.

Methodology

Overview of Study Design

As previously described in methods section of Chapter III

Participants

Nineteen LF (n=19), twenty-two MF (n=22) and twenty-two HF (n=22) healthy male adolescents aged 13-17 years participated in the study. These participants were a subset of Study 1.

Participant Recruitment

As previously described in methods section of Chapter III

Body Mass Index

As previously described in methods section of Chapter III

Body Surface Area

Body surface area (BSA) was calculated using the following equation of Haycock et al., (1978); $BSA (m^2) = 0.024265 \cdot Ht (cm)^{0.3964} \cdot Wt (kg)^{0.5378}$ (Haycock et al., 1978).

Maturation

As previously described in methods section of Chapter III

Endothelial Dependent Dilation and Endothelial Independent Dilation Assessment

As previously described in methods section of Chapter III

Carotid Intima Media Thickness

As previously described in methods section of Chapter III

Maximal Aerobic Capacity ($\dot{V}O_2\text{max}$)

As previously described in methods section of Chapter III

Oxygen Uptake Efficiency Slope (OUES)

Breath-by-breath gas data collected during the maximal exercise test was averaged at 20 sec intervals and stored in a database for off-line calculation of the OUES. The OUES was calculated by spreadsheet software (Microsoft Excel 2015) using the equation of Baba *et al.*, (1996); $\dot{V}O_2 = a \log_{VE} + b$ where the constant “a” represents the OUES, “logVE” represents the logarithm of \dot{V}_E and the constant ‘b’ represents the intercept (Appendix E). Specifically, $\dot{V}O_2$ and \dot{V}_E data used to calculate the OUES were expressed in liters/minute. \dot{V}_E was logarithmically transformed and the slope $\dot{V}O_2$ (y-axis) and \dot{V}_E (x-axis) was determined (Appendix E).

All data excluding the first min of exercise was used to calculate maximal OUES. The first min of exercise was excluded from the analysis to eliminate the confounding influence of hyperventilation that is common at the onset of exercise. Only exercise data up to the ventilatory anaerobic threshold (VAT) was included in

the analysis for determination of submaximal OUES. Relative values for $\dot{V}O_{2max}$, OUES and \dot{V}_E were calculated by dividing the absolute values by body mass and BSA.

Ventilatory Anaerobic Threshold

The ventilatory breakpoint method was used to determine the VAT. This involved plotting $\dot{V}O_2$ (x-axis) against \dot{V}_E (y-axis). The $\dot{V}O_2$ at which \dot{V}_E increased nonlinearly was used to determine the point of the VAT.

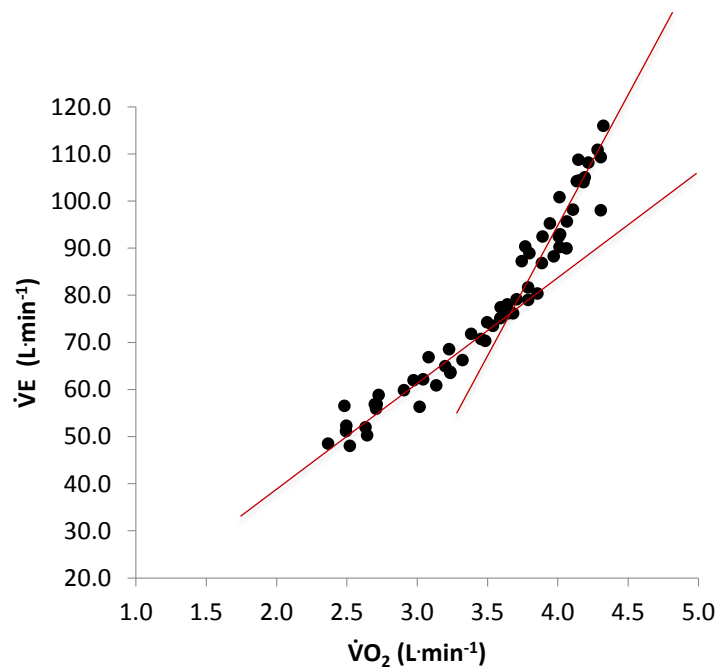

Figure 4.1: Example of how the VAT was determined

Cardiorespiratory and Metabolic Measures

As previously described in methods section of Chapter III

Mass Flow Sensor Heated Wire Anemometer- Mode of Operation

As previously described in methods section of Chapter III

Mass Flow Sensor Calibration

As previously described in methods section of Chapter III

Gas Analysers

As previously described in methods section of Chapter III

Calibration of CO₂ and O₂ Analysers

As previously described in methods section of Chapter III

Statistical Analysis

Prior to statistical analysis, the data was checked for normality using the Kolmogorov- Smirnov (K-S) test. A one-way ANOVA (parametric) and a Kruskal-Wallis test (non-parametric) were used to compare mean group differences. Significant main effects were probed using a Bonferroni post hoc test (parametric, equal variances assumed) or Games-Howell poc hoc test (parametric, equal variances not assumed) and Mann-Whitney U test (non-parametric). A paired sample t-test was used to compare differences between maximal and submaximal OUES. Univariate regression analysis was undertaken using the Pearson product-moment correlation. A multiple linear regression analysis that included $\dot{V}O_2$ max, maximal OUES and submaximal OUES was used to predict EDD using the stepwise method. Statistical significance was accepted at the $p < 0.05$ level of confidence. SPSS for Windows statistical software (V21.0, SPSS Inc, IL) was used to perform the statistical analysis.

RESULTS

Participant characteristics

Participant physical characteristics are summarized in table 4.1. Weight, BMI and BSA were significantly lower in HF and MF than LF. Tanner stage was higher ($p < 0.05$) in MF than LF. There was no significant difference in age and height between the three groups.

Table 4.1: Physical characteristics in participants

	Group		
	HF	MF	LF
Age (y)	15.77 ± 0.53	15.68 ± 0.57	15.32 ± 0.89
Height (cm)	173.47 ± 5.64	175.48 ± 7.09	176.40 ± 6.48
Weight (kg)	64.79 ± 6.61‡	64.63 ± 9.95‡	83.87 ± 18.05
BMI (kg·m ⁻²)	21.53 ± 2.05†	20.93 ± 2.56†	27.13 ± 6.42
BSA (m ²)	1.76 ± 0.11‡	1.77 ± 0.16‡	2.03 ± 0.24
Tanner stage (I-V)	4.09 ± 0.48	4.25 ± 0.51*	3.74 ± 0.69

Values are means ± SD; ‡p < 0.001 vs. LF, †p < 0.01 vs. LF, *p < 0.05 vs. LF

OUES and $\dot{V}O_2\text{max}$

Table 4.2 summarizes the significant relations between maximal and submaximal OUES parameters and $\dot{V}O_2\text{max}$. Maximal OUES/kg ($r=0.72$, $p < 0.001$) and submaximal OUES ($r=0.78$, $p < 0.001$) were both positively related to $\dot{V}O_2\text{max}$ (ml·kg⁻¹·min⁻¹), with a stronger association observed between submaximal OUES and $\dot{V}O_2\text{max}$ (ml·kg⁻¹·min⁻¹). (Table 4.2). Maximal OUES/kg and submaximal OUES/kg were significantly related to each other ($r=0.95$, $p=0.001$). There were also significant associations between $\dot{V}O_2\text{VT}$ and submaximal OUES/kg ($r=0.77$, $p < 0.000$) and

submaximal OUES/BSA ($r=0.67$, $p<0.001$). There was no relation between any maximal OUES variable and $\% \dot{V}O_2VT$. In contrast, there was a significant relation between $\% \dot{V}O_2VT$ and both submaximal OUES/kg ($r=0.32$, $p=0.016$) and submaximal OUES/BSA ($r=0.25$, $p=0.044$). V_E max was significantly related to maximal OUES ($r=0.31$, $p=0.008$), submaximal OUES ($r=0.39$, $p=0.003$), maximal OUES/BSA ($r=0.24$, $p=0.030$) and submaximal OUES/BSA ($r=0.31$, $p=0.016$).

Table 4.2 Univariate analysis between maximal and submaximal OUES parameters and absolute $\dot{V}O_2max$ and $\dot{V}O_2max$ relative to body weight and BSA

	$\dot{V}O_2max$ (L·min ⁻¹)	$\dot{V}O_2max$ (ml·kg ⁻¹ ·min ⁻¹)	$\dot{V}O_2max/BSA$ (ml·min ⁻¹ ·m ⁻²)
Maximal OUES	$r=0.67$, $p=0.000$	$r=0.23$, $p=0.038$	$r=0.46$, $p=0.000$
Maximal OUES/kg	$r=0.35$, $p=0.023$	$r=0.72$, $p=0.000$	$r=0.66$, $p=0.000$
Maximal OUES/BSA	$r=0.53$, $p=0.000$	$r=0.57$, $p=0.000$	$r=0.64$, $p=0.000$
Submaximal OUES	$r=0.73$, $p=0.000$	$r=0.39$, $p=0.004$	$r=0.60$, $p=0.000$
Submaximal OUES/kg	$r=0.42$, $p=0.002$	$r=0.78$, $p=0.000$	$r=0.73$, $p=0.000$
Submaximal OUES/BSA	$r=0.58$, $p=0.000$	$r=0.69$, $p=0.000$	$r=0.74$, $p=0.000$

OUES and EDD

There was a significant positive relation between maximal OUES/kg and both percent change in EDD ($r=0.51$, $p<0.001$) (figure 4.2) and absolute change ($r=0.52$, $P<0.001$) in EDD. After adjustment for pubertal stage, weight, BMI and BSA, the strength of the association between maximal OUES/kg and percent change in EDD ($r=0.38$, $p=0.001$) and maximal OUES/kg and absolute change in EDD ($r=0.43$, $p=0.001$) decreased, but remained significant.

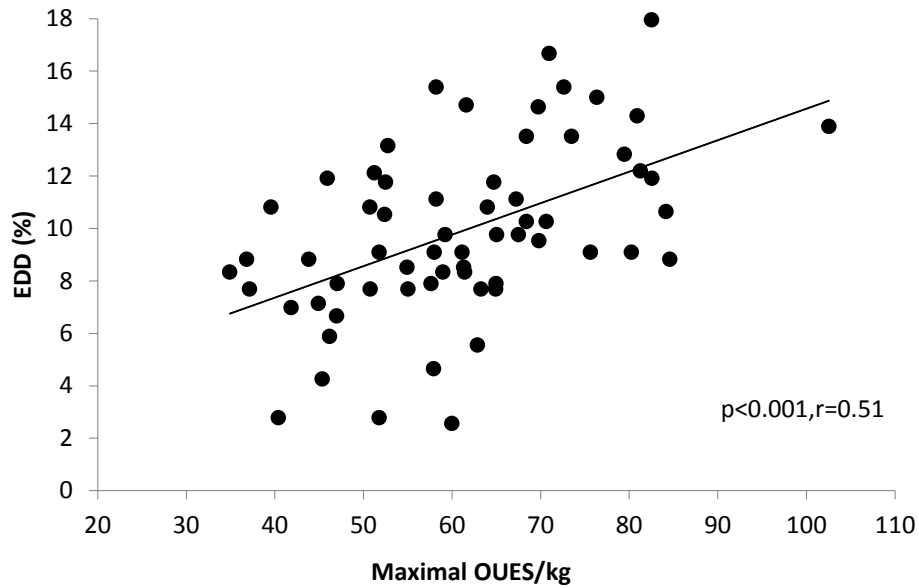

Figure 4.2 Relation between maximal OUES/kg and percent change in EDD

A stronger positive association was found between submaximal OUES/kg and both the percent change in EDD ($r=0.52$, $p<0.001$) (figure 4.3) and the absolute change in EDD ($r=0.56$, $P<0.001$) than maximal OUES/kg. After adjustment for pubertal stage, weight, BMI and BSA, the association between submaximal OUES and both the percentage change in EDD ($r=0.41$, $p=0.003$) and the absolute change in EDD ($r=0.50$, $p=0.001$) decreased, but remained significant.

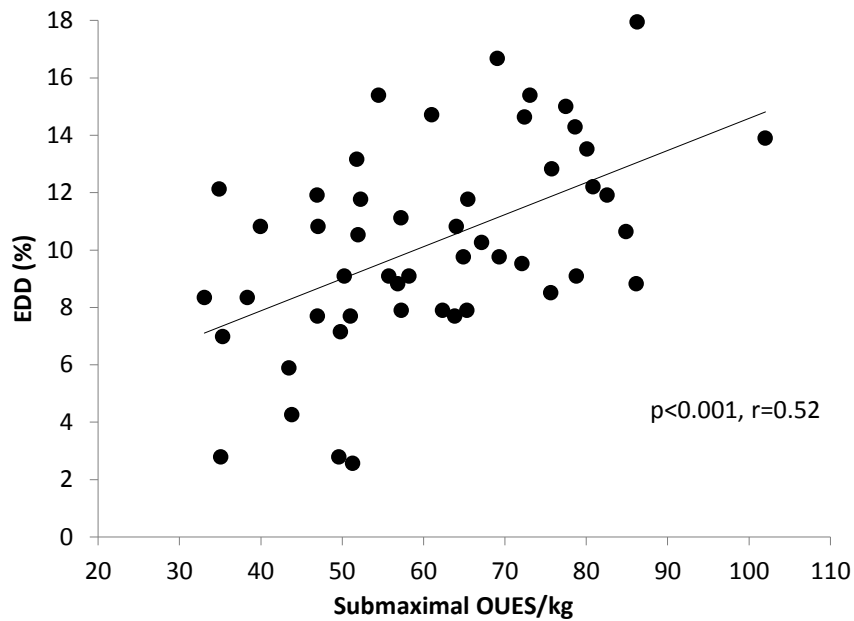

Figure 4.3 Relation between submaximal OUES/kg and percent change in EDD

Table 4.3 summarizes the significant univariate relations between selected physiological parameters at maximal exercise and EDD. The strongest relation was found between $\dot{V}O_2\text{max}$ and ($\text{ml}\cdot\text{kg}^{-1}\cdot\text{min}^{-1}$) and EDD. After adjustment for pubertal stage, weight, BMI and BSA, the relation between $\dot{V}O_2\text{max}$ ($\text{ml}\cdot\text{kg}^{-1}\cdot\text{min}^{-1}$) and the percent change in EDD ($r=0.60$, $p=0.001$) decreased, but remained significant. There was a significant positive relation between EDD and absolute $\dot{V}O_2\text{VT}$ ($\text{ml}\cdot\text{kg}^{-1}\cdot\text{min}^{-1}$) and $\% \dot{V}O_2\text{VT}$. The relation was much stronger for $\dot{V}O_2\text{VT}$ ($\text{ml}\cdot\text{kg}^{-1}\cdot\text{min}^{-1}$) than $\% \dot{V}O_2\text{VT}$. In a stepwise multiple linear regression analysis that included $\dot{V}O_2\text{max}$ ($\text{ml}\cdot\text{kg}^{-1}\cdot\text{min}^{-1}$), maximal OUES, maximal OUES/kg, submaximal OUES and submaximal OUES/kg, only $\dot{V}O_2\text{max}$ ($\text{ml}\cdot\text{kg}^{-1}\cdot\text{min}^{-1}$) was a significant predictor of EDD ($p<0.001$).

Table 4.3: Univariate relations between EDD and selected submaximal and maximal physiological parameters

	Correlation Coefficient	P value
$\dot{V}O_2\text{max}$ ($\text{ml}\cdot\text{kg}^{-1}\cdot\text{min}^{-1}$)	$r=0.72,$	$p<0.001$
$\dot{V}O_2\text{max}$ ($\text{L}\cdot\text{min}^{-1}$)	$r=0.37$	$p=0.001$
$\dot{V}O_2\text{max}/\text{BSA}$	$r=0.65$	$p<0.001$
Maximal OUES/kg	$r=0.51$	$p<0.001$
Maximal OUES/BSA	$r=0.39$	$p=0.001$
Submaximal OUES/kg	$r=0.52$	$p<0.001$
Submaximal OUES/BSA	$r=0.44$	$p=0.002$
V_E max	$r=0.31$	$p=0.007$
V_E max/BSA	$r=0.53$	$p<0.001$
$\dot{V}O_2\text{VT}$ ($\text{ml}\cdot\text{kg}^{-1}\cdot\text{min}^{-1}$)	$r=0.74$	$p<0.001$
$\% \dot{V}O_2\text{VT}$	$r=0.44$	$p=0.001$

$P<0.05$

OUES and cIMT

There was a significant inverse relation between both maximal OUES and submaximal OUES expressed relative to body weight and BSA and all measures of cIMT (Table 4.4). Of the OUES variables measured, the strongest association was observed between submaximal OUES expressed relative to body weight and cIMT. Table 4.4 summarizes the significant relations between other selected physiological characteristics during maximal exercise including OUES variables and near and far wall cIMT of the right and left CCA. The strongest associations were found to be between $\dot{V}O_2\text{max}$ ($\text{ml}\cdot\text{kg}^{-1}\cdot\text{min}^{-1}$) and right ($r=-0.67$, $p<0.001$) and left far wall cIMT ($r=-0.75$, $p<0.001$).

Table 4.4 Univariate analysis between physiological characteristics during exercise and cIMT

	cIMT			
	RT near wall	LT near wall	RT far wall	LT far wall
$\dot{V}O_2\text{max}$ (ml·kg ⁻¹ ·min ⁻¹)	r=-0.67, p=0.000	r=-0.67, p=0.000	r=-0.77, p=0.000	r=-0.75, p=0.000
$\dot{V}O_2\text{max}$ (L·min ⁻¹)	r=-0.26, p=0.026	r=-0.32, p=0.007	r=-0.41, p=0.000	r=-0.32, p=0.006
$\dot{V}O_2\text{max}$ (L·min ⁻¹)/BSA	r=-0.57, p=0.000	r=-0.61, p=0.000	r=-0.72, p=0.000	r=-0.67, p=0.000
Maximal OUES	ns	ns	ns	ns
Maximal OUES/kg	r=-0.40, p=0.001	r=-0.46, p=0.000	r=-0.53, p=0.000	r=-0.48, p=0.000
Maximal OUES/BSA	r=-0.26, p=0.026	r=-0.37, p=0.002	r=-0.41, p=0.000	r=-0.34, p=0.004
Submaximal OUES	ns	ns	r=-0.28, p=0.031	ns
Submaximal OUES/kg	r=-0.43, p=0.002	r=-0.46, p=0.001	r=-0.59, p=0.000	r=-0.57, p=0.000
Submaximal OUES/BSA	r=-0.35, p=0.002	r=-0.39, p=0.004	r=-0.51, p=0.000	r=-0.47, p=0.001
$\dot{V}e$ max	r=-0.33, p=0.006	r=-0.32, p=0.006	r=-0.39, p=0.001	r=-0.37, p=0.002
$\dot{V}e$ max/BSA	r=-0.57, p=0.000	r=-0.55, p=0.000	r=-0.62, p=0.000	r=-0.62, p=0.000
$\dot{V}O_2\text{VT}$ (ml·kg ⁻¹ ·min ⁻¹)	r=0.62, p=0.000	r=-0.66, p=0.000	r=-0.78, p=0.000	r=-0.77, p=0.000
% $\dot{V}O_2\text{VT}$	r=-0.26, p=0.045	r=-0.37, p=0.006	r=-0.39, p=0.004	r=-0.31, p=0.018

Maximal and Submaximal OUES values

Absolute and relative maximal and submaximal OUES values are presented in Table 4.5. Maximal OUES was significantly higher in HF than MF. Maximal OUES/kg was significantly higher in HF and MF than LF, and in HF than MF. Maximal OUES/BSA was significantly higher in HF than both MF and LF. Submaximal OUES, OUES/kg and OUES/BSA were significantly higher in HF than both MF and LF.

In HF, there was a significant difference between maximal OUES and submaximal OUES ($p=0.001$) and no difference between maximal and submaximal OUES relative to body weight or BSA. In MF and LF there was no significant difference between maximal OUES and submaximal OUES or between maximal and submaximal OUES relative to body weight or BSA.

Table 4.5 Maximal and submaximal OUES in participants

	Group		
	HF	MF	LF
Maximal OUES	4693.76 ± 771.39 ^a	3778.65 ± 732.29	4146.86 ± 943.41
Maximal OUES/kg	72.56 ± 10.59 ^{‡a}	59.16 ± 12.43*	49.99 ± 8.30
Maximal OUES/BSA	2657.46 ± 383.33 ^{‡a}	2142.02 ± 405.12	2032.98 ± 342.03
Submaximal OUES	4686.18 ± 837.60 ^a	3589.45 ± 808.31	3799.18 ± 783.93
Submaximal OUES/kg	73.40 ± 11.23 ^{‡a}	56.31 ± 14.18	46.51 ± 9.43
Submaximal OUES/BSA	2693.41 ± 415.11 ^{‡a}	2043.50 ± 466.52	1873.89 ± 300.97

Values are means ± SD; ‡ $p < 0.001$ vs. LF, * $p < 0.05$ vs. LF; ^a $p < 0.001$ vs. MF

The mean physiological and perceptual responses during the maximal graded exercise test are presented in table 4.6. Absolute $\dot{V}O_{2max}$ and $\dot{V}O_{2max}$ relative to both body weight and BSA was significantly higher in HF than MF and LF. $\dot{V}O_{2max}$ relative to body weight and BSA were significantly higher in MF than LF. Absolute \dot{V}_E max and \dot{V}_E max relative to both body weight and BSA was significantly higher in HF than LF and \dot{V}_E max relative to BSA was significantly higher in MF than LF. The relative oxygen uptake at VT ($\dot{V}O_{2VT}$) was higher ($p<0.001$) in both HF and MF than LF and $\% \dot{V}O_{2VT}$ was higher ($p<0.05$) in HF than LF. RER was higher ($p<0.05$) in HF and LF. There was no significant difference in maximum heart rate and RPE between the three groups. In total, 32% of the cohort did not achieve a plateau in oxygen consumption. Interestingly, a higher percentage of LF achieved a plateau in oxygen consumption (73.4%) than MF (68.2%) and HF (54.5). In addition, to a plateau in oxygen consumption, a number of secondary criterion including a respiratory exchange ratio (RER) > 1.0, heart rate (HR) >200 bpm and volitional fatigue (RPE 18-20) were used to verify attainment of attainment of $\dot{V}O_{2max}$. Attainment of at least two of the four criteria was required for the test to be considered maximal. Based on these criteria, a maximal test was achieved by all HF, MF and LF participants.

Table 4.6: Exercise parameters during the graded exercise test

	Group		
	HF	MF	LF
$\dot{V}O_2\text{max}$ (ml·kg ⁻¹ ·min ⁻¹)	63.52 ± 3.79‡ ^a	52.78 ± 4.02‡	40.17 ± 4.9
$\dot{V}O_2\text{max}$ (L·min ⁻¹)	4.12 ± 0.44‡ ^a	3.39 ± 0.47	3.31 ± 0.55
$\dot{V}O_2\text{max/BSA}$ (ml·kg ⁻¹ ·m ²)	2332.85 ± 152.74‡ ^a	1914.61 ± 138.00‡	1626.89 ± 153.83
HR max (beats·min ⁻¹)	199.59 ± 4.94	198.43 ± 5.53	197.39 ± 11.82
V_E max (L·min ⁻¹)	104.39 ± 14.19‡	94.49 ± 14.20	83.27 ± 17.33
V_E max/kg (L·min ⁻¹)	1.62 ± 0.22‡	1.47 ± 0.20	1.01 ± 0.16
V_E max/BSA (L·min ⁻¹ ·m ²)	59.27 ± 7.52	53.41 ± 6.22	40.90 ± 6.14
RER	1.13 ± 0.03*	1.11 ± 0.05	1.10 ± 0.07
RPE	18.91 ± 1.27	18.73 ± 1.64	19.06 ± 1.39
$\dot{V}O_2\text{VT}$ (ml·kg ⁻¹ ·min ⁻¹)	54.58 ± 4.62‡	45.26 ± 3.81‡	32.12 ± 5.58
% $\dot{V}O_2\text{VT}$	86.05 ± 6.02*	85.76 ± 3.58	80.73 ± 6.14

Values are means ± SD; ‡p < 0.001 vs. LF, *p < 0.05 vs. LF; ^ap < 0.001 vs. MF

Maximal OUES and submaximal OUES were significantly related to each other ($r=0.93$, $p=0.001$). There was also a significant positive relation between maximal OUES/kg and submaximal OUES/kg ($r=0.95$, $p=0.001$) and maximal OUES/BSA and submaximal OUES/BSA ($r=0.94$, $p=0.001$). Among HF, there was a significant positive association between maximal OUES and submaximal OUES ($r=0.99$, $p=0.001$), maximal OUES/kg and submaximal OUES/kg ($r=0.96$, $p=0.001$) and maximal OUES/BSA and submaximal OUES/BSA ($r=0.99$, $p=0.001$). Among MF, there was a significant positive relation between OUES and submaximal OUES ($r=0.998$, $p=0.001$), maximal OUES/kg and submaximal OUES/kg ($r=0.94$, $p=0.001$) and OUES/BSA and submaximal OUES/BSA ($r=0.93$, $p=0.001$). Among LF, there was a significant positive correlation between maximal OUES and submaximal OUES ($r=0.759$, $p=0.001$) and between maximal OUES/kg and submaximal OUES/kg ($r=0.589$, $p=0.034$). There was no association between maximal OUES/BSA and submaximal OUES/BSA.

Table 4.7 summarizes the univariate correlations between maximal and submaximal OUES and anthropometric parameters. There was a significant association between maximal OUES, maximal OUES/kg and submaximal OUES and weight, BMI and BSA. Submaximal OUES and submaximal OUES/BSA were significantly correlated with Tanner stage and weight, respectively.

Table 4.7 Univariate analysis between OUES and anthropometric parameters

	Age (yr)	Height (cm)	Weight (kg)	BMI (kg·m⁻²)	BSA (m²)	Tanner Stage (I-V)
Maximal OUES	Ns	Ns	r=0.37, p=0.001	r=0.36, p=0.002	r=0.37, p=0.001	Ns
Maximal OUES/kg	Ns	Ns	r=-0.47, p=0.000	r=-0.41, p=0.000	r=-0.47, p=0.000	Ns
Maximal OUES/BSA	Ns	Ns	Ns	ns	Ns	Ns
Submaximal OUES	Ns	Ns	Ns	ns	Ns	r=-0.30, p=0.020
Submaximal OUES/kg	Ns	Ns	r=-0.50, p=0.000	r=-0.47, p=0.000	r=-0.49, p=0.000	Ns
Submaximal OUES/BSA	Ns	Ns	r=-0.24, p=0.050	ns	Ns	Ns

P<0.05, ns= not significant

Summary of Results

OUES, a submaximal measure of CRF and has been suggested as potential surrogate for $\dot{V}O_2\text{max}$ in the assessment of CRF in children and adolescents. Both maximal and submaximal OUES were significantly correlated with $\dot{V}O_2\text{max}$ and were independently related to both EDD and cIMT in healthy male adolescents. Similar associations were found between maximal and submaximal OUES and EDD suggesting that the OUES calculated during submaximal exercise can be used to examine the relation between health CRF and vascular health. This is advantageous as maximal exercise testing in children and adolescents is not always feasible.

While a significant independent positive relation was found between both maximal OUES/kg and submaximal OUES/kg and EDD, a stronger association was observed between $\dot{V}O_2\text{max}$ and EDD. Furthermore, only $\dot{V}O_2\text{max}$ was retained in a linear regression analysis used to predict EDD that included maximal OUES/kg and submaximal OUES/kg.

Maximal OUES/kg was significantly higher in HF and MF than LF and in MF than LF. Maximal OUES/BSA, submaximal OUES/kg and submaximal OUES/BSA were significantly higher in HF than both MF and LF. Submaximal OUES values were slightly but significantly lower than maximal OUES. However, when these values were expressed relative to body weight and BSA, there was no significant difference in maximal and submaximal OUES showing that the OUES is effort independent.

Chapter V

STUDY 3

PHYSICAL ACTIVITY, SEDENTARY BEHAVIOUR, SELECTED CVD RISK FACTORS AND VASCULAR HEALTH IN MALE ADOLESCENTS

Rationale

Epidemiological studies in adults have demonstrated an inverse relation between PA and both CVD and all-cause mortality (Morris et al., 1953, Paffenbarger et al., 1986). In children and adolescents, objectively measured PA is independently associated with CMD risk (Ekelund et al., 2007, Ekelund et al., 2006). Regular PA enhances endothelial function through shear stress induced upregulation of eNOS, which subsequently increases the bioavailability of NO (Moyna & Thompson, 2004). Relatively few studies have examined the relation between objectively measured PA and vascular function in children and adolescents (Abbott et al., 2002, Pahkala et al., 2008, Hopkins et al., 2009). A cross sectional study examining the relation between objectively measured PA and brachial artery FMD in pre-pubertal children found that time spent in moderate and high intensity PA was significantly related to brachial artery FMD (Hopkins et al., 2009). To date no published studies have examined the relation between objectively measured PA and both vascular function and structure in healthy adolescents.

Current PA guidelines recommend that Irish children and adolescents aged 2-17 years undertake at least 60 min of daily MVPA (Get Ireland Active). Alarming,

results from a large observational study examining PA levels in Irish children and adolescents found that 81% of primary and 88% of post primary pupils do not meet the current PA recommendations (Woods et al., 2010). The effect of low levels of PA on vascular health in adolescents is not known.

Sedentary behavior has recently emerged as a distinct risk factor for CVD and all-cause mortality independent of traditional CVD risk factors and PA (Dunstan et al., 2010, Healy et al., 2007, Owen et al., 2010). While the mechanisms responsible for the adverse cardiometabolic effects associated with sedentary behaviour are not fully understood, it appears that the deleterious effect may be partially mediated by a reduction in LPL activity (Tremblay et al., 2010). Low levels of LPL are associated with increased circulating triglycerides and decreased HDL-C (Hamilton et al., 2007). Other potential mechanisms include a reduction in insulin action (Stephens et al., 2011) and glucose uptake (Hamilton et al., 2004, Stephens et al., 2011).

It is estimated that European children aged 12-18 years spend on average currently spend on average 9 h per day or 71% of their waking hours in sedentary behaviours (Ruiz et al., 2011). Findings from cross sectional studies examining the relation between objectively measured sedentary behaviour and CVD risk factors in children and adolescents have been equivocal (Tremblay et al., 2014). Some studies report no relation between sedentary behaviour and CVD risk after adjustment for MVPA (Hsu et al., 2011, Steele et al., 2009, Mitchell et al., 2010) while others found a significant relation between sedentary time and CVD risk factors, independent of PA (Atkin et al., 2013, Henderson et al., 2012).

In addition to metabolic health, limited evidence in adults suggests that sedentary behavior may also have deleterious effects on vascular function (Hamburg et al., 2008, Demiot et al., 2007). Sedentary behavior induces hemodynamic alterations within the vasculature, in particular low shear stress which results in a direct reduction in NO bioavailability (Thosar et al., 2012) and increased oxidative stress (Laufs et al., 2005). In children aged 9-10 years, Hopkins *et al.*, (2012) found no relation between brachial artery FMD and objectively measured total sedentary time and between seasonal change in sedentary behaviour and change in FMD (Hopkins et al., 2012). With the majority of studies having examined the relation between sedentary time and CVD risk factors solely and limited studies examining the relation of sedentary behaviour and vascular health, the proposed study will be unique in that it will be the first study to examine sedentary behaviours and both CVD risk factors and vascular health in healthy adolescents in addition to PA behaviours. This study will also examine the relation between sedentary behaviour and vascular health independent of MVPA, as findings in this area have been equivocal.

Study Purpose

The purpose of this study was to compare PA levels, sedentary behaviour, selected CVD risk factors and vascular health in LF, MF and HF apparently healthy male adolescents and to examine the relation between both PA and sedentary behaviours and CVD risk factors and vascular health in healthy male adolescents.

Specific Aims

1. To compare serum blood lipids, fasting glucose, insulin, HOMA-IR, pro-inflammatory cytokines, vascular adhesion molecules, BP, body composition, EDD, cIMT, time spent sitting/lying, number and time spent in sedentary bouts <20 min, >20min, >30 min and >60 min, time standing, LIPA, LIPA including standing and MVPA, in LF, MF and HF healthy male adolescents.
2. To examine the relation between time spent in LIPA and MVPA and EDD and time spent in LIPA and MVPA and cIMT in healthy male adolescents.
3. To examine the relation between sedentary behaviour and EDD and sedentary behaviour and cIMT in healthy male adolescents independent of MVPA.

Hypothesis

1. Number of sedentary bouts <20 min and time spent in sedentary bouts <20 min, time spent in LIPA and MVPA, HDL-C and EDD will be significantly lower and time spent sitting/lying and in sedentary bouts >20 min, >30 min and >60 min, TC, LDL-C, TG, fasting glucose, insulin, HOMA-IR, pro-inflammatory

cytokines, sICAM-1, sVCAM-1, BP, sum of skinfolds, waist-to-hip ratio, BMI, cIMT will be significantly higher in LF than MF and HF healthy male adolescents.

2. There will be a significant positive relation between time spent in LIPA and MVPA and EDD and a significant inverse relation between time spent in LIPA and MVPA and cIMT in healthy male adolescents.
3. Sedentary behavior will be significantly related to EDD and cIMT independent of MVPA.

Methodology

Study Overview

As previously described in methods section of Chapter III

Participants

Eighteen LF (n=18), eighteen MF (n=18) and eighteen HF (n=18) healthy male adolescents aged 13-17 years participated in the study. These participants were a subset of Study 1.

Participant recruitment

As previously described in methods section of Chapter III

Body Mass Index

As previously described in methods section of Chapter III

Waist-to-Hip Ratio

As previously described in methods section of Chapter III

Body fat

As previously described in methods section of Chapter III

Maturation

As previously described in methods section of Chapter III

Blood Pressure

As previously described in methods section of Chapter III

Blood Sampling

As previously described in methods section of Chapter III

Biochemical Analysis

As previously described in methods section of Chapter III

Insulin Sensitivity

As previously described in methods section of Chapter III

Pro-inflammatory cytokines assays

As previously described in methods section of Chapter III

Vascular Adhesion molecules assays

As previously described in methods section of Chapter III

Endothelial Dependent Dilation and Endothelial Independent Dilation Assessment

As previously described in methods section of Chapter III

Carotid Intima Media Thickness

As previously described in methods section of Chapter III

Physical Activity and Sedentary Behaviour Measurement

The ActivPAL³TM triaxial physical activity logger (PAL Technologies Ltd., Glasgow, UK) (figure 5.1) is a single unit triaxial accelerometer measuring (53 x 35 x 7 mm) and weighs approximately 15 g. The device samples at 10 Hz and measures bodily accelerations using a triaxial accelerometer. The ActivPAL³TM provides information on steps and activity counts which can be used to determine PA levels and inclinometer information used to determine posture. The data was allocated into 15 s epochs of sitting/lying, standing, and stepping using the on-board microprocessor. Proprietary algorithms provided outputs including time spent sitting/lying, standing, in LIPA, LIPA including standing, MVPA and step counts.



Figure 5.1 : ActivPAL³TM triaxial physical activity logger

Each participant was provided with an ActivPAL³TM and given a verbal description and written demonstration of its use. Participants were instructed to wear the device continuously for 7 d, except during water activity periods. The ActivPal³TM was worn on the midpoint of the anterior aspect of the right thigh and attached using a TegadermTM film adhesive frame dressing (Figure 5.2) (3M Health Care, Neuss, Germany). If required, an elastic tube bandage was worn over the device for further

stability. After 7 d, the ActivPAL³[™] was retrieved and the data was downloaded to a PC via a USB interface.



Figure 5.2: ActivPAL³[™] placement

Data Processing

For data to be included in the analysis, participants were required to provide ≥ 4 valid days, including one weekend day, where a valid day was defined as ≥ 600 min of recording during daytime hours, i.e., 7 am to 11 pm (Troost, McIver, & Pate, 2005). Non-wear time was defined as ≥ 60 min of continuous unbroken zero counts from the output data file (Harrington et al., 2011). Recorded data was accessed using the ActivPAL[™] proprietary software (ActivPAL[™] Professional VX) and exported to a Microsoft Excel format file (Microsoft Excel 2010, Microsoft Corporation, WA, USA). Data was displayed as the number of seconds that the participants engaged in sitting/lying, standing, and stepping for each 15 s epoch. Values were summed over a 24 h period to provide the total time spent sitting/lying, standing and stepping and the average time spent in these behaviour categories during the recording period were calculated.

Sedentary Behaviour

Sedentary behaviour characteristics were further examined by processing the ActivPAL™ data output files using a customized MATLAB® (version 7.0.1, Mathworks Inc, Natick, MA, USA) computer software programme (Harrington et al., 2011). The customized MATLAB® programme examined the ActivPAL™ output file epoch-by-epoch and binary coded each epoch. A sedentary epoch was categorized as an epoch spent entirely sitting/lying, i.e., a full 15 s, (code = 1) and a non-sedentary epoch was categorized as an epoch containing >0 s of standing or stepping or <15 s of sitting/lying (code = 0) (Dowd et al., 2012). A sedentary epoch identified the start of a sedentary bout and the last consecutive sedentary epoch marked the end of the sedentary bout. Daily sedentary bout duration and the number of sedentary bouts were calculated. Sedentary bouts were categorized by specific durations, namely <20 min, >20 min, >30min, >60 min to determine shorter and more prolonged sedentary behaviours. The number and total duration spent in sedentary bouts in each category were calculated.

Percentage non bed time in sedentary activities of specific duration, were identified by calculating bed hours and waking hours. A start time of 7.00 am was used to identify the start time for each 24 h measurement day and the first registered non-sedentary epoch of the day identified as rise time (Dowd et al., 2012). Bed time was identified as the last unregistered epoch of the day which was followed by a long, uninterrupted sedentary period (> 2 h) (Dowd et al., 2012). Bed hours were calculated as the sum of the time between 7.00 am and the first non-sedentary epoch and the

time between the last non-sedentary-epoch and the next 7.00 am time point. Waking hours were then calculated by subtracting bed hours from 24 h (Dowd et al., 2012).

Statistical Analysis

Prior to statistical analysis the data was checked for normality using the Kolmogorov- Smirnov (K-S) test. A one-way ANOVA (parametric) and a Kruskal-Wallis test (non-parametric) were used to compare selected CMD risk factors, endothelial function, cIMT, PA and sedentary behaviours physiological and perceptual responses during maximal exercise between LF, MF and HF groups. Significant main effects were probed using a Bonferroni post-hoc test (parametric, equal variances assumed) or Games-Howell post-hoc test (parametric, equal variances not assumed) and Mann-Whitney U test (non-parametric). Statistical significance was accepted at the $p < 0.05$ level of confidence. Univariate analysis was undertaken using the Pearson product-moment correlation. Partial correlations were undertaken using the Pearson product moment correlation. SPSS for Windows statistical software (V21.0, SPSS Inc, IL) was used to perform the statistical analysis.

RESULTS

Participant characteristics

Participant physical characteristics, blood pressure and maximal aerobic capacity are summarized in Table 5.1. Weight, BMI, waist circumference, hip circumference, sum of skinfolds, SBP, DBP and $\dot{V}O_2\text{max}$ ($\text{ml}\cdot\text{kg}^{-1}\cdot\text{min}^{-1}$) were significantly lower in HF and MF than LF. Weight, sum of skinfolds, SBP and $\dot{V}O_2\text{max}$ ($\text{ml}\cdot\text{kg}^{-1}\cdot\text{min}^{-1}$) was significantly lower in HF than MF. Absolute $\dot{V}O_2\text{max}$ was significantly higher in HF than LF. Tanner stage was significantly higher in MF than LF.

Table 5.1 Physical characteristics, blood pressure and maximal aerobic capacity

	Group		
	HF	MF	LF
Age (y)	15.67 ± 0.49	15.67 ± 0.59	15.44 ± 0.78
Height (cm)	171.57 ± 6.69	175.43 ± 7.16	176.67 ± 4.98
Weight (kg)	60.34 ± 6.31 ^{‡c}	68.18 ± 10.50*	81.37 ± 20.29
BMI ($\text{kg}\cdot\text{m}^{-2}$)	20.48 ± 1.76 [†]	22.07 ± 2.55*	26.08 ± 6.43
Waist circumference (cm)	69.41 ± 2.60*	65.16 ± 16.63*	80.49 ± 19.08
Hip circumference (cm)	74.12 ± 4.72*	71.65 ± 18.40*	87.96 ± 19.99
Waist-to-hip ratio	0.94 ± 0.04	0.91 ± 0.04	0.92 ± 0.08
Sum of skinfolds	28.40 ± 10.25 ^{‡c}	44.59 ± 19.13*	81.91 ± 39.09
Tanner Stage	4.08 ± 0.43	4.19 ± 0.55*	3.64 ± 0.74
SBP (mmHg)	113.00 ± 7.08 ^{‡a}	123.61 ± 5.01 [†]	131.28 ± 8.54
DBP (mmHg)	74.06 ± 5.05 [‡]	77.28 ± 5.29 [†]	81.78 ± 4.37
$\dot{V}O_2\text{max}$ ($\text{ml}\cdot\text{kg}^{-1}\cdot\text{min}^{-1}$)	63.31 ± 3.89 ^{‡a}	52.95 ± 4.07 [‡]	40.76 ± 4.36
$\dot{V}O_2\text{max}$ ($\text{L}\cdot\text{min}^{-1}$)	3.82 ± 0.40 [†]	3.52 ± 0.51	3.26 ± 0.65

Values are means ± SD; [‡]p < 0.001 vs. LF, [†]p < 0.01 vs. LF, *p < 0.05 vs. LF; ^ap < 0.001 vs. MF, ^cp < 0.05 vs. MF

Blood Lipids

Fasting serum lipid levels are presented in Table 5.2. Fasting TG were significantly lower in HF and MF than LF. There were no significant differences in TC, HDL-C, LDL-C and non HDL-C between the three groups.

Table 5.2 Fasting serum levels of circulating blood lipids in participants

	Group		
	HF	MF	LF
Total cholesterol (mg·dL ⁻¹)	137.12 ± 24.53	134.38 ± 24.32	143.39 ± 26.97
HDL-cholesterol (mg·dL ⁻¹)	42.36 ± 11.35	42.67 ± 8.52	35.96 ± 10.01
LDL-cholesterol (mg·dL ⁻¹)	76.80 ± 16.54	72.50 ± 20.20	91.63 ± 24.05
Non HDL-cholesterol (mg·dL ⁻¹)	94.76 ± 17.67	91.71 ± 19.93	107.43 ± 22.46
Triglycerides (mg·dL ⁻¹)	56.15 ± 24.67*	55.95 ± 16.44 ^c	77.73 ± 25.01

Values are means ± SD; *p < 0.05 vs. LF, ^cp < 0.05 vs. MF

Insulin Sensitivity

Fasting glucose, insulin and HOMA-IR in participants are presented in Table 5.3. Glucose and insulin were significantly lower in HF and MF than LF. HOMA-IR was significantly lower in HF than MF and LF.

Table 5.3 Fasting serum levels of glucose, insulin and HOMA-IR

	Group		
	HF	MF	LF
Glucose (mg·dL ⁻¹)	78.53 ± 7.67*	80.76 ± 5.99*	84.65 ± 7.92
Insulin (mIU·L ⁻¹)	4.17 ± 1.41‡	6.20 ± 1.88*	10.06 ± 5.17
HOMA-IR	0.82 ± 0.33‡ ^c	1.24 ± 0.38*	2.12 ± 1.16

Values are means ± SD; ‡p < 0.001 vs. LF, *p < 0.05 vs. LF, ^cp < 0.05 vs. MF

Inflammatory Markers and Adhesion Molecules

Circulating levels of pro-inflammatory cytokines and vascular adhesion molecules are summarized in Table 5.4. There was no significant difference in any of the inflammatory cytokines and vascular adhesion molecules between the groups.

Table 5.4 Pro-inflammatory cytokines and vascular adhesion molecules

	Group		
	HF	MF	LF
IL-1 (ng·mL ⁻¹)	0.98 ± 0.14	0.11 ± 0.14	0.11 ± 0.13
IL-6 (ng·mL ⁻¹)	0.39 ± 0.26	0.53 ± 0.59	0.38 ± 0.22
TNF- α (ng·mL ⁻¹)	1.37 ± 0.70	1.54 ± 0.77	1.79 ± 0.52
INF- γ (ng·mL ⁻¹)	5.77 ± 4.06	6.70 ± 5.02	5.91 ± 4.31
SAA (ng·mL ⁻¹)	2508.10 ± 786.13	5162.57 ± 5277.41	2592.07 ± 687.38
hsCRP (mg·L ⁻¹)	0.83 ± 0.72	0.91 ± 1.06	1.28 ± 1.43
sICAM-1 (ng·mL ⁻¹)	682.74 ± 81.70	745.75 ± 110.61	781.74 ± 193.29
sVCAM-1 (ng·mL ⁻¹)	834.44 ± 199.59	913.94 ± 227.47	896.58 ± 158.02

Values are means ± SD

Physical Activity and Sedentary Behaviour

Total Time in Physical Activity and Sedentary Behaviour

The mean total daily time over a 24 h period spent in PA behaviours, sitting/lying and steps per day are summarized in Table 5.5. The total time spent standing, in LIPA and in LIPA including standing was significantly higher in HF than LF. Total time spent in MVPA and steps per day were significantly higher in HF than both MF and LF. Total time spent sitting/lying was significantly lower in HF than MF and LF. There were no significant differences in any of the PA behaviours and total sitting/lying time between MF and LF.

Table 5.5 Total time spent in sitting/lying, standing, LIPA and MVPA and the number of steps per day

	Group		
	HF	MF	LF
Steps per day	13871.10 ± 2778.75 ^{‡b}	10600.70 ± 2563.49	9649.48 ± 3475.34
Sitting/lying (h)	17.59 ± 1.07 ^{‡c}	18.58 ± 0.94	19.37 ± 1.34
Standing (h)	3.59 ± 0.86 [*]	3.32 ± 0.72	2.74 ± 1.00
LIPA (h)	0.86 ± 0.25 [‡]	0.70 ± 0.22	0.59 ± 0.21
LIPA Inc. standing (h)	4.45 ± 1.02 [‡]	4.02 ± 0.86	3.33 ± 1.16
MVPA (h)	1.94 ± 0.49 ^{†c}	1.40 ± 0.55	1.30 ± 0.59

Values are means ± SD; ‡p < 0.001 vs. LF, †p < 0.01 vs. LF, *p < 0.05 vs. LF; ^bp < 0.01 vs. MF, ^cp < 0.05 vs. MF

Waking/Sleeping hours

The total number of sleeping hours (8.95 ± 0.68), MF (8.87 ± 0.56) and LF (8.87 ± 0.56) and waking hours (15.05 ± 0.68), MF (15.13 ± 0.56) and LF (14.66 ± 0.84) was similar in the three groups.

Percentage of Waking Hours Spent Sitting/Lying and in PA Behaviours

The percentage of mean daily waking hours spent sitting/lying and in PA behaviours are presented in table 5.6. The percentage of time spent sitting/lying during waking hours was significantly lower in HF than both MF and LF. The percentage of waking hours spent standing, in LIPA and in LIPA including standing was significantly higher in HF than LF. The percentage of time spent in MVPA during waking hours was significantly higher in HF than both MF and LF. There were no significant differences in the percentage of time spent sitting/lying and percentage of time in any of the PA behaviours between MF and LF.

Table 5.6 Percentage of waking hours spent in sitting/lying, standing, LIPA and MVPA per day

	Group		
	HF	MF	LF
Sitting/lying (%)	57.45 ± 7.82 ^{‡c}	63.98 ± 6.04	68.46 ± 9.14
Standing (%)	23.85 ± 5.70 *	22.13 ± 4.81	18.64 ± 6.81
LIPA (%)	5.71 ± 1.83 [†]	4.68 ± 1.48	4.07 ± 1.45
LIPA inc. standing (%)	29.56 ± 6.95*	26.80 ± 5.64	22.72 ± 7.96
MVPA (%)	12.90 ± 3.63 ^{†c}	9.25 ± 3.56	8.85 ± 3.93

Values are means ± SD; ‡p < 0.001 vs. LF, †p < 0.01 vs. LF, *p < 0.05 vs. LF; ^c p < 0.05 vs. MF.

Number of sedentary bouts

The number of bouts spent in short and longer uninterrupted sedentary behaviour categories is presented in table 5.7. The total number of sedentary bouts was significantly higher in HF and MF than LF. The number of sedentary bouts < 20 min was significantly higher in HF and MF than LF. The number of sedentary bouts > 20 min and > 30 min was significantly lower in HF than MF and LF. The number of sedentary bouts > 60 min was significantly lower in HF than LF. With the exception of total number of sedentary bouts and the number of sedentary bouts < 20 min, there was no difference in the number of sedentary bouts between MF and LF.

Table 5.7 Number of daily bouts spent in sedentary categories

	Group		
	HF	MF	LF
Total number of sedentary bouts	56.93 ± 8.6†	55.78 ± 9.9*	47.11 ± 9.6
No. of sedentary bouts <20 min	49.49 ± 9.63†	46.75 ± 11.32*	38.14 ± 9.62
No. of sedentary bouts >20min	7.43 ± 1.69† ^c	9.02 ± 1.93	8.98 ± 2.10
No. of sedentary bouts >30 min	4.16 ± 1.51† ^c	5.54 ± 1.74	5.9 ± 1.65
No. of sedentary bouts >60 min	0.98 ± 0.63‡	1.40 ± 0.76	1.93 ± 0.85

Values are means ± SD; ‡p < 0.001 vs. LF, †p < 0.01 vs. LF* p < 0.05 vs. LF, ^cp < 0.05 vs. MF

Sedentary bout duration

The duration of sedentary bouts spent in sedentary categories is summarized in table 5.8. There was no significant difference in time spent in sedentary bouts < 20 min between the three groups. The total time spent in sedentary bouts and time spent in sedentary bouts >20 min and > 30 min was significantly lower in HF than LF. Time spent in sedentary bouts > 60 min was significantly lower in HF and MF than LF. With the exception of time spent in sedentary bouts > 60 min, there was no difference in time spent in sedentary behaviour between MF and LF.

Table 5.8 Duration of daily sedentary bouts spent in sedentary categories

	Group		
	HF	MF	LF
Total sedentary time (min)	507.62 ± 95.33‡	577.41 ± 71.47	621.05 ± 109.39
Sedentary bouts <20 min	202.98 ± 31.05	208.16 ± 48.52	180.42 ± 39.09
Sedentary bouts >20 min	304.64 ± 97.16‡	369.25 ± 105.21	440.63 ± 124.62
Sedentary bouts >30 min	224.09 ± 97.16†	284.17 ± 100.57	365.43 ± 123.25
Sedentary bouts >60 min	92.93 ± 63.92†	120.14 ± 68.26†	207.49 ± 121.33

Values are means ± SD; ‡p < 0.001 vs. LF, †p < 0.01 vs. LF, ^cp < 0.05 vs. MF

PA behaviours and $\dot{V}O_2\text{max}$

The relation between $\dot{V}O_2\text{max}$ and selected PA behaviours is presented in table 5.9. With the exception of absolute $\dot{V}O_2\text{max}$ and total time standing, and absolute $\dot{V}O_2\text{max}$ and % of waking day spent in LIPA, there was a significant positive relation between either relative $\dot{V}O_2\text{max}$ or absolute $\dot{V}O_2\text{max}$ and all measured PA behaviours.

Table 5.9 Summary of the relation between PA behaviours and $\dot{V}O_2\text{max}$

	$\dot{V}O_2\text{max}$ ($\text{ml}\cdot\text{kg}^{-1}\cdot\text{min}^{-1}$)	$\dot{V}O_2\text{max}$ ($\text{L}\cdot\text{min}^{-1}$)
Total standing (h)	$r=0.45, p=0.000$	ns
Total LIPA (h)	$r=0.45, p=0.000$	$r=0.41, p=0.001$
Total MVPA (h)	$r=0.41, p=0.001$	$r=0.37, p=0.003$
Total LIPA inc. standing (h)	$r=0.48, p=0.000$	$r=0.27, p=0.026$
Total steps	$r=0.49, p=0.000$	$r=0.42, p=0.001$
Standing waking hours (%)	$r=0.42, p=0.001$	$r=0.43, p=0.000$
LIPA waking hours (%)	$r=0.41, p=0.001$	ns
LIPA inc. standing waking hours (%)	$r=0.45, p=0.000$	$r=0.26, p=0.028$
MVPA waking hours (%)	$r=0.39, p=0.002$	$r=0.36, p=0.004$

$P<0.05$, ns= not significant

Sedentary behaviours and $\dot{V}O_2\text{max}$

The relation between sedentary behaviours and $\dot{V}O_2\text{max}$ are presented in table 5.10. With the exception of the number of sedentary bouts < 20 min and time spent in sedentary bouts < 20 min, there was a significant inverse relation between all measured sedentary behaviours and $\dot{V}O_2\text{max}$. There was a significant positive relation between both relative $\dot{V}O_2\text{max}$ and absolute $\dot{V}O_2\text{max}$ and time spent in sedentary bouts and the number of sedentary bouts < 20 min.

Table 5.10: Relation between sedentary behaviours and $\dot{V}O_2\text{max}$

	$\dot{V}O_2\text{max}$ ($\text{ml}\cdot\text{kg}^{-1}\cdot\text{min}^{-1}$)	$\dot{V}O_2\text{max}$ ($\text{L}\cdot\text{min}^{-1}$)
Total sitting/lying (h)	$r=-0.59, p=0.000$	$r=-0.39, p=0.002$
Sitting/lying waking hours (h)	$r=-0.46, p=0.000$	$r=-0.41, p=0.001$
Sitting/lying waking hours (%)	$r=-0.55, p=0.000$	$r=-0.38, p=0.002$
No. of sedentary bouts < 20 min	$r=0.49, p=0.000$	$r=0.44, p=0.000$
Time in sedentary bouts < 20 min (min)	$r=0.29, p=0.017$	$r=0.40, p=0.001$
No of sedentary bouts > 20 min	$r=-0.45, p=0.000$	$r=-0.36, p=0.004$
Time in sedentary bouts > 20 min	$r=-0.59, p=0.000$	$r=-0.45, p=0.000$
No. of sedentary bouts > 30 min	$r=-0.54, p=0.000$	$r=-0.49, p=0.000$
Time in sedentary bouts > 30 min (min)	$r=-0.61, p=0.000$	$r=-0.48, p=0.000$
No. of sedentary bouts > 60 min	$r=-0.51, p=0.000$	$r=-0.57, p=0.000$
Time in sedentary bouts > 60 min (min)	$r=-0.53, p=0.000$	$r=-0.42, p=0.001$
Total number of sedentary bouts	$r=-0.45, p=0.000$	$r=-0.41, p=0.001$
Total time in sedentary bouts (min)	$r=-0.58, p=0.000$	$r=-0.37, p=0.003$

Relation between PA behaviours and CVD risk factors

Table 5.11 summarizes the relation between PA behaviours and selected CVD risk factors. The percentage of time spent in MVPA during waking hours was significantly and inversely related to SBP, DBP, TG and sICAM-1. The percentage of time spent in LIPA during waking hours was significantly related to sum of skinfolds, SBP, DBP, glucose, TG and sICAM-1. The percentage of time spent in LIPA including standing during waking hours was inversely related to weight, BMI, WC, hip circumference, sum of skinfolds, SBP, DBP, TG, insulin, HOMA-IR, INF- γ and sICAM-1.

Table 5.11: Correlation coefficients between PA behaviours during waking hours and CVD risk factors

	Physical Activity Behaviours		
	LIPA	LIPA inc. standing	MVPA
Body Composition			
Weight (kg)	ns	r=-0.25, p=0.032	ns
BMI (kg·m ⁻²)	ns	r=-0.31, p=0.010	ns
Sum of skinfolds	r=-0.23, p=0.051	r=-0.29, p=0.016	ns
Waist circumference (cm)	ns	r=-0.36, p=0.004	ns
Hip circumference (cm)	ns	r=-0.38, p=0.002	ns
Blood Pressure			
SBP (mmHg)	r=-0.37, p=0.003	r=-0.39, p=0.002	r=-0.33, p=0.007
DBP (mmHg)	r=-0.29, p=0.016	r=-0.27, p=0.023	r=-0.28, p=0.022
Metabolic Risk Factors			
Triglycerides (mg·dL ⁻¹)	r=-0.38, p=0.005	r=-0.34, p=0.010	r=-0.36, p=0.007
Glucose	r=-0.26, p=0.032	ns	ns
Insulin	ns	r=-0.28, p=0.043	ns
HOMA-IR	ns	r=-0.29, p=0.039	ns
Inflammatory Markers			
INF-γ (ng·mL ⁻¹)	ns	r=-0.35, p=0.031	ns
ICAM-1 (ng·mL ⁻¹)	r=-0.42, p=0.001	r=-0.40, p=0.002	r=-0.27, p=0.028

P<0.05, ns= not significant

Sedentary time and CVD risk factors

The percentage of time spent sitting and lying during waking hours was positively correlated with weight ($r=0.24, p=0.038$), SBP ($r=0.48, p=0.000$), DBP ($r=0.35, p=0.005$), BMI ($r=0.31, p=0.011$), sum of skinfolds ($r=0.33, p=0.008$), glucose, ($r=0.25, p=0.037$), insulin ($r=0.27, p=0.050$) HOMA-IR ($r=0.29, p=0.042$) and sICAM-1 ($r=0.46, p=0.001$).

Endothelial Function

EDD and EID – Group Comparisons

Resting brachial artery diameter and the percentage change and absolute change in EDD and EID are presented in table 5.5. Resting brachial artery diameter was similar in the three groups. The percentage change in EDD was significantly higher in HF than LF. There was no significant difference in percent change in EDD between MF and LF. The percentage change in EID was similar in the three groups. The absolute change in EDD was significantly higher in HF and MF than LF and in HF than MF. There was no difference in the absolute change in EID between the three groups. There was no significant difference in peak blood flow velocities following reactive hyperemia between the three groups. There was also no difference in peak shear rate (SR_{peak}) between the three groups.

Table 5.12 Resting brachial artery diameter and absolute and percentage change in EDD and EID

	Group		
	HF	MF	LF
Brachial artery diameter (cm)	0.40 ± 0.06	0.37 ± 0.04	0.36 ± 0.04
EDD (%)	12.11 ± 2.39‡	10.04 ± 2.40	7.62 ± 2.04
EDD (cm)	0.05 ± 0.01‡ ^c	0.04 ± 0.01*	0.03 ± 0.01
EID (%)	20.12 ± 5.29	21.08 ± 4.79	19.35 ± 6.12
EID (cm)	0.08 ± 0.02	0.08 ± 0.02	0.07 ± 0.02

Values are means ± SD; ‡p < 0.001 vs. LF, *p < 0.05 vs. LF. ^cp < 0.05 vs. MF

Physical Activity and Endothelial Function

The relation between PA behaviours and both the percentage and absolute change in EDD are presented in table 5.13. There was a significant moderate positive relation between the total time spent over a 24 h period in standing, LIPA, LIPA including standing, and MVPA and both the percentage and absolute change in EDD. There was a significant moderate positive relation between total daily steps accumulated and both the percentage and absolute change in EDD. There was a significant moderate positive relation between the percentage of time spent in LIPA, LIPA including standing, and MVPA during waking hours and both the percentage and absolute and in EDD.

Table 5.13 Correlation coefficients between PA behaviours and EDD

	Percent change in EDD	Absolute change in EDD
Total (h)		
Standing	r=0.37, p=0.004	r=0.32, p=0.011
LIPA	r=0.48, p=0.000	r=0.49, p=0.000
LIPA including standing (h)	r=0.42, p=0.001	r=0.38, p=0.003
MVPA	r=0.37, p=0.004	r=0.50, p=0.000
Total steps	r=0.46, p=0.000	r=0.56, p=0.000
Percentage of Waking Hours		
Standing	r=0.34, p=0.008	r=0.31, p=0.015
LIPA	r=0.44, p=0.001	r=0.46, p=0.000
LIPA including standing	r=0.39, p=0.003	r=0.36, p=0.000
MVPA	r=0.33, p=0.010	r=0.47, p=0.000

LIPA = light intensity physical activity, MVPA = moderate to vigorous intensity physical activity, EDD = endothelial dependent dilation

After adjusting for pubertal stage, SBP, sum of skinfolds and $\dot{V}O_2\text{max}$ ($\text{ml}\cdot\text{kg}^{-1}\cdot\text{min}^{-1}$), percent of time spent in MVPA and percent of time spent sitting and lying, the relation between total time spent in LIPA and both the percentage change ($r=0.27$, $p=0.035$) and absolute change EDD remained statistically significant, the relation between the percentage of time spent in LIPA during waking hours and the absolute change EDD ($r=0.25$, $p=0.052$) remained significant, whereas the percentage change in EDD ($r=0.23$, $p=0.068$) was no longer significant. After adjusting for the same potential confounding variables, no significant relation was found between the total time spent in LIPA (including standing) and the percentage of time spent in this behaviour during waking hours and both the percent change and absolute change in EDD

After adjusting for pubertal stage, SBP, sum of skinfolds, relative $\dot{V}O_2\text{max}$ and percentage of time spent sitting/lying, the relation between both the total MVPA

hours and the percentage of time spent in MVPA during waking hours and the percent change in EDD were no longer significant. The relation between the absolute change in EDD and total MVPA hours ($r=0.31$, $p=0.022$) and the percentage of time spent in MVPA during waking hours ($r=0.26$, $p=0.045$) remained statistically significant.

$\dot{V}O_2$ max and Endothelial Function

There was a significant positive relation between $\dot{V}O_2$ max ($\text{ml}\cdot\text{kg}^{-1}\cdot\text{min}^{-1}$) and both the percentage change ($r=0.68$, $p<0.001$) and absolute change ($r=0.74$, $p<0.001$) in EDD. After statistically adjusting for pubertal stage, sum of skinfolds, SBP, percent of time spent in MVPA and percent of time sitting/lying during waking hours the association between $\dot{V}O_2$ max and the percentage change ($r=0.28$, $p=0.032$) and absolute change ($r=0.32$, $p=0.017$) in EDD remained statistically significant.

Sedentary Behaviour and Endothelial Function

The relation between sedentary behaviours and both percentage and absolute change in EDD are presented in table 5.14. There was a significant moderate inverse relation between the total time spent sitting/lying in a 24 h period, and during waking hours and both the percentage change and absolute change in EDD. There was a significant moderate inverse relation between the percentage of time spent sitting/lying during waking hours and the percentage and absolute change in EDD.

There was a significant low to moderate positive relation between the total number of sedentary bouts and the number of sedentary bouts < 20 min and both the percentage and absolute change in EDD. There was a significant low to moderate inverse relation between the number and duration of sedentary bouts > 20 min, >30 min and >60 min and both the percentage change and absolute change in EDD. There was a significant low to moderate positive relation between both the percentage and absolute change in EDD and the total accumulated minutes of sedentary bouts and the duration of sedentary bouts < 20 min.

After statistically adjusting for the percentage of waking hours spent in MVPA, the association between the total sedentary time over a 24 hour period ($r=-0.43$, $p<0.05$), total sedentary time during waking hours ($r=-0.24$, $p=0.051$) and the percentage of time spent sedentary during waking hours ($r=-0.36$, $p<0.05$) and percentage change in EDD remained significant.

After statistically adjusting for pubertal stage, sum of skinfolds, SBP, percentage of waking hours in MVPA and relative $\dot{V}O_2\text{max}$, the association between the total time and the percentage of time spent sitting and lying during waking hours, and the percentage and absolute change in EDD no longer remained statistically significant.

Table 5.14 Correlation coefficients between sedentary behaviours and EDD

	Percent change in EDD	Absolute change in EDD
Total sitting/lying in a 24 h period (h)	r=-0.52, p=0.000	r=-0.54, p=0.000
Total sitting/lying waking hours (h)	r=-0.37, p=0.004	r=-0.43, p=0.001
Sitting/lying waking hours (%)	r=-0.47, p=0.000	r=-0.51, p=0.000
No of sedentary bouts (n)		
< 20 min	r=0.33, p=0.010	r=0.34, p=0.008
> 20 min	r=-0.39, p=0.002	r=-0.37, p=0.004
> 30 min	r=-0.47, p=0.000	r=-0.45, p=0.001
> 60 min	r=-0.28, p=0.026	r=-0.34, p=0.007
Total	r=0.28, p=0.026	r=0.30, p=0.019
Duration of sedentary bouts (min)		
< 20 min	r=0.25, p=0.039	r=0.25, p=0.038
> 20 min	r=-0.46, p=0.000	r=-0.45, p=0.001
> 30 min	r=-0.47, p=0.000	r=-0.47, p=0.000
> 60 min	r=-0.36, p=0.006	r=-0.38, p=0.003
Total min	r=-0.44, p=0.001	r=-0.42, p=0.001

P<0.05, ns= not significant

Carotid Intima Media Thickness

cIMT - Group Comparisons

Near and far wall cIMT measurements of the right and left CCA are presented in table 5.15. Right and left CCA near and far wall IMT were significantly lower in HF and MF than LF and in HF than MF.

Table 5.15 Near and far wall cIMT measurements of right and left CCA

	Group		
	HF	MF	LF
Right near wall cIMT (mm)	0.39 ± 0.04‡ ^c	0.45 ± 0.05*	0.52 ± 0.07
Left near wall cIMT (mm)	0.38 ± 0.03‡ ^c	0.45 ± 0.08*	0.52 ± 0.08
Right far wall cIMT (mm)	0.40 ± 0.05‡ ^a	0.51 ± 0.06*	0.57 ± 0.06
Left far wall cIMT (mm)	0.40 ± 0.05‡ ^a	0.49 ± 0.06*	0.56 ± 0.08

Values are means ± SD; ‡p < 0.001 vs. LF, *p < 0.05 vs. LF; ^ap < 0.001 vs. MF, ^cp < 0.05 vs. MF

Physical Activity and cIMT

The correlation between PA behaviours and cIMT are summarized in table 5.16. There was a significant inverse relation between all measures of cIMT and both the total time and the percentage of waking hours for standing, LIPA and LIPA including standing. With the exception of the right far wall cIMT there was no significant association between MVPA and cIMT. There was a significant inverse association between total daily steps and right near and fall and left far wall cIMT.

After statistically adjusting for pubertal stage, sum of skinfolds, $\dot{V}O_2\max$ ($\text{ml}\cdot\text{kg}^{-1}\cdot\text{min}^{-1}$) SBP and percent of time spent sitting/lying during waking hours, the association between the percent of time spent in LIPA during waking hours and

right CCA far wall cIMT ($r=-0.05$, $p=0.380$) and the percent of time spent in LIPA during waking hours and left CCA far wall cIMT ($r=-0.25$, $p=0.043$) remained statistically significant.

Table 5.16 Correlation coefficients between PA behaviours and cIMT

	Carotid Intima Media Thickness			
	RT near wall	LT near wall	RT far wall	LT far wall
Total (h)				
Standing	r=-0.48, p=0.001	r=-0.25, p=0.039	r=-0.34, p=0.007	r=-0.37, p=0.003
LIPA	r=-0.44, p=0.001	r=-0.34, p=0.007	r=-0.37, p=0.003	r=-0.44, p=0.001
LIPA including standing	r=-0.51, p=0.000	r=-0.29, p=0.021	r=-0.37, p=0.004	r=-0.41, p=0.001
MVPA	ns	ns	r=-0.27, p=0.026	ns
Total steps	r=-0.37, p=0.004	ns	r=-0.41, p=0.001	r=-0.38, p=0.003
Percentage of Waking Hours				
Standing	r=-0.44, p=0.001	r=-0.23, p=0.054	r=-0.32, p=0.011	r=-0.35, p=0.005
LIPA	r=-0.40, p=0.002	r=-0.34, p=0.008	r=-0.35, p=0.006	r=-0.41, p=0.001
LIPA including standing	r=-0.46, p=0.000	r=-0.27, p=0.029	r=-0.35, p=0.006	r=-0.39, p=0.002
MVPA	ns	ns	r=-0.26, p=0.30	ns

P<0.05, ns= not significant

$\dot{V}O_2\text{max}$ and cIMT

There was a significant inverse relation between $\dot{V}O_2\text{max}$ ($\text{ml}\cdot\text{kg}^{-1}\cdot\text{min}^{-1}$) and right near wall ($r=-0.73$, $p<0.001$), right far wall ($r=-0.75$, $p<0.001$) cIMT and left near wall ($r=-0.65$, $p<0.001$) and left far wall cIMT ($r=-0.70$, $p<0.001$). Following adjustment for pubertal stage, sum of skinfolds, SBP, percent of time spent in MVPA during waking hours and percent of time spent sitting/lying, the association between $\dot{V}O_2\text{max}$ ($\text{ml}\cdot\text{kg}^{-1}\cdot\text{min}^{-1}$) and right CCA far wall cIMT was no longer significant. In contrast, the inverse relation between $\dot{V}O_2\text{max}$ ($\text{ml}\cdot\text{kg}^{-1}\cdot\text{min}^{-1}$) and left CCA far wall cIMT weakened but remained significant ($r=-0.41$, $p=0.002$).

Sedentary Behaviour and cIMT

The relation between sedentary behaviours and cIMT are summarized in Table 5.17. There was a significant relation between the total time spent sitting/lying in a 24 h period, and during waking hours and all measures of cIMT. There was also a significant relation between the percentage of time spent sitting/lying during waking hours and all measures of cIMT. With the exception of right far wall cIMT there was a significant relation between the number sedentary bouts >20 min, >30 min and >60 min and all measures of cIMT. There was a significant relation between the total number of sedentary bouts and the number of sedentary bouts <20 min and all measures of cIMT.

With the exception of right far wall cIMT there was a significant relation between the duration of sedentary bouts >20 min, >30 min and >60 min and all

measures of cIMT. There was a significant relation between the total time of sedentary bouts and all measures of cIMT. Left near wall was the only IMT measurement that was significantly related to sedentary bouts < 20 min ($r=-0.32$, $p=0.01$).

After statistically adjusting for the percentage of waking hours spent in MVPA, the association between the total sedentary time over a 24 hour period ($r=0.40$, $p<0.05$), total sedentary time during waking hours ($r=0.30$, $p<0.05$) and the percentage of time spent sedentary during waking hours ($r=0.26$, $p<0.03$) and left far wall cIMT remained significant. The association between these measures of sedentary behaviour and right far wall cIMT were no longer significant after adjustment for percentage of time spent in MVPA.

Following adjustment for pubertal stage, SBP sum of skinfolds and percent of time spent in MVPA during waking hours and relative $\dot{V}O_{2\max}$, there was no significant association between the percent of time spent sitting/lying during waking hours and right and left far wall cIMT and total time spent sitting and lying during waking hours and right and left far wall cIMT.

Table 5.17 Relation between sedentary behaviours and cIMT

	Carotid Intima Media Thickness			
	RT near wall	LT near wall	RT far wall	LT far wall
Total sitting/lying (h)	r=0.50, p=0.000	r=0.25, p=0.039	r=0.43, p=0.001	r=0.43, p=0.001
Sitting/lying waking hours (h)	r=0.37, p=0.004	r=0.27, p=0.028	r=0.35, p=0.006	r=0.39, p=0.002
Sitting/lying hours (%)	r=0.44, p=0.001	r=0.24, p=0.046	r=0.41, p=0.001	r=0.41, p=0.001
No of sedentary bouts				
< 20 min	r=-0.38, p=0.003	r=-0.43, p=0.001	r=-0.31, p=0.013	r=-0.33, p=0.008
> 20 min	r=0.31, p=0.014	r=0.35, p=0.005	r=0.33, p=0.008	r=0.42, p=0.001
> 30 min	r=0.35, p=0.005	r=0.41, p=0.002	r=0.41, p=0.001	r=0.44, p=0.001
> 60 min	r=0.34, p=0.007	r=0.37, p=0.004	ns	r=0.25, p=0.037
Total	r=-0.35, p=0.006	r=-0.40, p=0.002	r=-0.27, p=0.026	r=-0.27, p=0.024
Duration of sedentary bouts (min)				
< 20 min	Ns	r=-0.32, p=0.011	ns	ns
> 20 min	r=0.42, p=0.001	r=0.42, p=0.001	r=0.33, p=0.008	r=0.38, p=0.003
> 30 min	r=0.42, p=0.001	r=0.42, p=0.001	r=0.35, p=0.006	r=0.37, p=0.004
> 60 min	r=0.40, p=0.002	r=0.37, p=0.004	ns	r=0.24, p=0.042
Total sedentary bouts (min)	r=0.42, p=0.001	r=0.37, p=0.004	r=0.33, p=0.008	r=0.37, p=0.004

P<0.05, ns= not significant

Summary of Results

Both total time over 24 h and the percentage of waking hours standing, in LIPA, and in LIPA including standing was significantly higher in HF than LF. Total time and the percent of time spent in MVPA during waking hours were significantly higher in HF than both MF and LF. There were no significant differences in the total time and percentage of time spent in the measured PA behaviours between MF and LF.

There was a significant positive relation between the total time, and the percent of time in LIPA and MVPA during waking hours and EDD. Following adjustment for potential confounders, these associations were no longer significant. There was a significant inverse relation between the percent of time spent in sitting/lying during waking hours and EDD. The association between sedentary time and EDD remained significant after adjustment for MVPA. $\dot{V}O_2\text{max}$ was also independently related to EDD after statistically adjusting for confounders. There was no significant association between all measures cIMT and the percentage of time spent in LIPA during waking hours after adjusting for potential confounders. Sedentary behaviours were positively associated with left far wall cIMT following adjustment for MVPA. $\dot{V}O_2\text{max}$ ($\text{ml}\cdot\text{kg}^{-1}\cdot\text{min}^{-1}$) was also independently related to left far wall cIMT after adjustment for confounders.

Chapter VI

DISCUSSION

Overview

Atherosclerosis, a chronic inflammatory disease, primarily of large and medium-sized conduit arteries, is the primary underlying cause of CVD (Libby et al., 2010). Although the clinical manifestations of CVD occur in middle and late adulthood, the atherosclerotic process begins in childhood in response to exposure to established and unknown risk factors.

As clinical CV events are rare in children and adolescents, the ability to measure structural and functional markers of sub-clinical atherosclerosis non-invasively is a critical aspect of early detection and risk classification (Berenson, 2002). Increased cIMT and impaired brachial artery FMD has been found in adolescents with ACVD risk factors including overweight (Woo et al., 2004), obesity (Meyer et al., 2006, Zhu et al., 2005) and diabetes mellitus (Jarvisalo et al., 2004). Low levels of CRF (Blair et al., 1989)(Blair et al., 1996) and PA (Andersen et al., 2006) , Paffenbarger et al., 1986) and increased sedentary behaviour (Dunstan et al., 2010) are independent risk factors for CVD and all-cause mortality in adults. Such behaviours induce hemodynamic alterations within the vasculature, in particular low shear stress that results in a direct reduction in NO bioavailability and increased oxidative stress.

A series of studies were undertaken to compare indices of CRF, PA and sedentary behaviour, CVD risk factors and vascular health in apparently healthy LF, MF and HF male adolescents and to examine the association between each of these behaviours (CRF, PA and sedentary behaviour) and vascular health.

Study 1

Study 1 compared selected CVD risk factors, cIMT and endothelial function in apparently healthy LF, MF and HF male adolescents and examined the relation between $\dot{V}O_2\text{max}$ and vascular health. Established CVD risk factors cluster in adolescents with low levels of CRF with 48% being classified as obese, 75% hypertensive (NIH, 2005) and 41% having borderline to high fasting TG (American Academy of Pediatrics, 2011). The important role of CRF in reducing CVD risk in children is illustrated by the fact that no participant in HF was classified as obese, hypertensive or hypertriglyceridemia, and with the exception of SBP and HOMA-IR there was no significant difference in CVD risk factors between HF and MF. Data from NHANES in the US found significantly higher TG and SBP and significantly lower HDL-C in adolescent males with a low $\dot{V}O_2\text{max}$ compared to those with a high $\dot{V}O_2\text{max}$ (Carnethon et al., 2005).

The inverse association between CRF and clustered metabolic risk in children may be mediated by adiposity (Shaibi et al., 2005, Rizzo et al., 2007). However, after adjusting for SBP, sum of skinfolds, TG, insulin and HOMA-IR, the relation between CRF and vascular health remained significant in study 1. In a large sample of children between the age of 9 and 15 years, the odds ratio for the clustering of metabolic risk

factors was 15.8 for boys in the lowest CRF quartiles compared to those in the highest quartile (Anderssen et al., 2007). The assessment of CRF is not mandatory in Irish post-primary schools. This is surprising considering that the severity of atherosclerosis is associated with the presence and extent of CVD risk factors and that among Irish teenagers the greatest clustering of risk factors was found in the LF group. These findings highlight the urgent need to develop of a comprehensive national strategy to increase CRF levels among school children.

Considerable evidence exists for the adverse effects of obesity on cardiovascular disease risk. Using the statistical technique of principal components analysis, Goodman *et al.*, (2005) reduced modifiable CVD risk factors that cluster in children and are significantly inter-correlated to a smaller number of summary factors that retain as much variance as possible as the original variables. These summary risk factors were identified as adiposity, cholesterol, carbohydrate-metabolic and blood pressure. Obesity was identified as the most important correlate for being at risk for each the summary factors (Goodman et al., 2005). Almost 50% of the LF participants in study 1 were classified as obese. The high prevalence of obesity in this study was perhaps not surprising, considering that global levels of overweight and obesity in children and adolescents mirrors trends in adults. It has been estimated that the worldwide prevalence of childhood obesity has increased by approximately 40% between 1980 and 2013 (Aver et al., 2015).

In a meta-analysis that included 49,220 school aged children between the age of 5 and 15 years, Friedemann *et al.*, (2012) found that the presence of

overweight and obesity significantly worsens risk parameters for CVD. Compared to normal weight children, resting SBP, DBP and TG levels were significantly higher and HDL-C significantly lower in overweight and obese than normal weight children. Glucose, insulin and insulin resistance were also significantly raised in obese children. The gradient effect of an increased BMI on CVD risk parameters was substantial. For example, the mean difference in SBP between normal weight and obese children was 40% higher than the difference between normal and overweight children. Circulating levels of TC and LDL-C were 7.5 and 9 times higher respectively, in the obese versus normal weight comparison than in the overweight versus normal weight comparison. If this magnitude of difference persists into adulthood, then obese children may already be at a much higher risk than normal weight children for both fatal and non-fatal cardiovascular events.

Ultrasonographically determined cIMT is a non-invasive surrogate marker for ACVD. Both near wall and far wall IMT of the right and left CCA was significantly higher in LF than MF and HF and in MF than HF. Increased cIMT has previously been found in children and adolescents with ACVD risk factors and with low CRF (Meyer et al., 2006, Farpour-Lambert et al., 2009). Currently, normative cIMT values for children and adolescents are limited (Le et al., 2010). Advanced VA, defined as having a mean far wall IMT \geq 25th percentile for age and race matched healthy 45 year olds, may serve as a useful adjunct until normative cIMT data for children is established (Le et al., 2010). Advanced VA was found in 54% of the study cohort, with the highest proportion in LF. In addition, 32% of LF had a VA comparable to a healthy

normal 55-65 year old male. In the only published study to examine VA in children and adolescents, Le *et al.*, (2010) also found VA in a 12-16 year olds with ACVD risk factors that included hypertension, dyslipidemia and insulin resistance.

Among the CVD risk factors measured, $\dot{V}O_2\text{max}$ had the strongest association with cIMT in a univariate analysis. The association between $\dot{V}O_2\text{max}$ and cIMT remained significant after controlling for adiposity, SBP, HOMA-IR, insulin, TG and pubertal stage. The fact that $\dot{V}O_2\text{max}$ was independently related to cIMT, suggests that a low $\dot{V}O_2\text{max}$ may be considered an important marker for advanced VA and should be routinely measured in post-primary school students, particularly those with low CRF levels. Indeed, assessment of CRF may be a cost-effective way to identify children with one of more modifiable CVD risk factors and at an increased risk for VA.

The vascular endothelium is an active paracrine organ that plays an important role in maintaining vascular homeostasis and is intimately involved in the initiation and progression of atherosclerosis. Damage to the vascular endothelium represents one of the earliest events in the pathogenesis of atherosclerosis and precedes structural changes in the vascular wall (Deanfield *et al.*, 2007). Impaired endothelial function has previously been reported in children and adolescents with ACVD risk factors and low $\dot{V}O_2\text{max}$ (Meyer *et al.*, 2006, Farpour-Lambert 2009, Tounian *et al.*, 2001, Aggoun *et al.*, 2008). In study 1, brachial artery FMD was impaired in the majority of LF participants. EDD was significantly higher in HF and MF than LF and in HF compared to MF. A brachial artery FMD <8% is defined as impaired EDD and was present in 54%, 28% and 0% of the LF, MF and HF, respectively. Severe

impairment of EDD, defined as FMD <5.5% was found in 21% of LF. The deleterious effect of CVD risk factors on reduced NO bioavailability and increased production of ROS may partly explain the impairment in EDD.

The prevalence of impaired EDD was also very high among participants who were obese (41%) and hypertensive (63%). Not surprisingly, in univariate analysis, obesity, SBP along with sum of skinfolds, insulin and HOMA-IR were independently associated with EDD. After adjusting for each of these risk factors, $\dot{V}O_{2\max}$ remained strongly associated with EDD. In the only previous published study to examine brachial artery FMD and objectively measured $\dot{V}O_{2\text{peak}}$ in youth, Hopkins *et al.*, (2009) found a significant relation between %FMD/SR_{AUC} and $\dot{V}O_{2\text{peak}}$ in pre-pubertal children. Furthermore, $\dot{V}O_{2\text{peak}}$ was significantly lower in children in the lowest tertile for FMD than those who were in the upper tertile for FMD (Hopkins *et al.*, 2009).

With the recognition that atherosclerosis is an inflammatory process (Libby *et al.*, 2010) a number of blood biomarkers have been identified as putative indicators of subclinical CVD in disease in children. Although TNF- α , hsCRP, sICAM-1 and sVCAM-1 were higher in LF than MF and HF, the difference did not reach statistical significance. Similarly, Kapiotis *et al.*, (2006) found no difference in sICAM-1 and sVCAM-1 between obese children with impaired EDD and increased cIMT, and healthy normal weight children (Kapiotis *et al.*, 2006). In contrast, others have reported increased circulating levels of hsCRP, E-selectin, thrombomodulin and fibrinogen in obese children and adolescents with impaired EDD, increased cIMT and

low CRF (Farpour-Lambert et al., 2009, Meyer et al., 2006). The variability in body weight in LF may help to explain the lack of significance. Approximately one-third of LF were classified as normal weight or underweight. It may be that excess weight is a prerequisite for the stimulation and release of markers such as TNF- α , IL-6 and hsCRP, since adipocytes partially mediate the inflammatory response.

High concentrations of pro-inflammatory cytokines are associated with impaired endothelial function through their direct effect on NO production or indirectly by increasing ROS generation. Interestingly, in study 1, none of the pro-inflammatory markers were associated with EDD. In a previous study, hsCRP was found to be a significant and independent predictor for brachial artery FMD and cIMT in healthy 11 year old children (Jarvisalo et al., 2002). Compared to children with hsCRP levels under the detection limit, children with higher hsCRP had significantly lower brachial artery FMD and significantly higher cIMT (Jarvisalo et al., 2002). Similarly, LF participants had significantly lower brachial artery FMD and significantly higher cIMT than MF and HF and based on their hsCRP levels were classified as being at a moderate risk of CVD compared to both MF and HF. However, despite significant differences in EDD and cIMT, there were no significant differences in inflammatory biomarkers between the groups. Collectively, these findings suggest that non-invasive measurement of cIMT and brachial artery are more sensitive measures of vascular health in children than inflammatory biomarkers.

In summary, i) there was a clustering of CVD risk factors in LF, ii) impaired EDD and increased cIMT were more prevalent in LF than HF and MF and iii) $\dot{V}O_2\text{max}$

was significantly and independently related to EDD and CIMT. The beneficial effects of increased CRF on cardiovascular health are multifactorial but are primarily associated with risk factor modification and the positive direct effect of exercise on the vascular endothelium (Joyner & Green, 2009). Increased CRF is associated with reductions in body weight and adiposity, TG, BP and improvements in insulin sensitivity in skeletal muscle (Ross et al., 2008). Regular exercise training is associated with increases in shear stress that result in an up-regulation of eNOS and subsequent bioavailability of NO, which enhances EDD and exerts anti-inflammatory effects (Green et al., 2004) .

Study 2

Although $\dot{V}O_2\text{max}$ is considered the gold standard measurement of CRF, it is not often attained in overweight/obese adolescents due to its effort dependency (Marinov et al., 2003). The oxygen uptake efficiency slope (OUES) is highly correlated with $\dot{V}O_2\text{max}$ and has been proposed as an alternative effort independent submaximal measure of CRF (Baba et al., 1996). Study 2 examined the relation between OUES and vascular health and compared maximal and submaximal OUES in LF, MF and HF male adolescents.

A primary requisite for a submaximal measure of CRF is that it is independent of exercise intensity. Findings from previous studies that have examined the relation between maximal and submaximal OUES have been equivocal with some reporting lower (Drinkard et al., 2007) or higher submaximal OUES values than maximal OUES (Marinov et al., 2003) while others found no difference between maximal and

submaximal OUES (Marinov et al., 2007). In study 2, submaximal OUES calculated up to the VAT was significantly lower (6%) than maximal OUES. However, similar to the findings of Akkerman *et al.*, (2010) there was no significant difference in maximal and submaximal OUES values when expressed relative to body mass and BSA. These findings suggest that when OUES is expressed relative to body mass and BSA it is a valid, effort independent submaximal measure of CRF. Similar to the findings of previous studies, maximal and submaximal OUES were both significantly correlated to $\dot{V}O_2\text{max}$, (Baba et al., 1996, Marinov et al., 2007, Marinov et al., 2003, Breithaupt et al., 2012 Akkerman et al., 2010) The fact that submaximal OUES is significantly correlated with $\dot{V}O_2\text{max}$ means that this is a suitable surrogate for $\dot{V}O_2\text{max}$ when such testing is not feasible or $\dot{V}O_2\text{max}$ cannot be attained.

To date, no published studies have examined the relation between OUES and vascular health in children and adolescents. In study 2, the relation between maximal OUES and submaximal OUES and vascular health was examined. There was a significant inverse association between maximal and submaximal OUES expressed relative to body mass and cIMT. There was a positive between maximal OUES and submaximal OUES values expressed relative to body mass and EDD. Unsurprisingly, $\dot{V}O_2\text{max}$ was also inversely related to cIMT and positively related to EDD. While a significant independent association between both maximal OUES/kg and submaximal OUES/kg and EDD, a stronger association was found between $\dot{V}O_2\text{max}$ ($\text{ml}\cdot\text{kg}^{-1}\cdot\text{min}^{-1}$) and EDD. Furthermore, only $\dot{V}O_2\text{max}$ was retained in a multiple regression analysis used to predict EDD that included maximal OUES/kg and submaximal OUES/kg.

Similarly, in healthy middle-aged adults $\dot{V}O_{2\max}$ ($\text{ml}\cdot\text{kg}^{-1}\cdot\text{min}^{-1}$) was found to be the only significant predictor of large artery stiffness in a linear regression analysis that included both maximal and submaximal OUES (Arena et al., 2009). The more robust relation observed between $\dot{V}O_{2\max}$ and EDD may be attributed to the fact that $\dot{V}O_{2\max}$ is considered the gold standard measurement of CRF and measures the maximum capacity of the respiratory, cardiovascular and musculoskeletal systems. While the OUES purportedly reflects the integrated function of the pulmonary, cardiac and skeletal muscle systems, little is known how the health of each of these physiologic systems independently contributes to the variation in OUES (Arena et al., 2009). Furthermore, less variability is associated with $\dot{V}O_{2\max}$ compared to the measurement of submaximal OUES, which is dependent on VAT determination. It is often not always possible to determine the VAT and in the present study it could not be identified in 27% of the participants. The subjective nature of VAT measurement also means that it is subject to greater variability. The findings of the current study suggest that while both submaximal and maximal OUES were significantly related to EDD they may not be a viable surrogate for $\dot{V}O_{2\max}$ in predicting vascular health in both healthy adolescents

Attainment of $\dot{V}O_{2\max}$ requires a plateau in oxygen uptake, defined as a change in $\dot{V}O_2 < 2.0 \text{ ml}\cdot\text{kg}^{-1}\cdot\text{min}^{-1}$ with increasing workload during the final minute of exercise (Rowland & Cunningham 1992). In total, 32% of the cohort did not achieve a plateau in oxygen consumption. Interestingly, a higher percentage of LF achieved a plateau in oxygen consumption (73.4%) than MF (68.2%) and HF (54.5). This finding

is in agreement with Norman *et al.*, (2005) who also found that a higher percentage of overweight/obese adolescents achieved a plateau in oxygen consumption compared to their non-overweight children (Norman *et al.*, 2005). In addition, to a plateau in oxygen consumption, a number of secondary criterion including a respiratory exchange ratio (RER) > 1.0, heart rate (HR) >200 bpm and volitional fatigue (RPE 18-20) were used to verify attainment of attainment of $\dot{V}O_2\text{max}$. In study 2, attainment of at least two of the four criteria was required for the test to be considered maximal. Based on these criteria, a maximal test was achieved by all HF, MF and LF participants. In contrast, previous studies have found that a large proportion of both normal and overweight children do not achieve the criteria for $\dot{V}O_2\text{max}$ (Marinov *et al.*, 2003, Norman *et al.*, 2005). The findings of study 2 indicate that LF overweight/obese adolescents are capable of attaining $\dot{V}O_2\text{max}$ during maximal exercise testing and that $\dot{V}O_2\text{max}$ testing should be encouraged when assessing CRF in such populations where feasible.

It has been recommended that OUES values should be adjusted for anthropometric variables such as body mass, BSA and FFM when comparing different study samples (Breithaupt *et al.*, 2012). In study, 64% of LF were overweight or obese. There was no significant difference between the absolute maximal and submaximal OUES values between HF and LF. This is in contrast to previous studies that reported higher absolute maximal and submaximal OUES values in obese compared to normal weight children (Marniov *et al.*, 2003). Maximal and submaximal OUES values expressed relative to body mass and BSA were significantly

higher in HF than MF and LF. Previous studies have also reported significantly lower maximal and submaximal OUES expressed relative to body mass or BSA in overweight and obese children compared to healthy normal weight controls (Marinov et al., 2003) (Breithaupt et al., 2012).

The mean absolute maximal OUES and submaximal OUES values calculated in the present study were higher compared to other studies that examined the OUES in healthy normal weight 15 year old male adolescents (Akkerman et al., 2010, Marinov et al., 2007). In obese adolescents with a mean age of 14.25 years, Breithaupt *et al.* (2012) found similar but slightly lower absolute maximal and submaximal OUES values than those found in study 2. The higher values reported by Breithaupt *et al.*, (2012) and in the present study may be partially attributed to differences in body size. In total, 26% of participants in the present study were classified as overweight. In addition, the mode of exercise testing may also help to explain the higher OUES values in study 2. Other studies (Akkerman et al., 2010, Marinov et al., 2007) used cycle ergometry to assess $\dot{V}O_2\text{max}$. In contrast, Breithaupt *et al.*, (2012) and the present study used treadmill exercise testing which is associated with a significantly higher $\dot{V}O_2\text{max}$ value than cycle ergometry (Carter et al., 2000). As OUES is highly correlated with $\dot{V}O_2\text{max}$, this may help explain the difference in OUES values reported between studies.

In summary, maximal OUES and submaximal OUES were i) highly correlated with $\dot{V}O_2\text{max}$ ii) significantly higher in HF than MF and LF, iii) positively related to EDD and iv) inversely related to cIMT. Performance of $\dot{V}O_2\text{max}$ is not often feasible in

children and adolescents where maximal exercise testing is contraindicated or when performance may be impaired by pain shortness of breath or fatigue rather than exertion. In such cases, the OUES should be used, as it is a valid submaximal independent effort measure of CRF when expressed relative to body weight and is significantly related to $\dot{V}O_2\text{max}$. While OUES was significantly related to EDD, a more robust relation was observed between $\dot{V}O_2\text{max}$ and EDD suggesting that $\dot{V}O_2\text{max}$ should be the preferred method of CRF assessment in adolescents and that this testing should be encouraged, particularly with LF overweight/obese adolescents who are capable of attaining $\dot{V}O_2\text{max}$. However, the strong correlation observed between submaximal OUES means that this can serve as an alternative to $\dot{V}O_2\text{max}$ when maximal exercise testing is not feasible.

Study 3

Currently, 81% of Irish children and 88% of Irish adolescents do not meet the current PA recommendations of 60 min of daily MVPA (Woods et al., 2010). In addition, it is estimated that European children aged 12-18 years spend on average 9 hours per day or 71% of their waking hours in sedentary behaviours (Ruiz et al., 2011). To date no published studies have simultaneously examined the effect of objectively measured PA and sedentary behaviour on both vascular structure and function in apparently healthy adolescents. In study 3, PA and sedentary behaviours, selected CVD risk factors, cIMT and endothelial function were compared between LF, MF and HF healthy male adolescents. In addition, the relation between PA

behaviours and vascular health and sedentary behaviours and vascular health was examined.

Carotid IMT was significantly lower and EDD was significantly higher in HF than MF and in MF than LF. In addition, similar differences in CVD risk factors were found between the 3 experimental groups with a large proportion of LF being overweight/obese, hypertensive, insulin resistant and having elevated TG. PA behaviours were similar between MF and LF despite the significant differences in both vascular health measures and $\dot{V}O_2$ max. Similarly, with the exception of both total time and percentage of time spent in MVPA during waking hours, there was no significant difference in PA behaviours between HF and MF. In contrast, all measured PA behaviours (standing, LIPA, LIPA including standing and MVPA) were significantly higher in HF than LF.

The majority of evidence that has informed current PA guidelines has been based on the health-associated benefits of PA performed at a moderate intensity. While low to moderate correlations were found between all PA behaviours including MVPA and selected CVD risk factors in study 3, the strongest associations were found between LIPA (including standing) and CVD risk factors. A recent study involving 1,731 adolescents aged 12-19 years found that after adjusting for confounders, each additional hour per day of low LIPA was associated with a 0.59 mmHg decrease in DBP and each additional hour per day of high LIPA was associated with a 1.67 mmHg lower DBP and 0.04 high HDL-C (Carson et al., 2013). The findings of Carson *et al.*, (2013) and the present study are of considerable public health importance. They

both indicate that increasing LIPA may be a more feasible strategy rather than increasing MVPA in the large proportion of adolescents who do not meet the current guidelines, and particularly in those who engage in minimal PA. Furthermore, MVPA only accounts for a small proportion of waking hours among adolescents even if they are accumulating the recommended 60 min throughout the day (Tremblay et al., 2007). Conversely, LIPA accounts for the majority of a daily energy expenditure (Levine et al., 2006) and as a result there may be a greater opportunity to increase daily LIPA through activities involving light ambulatory movement.

Relatively few studies have examined the relation between objectively measured PA and vascular health in children. In the present study, there was a significant positive association between EDD and the total time spent in LIPA and MVPA during waking hours and also the percentage of time in LIPA and MVPA during waking hours. Similarly, others have found an association between time spent in both MVPA (Hopkins et al., 2009) and habitual PA (Abbott et al., 2002) and the percent change in FMD in prepubertal children, . The strongest association has been found between time spent in PA and brachial artery FMD in individuals in the lowest tertile for percent change in FMD, suggesting that children with the lowest FMD could benefit the most from increasing their PA.

To examine the independent relation between PA and endothelial function, Pahkala *et al.*, (2008) found that after adjusting for baseline brachial diameter, BMI, HDL-C, LDL-C, TG, hsCRP and SBP, maximum FMD/SR_{AUC} was positively associated with leisure time PA in 13 year old boys (Pahkala et al., 2008). In contrast, the

present study found that after adjusting for confounders, there was no significant relation between LIPA and MVPA and the percent change in EDD. A weak but significant relation however, remained between both total time and percentage of waking hours spent in LIPA and MVPA and absolute change in EDD.

With the exception of right far wall cIMT, no significant relation was found between cIMT and total time spent in MVPA and percentage of time spent in MVPA during waking hours. Similarly others have reported no association between objectively measured MVPA and cIMT in children aged between 11-15 years (Melo et al., 2014, Ried-Larsen et al., 2013). In contrast, both the total time and the percentage of time spent in LIPA during waking hours were significantly related to all measures of cIMT in study 3. A weak but significant relation remained between the percentage of time spent in LIPA and right far wall cIMT after adjusting for potential confounders. A greater emphasis should be placed within the current PA guidelines on LIPA rather than sole emphasis on MVPA, due to its independent and inverse association with vascular health.

Current national guidelines place great attention on the importance of PA for optimizing health in children and adolescents with little or no emphasis on the importance of CRF. This is surprising considering that CRF is one of the most important correlates of overall health status and is an considered one of the strongest predictors for CVD, and all-cause mortality (Lavie et al., 2012). PA is a behaviour that when performed regularly at an appropriate intensity may result in improvements in CRF (Kaminsky et al., 2013). In the present study, $\dot{V}O_2\text{max}$ was

positively related to all measured PA behaviours. However, CRF has a stronger physiological basis than PA (Kaminsky et al., 2013). In study 3, $\dot{V}O_2\text{max}$ ($\text{ml kg}^{-1}\text{min}^{-1}$) was independently related to both the percentage change and the absolute change in EDD and left far wall cIMT. These associations were more robust than the independent associations observed for PA and vascular health. Stronger associations were also observed between $\dot{V}O_2\text{max}$ and CVD risk factors in study 1 than those reported between PA behaviours and CVD risk factors in study 3. This is in agreement with the findings of Rizzo *et al.*, (2007) who also found a stronger association between $\dot{V}O_2\text{max}$ and clustered CMD risk objectively than between objectively measured PA and clustered CMD in children and adolescents (Rizzo et al., 2007).

In terms of measurement, $\dot{V}O_2\text{max}$ is a more objective and reliable method of assessing CRF and has a lower measurement error than PA (Kaminsky et al., 2013). In study 3, PA measurement compliance issues including non-wear time and incorrect positioning of the accelerometer meant that 34% of the study sample was excluded from the analysis. Collectively these findings suggest that $\dot{V}O_2\text{max}$, in addition to being a direct measure of physiological health, is a more reliable measure of vascular health, particularly in adolescent populations.

In study 3, a number of measures of sedentary behaviour were assessed. These included total time and percentage of time spent in sitting/lying during waking hours and both the number and duration of bouts spent in bouts < 20min, > 20min, > 30 min and > 60 min. The majority of studies to date have only measured sedentary time. Therefore, the present study provides a more detailed insight into the

characteristics of sedentary behaviours undertaken by male adolescents. Furthermore, previous studies examining the relation between sedentary behaviour and cardiovascular health have only measured risk factors to assess CV health profile in children and adolescents. While CVD risk factor profiles are useful to identify adolescents at CVD risk, the ability to measure the disease itself using non-invasive ultrasound provides more diagnostic information in terms of vascular health and disease progression. In addition to CVD risk factors, the present study also examined measures of vascular health, enabling a more comprehensive examination of the relation between sedentary behaviour and cardiovascular health to be undertaken. Excessive sedentary behaviour has been found to reduce insulin sensitivity, impair metabolic function and attenuate endothelial function, all markers of ACVD (Tremblay et al., 2010). Male adolescents spent on average 63% of their waking day sitting/lying. This figure is slightly lower than those reported by Ruiz *et al.*, (2011) who found that European children between the ages of 12-18 years spend on average 9 h per day or 71% of their waking hours involved in sedentary behaviours (Ruiz et al., 2011). The different findings between studies may be due in part to the use of different accelerometers. The ActivPAL activity inclinometer that was used in study 3 can differentiate between sitting and standing. In contrast, the Actigraph accelerometer used in the study by Ruiz *et al.*, (2011) is unable to discriminate between sitting and standing which may help to explain the higher sedentary time values. LF spent on average 68% of their waking day sitting/lying. The percentage of time spent sitting/lying and the total sedentary hours during the waking day was

significantly lower in HF than MF and LF. There was no significant difference in time spent sedentary between MF and LF.

There is some evidence that excessive sedentary behaviour is associated with deleterious effects on vascular health in adults (Hamburg et al., 2008, Demiot et al., 2007). Sedentary behavior induces hemodynamic alterations within the vasculature. Low shear stress reduces NO bioavailability (Thosar et al., 2012) and increases oxidative stress (Laufs et al., 2005). In the present study, the percentage of waking day spent sitting/lying was inversely related with both the percent change and absolute change in EDD. In contrast, in the only published study to examine sedentary behaviour and endothelial function in healthy prepubertal children Hopkins *et al.*, (2012) found no association between brachial artery FMD and objectively measured total sedentary time with or without adjustment for potential confounders (Hopkins et al., 2012). Similarly, the relation between sedentary time and EDD was no longer significant in study 3 after adjusting for SBP, sum of skinfolds, $\dot{V}O_2$ max and pubertal stage.

Findings from previous studies examining the independent relation between sedentary behaviour and cardiometabolic disease risk factors in children and adolescents have been equivocal with some studies reporting no association independent of PA while others reported an association between sedentary time and cardiometabolic disease risk factors in children independent of PA. (Tremblay 2014). The relation between sedentary time independent of MVPA and vascular health was

addressed in Study 3. Sedentary time was inversely related to percent change in EDD and positively related to cIMT after adjustment for MVPA.

Exercise induced increases in shear stress and subsequent increase in NO bioavailability appear to be ephemeral (Thosar et al., 2012). Long uninterrupted bouts of sedentary behaviour maintain a state of low shear stress, which prohibits an increase in NO bioavailability. A recent study examining the effect of prolonged sitting and breaks in sitting time on endothelial function in 12 non-obese men found that 3 h of sitting resulted in a significant impairment in shear rate and FMD in the femoral artery (Thosar et al., 2015). Similarly, both the number of sedentary bouts and time spent in sedentary bouts >20 min, >30 min and >60 min were inversely related to both the percentage change and absolute change in EDD in study 3. Of these measures, the strongest association was found between both the number and duration of sedentary bouts > 30 min and measures of vascular health. These findings suggest that uninterrupted sedentary behaviour of > 30 min can negatively impact vascular health in youth. There was also a significant positive relation between both the percent change and absolute change in EDD and the number of sedentary bout < 20 min and the time spent in sedentary bouts < 20 min. Although no studies have examined the effect of breaking-up sedentary time on vascular health in children, the findings from study 3 suggest that interrupting sedentary time may have a beneficial effect on endothelial function in adolescents.

In addition to its relation with EDD, total time sitting and lying and the percentage of the waking day spent sitting/lying was positively associated with cIMT

of the near and far wall of the left and right CCA. These associations were no longer significant for right far wall cIMT but remained significant for left far wall cIMT independent of percent time in MVPA. When adjusted for other potential confounders including sum of skinfolds, pubertal stage and CRF, these associations were no longer significant. Similarly, in the only previous published study to examine the relation between objectively measured sedentary time and cIMT, total sedentary time measured was not associated with far wall IMT of the CCA with or without adjusting for MVPA, CRF, BMI and waist circumference in children between the age of 11 and 13 years (Melo et al., 2014).

With the exception of the number of sedentary bouts <20 min and the duration of time spent in this sedentary category, all sedentary behaviours were inversely related to $\dot{V}O_2\text{max}$ and all PA behaviours were positively related to $\dot{V}O_2\text{max}$. In contrast to $\dot{V}O_2\text{max}$, after adjusting for all potential confounders, there was no significant relation between sedentary time and both EDD and cIMT, suggesting that $\dot{V}O_2\text{max}$ is a better measure of vascular health than sedentary behaviour in adolescent males.

In summary, total time spent in PA behaviours was significantly higher and total sedentary time was significantly lower in HF than MF and LF. A weak but independent association was found between the absolute change in EDD and both LIPA and MVPA. Of all the sedentary number and bout duration indices measured in Study 3, those of > 30 min showed the strongest relation between measures of vascular health. The relation between sedentary behaviour and EDD remained

significant after adjustment for MVPA. However, it was no longer significant after adjusting for potential confounders that included pubertal stage, $\dot{V}O_2\text{max}$ and adiposity in addition to MVPA. While much of the recent focus has been on increasing MVPA, the results of the present study suggest that increasing LIPA should be promoted among adolescents, as it is positively associated with EDD, inversely associated with cIMT and significantly associated with a number of CVD risk factors. While significant and independent associations were found between PA and vascular health, the relation between $\dot{V}O_2\text{max}$ and vascular health was more robust indicating that $\dot{V}O_2\text{max}$ is a better measure of vascular health in male adolescents.

Study Limitations

There are a number of limitations associated with this research. Firstly, percentage body fat could not be determined in the study participants. In children and adolescents, the Slaughter equation (Slaughter et al., 1988) is commonly used to estimate percentage body fat. This equation requires skinfold measurement from the subscapular and triceps. In the present study, the skinfold measurements were taken at the chest, abdomen and thigh which precluded the use of the Slaughter et al., (1988) equation. Body composition was instead reported in terms of sum of skinfolds. Consequently, FFM could not be determined in the series of studies. The expression of $\dot{V}O_2\text{max}$ relative to FFM would have assisted in understanding the influence of adiposity and lean muscle mass in determining $\dot{V}O_2\text{max}$ and its relation with vascular health.

Secondly, the cross sectional design of the series of studies did not allow cause and effect relationships to be determined. In addition, the lowest detection limit for hsCRP was $0.48 \text{ mg}\cdot\text{L}^{-1}$. As hsCRP values are generally low in healthy children, exact hsCRP values could not be determined for those with a value below the limit of detection, and were therefore recorded as 0.48 mg/dL . Finally, a number of methodological and interpretive limitations are associated with brachial artery FMD technique. These include the variability of FMD, the lack of a consensus on what defines normal FMD in adolescents, variability relating to protocol employed between studies and normalization for shear stress.

Future Directions

This series of studies examined the relation between CRF, PA and sedentary behaviours and vascular health in apparently healthy male adolescents. Future research should determine the appropriate volume, intensity and type of exercise/PA needed to maintain optimal vascular health in children and adolescents.

Chapter VII

CONCLUSION

This series of studies is the first to compare objectively measured indices of CRF, PA, and sedentary behaviour and vascular health in Irish adolescents. ACVD risk factors including obese, overweight, hypertension, insulin resistance and elevated TG clustered in adolescent males with low CRF. cIMT was significantly higher and EDD was significantly lower in LF than both MF and HF male adolescents. Alarming, the majority of LF participants had advanced vascular aging of the carotid arteries and impaired endothelial function. $\dot{V}O_2\text{max}$, OUES, PA and sedentary time were each significantly related to EDD and cIMT. The adverse effect of low levels of CRF and PA behaviours and high levels of sedentary behaviour on vascular health may at least in part be due to the detrimental effect of the low levels of shear stress associated with each of these behaviours on the human vasculature.

While OUES, PA and sedentary behaviours were all significantly related to vascular health, a stronger relation was observed between $\dot{V}O_2\text{max}$ and markers of vascular health. Furthermore, $\dot{V}O_2\text{max}$ but not all PA measured variables remained independently related to EDD and cIMT after adjusting for potential confounders. Collectively, these findings highlight the urgent need to develop of a unified strategy to increase CRF levels among post-primary children to combat the early development of subclinical ACVD. The fact that EDD was normal in MF participants would indicate that this level of CRF is cardioprotective and the attainment of a moderate level of CRF among Irish post-primary school students, should be national priority.

REFERENCES

1. Abbott, R. A, Harkness, M. A, & Davies, P. S. W. (2002). Correlation of habitual physical activity levels with flow-mediated dilation of the brachial artery in 5-10 year old children. *Atherosclerosis*, 160(1), 233–9. Retrieved from <http://www.ncbi.nlm.nih.gov/pubmed/11755942>
2. Adams, V., Linke, A., Krankel, N., Erbs, S., Gielen, S., Mobius-Winkler, S., et al. (2005). Impact of Regular Physical Activity on the NAD(P)H Oxidase and Angiotensin Receptor System in Patients With Coronary Artery Disease. *Circulation*, 111(5), 555–562. doi:10.1161/01.cir.0000154560.88933.7e
3. Adegboye, A. R. A, Anderssen, S. A, Froberg, K., Sardinha, L. B., Heitmann, B. L., Steene-Johannessen, J., et al. (2011). Recommended aerobic fitness level for metabolic health in children and adolescents: a study of diagnostic accuracy. *British Journal of Sports Medicine*, 45(9), 722–728. doi:10.1136/bjism.2009.068346
4. Aggoun, Y., Farpour-Lambert, N. J., Marchand, L. M., Golay, E., Maggio, A. B. R., & Beghetti, M. (2008). Impaired endothelial and smooth muscle functions and arterial stiffness appear before puberty in obese children and are associated with elevated ambulatory blood pressure. *European Heart Journal*, 29(6), 792–799. doi:10.1093/eurheartj/ehm633
5. Akinci, G., Akinci, B., Coskun, S., Bayindir, P., Hekimsoy, Z., & Ozmen, B. (2008). Evaluation of markers of inflammation, insulin resistance and endothelial dysfunction in children at risk for overweight. *Hormones (Athens, Greece)*, 7(2), 156–62. Retrieved from <http://www.ncbi.nlm.nih.gov/pubmed/18477553>
6. Akkerman, M., van Brussel, M., Bongers, B. C., Hulzebos, E. H. J., Helders, P. J. M., & Takken, T. (2010). Oxygen uptake efficiency slope in healthy children. *Pediatric Exercise Science*, 22(5), 431–441.
7. Akkerman, M., van Brussel, M., Hulzebos, Vanhees, L., Helders, P. J. M., & Takken, T. (2010). The Oxygen uptake efficiency slope: what do we know? *Journal of Cardiopulmonary Rehabilitation and Prevention*, 30(6):357-73
8. American Academy of Pediatrics (2001). Children, Adolescents and Television. *Pediatrics*, 107 (2):423-426
9. American Academy of Pediatrics (2011). Expert Panel on Integrated Guidelines for Cardiovascular Health and Risk Reduction in Children and Adolescents: Summary Report. *Pediatrics*. 128 (Suppl 5); S213-256

10. Aminian, S., & Hinckson, E. A. (2012). Examining the validity of the ActivPAL monitor in measuring posture and ambulatory movement in children. *International Journal of Behavioral Nutrition and Physical Activity*, *9*, 119. doi:10.1186/1479-5868-9-119
11. Andersen, L. B., Harro, M., Sardinha, L. B., Froberg, K., Ekelund, U., Brage, S., & Anderssen, S. A. (2006). Physical activity and clustered cardiovascular risk in children: a cross-sectional study (The European Youth Heart Study). *Lancet*, *368*(9532), 299–304. doi:10.1016/S0140-6736(06)69075-2
12. Andersen, L. B., Hasselstrøm, H., Grønfeltd, V., Hansen, S. E., & Karsten, F. (2004). The relationship between physical fitness and clustered risk, and tracking of clustered risk from adolescence to young adulthood: eight years follow-up in the Danish Youth and Sport Study. *The International Journal of Behavioral Nutrition and Physical Activity*, *1*(1), 6. doi:10.1186/1479-5868-1-6
13. Anderson, T. J. (1999). Assessment and treatment of endothelial dysfunction in humans. *Journal of the American College of Cardiology*, *34*(3), 631–638. doi:10.1016/S0735-1097(99)00259-4
14. Anderson, T. J., Uehata, A., Gerhard, M. D., Meredith, I. T., Knab, S., Delagrang, D. et al. (1995). Close relation of endothelial function in the human coronary and peripheral circulations. *Journal of the American College of Cardiology*, *26*(5), 1235–41. Retrieved from <http://www.ncbi.nlm.nih.gov/pubmed/7594037>
15. Anderssen, S. a, Cooper, A. R., Riddoch, C., Sardinha, L. B., Harro, M., Brage, S., & Andersen, L. B. (2007). Low cardiorespiratory fitness is a strong predictor for clustering of cardiovascular disease risk factors in children independent of country, age and sex. *European Journal of Cardiovascular Prevention and Rehabilitation : Official Journal of the European Society of Cardiology, Working Groups on Epidemiology & Prevention and Cardiac Rehabilitation and Exercise Physiology*, *14*(4), 526–531. doi:10.1097/HJR.0b013e328011efc1
16. Arena, R., Arrowood, J. A., Fei, D.-Y., Helm, S., & Kraft, K. A. (2009). Maximal Aerobic Capacity and the Oxygen Uptake Efficiency Slope as predictors of Large Artery Stiffness in Apparently Healthy Subjects. *Journal of Cardiopulmonary Rehabilitation and Prevention*, *29*(4), 248–254. doi:10.1016/j.drugalcdep.2008.02.002.A
17. Arena, R., Myers, J., Hsu, L., Peberdy, M. A., Pinkstaff, S., Bensimhon, D., Chase, P. et al. (2007). The Minute Ventilation/Carbon Dioxide Production Slope is Prognostically Superior to the Oxygen Uptake Efficiency Slope. *Journal of Cardiac Failure*, *13*(6), 462–469. doi:10.1016/j.cardfail.2007.03.004
18. Aronson, D., Sheikh-Ahmad, M., Avizohar, O., Kerner, A., Sella, R., Bartha, P., et

- al. (2004). C-Reactive protein is inversely related to physical fitness in middle-aged subjects. *Atherosclerosis*, 176(1), 173–179. doi:10.1016/j.atherosclerosis.2004.04.025
19. Arsenault, B. J., Lachance, D., Lemieux, I., Alméras, N., Tremblay, A., Bouchard, C., et al. (2007). Visceral adipose tissue accumulation, cardiorespiratory fitness, and features of the metabolic syndrome. *Archives of Internal Medicine*, 167(14), 1518–1525. doi:10.1001/archinte.167.14.1518
 20. ATKIN, A. J., EKELUND, U., MØLLER, N. C., FROBERG, K., SARDINHA, L. B., ANDERSEN, L. B., & BRAGE, S. (2013). Sedentary Time in Children. *Medicine & Science in Sports & Exercise*, 45(6), 1097–1104. doi:10.1249/MSS.0b013e318282190e
 21. Ayer J, Charakida M., Deanfield J.E., & Celermajer D.S.(2015) Lifetime risk: childhood obesity and cardiovascular risk. *European Heart Journal*. 7;36(22):1371-6.
 22. Baba, R., Nagashima, M., Goto, M., Nagano, Y., Yokota, M., Tauchi, N., & Nishibata, K. (1996). Oxygen Uptake Efficiency Slope: A New Index of Cardiorespiratory Functional Reserve Derived From the Relation Between Oxygen Uptake and Minute Ventilation During Incremental Exercise. *Journal of the American College of Cardiology*, 28(6);1567-72.
 23. Baba, R., Nagashima, M., Nagano, Y., Ikoma, M., & Nishibata, K. (1999). Role of the oxygen uptake efficiency slope in evaluating exercise tolerance. *Archives of Disease in Childhood*, 81, 73–75.
 24. Baba, R., Kubo, N., Morotome, Y., & Iwagaki, S. Reproducibility of the oxygen uptake efficiency slope in normal healthy subjects. *Journal of Sports Medicine and Physical Fitness*, 39(3):202-6
 25. Babar, G. S., Zidan, H., Widlansky, M. E., Das, E., Hoffmann, R. G., Daoud, M., & Alemzadeh, R. (2011). Impaired endothelial function in preadolescent children with type 1 diabetes. *Diabetes Care*, 34(3), 681–685
 26. Bailey, D. P., Boddy, L. M., Savory, L. a, Denton, S. J., & Kerr, C. J. (2012). Associations between cardiorespiratory fitness, physical activity and clustered cardiometabolic risk in children and adolescents: the HAPPY study. *European Journal of Pediatrics*, 171(9), 1317–23.
 27. Barbeau, P., Litaker, M. S., Woods, K. F., Lemmon, C. R., Humphries, M. C., Owens, S., & Gutin, B. (2002). Hemostatic and inflammatory markers in obese youths: Effects of exercise and adiposity. *The Journal of Pediatrics*, 141(3), 415–420. doi:10.1067/mpd.2002.127497
 28. Bassett Jr, D.R., Freedson, P., & Kozey, S. (2010). Medical hazards of prolonged

- sitting. *Exercise and Sport Science Reviews*, 38(3), 101-102.
29. Berenson, G. S. (2002). Childhood risk factors predict adult risk associated with subclinical cardiovascular disease. The Bogalusa Heart Study. *The American Journal of Cardiology*, 90(10C), 3L-7L. Retrieved from <http://www.ncbi.nlm.nih.gov/pubmed/12459418>
 30. Berenson, G. S., Srinivasan, S. R., Bao, W., Newman, W. P., Tracy, R. E., & Wattigney, W. A. (1998). Association between multiple cardiovascular risk factors and atherosclerosis in children and young adults. The Bogalusa Heart Study. *The New England Journal of Medicine*, 338(23), 1650-6. doi:10.1056/NEJM199806043382302
 31. Berenson, G. S., & Srinivasan, S. R. (2005). Cardiovascular risk factors in youth with implications for aging: the Bogalusa Heart Study. *Neurobiology of Aging*, 26(3), 303-7. doi:10.1016/j.neurobiolaging.2004.05.009
 32. Bey, L., & Hamilton, M. T. (2003). Suppression of skeletal muscle lipoprotein lipase activity during physical inactivity: a molecular reason to maintain daily low-intensity activity. *The Journal of Physiology*, 551(2), 673-682. doi:10.1113/jphysiol.2003.045591
 33. Bhangoo, A., Sinha, S., Rosenbaum, M., Shelov, S., & Ten, S. (2011). Endothelial function as measured by peripheral arterial tonometry increases during pubertal advancement. *Hormone Research in Paediatrics*, 76(4), 226-33. doi:10.1159/000328455
 34. Blair, S.N., Kohl, H.W. 3rd, Paffenbarger, R.S., Jr., Clark, D.G., Cooper, K.H., & Gibbons, L.W. (1989). Physical fitness and all-cause mortality. A Prospective Study of Healthy Men and Women. *The Journal of the American Medical Association*, 262(17): 2395-401.
 35. Blair, S. N., Kampert, J. B., Kohl, H. W., Barlow, C. E., Macera, C. a, Paffenbarger, R. S., & Gibbons, L. W. (1996). Influences of cardiorespiratory fitness and other precursors on cardiovascular disease and all-cause mortality in men and women. *The Journal of the American Medical Association*, 276(3), 205-10. Retrieved from <http://www.ncbi.nlm.nih.gov/pubmed/8667564>
 36. Blair, S. N., Kohl, H. W., Barlow, C. E., Paffenbarger, R. S., Gibbons, L. W., & Macera, C. A. (1995). Changes in physical fitness and all-cause mortality. A prospective study of healthy and unhealthy men. *The Journal of the American Medical Association*, 273(14), 1093-1098. Retrieved from <http://www.ncbi.nlm.nih.gov/pubmed/7707596>
 37. Blair, S. N., & Morris, J. N. (2009). Healthy Hearts-and the Universal Benefits of Being Physically Active: Physical Activity and Health. *Annals of Epidemiology*,

- 19(4), 253–256. doi:10.1016/j.annepidem.2009.01.019
38. Bongers, B.C. (2013). Pediatric exercise testing. *Current Opinion in Cardiology*, 6(1), 107–109. doi:10.1097/00001573-199102000-00017
39. Bongers, B. C., Hulzebos, E. H. J., Arets, B. G. M., & Takken, T. (2012). Validity of the oxygen uptake efficiency slope in children with cystic fibrosis and mild-to-moderate airflow obstruction. *Pediatric Exercise Science*, 24 (1), 129–41. doi:10.4324/9780203852026
40. Boreham, C.A.G., Paliczka, V.J., & Nicholas, A.K. (1990) A comparison of the PWC170 and 20-MST test of aerobic fitness in adolescent school children. *The Journal of Sports Medicine and Physical Fitness*, 30 (1):19-23
41. Boreham, C., Twisk, J., Neville, C., Savage, M., Murray, L., & Gallagher, A. (2002). Associations between physical fitness and activity patterns during adolescence and cardiovascular risk factors in young adulthood: the Northern Ireland Young Hearts Project. *International Journal of Sports Medicine*, 23 (Suppl 1): S22-6.
42. Bots, M. L., & Grobbee, D. E. (2002). Intima media thickness as a surrogate marker for generalised atherosclerosis. *Cardiovascular Drugs and Therapy / Sponsored by the International Society of Cardiovascular Pharmacotherapy*, 16(4), 341–51.
43. Bots, M. L., Hoes, A. W., Koudstaal, P. J., Hofman, A., & Grobbee, D. E. (1997). Common Carotid Intima-Media Thickness and Risk of Stroke and Myocardial Infarction: The Rotterdam Study. *Circulation*, 96(5), 1432–1437. doi:10.1161/01.CIR.96.5.1432
44. Bots, M. L., Westerink, J., Rabelink, T. J., & de Koning, E. J. P. (2005). Assessment of flow-mediated vasodilatation (FMD) of the brachial artery: effects of technical aspects of the FMD measurement on the FMD response. *European Heart Journal*, 26(4), 363–8. doi:10.1093/eurheartj/ehi017
45. Bouchard, C., An, P., Rice, T., Skinner, J. S., Wilmore, J. H., Gagnon, J., et al.(1999). Familial aggregation of $\dot{V}O_2$ max response to exercise training: results from the HERITAGE Family Study. *Journal of Applied Physiology*, 87(3), 1003–1008. doi:10.1055/s-2000-12983
46. Brage, S., Wedderkopp, N., Ekelund, U., Franks, P.W., Wareham, N.J., Andersen, L.B., & Froberg, K. (2004) Features of the Metabolic Syndrome Are Associated with Objectively Measured Physical Activity and Fitness in Danish Children. The European Youth Heart Study (EYHS). *Diabetes Care*, 27(9):2141-2148.
47. Breithaupt, P. G., Colley, R. C., & Adamo, K. B. (2012). Using the oxygen uptake

- efficiency slope as an indicator of cardiorespiratory fitness in the obese pediatric population. *Pediatric Exercise Science*, 24(3), 357–68. Retrieved from <http://www.ncbi.nlm.nih.gov/pubmed/22971553>
48. Brodersen, N. H., Steptoe, A., Boniface, D. R., & Wardle, J. (2007). Trends in physical activity and sedentary behaviour in adolescence: ethnic and socioeconomic differences. *British Journal of Sports Medicine*, 41(3), 140–4. doi:10.1136/bjism.2006.031138
49. Bruyndonckx, L., Hoymans, V. Y., Craenenbroeck, A. H. Van, Vissers, D. K., Vrints, C. J., Ramet, J., & Conraads, V. M. (2013). Review Article Assessment of Endothelial Dysfunction in Childhood Obesity and Clinical Use. *Oxidative Medicine and Cellular Longevity* (2013)
50. Carmona-Montesinos, E., Ruiz-Fragoso, Z., Ponce-Hinojosa, G., & Rivas-Arancibia, S. (2015). Changes in C-Reactive Protein and Biochemical Profile in Preschool Children With Obesity. *Nutricion Hospitalaria*, 1:32(n04), 1548–1553. doi:10.3305/nh.2015.32.4.9569
51. Carnethon, M. R., Gulati, M., & Greenland, P. (2005). Prevalence and cardiovascular disease correlates of low cardiorespiratory fitness in adolescents and adults. *The Journal of the American Medical Association*, 294(23), 2981–8. doi:10.1001/jama.294.23.2981
52. Carter, H, Jones, A.M., Barstow, T.J., Burnley, M., Williams, C.A., & Doust, J.H. (2000). Oxygen uptake kinetics in treadmill running and cycle ergometry: a comparison. *Journal of Applied Physiology*, 89(3); 899-907
53. Carson, V., & Janssen, I. (2011). Volume, patterns, and types of sedentary behavior and cardio-metabolic health in children and adolescents: a cross-sectional study. *BMC Public Health*, 11(1), 274. doi:10.1186/1471-2458-11-274
54. Carson, V., Ridgers, N.D., Howard, B.J., Winkler, E.A., Healy, G.N., Owen, N., Dunstan, D.W., & Salmon, J. (2013). Light intensity physical activity and cardiometabolic biomarkers in US adolescents. *PLoS One*, 9(8):e71417. doi 10.1371/journal.pone.0071417.
55. Caspersen, C. J., Powell, K. E., & Christenson, G. M. (1985). Physical activity, exercise, and physical fitness: definitions and distinctions for health-related research. *Public Health Reports*, 100(2), 126–131. doi:10.2307/20056429
56. Centers for Disease Control and Prevention (2015). Division of Nutrition, Physical Activity and Obesity. Retrieved from <http://www.cdc.gov/physicalactivity/basics/children/index.htm>
57. Celermajer, D.S., Sorensen, K.E., Gooch, V.M., Spiegelhalter, D.J., Miller, OI, Sullivan, I.D., Lloyd, J.K., & Deanfield, J.E. (1992) Non-invasive detection of

- endothelial dysfunction in children and adults at risk of atherosclerosis. *Lancet*, 340(8828):1111-5.
58. Chaput, J.-P., Lambert, M., Mathieu, M.-E., Tremblay, M. S., O' Loughlin, J., & Tremblay, A. (2012). Physical activity vs. sedentary time: independent associations with adiposity in children. *Pediatric Obesity*, 7(3), 251–258. doi:10.1111/j.2047-6310.2011.00028.
 59. Chaput, J.-P., Saunders, T. J., Mathieu, M.-È., Henderson, M., Tremblay, M. S., O'Loughlin, J., & Tremblay, A. (2013). Combined associations between moderate to vigorous physical activity and sedentary behaviour with cardiometabolic risk factors in children. *Applied Physiology, Nutrition, and Metabolism*, 38(5), 477–83. doi:10.1139/apnm-2012-0382
 60. Christodoulos, A. D., Douda, H. T., & Tokmakidis, S. P. (2012). Cardiorespiratory fitness, metabolic risk, and inflammation in children. *International Journal of Pediatrics*, 2012, 270515. doi:10.1155/2012/270515
 61. Church, T. S., Barlow, C.E., Earnest, C.P., Kampert, J.B., Priest, E.L., & Blair, S.N. (2002). Associations Between Cardiorespiratory Fitness and C-Reactive Protein in Men. *Arteriosclerosis, Thrombosis, and Vascular Biology*, 22(11), 1869–1876. doi:10.1161/01.ATV.0000036611.77940.F8
 62. Church, T. S., Cheng, Y. J., Earnest, C. P., Barlow, C. E., Gibbons, L. W., Priest, E. L., & Blair, S. N. (2004). Exercise capacity and body composition as predictors of mortality among men with diabetes. *Diabetes Care*, 27(1), 83–8. Retrieved from <http://www.ncbi.nlm.nih.gov/pubmed/14693971>
 63. Coeckelberghs, E., Buys, R., Goetschalckx, K., Cornelissen, V.A., & Vanhees, L. (2015). Prognostic values of the oxygen uptake efficiency slope and other exercise variables in patients with coronary artery disease. *European Journal of Preventive Cardiology*, pii: 2047487315569410 (Epub ahead of print)
 64. Colley, R. C., Garriguet, D., Janssen, I., Craig, C. L., Clarke, J., & Tremblay, M. S. (2011). Physical activity of Canadian children and youth: accelerometer results from the 2007 to 2009 Canadian Health Measures Survey. *Health Reports / Statistics Canada, Canadian Centre for Health Information* 22(1), 15–23. doi:10.1016/j.yspm.2011.03.006
 65. Colley, R. C., Garriguet, D., Janssen, I., Wong, S. L., Saunders, T. J., Carson, V., & Tremblay, M. S. (2013). The association between accelerometer-measured patterns of sedentary time and health risk in children and youth: results from the Canadian Health Measures Survey. *BMC Public Health*, 13(1), 200. doi:10.1186/1471-2458-13-200
 66. Cook, D. G., Mendall, M. A, Whincup, P. H., Carey, I. M., Ballam, L., Morris, J. E., et al. (2000). C-reactive protein concentration in children: relationship to

- adiposity and other cardiovascular risk factors. *Atherosclerosis*, 149(1), 139–150. doi:10.1016/S0021-9150(99)00312-3
67. Corretti, M. C., Anderson, T. J., Benjamin, E. J., Celermajer, D., Charbonneau, F., Creager, M. A. et al. (2002). Guidelines for the ultrasound assessment of endothelial-dependent flow-mediated vasodilation of the brachial artery: a report of the International Brachial Artery Reactivity Task Force. *Journal of the American College of Cardiology*, 39(2), 257–265.
68. Cote, A. T., Harris, K. C., Panagiotopoulos, C., Sandor, G. G. S., & Devlin, A. M. (2013). Childhood Obesity and Cardiovascular Dysfunction. *Journal of the American College of Cardiology*, 62(15), 1309–1319. doi:10.1016/j.jacc.2013.07.042
69. Davies, L. C., Wensel, R., Georgiadou, P., Cicoira, M., Coats, A. J. S., Piepoli, M. F., & Francis, D. P. (2006). Enhanced prognostic value from cardiopulmonary exercise testing in chronic heart failure by non-linear analysis: Oxygen uptake efficiency slope. *European Heart Journal*, 27(6), 684–690. doi:10.1093/eurheartj/ehi672
70. Davies, P. F., Spaan, J. A., & Krams, R. (2005). Shear stress biology of the endothelium. *Annals of Biomedical Engineering*, 33(12), 1714–1718. doi:10.1007/s10439-005-8774-0
71. Davis, P. H., Dawson, J. D., Riley, W. a, & Lauer, R. M. (2001). Carotid intimal-medial thickness is related to cardiovascular risk factors measured from childhood through middle age: The Muscatine Study. *Circulation*, 104(23), 2815–9. Retrieved from <http://www.ncbi.nlm.nih.gov/pubmed/11733400>
72. Dawber, T. R., Moore, F. E., & Mann, G. V. (1950). Coronary Heart Disease in the Framingham Study. *American Journal of Public Health*, 47(Supplement), 4–23.
73. Dawson, J. D., Sonka, M., Blecha, M. B., Lin, W., & Davis, P. H. (2009). Risk factors associated with aortic and carotid intima-media thickness in adolescents and young adults: the Muscatine Offspring Study. *Journal of the American College of Cardiology*, 53(24), 2273–9. doi:10.1016/j.jacc.2009.03.026
74. de Jongh, S., Lilien, M. R., op't Roodt, J., Stroes, E. S. G., Bakker, H. D., & Kastelein, J. J. P. (2002). Early statin therapy restores endothelial function in children with familial hypercholesterolemia. *Journal of the American College of Cardiology*, 40(12), 2117–2121.
75. Deanfield, J. E., Halcox, J. P., & Rabelink, T. J. (2007). Endothelial function and dysfunction: Testing and clinical relevance. *Circulation*, 115(10), 1285–1295. doi:10.1161/CIRCULATIONAHA.106.652859

76. Demiot, C., Dignat-George, F., Fortrat, J.-O., Sabatier, F., Gharib, C., Larina, I., et al. (2007). WISE 2005: chronic bed rest impairs microcirculatory endothelium in women. *American Journal of Physiology. Heart and Circulatory Physiology*, 293(5), H3159–H3164. doi:10.1152/ajpheart.00591.2007
77. Desideri, G., De Simone, M., Iughetti, L., Rosato, T., Iezzi, M. L., Marinucci, M. C., et al. (2005). Early activation of vascular endothelial cells and platelets in obese children. *The Journal of Clinical Endocrinology and Metabolism*, 90(6), 3145–52. doi:10.1210/jc.2004-1741
78. Dowd, K. P., Harrington, D. M., Bourke, A. K., Nelson, J., & Donnelly, A. E. (2012). The measurement of sedentary patterns and behaviors using the activPAL™ Professional physical activity monitor. *Physiological Measurement*, 33(11), 1887. Retrieved from <http://stacks.iop.org/0967-3334/33/i=11/a=1887>
79. Doyon, A., Kracht, D., Bayazit, A. K., Deveci, M., Duzova, A., Krmar, R. T., et al. (2013). Carotid Artery Intima-Media Thickness and Distensibility in Children and Adolescents: Reference Values and Role of Body Dimensions. *Hypertension*, 62(3), 550–556. doi:10.1161/HYPERTENSIONAHA.113.01297
80. Drinkard, B., Roberts, M.D., Ranzenhofer, L.M., Han, J.C., Yanoff, .B., Merke, D.P., et al. (2007) Oxygen-Uptake Efficiency Slope as a Determinant of Fitness in Overweight Adolescents. *Medicine and Science in Sports and Exercise*, 39 (10):1811-1816.
81. Duckles, S.P., & Miller, V.M. (2010). Hormonal modulation of endothelial NO production. *Pflugers Archiv European Journal of Physiology*, 459 (6):841-851
82. Dunstan, D. W., Barr, E. L. M., Healy, G. N., Salmon, J., Shaw, J. E., Balkau, B., et al. (2010). Television Viewing Time and Mortality: The Australian Diabetes, Obesity and Lifestyle Study (AusDiab). *Circulation*, 121(3), 384–391. doi:10.1161/CIRCULATIONAHA.109.894824
83. Dunstan, D. W., Kingwell, B. A., Larsen, R., Healy, G. N., Cerin, E., Hamilton, M. T., et al. (2012). Breaking Up Prolonged Sitting Reduces Postprandial Glucose and Insulin Responses. *Diabetes Care*, 35(5), 976–983. doi:10.2337/dc11-1931.
84. Durand, M.J., and Gutterman, D.D. (2014) Exercise and Vascular Function-How Much is too Much? *Canadian Journal of Physiology and Pharmacology*, 92(7): 551-557
85. Eisenmann, J. C., Welk, G. J., Wickel, E. E., & Blair, S. N. (2007). Combined influence of cardiorespiratory fitness and body mass index on cardiovascular disease risk factors among 8–18 year old youth: The Aerobics Center

- Longitudinal Study. *International Journal of Pediatric Obesity*, 2(2), 66–72. doi:10.1080/17477160601133713
86. Eisenmann, J. C., Wickel, E. E., Welk, G. J., & Blair, S. N. (2005). Relationship between adolescent fitness and fatness and cardiovascular disease risk factors in adulthood: The Aerobics Center Longitudinal Study (ACLS). *American Heart Journal*, 149(1), 46–53. doi:10.1016/j.ahj.2004.07.016
 87. Ekelund, U., Brage, S., Froberg, K., Harro, M., Anderssen, S. A., Sardinha, L. B., et al., (2006). TV Viewing and Physical Activity Are Independently Associated with Metabolic Risk in Children: The European Youth Heart Study. *PLoS Medicine*, 3(12), e488. doi:10.1371/journal.pmed.0030488
 88. Ekelund, U., Anderssen, S. a, Froberg, K., Sardinha, L. B., Andersen, L. B., & Brage, S. (2007). Independent associations of physical activity and cardiorespiratory fitness with metabolic risk factors in children: the European youth heart study. *Diabetologia*, 50(9), 1832–40. doi:10.1007/s00125-007-0762-5
 89. Ekelund, U., Luan, J., Sherar, L. B., Esliger, D. W., Griew, P., & Cooper, A. R. (2012). Moderate to Vigorous Physical Activity and Sedentary Time and Cardiometabolic Risk Factors in Children and Adolescents. *The Journal of American Medical Association*, 307(7), 704–712. doi:10.1016/j.yspm.2012.03.030
 90. Enos, M. W.F., Col, L., Holmes, R.H., & Army, U.S. (1953) CORONARY DISEASE AMONG UNITED STATES SOLDIERS KILLED IN ACTION IN KOREA. *The Journal of the American Medical Association*, 152(12); 1090-1093.
 91. Erikssen, G., Liestøl, K., Bjørnholt, J., Thaulow, E., Sandvik, L., & Erikssen, J. (1998). Changes in physical fitness and changes in mortality. *Lancet*, 352(9130), 759–762. doi:10.2165/00007256-200131080-00001
 92. Espeland, M. a., Tang, R., Terry, J. G., Davis, D. H., Mercuri, M., & Crouse, J. R. (1999). Associations of Risk Factors With Segment-Specific Intimal-Medial Thickness of the Extracranial Carotid Artery. *Stroke*, 30(5), 1047–1055. doi:10.1161/01.STR.30.5.1047
 93. Farpour-Lambert, N. J., Aggoun, Y., Marchand, L. M., Martin, X. E., Herrmann, F. R., & Beghetti, M. (2009). Physical Activity Reduces Systemic Blood Pressure and Improves Early Markers of Atherosclerosis in Pre-Pubertal Obese Children. *Journal of the American College of Cardiology*, 54(25), 2396–2406. doi:10.1016/j.jacc.2009.08.030
 94. Fearon, W. F., & Fearon, D. T. (2008). Inflammation and Cardiovascular Disease: Role of the Interleukin-1 Receptor Antagonist. *Circulation*, 117(20), 2577–2579. doi:10.1161/CIRCULATIONAHA.108.772491

95. Fernhall, B., & Agiovlasitis, S. (2008). Arterial function in youth: window into cardiovascular risk. *Journal of Applied Physiology (Bethesda, Md. : 1985)*, *105*(1), 325–33. doi:10.1152/jappphysiol.00001.2008
96. Ferreira, I., Twisk, J. W. R., Van Mechelen, W., Kemper, H. C. G., & Stehouwer, C. D. (2002). Current and adolescent levels of cardiopulmonary fitness are related to large artery properties at age 36: the Amsterdam Growth and Health Longitudinal Study. *European Journal of Clinical Investigation*, *32*(10), 723–31. Retrieved from <http://www.ncbi.nlm.nih.gov/pubmed/12406019>
97. Fisher, K., Ruttgers, D., Muller, H.P., Jacobs, G., Kassaubek, J., Lieb, W., & Nothlings, U. (2015). Association of Habitual Patterns and Types of Physical Activity and Inactivity with MRI-Determined Total Volumes of Visceral and Subcutaneous Abdominal Adipose Tissue in a General White Population. *PLoS One*, *10*(11); doi:10.1371/journal.pone.0143925
98. Flammer, A. J., Anderson, T., Celermajer, D. S., Creager, M. A., Deanfield, J., Ganz, P., Hamburg, N.M., Luscher, T.F., Shechter, M., Taddei, S., Vita, J.A., & Lerman, A. (2012). The Assessment of Endothelial Function: From Research Into Clinical Practice. *Circulation*, *126*(6), 753–767. doi:10.1161/CIRCULATIONAHA.112.093245
99. Fleg, J. L., Morrell, C.H., Bos, A.G., Brant, L.J., Talbot, L.A., Wright, J.G., & Lakatta, E.G. (2005). Accelerated Longitudinal Decline of Aerobic Capacity in Healthy Older Adults. *Circulation*, *112*(5), 674–682. doi:10.1161/CIRCULATIONAHA.105.545459
100. Flynn, J. T. (2006). What is the significance of increased carotid intima media thickness in hypertensive adolescents? *Hypertension*, *48*(1), 23–24. doi:10.1161/01.HYP.0000226914.44904.ca
101. Ford, E. S. (2003). C-reactive protein concentration and cardiovascular disease risk factors in children: Findings from the National Health and Nutrition Examination Survey 1999-2000. *Circulation*, *108*(9), 1053–1058. doi:10.1161/01.CIR.0000080913.81393.B8
102. Fotis, L., Giannakopoulos, D., Stamogiannou, L., & Xatzipsalti, M. (2012). Intercellular cell adhesion molecule-1 and vascular cell adhesion molecule-1 in children. Do they play a role in the progression of atherosclerosis? *Hormones (Athens, Greece)*, *11*(2), 140–6. Retrieved from <http://www.ncbi.nlm.nih.gov/pubmed/22801559>
103. Freedson, P., Pober, D., & Janz, K. F. (2005). Calibration of accelerometer output for children. *Medicine and Science in Sports and Exercise*, *37*(11 Suppl.), S523–530. doi:10.1249/01.mss.0000185658.28284.ba

104. Friedemann C, Heneghan C, Mahtani K, Thompson M, Perera R, Ward A.M.(2012) Cardiovascular disease risk in healthy children and its association with body mass index: systematic review and meta-analysis. *British Medical Journal*, 25;345:e4759. doi: 10.1136/bmj.e4759.
105. Fukai, T., Siegfried, M. R., Ushio-Fukai, M., Cheng, Y., Kojda, G., & Harrison, D. G. (2000). Regulation of the vascular extracellular superoxide dismutase by nitric oxide and exercise training. *The Journal of Clinical Investigation*, 105(11), 1631–1639. doi:10.1172/JCI9551
106. Furchgott, R. F., & Zawadzki, J. V. (1980). The obligatory role of endothelial cells in the relaxation of arterial smooth muscle by acetylcholine. *Nature*, 288(5789), 373–376. doi:10.1038/288373a0
107. Gabel, L., Ridgers, N. D., Della Gatta, P. A., Arundell, L., Cerin, E., Robinson, S., *et al.*, (2015). Associations of sedentary time patterns and TV viewing time with inflammatory and endothelial function biomarkers in children. *Pediatric Obesity*, doi:10.1111/ijpo.12045.(Epub ahead of print)
108. Get Ireland Active (2016). Promoting Physical activity in Ireland. Retrieved from <http://www.getirelandactive.ie/guidelines-resources/how-much-physical-activity-is-required/>
109. Gibbs, B.B., Dobrosielski, D.A., Lima, M., Bonekamp, S., Stewart, K.J., & Clark, J.M. (2011). The Association between Arterial Shear Stress and Flow Mediated Dilation in Diabetes. *Vascular Medicine*, 16(4):267-274
110. Głowińska-Olszewska, B., Tolwiska, J., & Urban, M. (2007) Relationship between endothelial dysfunction, carotid intima media thickness and circulating markers of vascular inflammation in obese hypertensive children and adolescents. *Journal of Pediatric Endocrinology & Metabolism*, 20(10): 1125-1136
111. Głowińska-Olszewska, B., Moniuszko, M., Hryniewicz, A., Jeznach, M., Rusak, M., Dąbrowska, M., *et al.*, (2013). Relationship between circulating endothelial progenitor cells and endothelial dysfunction in children with type 1 diabetes: a novel paradigm of early atherosclerosis in high-risk young patients. *European Journal of Endocrinology / European Federation of Endocrine Societies*, 168(2), 153–61. doi:10.1530/EJE-12-0857
112. Goar, F.G.S., Pinto, F.J., Alderman, E.L., Fitzgerald, P.J., Stinson, E.B., Billingham, M.E., & Popp, R.L (1992). Detection of Coronary Atherosclerosis in Young Adult Hearts Using Intravascular Ultrasound. *Circulation*, 86(3):756-63
113. Goldfield, G.S., Ssaunders, T.J., Kenny, G.P., *et al.* (2013). Screen viewing and diabetes risk factors in overweight and obese adolescents. *American Journal of Preventive Medicine*, 44(Suppl 4):S364-70

114. Goodman E, Dolan L.M., Morrison J.A., Daniels S.R., (2005). Factor analysis of clustered cardiovascular risks in adolescence: obesity is the predominant correlate of risk among youth. *Circulation*. 19;111(15):1970-7.
115. Gokce, N., Keaney, J. F., Hunter, L. M., Watkins, M. T., Nedeljkovic, Z. S., Menzoian, J. O., & Vita, J. A. (2003). Predictive value of noninvasively determined endothelial dysfunction for long-term cardiovascular events in patients with peripheral vascular disease. *Journal of the American College of Cardiology*, 41(10), 1769–1775. doi:10.1016/S0735-1097(03)00333-4
116. Gomez- Ambrosi, J., Azcona, C., Patino- Gracia, A., Fruhbeck, G. (2008). Serum Amyloid A concentration is increased in obese children and adolescents . *Pediatrics*, 153 (1), 71-75.
117. Gortmaker, Must, Perrin, Sobol, D. (1993). The New England Journal of Medicine Downloaded from nejm.org at IREL on December 19, 2011. For personal use only. No other uses without permission. Copyright © 1993 Massachusetts Medical Society. All rights reserved.
118. Goto, C., Higashi, Y., Kimura, M., Noma, K., Hara, K., Nakagawa, K., et al.,(2003). Effect of different intensities of exercise on endothelium dependent vasodilation in humans: Role of Endothelium-Dependent Nitric Oxide and Oxidative Stress. *Circulation*, 108(5): 530-535.
119. Green, D. J., Maiorana, A., O’Driscoll, G., & Taylor, R. (2004). Effect of exercise training on endothelium-derived nitric oxide function in humans. *The Journal of Physiology*, 561(Pt 1), 1–25. doi:10.1113/jphysiol.2004.068197
120. Green, D. J., Walsh, J. H., Maiorana, A., Best, M. J., Taylor, R. R., & O’Driscoll, J. G. (2003). Exercise-induced improvement in endothelial dysfunction is not mediated by changes in CV risk factors: pooled analysis of diverse patient populations. *American Journal of Physiology. Heart and Circulatory Physiology*, 285(6), H2679–H2687. doi:10.1152/ajpheart.00519.2003
121. Greenland, P., Knoll, M.D., & Stamler, J. (2003) Major risk factors as antecedents of fatal and non fatal coronary heart disease events. *The Journal of the American Medical Association*, 290; 891-897.
122. Grøntved, A., & Hu, F. B. (2011). Television viewing and risk of type 2 diabetes, cardiovascular disease, and all-cause mortality: a meta-analysis. *The Journal of the American Medical Association*, 305(23), 2448–55. doi:10.1001/jama.2011.812
123. Gulati, M., Pandey, D.K., Arnsdorf, M.F., Lauderdale, D.S., Thisted, R.A., Wicklund R.H., Al-Hani, A.J., & Black, H.R. (2003). Exercise Capacity and

- the Risk of Death in Women: The St James Women Take Heart Project. *Circulation*, 108(13), 1554–1559. doi:10.1161/01.CIR.0000091080.57509.E9
124. Halcox, J. P. J., Schenke, W. H., Zalos, G., Mincemoyer, R., Prasad, A., Waclawiw, M., Nour, K.R., & Quyyumi, A.A..(2002). Prognostic Value of Coronary Vascular Endothelial Dysfunction. *Circulation*, 106(6), 653–658. doi:10.1161/01.CIR.0000025404.78001.D8
125. Halle, M., Korsten-Reck, U., Wolfarth, B., & Berg, A. (2004). Low-grade systemic inflammation in overweight children: impact of physical fitness. *Exercise Immunology Review*, 10, 66–74. Retrieved from <http://www.ncbi.nlm.nih.gov/pubmed/15633587>
126. Hambrecht, R. (2003). Regular Physical Activity Improves Endothelial Function in Patients With Coronary Artery Disease by Increasing Phosphorylation of Endothelial Nitric Oxide Synthase. *Circulation*, 107(25), 3152–3158. doi:10.1161/01.CIR.0000074229.93804.5C
127. Hamburg, N. M., McMackin, C. J., Huang, A. L., Shenouda, S. M., Michael, E., Schulz, E., et al.(2008). Physical Inactivity Rapidly Induces Insulin Resistance and Microvascular Dysfunction in Healthy Volunteers. *Arteriosclerosis Thrombosis and Vascular Biology*, 27(12), 2650–2656.
128. Hamilton, M., Hamilton, D., & Zderic, T. (2007). Role of low energy expenditure and sitting in obesity, metabolic syndrome, type 2 diabetes, and cardiovascular disease. *Diabetes*, 56(November), 2655–2667. doi:10.2337/db07-0882.
129. Hamilton, M. T., Etienne, J., McClure, W. C., Pavey, B. S., & Holloway, A. K. (1998). Role of local contractile activity and muscle fiber type on LPL regulation during exercise. *The American Journal of Physiology*, 275 (6 Pt 1):E1016–E1022.
130. Hamilton, M. T., Hamilton, D. G., & Zderic, T. W. (2004). Exercise physiology versus inactivity physiology: an essential concept for understanding lipoprotein lipase regulation. *Exercise and Sport Sciences Reviews*, 32(4), 161–6
131. Harrington, J., Peña, A. S., Gent, R., Hirte, C., & Couper, J. (2010). Aortic intima media thickness is an early marker of atherosclerosis in children with type 1 diabetes mellitus. *The Journal of Pediatrics*, 156(2), 237–41. doi:10.1016/j.jpeds.2009.08.036
132. Harrington, D.M., Dowd, K.P. Bourke, A.K. & Donnelly, A.E. (2011) Cross-sectional analysis of levels and patterns of objectively measured sedentary time in adolescent females. *International Journal of Behavioural Nutrition and*

133. Harris, R. A., Nishiyama, S. K., Wray, D. W., & Richardson, R. S. (2010). Ultrasound assessment of flow-mediated dilation. *Hypertension*, 55(5), 1075–1085. doi:HYPERTENSIONAHA.110.150821
[pii]\r10.1161/HYPERTENSIONAHA.110.150821
134. Hassinen, M., Lakka, T.A., Savonen, K., Litmanen, H., Kiviahho, L., Laaksonen, D.E., Komulainen, P., & Rauramaa, R. (2008). Cardiorespiratory Fitness as a Feature of Metabolic Syndrome in Older Men and Women. *Diabetes Care*, 31(6), 1242–1247. doi:10.2337/dc07-2298.
135. Haycock, G.B., Schwartz, G.J., Wisotsky, D.H.(1978). Geometric method for measuring body surface area: a height-weight formula validated in infants, children and adults. *Journal of Pediatrics*, 93(1):62-6.
136. Healy, G. N., Dunstan, D. W., Salmon, J., Cerin, E., Shaw, J. E., Zimmet, P. Z., & Owen, N. (2007). Objectively measured light-intensity physical activity is independently associated with 2-h plasma glucose. *Diabetes Care*, 30(6), 1384–9. doi:10.2337/dc07-0114
137. Henderson, M., Gray-Donald, K., Mathieu, M.-E., Barnett, T. A., Hanley, J. A., O’Loughlin, J., et al. (2012). How Are Physical Activity, Fitness, and Sedentary Behavior Associated With Insulin Sensitivity in Children? *Diabetes Care*, 35(6), 1272–1278. doi:10.2337/dc11-1785
138. Hollenberg, M., & Tager, I. B. (2000). Oxygen uptake efficiency slope: An index of exercise performance and cardiopulmonary reserve requiring only submaximal exercise. *Journal of the American College of Cardiology*, 36(1), 194–201. doi:10.1016/S0735-1097(00)00691-4
139. Holman, R.L., McGill, H.C., Strong, J.P., and Geer, J.C.(1958). The Natural History of Atherosclerosis. *The American Journal of Pathology*, 34(2):209-235
140. Hasselstrom, H., Hansen, S.E., Froberg, K.,& Andersen, L.B. (2002) Physical fitness and physical activity during adolescence as predictors of cardiovascular disease risk in young adulthood. Danish Youth and Sports Study. An eight-year follow-up study. *International Journal of Sports Medicine*, 23(Suppl 1): S27-31.
141. Hopkins, N.D., Stratton, G., Tinken, T.M., McWhannell, N., Ridgers, N.D., Graves, L.E.F. et al. (2009). Relationships between measures of fitness, physical activity, body composition and vascular function in children. *Atherosclerosis*, 204(1), 244–9. doi:10.1016/j.atherosclerosis.2008.09.004
142. Hopkins, N. D., Stratton, G., Tinken, T. M., Ridgers, N. D., Graves, L. E., McWhannell, N., et al. (2011). Seasonal reduction in physical activity and flow-

- mediated dilation in children. *Medicine and Science in Sports and Exercise*, 43(2), 232–8. doi:10.1249/MSS.0b013e3181e90e
143. Hopkins, N., Stratton, G., Ridgers, N. D., Graves, L. E. F., Cable, N. T., & Green, D. J. (2012). Lack of relationship between sedentary behaviour and vascular function in children. *European Journal of Applied Physiology*, 112(2), 617–22. doi:10.1007/s00421-011-2011-3
144. Howard, G., Sharrett, a. R., Heiss, G., Evans, G. W., Chambless, L. E., Riley, W. a., & Burke, G. L. (1993). Carotid artery intimal-medial thickness distribution in general populations as evaluated by B-mode ultrasound. ARIC Investigators. *Stroke*, 24(9), 1297–1304. doi:10.1161/01.STR.24.9.1297
145. Hsu, Y., Belcher, B. R., Ventura, E. E., Byrd-williams, C. E., Weigensberg, M. J., Davis, J. N. et al. (2011). Physical Activity, Sedentary Behavior, and the Metabolic Syndrome in Minority Youth., (16), 2307–2313. doi:10.1249/MSS.0b013e318222020f
146. Iannuzzi, A., Licenziati, M. R., Acampora, C., Salvatore, V., Auriemma, L., Romano, M.L. et al. (2004). Increased carotid intima-media thickness and stiffness in obese children. *Diabetes Care*, 27(10), 2506–2508.
147. Irish Heart Foundation. (2015). Facts on Heart disease and stroke. Retrieved from:https://www.irishheart.ie/iopen24/facts-heart-disease-stroke-t-7_18.html
148. Jackson, A. S., Sui, X., Hébert, J. R., Church, T. S., & Blair, S. N. (2009). Role of lifestyle and aging on the longitudinal change in cardiorespiratory fitness. *Archives of Internal Medicine*, 169(19), 1781–1787. doi:10.1001/archinternmed.2009.312
149. Janz, K. F., Dawson, J. D., & Mahoney, L. T. (2000). Tracking physical fitness and physical activity from childhood to adolescence: the muscatine study. *Medicine and Science in Sports and Exercise*, 32(7), 1250–1257. doi:10.1097/00005768-200007000-00011
150. Jarvisalo, M. J., Harmoinen, A., Hakanen, m., Paakkunainen, U., Viikari, J., Hartiala, J, et al. (2002). Elevated Serum C-Reactive Protein Levels and Early Arterial Changes in Healthy Children. *Arteriosclerosis, Thrombosis, and Vascular Biology*, 22(8), 1323–1328. doi:10.1161/01.ATV.0000024222.06463.21
151. Jarvisalo, M. J., Jartti, L., Nanto-Salonen, K., Irjala, K., Ronnema, T., Hartiala, J. J., et al. (2001). Increased Aortic Intima-Media Thickness: A Marker of Preclinical Atherosclerosis in High-Risk Children. *Circulation*, 104(24), 2943–2947. doi:10.1161/hc4901.100522

152. Järvisalo, M. J., Raitakari, M., Toikka, J. O., Putto-Laurila, A., Rontu, R., Laine, S. et al. (2004). Endothelial Dysfunction and Increased Arterial Intima-Media Thickness in Children with Type 1 Diabetes. *Circulation*, *109*(14), 1750–1755. doi:10.1161/01.CIR.0000124725.46165.2C
153. Järvisalo, M. J., & Raitakari, O. T. (2005). Ultrasound assessment of endothelial function in children. *Vascular Health and Risk Management*, *1*(3), 227–233.
154. Järvisalo, M. J., Rönnemaa, T., Volanen, I., Kaitosaari, T., Kallio, K., Hartiala, J. J. et al., (2002). Brachial artery dilatation responses in healthy children and adolescents. *American Journal of Physiology. Heart and Circulatory Physiology*, *282*(1), H87–H92.
155. Jarvisalo, Mikko J., Putto-laurila, A., Jartti, L., Lehtima, T., & Solakivi, T. (2002). Carotid Artery Intima-Media Thickness in Children with Type 1 Diabetes. *Diabetes*, *51*, 493–498.
156. Johnson, B. D., Kip, K. E., Marroquin, O. C., Ridker, P. M., Kelsey, S. F., Shaw, L. J., et al.(2004). Serum Amyloid A as a Predictor of Coronary Artery Disease and Cardiovascular Outcome in Women: The National Heart, Lung, and Blood Institute-Sponsored Women’s Ischemia Syndrome Evaluation (WISE). *Circulation*, *109*(6), 726–732. doi:10.1161/01.CIR.0000115516.54550.B1
157. Joyner, M. J., & Green, D. J. (2009). Exercise protects the cardiovascular system: effects beyond traditional risk factors. *The Journal of Physiology*, *587*(Pt 23), 5551–5558. doi:10.1113/jphysiol.2009.179432
158. Juhola, J., Magnussen, C. G., Viikari, J. S. a, Kähönen, M., Hutri-Kähönen, N., Jula, A., et al. (2011). Tracking of serum lipid levels, blood pressure, and body mass index from childhood to adulthood: the Cardiovascular Risk in Young Finns Study. *The Journal of Pediatrics*, *159*(4), 584–90.
159. Jung, C., Gerdes, N., Fritzenwanger, M., & Figulla, H. R. (2010). Circulating levels of interleukin-1 family cytokines in overweight adolescents. *Mediators of Inflammation*, *2010*(II), 958403. doi:10.1155/2010/958403
160. Juonala, M., Magnussen, C. G., Venn, A., Dwyer, T., Burns, T. L., Davis, P. H., et al. (2010). Influence of Age on Associations Between Childhood Risk Factors and Carotid Intima-Media Thickness in Adulthood The Cardiovascular Risk in Young Finns Study , the Childhood Determinants of Adult Health Study , the Bogalusa Heart Study , and the Muscatine Study for the Intenational Childhood Cardiovascular cohor (i3C) Consortium. *Circulation*, *122*, 2514–2520.

161. Juonala, M., Viikari, J. S. a, Kähönen, M., Taittonen, L., Laitinen, T., Hutri-Kähönen, N. et al. (2010). Life-time risk factors and progression of carotid atherosclerosis in young adults: the Cardiovascular Risk in Young Finns study. *European Heart Journal*, 31(14), 1745–51. doi:10.1093/eurheartj/ehq141
162. Kaminsky, L.A. Arena, R., Beckie, T.M., Brubaker, P.H., Church, T.S., Forman, D.E., Franklin, B.A., Gulati, M. et al.,(2013). The Importance of Cardiorespiratory Fitness in the United States: The need for a National Registry. A Policy Statement From the American Heart Association. *Circulation*; 127:652-662
163. Kapiotis, S., Holzer, G., Schaller, G., Haumer, M., Widhalm, H., Weghuber, D., et al. (2006). A proinflammatory state is detectable in obese children and is accompanied by functional and morphological vascular changes. *Arteriosclerosis, Thrombosis, and Vascular Biology*, 26(11), 2541–2546. doi:10.1161/01.ATV.0000245795.08139.70
164. Karpoff, L., Vinet, A, Schuster, I., Oudot, C., Goret, L., Dauzat, M., et al. (2009). Abnormal vascular reactivity at rest and exercise in obese boys. *European Journal of Clinical Investigation*, 39(2), 94–102. doi:10.1111/j.1365-2362.2008.02068.x
165. KATZMARZYK, P. T., CHURCH, T. S., CRAIG, C. L., & BOUCHARD, C. (2009). Sitting Time and Mortality from All Causes, Cardiovascular Disease, and Cancer. *Medicine & Science in Sports & Exercise*, 41(5), 998–1005. doi:10.1249/MSS.0b013e3181930355
166. Kaufman, C. L., Kaiser, D. R., Steinberger, J., & Dengel, D. R. (2007). Relationships between heart rate variability, vascular function, and adiposity in children. *Clinical Autonomic Research*, 17(3), 165–171. doi:10.1007/s10286-007-0411-6
167. Kavey, R. W., Daniels, S. R., Lauer, R. M., Atkins, D. L., Laura, L., Taubert, K., et al. (2003). American Heart Association Guidelines for Primary Prevention of Atherosclerotic Cardiovascular Disease Beginning in Childhood. *Circulation*, 107 (11), 1562–1566. doi:10.1161/01.CIR.0000061521.15730.6E
168. Kelishadi, R., Hashemi, M., Mohammadifard, N., Asgary, S., & Khavarian, N. (2008). Association of changes in oxidative and proinflammatory states with changes in vascular function after a lifestyle modification trial among obese children. *Clinical Chemistry*, 54(1), 147–53. doi:10.1373/clinchem.2007.089953
169. Kelly, A.S., Wetzsteon, R.J., Kaiser, D.R., Steinberger, J., Bank, A.J., Dengel, D.R. (2004). Inflammation, Insulin, and Endothelial Function in Overweight Children and Adolescents: The Role of Exercise. *Pediatrics*, 145(6), 731-736.

170. Kelly, A. S., Steinberger, J., Olson, T. P., & Dengel, D. R. (2007). In the absence of weight loss, exercise training does not improve adipokines or oxidative stress in overweight children. *Metabolism: Clinical and Experimental*, *56*(7), 1005–9. doi:10.1016/j.metabol.2007.03.009
171. Kemper, H. C., Snel, J., Verschuur, R., & Storm-van Essen, L. (1990). Tracking of health and risk indicators of cardiovascular diseases from teenager to adult: Amsterdam Growth and Health Study. *Preventive Medicine*, *19*(6), 642–55. doi:10.1016/0091-7435(90)90061-N
172. Keskin, M., Kurtoglu, S., Kendirci, M., Atabek, M. E., & Yazici, C. (2005). Homeostasis Model Assessment Is More Reliable Than the Fasting Glucose/Insulin Ratio and Quantitative Insulin Sensitivity Check Index for Assessing Insulin Resistance Among Obese Children and Adolescents. *Pediatrics*, *115*(4), e500–e503. doi:10.1542/peds.2004-1921
173. Khot, U.N., Khot, M.B., Bajzeri, C.T., Sapp, S.K., Magnus Ohman, E., M. Brener, S.J. et al. (2003). Prevalence of Conventional risk factors in patients with coronary artery disease; *The Journal of the American Medical Association*, *290*; 898-904
174. Kim, K., Must, A., Fitzmaurice, G.M., Gillman, M.W., Chomitz, V., Kramer, E., Mc Gowan, R., & Peterson, K.E. (2005). Relationship of physical fitness to prevalence and incidence of overweight among schoolchildren. *Obesity Research*, *13*(7):1246-54.
175. Kim, E. S., Park, J. H., Lee, M. K., Lee, D. H., Kang, E. S., Lee, H. C., et al. (2011). Associations between fatness, fitness, IGF and IMT among obese Korean male adolescents. *Diabetes and Metabolism Journal*, *35*, 610–618. doi:10.4093/dmj.2011.35.6.610
176. Kingwell, B., Tran, B., Cameron, J., Jennings, G. & Dart, A. (1996) Enhanced Vasodilation to Acetylcholine in Athletes is Associated with Lower Plasma Cholesterol. *American Journal of physiology. Heart and circulatory physiology*, *270* (6 Pt 2), H2008–H2013
177. Kitta, Y., Obata, J., Nakamura, T., Hirano, M., Kodama, Y., Fujioka, D. Saito, Y., Kawabata, K., Sano, K., Kobayashi, T., Yano, T., Nakamura, K., & Kugiyama, K. (2009). Persistent impairment of endothelial vasomotor function has a negative impact on outcome in patients with coronary artery disease. *Journal of the American College of Cardiology*, *53*(4), 323–30. doi:10.1016/j.jacc.2008.08.074
178. Kodama, S., Saito, K., Tanaka, S., Maki, M., Yachi, Y., Asumi, M., Sugawara, A., et al. (2009). Cardiorespiratory Fitness as a Quantitative Predictor of All-Cause Mortality and Cardiovascular events in Healthy Men and Women. *The Journal of the American Medical Association*, *301*(19): 2204-35.

179. Kofler, S., Nickel, T., & Weis, M. (2005). Role of cytokines in cardiovascular diseases: a focus on endothelial responses to inflammation. *Clinical Science (London, England: 1979)*, *108*(3), 205–213. doi:10.1042/CS20040174
180. Kokkinos, P., Myers, J., Kokkinos, J. P., Pittaras, A., Narayan, P., Manolis, A. et al. (2008). Exercise capacity and mortality in black and white men. *Circulation*, *117*(5), 614–622. doi:10.1161/CIRCULATIONAHA.107.734764
181. Kosuge, M., Ebina, T., Ishikawa, T., Hibi, K., Tsukahara, K., Okuda, J. et al. (2007). Serum Amyloid A is a Better Predictor of Clinical Outcomes than C-Reactive Protein in Non-ST-Segment, *71*(February), 186–190.
182. Kristensen, P. L., Moller, N. C., Korsholm, L., Wedderkopp, N., Andersen, L. B., & Froberg, K. (2008). Tracking of objectively measured physical activity from childhood to adolescence: the European youth heart study. *Scandinavian Journal of Medicine and Science in Sports*, *18*(2), 171–178. doi:10.1111/j.1600-0838.2006.00622.x
183. Kuczmarski, R. J., Ogden, C. L., Guo, S. S., Grummer-Strawn, L. M., Flegal, K. M., Mei, Z., et al. (2002). *2000 CDC Growth Charts for the United States: Methods and Development. Vital and health statistics.*
184. Kuo, H., Yen, C., Chen, J., Yu, Y., & Bean, J. F. (2007). Association of cardiorespiratory fitness and levels of C-reactive protein : Data from the National Health and Nutrition Examination Survey 1999 – 2002. *International Journal of Cardiology*, *114*, (1): 28–33. doi:10.1016/j.ijcard.2005.11.110
185. Kusters, D. M., Wiegman, A., Kastelein, J. J. P., & Hutten, B. A. (2014). Carotid intima-media thickness in children with familial hypercholesterolemia. *Circulation Research*, *114*(2), 307–310. doi:10.1161/CIRCRESAHA.114.301430
186. Kwon, S., Burns, T. L., Levy, S. M., & Janz, K. F. (2013). Which contributes more to childhood adiposity-high levels of sedentarism or low levels of moderate-through-vigorous physical activity? The Iowa Bone Development Study. *The Journal of Pediatrics*, *162*(6), 1169–74. doi:10.1016/j.jpeds.2012.11.071
187. LaMonte, M. J., Barlow, C. E., Jurca, R., Kampert, J. B., Church, T. S., & Blair, S. N. (2005). Cardiorespiratory fitness is inversely associated with the incidence of metabolic syndrome: A prospective study of men and women. *Circulation*, *112*(4), 505–512. doi:10.1161/CIRCULATIONAHA.104.503805
188. Lande, M. B., Carson, N. L., Roy, J., & Meagher, C. C. (2006). Effects of childhood primary hypertension on carotid intima media thickness: a matched controlled study. *Hypertension*, *48*(1), 40–4. doi:10.1161/01.HYP.0000227029.10536.e8

189. Landmesser, U., Dikalov, S., Price, S. R., McCann, L., Fukai, T., Holland, S. M., et al. (2003). Oxidation of tetrahydrobiopterin leads to uncoupling of endothelial cell nitric oxide synthase in hypertension. *Journal of Clinical Investigation*, *111*(8), 1201–1209. doi:10.1172/JCI14172
190. Laufs, U., Wassmann, S., Czech, T., Munzel, T., Eisenhauer, M. Bohm, M. & Nickenig, G. (2005). Physical Inactivity Increases Oxidative Stress, Endothelial Dysfunction, and Atherosclerosis. *Arteriosclerosis, Thrombosis, and Vascular Biology*, *25*(4), 809–814. doi:10.1161/01.ATV.0000158311.24443.af
191. Laurer, R.M., & Clarke, W. R. (1989). Childhood Risk Factors for High Adult Blood Pressure: The Muscatine Study. *Pediatrics*, *84*(4), 633–641.
192. Laurer, R.M., Lee, J. and Clarke, W. R. (1988). Factors affecting the relationship between childhood and adult cholesterol levels.: The Muscatine Study. *Pediatrics*, *82*(3), 309–318.
193. Lavie, C.J., Swift, D.L., Johannsen, N.M., Arena, R., & Church, T.S. (2012). Physical Fitness- An Often Forgotten Cardiovascular Risk Factor. *Journal of Glycomics Lipidomics* 2:e104. doi: 10.4172/2153-0637.1000e104
194. Le, J., Zhang, D., Menees, S., Chen, J., & Raghuvver, G. (2010). “Vascular age” is advanced in children with atherosclerosis-promoting risk factors. *Circulation. Cardiovascular Imaging*, *3*(1), 8–14. doi:10.1161/CIRCIMAGING.109.880070
195. Lee, C.D., & Blair, S.N. (2002) Cardiorespiratory fitness and smoking-related total cancer mortality in men. *Medicine & Science in Sports & Exercise*, *34*(5): 735-9
196. Lee, D. -c., Sui, X., Artero, E. G., Lee, I.-M., Church, T. S., McAuley, P. A., et al. (2011). Long-Term Effects of Changes in Cardiorespiratory Fitness and Body Mass Index on All-Cause and Cardiovascular Disease Mortality in Men: The Aerobics Center Longitudinal Study. *Circulation*, *124*(23), 2483–2490. doi:10.1161/CIRCULATIONAHA.111.038422
197. Lee, C. Do, Blair, S. N., & Jackson, A. S. (1999). Cardiorespiratory fitness , body composition , and all-cause and cardiovascular disease mortality in men. *The American Journal of Clinical Nutrition*, *69*(3): 373-80.
198. Lee, I.-M., Shiroma, E. J., Lobelo, F., Puska, P., Blair, S. N., & Katzmarzyk, P. T. (2012). Effect of physical inactivity on major non-communicable diseases worldwide: an analysis of burden of disease and life expectancy. *The Lancet*, *380*(9838), 219–229. doi:10.1016/S0140-6736(12)61031-9
199. Lefevre, J., Philippaerts, R., Delvaux, K., Thomis, M., Claessens, a L., Lysens, R., et al. (2002). Relation between cardiovascular risk factors at adult age, and

- physical activity during youth and adulthood: the Leuven Longitudinal Study on Lifestyle, Fitness and Health. *International Journal of Sports Medicine*, 23 Suppl 1(16), S32–8. doi:10.1055/s-2002-28459
200. Léger, L. A., Mercier, D., Gadoury, C., & Lambert, J. (1988). The multistage 20 metre shuttle run test for aerobic fitness. *Journal of Sports Sciences*, 6(2), 93–101. doi:10.1080/02640418808729800
201. Leite, S. A., Monk, A. M., Upham, P. A., & Bergenstal, R. M. (2009). Low cardiorespiratory fitness in people at risk for type 2 diabetes: early marker for insulin resistance. *Diabetology & Metabolic Syndrome*, 1(1), 8. doi:10.1186/1758-5996-1-8
202. Levine, J. A., Vander Weg, M.W., Hill, J.O., Klesges, R.C. (2006). Non-Exercise Activity Thermogenesis: The Crouching Tiger Hidden Dragon of Societal Weight Gain. *Arteriosclerosis, Thrombosis, and Vascular Biology*, 26(4), 729–736. doi:10.1161/01.ATV.0000205848.83210.73
203. Li, S., Chen, W., Srinivasan, S. R., Bond, M. G., Tang, R., Urbina, E. M., & Berenson, G. S. (2003). Childhood cardiovascular risk factors and carotid vascular changes in adulthood: the Bogalusa Heart Study. *JAMA : The Journal of the American Medical Association*, 290(17), 2271–6. doi:10.1001/jama.290.17.2271
204. Libby, P., Okamoto, Y., Rocha, V. Z., & Folco, E. (2010). Inflammation in Atherosclerosis: *Circulation Journal*, 74(2), 213–220. doi:10.1253/circj.CJ-09-0706
205. Litwin, M., Niemirska, A., Sladowska, J., Antoniewicz, J., Daszkowska, J., Wierzbicka, A., et al. (2006). Left ventricular hypertrophy and arterial wall thickening in children with essential hypertension. *Pediatric Nephrology (Berlin, Germany)*, 21(6), 811–9. doi:10.1007/s00467-006-0068-8
206. Litwin, M., Trelewicz, J., Wawer, Z., Antoniewicz, J., Wierzbicka, A., Rajszyz, P., & Grenda, R. (2004). Intima-media thickness and arterial elasticity in hypertensive children: controlled study. *Pediatric Nephrology (Berlin, Germany)*, 19(7), 767–74. doi:10.1007/s00467-004-1480-6
207. Lobelo, F., Pate, R.R., Dowda, M., Liese, A.D., & Ruiz, J.R. (2009). Validity of cardiorespiratory fitness criterion-referenced standards for adolescents. *Medicine and Science in Sports and Exercise*, 41(6), 1222–9. doi:10.1249/MSS.0b013e318195d491
208. Lorenz, M. W., Markus, H. S., Bots, M. L., Rosvall, M., & Sitzer, M. (2007). Prediction of Clinical Cardiovascular Events With Carotid Intima-Media Thickness: A Systematic Review and Meta-Analysis. *Circulation*, 115(4), 459–467. doi:10.1161/CIRCULATIONAHA.106.628875

209. Lysterly, G. W., Sui, X., Church, T. S., Lavie, C. J., Hand, G. A., & Blair, S. N. (2008). Maximal exercise electrocardiography responses and coronary heart disease mortality among men with diabetes mellitus. *Circulation*, *117*(21), 2734–2742. doi:CIRCULATIONAHA.107.729277
210. Lysterly, G. W., Sui, X., Church, T. S., Lavie, C. J., Hand, G. A., & Blair, S. N. (2010). Maximal exercise electrocardiographic responses and coronary heart disease mortality among men with metabolic syndrome. *Mayo Clinic Proceedings*, *85*(3), 239–46. doi:10.4065/mcp.2009.0509
211. Mahmud, F. H., Hill, D. J., Cuerden, M. S., & Clarkson, C. L. (2009). Impaired vascular function in obese adolescents with insulin resistance. *The Journal of Pediatrics*, *155*(5), 678–82. doi:10.1016/j.jpeds.2009.04.060
212. Malina, R.M., Tracking of physical activity and physical fitness across the lifespan. *Research Quarterly for Exercise and Sport*, *67*(3 Suppl):S48-57.
213. Marinov, B., Mandadzhieva, S., & Kostianev, S. (2007). Oxygen-uptake efficiency slope in healthy 7- to 18-year-old children. *Pediatric Exercise Science*, *19*(4), 159–170.
214. Marinov, B., & Kostianev, S. (2003). Exercise performance and oxygen uptake efficiency in obese children performing standardized exercise. *Acta physiologica et pharmacologica*, *27*(2-3):59-64.
215. Marlatt, K. L., Steinberger, J., Dengel, D. R., Sinaiko, A., Moran, A., Chow, L. S., et al. (2013). Impact of pubertal development on endothelial function and arterial elasticity. *The Journal of Pediatrics*, *163*(5), 1432–6. doi:10.1016/j.jpeds.2013.07.002
216. Martinez-Gomez, D., Eisenmann, J. C., Healy, G. N., Gomez-Martinez, S., Diaz, L. E., Dunstan, D. W., et al., (2012). Sedentary Behaviors and Emerging Cardiometabolic Biomarkers in Adolescents. *The Journal of Pediatrics*, *160*(1), 104–110.e2. doi:10.1016/j.jpeds.2011.06.037
217. McAuley, P. A., Kokkinos, P. F., Oliveira, R. B., Emerson, B. T., & Myers, J. N. (2010). Obesity Paradox and Cardiorespiratory Fitness in 12,417 Male Veterans Aged 40 to 70 Years. *Mayo Clinic Proceedings*, *85*(2), 115–121. doi:10.4065/mcp.2009.0562
218. McGee, H. (2010). *Changing CardioVascular Health*. Retrieved from http://www.headway.ie/download/pdf/changing_cardiovascular_health.pdf
219. McGill, H. C., McMahan, C. a, Zieske, a W., Tracy, R. E., Malcom, G. T., Herderick, E. E., & Strong, J. P. (2000). Association of Coronary Heart Disease Risk Factors with microscopic qualities of coronary atherosclerosis in youth.

- Circulation*, 102(4), 374–379. doi:10.1161/01.CIR.102.4.374
220. McGill, H. C., McMahan, C. A., Zieske, A. W., Sloop, G. D., Jamie, V., Troxclair, D. A., et al. (2004). Associations of Coronary Heart Disease Risk Factors With the Intermediate Lesion of Atherosclerosis in Youth. *World Wide Web Internet And Web Information Systems*. doi:10.1161/01.ATV.20.8.1998
221. McMurray, R.G., Harrell, J.S., Bangdiwala, S.I., & Hu, J. (2003) Tracking of physical activity and aerobic power from childhood through to adolescence. *Medicine and Science in Sports and Exercise*, 35(11):1914-1922.
222. McNamara, J., Molot, M., JF, S., & Cutting RT. (1971). Coronary Artery Disease in Combat Casualties in Vietnam. *JAMA : The Journal of the American Medical Association*, 216(7) 1185–1187.
223. Melo, X., Santa-Clara, H., Pimenta, N. M., Martins, S. S., Minderico, C. S., Fernhall, B., & Sardinha, L. B. (2014). Intima-Media Thickness in 11-13 Years-Old Children: Variation Attributed to Sedentary Behavior, Physical Activity, Cardiorespiratory Fitness and Waist Circumference. *Journal of Physical Activity & Health*, 12 (5):610–617. doi:10.1123/jpah.2013-0501
224. Metzige, A. M., Schwarzenberg, S. J., Fox, C. K., Deering, M. M., Nathan, B. M., & Kelly, A. S. (2011). Postprandial endothelial function, inflammation, and oxidative stress in obese children and adolescents. *Obesity (Silver Spring)*, 19(6), 1279–83. doi:10.1038/oby.2010.318
225. Meyer, A. a, Kundt, G., Lenschow, U., Schuff-Werner, P., & Kienast, W. (2006b). Improvement of early vascular changes and cardiovascular risk factors in obese children after a six-month exercise program. *Journal of the American College of Cardiology*, 48(9), 1865–70.
226. Meyer, A. A., Kundt, G., Steiner, M., Schuff-Werner, P., & Kienast, W. (2006). Impaired flow-mediated vasodilation, carotid artery intima-media thickening, and elevated endothelial plasma markers in obese children: the impact of cardiovascular risk factors. *Pediatrics*, 117(5), 1560–1567.
227. Mezzani, A., Agostoni, P., Cohen-Solal, A., Corrà, U., Jegier, A., Kouidi, E., et al., (2009). Standards for the use of cardiopulmonary exercise testing for the functional evaluation of cardiac patients: a report from the Exercise Physiology Section of the European Association for Cardiovascular Prevention and Rehabilitation. *European Journal of Cardiovascular Prevention & Rehabilitation*, 16(3), 249–267. doi:10.1097/HJR.0b013e32832914c8
228. Mikines, K. J., Richter, E. A., Dela, F., & Galbo, H. (1985). Seven days of bed rest decrease insulin action on glucose uptake in leg and whole body. *Journal of Applied Physiology*, 70(3), 1245–54.

229. Mitchell, J. A, Mattocks, C., Ness, A. R., Leary, S. D., Pate, R. R., Dowda, M., et al. (2009). Sedentary behavior and obesity in a large cohort of children. *Obesity (Silver Spring, Md.)*, *17*(8), 1596–1602. doi:10.1038/oby.2009.42
230. Mora, S., Cook, N., Buring, J. E., Ridker, P. M., & Lee, I.-M. (2007). Physical activity and reduced risk of cardiovascular events: potential mediating mechanisms. *Circulation*, *116*(19), 2110–8. doi:10.1161/CIRCULATIONAHA.107.729939
231. Morris, J.N., Heady, J.A., Raffle, P.A.B., Roberts, C.G., and Parks, J.W., (1953). Coronary Heart Disease and Physical Activity of Work. *Lancet*, *265*, 1111-1120.
232. Morris, J.N., Heady, J.A., Raffle, P.A.B., Roberts, C.G., and Parks, J.W., (1953). Coronary Heart Disease and Physical Activity of Work. *Lancet*, *265*, 1053-1057.
233. Morrison, K. M., Dyal, L., Conner, W., Helden, E., Newkirk, L., Yusuf, S., & Lonn, E. (2010). Cardiovascular risk factors and non-invasive assessment of subclinical atherosclerosis in youth. *Atherosclerosis*, *208*(2), 501–505. doi:10.1016/j.atherosclerosis.2009.07.034
234. Moyna, N.M., & Thompson, P.D. (2004). The effect of physical activity on endothelial function in man. *Acta Physiologica Scandinavica*, *180*(2), 113–123.
235. Murphy, E. C-S., Carson, L., Neal, W., Baylis, C., Donley, D., Yeater, R. (2009). Effects of an exercise intervention using Dance Dance Revolution on endothelial function and other risk factors in overweight children. *International Journal of Pediatric Obesity*, *4*(4): 205–214.
236. Myers, J., Prakash, M., Froelischer, V., Partington, S., & Atwood, J.E. (2002) EXERCISE CAPACITY AND MORTALITY AMONG MEN REFERRED FOR EXERCISE TESTING. *The New England Journal of Medicine*. *346*(11): 793-801.
237. Must, A., Jacques, P.F., Dallal, G.E., Bajema, C.J., Dietz, W.H. (1992). Long-term morbidity and mortality of overweight adolescents; a follow-up of the Harvard Growth Study 1922 to 1935. *N. Engl. J. Med.* *327*, 1350-1355.
238. Nambi, V., Chambless, L., He, M., Folsom, A. R., Mosley, T., Boerwinkle, E., & Ballantyne, C. M. (2012). Common carotid artery intima-media thickness is as good as carotid intima-media thickness of all carotid artery segments in improving prediction of coronary heart disease risk in the Atherosclerosis Risk in Communities (ARIC) study. *European Heart Journal*, *33*(2), 183–90.
239. Nassis, G. P., Papantakou, K., Skenderi, K., Triandafillopoulou, M., Kavouras, S. A., Yannakoulia, M., et al. (2005). Aerobic exercise training improves insulin sensitivity without changes in body weight, body fat, adiponectin, and inflammatory markers in overweight and obese girls. *Metabolism*, *54*(11), 1472–1479. doi:10.1016/j.metabol.2005.05.013

240. National Institutes of Health. (2005). The Fourth Report on the Diagnosis, Evaluation, and Treatment of High Blood Pressure in Children and Adolescents. *National Institutes of Health, 05-5267*, 1–60. doi:10.1542/peds.114.2.S2.555
241. Naylor, L. H., Green, D. J., Jones, T. W., Kalic, R. J., Suriano, K. L., Shah, M., et al. (2011). Endothelial function and carotid intima-medial thickness in adolescents with Type 2 diabetes mellitus. *Journal of Pediatrics, 159*(6), 971–974. doi:10.1016/j.jpeds.2011.05.019
242. Neunteufl, T., Katzenschlager, R., Hassan, A., Klaar, U., Schwarzacher, S., Glogar, D., Bauer, P., & Weidinger, F. (1997). Systemic endothelial dysfunction is related to the extent and severity of coronary artery disease. *Atherosclerosis, 129*(1), 111–118. doi:10.1016/S0021-9150(96)06018-2
243. Nichols, M., Townsend, N., Scarborough, P., & Rayner, M. (2014). Cardiovascular disease in Europe 2014: epidemiological update. *European Heart Journal, 35*(42), 2950–2959. doi:10.1093/eurheartj/ehu299
244. Nichols Melanie, Nick, T., Peter, S., & Mike, R. (2012). *European Cardiovascular Disease Statistics. European Heart Network and European Society of Cardiology*. doi:978-2-9537898-1-2
245. Nicklas, T. A, Von Duvillard, S. P., & Berenson, G. S. (2002). Tracking of serum lipids and lipoproteins from childhood to dyslipidemia in adults: the Bogalusa Heart Study. *International Journal of Sports Medicine, 23 Suppl 1*, S39–43. doi:10.1055/s-2002-28460
246. Hotamisligil, G.S. (1999). Mechanisms of TNF-alpha-induced insulin resistance. *Experimental and Clinical Endocrinology & Diabettes, 107*(2); 119-25
247. Norman, A.C., Drinkard, B., McDuffie, J.R., Ghorbani, S., Yanoff, L.B., & Yanovski, J.A. (2005). Influence of excess adiposity on exercise fitness and performance in overweight children and adolescents. *Pediatrics, 115*(6):e690-6
248. O’Leary, D.H., Polak, J., Kronmal, R., Manolio, T., Burke, G., Wolfson, S., & For, the C. H. S. C. R. G. (1999). Carotid-Artery Intima and Media Thickness As a Risk Factor for Myocardial Infarction and Stroke in Older Adults. *New England Journal of Medicine, 340*(1), 14–22.
249. Ortega, F. B., Artero, E. G., Ruiz, J. R., Espana-Romero, V., Jimenez-Pavon, D., Vicente-Rodriguez, G., ... Castillo, M. J. (2011). Physical fitness levels among European adolescents: the HELENA study. *British Journal of Sports Medicine, 45*(1), 20–29. doi:10.1136/bjism.2009.062679

250. Caballero, A.E, Bousquet-Santos, K., Robles-Osorio, L., Montagnani, V., Soodini, G., Porramatikul, S., Hamdy, O., Nobrega, A.C., & Horton, E.S. Overweight Latino children and adolescents have marked endothelial dysfunction and subclinical vascular Inflammation in association with excess body fat and insulin resistance. *Diabetes Care*, 31(3):576-82.
251. Owen, N. Healy, G.N., Matthews, C.E., & Dunstan, W. (2010). Too Much Sitting: The Population-Health Science of Sedentary Behavior. *Exercise Sports Science Reviews*, 38(3), 105–113. doi:10.1097/JES.0b013e3181e373a2.
252. Owen, N., Sparling, P. B., Healy, G. N., Dunstan, D. W., & Matthews, C. E. (2010). Sedentary Behavior: Emerging Evidence for a New Health Risk. *Mayo Clinic Proceedings*, 85(12), 1138–1141. doi:10.4065/mcp.2010.0444
253. Paffenbarger, R.S. Jr., Wing A.R., Hyde, R.T., (1978). Physical Activity as an Index of Heart Attack Risk in College Alumni. *American Journal of Epidemiology* 108(3), 161-175.
254. Paffenbarger, R.S. Jr., Hyde, R., Wing, A.L., & Hsieh, C.C. (1986). Physical activity, all-cause mortality and longevity of college alumni. *The New England Journal of Medicine*, 314 (10): 605-613.
255. Pahkala, K., Heinonen, O. J., Lagström, H., Hakala, P., Simell, O., Viikari, J. S. A., (2008). Vascular endothelial function and leisure-time physical activity in adolescents. *Circulation*, 118(23), 2353–9. doi:10.1161/CIRCULATIONAHA.108.791988
256. Pahkala, K., Heinonen, O. J., Simell, O., Viikari, J. S. a, Rönnemaa, T., Niinikoski, H., & Raitakari, O. T. (2011). Association of physical activity with vascular endothelial function and intima-media thickness. *Circulation*, 124(18), 1956–1963. doi:10.1161/CIRCULATIONAHA.111.043851
257. Pahkala, K., Laitinen, T. T., Heinonen, O. J., Viikari, J. S. a, Rönnemaa, T., Niinikoski, H., *et al.*, (2013). Association of fitness with vascular intima-media thickness and elasticity in adolescence. *Pediatrics*, 132(1), e77–84.
258. Parker, B.A., Trehearn, T.L., & Meendering, J.R. (1985) Pick your Poiseuille: normalizing the shear stimulus in studies of flow mediated dilation. *Journal of Applied Physiology*, 107(4): 1357-9
259. Parsons, T.J., Power, C.& Manor, O. (2006). Longitudinal physical activity and diet patterns in the 1958 British Birth Cohort. *Medicine and Science in Sports and Exercise*, 38 (3):547-554.
260. Pate, R., Oria, M., Pillsbury, L., & Measures, F. (2012). *IOM (Institute of Medicine) Fitness Measures and Health Outcomes in Youth*.

261. Pate, R. R., O'Neill, J. R., & Lobelo, F. (2008). The evolving definition of "sedentary". *Exercise and Sport Sciences Reviews*, 36(4), 173–178. doi:10.1097/JES.0b013e3181877d1a
262. Pate, R. R., Trost, S. G., Dowda, M., Ott, A. E., Ward, D. S., Saunders, R., & Felton, G. (1999). Tracking of physical activity, physical inactivity, and health-related physical fitness in rural youth. *Pediatric Exercise Science*, 11(4), 364–376.
263. Pauciuolo, P., Iannuzzi, a, Sartorio, R., Irace, C., Covetti, G., Di Costanzo, a, & Rubba, P. (1994). Increased intima-media thickness of the common carotid artery in hypercholesterolemic children. *Arteriosclerosis and Thrombosis : A Journal of Vascular Biology / American Heart Association*, 14(7), 1075–1079. doi:10.1161/01.ATV.14.7.1075
264. Pedersen, B. K. (2006). The anti-inflammatory effect of exercise: its role in diabetes and cardiovascular disease control. *Essays in Biochemistry*, 42; 105–117. Retrieved from http://www.ncbi.nlm.nih.gov/entrez/query.fcgi?cmd=Retrieve&db=PubMed&dopt=Citation&list_uids=17144883
265. Peel, J. B., Sui, X., Adams, S. A., Ph, D., Hébert, J. R., Hardin, J. W., & Blair, S. N. (2013). A prospective study of cardiorespiratory fitness and breast cancer. *Medicine & Science in Sports & Exercise.*,41(4), 742–748. doi:10.1249/MSS.0b013e31818edac7.A
266. Peña, A. S., Belobrajdic, D. P., Wiltshire, E., Gent, R., Hirte, C., & Couper, J. (2010). Adiponectin relates to smooth muscle function and folate in obese children. *International Journal of Pediatric Obesity : IJPO : An Official Journal of the International Association for the Study of Obesity*, 5(2), 185–91. doi:10.3109/17477160903111748
267. Peña, A. S., Wiltshire, E., MacKenzie, K., Gent, R., Piotto, L., Hirte, C., & Couper, J. (2006). Vascular endothelial and smooth muscle function relates to body mass index and glucose in obese and nonobese children. *The Journal of Clinical Endocrinology and Metabolism*, 91(11), 4467–4471. doi:10.1210/jc.2006-0863
268. Pignoli, P., Tremoli, E., Poli, a, Oreste, P., & Paoletti, R. (1986). Intimal plus medial thickness of the arterial wall: a direct measurement with ultrasound imaging. *Circulation*, 74(6), 1399–1406. doi:10.1161/01.CIR.74.6.1399
269. Poole, D. C., Wilkerson, D. P., & Jones, A. M. (2008). Validity of criteria for establishing maximal O₂ uptake during ramp exercise tests. *European Journal of Applied Physiology*, 102(4), 403–410. doi:10.1007/s00421-007-0596-3
270. Pozza, R. D., Bechtold, S., Bonfig, W., Putzker, S., Kozlik-Feldmann, R., Netz,

- H., et al.(2007). Age of Onset of Type 1 Diabetes in Children and Carotid Intima Medial Thickness. *Journal of Clinical Endocrinology & Metabolism*, 92(6), 2053–2057. doi:10.1210/jc.2006-2868
271. Puder, J. J., Marques-Vidal, P., Schindler, C., Zahner, L., Niederer, I., Burgi, F. et al. (2011). Effect of multidimensional lifestyle intervention on fitness and adiposity in predominantly migrant preschool children (Ballabeina): cluster randomised controlled trial. *The British Medical Journal* 343:d6195–d6195. doi:10.1136/bmj.d6195
272. Raitakari, O. T., Juonala, M., Kähönen, M., Taittonen, L., Laitinen, T., Mäki-Torkko, N., et al. (2003). Cardiovascular risk factors in childhood and carotid artery intima-media thickness in adulthood: the Cardiovascular Risk in Young Finns Study. *JAMA : The Journal of the American Medical Association*, 290(17), 2277–83. doi:10.1001/jama.290.17.2277
273. Rankinen, T., Roth, S. M., Bray, M. S., Loos, R., Russe, L. P., Wolfarth, B., et al. (2010). Advances in Exercise, Fitness, and Performance Genomics. *Medicine & Science in Sports & Exercise*, 42(5), 835–846. doi:10.1249/MSS.0b013e3181d86ce
274. Reed, K., Warburton, D., Lewanczuk, R.Z, Haykowsky, M,J.F., Scott, J.M., Whitney, C.J. (2005) Arterial Compliance in Young Children: The Role of Aerobic Fitness. *European Journal of Cardiovascular Preventive Rehabilitation*, 12(5):492-7.
275. Reed, K. E., Warburton, D. E. R., Macdonald, H. M., Naylor, P. J., & McKay, H. A. (2008). Action Schools! BC: A school-based physical activity intervention designed to decrease cardiovascular disease risk factors in children. *Preventive Medicine*, 46(6), 525–531. doi:10.1016/j.ypmed.2008.02.020
276. Reilly, J. J., Penpraze, V., Hislop, J., Davies, G., Grant, S., & Paton, J. Y. (2008). Objective measurement of physical activity and sedentary behaviour: review with new data. *Archives of Disease in Childhood*, 93(7), 614–619. doi:10.1136/adc.2007.133272
277. Reinehr, T., Kiess, W., de Sousa, G., Stoffel-Wagner, B., & Wunsch, R. (2006). Intima media thickness in childhood obesity: relations to inflammatory marker, glucose metabolism, and blood pressure. *Metabolism*, 55(1), 113–8. doi:10.1016/j.metabol.2005.07.016
278. Ridker, P. M. (2005). C-Reactive Protein, Inflammation, and Cardiovascular Disease: Clinical update. *Current Issues in Cardiology*, 32(3), 384–386.
279. Ridker, P. M., Hennekens, C. H., Buring, J. E., & Rifai, N. (2000). C-reactive protein and other markers of inflammation in the prediction of cardiovascular disease in women. *The New England Journal of Medicine*, 342(12), 836–843.

280. Ried-Larsen, M., Grøntved, a, Froberg, K., Ekelund, U., & Andersen, L. B. (2013). Physical activity intensity and subclinical atherosclerosis in Danish adolescents: the European Youth Heart Study. *Scandinavian Journal of Medicine & Science in Sports*, 23(3), e168–77. doi:10.1111/sms.12046
281. Ried-Larsen, M., Grøntved, A., Møller, N. C., Larsen, K. T., Froberg, K., & Andersen, L. B. (2014). Associations Between Objectively Measured Physical Activity Intensity in Childhood and Measures of Subclinical Cardiovascular Disease in Adolescence: Prospective Observations from the European Youth Heart Study. *British Journal of Sports Medicine*, 48, 1502–1507. doi:10.1136/bjsports-2012-091958
282. Riggio, S., Mandraffino, G., Sardo, M. A., Iudicello, R., Camarda, N., Imbalzano, E. et al. (2010). Pulse wave velocity and augmentation index, but not intima-media thickness, are early indicators of vascular damage in hypercholesterolemic children. *Eur J Clin Invest*, 40(3), 250–7. doi:10.1111/j.1365-2362.2010.02260.x
283. Rizzo, N. S., Ruiz, J. R., Hurtig-Wennlöf, A., Ortega, F. B., & Sjöström, M. (2007). Relationship of Physical Activity, Fitness, and Fatness with Clustered Metabolic Risk in Children and Adolescents: The European Youth Heart Study. *Journal of Pediatrics*, 150(4), 388–394. doi:10.1016/j.jpeds.2006.12.039
284. Roberts, C. K., Chen, A. K., & Barnard, R. J. (2007). Effect of a short-term diet and exercise intervention in youth on atherosclerotic risk factors. *Atherosclerosis*, 191(1), 98–106. doi:10.1016/j.atherosclerosis.2006.09.011
285. Rodriguez, R. R., Gomez-Diaz, R. A., Haj, J. T., Garnica, F. J. A., Soriano, E. R., Meguro, E. N., et al., (2007). Carotid intima-media thickness in pediatric Type 1 diabetic patients. *Diabetes Care*, 30(10), 2599–2602. doi:10.2337/dc07-0922.
286. Ross, R., & Janiszewski, P.M. (2008) Is weight loss the optimal target for obesity related cardiovascular disease risk reduction? *The Canadian Journal of Cardiology*, 24 (Suppl D); 25D-31-D
287. Rowland, T., & Cunningham, L.N. (1992) Oxygen uptake plateau during maximal treadmill exercise in children. *Chest*, 101(2):485-9
288. Ruiz, J. R., Ortega, F. B., Martínez-Gómez, D., Labayen, I., Moreno, L. A, De Bourdeaudhuij, I., et al., (2011). Objectively measured physical activity and sedentary time in European adolescents: the HELENA study. *American Journal of Epidemiology*, 174(2), 173–184. doi:10.1093/aje/kwr068
289. uiz, J. R., Ortega, F. B., Rizzo, N. S., Villa, I., Hurtig-Wennlöf, A., Oja, L., & Sjöström, M. (2007). High cardiovascular fitness is associated with low metabolic risk score in children: the European Youth Heart Study. *Pediatric Research*, 61(3), 350–5. doi:10.1203/pdr.0b013e318030d1bd

290. Ruiz, J. R., Ortega, F. B., Warnberg, J., & Sjöström, M. (2007). Associations of low-grade inflammation with physical activity, fitness and fatness in prepubertal children; the European Youth Heart Study. *International Journal of Obesity (2005)*, 31(10), 1545–1551. doi:10.1038/sj.ijo.0803693
291. Sallis, J. F., & Saelens, B. E. (2000). Assessment of physical activity by self-report: Status, limitations, and future directions. *Research Quarterly for Exercise and Sport*, 71(2), 1–14. doi:10.1080/02701367.2000.11082780
292. Saltin B. In Limiting factors of physical performance. Keul J, editor. Stuttgart, Germany: Thieme Medical Publishers; 1973. pp. 235–252. (Oxygen transport by the circulatory system during exercise in man)
293. Sandoo, A., van Zanten, J. J. C. S. V., Metsios, G. S., Carroll, D., & Kitas, G. D. (2010). The endothelium and its role in regulating vascular tone. *The Open Cardiovascular Medicine Journal*, 4, 302–312. doi:10.2174/1874192401004010302
294. Sandvik, L., Erikssen, J., Thaulow, E., Erikssen, G., Mundal, R., & Rodahl, K. (1993). Physical fitness as a predictor of mortality among healthy, middle-aged Norwegian men. *The New England Journal of Medicine*, 328 (8): 533-537
295. Sass, C., Herbeth, B., Chapet, O., Siest, G., Visvikis, S., Faiez, Z. (1998). Intima-media thickness and diameter of carotid and femoral arteries in children, adolescents and adults from the Stanislas cohort: effect of age, sex, anthropometry and blood pressure. *Journal of Hypertension*.16(11):1593-602
296. Saunders, T. J., Larouche, R., Colley, R.C., & Tremblay, M.S. (2012) Acute Sedentary Behaviour and Markers of Cardiometabolic Risk: A Systematic Review of Intervention Studies. *Journal of Nutrition and Metabolism*, 2012; doi:10.1155/2012/712435
297. Saunders, T. J., Chaput, J.-P., Goldfield, G. S., Colley, R. C., Kenny, G. P., Doucet, E., & Tremblay, M. S. (2013). Prolonged sitting and markers of cardiometabolic disease risk in children and youth: A randomized crossover study. *Metabolism*, 62(10), 1423–1428. doi:10.1016/j.metabol.2013.05.010
298. Sauzeau, V., Le Jeune, H., Cario-Toumaniantz, C., Smolenski, A., Lohmann, S.M., Bertoglio, J., Chardin, P., Paucaud, P., & Loirand, G. (2000). Cyclic GMP-dependent Protein Kinase Signaling Pathway Inhibits RhoA-induced Ca²⁺ Sensitization of Contraction in Vascular Smooth Muscle. *Journal of Biological Chemistry*, 275(28), 21722–21729. doi:10.1074/jbc.M000753200
299. Scheller, J., Chalaris, A., Schmidt-Arras, D., & Rose-John, S. (2011). The pro- and anti-inflammatory properties of the cytokine interleukin-6. *Biochimica et Biophysica Acta (BBA)- Molecular Cell Research*, 1813(5), 878-888

300. Schleef, R. R., Bevilacqua, M. P., Sawdey, M., Gimbrone, M. A., & Loskutoff, D. J. (1988). Cytokine activation of vascular endothelium. Effect on tissue-type plasminogen activator and type-1 plasminogen activator inhibitor. *The Journal of Biological Chemistry*, 263(12), 5797–5803.
301. Sedentary Behaviour Research Networ. (2012). Letter to the Editor: Standardized use of the terms “sedentary” and “sedentary behaviours.” *Applied Physiology, Nutrition, and Metabolism*, 37(3), 540–542. doi:10.1139/h2012-024
302. Seeger, J. P. H., Thijssen, D. H. J., Noordam, K., Cranen, M. E. C., Hopman, M. T. E., & Nijhuis-van der Sanden, M. W. G. (2011). Exercise training improves physical fitness and vascular function in children with type 1 diabetes. *Diabetes, Obesity & Metabolism*, 13(4), 382–4. doi:10.1111/j.1463-1326.2011.01361.x
303. Seider, M. J., Nicholson, W. F., & Booth, F. W. (1982). Insulin resistance for glucose metabolism in disused soleus muscle of mice. *The American Journal of Physiology*, 242(1), E12–8.
304. Shaibi, G. Q., Cruz, M. L., Ball, G. D. C., Weigensberg, M. J., Kobaissi, H. A., Salem, G. J., & Goran, M. L. (2005). Cardiovascular fitness and the metabolic syndrome in overweight Latino youths. *Medicine and Science in Sports and Exercise*, 37(6), 922–928. doi:10.1029/01.mss.0000170472.75214.53
305. Silva, L. R., Cavaglieri, C., Lopes, W. A., Pizzi, J., Coelho-e-Silva, M. J. C., & Leite, N. (2014). Endothelial wall thickness, cardiorespiratory fitness and inflammatory markers in obese and non-obese adolescents. *Brazilian Journal of Physical Therapy*, 18(1), 47–55. doi:10.1590/S1413-35552012005000133
306. Singh, T. P., Groehn, H., & Kazmers, A. (2003). Vascular function and carotid intimal-medial thickness in children with insulin-dependent diabetes mellitus. *Journal of the American College of Cardiology*, 41(4), 661–665. doi:10.1016/S0735-1097(02)02894-2
307. Singhal, A. (2005). Endothelial dysfunction: role in obesity-related disorders and the early origins of CVD. *The Proceedings of the Nutrition Society*, 64(1), 15–22. doi:10.1079/PNS2004404
308. Sorensen, K. E., Celermajer, D. S., Georgakopoulos, D., Hatcher, G., Betteridge, D. J., & Deanfield, J. E. (1994). Impairment of endothelium-dependent dilation is an early event in children with familial hypercholesterolemia and is related to the lipoprotein(a) level. *Journal of Clinical Investigation*, 93(1), 50–55. doi:10.1172/JCI116983
309. Sorić, M., Jembrek Gostović, M., Gostović, M., Hočevar, M., & Mišigoj-Duraković, M. (2014). Tracking of BMI, fatness and cardiorespiratory fitness

- from adolescence to middle adulthood: the Zagreb Growth and Development Longitudinal Study. *Annals of Human Biology*, 41(3), 238–43. doi:10.3109/03014460.2013.851739
310. Spieker, L. E., Sudano, I., Hürlimann, D., Lerch, P. G., Markus, G., Binggeli, C., Corti, R., Ruschitzka, F., & Lüscher, T. F. (2002). High-Density Lipoprotein Restores Endothelial Function in hypercholesterolemic men. *Circulation*, 105(12): 1399–1403. doi:10.1161/01.CIR.0000013424.28206.8F
311. Stabouli, S., Kotsis, V., Karagianna, C., Zakopoulos, N., Konstantopoulos, A. (2012). Blood Pressure and Carotid Artery Intima-Media Thickness in Children and Adolescents: The Role of Obesity. *Hellenic Journal of Cardiology*, 53(1), 41–47
312. Stary, H.C. (1989). Evolution and progression of atherosclerotic lesions in coronary arteries in children and young adults. *Arteriosclerosis*; 9 (Suppl I):119-32
313. Steele, R. M., Van Sluijs, E. M. F., Cassidy, A., Griffin, S. J., & Ekelund, U. (2009). Targeting sedentary time or moderate- and vigorous-intensity activity: Independent relations with adiposity in a population-based sample of 10-y-old British children. *American Journal of Clinical Nutrition*, 90(5), 1185–1192. doi:10.3945/ajcn.2009.28153
314. Stein, J. H., Fraizer, M. C., Aeschlimann, S. E., Nelson-Worel, J., McBride, P. E., & Douglas, P. S. (2004). Vascular age: integrating carotid intima-media thickness measurements with global coronary risk assessment. *Clinical Cardiology*, 27(7), 388–392. doi:10.1002/clc.4960270704
315. Steinberger, J., Moran, A, Hong, C. P., Jacobs, D. R., & Sinaiko, A, R. (2001). Adiposity in childhood predicts obesity and insulin resistance in young adulthood. *The Journal of Pediatrics*, 138(4), 469–73. doi:10.1067/mpd.2001.112658
316. Stephens, B. R., Granados, K., Zderic, T. W., Hamilton, M. T., & Braun, B. (2011). Effects of 1 day of inactivity on insulin action in healthy men and women: interaction with energy intake. *Metabolism*, 60(7), 941–949.
317. Stevens, J., Evenson, K. R., Thomas, O., Cai, J., & Thomas, R. (2004). Associations of fitness and fatness with mortality in Russian and American men in the lipids research clinics study. *International Journal of Obesity*, 28(11), 1463–1470. doi:10.1038/sj.ijo.0802770
318. Sui, X., LaMonte, M. J., Laditka, J. N., Hardin, J. W., Chase, N., Hooker, S. P., & Blair, S. N. (2007). Cardiorespiratory fitness and adiposity as mortality predictors in older adults. *JAMA: The Journal of the American Medical Association*, 298(21), 2507–2516.

319. Sun, C., Magnussen, C. G., Ponsonby, A. L., Schmidt, M. D., Carlin, J. B., Huynh, Q., et al.(2014). The contribution of childhood cardiorespiratory fitness and adiposity to inflammation in young adults. *Obesity (Silver Spring)*, 22(12), 2598–2605. doi:10.1002/oby.20871
320. Suwaidi, J. A, Hamasaki, S., Higano, S. T., Nishimura, R. A, Holmes, D. R., & Lerman, A. (2000). Long-term follow-up of patients with mild coronary artery disease and endothelial dysfunction. *Circulation*, 101(9), 948–954. doi:10.1161/01.CIR.101.9.948
321. Takase, B., Uehata, A., Takashi, A., Tomoo, N., Toshihiko, N., Akira, H., Kimio, S., Fumitaka, O., & Kurita, A. (1998). Endothelium-Dependent Flow-Mediated Vasodilation in Coronary and Brachial arteries in Suspected Coronary Artery Disease. *The American Journal of Cardiology*, 82(12):1535-1539
322. Tanaka, K., Masuda, J., Imamura, T., Sueishi, K., Nakashima, T., Sakurai, I., Shozawa, T., et al., (1988). A nation-wide study of atherosclerosis in infants, children and young adults in Japan. *Atherosclerosis*, 72(2-3):\$43-56
323. Tanner, J. .M. (1962). Growth at adolescence; with a general consideration of the effects of hereditary and environmental factors upon growth and maturation from birth to maturity. (2nd ed.). Oxford: Blackwell Scientific Publications
324. Taylor, H., Henschel, A, & Buskirk, E. (1955). Maximal Oxygen Make us an Objective Cur&u-Respird tory Pefurmancel. *Journal of Applied Physiology*, 8:73–80.
325. Taylor, R. W., Jones, I. E., Williams, S. M., & Goulding A. (2000). Evaluation of waist circumference, waist-to-hip ratio, and the conicity index as screening tools for high trunk fat mass, as measuread by dual-energy X-ray absorptiometry, in children aged 3-19y. *American Society for Clinical Nutrition*, 72(2), 490-495.
326. Telema, R., Yang, X., Viikari, J., Valimaki, I., Wanne, O., Raitakari, O. (2005). Physical activity from childhood to adulthood: a 21-year tracking study. *American Journal of Preventive Medicine*, 28(3):267-73.
327. The Cooper Institute for Aerobic Research. FITNESSGRAM Test Administration Manual. 3rd ed. Champaign (IL); Human Kinetics; 2004, pp, 38-9.
328. Thosar, S. S., Johnson, B. D., Johnston, J. D., & Wallace, J. P. (2012). Sitting and endothelial dysfunction: the role of shear stress. *Medical Science Monitor : International Medical Journal of Experimental and Clinical Research*, 18(12), RA173–80.

329. Thosar, S.S., Sylvanna, L.B., Mather, K.J., Johnston, J.D., & Wallace, J.P. (2015) Effect of Prolonged Sitting and Breaks in Sitting Time on Endothelial Function. *Medicine and Science in Sports and Exercise*, 47 (4):843-9
330. Tjønnå, A.E., Lee, S. J., Rognmo, O., Stølen, T. O., Bye, a, Haram, P. M., et al. (2008). Aerobic interval training versus continuous moderate exercise as a treatment for the metabolic syndrome: a pilot study. *Circulation*, 118 (4), 346–354. doi:CIRCULATIONAHA.108.772822
331. Tjønnå, A. E., Stølen, T. O., Bye, A., Volden, M., Slørdahl, S. a, Odegård, R., et al.,(2009). Aerobic interval training reduces cardiovascular risk factors more than a multitreatment approach in overweight adolescents. *Clinical Science (London, England : 1979)*, 116(4), 317–26. doi:10.1042/CS20080249
332. Tonstad, S., Joakimsen, O., Stensland-Bugge, E., Leren, T.P., Ose, L., Russell, D., Bønna, K.H. (1996). Risk factors related to carotid intima-media thickness and plaque in children with familial hypercholesterolemia in control subjects. *Arteriosclerosis, Thrombosis, and Vascular Biology*, 16(8), 984-991.
333. Tounian, P., Aggoun, Y., Dubern, B., Varille, V., Guy-Grand, B., Sidi, D.,Girardet, J.P., & Bonnet, D. 2001). Presence of increased stiffness of the common carotid artery and endothelial dysfunction in severely obese children: a prospective study. *Lancet*, 358(9291), 1400–1404. doi:10.1016/S0140-6736(01)06525-4
334. Trang, N. H. H. D., Hong, T. K., van der Ploeg, H. P., Hardy, L. L., Kelly, P. J., & Dibley, M. J. (2013). Longitudinal sedentary behavior changes in adolescents in Ho Chi Minh City. *American Journal of Preventive Medicine*, 44(3), 223–30. doi:10.1016/j.amepre.2012.10.021
335. Treiber, F., Papavassiliou, D., Gutin, B., Malpass, D., Yi, W., Islam, S., Davis, H., & Strong, W. (1997). Determinants of endothelium-dependent femoral artery vasodilation in youth. *Psychosomatic Medicine*, 59(4):376-81
336. Tremblay, M. S., Colley, R. C., Saunders, T. J., Healy, G. N., & Owen, N. (2010). Physiological and health implications of a sedentary lifestyle. *Applied Physiology, Nutrition, and Metabolism*, 35(6), 725–740. doi:10.1139/H10-079
337. Tremblay, M. S., LeBlanc, A. G., Kho, M. E., Saunders, T. J., Larouche, R., Colley, R. C., et al., (2011). Systematic review of sedentary behaviour and health indicators in school-aged children and youth. *International Journal of Behavioral Nutrition and Physical Activity*, 8(1), 98. doi:10.1186/1479-5868-8-98
338. Tremblay, M.S. (2012). Letter to the Editor: Standardized use of the terms sedentary and sedentary behaviours. Sedentary Behaviour Research Network.

339. Tremblay, M.S., Esliger, D.W., Tremblay, A., Colley, R. (2007). Incidental movement, lifestyle-embedded activity and sleep: new frontiers in physical activity assessment. *Canadian Journal of Public Health*. 98 (Suppl 2): S208-217
340. Trost, S. G. (2007). Measurement of Physical Activity in Children and Adolescents. *American Journal of Lifestyle Medicine*, 1(4), 299–314. doi:10.1177/1559827607301686.
341. Trost, S. G., McIver, K. L., & Pate, R. R. (2005). Conducting accelerometer-based activity assessments in field-based research. *Medicine and Science in Sports and Exercise*. 37, (Suppl 1) S531-43.
342. Trudeau, F., Laurencelle, L., & Shephard, R.J. (2004). Tracking of physical activity from childhood to adulthood. *Medicine and Science in Sports and Exercise*, 36(11):1937-43
343. Tryggestad, J. B., Thompson, D. M., Copeland, K. C., & Short, K. R. (2012). Obese Children Have Higher Arterial Elasticity Without a Difference in Endothelial Function: The Role of Body Composition. *Obesity*, 20(1), 165–171.
344. Tuzcu, E. M., Kapadia, S. R., Tutar, E., Ziada, K. M., Hobbs, R. E., Patrick, M., et al. (2001). High Prevalence of Coronary Atherosclerosis in Asymptomatic Teenagers and Young Adults: Evidence From Intravascular Ultrasound. *Circulation*, 103 (22), 2705–2710. doi:10.1161/01.CIR.103.22.2705
345. Twisk, J. W., Kemper, H. C., van Mechelen, W., & Post, G. B. (1997). Tracking of risk factors for coronary heart disease over a 14-year period: a comparison between lifestyle and biologic risk factors with data from the Amsterdam Growth and Health Study. *American Journal of Epidemiology*, 145(10), 888–98. doi:10.1093/oxfordjournals.aje.a009048
346. Twisk, J. W. R., Kemper, H. C. G., & van Mechelen, W. (2002). The relationship between physical fitness and physical activity during adolescence and cardiovascular disease risk factors at adult age. The Amsterdam Growth and Health Longitudinal Study. *International Journal of Sports Medicine*, 23 Suppl 1, S8–14. doi:10.1055/s-2002-28455
347. Twisk, J. W. R., Twisk, J. W. R., Kemper, H. C. G., Kemper, H. C. G., van Mechelen, W., & van Mechelen, W. (2000). Tracking of activity and fitness and the relationship with cardiovascular disease risk factors. *Medicine and Science in Sports and Exercise*, 32(8), 1455–61. doi:10.1097/00005768-200008000-00014
348. Urbina, E. M., Kimball, T. R., McCoy, C. E., Khoury, P. R., Daniels, S. R., & Dolan, L. M. (2009). Youth With Obesity and Obesity-Related Type 2 Diabetes Mellitus Demonstrate Abnormalities in Carotid Structure and Function. *Circulation*, 119(22), 2913–2919. doi:10.1161/CIRCULATIONAHA.108.830380

349. Urbina, E. M., Williams, R. V., Alpert, B. S., Collins, R. T., Daniels, S. R., Hayman, L., et al. (2009). Noninvasive assessment of subclinical atherosclerosis in children and adolescents: recommendations for standard assessment for clinical research: a scientific statement from the American Heart Association. *Hypertension*, *54*(5), 919–50. doi:10.1161/HYPERTENSIONAHA.109.192639
350. Vaddi, K., Nicolini, F. A., Mehta, P., & Mehta, J. L. (1994). Increased secretion of tumor necrosis factor-alpha and interferon-gamma by mononuclear leukocytes in patients with ischemic heart disease. Relevance in superoxide anion generation. *Circulation*, *90*(2), 694–9. doi:10.1161/01.CIR.90.2.694
351. Virkola, K., Pesonen, E., Akerblom, H. K., & Siimes, M. A. (1997). Cholesterol and carotid artery wall in children and adolescents with familial hypercholesterolaemia: a controlled study by ultrasound. *Acta Paediatrica (Oslo, Norway: 1992)*, *86*(11), 1203–7. Retrieved from <http://www.ncbi.nlm.nih.gov/pubmed/9401514>
352. Visser, M., Bouter, L. M., McQuillan, G. M., Wener, M. H., & Harris, T. B. (2001). Low-grade systemic inflammation in overweight children. *Pediatrics*, *107*(1), E13. doi:10.1542/peds.107.1.e13
353. Vita, J. A. (2011). Endothelial Function. *Circulation*, *124*(25), e906–e912. doi:10.1161/CIRCULATIONAHA.111.078824
354. Vlahos, A. P., Naka, K. K., Bechlioulis, A., Theoharis, P., Vakalis, K., Moutzouri, E., et al., (2014). Endothelial dysfunction, but not structural atherosclerosis, is evident early in children with heterozygous familial hypercholesterolemia. *Pediatric Cardiology*, *35*(1), 63–70. doi:10.1007/s00246-013-0742-0
355. Wallace, T. M., Levy, J. C., & Matthews, D. R. (2004). Use and abuse of HOMA modeling. *Diabetes Care*, *27*(6), 1487–95. doi:10.2337/diacare.27.6.1487
356. Wassmann, S., Stumpf, M., Strehlow, K., Schmid, A., Schieffer, B., Bohm, M., & Nickenig, G. (2004). Interleukin-6 Induces Oxidative Stress and Endothelial Dysfunction by Overexpression of the Angiotensin II Type 1 Receptor. *Circulation Research*, *94*(4), 534. doi:10.1161/01.RES.0000115557.25127.8D
357. Watts, K., Beye, P., Siafarikas, A., Davis, E. a, Jones, T. W., O'Driscoll, G., & Green, D. J. (2004). Exercise training normalizes vascular dysfunction and improves central adiposity in obese adolescents. *Journal of the American College of Cardiology*, *43*(10), 1823–7. doi:10.1016/j.jacc.2004.01.032
358. Watts, Katie, Beye Petra, Siafarika Aris, O Driscoll Gerard, Jones, T. D. J. G. (2005). Effects of exercise training on vascular function in obese children. *The Journal of Pediatrics*, *146*(2), 296–7. doi:10.1016/j.jpeds.2004.08.078

359. Webb, R. C. (2003). Smooth muscle contraction and relaxation. *Advances in Physiology Education*, 27(4), 201–206. doi:10.1152/advan.00025.2003
360. Wiegman, A., de Groot, E., Hutten, B. a, Rodenburg, J., Gort, J., Bakker, H. D., et al. (2004). Arterial intima-media thickness in children heterozygous for familial hypercholesterolaemia. *Lancet*, 363(9406), 369–70. doi:10.1016/S0140-6736(04)15467-6
361. Wiltshire, E. J., Gent, R., Hirte, C., Pena, A., Thomas, D. W., & Couper, J. J. (2002). Endothelial dysfunction relates to folate status in children and adolescents with type 1 diabetes. *Diabetes*, 51(7), 2282–2286. doi:10.2337/diabetes.51.7.2282
362. Woo, K. S., Chook, P., Yu, C. W., Sung, R. Y. T., Qiao, M., Leung, S. S., Lam, C.W., Metreweli, C., & Celermajer, D.S. (2004). Effects of Diet and Exercise on Obesity-Related Vascular Dysfunction in Children. *Circulation*, 109(16), 1981–1986. doi:10.1161/01.CIR.0000126599.47470.BE
363. Woo, K. S., Chook, P., Yu, C. W., Sung, R. Y. T., Qiao, M., Leung, S. S., Lam, C.W., Metreweli, C., & Celermajer, D.S. (2004). Overweight in children is associated with arterial endothelial dysfunction and intima-media thickening. *International Journal of Obesity and Related Metabolic Disorders : Journal of the International Association for the Study of Obesity*, 28(7), 852–857. doi:10.1038/sj.ijo.0802539
364. Woods, C. B., Tannehill, D., Quinlan, A., Moyna, N., & Walsh, J. (2010). The Children’s Sport Participation and Physical Activity Study (CSPPA). Research Report No 1. *School of Health and Human Performance, Dublin City University and The Irish Sports Council, Dublin, Ireland.*
365. World Health Organisation. (2015). Cardiovascular Diseases; Fact sheets. Retrieved from <http://www.who.int/mediacentre/factsheets/fs317/en/>
366. Yilmazer, M. M., Tavli, V., Carti, Ö. U., Mese, T., Güven, B., Aydın, B., et al. (2010). Cardiovascular risk factors and noninvasive assessment of arterial structure and function in obese Turkish children. *European Journal of Pediatrics*, 169(10), 1241–1248. doi:10.1007/s00431-010-1216-5
367. Yousuf, O., Mohanty, B.D., Martin, S.S., Joshi, P.H., Blaha, M.J., Nasir, K., Blumenthal. R.S., & Budoff, M.J. (2013) . High-Sensitivity C-Reactive Protein and Cardiovascular Disease; A Resolute Belief or an Elusive Link? *Journal of the American College of Cardiology*, 62(5), 397-408
368. Zeiher, A, M., Drexler, H., Wollschläger, H., & Just, H. (1991). Modulation of coronary vasomotor tone in humans. Progressive endothelial dysfunction with different early stages of coronary atherosclerosis. *Circulation*, 83(2), 391–401. doi:10.1161/01.CIR.83.2.391

369. Zhang, H., Park, Y., Wu, J., Chen, X., Lee, S., Yang, J., et al. (2009). Role of TNF-alpha in vascular dysfunction. *Clinical Science (Lond)*, *116*, 219–230. doi:CS20080196 [pii]\r10.1042/CS20080196
370. Zhu, W., Huang, X., He, J., Li, M., & Neubauer, H. (2005). Arterial intima-media thickening and endothelial dysfunction in obese Chinese children. *European Journal of Pediatrics*, *164*(6), 337–44.

APPENDICES

Appendix A

Dublin City University



RESEARCH ETHICS COMMITTEE

APPLICATION FOR APPROVAL OF A PROJECT INVOLVING HUMAN PARTICIPANTS

Application No. (*office use only*) DCUREC/2011/

Period of Approval (*office use only*)/...../..... to
...../...../.....

This application form is to be used by researchers seeking ethics approval for individual projects and 120 studies. The **signed original and an electronic copy** of your completed application must be submitted to the DCU Research Ethics Committee.

Note: If your research requires approval from the Biosafety Committee, this approval should be in place prior to REC submission. Please attach the approval from the BSC to this submission.

NB - The hard copy must be signed by the PI. The electronic copy should consist of one file only, which incorporates all supplementary documentation. The completed application must be proofread and spellchecked before submission to the REC. All sections of the application form should be completed. Applications which do not adhere to these requirements will not be accepted for review and will be returned directly to the applicant.

Applications must be completed on the form; answers in the form of attachments will not be accepted, except where indicated. No handwritten applications will be accepted. **Research must not commence until written approval has been received from the Research Ethics Committee.**

PROJECT TITLE

Comparison of cardiovascular disease risk factors and vascular health in low fit moderately fit and high fit Irish teenagers.

PRINCIPAL INVESTIGATOR(S)

Prof. Niall M. Moyna

Please confirm that **all** supplementary information is included in your application (in both signed original and electronic copy). If questionnaire or interview questions are submitted in draft form, a copy of the final documentation must be submitted for final approval when available.

	INCLUDED	NOT APPLICABLE
Bibliography	<input checked="" type="checkbox"/>	<input type="checkbox"/>
Recruitment advertisement	<input type="checkbox"/>	<input checked="" type="checkbox"/>
Plain language statement/Information Statement	<input checked="" type="checkbox"/>	<input type="checkbox"/>
Informed Consent form	<input checked="" type="checkbox"/>	<input checked="" type="checkbox"/>
Evidence of external approvals related to the research	<input type="checkbox"/>	<input checked="" type="checkbox"/>
Questionnaire	<input type="checkbox"/>	<input checked="" type="checkbox"/>
Interview Schedule	<input type="checkbox"/>	<input checked="" type="checkbox"/>
Debriefing material	<input type="checkbox"/>	<input checked="" type="checkbox"/>
Other	<input type="checkbox"/>	<input checked="" type="checkbox"/>

Please note:

1. Any amendments to the original approved proposal must receive prior REC approval.
2. As a condition of approval investigators are required to document and report immediately to the Secretary of the Research Ethics Committee any adverse events, any issues which might negatively impact on the conduct of the research and/or any complaint from a participant relating to their participation in the study

1. ADMINISTRATIVE DETAILS

THIS PROJECT IS: Research Project Funded Consultancy
(tick as many as apply) Practical Class Clinical Trial
 Student Research Project Other - *Please Describe:*

(please give details) ResearchMasters Taught Masters PhD Undergraduate**Project Start Date: Oct 1, 2011****Project End date: May 31, 2014****1.1 INVESTIGATOR CONTACT DETAILS****PRINCIPAL INVESTIGATOR(S):**

TITLE	SURNAME	FIRST NAME	PHONE	FAX	EMAIL
Prof	Moyna	Niall	01 7008802	01 7008888	niall.moyna@dcu.ie

OTHER INVESTIGATORS:

TITLE	SURNAME	FIRST NAME	PHONE	FAX	EMAIL
Dr.	Mc Caffrey (MD)	Noel	087 2797597	01 7008888	noel.mccaffrey@dcu.ie
Ms.	Sheridan	Sinead	086 3584725	01 7008888	sinead.sheridan9@mail.dcu.ie

FACULTY/DEPARTMENT/SCHOOL/CENTRE: School of Health and Human Performance**1.2 WILL THE RESEARCH BE UNDERTAKEN ON-SITE AT DUBLIN CITY UNIVERSITY**

YES NO The laboratory research will be undertaken in the Vascular Health Research Unit in Dublin City University. Cardiovascular fitness will be estimated by having transition year students (15-17 years) undertake a multi-stage shuttle test in their own school.

1.3 IS THIS PROTOCOL BEING SUBMITTED TO ANOTHER ETHICS COMMITTEE, OR HAS IT BEEN PREVIOUSLY SUBMITTED TO AN ETHICS COMMITTEE?)

YES NO

DECLARATION BY INVESTIGATORS

The information contained herein is, to the best of my knowledge and belief, accurate. I have read the University's current research ethics guidelines, and accept responsibility for the conduct of the procedures set out in the attached application in accordance with the guidelines, the University's policy on Conflict of Interest and any other condition laid down by the Dublin City University Research Ethics Committee or its Sub-Committees. I have attempted to identify all risks related to the research that may arise in conducting this research and acknowledge my obligations and the rights of the participants.

If there any affiliation or financial interest for researcher(s) in this research or its outcomes or any other circumstances which might represent a perceived, potential or actual conflict of interest this should be declared in accordance with Dublin City University policy on Conflicts of Interest.

I and my co-investigators or supporting staff have the appropriate qualifications, experience and facilities to conduct the research set out in the attached application and to deal with any emergencies and contingencies related to the research that may arise.

Signature(s):

Principal investigator(s): *Niall Moyna* 8 July 2011

Print name(s) in block letters: *Niall Moyna* 8 July 2011

2. PROJECT OUTLINE

2.2 LAY DESCRIPTION

Despite a substantial decline in cardiovascular disease (CVD) death rates over the past two decades, CVD remains the leading cause of mortality in Ireland. Moreover, recent data suggests that an increase in sedentary behaviours and concomitant decrease in physical activity and cardiorespiratory fitness are leading to an increase in some CVD risk factors such as diabetes mellitus, obesity, and metabolic syndrome in children. The purpose of this study is to compare cardiovascular disease risk factors and sub-clinical atherosclerosis in low fit, moderately fit and high fit transition year students. Students will undertake a multi-stage shuttle run (MSST) test to estimate their cardiorespiratory fitness level. Based on the results of the MSST the students will be classified as low fit, moderately fit or high fit. A random sample of low fit, moderately fit and high fit boys (n=90) and girls (n=90) will be selected to wear an accelerometer for 7 days to record their physical activity levels, and will make a single visit to the Vascular Health Research Unit in DCU. During this visit, participants will undertake a treadmill exercise test to determine their aerobic fitness level (VO₂max) and have their body composition assessed. A small volume of blood will be taken to measure a variety of biomarkers in the blood (glucose, total cholesterol, HDL-C, LDL-C, insulin and hs-CRP) that are used to predict CVD risk. Evidence of CVD will be determined by using ultrasound to measure the thickness of the wall of the carotid artery in the neck, and the ability of the brachial artery in the arm to dilate (widen) after the blood flow is blocked for 5 minutes. The study will provide health care professionals with information on the importance of physical activity in the primary prevention of CVD and other lifestyle mediated chronic disease in children.

2.2 AIMS OF AND JUSTIFICATION FOR THE RESEARCH

Cardiovascular disease refers to coronary heart disease, stroke and blood vessel disease, and is the leading cause of death in Ireland. Atherosclerosis is the primary underlying cause of most CVD. Although clinical heart disease occurs in middle-age and in older individuals, evidence of atherosclerotic disease and organ changes related to high blood pressure, and adult type II diabetes are now evident in childhood. Results from autopsy studies of young individuals, indicate that the duration of risk factor burden is a major factor governing the development of atherosclerosis (2, 3, 4). Cardiovascular disease risk factor levels for an individual tend to persist or track over time in a given rank within the distribution of the population. Long term exposure to multiple CVD risk factors and lifestyle behaviours such as a high fat-high calorie diet, tobacco use and physical inactivity confers a lifelong burden of CVD risk resulting in the development of early systemic atherosclerosis.

Although a profile of CVD risk factors is useful in predicting cardiovascular events, measurement of sub-clinical atherosclerosis by non-invasive imaging techniques such as echo-doppler studies of the carotid arteries or brachial artery reactivity provides a powerful approach to determine the extensiveness and severity of asymptomatic disease and potential future risk. A recent analysis of 4380 members of 4 longitudinal cohort studies, found that risk factor measurements (high [highest quintile] total cholesterol, triglycerides, blood pressure, and body mass index)

obtained at or after 9 years of age are predictive of sub-clinical atherosclerosis in adulthood.

Recent evidence indicates that an alarming 81% of boys and girls attending Irish primary school and 88% of post primary pupils do not meet the current Department of Health and Children's physical recommendations. Furthermore, the study found that physically active children have a better health profile (based on cardiorespiratory fitness, BMI, blood pressure and waist/hip ratio) than those who are inactive. The effect of low levels of physical activity on cardiorespiratory fitness, CVD risk factors and sub-clinical atherosclerosis in Irish children is unknown. The aim of this study is to compare CVD risk factors and sub-clinical atherosclerosis in low fit, moderately fit and high fit adolescents. It is hypothesized that there will be an inverse relation between physical activity levels, cardiorespiratory fitness levels and serum levels of glucose, total cholesterol, LDL-C, insulin, hs-CRP and subclinical cardiovascular disease.

2.3 PROPOSED METHOD

Study Overview

The study will use a cross-sectional research design. Transition year students who agree to participate will undertake a multi-stage shuttle test (MSST) during school hours. Based on the results of the MSST the students will be classified as low fit, moderately fit or high fit. A random sample of low fit, moderately fit and high fit boys and girls will be selected to wear an accelerometer for 7 days to record their physical activity levels, and will make a single visit to the Vascular Health Research Unit in DCU. During this visit, a blood sample will be drawn, body composition will be assessed, and carotid intima media thickness (CIMT), endothelial function and aerobic fitness ($VO_2\max$) will be measured.

Initial Contact with Schools

A letter (Appendix 1) providing a brief summary of the research project will be sent to secondary school principals in the greater Dublin region. Participants recruited for the study will be required to wear an accelerometer for 7 days prior to their visit to the Vascular Health Unit in DCU.

SCHOOL VISIT 1: Approximately 30 minutes in duration. Sinead Sheridan (PhD student) will visit the schools that agree to participate to outline the purpose of the study and provide a brief summary of what is involved to all transition year students. Students will be provided with an informed consent to be signed by a parent/guardian, an assent form to be signed by themselves, and a Physical Activity Readiness Questionnaire (Appendix 3).

SCHOOL VISIT 2: Approximately 60 minutes in duration. Subjects will undertake a multi-stage shuttle test (MSST) during school hours.

Multistage Shuttle Run Test: Subjects will run back and forth between two lines exactly 20 m apart, keeping in time with a series of audio signals (beeps). The initial speed will be 8.0 km/hr and will increase by $0.14\text{ m}\cdot\text{s}^{-1}$ every minute. The test will be terminated if a subject stops voluntarily, or is unable to maintain the set pace. The total number of shuttle runs completed will be used to classify participants into the low, moderate and high fitness categories. Fitness classification will be based on

data collected during a multistage fitness test on 2120 boys and 1964 girls as part of the Take Part Study. A total of 90 boys (30 low fit, 30 moderately fit, and 30 high fit) and 90 girls (30 low fit, 30 moderately fit, and 30 high fit) aged 15-17 years will be randomly selected to wear an accelerometer and visit DCU.

Measurement of Physical Activity: Subjects will wear a uni-axial activPAL accelerometer for 7 days prior to their visit to the Vascular Health Unit in Dublin City University. Accelerometry count thresholding will be employed to quantify the amount of time spent in daily physical activity.

VISIT TO THE VASCULAR HEALTH UNIT DCU: Approximately 3 hours in duration. Subjects will arrive at the Vascular Health Unit following an overnight fast. A blood sample (9 ml) will be drawn and body composition and pubertal status will be assessed. Carotid intima media thickness (CIMT) and endothelial function will be measured using ultrasonography. Finally, aerobic fitness (VO₂max) will be measured.

Pubertal status: Pubertal status will be assessed by asking the subjects to self-report their current status, compared to standard graphical representations of pubertal Tanner stages.

Cardiorespiratory fitness: A ramp treadmill protocol with open circuit spirometry will be used to measure VO₂max. During this assessment subjects will be fitted with a mouthpiece or facemask.

Body composition: Height, weight, waist and hip circumferences will also be measured using standard procedures. Skinfold callipers will be used to measure double thickness subcutaneous adipose tissue on the right side of the body.

Blood sampling and assays: Blood samples will be obtained using standard venipuncture. An individual trained in phlebotomy will draw the blood samples. The total amount of blood taken will be approximately 9 ml. Serum concentrations of blood lipids will be determined on an automated clinical chemistry analyser using spectrophotometric (lipids). Serum concentrations of hs-CRP and insulin will be determined by immunoassay. Plasma glucose will be measured using a standard spectrophotometric assay.

Carotid Intima- Media Thickness (CIMT): Thickness of the carotid intima-media will be assessed using a 12.0 MHz linear-array transducer (SonoSite, MicroMaxx). Recordings will be obtained with the subject resting in a supine position, with the head turned slightly to the contralateral side. The common coronary artery, including the carotid bulb, will be visualized, and 2 longitudinal B-mode images of the left and the right common carotid arteries at end diastole will be recorded and electronically stored. Measurements of CIMT will be conducted in the 10-mm linear segment proximal to the carotid bulb at 2 plaque-free sides twice in the near wall and twice in the far wall on both sides and combined as mean CIMT. The combination of the readings from the near and far walls yields the strongest association with cardiovascular disease. The artery will be scanned longitudinally without colour flow to assess the grey scale image and with colour flow to identify difficult anatomy and delineate irregularities in plaque.

Endothelial Function: Endothelial dependent dilation will be determined in response to reactive hyperaemia following 5 min of lower arm occlusion. A blood pressure

cuff will be placed on the left arm for blood pressure monitoring and another on the right lower arm for occlusion. ECG leads will be attached to monitor heart rate. Subjects will rest for 10 min in a supine position. Blood pressure will be determined during the final 2 minutes of the rest period. Baseline blood flow and brachial artery diameter (SonoSite, MicroMaxx) will be recorded. The right arm blood pressure cuff will then be inflated to approximately 220-230 mmHg and maintained at that pressure for 5 minutes. The cuff will then be rapidly deflated after 5 min of occlusion. Doppler blood flow measurement will be obtained during the first minute following cuff deflation. Brachial artery diameter will be assessed at one and three minutes post occlusion. Subjects will then rest for 15 minutes to eliminate endothelium dependent effects on brachial artery diameter. After this period, endothelial independent dilation will be assessed. Baseline blood flow and brachial artery diameter will be recorded and used as a baseline prior to sublingual nitroglycerine administration. Glyceryl trinitrate (0.4mg) will be placed under the subjects tongue. Doppler blood flow measurement will be obtained three minutes following the sublingual nitroglycerin administration and brachial artery diameter measurements will be assessed 3 and 5 minutes post glyceryl trinitrate administration.

Data Analysis: Data will be analysed using SPSS (v17.0, SPSS Inc., IL). A mixed model (gender x fitness level) ANOVA will be used to compare mean differences. Pearson's product-moment correlation coefficients were used to determine the relation between selected parameters. A probability of $p \leq 0.05$ was accepted for statistical significance.

2.4 PARTICIPANT PROFILE

A total of 90 boys (30 low fit, 30 moderately fit, and 30 high fit) and 90 girls (30 low fit, 30 moderately fit, and 30 high fit) aged 15-17 years in transition year will be recruited from the participatory schools in the greater Dublin region.

Inclusion criteria:

- Transition year student
- Aged 15-17 years
- Clinically stable and in good health
- Girls will be scheduled to visit DCU during the first 7 days of the follicular phase of their menstrual cycle.

Exclusion criteria:

Potential subjects will be excluded if:

- They have not informed consent
- Current smoker
- Clinical conditions that may preclude them from exercise
- Taking oral contraceptive pill
- Systolic blood pressure >180 mmHg and/or diastolic blood pressure > 100 mmHg

The family physician and parents of study participants with high blood pressure or other adverse indicators will be contacted by Dr. Noel McCaffrey.

2.5 MEANS BY WHICH PARTICIPANTS ARE TO BE RECRUITED

A letter providing a brief summary of the research project will be sent to post-primary school principals in the greater Dublin region. Sinead Sheridan (PhD student) will visit the schools that agree to participate. The purpose of the study will be outlined and a brief summary of what is involved will be explained to all transition year students. The students will be provided with an informed consent to be signed by a parent/guardian. In addition, they will sign an assent form and complete a Physical Activity Readiness Questionnaire (Appendex 1). Perspective participants will be told that only a small number of them will be randomly selected to wear an accelerometer and visit DCU.

2.6 PLEASE EXPLAIN WHEN, HOW, WHERE, AND TO WHOM RESULTS WILL BE DISSEMINATED, INCLUDING WHETHER PARTICIPANTS WILL BE PROVIDED WITH ANY INFORMATION AS TO THE FINDINGS OR OUTCOMES OF THE PROJECT?

The results obtained will form the basis for a postgraduate thesis and will be presented at scientific meeting and published in scientific journals. The identity of the individual participants will remain anonymous. Information, as a group, will only be presented. Participants will be provided with a report which will detail their results from participating in the study.

2.7 OTHER APPROVALS REQUIRED *Has permission to gain access to another location, organisation etc. been obtained? Copies of letters of approval to be provided when available.*

YES NO NOT APPLICABLE

Permission will be obtained from school principals (Appendix 1)

2.8 HAS A SIMILAR PROPOSAL BEEN PREVIOUSLY APPROVED BY THE REC

YES NO

(If YES, please state both the REC Application Number and Project Title)

3. RISK AND RISK MANAGEMENT

3.1 ARE THE RISKS TO SUBJECTS AND/OR RESEARCHERS ASSOCIATED WITH YOUR PROJECT GREATER THAN THOSE ENCOUNTERED IN EVERYDAY LIFE?

YES NO *If YES, this proposal will be subject to full REC review*

If NO, this proposal may be processed by expedited administrative review

3.2 DOES THE RESEARCH INVOLVE

	YES	NO
• use of a questionnaire? (attach copy)?	<input checked="" type="checkbox"/>	<input type="checkbox"/>
• interviews (attach interview questions)?	<input type="checkbox"/>	<input checked="" type="checkbox"/>
• observation of participants without their knowledge?	<input type="checkbox"/>	<input checked="" type="checkbox"/>
• participant observation (provide details in section 2)?	<input type="checkbox"/>	<input checked="" type="checkbox"/>
• audio- or video-taping interviewees or events?	<input type="checkbox"/>	<input checked="" type="checkbox"/>
• access to personal and/or confidential data (including student, patient or client data) without the participant's specific consent?	<input type="checkbox"/>	<input checked="" type="checkbox"/>
• administration of any stimuli, tasks, investigations or procedures which may be experienced by participants as physically or mentally painful, stressful or unpleasant during or after the research process?	<input checked="" type="checkbox"/>	<input type="checkbox"/>
• performance of any acts which might diminish the self-esteem of participants or cause them to experience embarrassment, regret or depression?	<input type="checkbox"/>	<input checked="" type="checkbox"/>
• investigation of participants involved in illegal activities?	<input type="checkbox"/>	<input checked="" type="checkbox"/>
• procedures that involve deception of participants?	<input type="checkbox"/>	<input checked="" type="checkbox"/>
• administration of any substance or agent?	<input checked="" type="checkbox"/>	<input type="checkbox"/>
• use of non-treatment of placebo control conditions?	<input type="checkbox"/>	<input checked="" type="checkbox"/>
• collection of body tissues or fluid samples?	<input checked="" type="checkbox"/>	<input type="checkbox"/>

- collection and/or testing of DNA samples?
- participation in a clinical trial?
- administration of ionising radiation to participants?

3.3 POTENTIAL RISKS TO PARTICIPANTS AND RISK MANAGEMENT PROCEDURES (*see Guidelines*)

1. Exercise testing is associated with a very small risk of abnormal heart rhythm, heart attack or death. Subjects heart activity will be continuously monitored using a 12 lead ECG and a physician will be present during exercise testing.
2. Drawing blood is associated with slight pain and discomfort and can cause bruising where the needle is inserted. An individual trained in phlebotomy will draw the blood samples. A safe volume of approximately 9 ml of blood will be drawn.
3. Restriction of blood flow for a period of 5 minutes is necessary to assess endothelial dependent and independent dilation. This procedure may induce slight discomfort in the subject's arm which will dissipate following the deflation of the blood pressure cuff. The glyceryl trinitrate administered may cause a headache that may last for 5-10 minutes

Alternatives to the risks: Endothelial dependent and independent dilation can only be determined by brachial artery reactivity and the administration of nitroglycerin. Blood samples are required to assess the subject's cardiovascular biomarkers.

3.4 ARE THERE LIKELY TO BE ANY BENEFITS (DIRECT OR INDIRECT) TO PARTICIPANTS FROM THIS RESEARCH?

YES NO

Participants will receive a copy of their results, detailing information on their vascular health, body composition and fitness levels.

3.5 ARE THERE ANY SPECIFIC RISKS TO RESEARCHERS? (*e.g. risk of infection or where research is undertaken at an off-campus location*)

YES NO

Risk is associated with working with blood and handling needles. The research team has been immunized for hepatitis B. Standard operating procedures for the handling of biological products exist within the School of Health and Human Performance.

3.6 ADVERSE/UNEXPECTED OUTCOMES

The School of Health and Human Performance has established an emergency protocol for adverse events. In the unlikely event of a major adverse outcome, an ambulance will be called and the participant will be sent immediately to Beaumont Hospital. Any minor adverse outcomes will be dealt with by the study physician who will then refer the participant, if required, to the VHI- swift care clinic in Swords for further attention.

3.7 MONITORING

The research team will have meetings on a weekly basis to update on all aspects of the study. All researchers involved in the study will be familiar with testing procedures and the safety statement prior to commencing data collection. A number of practice sessions will be undertaken by all the research team to ensure proficiency and reliability in performing the data collection procedures.

3.8 SUPPORT FOR PARTICIPANTS

This study does not require additional support for participants

3.9 DO YOU PROPOSE TO OFFER PAYMENTS OR INCENTIVES TO PARTICIPANTS?

YES NO (If YES, please provide further details.)

4. INVESTIGATORS' QUALIFICATIONS, EXPERIENCE AND SKILLS

The PI (Niall Moyna) has extensive experience with measuring flow mediated dilation. He initially learned the procedure in the Division of Cardiology at the University of Pittsburgh Centre, Pittsburgh, PA, USA and later established an endothelial function assessment laboratory in the Division of Nuclear Cardiology at Hartford Hospital, Connecticut, USA. During the past 5 years, Prof Moyna and Dr. Cleona Gray, the Senior Vascular Technologist in the Vascular Lab at the Mater Hospital have trained a number of DCU graduate students in the measurement of carotid intima media thickness and flow mediated dilation.

Dr. Noel McCaffrey is a physician with extensive experience in exercise related research.

Sinead Sheridan recently completed the BSc Physical Education and Biology at Dublin City University. She finished first in her class with a 1.1 honors degree. Sinead is familiar with many of the procedures involved in fitness testing and she is currently learning the ultrasound procedure involved in measuring carotid intima media thickness and flow mediated dilation.

5. CONFIDENTIALITY/ANONYMITY

5.1 WILL THE IDENTITY OF THE PARTICIPANTS BE PROTECTED?

YES NO (If NO, please explain)

IF YOU ANSWERED YES TO 5.1, PLEASE ANSWER THE FOLLOWING QUESTIONS:

5.2 HOW WILL THE ANONYMITY OF THE PARTICIPANTS BE RESPECTED?

Participant confidentiality is an important issue during data collection. Participant's identity and other personal information will not be revealed, published or used in other studies. Participants will be assigned an ID number under which all personal information will be stored in a secure locked cabinet in the Vascular Health Research Unit in the School of Health and Human Performance in DCU and saved in a

password- protected in a computer in DCU. The principal investigator and named collaborators listed on this ethics application will be able to access the data.

5.3 LEGAL LIMITATIONS TO DATA CONFIDENTIALITY: *(Have you included appropriate information in the plain language statement and consent form? See Guidelines)*

YES NO

(If NO, please advise how participants will be advised.)

6 DATA/SAMPLE STORAGE, SECURITY AND DISPOSAL

6.1 HOW WILL THE DATA/SAMPLES BE STORED? *(REC recommends that all data be stored on campus)*

Stored at DCU

Stored at another site *(Please explain where and for what purpose)*

6.2 WHO WILL HAVE ACCESS TO DATA/SAMPLES?

Access by named researchers only

Access by people other than named researcher(s) *(Please explain who and for what purpose)*

Other *(Please explain)*

6.3 IF DATA/SAMPLES ARE TO BE DISPOSED OF, PLEASE EXPLAIN HOW, WHEN AND BY WHOM THIS WILL BE DONE?

The data will be stored in a secure locked cabinet in the Vascular Health Research Unit in the School of Health and Human Performance in DCU and saved in a password- protected in a computer in DCU. Data will be kept for a **maximum** of 5 years following from the date of the publication of the research. The principal investigator will be responsible for the security of the data. Only the other investigators listed on this ethics application form will have access to the data. The data will be shredded by the principal investigator after 5 years.

7. FUNDING

7.1 HOW IS THIS WORK BEING FUNDED?

Grant has been submitted to the Office of the Minister for Children and Youth Affairs - Research Scholarship Programme

7.2 PROJECT GRANT NUMBER (If relevant and/or known)

7.3 DOES THE PROJECT REQUIRE APPROVAL BEFORE CONSIDERATION FOR FUNDING BY A GRANTING BODY?

YES NO

7.4 HOW WILL PARTICIPANTS BE INFORMED OF THE SOURCE OF THE FUNDING?

Informed consent

7.5 DO ANY OF THE RESEARCHERS, SUPERVISORS OR FUNDERS OF THIS PROJECT HAVE A PERSONAL, FINANCIAL OR COMMERCIAL INTEREST IN ITS OUTCOME THAT MIGHT COMPROMISE THE INDEPENDENCE AND INTEGRITY OF THE RESEARCH, OR BIAS THE CONDUCT OR RESULTS OF THE RESEARCH, OR UNDULY DELAY OR OTHERWISE AFFECT THEIR PUBLICATION?

YES NO

(If Yes, please specify how this conflict of interest will be addressed.)

8. PLAIN LANGUAGE STATEMENT

DUBLIN CITY UNIVERSITY

Plain Language Statement

Project Title:	Comparison of Cardiovascular Disease Risk Factors and Vascular Health in Low fit, Moderately Fit and High Fit Irish Teenagers
Principal investigator	Professor Niall M. Moyna (Tel: 01-7008802; Fax 01-7008888) Centre for Preventive Medicine School of Health and Human Performance
Email:	niall.moyna@dcu.ie

I. Introduction to the Research Study

Disease of the blood vessels that supply the heart and brain called cardiovascular disease (CVD) is the leading cause of death in Ireland. Although the clinical events associated with CVD such as chest pain, heart attack and stroke normally occur when people get older there is now strong evidence that the disease process starts during childhood. Children who regularly eat a high fat-high diet, who smoke or who don't get enough exercise have a high risk of getting heart disease early in life. Researchers can now use simple and painless procedures to measure the health of blood vessels and the risk for developing CVD. The aim of this study is to compare the health of blood vessels in low fit, moderately fit and high fit adolescent boys and girls. In addition, we will check to see how many CVD risk factors that low fit, moderately fit and high fit adolescent boys have.

II. Involvement in the Research Study will require

If you agree to allow your child to take part in the study, he/she will undertake a shuttle run test during school hours to assess their fitness level. After your child had completed the shuttle run test he or she may be selected by chance to wear a small device called an accelerometer on their hip to record how much physical activity they get every day for 7 days. They will also make a single visit to DCU to undergo additional tests. During the visit to DCU, i) a blood sample will be drawn, ii) their height, weight, and the amount of muscle and fat will be measured, iii) a picture will be taken of a blood vessel in their neck, iv) the health of a blood vessel in the arm will be assessed and v) they will undergo a fitness level on a treadmill. Your child will be asked to fast for at least 12 hours and will not be allowed to exercise for at least 24 hours before the visit to DCU.

- Researchers from Dublin City University will visit the school that your child is attending to administer the shuttle run test. This test involves running back and forth between two lines exactly 20 metres apart while keeping in time with a series of audio signals.
- Two tablespoons of blood will be taken to measure a variety of biomarkers in the blood that are used to predict the risk of CVD. These include glucose and cholesterol. Special skin calipers will be used to measure amount of muscle and fat. The blood samples and skin caliper measurements will be taken in a private room. A female researcher will measure height and weight and take the skinfold measurements in girls.

- A special machine called an ultrasound will take a picture of a blood vessel in your child's neck. (figure A). The health of a blood vessel in your child's arm will be also measured using the ultrasound machine and involves two steps. The first step will involve blocking the blood flow to your child's lower arm for 5 minutes by inflating a blood pressure cuff, and then taking a picture when the blood pressure cuff is released. The second step involves spraying a medicine called glyceryl trinitrate under your child's tongue in order to widen the artery and then taking a picture 3 minutes later (figure B).



Figure A



Figure B

- Your child's fitness will be assessed by having him/her walk/run on a treadmill while wearing a special headgear that is attached to a mouthpiece.

III. Potential risks from involvement in the Research Study

- Your child may experience some muscle soreness in his/her legs or nausea following exercise.
- People who exercise have a very small risk of getting injured and having heart problems. The chance of any of these happening in healthy young adolescent boys and girls is very low.
- Drawing blood may cause a slight pain where the needle is inserted and can leave a bruise. A person trained to take blood will be used to decrease these risks. The amount of blood drawn is not harmful.
- Stopping the flow of blood for a period of 5 minutes may induce slight discomfort in your child's arm which will go away when the blood pressure cuff is deflated.
- Glyceryl trinitrate, is a type of medicine called a nitrate that works by being converted in the body to a chemical called nitric oxide. This chemical (nitric oxide) is also made naturally by the body and has the effect of making the veins and arteries relax and widen (dilate). This makes it easier for the heart to pump blood around the body. There is a very small chance that your child may get a headache that may last 5-10 minutes after glyceryl trinitrate is sprayed under his/her tongue.

IV. Benefits from involvement in the Research Study

Your child will receive a report summarizing the results of his/her tests undertaken during the study. No other benefits have been promised.

V. Arrangements to protect confidentiality of data

Your child's identity and other personal information will not be revealed, published or used in further studies. Your child will be assigned an ID number under which all personal information will be stored and saved in a password protected file in a computer at DCU. The person in charge of the study (Prof. Niall Moyna), and the other researchers listed on this ethics application will have access to the data. You need to be aware that

confidentiality of information provided can only be protected within the limitations of the law. It is possible for data to be subject to subpoena, freedom of information claim or mandated reporting by some professions.

VI. Advice as to whether or not data is to be destroyed after a minimum period

The original documentation will be stored for a maximum of 5 years. Thereafter the documentation will be shredded.

VII. Involvement in the Research Study is voluntary

Involvement in this study is completely voluntary. Your child may withdraw from the Research Study at any point. There will be no penalty for withdrawing before all stages of the Research Study have been completed.

If participants have concerns about this study and wish to contact an independent person, please contact: The Secretary, Dublin City University Research Ethics Committee, c/o Office of the Vice-President for Research, Dublin City University, Dublin 9. Tel 01-7008000

9. INFORMED CONSENT FORM

DUBLIN CITY UNIVERSITY

Informed Consent Form

I. Research Study Title

Comparison of Cardiovascular Disease Risk Factors and Vascular Health in Low fit, Moderately Fit and High Fit Irish Teenagers

Principle Investigator

Prof. Niall M. Moyna, Centre for Preventive Medicine, School of Health and Human Performance

II. Purpose of the research

To compare cardiovascular disease risk factors and sub-clinical atherosclerosis in low fit, moderately fit and high fit adolescents.

III. Confirmation of particular requirements as highlighted in the Plain Language Statement

Participant – please complete the following (Circle Yes or No for each question)

I have read the Plain Language Statement (or had it read to me) Yes

No

I understand the information provided Yes

No

I have had an opportunity to ask questions and discuss this study Yes

No

I have received satisfactory answers to all my questions Yes

No

IV. Confirmation that involvement in the Research Study is voluntary

Your child may withdraw from the Research Study at any point.

V. Advice as to arrangements to be made to protect confidentiality of data, including that confidentiality of information provided is subject to legal limitations

Your child's and other personal information will not be revealed, published or used in further studies. Your child will be assigned an ID number under which all personal information will be stored in a secure locked cabinet and saved in a password protected file in a computer at DCU. The named investigators will have access to the data. Data will be shredded after 5 years by Prof. Moyna.

Confidentiality is insured, but you must be aware that confidentiality of information provided can only be protected within the limitations of the law. It is possible for data to be subject to subpoena, freedom of information claim or mandated reporting by some professions.

VI. Any other relevant information

If your child is in a dependent relationship with any of the researchers their involvement in the project will not affect ongoing assessment/grades/management or treatment of health at DCU.

VII. Signature:

I have read and understood the information in this form. My questions and concerns have been answered by the researchers, and I have a copy of this consent form. Therefore, I consent to allow my child take part in this research project

Participants Signature: _____

Name in Block Capitals: _____

Witness: _____

Date: _____

ASSENT FORM FOR CHILDREN

Study Title: Comparison of Cardiovascular Disease Risk Factors and Vascular Health in Low fit, Moderately Fit and High Fit Irish Teenagers

1. My physical education teacher has talked to me about being part of a research study.
2. I have been told that researchers from Dublin City University (DCU) will visit my school and measure my fitness using a bleep test
3. I have been told that I may be selected at random to visit the Vascular Research Unit at DCU to undergo additional tests. I will also wear a small device called an accelerometer on my hip for 7 days to record my physical activity levels
4. The visit to DCU will take place in the morning and will last for about 3 hours.
5. I will not eat any food from 10 pm the previous evening. I will be allowed to drink water.
6. I will not do any exercise that makes me tired the day before the bleep test in school or the tests in DCU.
7. I will have about 2 tablespoons of blood taken from a vein in my arm. Drawing blood may cause a slight pain where the needle is inserted and may leave a bruise on my arm that will clear up in a few days
8. A special ultrasound machine will take a picture of an artery in my neck. This will take about 15 minutes.
9. The health of a blood vessel in my arm will also be measured using the ultrasound machine. The first step will involve blocking the blood flow in my arm for 5 minutes using a blood pressure cuff and then taking a picture of my blood vessel when the cuff is released. The second step involves spraying a chemical under my tongue and taking a picture 3 minutes later. This test will take about 45 minutes,
10. Stopping the flow of blood in my arm for 5 minutes may feel a little uncomfortable. The chemical that is sprayed under my tongue may cause a headache that may last for 5-10 minutes
11. I will run on treadmill to see how fit I am. During the test I will wear a nose clip on my nose and a mouthpiece in my mouth.
12. I will be allowed to stop any of the tests whenever I want.
13. I may feel tired or be out of breath when I am running on the treadmill and my legs may feel tired
14. If I wish, I can stop doing the tests at any time.
15. If I wish, I may choose not to take part in any of the tests.
16. I know that the people in DCU, my physical education teacher and my parents/guardian will not be upset with me if I decide not to take part in this study, or if I wish to stop taking part in the study.

SIGNED: _____
(Participant's name)

DATE: _____

SIGNED: _____
(Witness name)

DATE: _____

Appendix 1

Dear Principal:

I am a member of the Vascular Health Research Centre, in the School of Health and Human Performance at DCU. We are planning to undertake a study that will evaluate both risk factors for cardiovascular disease (CVD) and subclinical CVD in transition year students.

Despite a substantial decline in CVD death rates over the past two decades, CVD remains the leading cause of mortality in Irish men and women. Results from autopsy studies of young individuals, mostly from accidental deaths or during military warfare indicate that the duration of risk factor burden is a major factor governing the development of CVD. There is accumulating evidence that cardiovascular disease risk factor levels for an individual tend to persist or track over time in a given rank within the distribution of the population. Long term exposure to multiple CVD risk factors and lifestyle behaviours such as a high fat-high calorie diet, tobacco use and physical inactivity confers a lifelong burden of CVD risk resulting in the development of early systemic CVD.

The Children's Sport Participation and Physical Activity study (CSPPA) is a recently published multi-centre study (I am a co-author) that examined physical activity levels in Irish children from 53 primary schools (n=1275) and 70 post primary schools (n=4122, 1st to 6th year, 12-18 yr; 52% female). Results from the study indicate that an alarming 81% of primary and 88% of post primary pupils do not meet the Department of Health and Children's physical activity recommendations. Furthermore, physically active children have a better health profile (based on cardiorespiratory fitness, BMI, blood pressure and waist/hip ratio) than those who are inactive. The use of a non-invasive technique such as ultrasound to measure the thickness of the wall of the carotid artery in the neck, and the ability of the brachial artery in the arm to dilate following 5 minutes of occlusion are now commonly used to determine the severity of asymptomatic CVD and potential future risk. The proposed study will evaluate physical activity levels, cardiovascular fitness, risk factors for cardiovascular disease, and subclinical CVD in low fit, moderately fit and high fit 15-17 year old Irish boys and girls.

We are seeking your permission to contact the physical education teacher(s)

If you would like more information please feel free to contact my office number - 01-7008802.

My email address: niall.moyna@dcu.ie

Kindest regards,

Niall M. Moyna, PhD., FACSM

Appendix 2

Ethical justification for blood sampling associated with human studies conducted within DCU.

Completion instructions:

This document is intended to prompt responses to a number of standard questions which generally need to be answered to justify the sampling of blood associated with human studies.

The document is not meant to be an exhaustive exploration of the justification for such sampling and in specific situations. Additional information may be required/ requested.

Answers are expected to be brief but should also be informative. See a sample completed form at the end.

Queries should be directed to the Secretary of the Research Ethics Committee in the OVPR office.

1) **Briefly explain why blood sampling is required**

To measure biomarkers that are used to predict the risk for cardiovascular disease.

2) **Outline the analyses, components or general applications to be investigated in subject blood (now and any future studies)**

Serum total cholesterol, TG, LDL-C and HDL-C, and hs-CRP will be determined using enzymatic assays (Liquicolor, Human, Germany/Randox direct, Randox, Northern Ireland) and measured spectrophotometrically (MODULAR, Hitachi, Japan). Glucose will be analysed using an automated YSI 2300 STAT PLUS analyser. Serum insulin was

3) **Are any alternatives available to substitute the venous sampling of blood? yes/no.**

No

4) **Will sampling require cannulation or direct vein puncture?**

Direct vein puncture

5) **Outline the minimum volume of original subject blood (i.e. not serum or plasma) required to measure the required components.**

9.0 ml

6) **Are steps being taken in the protocol to minimise the volume of blood samples being taken? Yes**

Yes. We have taken the minimum volume of blood that will allow us to measure the selected biomarkers

7) **Are steps included to minimise the number of blood samples/vein puncture being taken? No**

Yes. We are only taking 9 ml of blood (2 teaspoons) during a single venipuncture

8) **Anticipated sampling methodology**

Volume of blood to be taken per sample	9.0ml
----------------------------------------	-------

Maximum number of samples to be taken per "sitting"	1
Maximum number of samples taken per day	1
Maximum number of samples to be taken over the course of the full study (if long duration study indicate the amount taken in an active 1 month period)	1
Maximum anticipate number of vein puncture episodes	1
Total volume of blood that will be taken from subject.	9.0 ml

9) I certify that:-

- all persons sampling blood in this study are certified to do so through the school/unit where this work is being conducted
- that all those manipulating the resultant samples are fully trained in the safe practice of handling blood
- all persons handling this blood have received appropriate information according to current vaccination policy.

Signature of Study PI

Niall Moyna

Date: 10 June 2011

An original signed copy must accompany electronic submissions. Alternatively, a PDF or other scanned version with a signature may be submitted

Appendix B

Physical Activity Readiness
Questionnaire – PAR-Q
(revised 2002)

PAR-Q & YOU

(A Questionnaire for People Aged 15 to 69)

Regular physical activity is fun and healthy, and increasingly more people are starting to become more active every day. Being more active is very safe for most people. However, some people should check with their doctor before they start becoming much more physically active.

If you are planning to become much more physically active than you are now, start by answering the seven questions in the box below. If you are between the ages of 15 and 69, the PAR-Q will tell you if you should check with your doctor before you start. If you are over 69 years of age, and you are not used to being very active, check with your doctor.

Common sense is your best guide when you answer these questions. Please read the questions carefully and answer each one honestly: check YES or NO.

YES	NO	
<input type="checkbox"/>	<input type="checkbox"/>	1. Has your doctor ever said that you have a heart condition and that you should only do physical activity recommended by a doctor?
<input type="checkbox"/>	<input type="checkbox"/>	2. Do you feel pain in your chest when you do physical activity?
<input type="checkbox"/>	<input type="checkbox"/>	3. In the past month, have you had chest pain when you were not doing physical activity?
<input type="checkbox"/>	<input type="checkbox"/>	4. Do you lose your balance because of dizziness or do you ever lose consciousness?
<input type="checkbox"/>	<input type="checkbox"/>	5. Do you have a bone or joint problem (for example, back, knee or hip) that could be made worse by a change in your physical activity?
<input type="checkbox"/>	<input type="checkbox"/>	6. Is your doctor currently prescribing drugs (for example, water pills) for your blood pressure or heart condition?
<input type="checkbox"/>	<input type="checkbox"/>	7. Do you know of any other reason why you should not do physical activity?

If
you
answered

YES to one or more questions

Talk with your doctor by phone or in person BEFORE you start becoming much more physically active or BEFORE you have a fitness appraisal. Tell your doctor about the PAR-Q and which questions you answered YES.

- You may be able to do any activity you want — as long as you start slowly and build up gradually. Or you may need to restrict your activities to those which are safe for you. Talk with your doctor about the kinds of activities you wish to participate in and follow his/her advice.
- Find out which community programs are safe and helpful for you.

NO to all questions

If you answered NO honestly to all PAR-Q questions, you can be reasonably sure that you can:

- start becoming much more physically active — begin slowly and build up gradually. This is the safest and easiest way to go.
- take part in a fitness appraisal — this is an excellent way to determine your basic fitness so that you can plan the best way for you to live actively. It is also highly recommended that you have your blood pressure evaluated. If your reading is over 144/94, talk with your doctor before you start becoming much more physically active.

DELAY BECOMING MUCH MORE ACTIVE:

- if you are not feeling well because of a temporary illness such as a cold or a fever — wait until you feel better; or
- if you are or may be pregnant — talk to your doctor before you start becoming more active.

PLEASE NOTE: If your health changes so that you then answer YES to any of the above questions, tell your fitness or health professional. Ask whether you should change your physical activity plan.

Informed Use of the PAR-Q: The Canadian Society for Exercise Physiology, Health Canada, and their agents assume no liability for persons who undertake physical activity, and if in doubt after completing this questionnaire, consult your doctor prior to physical activity.

No changes permitted. You are encouraged to photocopy the PAR-Q but only if you use the entire form.

NOTE: If the PAR-Q is being given to a person before he or she participates in a physical activity program or a fitness appraisal, this section may be used for legal or administrative purposes.

"I have read, understood and completed this questionnaire. Any questions I had were answered to my full satisfaction."

NAME _____

SIGNATURE _____

DATE _____

SIGNATURE OF PARENT
or GUARDIAN (for participants under the age of majority) _____

WITNESS _____

Note: This physical activity clearance is valid for a maximum of 12 months from the date it is completed and becomes invalid if your condition changes so that you would answer YES to any of the seven questions.





© Canadian Society for Exercise Physiology www.csep.ca/forms



Appendix C

Pubertal self-assessment (male)
Indicate which stage is closest to yours:



PUBIC HAIR



1 - No pubic hair

2  3 

4  5 

GENITALS

1  2 

3  4 

5 

First indicate the stage corresponding to pubic hair growth and then the stage corresponding to genitals.

Figure 2 - Pictures used for self-assessment of boys²

Appendix D

$\dot{V}O_2$ max Protocol (LF)

Stage	Time	Speed	Slope
Warm Up	2:00	6.0	0.0
1	1:00	7.0	0.0
2	1:00	8.0	1.0
3	1:00	8.0	2.0
4	1:00	8.0	3.0
5	1:00	8.0	4.0
6	1:00	8.0	5.0
7	1:00	8.0	6.0
8	1:00	8.0	7.0
9	1:00	8.0	8.0
10	1:00	8.0	9.0
11	99:00	8.0	9.0
Recovery	5:00	5.0	0.0

$\dot{V}O_2$ max Protocol (MF)

Stage	Time	Speed	Slope
Warm Up	2:00	7.0	0.0
1	1:00	8.0	0.0
2	1:00	10.0	1.0
3	1:00	10.0	2.0
4	1:00	10.0	3.0
5	1:00	10.0	4.0
6	1:00	10.0	5.0
7	1:00	10.0	6.0
8	1:00	10.0	7.0
9	1:00	10.0	8.0
10	1:00	10.0	9.0
11	99:00	10.0	10.0
Recovery	5:00	5.5	0.0

$\dot{V}O_2$ max Protocol (HF)

Stage	Time	Speed	Slope
Warm Up	2:00	9.0	0.0
1	1:00	11.0	0.0
2	1:00	12.0/13.0	1.0
3	1:00	12.0/13.0	2.0
4	1:00	12.0/13.0	3.0
5	1:00	12.0/13.0	4.0
6	1:00	12.0/13.0	5.0
7	1:00	12.0/13.0	6.0
8	1:00	12.0/13.0	7.0
9	1:00	12.0/13.0	8.0
10	1:00	12.0/13.0	9.0
11	99:00	12.0/13.0	9.0
Recovery	5:00	6.0	0.0

Appendix E

Data of graded maximal exercise test of individual participant used to calculate OUES

Test	VO2(ml/kg/min)	VO2 (l/min)	VO2(ml/min)	VE	LOG VE	VO2(ml/min)
0:01:40	39.60	2.81	2813.00	56.80	1.75	2813.00
0:02:00	39.50	2.81	2811.00	55.20	1.74	2811.00
0:02:20	48.00	3.41	3410.00	66.10	1.82	3410.00
0:02:40	41.80	2.97	2973.00	57.50	1.76	2973.00
0:03:00	44.60	3.18	3175.00	63.70	1.80	3175.00
0:03:20	45.60	3.24	3239.00	66.10	1.82	3239.00
0:03:40	46.90	3.33	3332.00	70.40	1.85	3332.00
0:04:00	46.20	3.29	3285.00	69.40	1.84	3285.00
0:04:20	49.40	3.51	3512.00	72.50	1.86	3512.00
0:04:40	50.90	3.62	3618.00	74.80	1.87	3618.00
0:05:00	47.30	3.36	3362.00	71.70	1.86	3362.00
0:05:20	50.00	3.56	3555.00	73.30	1.87	3555.00
0:05:40	53.00	3.77	3769.00	79.50	1.90	3769.00
0:06:00	55.10	3.92	3921.00	92.70	1.97	3921.00
0:06:20	54.40	3.87	3868.00	94.80	1.98	3868.00
0:06:40	56.80	4.04	4036.00	94.70	1.98	4036.00
0:07:00	55.00	3.91	3912.00	92.50	1.97	3912.00
0:07:20	58.30	4.15	4147.00	100.40	2.00	4147.00
0:07:40	57.40	4.08	4082.00	103.70	2.02	4082.00
0:08:00	58.80	4.18	4180.00	106.60	2.03	4180.00
0:08:20	60.50	4.30	4302.00	107.50	2.03	4302.00
0:08:40	59.80	4.25	4250.00	108.10	2.03	4250.00
0:09:00	62.00	4.41	4407.00	116.30	2.07	4407.00

0:09:20	64.80	4.61	4608.00	128.90	2.11	4608.00
0:09:40	64.10	4.56	4561.00	128.80	2.11	4561.00
0:10:00	64.60	4.59	4593.00	118.20	2.07	4593.00

