

2006

Introduction to shadowgraph and schlieren imaging

Andrew Davidhazy

Follow this and additional works at: <http://scholarworks.rit.edu/article>

Recommended Citation

Davidhazy, Andrew, "Introduction to shadowgraph and schlieren imaging" (2006). Accessed from <http://scholarworks.rit.edu/article/478>

This Technical Report is brought to you for free and open access by RIT Scholar Works. It has been accepted for inclusion in Articles by an authorized administrator of RIT Scholar Works. For more information, please contact ritscholarworks@rit.edu.

INTRODUCTION TO SHADOWGRAPH AND SCHLIEREN IMAGING

Andrew Davidhazy
Rochester Institute of Technology
Imaging and Photographic Technology

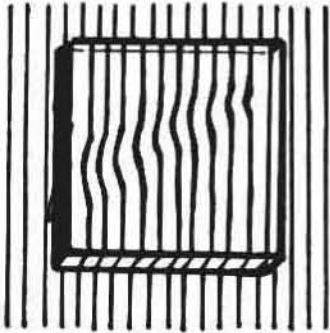

Schlieren photography is not new. It's a technique peripherally developed by early astronomers and glass makers. It is a word that has its origin in the German word "schliere" or streaks, caused by inhomogeneous areas in glass. A variety of methods were used to detect these schliere, with some of them probably closely related to the techniques which we are about to examine.

- SHADOWGRAPHS
- SCHLIEREN
- INTERFEROGRAMS

There are three basic types of optical probing systems each with intrinsic merits and limitations. These are shadowgraphs, schlieren images, and interferograms. These are listed in order of increasing complexity and possible variations.

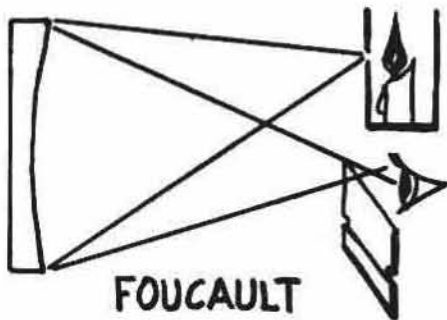

In the mid 1800's, Leon Foucault developed a test that bears his name for examining the figure or curvature of astronomical mirrors. Workers testing mirrors with the Foucault test were well aware of, and took great pains to minimize, the disturbing effects of density gradients present between the light source, the mirror and the "knife edge".

- TOEPLER
- MACH
- SCHARDIN

Some of the pioneers in terms of development of applications were such people as Toepler, Mach, Schardin, and others.

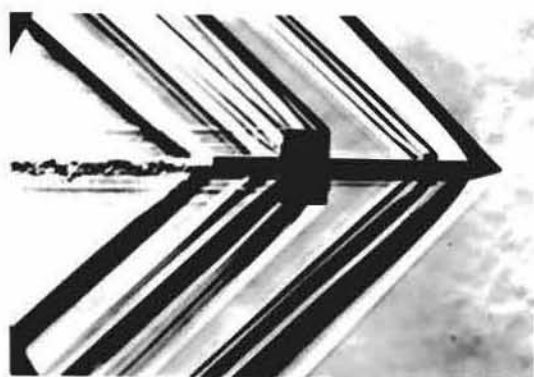

Speaking in broad generalities, most applications of shadowgraphs and schlieren techniques have mainly been developed in the field of ballistics and aerodynamics, although many applications have been developed to study fluid mechanics and thermal exchange processes.

REFRACTION

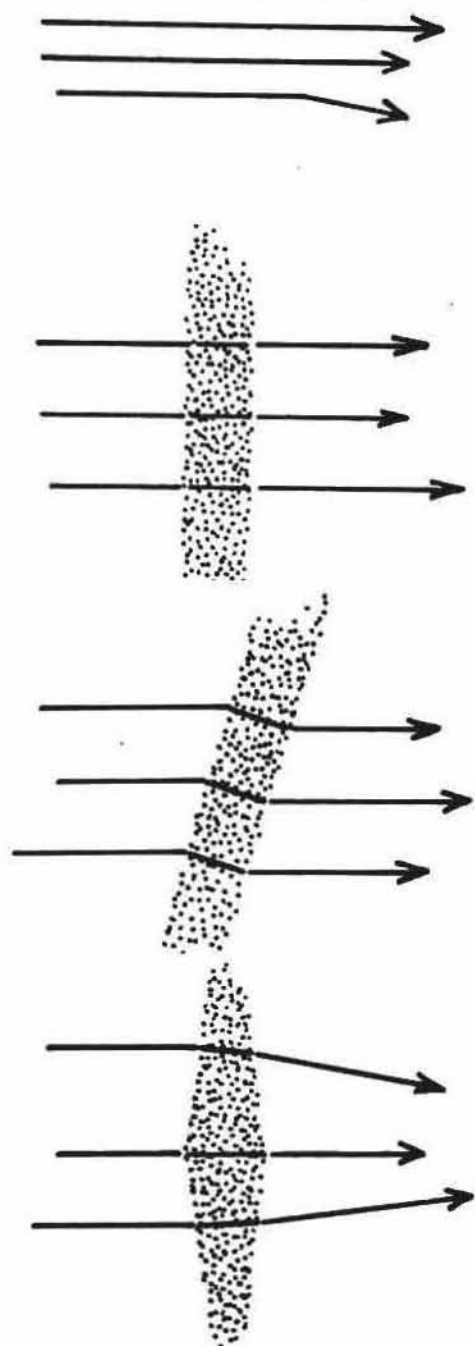

The fundamental principle behind shadowgraphs and schlieren optical probing systems is that light rays travel in space or transparent media in straight lines unless their direction is altered by some obstacle. Interferometric systems usually depend on a phase shift associated with changes in the velocity of light.

By way of brief summary, the changes in direction which light rays can undergo are summarized as follows:

Upon entering at right angles to the first surface of a medium of uniform density and parallel sides, the light ray slows down or speeds up as it goes across the medium, depending on it's density, but it's direction is not altered. Upon exiting it picks up it's original velocity.

If the ray passes through a similar subject at an angle, then it's direction is altered upon entering the first interface, but if it exits into the same medium as the one it entered from, then it returns to it's original direction at the exit interface.

If the intervening area does not have parallel faces, then the light ray which enters the region of different density has it's direction changed as above but since the exit interface is not parallel to the first one, the exiting ray does not pick up it's original direction but assumes a new one.

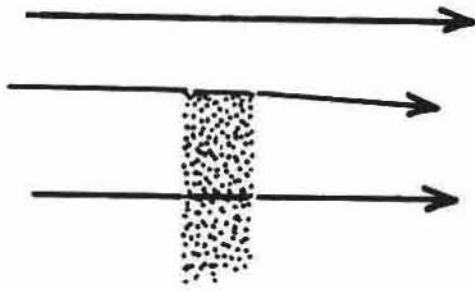

Also, when light rays travel in the vicinity of a region where there is a change in density as shown in the illustration, the direction of those rays passing close to this area will also suffer a change in direction. One could oversimplify this effect in terms of simply thinking that those rays which move past this region "stick" to the denser medium below and thus affect the direction of the ray or rays passing in this vicinity. If the denser medium is located on top, then the rays bend upwards.



For all test methods, a light source is required. Light will emanate from this source in all directions. For now we will deal only with a "point" source, although a true point source is often not obtainable or desirable.

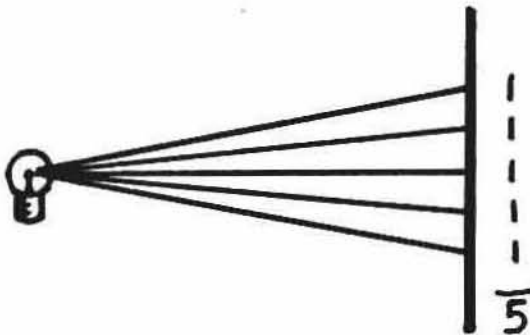

When light from this source falls on a screen, the screen will appear to be lit up by the light rays falling on it. If the source is very far away then the change in distance between the source and the edges of the screen will be negligible. This will result in an energy distribution which is shown in the drawing. That is, there will be the same units of energy per unit surface area. This will be reflected by the visual sensation that the screen appears to have the same "brightness" or luminance all over. We could simply say that on any given spot there is one light ray falling. In this case, over the five points shown, we would measure one ray over each point, or five total units of light energy.

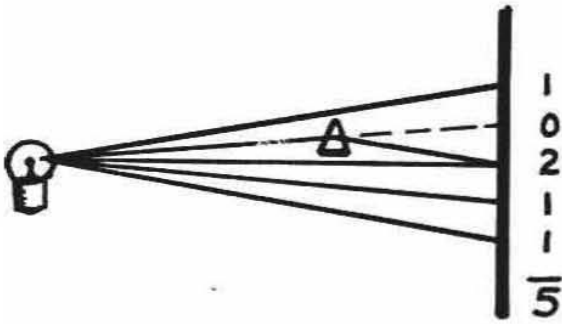

If we now disturb the situation and alter the path, or flight direction, of one of these rays, we will notice that the energy distribution pattern has changed. From one place the light ray is removed, with the illumination falling to zero, and at another, the light that was taken from the previous point is added to that point with the consequence that the illumination is doubled. This area appears twice as bright as the undisturbed surround.

Notice that the total energy has remained unchanged. We have simply taken some energy from one place and moved it to another. We have, however, set up a system for detecting the fact that some disturbance located between the light source and the screen has appeared, changing a "steady state" condition. The exact location and magnitude of the disturbance is hard to pinpoint, however.

RESOLUTION

- DECREASE LIGHT SOURCE SIZE
- SMALL SOURCE - SCREEN DISTANCE

SENSITIVITY

- LARGE SOURCE - SCREEN DISTANCE

The sharpness of the images secured with this type of detection system depends largely on the size of the source, the smaller the better. Also, as the distance from the source to the screen increases, the sharpness of the shadow image formed increases. Sensitivity, on the other hand, increases as the distance between the disturbance and the screen increases. Sensitivity and resolution depend on opposing parameters.

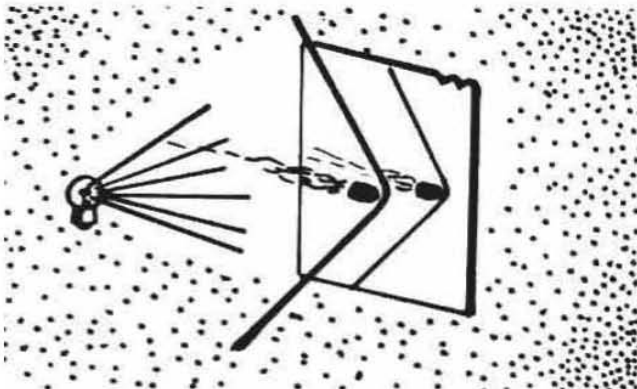

Generally, in what could be called direct shadowgraph recording, the screen is a piece of photosensitized material the size of which limits the size of the subject that can be adequately recorded on it. If this is the system design, then the work must be carried out in a darkened laboratory.

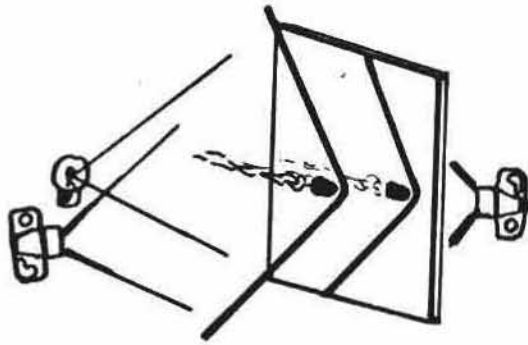

Where the screen size is insufficient to cover the subject, an indirect method can usually be employed. This consists of photographing the shadowgraph pattern with a more or less "standard" camera. This is accomplished by causing the pattern to fall on a white screen and, usually, photographing from behind the disturbance. This, however, causes the subject itself to interfere with the view of the screen. Keeping the camera/light axis as close as possible minimizes this effect. An alternative is to photograph the shadow pattern from behind a translucent screen.

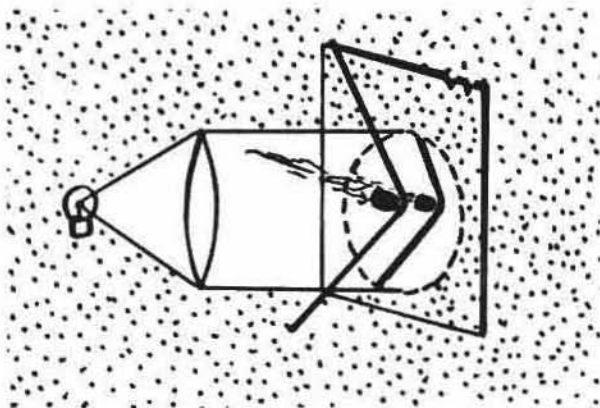

Gains in luminous efficiency and evenness of illumination on the screen can be accomplished by collimating the light source. This, however, has the effect of limiting the field size, and thus the subject size which can be recorded by the system.



A big advantage of the shadowgraph system is that it is relatively cheap to set up and that it can deal with subjects of relatively large size. Attempts to increase the system sensitivity invariably raise the cost and the improved versions usually start to become very similar to Schlieren systems.

A further modification of the shadowgraph, and one which starts to approach the principles of Schlieren systems, employs a retroreflective material as the screen to increase the luminous efficiency.

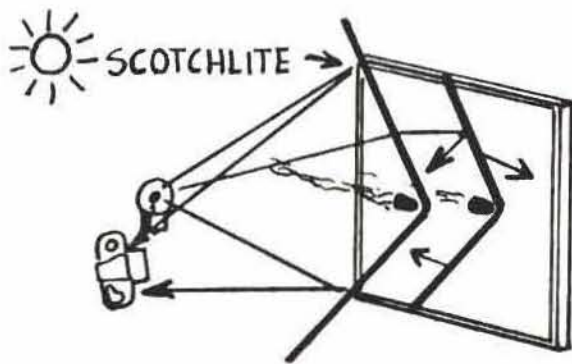

The "Scotchlite" material used as the screen has the property of reflecting light incident on it back in the same direction it arrived. Thus, a small camera located next to the light source will collect a relatively large amount of the light emitted by the source if it is located very close to the source itself.

Disturbances between the source and the screen will alter the direction of the reflected light rays causing them to bypass the camera lens. The areas from which the light is thus removed will appear dark on the image of the Scotchlite screen. Some areas, on the other hand, may marginally gain brightness. This method has been used in full daylight conditions to secure technically useful data related to explosives and ballistics behavior.

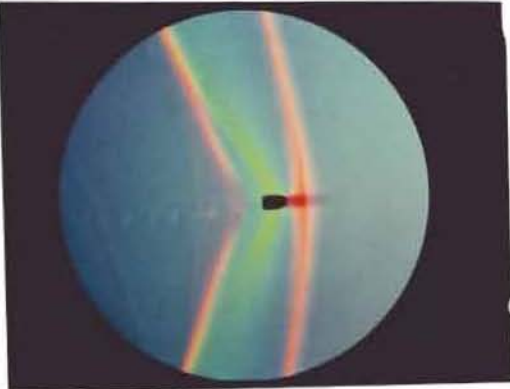

While Shadowgraphs and Schlieren techniques are both used to study refractive index changes in a variety of subjects, Schlieren systems are particularly useful when high sensitivity is required or when a color record is desired. Schlieren systems actually are nothing more than Shadowgraphs in which the deflected rays are interfered with in some manner, rather than allowing these rays to reach the imaging screen undisturbed.

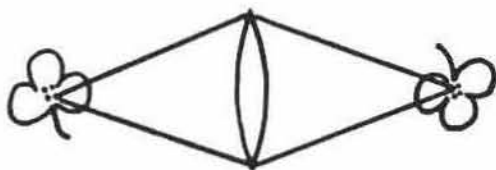

To understand the principle on which Schlieren systems work consider that a lens makes an image of every point in the subject by collecting a cone of light emanating from each subject point. The size or area of the base of this cone is determined by the size of the lens aperture. For a given image size, the larger the base dimension, the brighter the image on the screen.

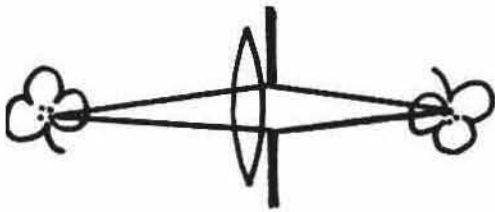

Thus, as a lens is stopped down we do not see the edges of the diaphragm decreasing the field of view or casting a noticeable shadow on the groundglass of a camera's viewfinder, but rather we simply see that the luminance or brightness of the image decreases simultaneously overall as the aperture is decreased.

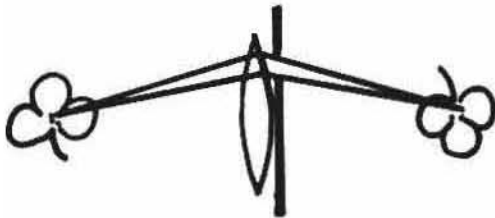

It is interesting to note that the aperture can, in fact, be located anywhere in the diaphragm plane and the effect is the same. That is, no matter where the aperture is, a full image of the subject will be formed at the film or screen plane and that it's brightness will simply be controlled by the open area of the diaphragm.



In fact, one could carry this process to the ultimate end and logically figure out that it would be theoretically possible to make the opening almost infinitely small. Then, the diameter of the aperture would be as small as one light ray. However, even if this were the case, a ray emanating from a point on the subject would manage to pass through this "hole" and fall on a corresponding location on the screen.

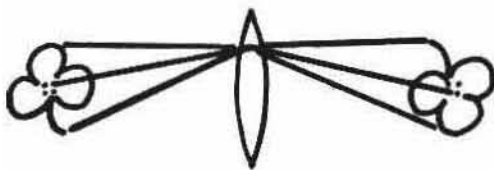

Actually, in this assumed state, one light ray from every point on the subject side of the hole would be able to pass through it and arrive at the screen. Thus, a "standard", upside down, reversed left-to-right, image of the subject will be present at the screen. This ultimately means that every point on the surface of a lens produces a complete image of the subject.

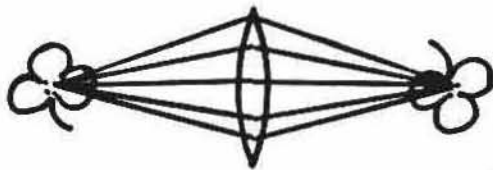

The more "points" there are to form an image, and this is governed by the total area of the lens, the brighter the combined image formed by the contributions of the individual components or lens surface points becomes. Thus, the larger the aperture the brighter the image because more points on the lens contribute their individual images to the final composite. In graphical form this is shown by the size of the cone of illumination at each image location. In photographic terms we deal with this fact every time we adjust the f# of the lens.

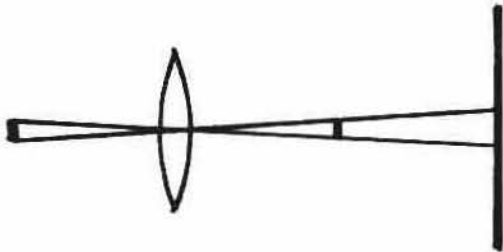

Now, assuming that we start with a source on the left, the lens makes an image of this source on the right, and the light continues onward until it is intercepted by a screen.

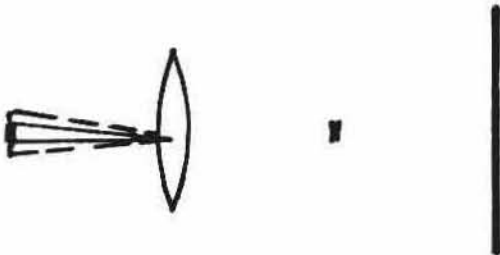

The brightness of a point on the surface of the lens is affected as explained above and is a function of the size of the source and it's brightness or luminance. Thus we can draw rays extending from the limits of the source to represent the cone of rays that illuminates a given point on the lens surface.

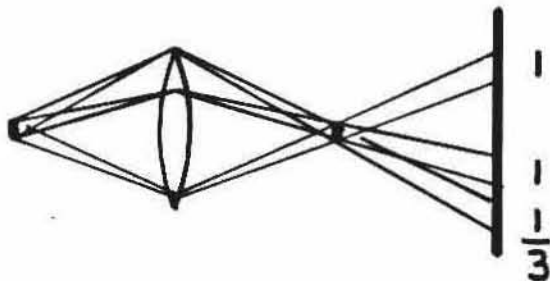

As these divergent rays leave the lens surface, they all pass through the focal plane of the lens at the place where the image of the light source is located. Eventually these rays fall on the screen and note that, as before with the shadowgraph system, we can, in this very simplified diagram, deduce (and measure) that the illumination level is unity in each of the three sample areas on the screen illuminated by the three different points on the lens surface.

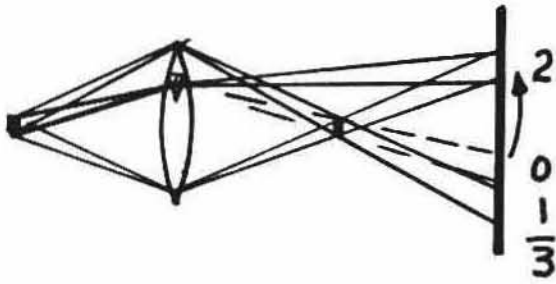

Next, the direction of the beam emanating from the middle point on the lens is altered by some means. This causes the light beam to fall superimposed on the same spot as the beam from the lower point. The consequence of this is that the brightness distribution on the screen changes. At the top we measure two units of energy, in the middle none, and the bottom spot remains undisturbed. The total energy still is three units as before but it exists in a redistributed state. From this new pattern which is visible on the screen one can tell that light was bent away from the middle spot and added to the top spot on the screen. That is, a disturbance which changed the direction of the light rays caused this change.

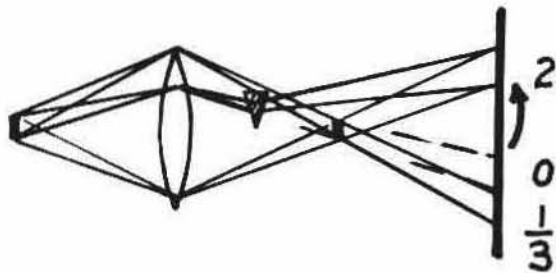

This can then be attributed to a refraction of the light beam as it traveled between the source and the screen. The location and magnitude of the refractive gradient which caused this change in brightness is hard to estimate because similar total effects can be achieved by a small gradient over a large distance or a large gradient over a short distance. Plus the disturbance can be located, as shown here, anywhere along the light beam for that matter. Up to this point we have simply set up a shadowgraph system once again.

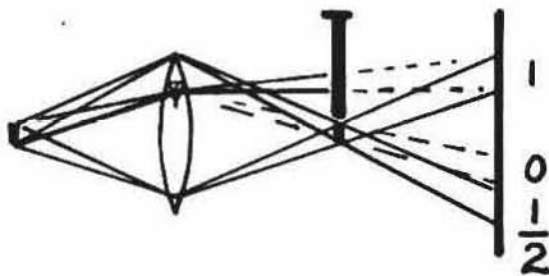

Note that an obstruction can be placed next to the location of the image through which all light beams radiating from the lens's surface pass. This will have no effect on the undeflected rays, but those that are bent will fall on this obstruction and fail to arrive at the screen. Thus, the bent light is simply removed from the screen and not added somewhere else. This interaction of deviated light with an obstruction is the principle on which the Schlieren system operates. Notice that in this configuration, the image formed on the screen is a shadow image and that it is usually quite unsharp.

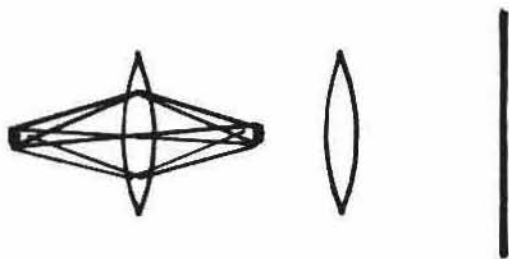

We will now examine the process further and improve on it's sharpness as we discuss focused systems. Here a second lens is added behind the image of the light source formed by the first lens, commonly called a "field lens", or "field mirror" in mirror systems which will be discussed later. The term "schlieren head" is often used instead of "field lens".

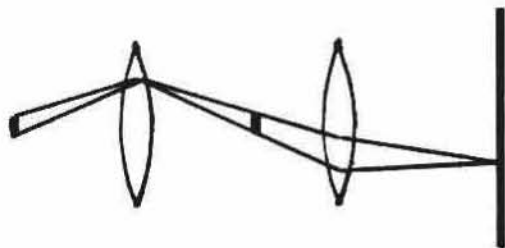

The rays of light emanating from one field lens point are intercepted by a second lens, the camera lens. It's focal length does not matter. It is chosen to simply provide an image size of the field lens which is adequate for the purpose. This camera lens, when focused on a point on the surface of the field lens, will reproduce that surface point as a sharp image point on it's screen.

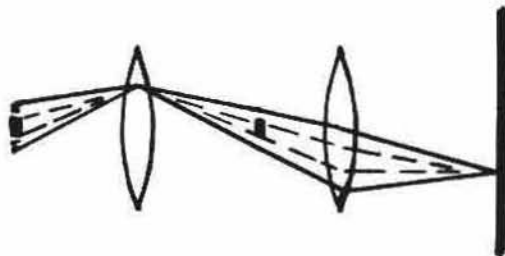

As discussed earlier, the brightness of any point on the field lens surface, and as a result the brightness of corresponding image points, is a result of two factors. For a given brightness of the lamp, the brightness of image points can be increased by increasing the size of the source, effectively increasing the cone of illumination reaching each image point in a similar manner as if the diaphragm of a camera lens had been opened up.

Alternately, for a given source size the brightness of a point on the surface of the field lens can be changed by varying the source brightness. This can be accomplished by a voltage change to the filament.

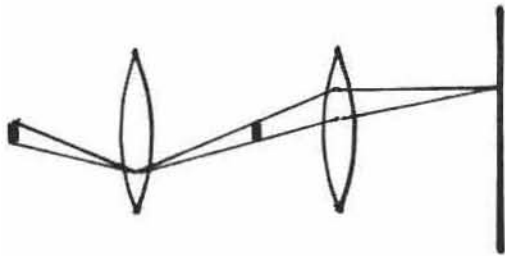

Again, note that the second lens reproduces each point on the field lens's surface. In this case it forms an image on the lower edge of the field lens at the top of the screen...

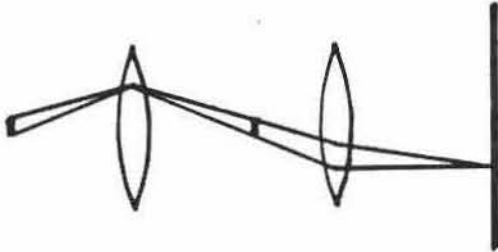

...and in this case it forms an image of a field lens point located high on it's surface at the bottom of the screen...

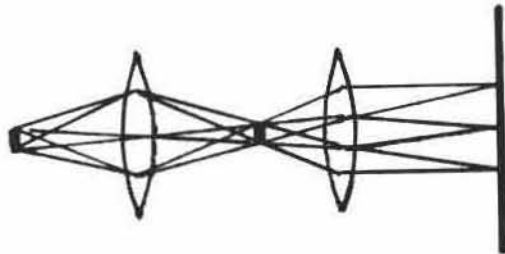

...and now three field lens point locations are shown simultaneously. If the process were extended to account for all light rays, again we would notice that the brightness distribution on the screen is uniform.

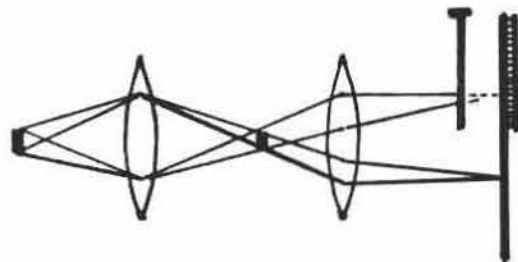

Now, an opaque obstruction extending from the top downwards is placed at a location close to that of the surface of the screen...

...this obstruction blocks those light rays that would have fallen on the top portions of the screen but does not affect the brightness of the screen below. The obstruction basically casts a shadow of itself on the screen. Some of the light is actually eliminated from reaching the top of the screen.



If you were to look at the groundglass located at the screen position you would see the top of the image of the lens go dark. The shadow would appear to come down from the top as the mask is lowered.

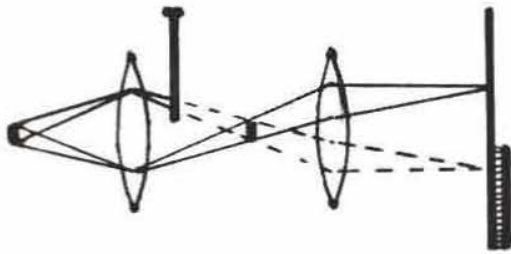

Now, taking the same mask to a location near the field lens, we would notice that as the mask again is lowered from the top, we would start to cover up the surface of the field lens from the top. This is reflected at the final image plane, within the camera, as a gradual darkening of the image starting from the bottom. The unaffected points on the field lens surface will not change in brightness because they can still beam the totality of the light rays which come from the source.



The visual impression apparent at the screen, then, is as shown here, with darkness appearing to move upwards now even though the opaque obstruction is moving downwards as was the case above. One might ask, then, whether there is a place that the obstruction, commonly called a "knife edge", can be located at which the inflexion, or reversal of direction of shadow motion, occurs. With the knife edge at this location one should not notice the direction in which the shadow is moving but would rather simply perceive a gradual darkening of the image of the field lens on the camera's screen.

KNIFE EDGE MUST BE PLACED AT FOCUS OF FIELD LENS

The location at which the knife edge causes this gradual overall darkening without giving a hint of the direction in which it is being inserted into the light beam is when it is located at the exact focus of the field lens. This point or plane is sometimes referred to as the schlieren plane or stop. All we have done so far is to set up for a Foucault test of a lens!

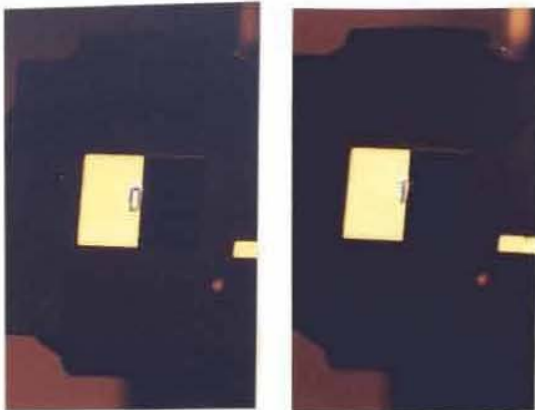

In these illustrations the image of the light source is shown falling on an improvised knife edge with the whole image falling on the obstruction. In practice a small amount of light is allowed to pass by the knife edge to give the background a noticeable tone. How this is accomplished is discussed next.

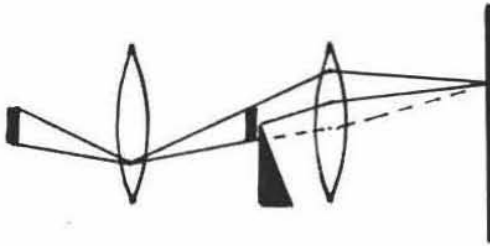

Referring to an earlier illustration, we discussed that the brightness of any given point in the image could be altered by changing the source size. The exact same effect can be produced by changing the size of the image of the source. This is what happens when the knife edge is inserted at the exact focus of the field lens. By taking a single point on the surface of the field lens as an example, you can see that the insertion of the knife edge cuts into the beam of light coming from the surface of the field lens. This results in a fewer light rays reaching the corresponding image point on the screen, thus causing the brightness of that point to fall. The effect, again, is exactly the same as if we had decreased the size of the source itself. Basically, if the knife edge cuts 50% into the beam the illumination level at the screen will drop to 50% of the original level.

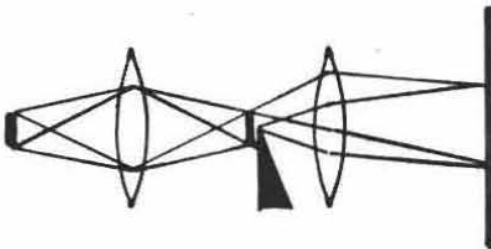

Just to carry the point a bit further, note that since the light rays from all points, here summarized with just two, pass through the image plane of the field lens, the knife edge will simultaneously cut into the image of the source formed by the cumulative contribution of all points on the lens surface. At any other location along the beam, the knife edge interferes more with some of the image beams than others causing an uneven darkening of the image of the field lens. Therefore, with the knife edge in this location, the brightness of every image point is diminished simultaneously. The visual appearance of this process of cutting into the image of the light source, then, is as shown in this illustration.

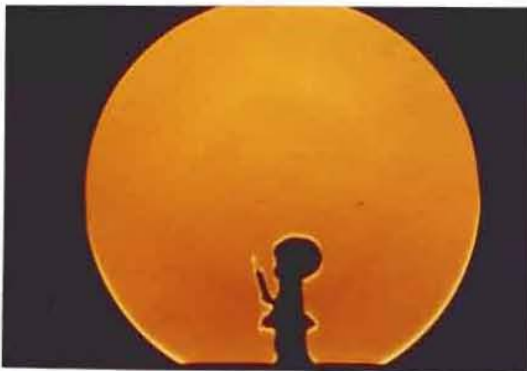

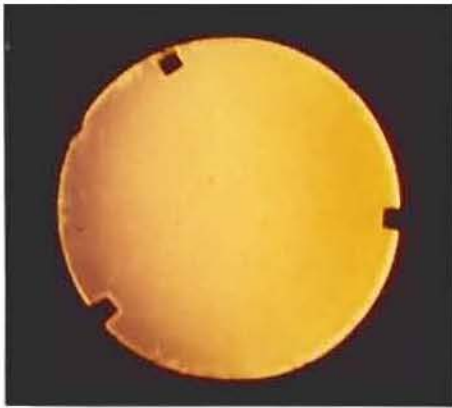

FOCUS OF FIELD LENS VARIES WITH WAVELENGTH

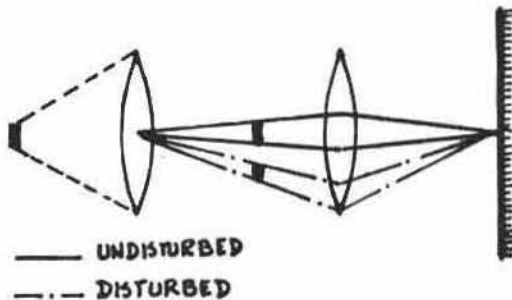
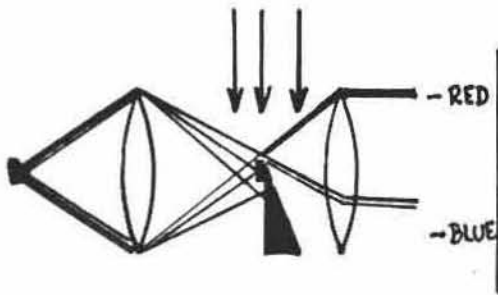

At this point it may be appropriate to mention that if field lenses are used, the schlieren field may appear colored even with no disturbances present.

This is due to the fact that unless the field lens is free from chromatic aberration, it's focal length, thus the location of the sharply focused source image varies with wavelength. Since the knife edge must be located at the exact focus of the lens this can only be achieved perfectly for one wavelength. This means that all other sharp images of the source formed by the other wavelengths will be out of focus at the knife edge. This causes an uneven distribution for all wavelengths other than the one which is sharply focused at the knife edge. This then causes an uneven distribution of colors to appear on the screen. This is one of the reasons that high quality concave first surface mirrors are used instead of lenses since mirror optics do not suffer from chromatic aberration.

At this point we will look at a situation in which the light from a point on the field lens travels undeviated and deviated paths through the system. When the beam is deflected from its normal path by some disturbance at the point of origin of the beam as it leaves the lens, the beam may be deflected downwards as shown in this example. This now forms an image of the light source below the point where all the other images are formed by these other points on the surface of the lens.

As this deviated light beam continues to travel towards the right all of it is intercepted by the second, camera, lens. This lens "sees" the light coming from the same spot on the lens as an undeviated beam would come from, and thus proceeds to place the light in this deviated beam in the same spot that it would place the light from an undeviated beam.

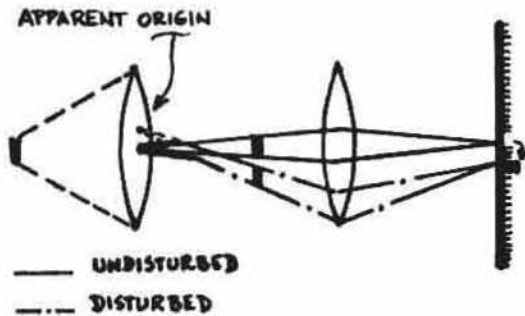

This is not the case, however, if the disturbance happens beyond the radiating surface of the field lens. Then, the second lens sees the deviated beam as coming from a different location on the field lens than an undeviated beam would come from. Thus, the light ends up in a different location than the one at which the undeviated beam would have arrived. This causes the subtraction of light from one location and the addition of this light to another location...a shadowgraph.

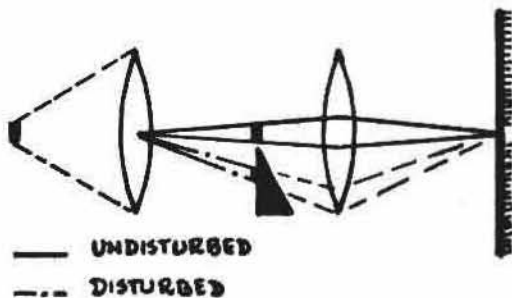

If now, in the steady state or reference mode, a knife edge is introduced just below the image of the source then the screen will still appear as bright as it possibly can because all the light from every field lens point is collected by the second lens without interference. However, if as shown, the beam from a given point is deflected downwards, in that case the deflected light is stopped by the knife edge and it is, in this case, totally eliminated from the screen. That spot on the image of the field lens goes dark. If the disturbance is not at the surface of the field lens the image of the spot from which the beam emanated darkens anyway. Notice that as was the case in a previous example, in this case the refracted or deviated light is completely eliminated from the system. Unlike a shadowgraph the refracted light is "lost", at least to the screen. As stated earlier, this is the operating principle of a schlieren system.

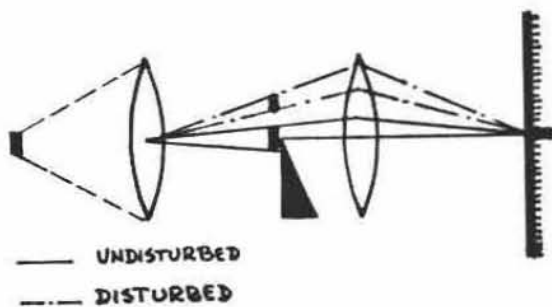

Now let us set up the system so that half of the sharply focused image of the source is obstructed in the steady state condition. Then all screen points in the camera become half as luminous as they can possibly get. Now, when the upper beam gets deflected away from the knife edge at a point in the field lens, the image which this point would have contributed at the knife edge is able to pass the edge completely but even though it has a new direction all of the beam is intercepted by the second lens. As above, this lens sees the light coming from the point at which the beam was deflected and thus it places all the light in this beam on the corresponding image point on the screen. This point will now appear as bright as if there were no knife edge in the system at all. Again, unlike in shadowgraphs, note that screen brightness at this point goes up without a corresponding loss of illumination at some other point.

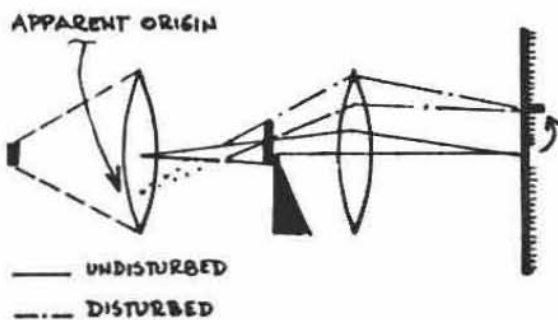

If, as is more usually the case, the disturbance does not happen in the field lens, then the second lens will place these deflected image forming rays in a different spot than the one they belong to. This means that the spot from which the beam emanated will darken. Further, however, the spot from which the second lens sees the deflected rays coming from, will increase or remain unchanged in brightness. The latter happens if the source image is completely blocked by the knife edge. Again, a shadowgraph in nature. The knife edge, however, interacts with the deflected rays as the image of the source moves across it. A schlieren characteristic. Thus, schlieren and shadowgraph are combined on one optical system in this manner.



Therefore, shadowgraphs and schlieren systems are quite interrelated. It could be said that a true schlieren system can not exist unless the region of refractive index gradients can be confined to the field lens plane.

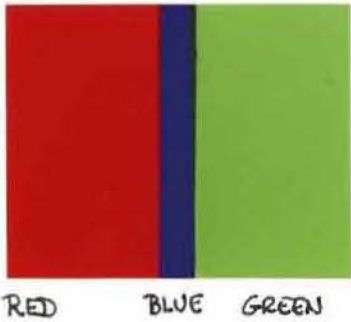

Two interesting, and popular, variations on the hard edge technique discussed so far follow. The first merely replaces the opaque knife edge with a transparent colored filter array. A simple but popular array consists of filter material arranged as shown here and placed in the plane of the knife edge.

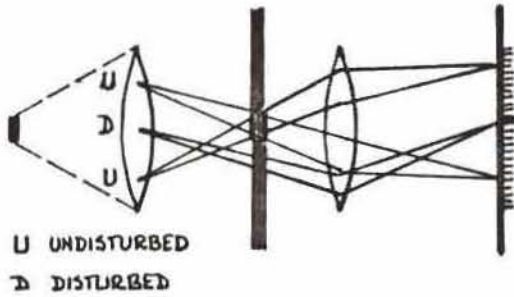

Note that in this "color" schlieren system all the undeviated rays are made to pass through a narrow, blue, central filter band. Thus, the schlieren field as seen on the screen of the camera acquires an overall color of blue. When a beam is deviated from its normal path and bent downwards, it moves so that more and more of it passes through the red filter with that spot on the screen becoming first magenta and eventually completely red. Conversely, if the beam is deflected upwards, the spot becomes first cyan and eventually turns totally green.



It should be mentioned that disturbances which cause the beam to deflect farther than the limits of the diameter of the second lens completely disappear from view and not only do those areas go totally black on the screen, the light which belongs to those areas obviously can not be added to any other spot on the screen either.

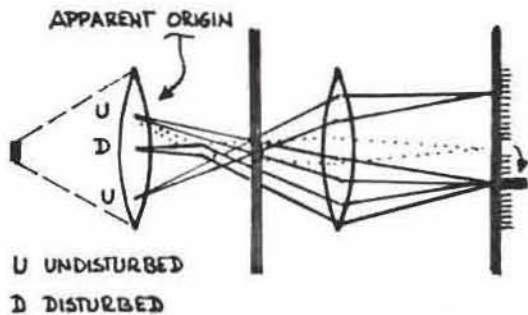

Again, if the disturbance occurs away from the field lens surface the light energy from a given spot will be added to another point on the screen. If the deviated light goes through the green filter but it appears to come from a normally red region, then that area on the screen will appear yellowish, while the area from which the beam actually is coming from will diminish in intensity.



A second variation is possible by substituting a soft edge, or graduated filter for the hard edge or the color array. This scheme is particularly useful if there are large changes or gradients in density. Further it tends to result in improved sharpness due to a lessening of diffraction effects as light interacts with the sharp hard edge, or the hard color edges of the color filter array.

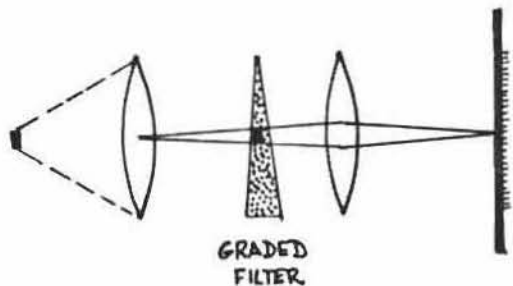

One simply replaces the hard knife edge with a graduated density filter and moves this filter with respect to the image of the light source until the image of the field lens assumes some desired brightness level. Refraction of a particular beam across the filter will cause the image of the source to pass through more or less dense areas of the filter. This results in a decrease or increase in illumination of the points which correspond to the locations which the light in these beams represent. Since the light beam does not interact with a sharp edge diffraction effects are less apparent.

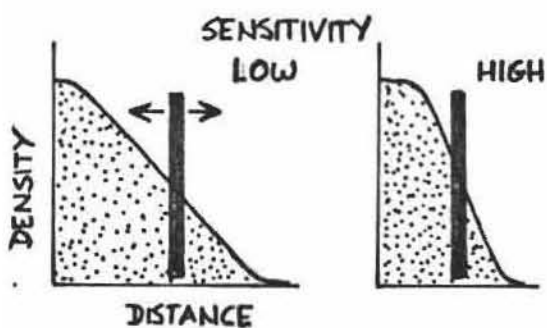

Further, since the contrast of the graded edge can be made steep or shallow, the sensitivity of the system can be extended over a large dynamic range with a shallow contrast filter. A sharp contrast graded filter starts to behave more and more like a regular knife edge and sensitivity and dynamic range are for all intents and purposes controlled by the size of the source. The smaller the size of the source in a direction perpendicular to the edge, the greater the sensitivity and the smaller the dynamic range.

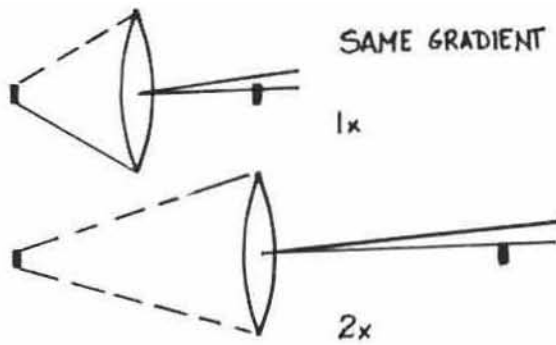

The sensitivity of a schlieren system is also dependent on the field lens or mirror focal length, the longer the focal length the greater the sensitivity. Actually, what matters is the distance between the disturbance and the knife edge. This can obviously be made greater with increasing focal length so sensitivity is tied in with focal length in this manner.

TOTAL DEFLECTION POSSIBLE BEFORE RANGE EXHAUSTED

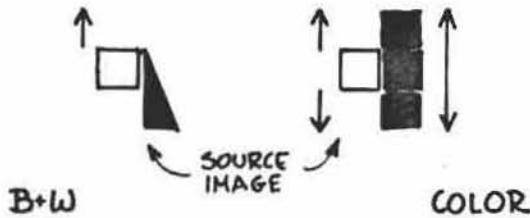

In terms of sensitivity black and white systems seem to me to be more sensitive, but at the expense of dynamic range. On the other hand, the dynamic range of color systems can be large while retaining a respectable level of sensitivity. The reason for this is that in the color system the image of the light source can travel across a number of transparent obstructions continuing to yield information about the interaction between the image of the source and the series of colored filters, in the black and white system the image of the light source can only be displaced over a distance equal to it's width before exhausting the range of tones it is capable of forming at the camera's screen.

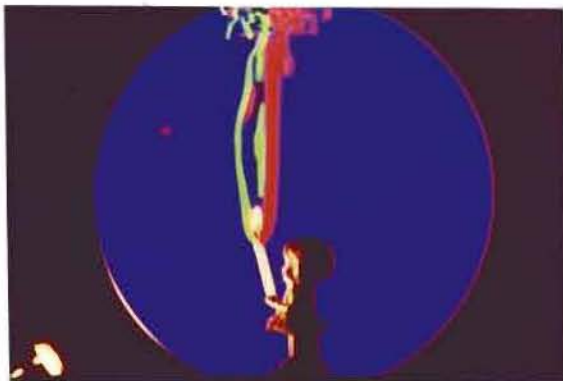
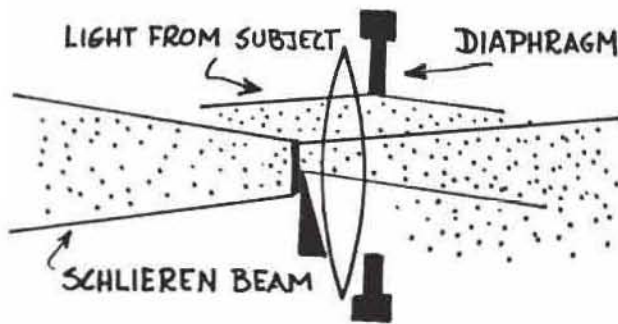

One most interesting effect, and one which dramatically illustrates the point that most schlieren systems basically consist of two superimposed optical systems, is apparent when the aperture of the second lens is altered. Notice that unless the diaphragm is closed to a very small opening, changes in the aperture of this lens have no effect on the light beams which form the image of the light source at the knife edge. This means that as far as the schlieren field is concerned, its brightness is affected only by the size and brightness of the light source. The brightness of the "silhouette" of the subject is controlled by the aperture of the camera lens and the light falling on the surface of the subject located in the schlieren beam.

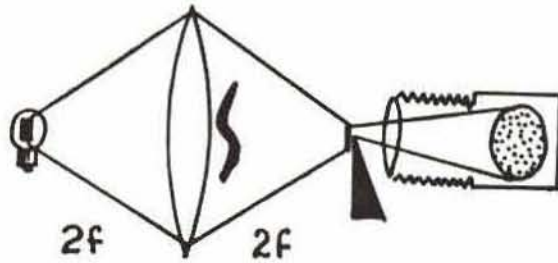
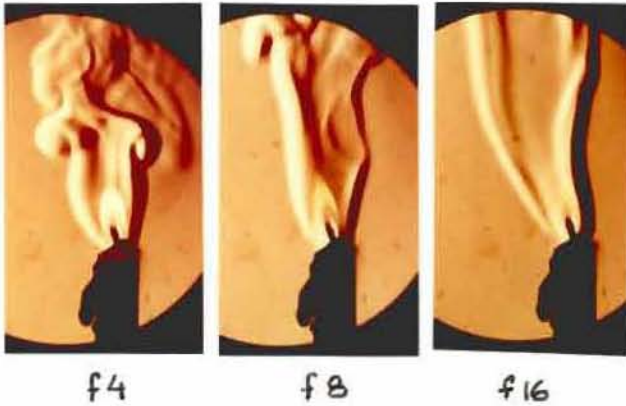

By adding light to an opaque subject, which may be causing density changes near it, the surface of the subject becomes visible without the background, or schlieren, field being affected. The three images shown here were taken at decreasing apertures but at the same exposure time. Note that the visibility of the candle flame becomes less as the lens is stopped down but that the background density remains unchanged.

Now we will briefly review the optical layout of a single field lens schlieren system. The source consists of a compact, rectangular light source with well defined edges. If this is not available, a larger and less regular source can be reduced in size and shaped by passing it through a slit which may have variable width capability.

The filament of the lamp, or the slit, is located at roughly two focal lengths from the field lens. This forms a life size image of the source also two focal lengths on the other side of the field lens. The knife edge or filter array is located at this plane. It is moved back and forth until the image of the source is sharply focused on the knife edge. A camera lens is located somewhere beyond the knife edge location making sure that the diaphragm of the lens is wide open or at least that the diaphragm does not interfere with the light rays which form the image of the source at the knife edge. With autoaperture lenses it is best to set them in the manual mode. Some workers have used the edge of the actual camera lens diaphragm as a substitute for a separate knife edge with success.

If the camera lens is aimed at the field lens and focused on the subject plane which should be as close to the field lens as possible. Then, a fully illuminated image of the surface of this lens should be visible in the viewfinder.

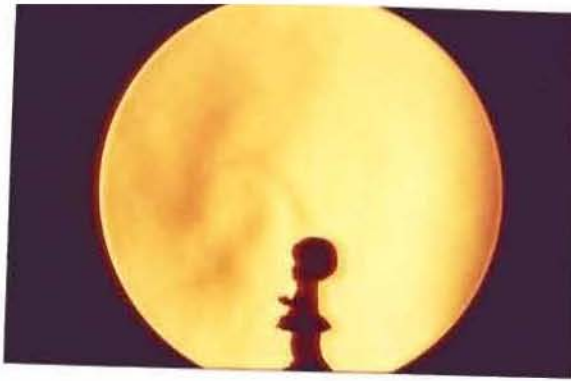

As the knife edge is inserted into the beam the illumination should gradually diminish overall. If a color filter array is inserted in the beam, then the field should acquire an even color made up of the color of the central filter band when the light which forms the image of the source passes through it. Fields of uneven brightness or color distribution are generally considered technically imperfect in their alignment and set-up. When the subject is placed in it's proper location it will show up in silhouette against the background.

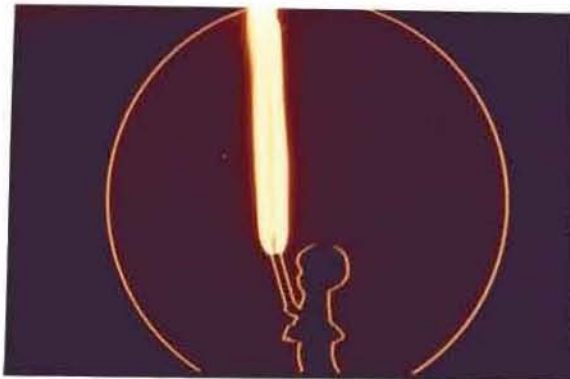

It is also possible to set up a "dark field" schlieren system by making the knife edge block all the rays in the steady state condition. Then, only beams which are bent away from the edge will add light to corresponding image points in the viewfinder. Or, the knife edge can be a strip, or a circle, if a circular source is used, which just blocks the image of the source. Then, any movement of the image of the source across the strip will add light to the groundglass. With the circular knife edge movement in any direction becomes detectable.

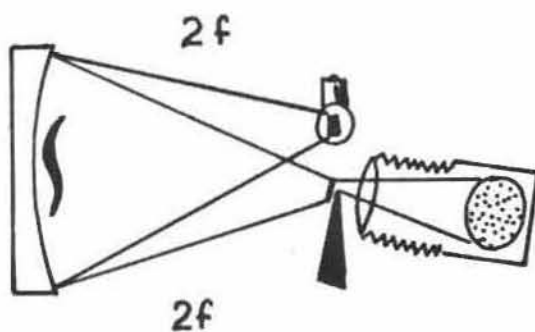

Now we'll look at the layout for a single mirror type schlieren system. Besides the freedom from chromatic aberration, mirrors have the added advantage over lenses that they need to only have one surface ground and polished and that defects in the substrate are usually of much less significance. Thus large diameter mirrors are considerably less expensive and better than lenses for Schlieren applications.

In this system the basic layout of distances and alignment procedures is the same as with a single lens system. However, since the light is reflected by a mirror, the bending angle caused by the light passing through the density gradient located in front of the mirror is doubled in magnitude. Thus, this type of schlieren system has twice the sensitivity of a lens type system of equivalent focal length. It is known as a double-pass or 2X sensitivity system.

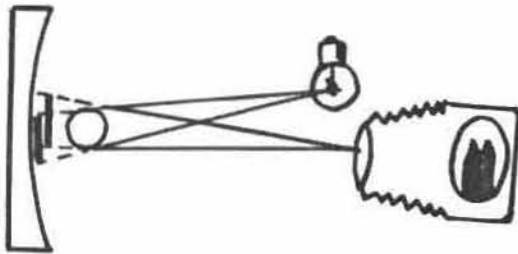

The gain in sensitivity of a single mirror or two-pass schlieren system is not achieved without penalty. Notice that the axis of illumination and the axis of view are not coincident. Since there is a small separation between the two, the subject obscures part of the mirror surface from the light source essentially casting a shadow on the mirror surface. From the point of view of the recording camera, the subject covers up a different portion of the mirror surface. These effects combine to produce what appears to be a double image of the subject at the camera. These are actually the subject and its shadow. They can be made less objectionable by keeping the separation between the source and the camera lens small. There are schemes whereby the two can be made coincident, but only at the expense of light available in the system.

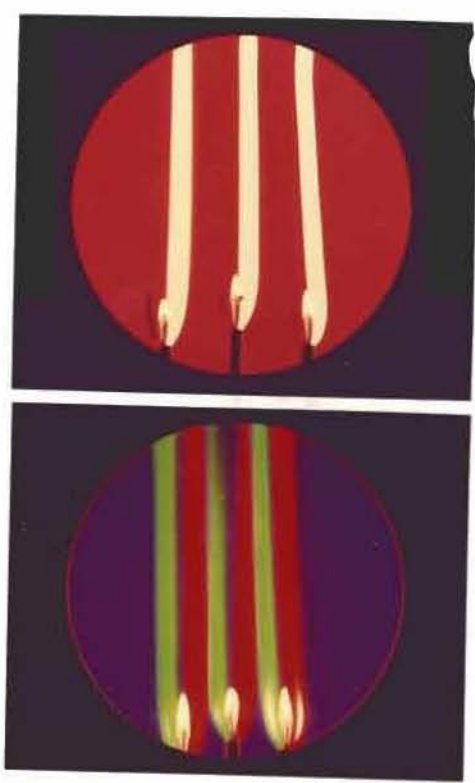

These examples show that the colors visible in a color schlieren system are totally dependent on the arrangement of the filters used in the system. As mentioned earlier, as far as sensitivity is concerned theoretically, there is no intrinsic advantage in a color vs. a black and white record other than we are able to distinguish differences in color easier than differences in tone. The advantage of color systems lies primarily in the extended range of light beam deviations they can accommodate without stopping to yield useful information.

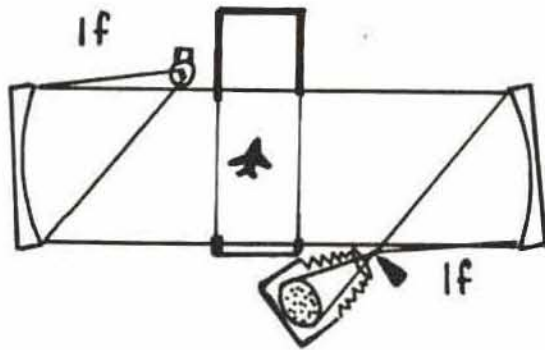

The most popular type of schlieren system is the "Z" type and this is the type that is most often used in conjunction with wind tunnel studies. The light source used has the same requirements as for systems presented earlier, however, in this layout it is located to one side of one of the two schlieren mirrors and exactly one focal length away from the mirror. Because of its placement in this position, the mirror projects a more or less parallel beam of light, as if trying to focus the light from the source at infinity. The location of the source, in fact, is adjusted until the emerging beam from the mirror maintains the same diameter over an extended distance.

A second mirror, which can be located a considerable distance from the first, thus allowing the wind tunnel to be placed between them, intercepts the light beam from the first mirror. Because it is parallel and therefore appearing to come from infinity, the second mirror brings this light to a focus, and forms an image of the source one focal length from its surface. The mirror is turned so that it places the image on the opposite side of the beam as the location of the source. This placement tends to reduce aberrations introduced by the first lens being at an angle to the source.

While the placement of the knife edge is standard, the distance of the camera to the image plane will need to be adjusted so that the lens is nearer to the image plane than when focused on infinity. Most standard camera lenses do not allow this and lenses on bellows need to be used.

The reason for the unusual requirement mentioned above is that the second schlieren mirror acts as an auxiliary optical element with respect to the light rays that make up the image of the object located in the schlieren field.

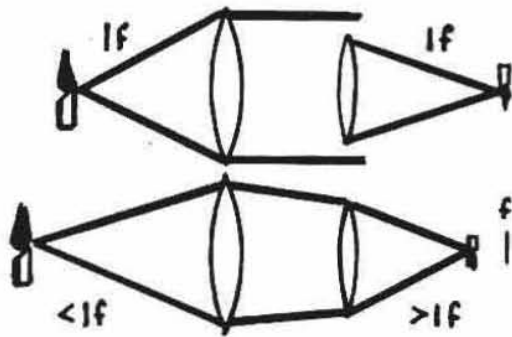

When the subject is located exactly one focal length from the mirror, the mirror in effect projects the image forming rays to infinity. These rays arrive to the camera lens as such and this lens will need to be set to infinity focus.

When the subject is located farther from the mirror than one focal length, then the mirror brings the image forming rays to a real focus and the rays leave the mirror converging towards this focus point where a real inverted image of the schlieren field will be formed. Since these rays are converging when they arrive at the camera lens, and the camera lens-to-screen distance is least when the incident rays from a subject are parallel, the lens will, in fact, form an image of the subject at a distance less than that which it has when the lens is focused at infinity.

It is only if the schlieren field is located at a distance smaller than the focal length of the second mirror that the camera lens will need to be racked out beyond its infinity setting. When the subject is located here, then the diverging angle of the rays from the subject is reduced in magnitude but they leave the mirror still diverging. Thus when the camera lens intercepts them the lens will need to be extended beyond its infinity position.

Generally, the schlieren field is not located so close to the second mirror because its location here would introduce aberrations and possibly interfere with the light source assembly. In addition, one of the primary advantages of the double mirror system is exactly that the distance between the mirrors can be kept large to introduce objects as large as a wind tunnel between them.

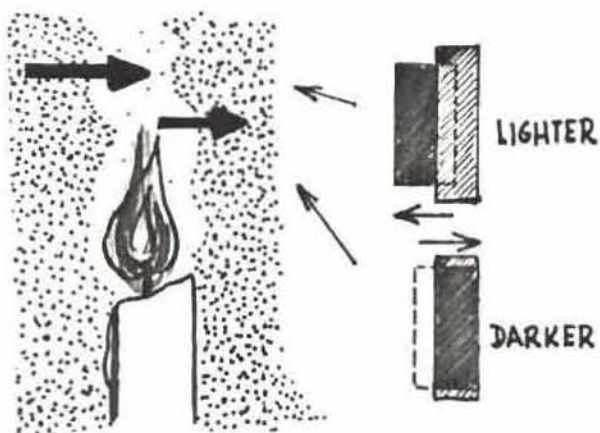

It is worth mentioning that shadowgraph and schlieren systems are not representations of absolute temperature or density of a medium. Thus, they can not, for example, distinguish warm air from cold air. All each can do is to detect an edge or a gradient. That is, if it is established that there is in the subject an area which is warm, then proceeding from the left, for example, one will run first into a density gradient going from high to low. This may cause the image of the light source to move away from the knife edge thus this gradient will appear brighter than the surround.

Conversely, as the other edge of the warm area is traversed, one would go from a low density area to a high density one. This will cause the image of the source to move in the opposite direction as in the previous case. Therefore, this gradient will appear as a darker area on the screen.

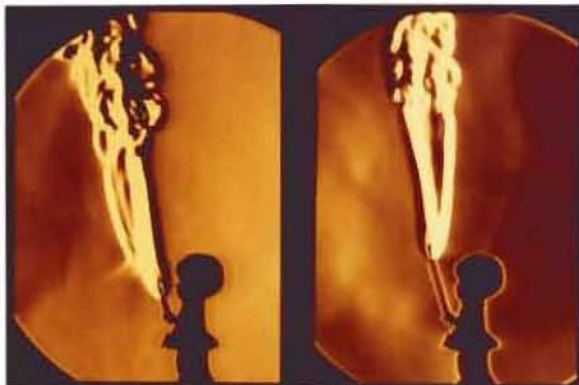

Also, it should be noted once more that the reverse distribution of subject tones, or colors in a color set-up, can be secured by the simple expedient of reversing the position of the knife edge.

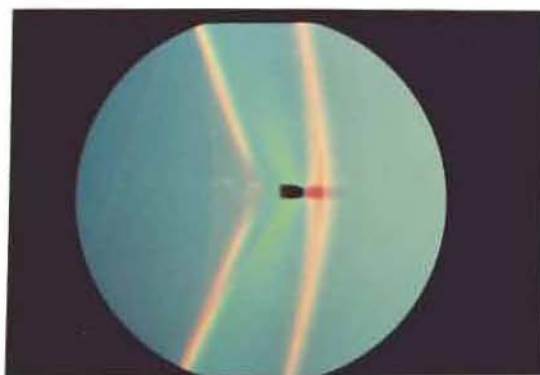

In a simplified subject as illustrated here, areas of uniform density regardless of whether they are high or low or in between, will appear as areas of uniform brightness at the final image. It bears repeating that shadowgraphs and schlieren systems detect edges, changes, or simply gradients, which cause a deviation in the path of light rays which travel through these gradients.

SHADOWGRAPHS SCHLIEREN

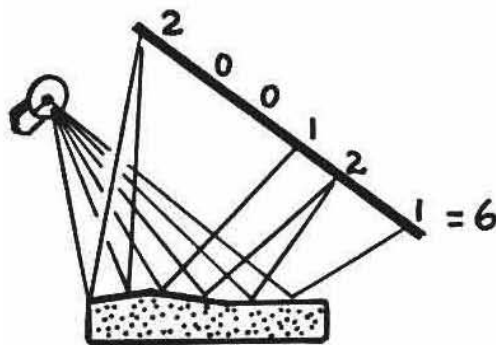
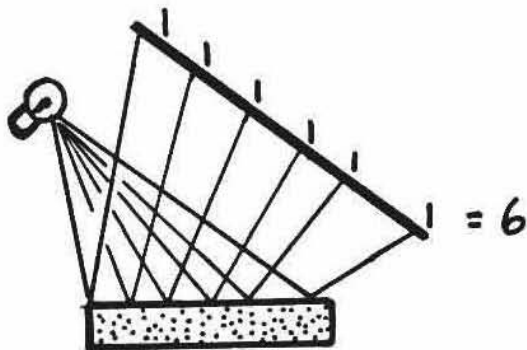

So far we have covered quite standard applications of shadowgraph and schlieren systems. The applications all deal with imaging density gradients in transparent subjects. These density gradients alter the path of light rays and these deviated rays rearrange the light energy distribution on a screen for the shadowgraph system, or interact positively or negatively with a knife edge in a schlieren system to produce brightness or luminance changes at an image plane.

Both systems depend on altering the path of light rays by "refraction". But the path of light rays can also be altered by "reflection". Thus it should be possible to also design reflection shadowgraph and schlieren systems.

First we need a source and then a reflective subject. This will invariably be some kind of a more-or-less-flat surface. The light rays from the source reflect off this surface and proceed to fall on a screen as in a typical shadowgraph set-up. The brightness of this screen we will assume is rather uniform.

When a disturbance appears which alters the flatness of the subject's surface, light rays assume new flight paths or directions depending on the angle at which they fall on the uneven surface. Since their direction is altered, they fall on new areas on the screen and change the brightness distribution...but not the total light energy falling on the screen. Suffice it to say that the new pattern formed on the screen is a direct indication of the fact that the surface is no longer flat.

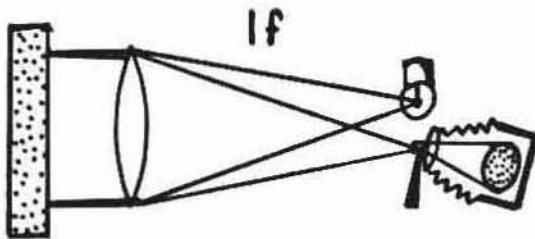

A similar scheme can be set up with a schlieren system, with the surface under study made to interact with the schlieren beam in any of a number of schemes. We will set up a system which might be used to study the surface flatness of a solid subject.

The light source is placed one focal length from a lens. The light beam leaves this lens essentially in a parallel collimated beam. The beam reaches the reflective surface. Assuming that the surface is truly flat, the beam is reflected equally at every point and heads back towards the schlieren head or lens. If the source is placed exactly on axis, and the surface is perpendicular to it, then the reflected beam will be reimaged on the source. Since this is not generally a useful location, the source should be located slightly off axis, causing the reflected beam to form an image of the source slightly off axis on the other side. This is the location for the schlieren knife edge, with the camera lens located slightly beyond the edge as in a regular schlieren system.

Introducing the knife edge into the light source image here has the same effect as in a transmission schlieren system. The overall field brightness changes as the knife edge is made to cut off more or less of the image of the light source.

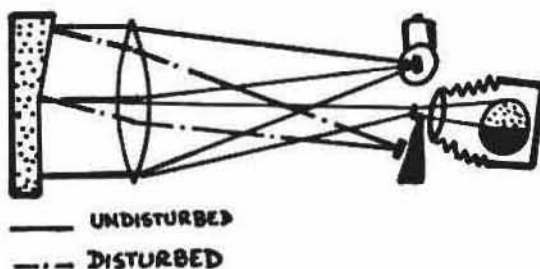

If the surface contains areas which are not flat, then the slope of the surface will cause the image of the light source to move with respect to the knife edge. If a point causes the image of the source to move towards the knife edge, then that area of the image of the surface at the camera screen will darken. Conversely, if the image is deflected away from the edge, then that area will lighten. If the image is deflected along the edge, then the area causing this disturbance will darken while an adjacent area will lighten. Thus, the schlieren and shadowgraph systems are superimposed on each other.

FLAT?

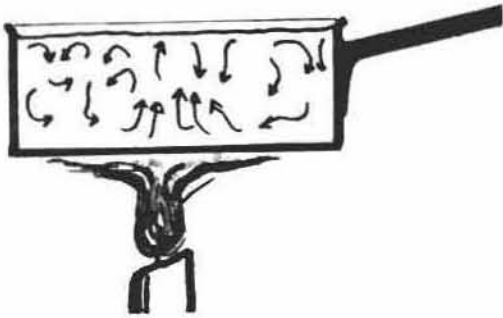

In fact, not only are the two optical systems superimposed on each other, but it is even possible to superimpose the refractive and reflective configurations on each other as well. A typical application for such an arrangement would be the desire to study density gradients within a substance and their relationship to patterns on the surface of transparent solids or liquids which also are supposed to have a flat surface.

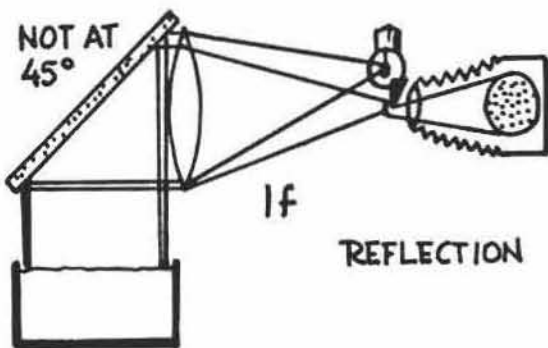

The optical layout required to superimpose the two types of systems for the study of the effect of convection on the surface of a liquid would start with a source slightly off the axis of a schlieren field lens and one focal length away. The field lens projects a parallel beam of light which is deflected by a first surface mirror at an angle of close to, but not quite, 90 degrees and onto the surface of the liquid, here shown in idealized form. Since the liquid will automatically have a level, though not necessarily flat, surface, it will reflect a substantial amount of the incident light back up towards the field lens. This light will eventually form an image of the source close to its real location. Since the source was slightly off axis, its image will also be a little displaced. If the surface is truly flat, then at the plane of this image, all the points on the liquid surface will contribute their own individual images of the source. If, however, some surface points are at an angle, then the images of the source formed by these points will be displaced and will interact with the knife edge in unequal ways causing a typical schlieren pattern of light and dark tones to appear on the camera's screen.

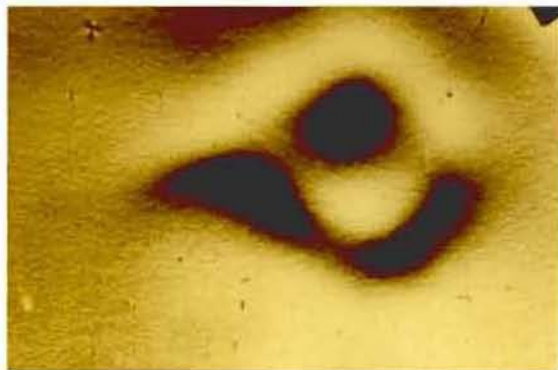

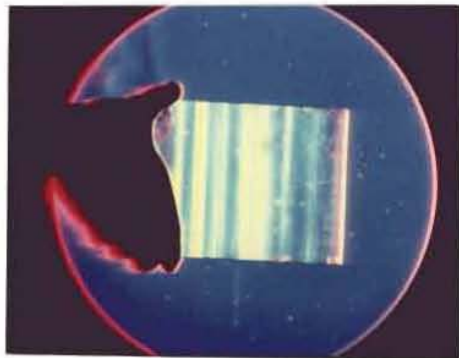
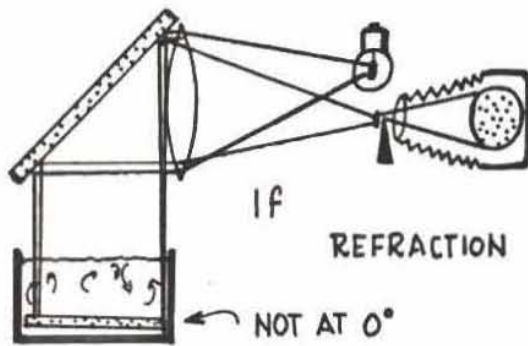

Ignoring for now the light that was reflected at the liquid surface, a large portion of the light incident on this surface passes through into the bulk of the liquid. Assuming that the liquid is free of density gradients, the light proceeds down to the bottom of the container undisturbed. Here it is reflected by another first surface mirror aligned at an angle which is not quite 0 degrees, which is the angle that the liquid surface sets itself to. The light which is reflected now travels back up through the liquid and out of the surface, back through the field lens, and eventually this light, too, forms an image of the light source somewhere close to the original source and close to the location of the image formed by the light reflected from the surface. A second knife edge is inserted into this, second, image of the source. If the bulk of the liquid has density gradients present, these cause the image of the source to move with respect to the second knife edge creating a schlieren pattern on the screen of the second camera due primarily to the density gradients in the bulk of the liquid. With some perseverance it is even possible to record both schlieren patterns on the screen of a single camera as shown by the accompanying illustration.

In conclusion, while the theory and applications of shadowgraphs and schlieren systems seem to have been exhausted and the processes described in great detail by a great number of workers in this field, I hope that the material which you have heard discussed and seen demonstrated in this workshop has helped to introduce you to some of the basic concepts associated with these often misunderstood techniques. Although I probably could not help with mathematical modeling of these systems, if I may be of further help in any other way please do not hesitate to write to me at the Photo Tech Department at RIT or simply call me at (716)475-2592.

