

# Distributed Automation System Based Remote Monitoring of Power Quality Disturbance on LV Network

Emmanuel D. Buedi, K. O. Boateng, Griffith S. Klogo

**Abstract**—Electrical distribution networks are prone to power quality disturbances originating from the complexity of the distribution network, mode of distribution (overhead or underground) and types of loads used by customers. Data on the types of disturbances present and frequency of occurrence is needed for economic evaluation and hence finding solution to the problem. Utility companies have resorted to using secondary power quality devices such as smart meters to help gather the required data. Even though this approach is easier to adopt, data gathered from these devices may not serve the required purpose, since the installation of these devices in the electrical network usually does not conform to available PQM placement methods. This paper presents a design of a PQM that is capable of integrating into an existing DAS infrastructure to take advantage of available placement methodologies. The monitoring component of the design is implemented and installed to monitor an existing LV network. Data from the monitor is analyzed and presented. A portion of the LV network of the Electricity Company of Ghana is modeled in MATLAB-Simulink and analyzed under various earth fault conditions. The results presented show the ability of the PQM to detect and analyze PQ disturbance such as voltage sag and overvoltage. By adopting a placement methodology and installing these nodes, utilities are assured of accurate and reliable information with respect to the quality of power delivered to consumers.

**Keywords**—Power quality, remote monitoring, distributed automation system, economic evaluation, LV network.

## I. INTRODUCTION

THE current technological advancement and sophistication has resulted in the computerization of domestic and industrial equipment, and hence, an increase in their sensitivity to the quality of power they depend on. Utility companies the world over have an additional mandate to ensure that the power they supply to consumers is free from disturbances. Total elimination of these disturbances from the distribution network has proven to be impossible. This is due to the complexity of the network and mode of operation of equipment connected to the network.

In order to resolve power quality (PQ) disturbances, utility

Emmanuel D. Buedi is with the Electricity Company of Ghana, Supervisory Systems Division, P.O.Box, 521, Accra, Ghana (phone: +233266188177, e-mail: inteldana09@gmail.com).

K. O. Boateng is with the Kwame Nkrumah University of Science and Technology (KNUST) Department of Computer Engineering, PMB, UPO, KNUST, Kumasi, Ghana (phone: +233203154862, e-mail: koboat\_2000@yahoo.com).

Griffith S. Klogo is with the KNUST Department of Computer Engineering, PMB, UPO, KNUST, Kumasi, Ghana (phone: +233244880568, e-mail: klogoselorm@yahoo.com).

companies rely on power quality monitors (PQMs) to detect and hence find solutions to the problem. To perform a complete evaluation of power quality disturbance in the network, the steps outlined in Fig. 1 can serve as a guide [1]-[5].

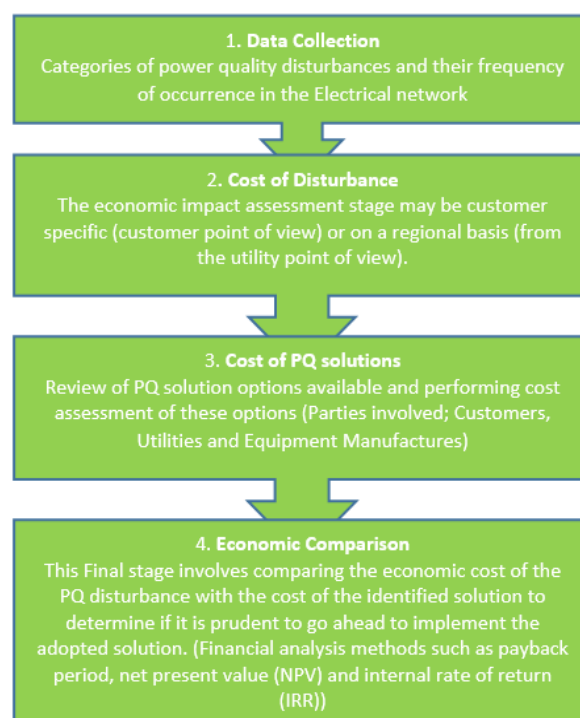

Fig. 1 Steps involved in performing a complete economic evaluation of power quality disturbance

The first step, which involves the collection of data on various forms of power quality disturbances and their frequency of occurrence, is very vital. Any error in this process affects the whole evaluation process.

The type of monitors and their mode of operation will have an impact on the data collected. Some power measurement and monitoring equipment such as energy meters have been equipped with secondary PQM capabilities.

The conventional method of placement of these energy meters is to install them on every feeder to check revenue losses in the network. References [6], [12], [13] show how network automation equipment such as RTU and energy meters can be upgraded to perform power quality monitoring. This may seem as a cheaper alternative for utility companies

but will end up affecting data collected. Factors affecting the decision and placement of this network equipment are mostly conventional and differ from placement methods for PQMs. This may end up increasing redundant data or reducing network coverage of the monitor. The availability of new monitor placement algorithms has proven to be efficient in using the minimum amount of monitors to provide a better network observability and reduced data redundancy at less cost [8]-[10]. There is therefore the need to focus on devices specifically designed and dedicated for monitoring PQ disturbances.

Power quality monitors and analyzers could come in the form of handheld, standalone or networked. The choice of a PQM to use depends on a number of considerations such as the type of disturbance and the purpose of measurement. Measurement equipment ranging from simple voltage or current meters to highly sophisticated analyzers and monitors are available. Fig. 2 categorizes this equipment depending on their mode of operation. Primary PQMs refer to equipment used purposely to measure or sample voltage or current parameters for analysis. This category of devices can be temporally or permanently installed in the electrical distribution network. Temporal PQMs refer mostly to handheld or easily movable devices used to measure or monitor disturbances in the network. They range from simple voltmeters, ammeters, oscilloscopes to sophisticated handheld analyzers such as the Fluke 435 series and AEMC 8435 PowerPad. These devices can be installed over a period and their recorded data can be viewed onscreen or downloaded onto a PC. Permanent PQMs on the other hand refers to the monitors that are permanently installed in the network. They are designed to operate autonomously with weather and power considerations in mind. They could be standalone or be monitored remotely over a communication network. Secondary PQMs may refer to any equipment designed to have additional features to measure voltage and current parameters for analysis. Devices that fall under this category include some (smart) revenue meters, IEDs and RTUs or FTUs. Primarily, revenue meters are designed to measure the amount of power consumed in KWh for billing purposes. RTU/FTU is used to monitor and control field devices on the distribution network. Since these devices are installed in the network, some manufactures have decided to include disturbance monitoring functionalities due to its importance to utility companies and consumers. Since power quality monitoring is not their primary function, the decision as to where to install these devices in the network may render the PQ data recorded less relevant.

Individual consumers or industries can use handheld or standalone monitors at their premises, but for utility companies, the networked monitors are preferred. Most utility companies can make use of their existing DAS infrastructure to provide connectivity to the PQMs. Data collected from the monitors is centralized making analysis faster and easier.

This study presents an overview of a dedicated PQM capable of integrating into an existing DAS infrastructure. This work focuses more on voltage sags since it has been

identified as the most important power quality problems affecting industries and large commercial customers [1]. A portion of an existing network is modeled and analyzed using the SimPowerSystem toolbox in MATLAB. The monitoring unit of the designed PQM is implemented and installed in an LV network over a period of time.

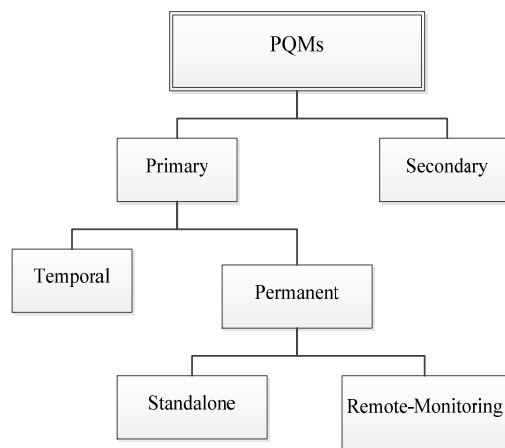

Fig. 2 Categorization of power quality monitors

This paper is organized as follows. Section II discusses the various PQ disturbances available in the electrical network. The overview of the designed PQM is presented in Section III. In Section IV, the model of a portion of the network is presented and the outcome of the simulation is analyzed. Finally, real-time data gathered from the PQM installed in the network is presented in Section V.

## II. POWER QUALITY DISTURBANCES

A number of problems regarding the quality of power delivered by utility companies can be identified [2], [4], [5]. Voltage sags/dip, voltage swells, under voltage, interruption, transients, voltage unbalance, voltage fluctuations and harmonics are some major power quality problems in a distribution network. These system disturbances are categorized by factors such as magnitude of disturbance and duration. Among these disturbances, voltage sag and momentary interruption have been identified as the most important in terms of their impact on equipment operations [1], [7], [11].

### A. Voltage Sag

Voltage sags refers to the reduction in magnitude of voltage level between 10% to 90% of the RMS and last for duration of 8 milliseconds to 60 seconds. The causes of voltage sags can be categorized into two main types: consumer side and utility side.

At the consumer side, voltage sags can arise during the startup of large loads such as industrial motors or by electrical faults. There is a significant instantaneous drop in voltage level due to the large initial current drawn by these loads.

At the utility provider's end, causes of voltage sags includes: operation of reclosers and circuit breakers,

equipment failure due to overloading or cable faults, thunder storms or lightning, salt spray that builds up around conductors close to coastal areas and animals or birds coming into contact with electrical distribution equipment.

#### B. Overvoltage

Overvoltage refers to an increase in the AC supply voltage in the electrical distribution network for a period of time. Depending on the magnitude of increase and duration, overvoltage can be classified into two main categories.

Momentary overvoltage or voltage swell refers to RMS variation that exceeds 110% of the nominal voltage and last for the duration of 0.5 cycles to 60 seconds. This is usually caused by faults or brief interruption of power lines. Long duration overvoltage on the other hand refers to RMS variations that exceeds 110% of the nominal voltage and lasts for more than 60seconds.

They are usually caused by wrong transformer tap settings, decrease in load on a phase, lightning and switching of a capacitor bank connected to the network.

#### C. Interruption

Interruption refers to a complete loss of voltage or load current in one or more phases of a source. Depending on the duration, interruption can be grouped into three main categories. These include momentary interruptions, temporal interruptions and sustained interruptions. Momentary interruption refers to loss of voltage for a period of between 8 milliseconds and 3 seconds. Temporal interruption refers to a drop of voltage below 10% of the nominal voltage level (i.e. < 23VAC) for a period of between 3 seconds and 60 seconds. Sustained interruption refers to continues loss of voltage for more than 60 seconds in an electrical system. The economic impact of these interruptions ranges from permanent loss of data on a computer to massive damage of industrial equipment. Three seconds of power interruption can cause damage that will require more than 7 hours to repair.

#### D. Transient

Transient refers to a sudden increase or decrease of electrical current or voltage that dissipates in a short duration. Impulsive transient refers to a sudden increase or rise in voltage or current in an electrical system in the negative or positive direction. The sudden rise to a peak and decay to nominal value takes place in less than 50 nanoseconds. Lightning, electrostatic discharge and switching of inductive loads are some of the identifiable causes of impulsive transients or "spikes". Mounting of lightning arresters and proper grounding of transformers and other electrical distribution equipment are some solutions to this problem. Oscillatory transient do not decay quickly, but rather oscillate for 0.5 to 3 cycles at the nominal frequency.

### III. DESIGN OF PQM WITH REMOTE MONITORING FUNCTION

Data gathered from PQMs serves as a vital source of information during decision making in the quest for a solution to disturbances in the network.

The main aim of remote monitoring is to ensure that real-time data gathered is made available instantly for analysis by system operators. Fig. 3 gives a design of a PQM with remote monitoring features.

The system consists of PQMs installed at monitoring points on the network and sending data to a centralized location. This follows a typical distributed automation system (DAS) architecture, which is already common in the electrical distribution sector. Hence, this system can easily be integrated into an existing AMR or SCADA system.

The monitor consists of the power supply unit, the control unit and the sensor board. The power supply unit ensures that the system gets the right voltage level for its operation. It also has battery backup to keep the system running in case of a long duration interruption. The sensor board consists of current and voltage sensors to pick analog data from the monitoring point in the network for the control unit.

The control logic board also makes use of the ADE7558 IC, which is a high accuracy 3-phase electrical energy measurement IC with a serial interface and two pulse outputs. This IC can measure RMS voltage and current, active/reactive/apparent energy, frequency and sampled waveform data; it also contains a circuitry for overvoltage and voltage sags with programmable thresholds. When these thresholds are exceeded, the IC generates a fault alert, which serves as an interrupt for the microcontroller. Fig. 4 shows the flowchart of the system.

The program starts by initializing the ADE7758 IC and the second memory unit (Mem 2). This process calibrates the ADE7558 IC by setting the thresholds for voltage sags and overvoltage. The ADC attached to the controller constantly monitors and digitizes the AC signal into Mem 1. This data is transmitted intermittently to the server. The ADE7758 IC also monitors the AC signal for any abnormalities. If any fault is detected, the controller is alerted and the digitized faulty signal is transferred into Mem 2 for immediate transmission. The memory units are cleared after every data transmission.

These units communicate with the control center the same way as RTUs and AMR meters. The servers at the monitoring station intermittently polls the units to read information. The units are also set to transmit immediately new and urgent information to the servers.

Fig. 5 shows a typical communication network overview of the setup for the control center and PQMs installed in the electrical network. To maintain uniformity and conform to industrial standards, the data sampled by the PQM is formatted into an IEC 60870-5-101 frame, as shown in Fig. 6, before transmission to the server.

### IV. MODEL OF THE NETWORK

A portion of the distribution network of the Electricity Company of Ghana showing the power supply from the substation to the end user is shown in Fig. 7. The standard voltage levels in the network and the PQ monitoring points are indicated in this diagram.

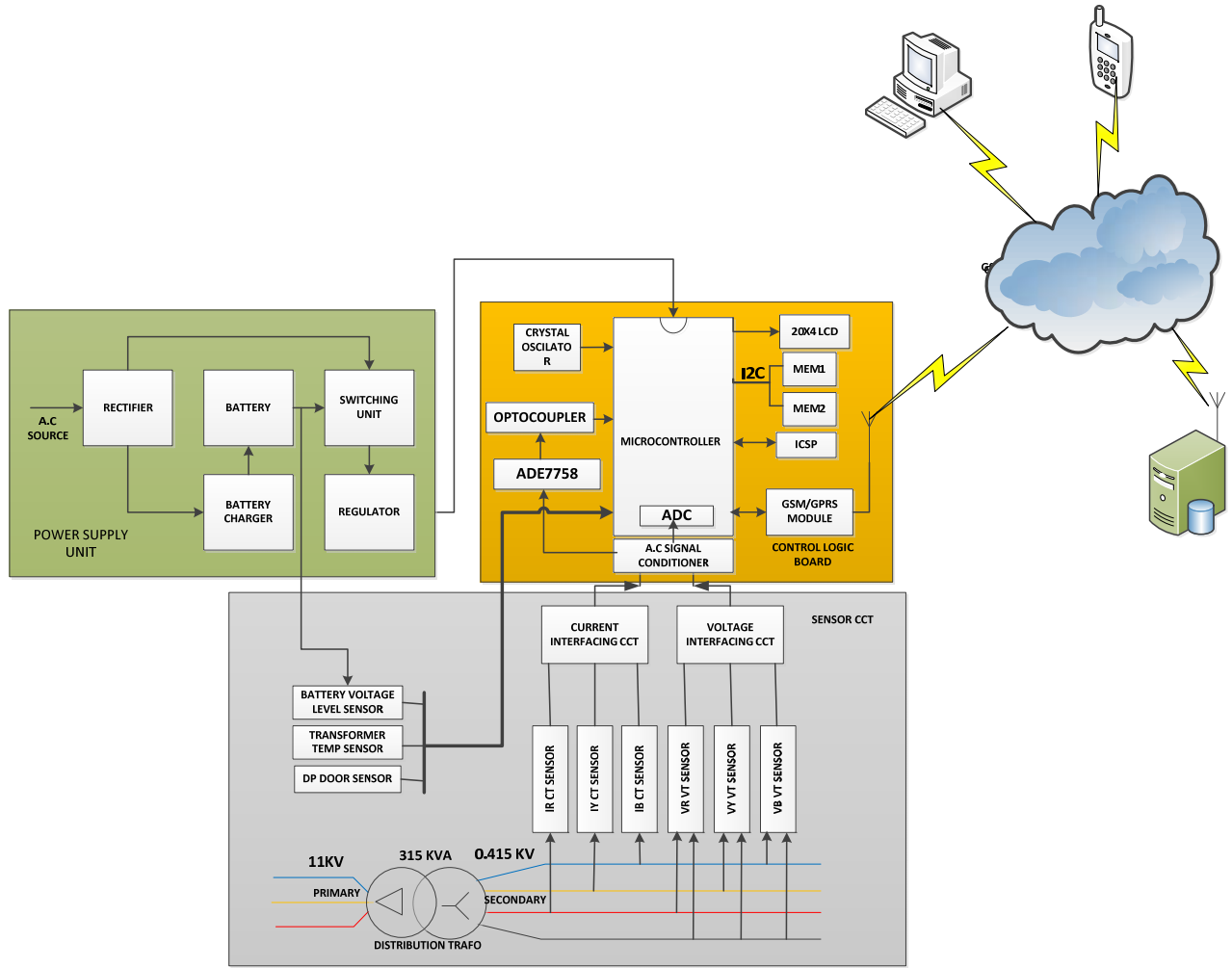

Fig. 3 Design of PQM

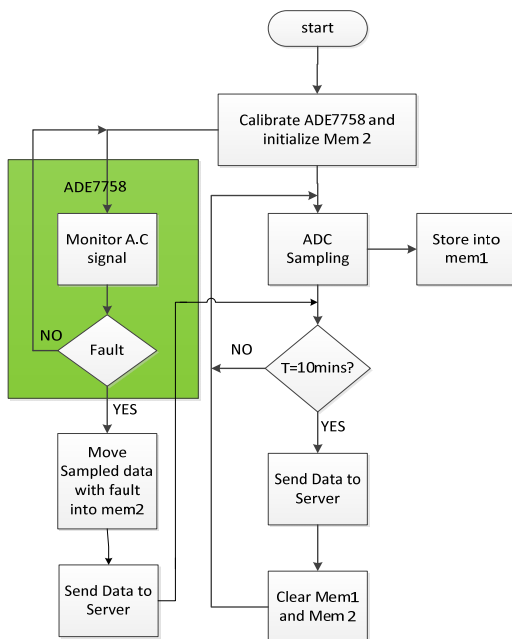

Fig. 4 Flow chart for controller

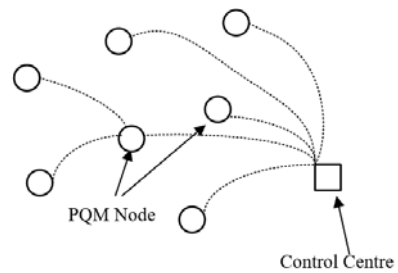

Fig. 5 PQM network setup

The SimPowerSystem library in Simulink provides a comprehensive set of models for the components required in this work and has been used to generate a model for the circuit given in Fig. 7. The Three-Phase source block implements a balanced three-phase voltage source with internal R-L impedance. The source used in this work has 11000VAC phase-to-phase RMS, frequency of 50Hz, source impedance of 0.8929 and inductance of 16.58e-3. Three-Phase Breaker block implements a three-phase circuit breaker where the opening and closing times can be controlled either from an external Simulink signal (external control mode), or from an internal control timer (internal control mode). The Three-

Phase Transformer (Two Windings) block implements a three-phase transformer using three single-phase transformers which steps down the voltage from the source to 415VAC. The Three-Phase Fault block uses three Breaker blocks that can be individually switched on and off to program phase-to-phase faults, phase-to-ground faults, or a combination of phase-to-phase and ground faults. The time for the fault to occur can be controlled internally or externally. The customer facility is represented by a series RLC branch. The Series RLC Branch block implements a single resistor, inductor, or capacitor, or a series combination of these. The values of each parameter can be set to give a representation of the customer's load

characteristics. The voltages and currents at various stages in the circuit are monitored by the Three-Phase V-I Measurement block and the scopes. Results of simulation carried out on the model presented in Fig. 8 are presented in this section. The Fault block is set to introduce an earth-fault into the network from  $t=0.1$  to  $t=0.2$  during the simulation. The results of an earth fault on the yellow phase are presented in Fig. 9. This leads to a momentary interruption on the yellow phase and voltage increase on the other phases. Fig. 10 presents a two-phase bridging fault between the yellow and blue phases. This fault causes a voltage sag on both phases and the red phase is not affected.

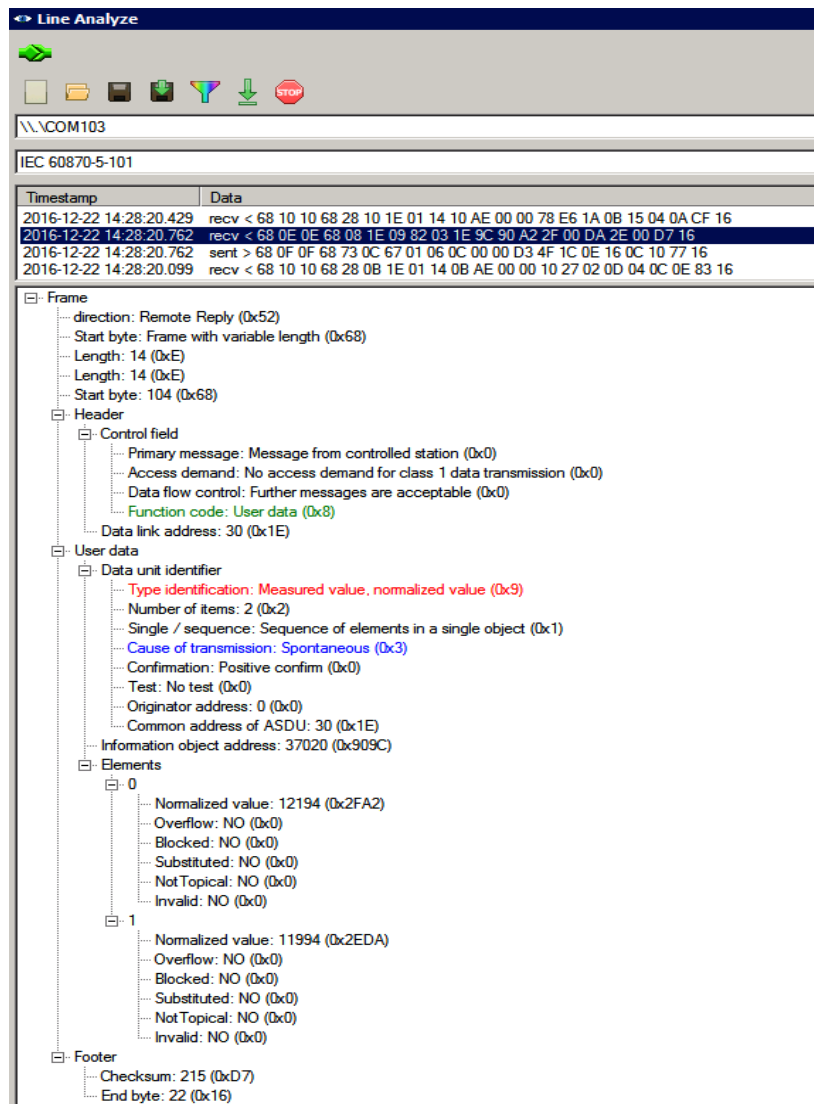

Fig. 6 Format of sampled analog data sent to server

Fig. 11 shows the behavior of the model output under different sampling rates. From this figure, it can be observed that the signal starts to deviate considerably for rates below 0.5 kHz. Any rate above this threshold is enough to represent accurately the signal for analysis.

The RMS profile for an AC signal is a preferable way to represent signals for analysis and comparison. The logic of the

PQM is then set to report any RMS value below 0.9 pu as voltage sag. The output RMS profile of the PQ disturbance from the LV network is given in Fig. 12. This shows how the PQM interprets a voltage sag event.

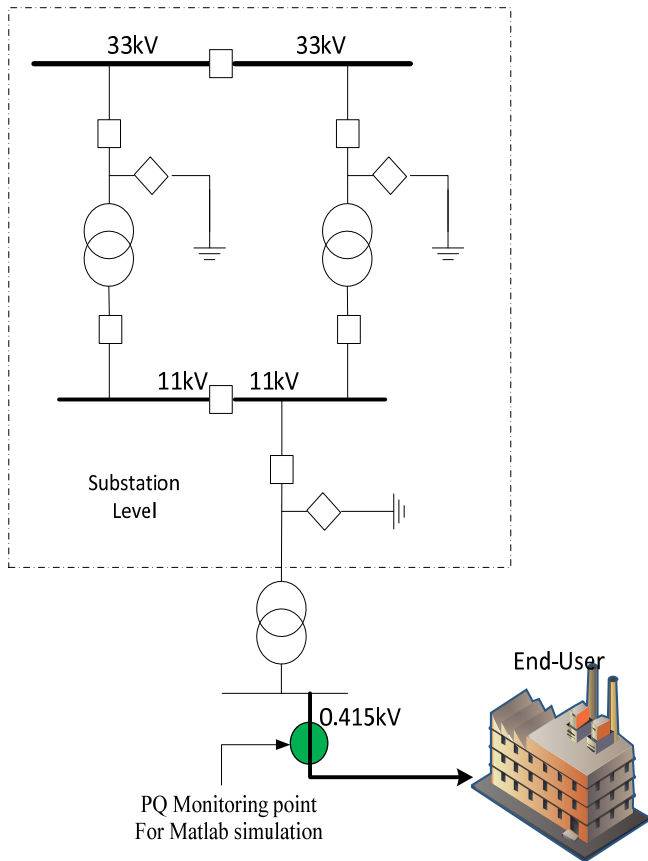

Fig. 7 Single Line Diagram describing energy supply from substation to End-user facility

## V. RESULTS AND DISCUSSION

To assess the performance of the designed PQM in a real environment, the monitoring unit of the PQM is implemented and subjected to data with PQ disturbances from an existing LV network, as shown in Fig. 14. A normal single-phase voltage signal captured from the network is presented in Fig. 13.

With a sampling rate of approximately 2 kHz, this monitoring unit is able to capture the voltage waveform in good detail for analysis. Data presented in Fig. 15 shows the various instantaneous voltage levels sampled and corresponding RMS calculated with a window of 10 units. The corresponding graphical output of this data is presented in Fig. 14.

## VI. CONCLUSION

This paper has identified and presented the reasons for utilities to invest into DAS-based PQMs as opposed to secondary PQMs. A proposed design of this recommended type of PQM has been presented and the monitoring unit of this design has been implemented. This work also presents the Simulink module of a portion of an existing network and simulates various short circuit faults. Results in both cases show the ability of the system to detect and analyze disturbance in the signal waveform. Utilities can deploy these PQM nodes in their network based on a chosen optimal placement algorithm and hook it onto an existing SCADA or AMR communication infrastructure. Data received from these nodes can be used as inputs for economic evaluation of power quality disturbance in the network.

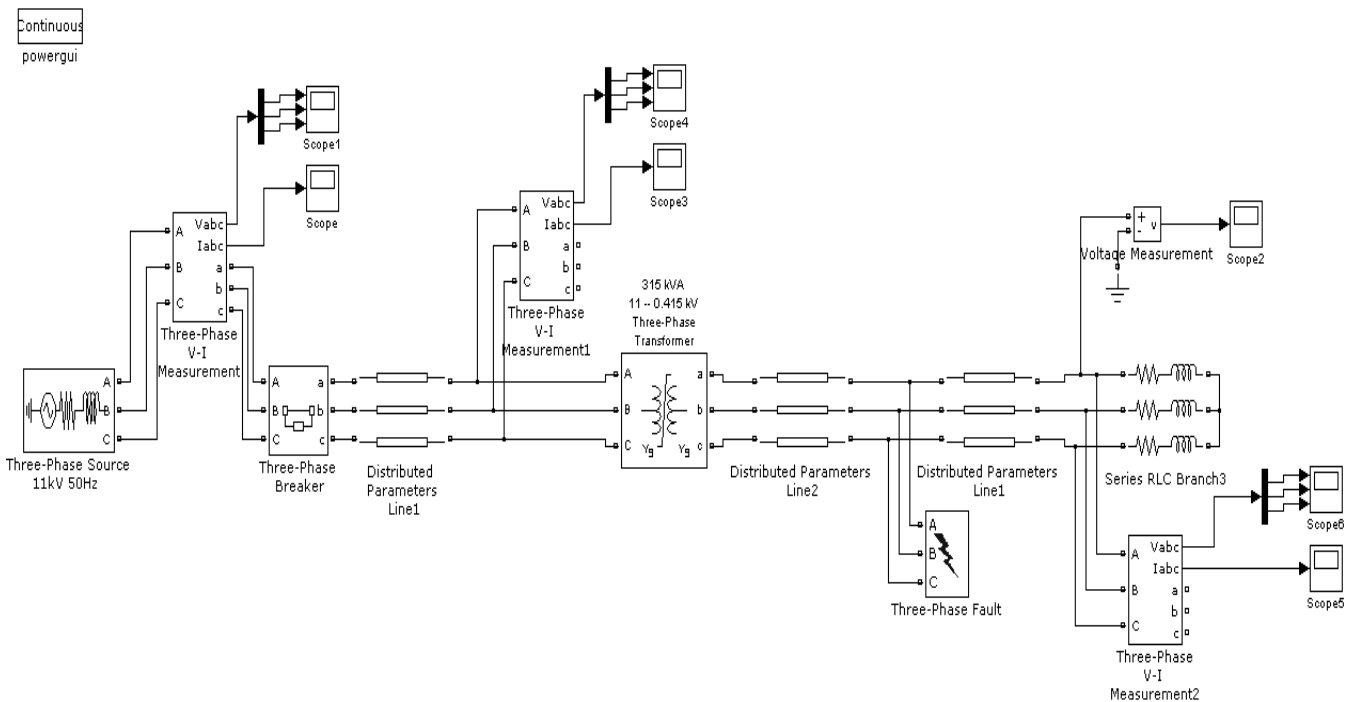

Fig. 8 MATLAB model of electrical network with earth fault

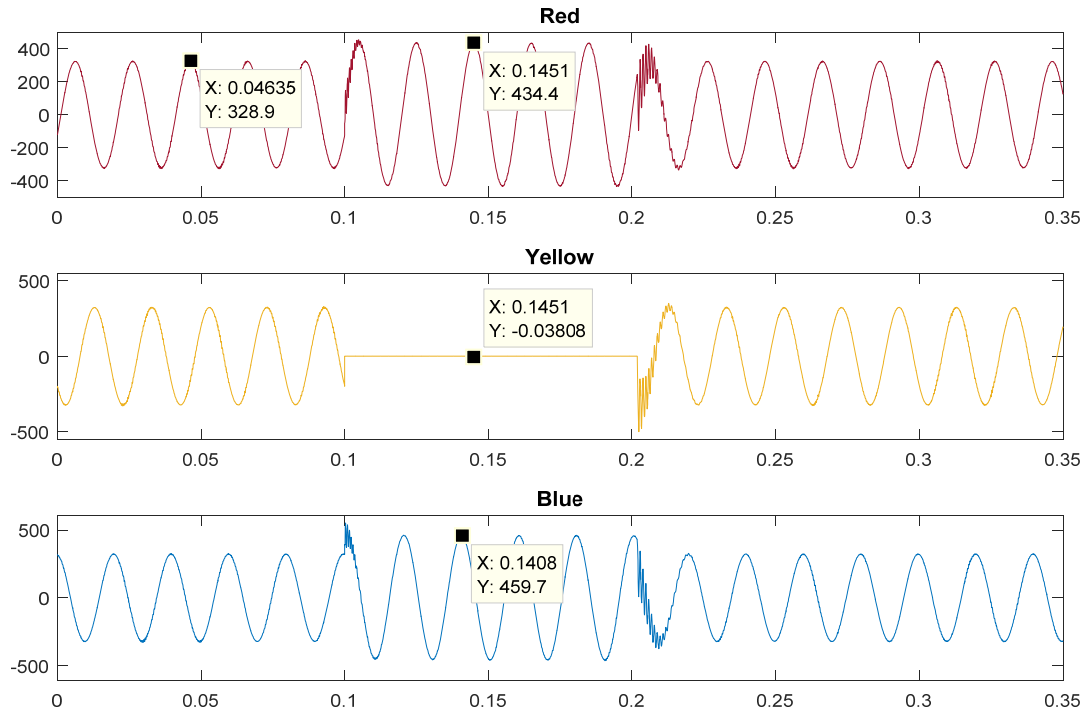

Fig. 9 Earth Fault on the yellow phase for  $V_{peak}$  value of 328.9

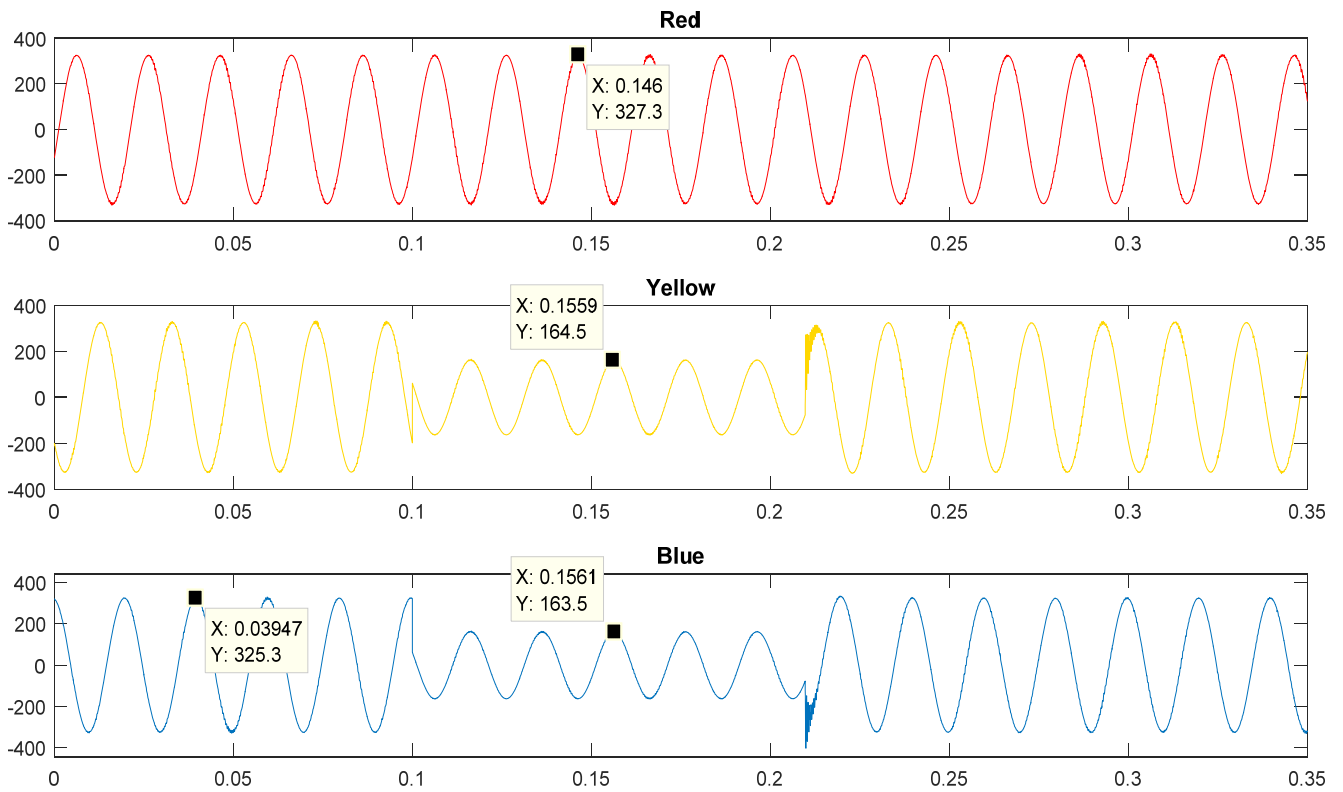

Fig. 10 Short circuit fault between yellow and blue phase

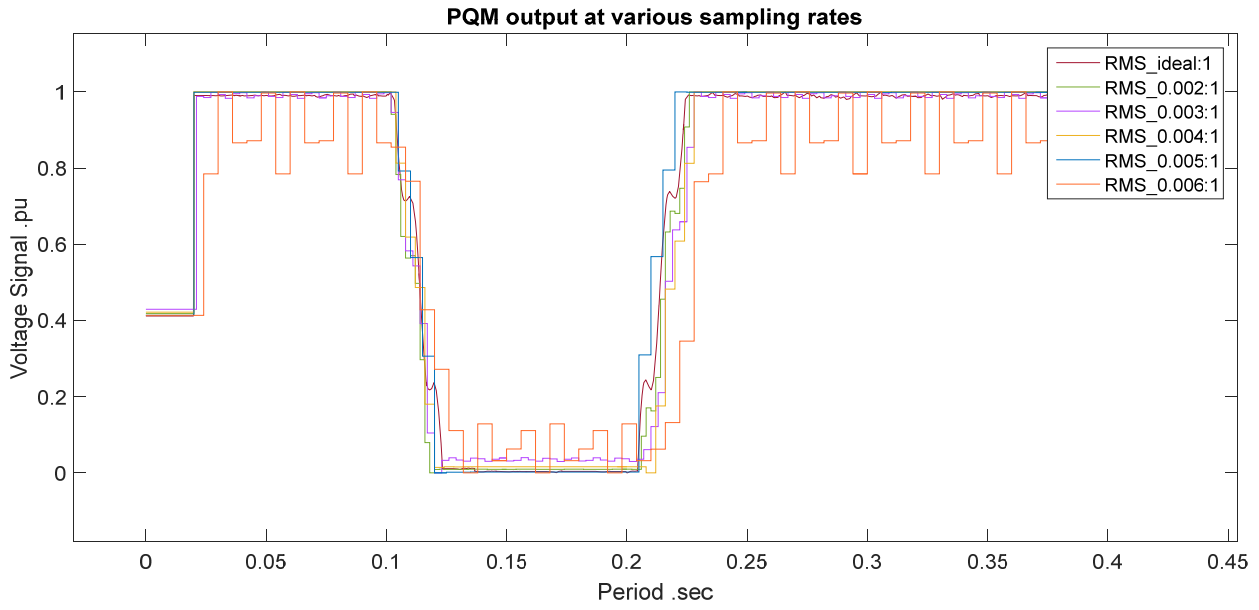

Fig. 11 PQM outputs at various sampling rates

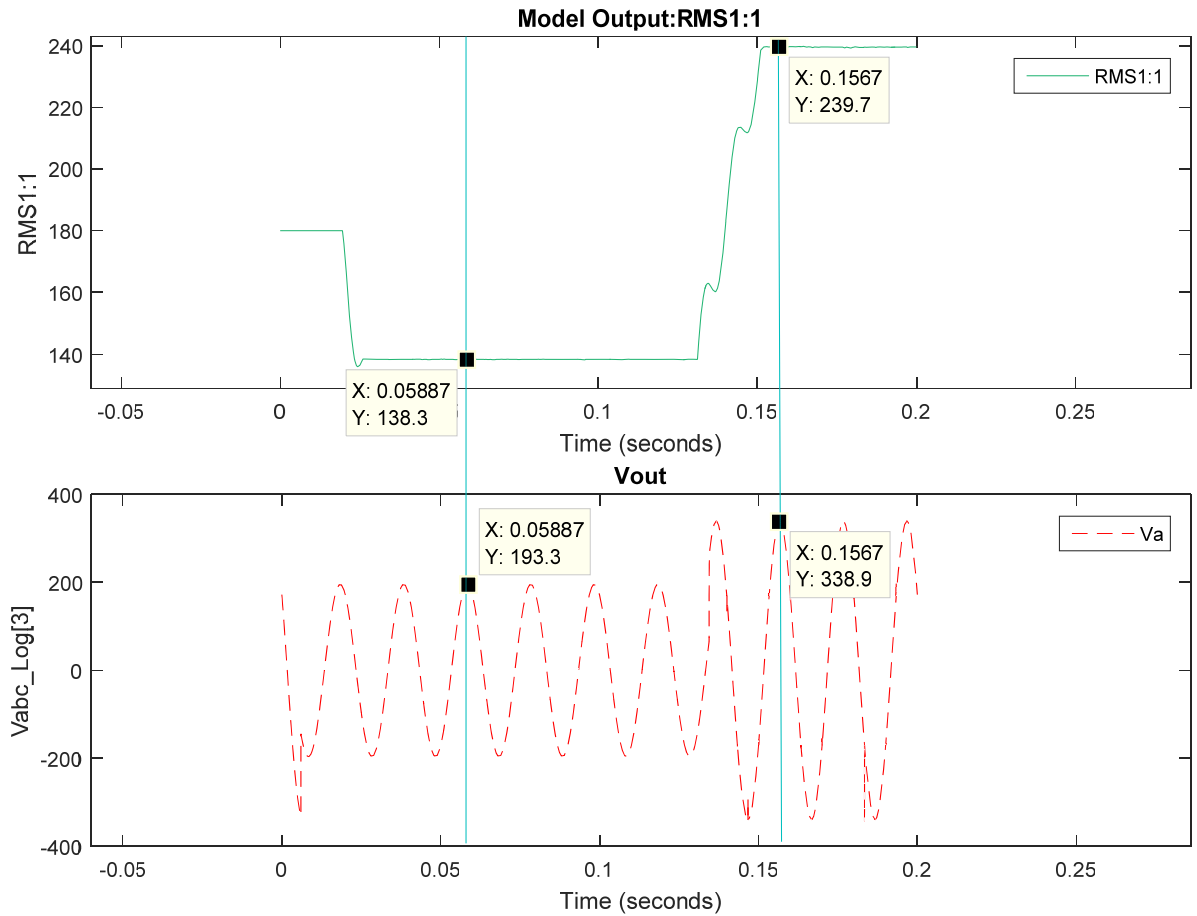

Fig. 12 PQM output RMS profile for voltage sag



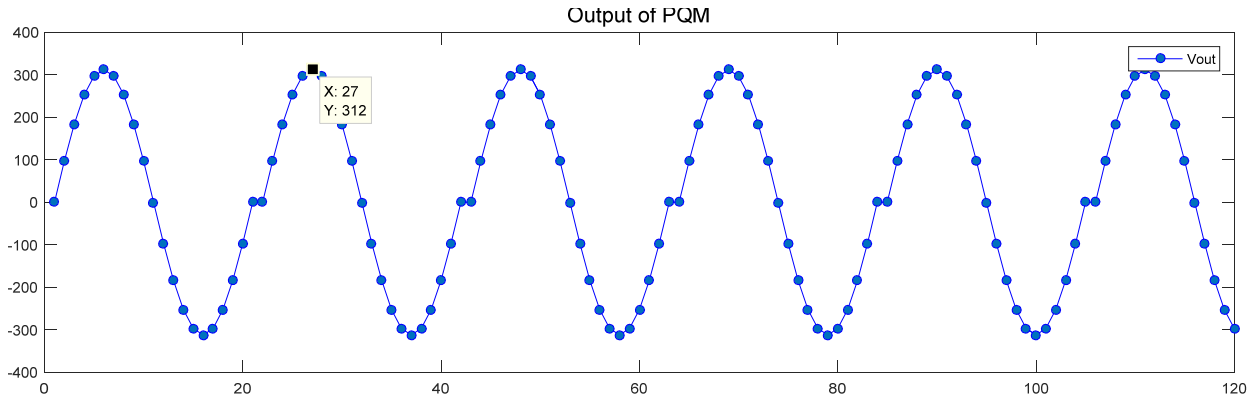

Fig. 13 PQM output for real-time voltage signal from an existing single-phase LV network

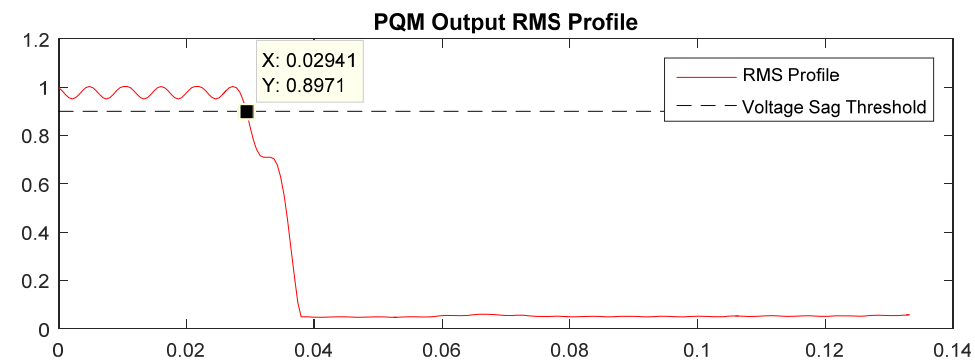
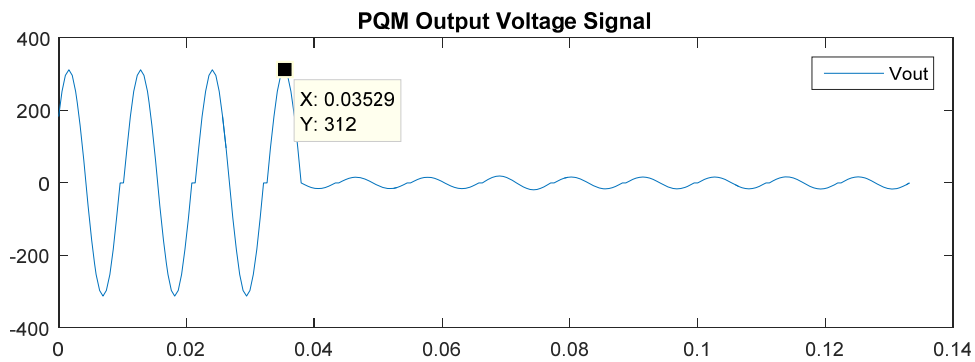

Fig. 14 Voltage sag disturbance captured by PQM

ts	0.030481	0.031016	0.031551	0.032086	0.03262	0.033155	0.03369	0.034225	0.034759	0.035294
Vout	-252.7	-183.7	-96.4	0.0	0.0	95.4	181.4	249.4	299.7	312.0
Vrms	0.783409	0.740363	0.71663	0.70996	0.709977	0.709977	0.703181	0.678045	0.627705	0.550653
ts	0.035829	0.036364	0.036898	0.037433	0.037968	0.038503	0.039037	0.039572	0.040107	0.040642
Vout	296.7	251.9	178.4	98.4	0.0	-4.4	-9.8	-12.6	-14.8	-15.6
Vrms	0.450426	0.334927	0.215835	0.109572	0.0499	0.05014	0.0499	0.049267	0.048472	0.047819
ts	0.041176	0.041711	0.042246	0.042781	0.043316	0.04385	0.044385	0.04492	0.045455	0.045989
Vout	-14.1	-12.6	-9.2	-4.8	0.0	0.0	4.8	9.2	12.6	14.8
Vrms	0.047567	0.047819	0.048472	0.049267	0.0499	0.05014	0.05014	0.0499	0.049267	0.048472
ts	0.046524	0.047059	0.047594	0.048128	0.048663	0.049198	0.049733	0.050267		
Vout	15.6	14.8	12.6	9.7	4.1	0.0	-4.8	-9.2		
Vrms	0.047819	0.047567	0.047819	0.048472	0.049267	0.0499	0.05014	0.0499		

Fig. 15 Data from the LV network

REFERENCES

- [1] Mark McGranaghan, Bill Roettger (2002, Feb). Economic Evaluation of Power Quality. *IEEE Power Engineering Review* (Online). 22(2), pp. 8-12. (Accessed: 25-June-2015). Available: [http://ieeexplore.ieee.org/xpl/abstractMetrics.jsp?arnumber=981339&ranges=2002\\_2003\\_Year&searchWithin=%22Authors%22:QT.M.%20McGranaghan.QT](http://ieeexplore.ieee.org/xpl/abstractMetrics.jsp?arnumber=981339&ranges=2002_2003_Year&searchWithin=%22Authors%22:QT.M.%20McGranaghan.QT)
- [2] IEEE Recommended Practice for Evaluating Electric Power System Compatibility With Electronic Process Equipment, IEEE Standard 1346, 1998.
- [3] D. coll-mayor, j. Pardo, M. Perez-Donsion (2009, April). Analysis of Methodologies for the Economical Evaluation of Power Quality. International Conference on Renewable Energies and Power Quality (ICREPQ'09).
- [4] Barry W. Kennedy, "Power Quality Economics," in *Power Quality Primer*, New York: McGraw-Hill, 2000, pp. 239-271.
- [5] Heine, P., Pohjanheimo, P., Lehtonen, M., Lakervi, E (2002, May). A Method for Estimating the Frequency and Cost of Voltage Sags, *IEEE Transactions on Power Systems*, 17(2), pp. 290-296.
- [6] Boknam Ha, Shinyeol Park, Changhoon Shin, Seongchul Kwon, Soyeong Park, (2007, May). Power Quality Monitoring On Distribution Networks Using Distribution Automation System, *19th International Conference on Electricity Distribution (CIRED '09)*, Paper 0426.
- [7] Math H. J. Bollen (2000, October). *Understanding power quality problems: voltage sags and interruptions*. (Online). (Accessed: 25-June-2015). Available: <http://www.wiley.com/WileyCDA/WileyTitle/productCd-0780347137.html>
- [8] Ahmad Asrul Ibrahim, Azah Mohamed, Hussain Shareef, Sakti Prasad Ghoshal (2012, March). Optimization Methods for Optimal Power Quality Monitor Placement in Power Systems: A Performance Comparison. *International Journal on Electrical Engineering and Informatics - Volume 4(1)*.
- [9] Asadollah Kazemi, Azah Mohamed, Hussain Shareef, Hadi Zayandehroodi (2013). A Review of Power Quality Monitor Placement Methods in Transmission and Distribution Systems. *Przegląd Elektrotechniczny*, ISSN 0033-2097, R. 89 NR 185-188.
- [10] Ibrahim, A.A., A. Mohamed, H. Shareef. (2010). Optimal Placement of Voltage Sag Monitors Based on Monitor Reach Area and Sag Severity Index. *IEEE Student Conference on Research and Development (SCoReD)* pp.467-470.
- [11] Jeff Lamoree, Dave Mueller, Paul Vinett, William Jones (1994). Voltage Sag Analysis Case Studies. *IEEE Transactions on Industry Applications* 30(4) pp.1083-1089.
- [12] Michael Campbell, Neville Watson, Allan Miller (2015). Smart Meters to Monitor Power Quality at Consumer Premises. *EEA Conference & Exhibition*.
- [13] Shihui Yang, Fangfang Duan, Ke Li, Bin Li (2015). The Design of Smart Meter with Power Quality Monitoring. *International Conference on Applied Science and Engineering Innovation (ASEI)* pp1447-1450.