

Computational Fluid Dynamics Simulation and Comparison of Flow through Mechanical Heart Valve Using Newtonian and Non-Newtonian Fluid

D. Šedivý, S. Fialová

Abstract—The main purpose of this study is to show differences between the numerical solution of the flow through the artificial heart valve using Newtonian or non-Newtonian fluid. The simulation was carried out by a commercial computational fluid dynamics (CFD) package based on finite-volume method. An aortic bileaflet heart valve (Sorin Bicarbon) was used as a pattern for model of real heart valve replacement. Computed tomography (CT) was used to gain the accurate parameters of the valve. Data from CT were transferred in the commercial 3D designer, where the model for CFD was made. Carreau rheology model was applied as non-Newtonian fluid. Physiological data of cardiac cycle were used as boundary conditions. Outputs were taken the leaflets excursion from opening to closure and the fluid dynamics through the valve. This study also includes experimental measurement of pressure fields in ambience of valve for verification numerical outputs. Results put in evidence a favorable comparison between the computational solutions of flow through the mechanical heart valve using Newtonian and non-Newtonian fluid.

Keywords—Computational modeling, dynamic mesh, mechanical heart valve, non-Newtonian fluid, SDOF.

I. INTRODUCTION

MECHANICAL heart valves are constructed to imitate the function of the real heart valves found in human heart. Their fluid mechanics is an important part of research in bioengineering. Since their introduction about 60 years ago, many types of mechanical heart valves were designed. Nowadays, CFD has a big impact on this research [1].

At the start, there were two different approaches used for numerical simulations. The first approach did not take the interaction between leaflets and blood into consideration [2], [3]. These works were mostly focused on peak and near peak systole phase of cardiac cycle. Nowadays, this type of approach is not already used because software and hardware become powerful enough to simulate the interaction of blood and leaflets. On this topic, many works were published [4], [5]. Some of these works contained also comparison between numerical and experimental results. But, none of these works have shown the comparison between the use of Newton rheology model and non-Newtonian rheology model. Viscosity of Newtonian fluid changes only over temperature. However, the blood viscosity is a function of many other variables, e.g. shear rate [6]. Therefore, it is necessary to resolve whether non-Newtonian fluid properties can have any

D. Šedivý and S. Fialová are with the Faculty of mechanical engineering, Brno University of Technology, Technická 2896/2, 61669, Brno, Czech Republic (e-mail: 145706@vutbr.cz, fialova@fme.vutbr.cz).

potential impact on flow field in heart valve, which is the aim of this work.

II. METHODS

A. Mechanical Heart Valve

The real mechanical heart valve was used in this work – specifically the bileaflet model called Sorin Bicarbon Fitline. Its parameters are as follows: nominal size 23 mm, tissue annulus diameter (TAD) 23.4 mm, internal diameter (ID) 19.2 mm, orifice height (OH) 6.8 mm and effective orifice area (EOA) 2.07 cm². The opening angle is 80° and travel angle is 60° (see Fig. 1).

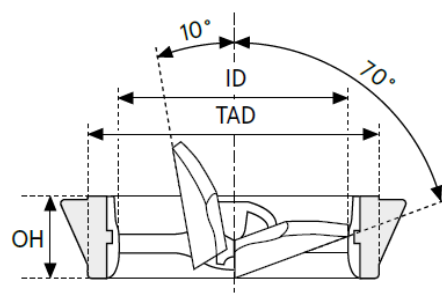

Fig. 1 Geometric parameters of mechanical heart valve [8]

Reverse engineering was used to gain geometry of mechanical heart valve for use in numerical solution. Resolution of CT scanner was 20 μm in any of three main directions. Shape of scan object is made by post-processing X-ray images by using contrast of shades of grey. Position of leaflets had to be constant during scanning. Glue that can be easily removed from the X-ray images was used for fixing the position. Originally, CT scans of two mechanical heart valves were made (first one is Sorin Bicarbon and the second one is Allcarbon Sorin, representing mechanical heart valve with a single tilting disc). However, the Allcarbon Sorin heart valve is made from different material, which causes artefacts in X-ray images, and therefore, it was not possible to create a 3D model of heart valve with tilting disc (see Fig. 2).

Contrast of shades was not satisfactory on X-ray images, and so, it was impossible to use automatic process for generating edges of surfaces on X-ray images, which means that whole process had to be done manually. 3D model of mechanical heart valve was generated as mesh of surface body in STL format file (see Fig. 3).

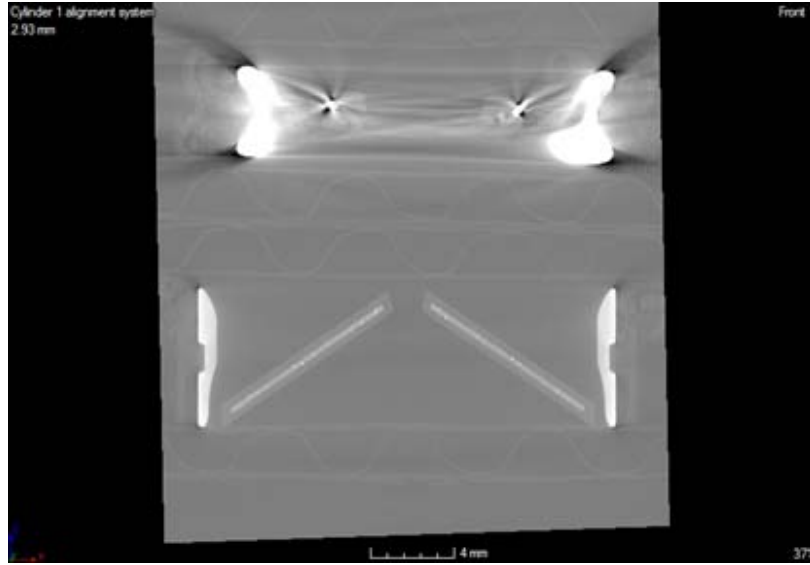

Fig. 2 X-ray image of mechanical heart valves



Fig. 3 Mesh from CT scanner

This model had to be adapted for need of CFD. Commercial 3D designer (SolidWorks) was used for these purposes. In Fig. 3, it can be seen that the model surface is made of many of tiny squares and is therefore not suitable for future work in CFD software. For this reason, the surface of the valve model was smoothed by few basic operations in SolidWorks. Also, problematic parts of geometry (holdings of leaflets) were removed (see Fig. 4).



Fig. 4 Adaptations of 3D model

B. Geometry, Mesh and Boundary Conditions

The geometry for CFD solution was made as inverse of 3D valve model in tube with constant diameter 21.4 mm. Distance between inlet and mechanical heart valve was 20 mm. Length of the whole domain was 100 mm. The geometry was sliced in

three parts for the calculation purposes (see Fig. 5). Mesh had to be redesigned during the solution because of big size of angular motion of leaflets. Mesh in first and third part is structured and consists of hexagonal elements. Mesh in second part of geometry is automatically generated and is made from tetrahedral elements.

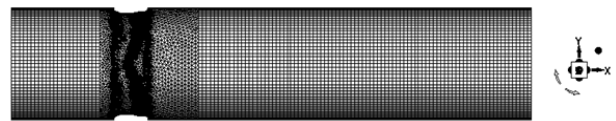

Fig. 5 Mesh of computational domain

Mesh had 1,636,245 of elements. Its maximum orthogonal skewness was 0.73 and it had maximum aspect ratio 17.3752.

All walls including the aorta wall were rigid. The combination of velocity condition on inlet and pressure condition on outlet is very common. But, the velocity or flow rate arises because of heart valve function. That is the reason why is pressure used in this work as boundary conditions on inlet. Both pressures (inlet and outlet) were set to simulate physiological conditions [1]. They are represented in Fig. 6.

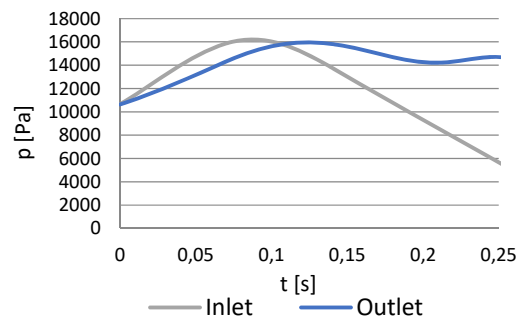

Fig. 6 Pressure boundary conditions

C. Fluid Properties

Blood is a heterogeneous fluid that can't be easily modeled. In this paper, blood is considered as an incompressible fluid (with constant density). The blood density was for numerical purposes set up as $1050 \text{ kg}\cdot\text{m}^{-3}$. Viscosity, the second important property of fluid, was defined for two different cases. The first one describes blood as Newtonian fluid, which means that shear stress is only function of viscosity and shear rate. Newtonian fluid has constant viscosity and its shear stress is formulated by Newton viscosity law:

$$\tau = \eta \cdot \dot{\gamma} \quad (1)$$

Dynamic viscosity had value $3.45 \text{ mPa}\cdot\text{s}$. This model is not ideal for blood modeling description, but it can be used for cases of flow with high magnitude of shear rate (see Fig. 7). The second model described blood viscosity more accurately. This rheology model belongs to non-Newtonian fluid and it is called Carreau [6]:

$$\eta = \eta_{\infty} + (\eta_0 - \eta_{\infty})[1 + (\dot{\gamma}\lambda)^2]^{\frac{q-1}{2}} \quad (2)$$

The comparison of these two viscosity models is depicted in Fig. 7.

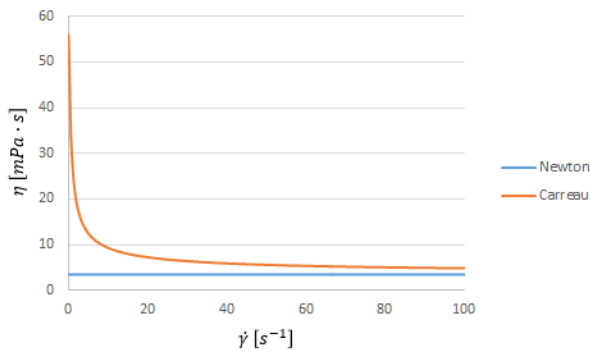

Fig. 7 Newton and Carreau viscosity model

TABLE I
UNITS FOR FLUID PROPERTIES

Symbol	Quantity	SI units	Value
τ	Shear stress	Pa	
η	Dynamic viscosity	Pa·s	0.00345
$\dot{\gamma}$	Shear rate	1/s	
η_{∞}	Dynamic viscosity for infinity shear rate	Pa·s	0.00345
η_0	Dynamic viscosity for zero shear rate	Pa·s	0.056
λ	Time constant	s	3.31
q	Carreau fluid coefficient		0.375

D. Experiment Setup

Experimental measurement of mechanical heart valve dynamics was done for comparison the speed of opening and closing in numerical solution. Scheme of experimental stand is shown on Fig. 8. The stand consisted of two tanks filled with water. Their main function was to keep constant static pressure during diastole. Heights of water surface altitudes above the valve correspond with diastolic pressure. Material of

pipeline is relatively stiff in comparison to material of blood vessels. Artificial heart was used as pump, generating a pulsatile flow. This artificial heart uses a flexible membrane for pumping. Five pressure sensors and one induction flowmeter were installed into the experimental stand. The first pressure sensor took values of pressure in pump intake. The fifth sensor monitored the operating pressure of diaphragm pump. The second and third sensors record data before and behind the mechanical heart valve.

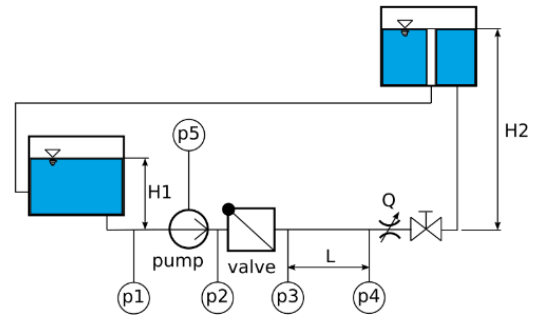

Fig. 8 Scheme of experimental stand

Induction flowmeter records only mean value of flow rate. Therefore, there was also the fourth pressure sensor installed in experimental stand. Transient flowrate was calculated from pressure differences between third and fourth pressure sensors by (3). Material of pipe polypropylene and its inner diameter was 21.2 mm , and the length between p_3 and p_4 was 134 mm . This equation was derived in [7].

$$Q_{i+1} = Q_i + \left(-R \cdot |Q_i| \cdot Q_i + \frac{p_{3i} - p_{4i}}{\rho}\right) \cdot \frac{S}{L} \cdot \Delta t \quad (3)$$

TABLE II
PARTS OF (3)

Symbol	Quantity	SI units
Q_{i+1}	Flow rate in next time step	$\text{m}^3\cdot\text{s}^{-1}$
Q_i	Current flow rate	$\text{m}^3\cdot\text{s}^{-1}$
R	Hydraulic resistance	$\text{m}^3\cdot\text{s}^{-1}$
p_{3i}	Current static pressure (position 3)	Pa
p_{4i}	Current static pressure (position 4)	Pa
S	Surface of pipe cross-section	m^2
L	Length between p_3 and p_4	m
Δt	Size of time step	s

III. SOLUTION AND RESULTS

Flow simulations were done by a commercial CFD software (ANSYS Fluent 18.1). Motions of heart valve leaves are time dependent so numerical solutions were calculated as transient and the size of time step was 0.0001 s . Simulations were solved for both types of liquid (Newton, Carreau). The flow in blood vessels has ordinary laminar character of flow, but in aorta Reynolds numbers are relatively high (up to 8000), which means that a turbulent flow occurs there. Therefore, a turbulent model had to be chosen. The values of Y-plus parameters were up to 6, meaning that 4-equation SST turbulence model was applied. Numerical simulations were solved by the dynamic mesh. Displacements were large in

these solutions; therefore, the meshes of computational domains had to be remeshed (number of elements changed during the simulation). Therefore, Smoothing and Remeshing methods, which are included in ANSYS Fluent, were applied. Diffusion parameter was defined as Cell-volume and its value was set equal to 0. Local cell and local face methods were used and maximum allowed value was 0.85 for cell skewness and 0.7 for face skewness. The remeshing interval was set to 1. Also, implicit update and six degrees of freedom (SDOF) were allowed in dynamic mesh options. Update interval in implicit update was equal to 1. Motion of heart valve leaf was simplified. Rotation of only one of the axis (z) was permitted, which means that leaflets had one degree of freedom. Leaflets were set as rigid bodies and their moment of inertia for rotation about z axis had value $5 \cdot 10^{-9} \text{ kg} \cdot \text{m}^2$. Rotation of leaflets was limited from 0° to 58° , because the initial leaflets position was opened on 2° . Valve was not closed as dynamic mesh does not allow contact of bodies (it would generate a mesh with negative cell volume). Values of velocity in direction of x axis and positions of leaflets were recorded during solutions.

From the results of numerical solutions, it is obvious that use of non-Newtonian fluid does not have any influence on the results of CFD calculation. In Fig. 9, it is possible to see angular position of leaflets (legend Newton and Carreau). Differences are very small, practically on the level of numerical mistake. Opening time of mechanical heart valves to fully opened state was 0.0564 s. The closing of heart valves began in case of Newtonian fluid earlier (time 0.1373 s) than in case of non-Newtonian fluid (time 0.1380 s). This was probably caused by viscosity forces which were in this time of the same order of magnitude as pressure forces, but for Carreau model they were a little bit bigger. Fully closed state had come in time 0.1734 s for solution with fluid with constant viscosity (for Carreau model it was $t = 0.1736 \text{ s}$). Time dependence of area average axial velocity is for both models of fluid almost the same (see Fig. 9). Maximal value of averaged axial velocity was 0.7725 m/s (in time 0.0965 s) for model of fluid with constant viscosity. In case of Carreau rheology model, area averaged axial velocity was equal to 0.7679 m/s (in time 0.0964 s). Difference of these values is also insignificant.

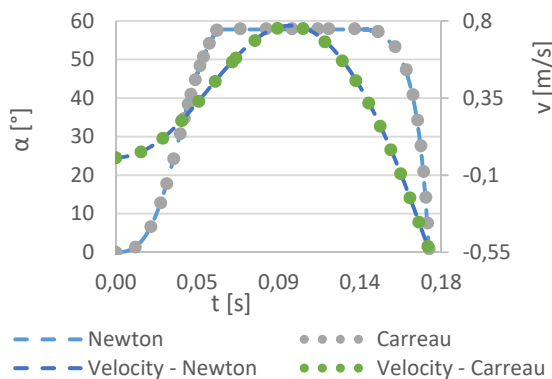

Fig. 9 Angular motion and axial velocity

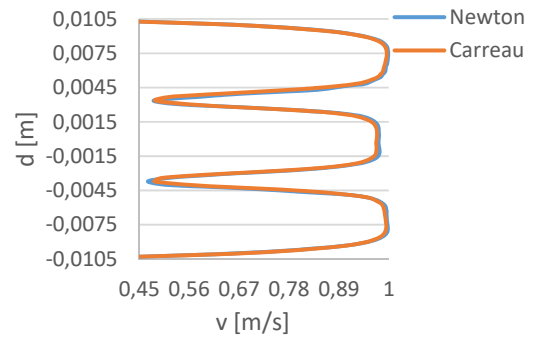

Fig. 10 2D axial velocity profiles

In Fig. 10, 2D axial velocity profiles for time 0.095 s and position 0.02 m are depicted behind the valve. It is evident that in case of Newtonian fluid, there are larger differences between maximal and minimal peaks. Bigger values of viscosity in Carreau model probably absorb the differences in local velocities. However, the velocity profiles are very similar and it is true for case of 3D velocity profiles (see Figs. 11 and 12).

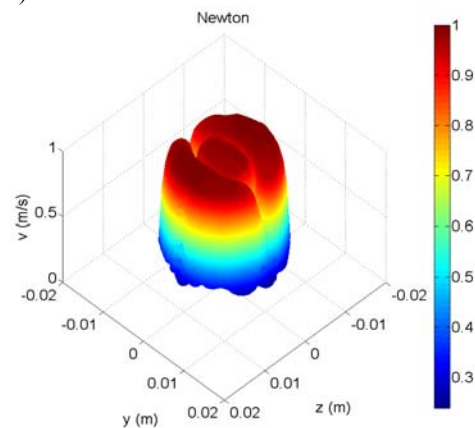

Fig. 11 Velocity profile for Newton rheology model

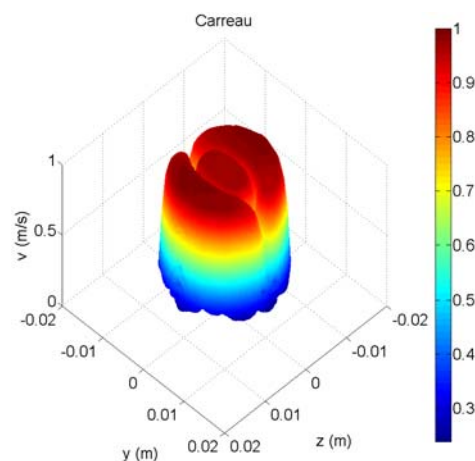

Fig. 12 Velocity profile for Carreau rheology model

Fig. 13 shows distribution of wall shear stress on leaflets surfaces in the case of Newtonian fluid, and Fig. 14 displays the same thing but for the case of non-Newtonian fluid. It is

obvious that the differences are also small and are practically negligible.

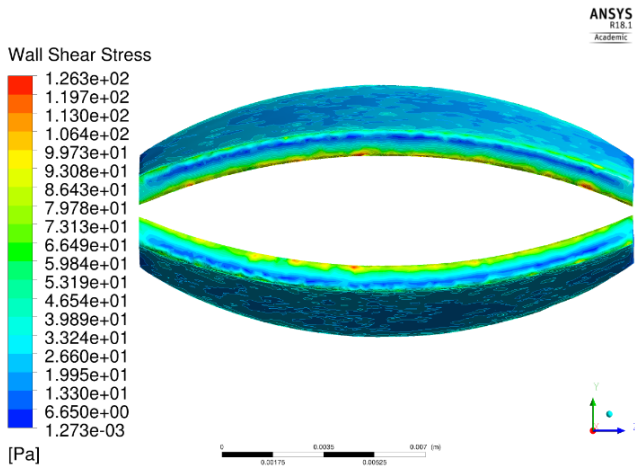

Fig. 13 Wall shear stress on leaflets for Newtonian fluid

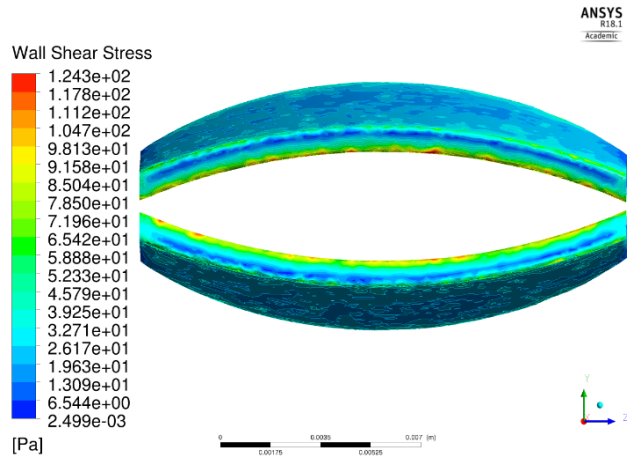

Fig. 14 Wall shear stress on leaflets for non-Newtonian fluid

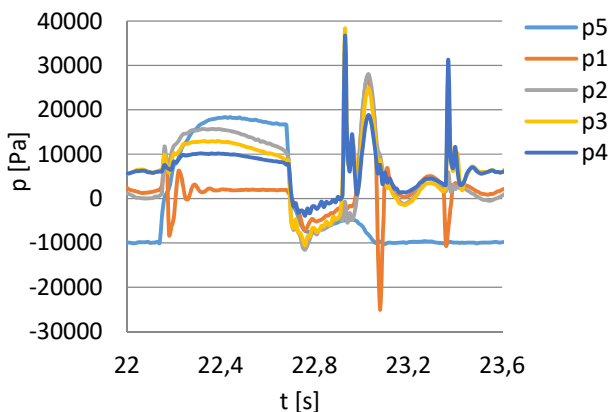

Fig. 15 Pressure records of one period of cycle

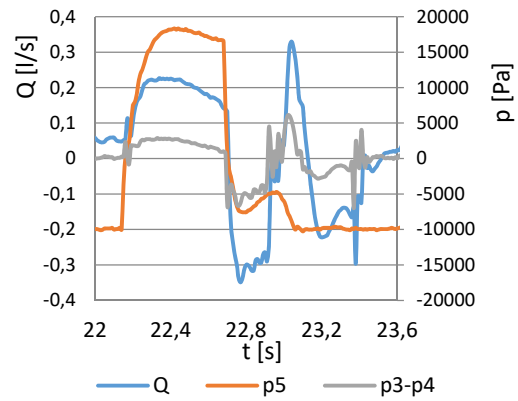

Fig. 16 Calculated flow rate from pressure differences

Experimental results (see Figs. 15 and 16) differ from the numerical ones widely. This is caused by difference between experimental and numerical setup. Both cases were solved for rigid (at least relatively rigid in experiment) material of pipe. However, the numerical solution was calculated for physiological values. Also, other dynamic effects were not included in CFD calculations. Experimental results were influenced by system dynamic of whole experimental stand. Artificial heart has its own valves, which caused dynamic pulsation (water hammer). Therefore, the results of experiment are useable only during the pump phase, because the values of pressure and flow rate are damaged by water hammers during the suction phase. For future work, a different, more pliable material of pipe (Tygon, silicon) should be used.

IV. CONCLUSION

Use of Carreau rheology model for describing of viscosity in blood does not have significant influence on results of CFD simulation of blood flow through mechanical heart valve. All the evaluated values (motion of mechanical heart valve leaflets, axial velocity, velocity profiles and wall shear stress) were practically the same in comparison to Newtonian rheology model with constant viscosity. Theoretically, this could be caused by turbulence model. Every turbulence model is more dissipative than laminar flow. Different results also could be gained by solving this problem with multiphase liquid. Experimental results were not satisfying, and in future, the experimental stand will have to be changed.

ACKNOWLEDGMENT

Grant Agency of the Czech Republic, within the project GA101/17-19444S, is gratefully acknowledged for support of this work.

REFERENCES

- [1] Chandran, K. B., Stanley E. Rittgers and A. P. Yoganathan. Biofluid mechanics: the human circulation. Boca Raton: CRC/Taylor & Francis, c2007. ISBN 0-8493-7328-x.
- [2] Grigioni, M., Daniele, C., Del Gaudio, C., Morbiducci, U., Balducci, A., D'Avenio, G., Barbaro, V., 2005. Three-dimensional numerical simulation of flow through an aortic bileaflet valve in a realistic model of aortic root. *Asaio Journal* 51 (3), 176–183.

- [3] Yokoyama, Y., Medart, D., Hormes, M., et al., 2006. CFD simulation of a novel bileaflet mechanical heart valve prosthesis: an estimation of the Venturi passage formed by the leaflets. *International Journal of Artificial Organs* 29 (12), 1132–1139.
- [4] M. D. de Tullio, A. Cristallo, E. Balaras and R. Verzicco. Direct numerical simulation of the pulsatile flow through an aortic bileaflet mechanical heart valve. *Journal of Fluid Mechanics*. Cambridge University Press, 2009, (622), 259-290. DOI: <http://dx.doi.org/10.1017/S0022112008005156>.
- [5] Guivier-Curien C., Deplano V., Bertrand E.: Validation of a numerical 3-D fluidstructure interaction model for a prosthetic valve based on experimental PIV measurements. *Med. Eng. Phys.* 31, 986 – 993 (2009).
- [6] Iasiello, Marcello, Kambiz Vafai, Assunta Andreozzi and Nicola BIANCO. Analysis of non-Newtonian effects on Low-Density Lipoprotein accumulation in an artery. *Journal of Biomechanics*. 2016, 49(9), 1437-1446. DOI: 10.1016/j.jbiomech.2016.03.017. ISSN 00219290.
- [7] Adamkowski, Adam, Zbigniew Krzemianowski a Waldemar Janicki. Improved Discharge Measurement Using the Pressure-Time Method in a Hydropower Plant Curved Penstock. *Journal of Engineering for Gas Turbines and Power*. 2009, 131(5), 053003-. DOI: 10.1115/1.3078794. ISSN 07424795.
- [8] Bicarbon Slimline (online). (2017-08-04). Available from: <http://www.livanova.sorin.com/products/cardiac-surgery/aortic/slimline>.