



FEEDBACK EQUALIZER FOR VEHICULAR CHANNEL

Samarendra Nath Sur^{1*}, Rabindranath Bera² and Bansibadan Maji³

¹Electronics and Communication Engineering Department, Sikkim Manipal Institute of Technology, Sikkim, India

²Electronics and Communication Engineering Department, Sikkim Manipal Institute of Technology, Sikkim, India

³Electronics and Communication Engineering Department, National Institute of Technology, Durgapur, West Bengal, India
Emails: samar.sur@gmail.com

Submitted: Dec. 5, 2016

Accepted: Jan. 20, 2017

Published: Mar. 1, 2017

Abstract- In this fast moving world, the number of fatal accidents is increasing day by day and this leads to the requirement of the availability of the traffic condition and road conditions related data to the users. Therefore, to support Vehicle-to-vehicle (V2V) communication in high speed mobility condition, it is required to have reliable and secure of communication. Here, the performance of multiple input and multiple output (MIMO) system as a combination of nonlinear decision feedback receiver (DFE) have been investigated in V2V channel. In this paper, through the simulation, the results are presented to show the effect of the channel correlation coefficient and Doppler shift (F_d) (because of the relative velocity of the vehicle) over the performance of the MIMO system. As a counter measure of those problems nonlinear receivers have been formulated and analyzed.

Index terms: DFE, Doppler Shift, MIMO, SCM, VANET.

I. INTRODUCTION

Now a day, V2V communications have received lots of attention due its requirement and utility to successfully implement the concept of ITS [1].

The aim of ITS is to improve the road safety by avoiding accident and goal of the wireless communication researchers is to reduce the traffic impact on the environment by improving the protocols, signal processing algorithms, etc. And also the demand of exchanging high rate multimedia information needs exploitation of advanced and secure communication system [2]. These requirements could be assured, by utilizing available wireless infrastructure technologies (IEEE 802.11a/b/n, 802.16, GSM, WCDMA, LTE), [3, 4]. Therefore, in this context MIMO with DFE receiver emerged as a possible solution to combat severe channel condition and improve the system performance.

During modeling of a V2V system some important physical scenarios to be considered, such as, dynamic behavior of environment, platform mobility, antenna height corresponding to communicating units. Similarly, in SCM-MIMO channel is designed considering various cases such as urban macrocell environment, suburban macro-cell environment and urban microcell environment [5]. It considered many parameters like propagation delays, F_d , angle of departure (AOD), angle of arrival (AOA), and spacing between the antennas in transmitter and receiver side. All these parameters are important to model more realistic and practical channel model.

Particularly in VANET, the power distribution and Doppler spectrum are non-uniform due to severe scattering environment. And along with this non-uniformity, mutual coupling between the antennas degrades the signal even more severely. As in SCM-MIMO model, for V2V communication [6], the objects in the channel such as buildings, trees, leads to the formation of inter symbol interference (ISI). These environmental effects lead to the challenges high BER due to Doppler shift degradation caused by high node mobility and correlated channel.

The organization of the paper is as follows. After the introducing section about the vehicular channel, the mathematical model for spatial channel, linear receiver and feedback receiver are presented in section II. The analysis and simulation results of the MIMO system in V2V channel has been discussed in section III. The paper has been concluded in section IV.

II. MATHEMATICAL MODEL

A. Spatial Channel Model (SCM)

The SCM for MIMO simulations is a basis for developing a real-time channel emulator. This model having 5 MHz bandwidth and utilize 2 GHz as center frequency [6]. In the 3GPP SCM model, each resolvable path is characterized by some parameters like, angular spread (AS), AoD, AoA, Power Delay Spectrum (PDS), power azimuth spectrum (PAS), Direction of Travel (DoT) [6,7]. The basic model for SCM provide less antenna correlation effect. In SCM designed with fixed subpath angles, whereas modified SCM method deals with random subpath angles. This model can be considered for V2V communication. A vehicular communication channel can be categorized as, Line of sight (LOS)—direct path between the transmitting and receiving antennas; Non-LOS due to vehicles (NLOS_v)—links whose LOS is obstructed by other vehicles; Non-LOS due to buildings/foilage (NLOS_b)—links whose LOS is obstructed by buildings etc. GEMV2, an effective channel simulator for V2V communication, that take care of all the path configurations in different environments such as highway, urban, suburban, and free space [8].

B. Linear Receiver

The linear receiver like ZF and MMSE [9] equalizers are fundamental blocks and are ubiquitously required to design low complex advanced receiver for MIMO system.

These linear detectors achieve suboptimal performance and because of their low complexity in the implementation they are widely used in practice. As per the linear receiver family is concerned, MMSE provides optimal solution with respect to another.

As per the ZF receiver is concerned, this simplest linear receiver deals with less computational complexity. It's able to minimize the interference, but in deep fed condition produce noise enhancement. The ZF receiver works best with high SNR level. Zero forcing implements matrix (pseudo)- inverse (+). The ZF receiver is

$$W_{ZF} = \left(H^H H \right)^{-1} H^H . \quad (2)$$

The MMSE equalizer (w_{mmse}) is governed by the fundamental relation as presented in the equation

$E\left[\|x - W_{mmse}^H y\|^2\right]$. The weight vector corresponding to the MMSE equalizer is given by

$$W_{mmse} = (H^H H + \rho^{-1} I)^{-1} H^H \quad (3)$$

MMSE detector maximizes the SNR. MMSE has better performance than ZF at low SNR because it suppresses both noise and interference components. Therefore, MMSE detector provides superior performance in comparison to the ZF detector in noisy environment.

C. Decision Feedback Equalizer

A simplified architectural overview of DFE [10], with QR decomposing algorithm has been investigated in this paper. The QR factorization technique is commonly used for DFE implementations because it leads to parallelizable and numerically stable implementations [10].

The concatenated channel matrix can be QR and expressed as

$$H = QR \quad (4)$$

Where Q is unitary (orthogonal matrix) and R is upper triangular. Householder algorithm is very popular in this regard [11]. In this work, modified Gram-Schmidt (MGS) algorithm has been considered because of its improved numerical stability.

Let, q_k be k^{th} column of matrix Q and q_k^H be its Hermitian. Again, $R(k, j)$ be the element in the k^{th} row and j^{th} column of R.

$$R = 0; Q = H$$

for $k = 0 : N - 1$

$$R(k, k) = \|q_k\|$$

$$q_k = q_k / R(k, k)$$

for $j = k + 1 : N - 1$

$$R(k, j) = q_k^H \cdot q_j$$

$$q_j = q_j - q_k / R(k, j)$$

end

end

Algorithm 1. Modified Gram-Schmidt Process

If the received signal y is projected onto the vector space spanned by the columns of Q ,

$$w = Q^* y = Rx + Q^* n = Rx + \bar{n} \quad (5)$$

$$\text{With } E[\bar{n} \bar{n}^*] = \sigma_x^2 I_{N_t}$$

Again, by using a DFE, w can be equalized. The foundation of feedforward filter is

$$K = [\text{diag}(R)]^{-1} \quad (6)$$

where $\text{diag}(R)$ is the diagonal matrix with elements same as the diagonal elements of R .

The feedback filter coefficients can be calculated by $B = I - KR$ (7)

B is nothing but an upper triangular matrix having zero diagonal elements.

The implementation of the one-shot QR decomposition enabled MIMO DFE systems is shown in Fig. 1.

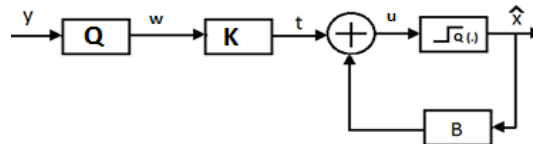

Figure 1 DFE architecture.

The MMSE-DFE receiver can be modeled following the same procedure, by decomposing (QR) the augmented matrix,

$$\underline{H} = \begin{bmatrix} H \\ \sigma I \end{bmatrix} \quad (8)$$

Where $1/\sigma$ is the SNR.

III. SIMULATION RESULTS

In this paper, before going to the vehicular channel, the utility of a MIMO system along with DFE receiver has been analyzed in Nakagmai channel condition.

By considering the largest eigenvalues of the correlation channel matrix, the probability distribution eigenvalues have been investigated. As, it is known to all that after the eigenvalue decomposition, the diagonal elements of the channel matrix represent the power distribution of the sub-channel of the MIMO system. Therefore, from Figure 2, one can make an idea about the channel quality of the MIMO system. Figure 2 depicts the eigenvalues variation for $m= 0.5$ with $SNR=0$ dB.

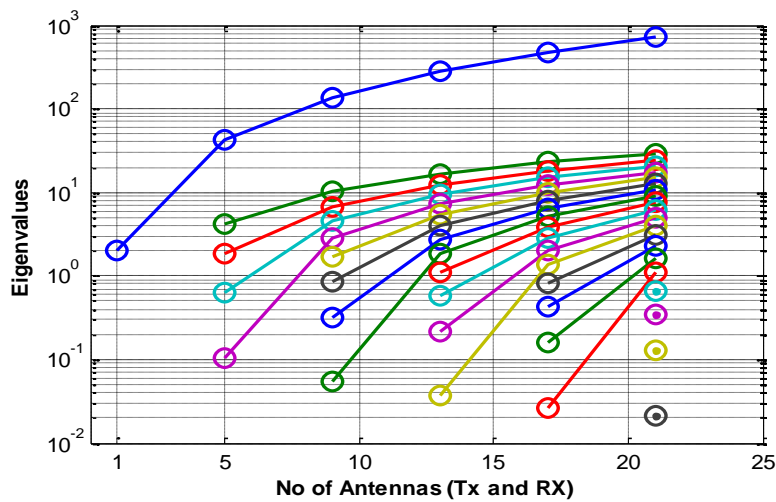

Figure 2. Distribution of eigenvalues for $N \times N$ MIMO.

In this section, the authors have analyzed the MIMO capacity under the influence of the SCM channel model. For the simulation purpose authors have considered only the case of suburban macro-cell scenarios here and some of the parameters are listed in Table 1.

Table 1. Simulation Parameters Considered during SCM channel modeling.

Parameters	Value or Description
Carrier frequency	2 GHz
No of BS antenna	2
No of MS antenna	2
BS antenna spacing	0.5λ

MS antenna spacing	0.5λ
No of paths (cluster)	4
No of sub-paths	20

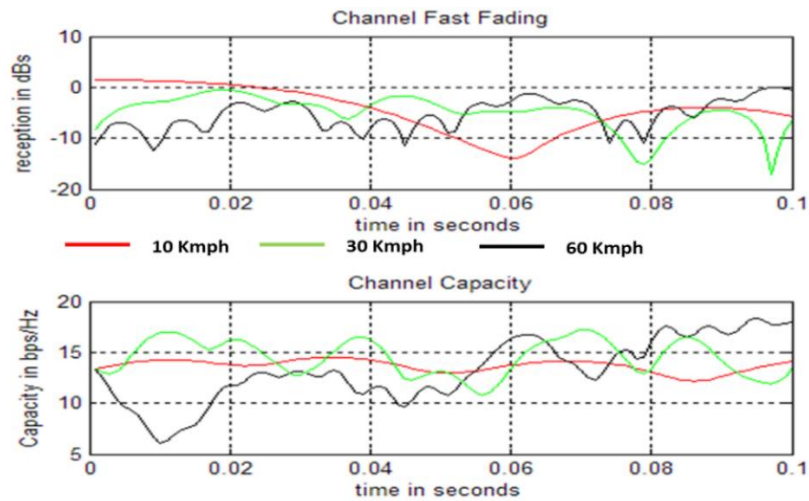

Figure 3. Capacity variation with vehicle velocity.

Figure 3 represents the variation in capacity with the change in vehicle speed. As shown in the figure with the change in velocity the channel fading characteristic changes drastically to severe fading channel and this leads to the rapid change in the capacity of the system. As represented, the vehicular motion makes the channel more time selective.

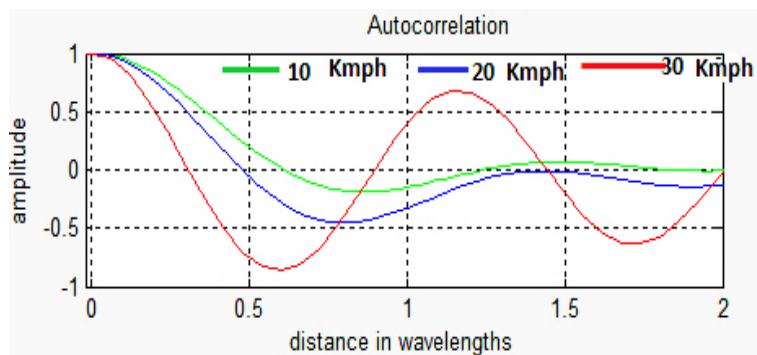

Figure 4. The temporal autocorrelation with different vehicle speed.

As in Figure 4, the vehicular speed has a significant effect on the autocorrelation function and that dependence, create a rapid fluctuation in channel fading characteristic. And this variation in the channel characteristic has significant influence on the average capacity of the system, as presented in Figure 5.

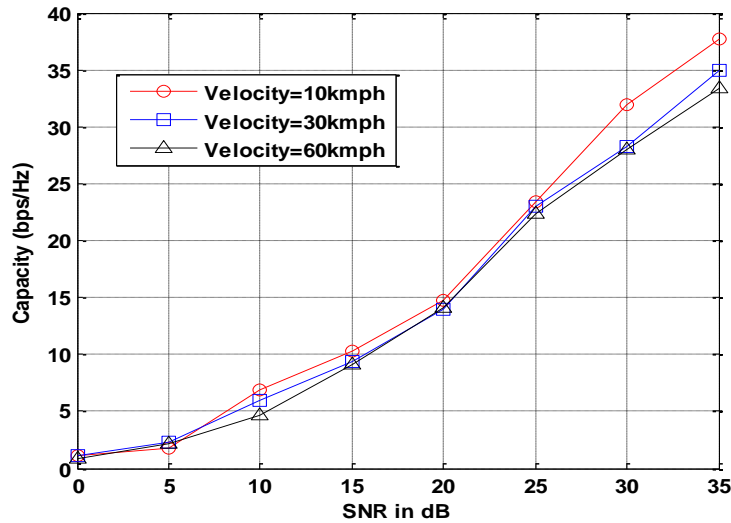

Figure 5. Impact of the vehicle speed over the average capacity.

The comparative performance of linear and DFE for MIMO system has been presented with the variation in the number of antennas and presented in Figure 6 and 7.

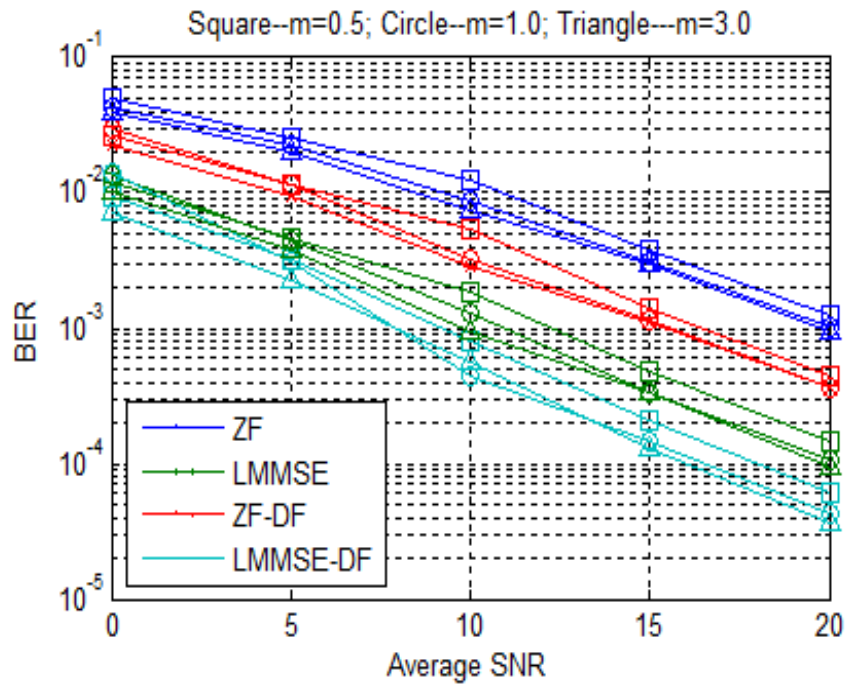

Figure 6. Comparison between LF and DFE.

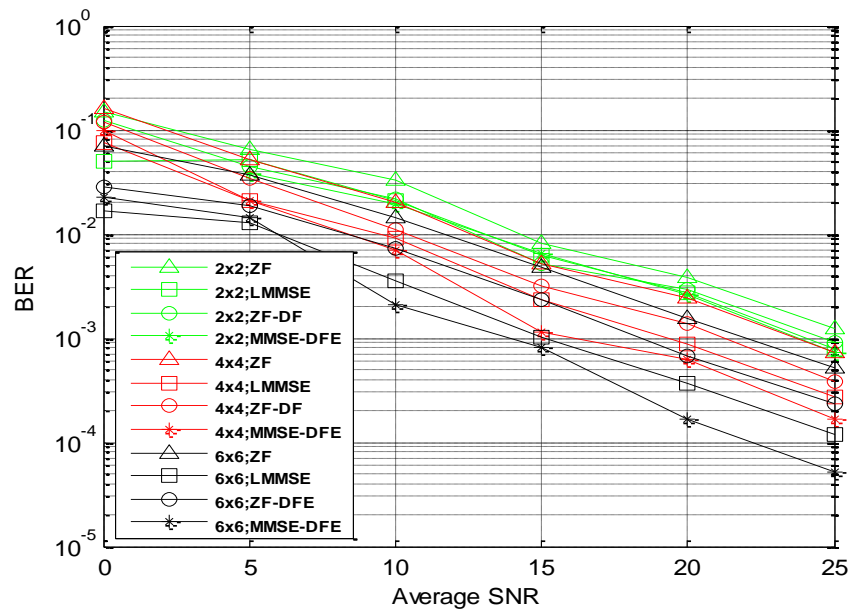

Figure 7. Assessment of the performance of the linear and DFE receiver.

As indicated in Figure 6-7, MMSE-DFE receiver provides best BER performance in comparison to the other receiver system. As in figure, with the increment in the number of antennas, the required SNR to achieve a particular BER decrease. And the SNR gap increases as we move towards the MMSE-DFE receiver. And also the impact of the m , over the system performance is also evaluated. Increase in m influence the fading characteristic, changing the PDF from one sided Gaussian to Rician condition, thereby decreasing BER values with increasing SNR values.

Channel correlation coefficient and vehicular speed have a significant effect over the BER performance of the system. As in Figure 7,8 and 9, MMSE-DFE receiver is best suitable in severe channel condition.

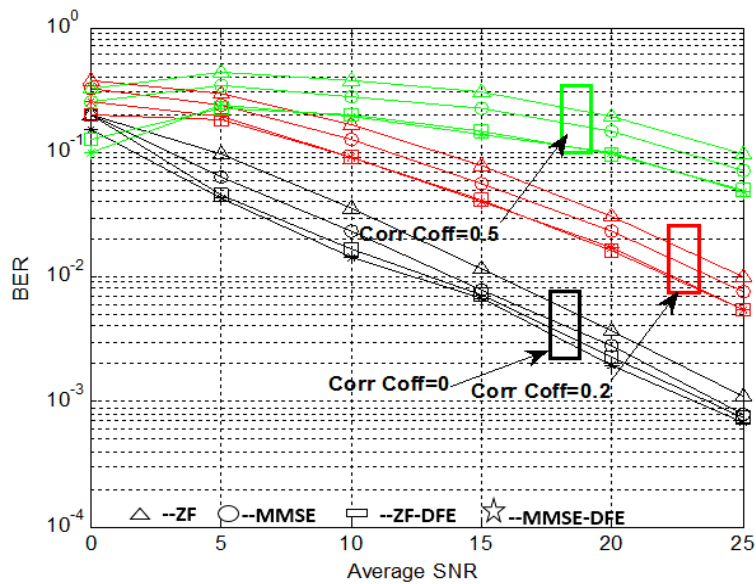

Figure 8. Assessment of the performance of the linear and DFE receiver with the variation in correlation coefficient.

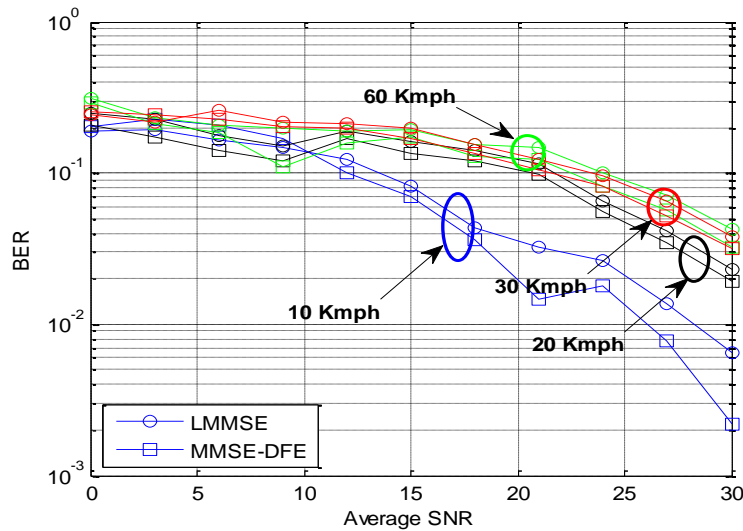

Figure 9. Assessment of the performance of LMMSE and DFE receiver with the variation in vehicular speed.

After analyzing the performance of the MMIMO system in SCE, further the performance of LMMSE and MMSE-DFE receiver has been analyzed under ITU vehicular test environment channel A and ITU pedestrian test environment channel B. The simulated result has been presented in Figure 10. Through the simulated results, it is proven that the MMSE - DFE receiver is best suitable candidate to encounter the severe channel condition.

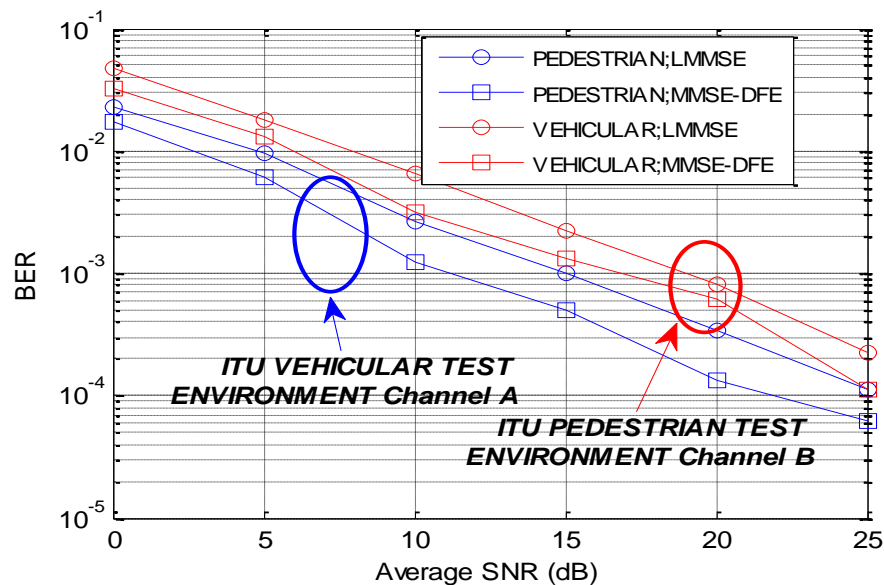

Figure 10. Assessment of the performance of LMMSE and MMSE- DFE receiver under different channel condition.

IV. HARDWARE RESULTS

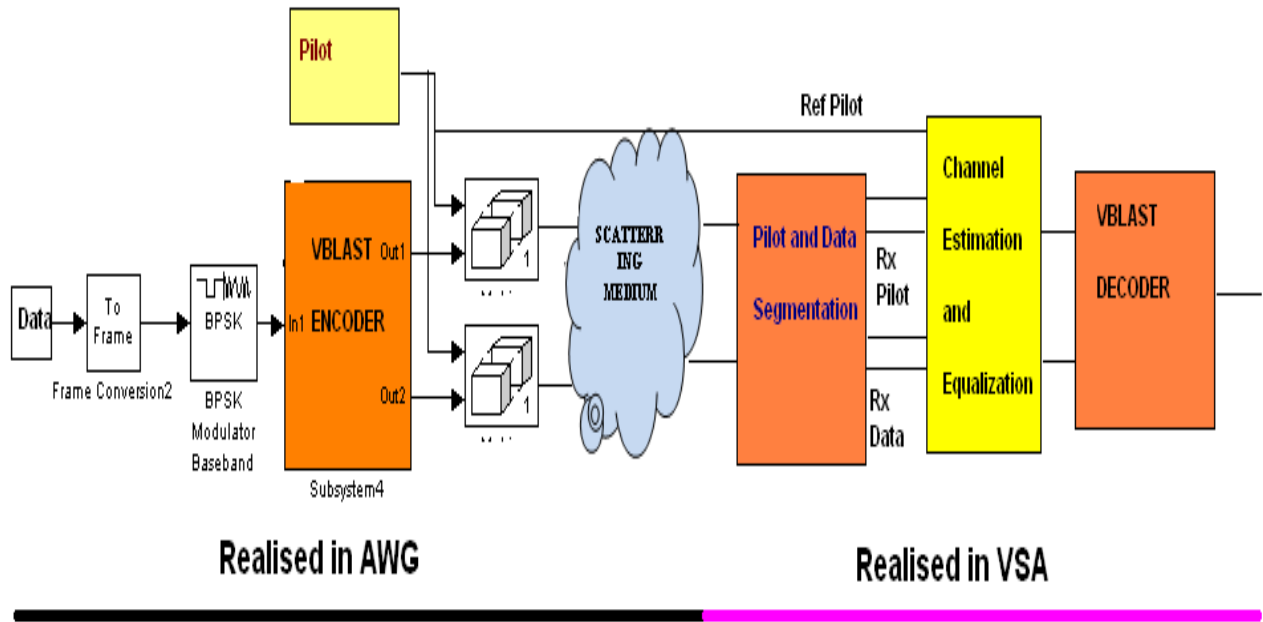

Figure 11. Basic Block Diagram for Hardware Realization.

Above figure shows the basic block diagram which is implemented and realized through Arbitrary waveform generator (AWG) and Vector signal analyzer (VSA). The basic data generation, BPSK modulation, VBLAST encoder, training insertion and the channel modeling have implemented in AWG. Whereas in the receiver side i.e in VSA the 1st job is to segregate the pilot from the data, then channel estimation and equalization. In the last stage VBLAST decoder is implemented. The total experiment is done in closed loop fashion with AWG and VSA.

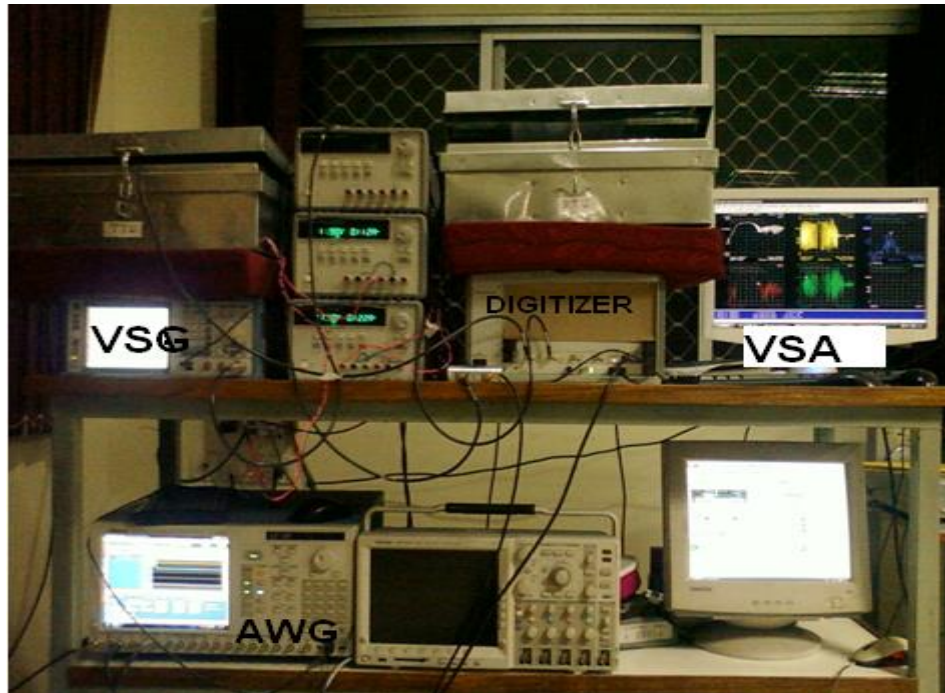

Figure 12. Hardware setup

Above figure shows the transmitter and the receiver section of the MIMO-OFDM system. As we know that AWG is a very versatile instrument. The AWG can be decompose into programmable base band section along with IF signal generation, channel modeling section and finally RF upconversion section. However, in our experimentation, we have upconverted the IF signal using VSG. The MIMO encoded and the OFDM modulated signal is generated from the Arbitrary Waveform Generator (AWG) over the IF of 100 MHz. Then the IF modulated signal is up-converted to RF level by using Vector Signal Generator (VSG) and loop back to the receiver section. At the receiver side the signal is down converted to the IF level. The IF signal is fed to the digitizer and the digitized signal is analyzed by using Vector Signal Analyzer (VSA).

Table 2. Summary of OFDM Parameter

Number of Subcarrier Spacing	256
Subcarrier spacing	200 KHz
Modulation	QPSK
Bandwidth	51.2 MHZ

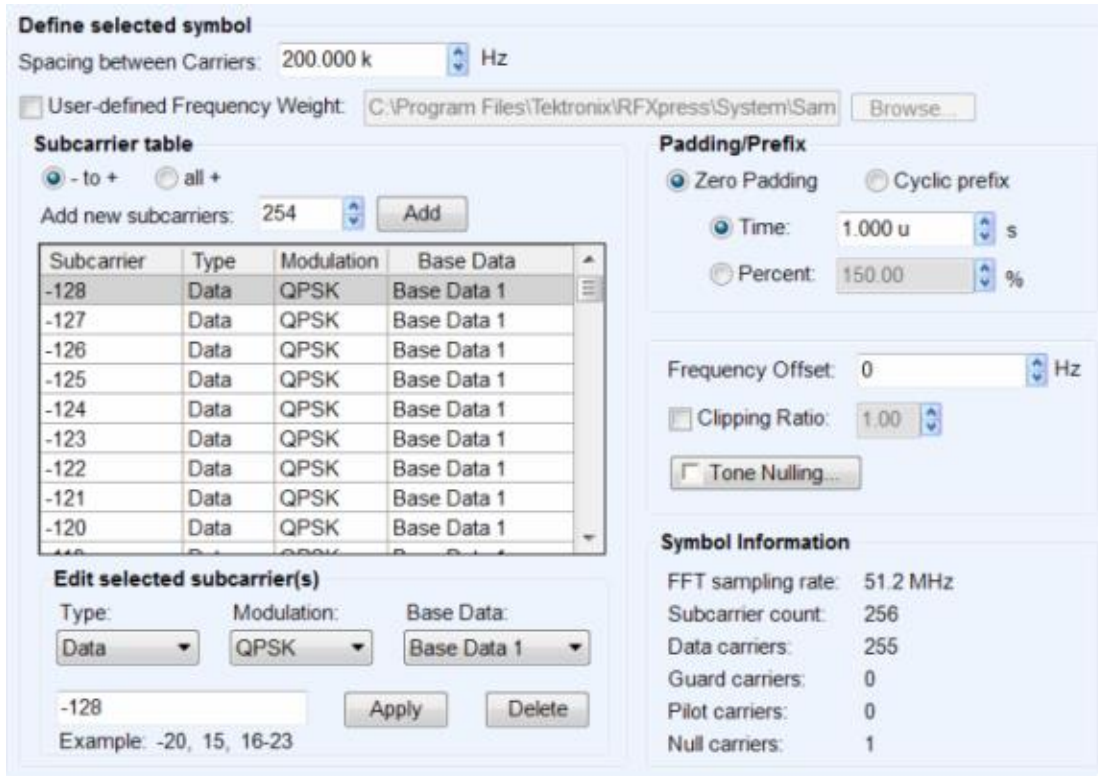

Figure 13. OFDM Parameters setting for AWG.

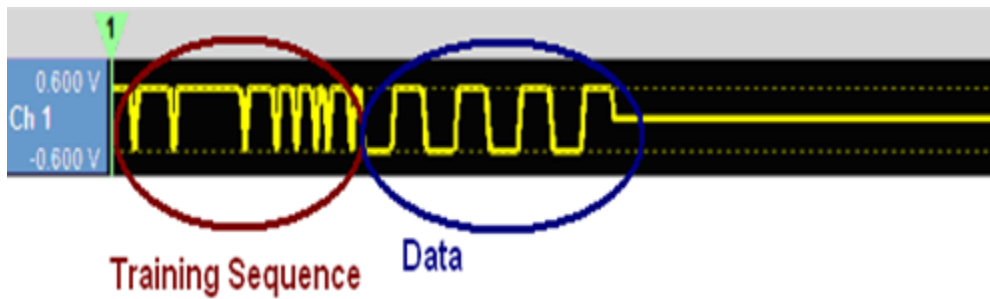

Figure 14. Baseband Signal at the transmitter side for 1st channel (Real part).

As in the figure, information data stream is first modulated and then it is VBLAST encoded. Then training data stream is added to both of the coded data. Above figure shows the real part of the 1st transmitted data stream.

After pilot insertion the data streams are up-converted to the IF level of 100 MHz. The transmitted IF signals are shown in the figures below.

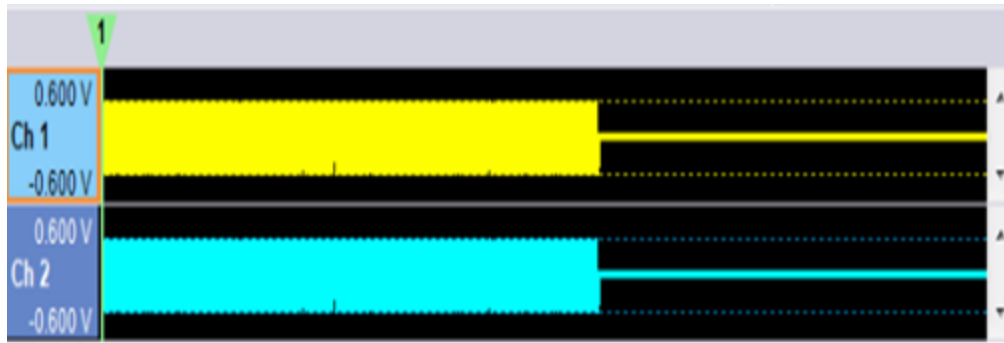

Figure 15. Signal from AWG without any channel (IF 100MHz)

As we have already discussed that we have tested our system in hardware in loop (HIL) configuration, therefore using the programmability of the AWG we have built the channel model and have passed the transmitted data through that channel and shown in the figures below.

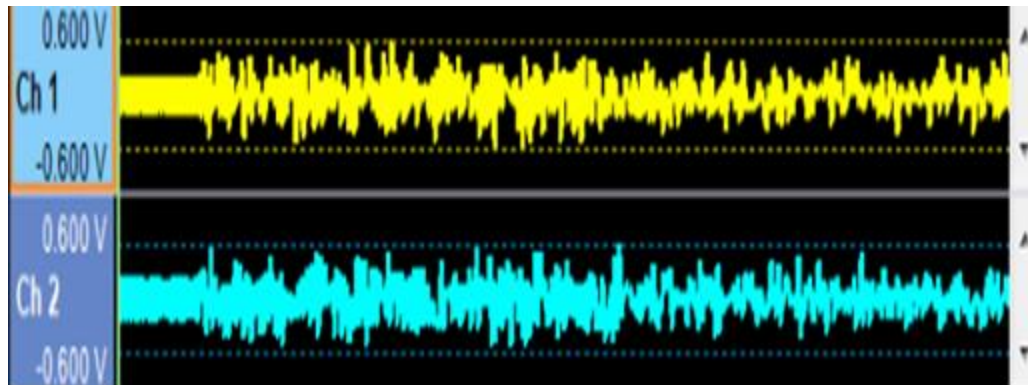

Figure 16. Signal from AWG with AWGN channel (-3dB SNR) (IF 100MHz)

By comparing figure 15 and 16 one can conclude that as the SNR value decreases the channel the signal quality degraded as the noise floor over shoot the signal level.

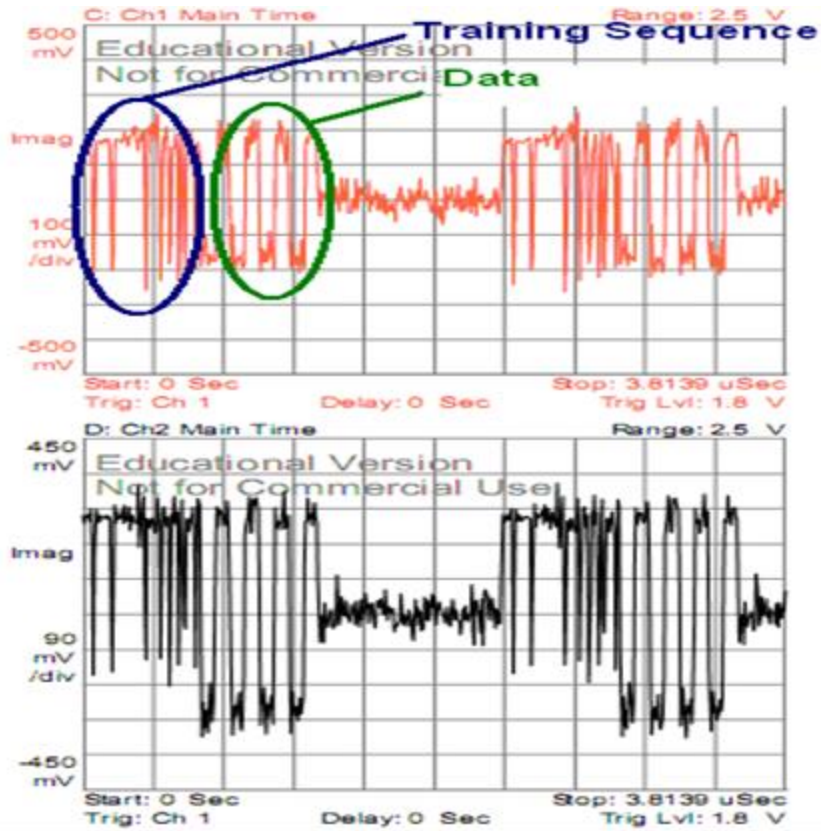

Figure 17. Received Signal at VSA with AWGN channel (6 dB)

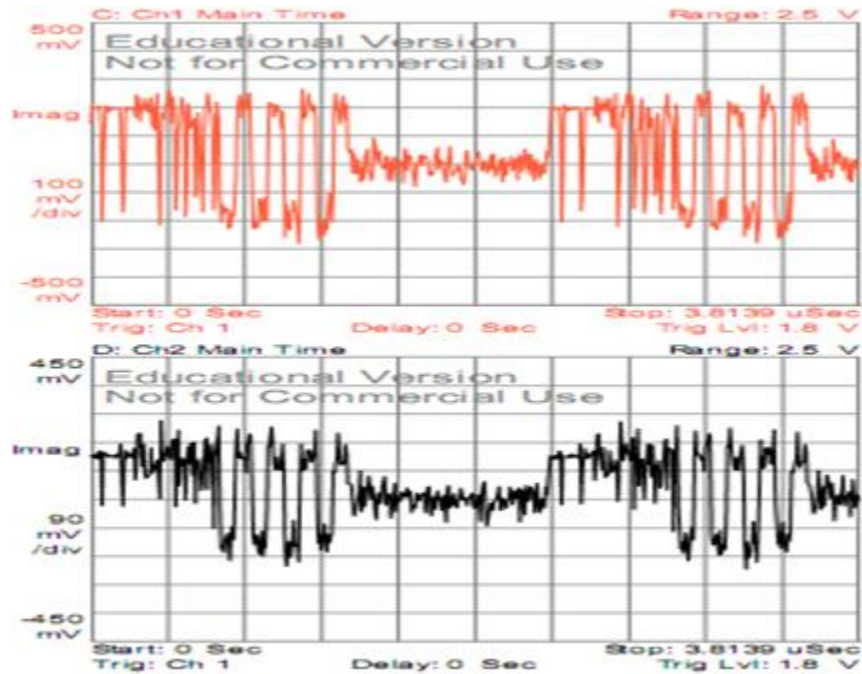

Figure 18. Received Signal at VSA with AWGN channel (3 dB SNR)

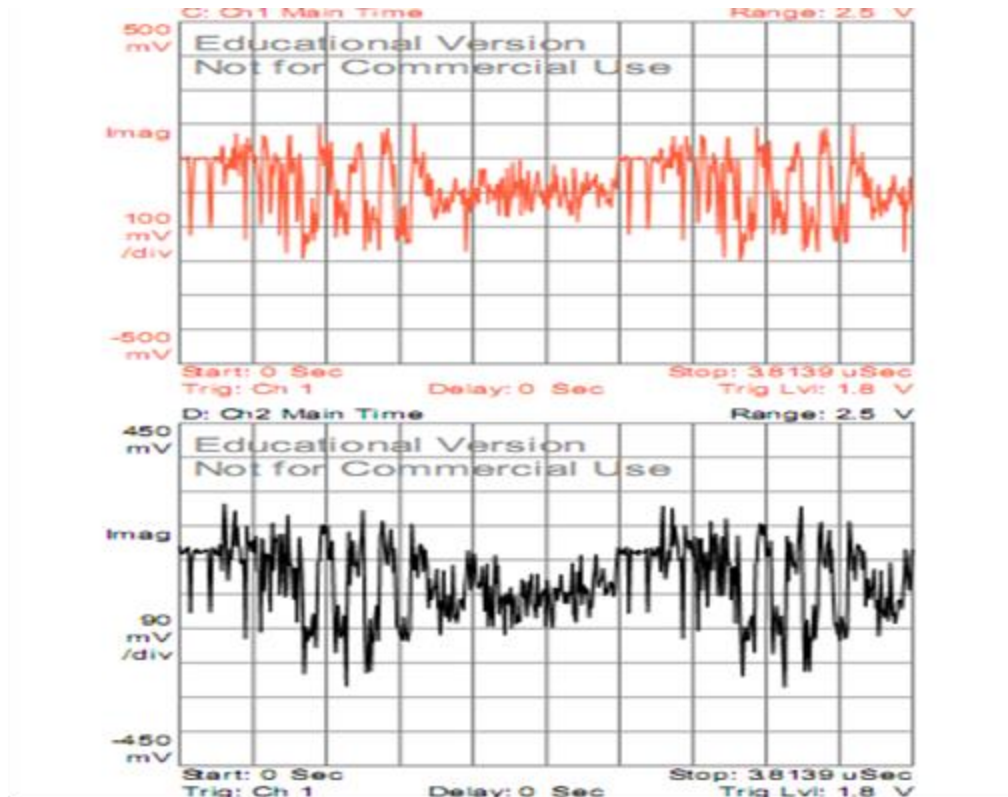

Figure 19. Received Signal at VSA with AWGN channel (-3dB SNR)

Figures 17, 18 and 19 represent the received base band signal at the VSA. It is clear from the figures that as the SNR value decrease the signal quality deteriorated.

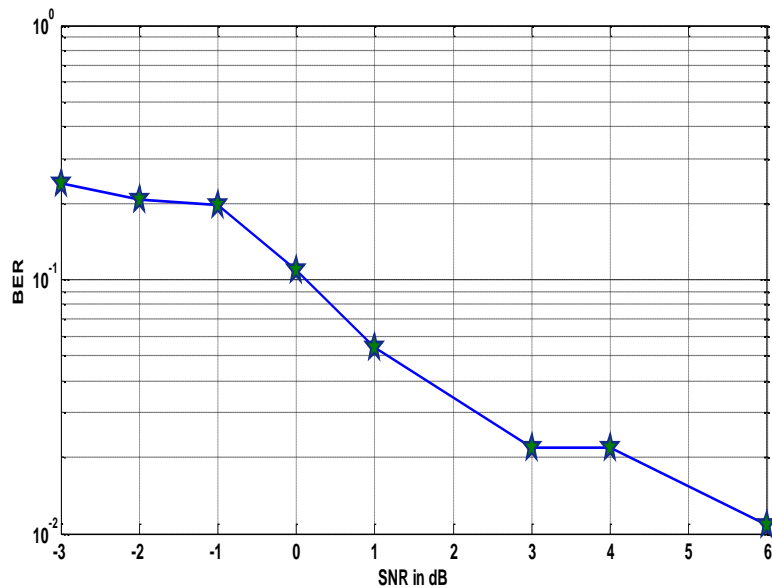

Figure 20. SNR vs BER curve in closed loop condition.

Above figure shows the BER performance of the above said VBLAST system in closed loop form with AWG and VSA. Figure shows with the increase in SNR value the BER reduces.

IV. CONCLUSIONS

The dynamic nature of the environment force the system designer to design a more complex system. More emphasis is given to the design of the receiver system. The main aim is to provide more advanced and suitable signal processing algorithms. Design of suitable receiver system in severe channel condition plays an important role to enhance the system performance. Particularly, in SCM channel the dynamic nature of the channel makes the environment more hostile. As presented in this paper, the non-linear receiver is best suitable for the dynamic channel condition. Particularly, MMSE-DFE receiver enhance the MIMO system performance in comparison other receiver system.

REFERENCES

- [1]. Zhang, L. and Chen, F, A Channel Model for VANET Simulation System. International Journal of Automation and Power Engineering (IJAPE), vol.2, no. 4, 2013, pp. 116-122.
- [2]. Kenney, J. B., Dedicated Short-Range Communications (DSRC) Standards in the United States, Proceedings of the IEEE, vol. 99, no. 7,2011, pp.1162-1182.
- [3]. Zhang, Y. and Moustafa, H. (2009), Vehicular Networks Techniques, Standards, and Application, New York: Taylor & Francis Group, LLC (ISBN 9781420085716 - CAT# AU8571).
- [4]. Vinel, 3GPP LTE Versus IEEE 802.11p/WAVE: Which Technology is Able to Support Cooperative Vehicular Safety Applications?, IEEE Wireless Communications Letters, vol. 1, no. 2, 2012, pp. 125-128.
- [5]. 3rd Generation Partnership Project (3GPP),(2003), Spatial channel model for multiple input multiple output (MIMO) simulations (3gpp tr 25.996 version 6.1.0 release 6), ETSI, Tech. Rep.
- [6]. User guide, "Spatial Channel Model for Multiple Input Multiple Output (MIMO) Simulations", A Ray Tracing Simulator Based on 3GPP TR 25.996 v. 6.1.0.
- [7]. 3rd Generation Partnership Project; Technical Specification Group Radio Access Network; Spatial channel model for Multiple Input Multiple Output (MIMO) simulations (Release 9) 3GPP TR 25.996 V9.0.0 (2009-12).

- [8]. Mate Boban, João Barros, and Ozan K. Tonguz, Geometry-Based Vehicle-to-Vehicle Channel Modeling for Large-Scale Simulation, *IEEE Transactions On Vehicular Technology*, Vol. 63, No. 9, November 2014, pp-4146-4164.
- [9]. Eraslan, E., Daneshrad, B. and Lou, C. Y., Performance Indicator for MIMO MMSE Receivers in the Presence of Channel Estimation Error, *IEEE Wireless Communications Letters*, Vol. 2, No.2, , 2013, pp. 211-214.
- [10]. Lee, J., Toumpakaris, D., Jang, E. W. and Lou, H. L, DFE-based Receiver Implementation for MIMO Systems Employing Hybrid ARQ, *IEEE GLOBECOM*, ,2008 pp. 1-5.
- [11]. Kan, W. C. and Sobelman, G. E., Reduced Complexity MIMO MMSE-DFE, 39th Asilomar Conference on Signals, Systems and Computers; Pacific Grove, CA; United States, Volume2005, Article number 1599869, pp. 824-828.