



# The RealTime challenges for the EISCAT\_3D Phased Array Radar system



*Ingemar Häggström  
EISCAT Scientific Association, Kiruna, Sweden*

# EISCAT Scientific Association



CRIRP, PRC



Suomen Akatemia,  
Finland\*



NIPR/ISEE, Japan



Forskningsrådet,  
Norway\*



Vetenskapsrådet,  
Sweden\*



NERC, U.K.



AARI, Russia



IRA, Ukraine



IRAP, France



KOPRI & KASI,  
S. Korea

\* EISCAT host countries

# Current EISCAT installations in Northern Scandinavia and Finland

**Unique:** tristatic IS radar!

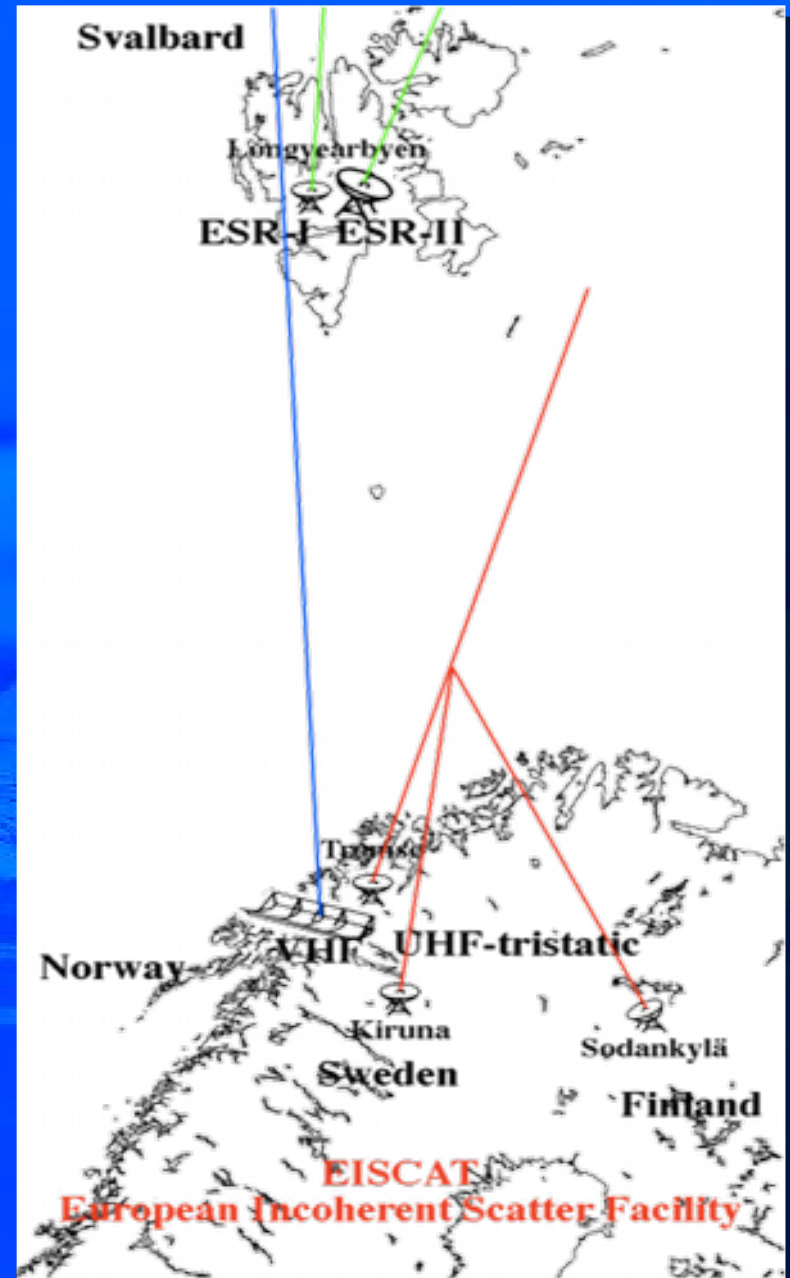

# EISCAT Radars

**Tromsø, Norway**



**Kiruna, Sweden**



**Sodankylä, Finland**



**Longyearbyen, Svalbard**



# EISCAT Science

How is Earth's atmosphere coupled to space?

Space weather effects

Climate change

Space debris

Near-Earth object studies

Radio astronomy

Micrometeors

Basic plasma physics via active experiments

e-Science

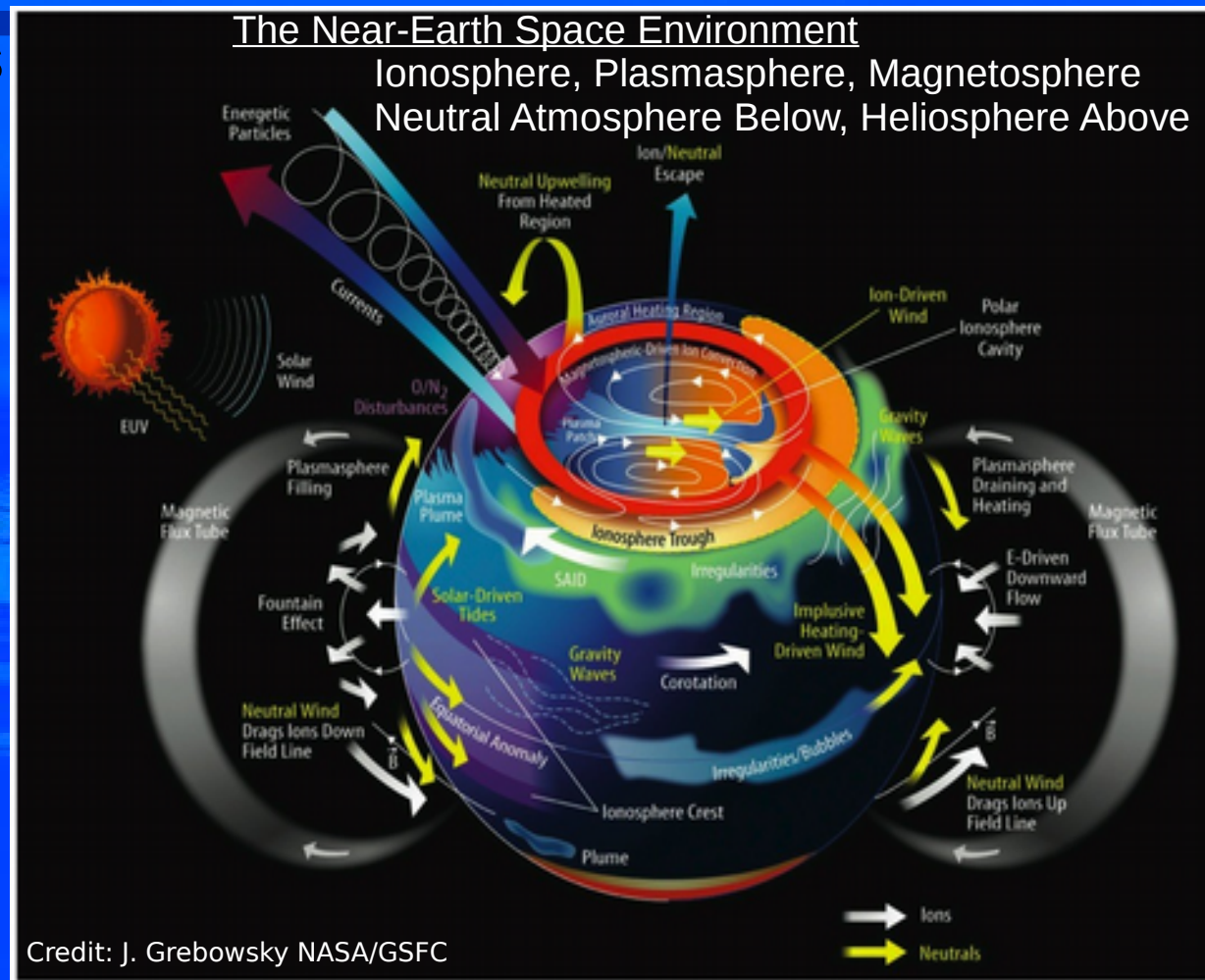

# EISCAT\_3D

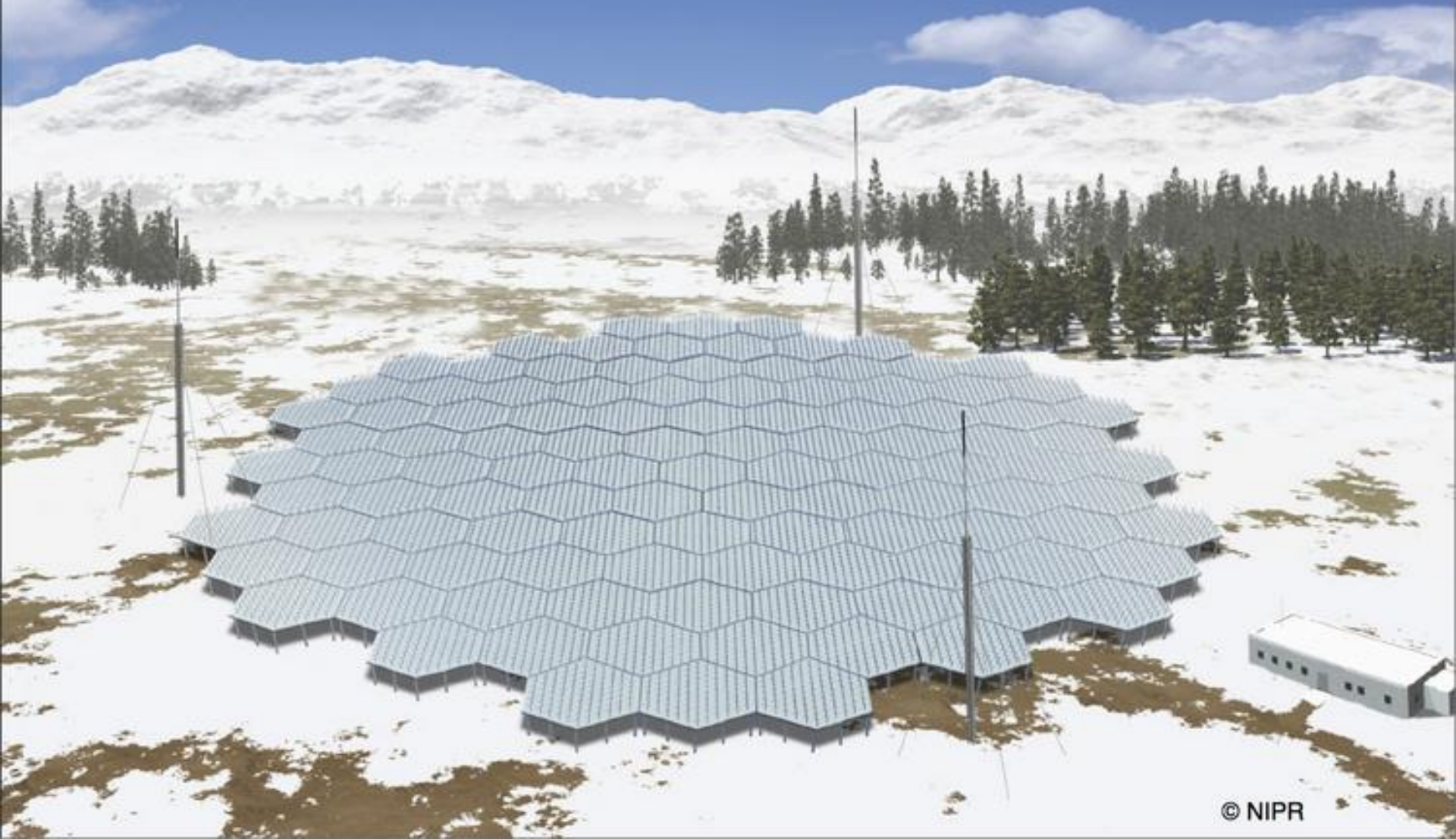

# EISCAT\_3D

EISCAT\_3D will be a volumetric **vector**-imaging radar for studying the geospace environment

It represents a revolutionary upgrade to the existing EISCAT mainland facilities, utilizing multi-static, phased-array technologies

It will support continuous measurements of the space environment via unattended operations

EISCAT\_3D will have the sensitivity needed for ionospheric measurements at better than 100 msec time scales and 50-100 meter spatial scales (order of magnitude improvements over current systems)

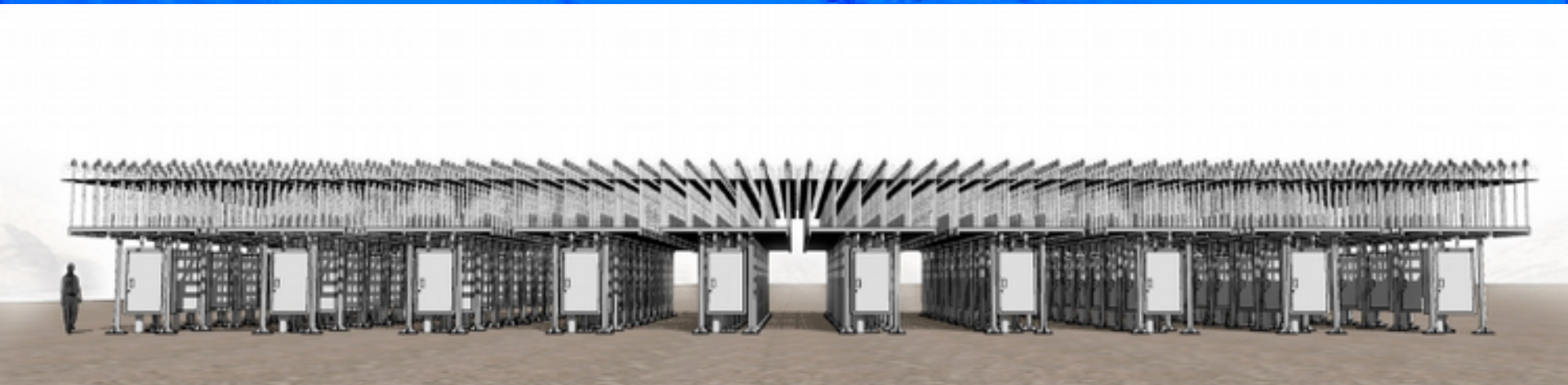

# 9919+ Antennas Per Site

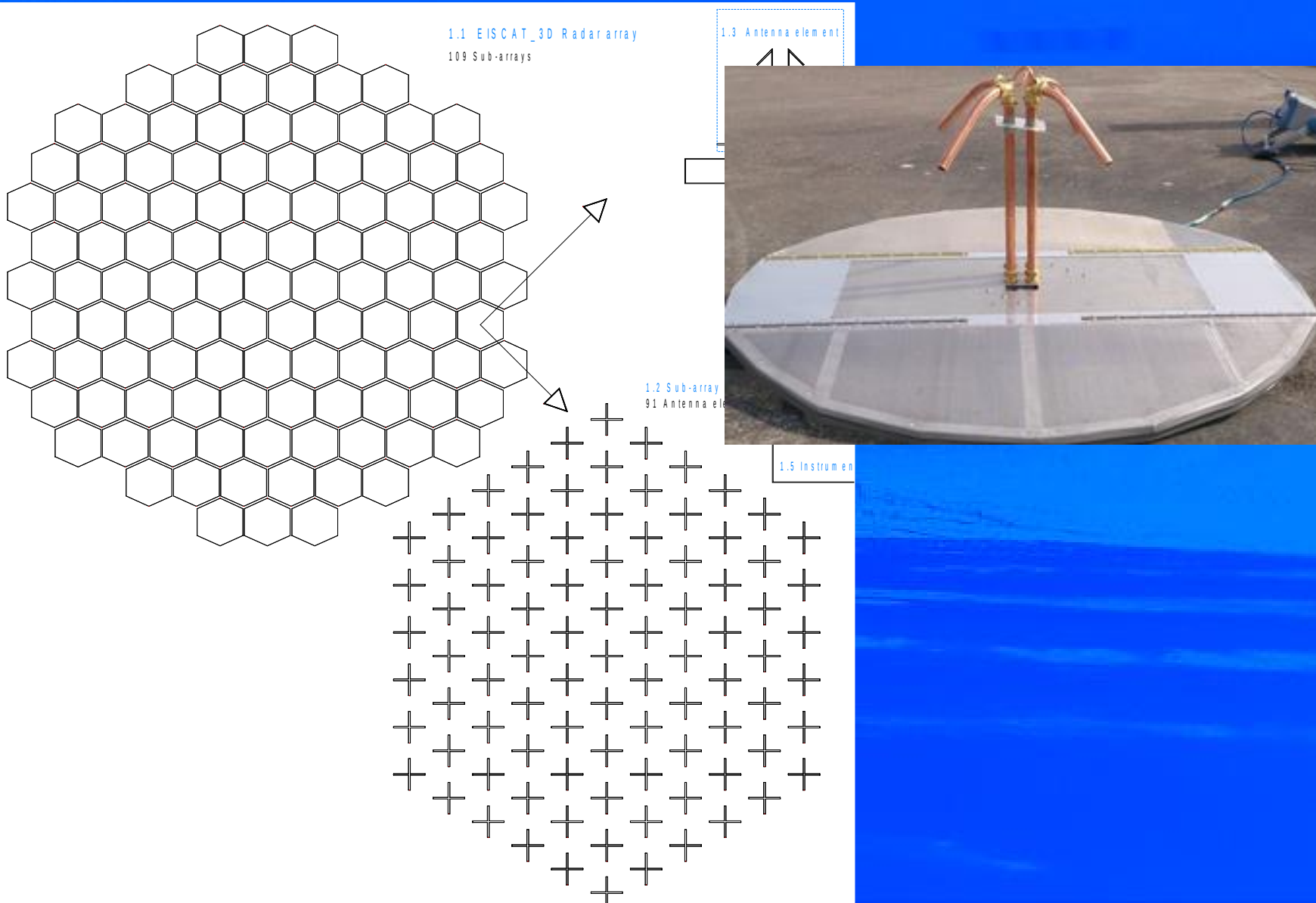



# Multistatic Phased Array

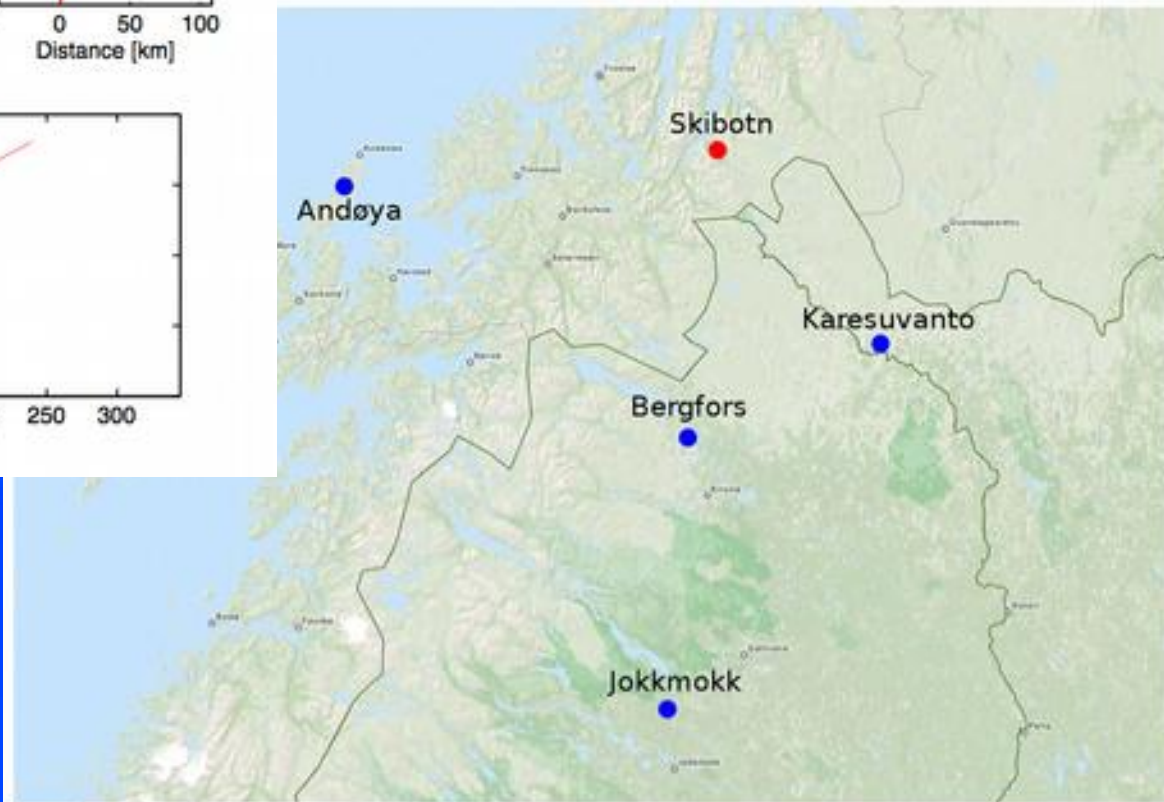
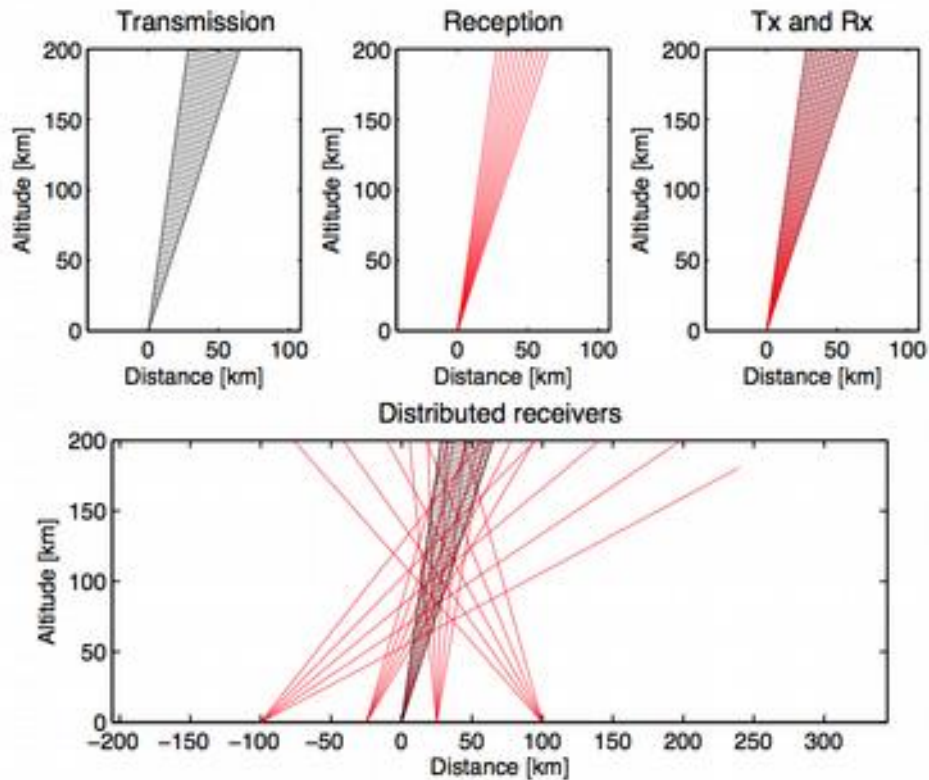

# Component Modules

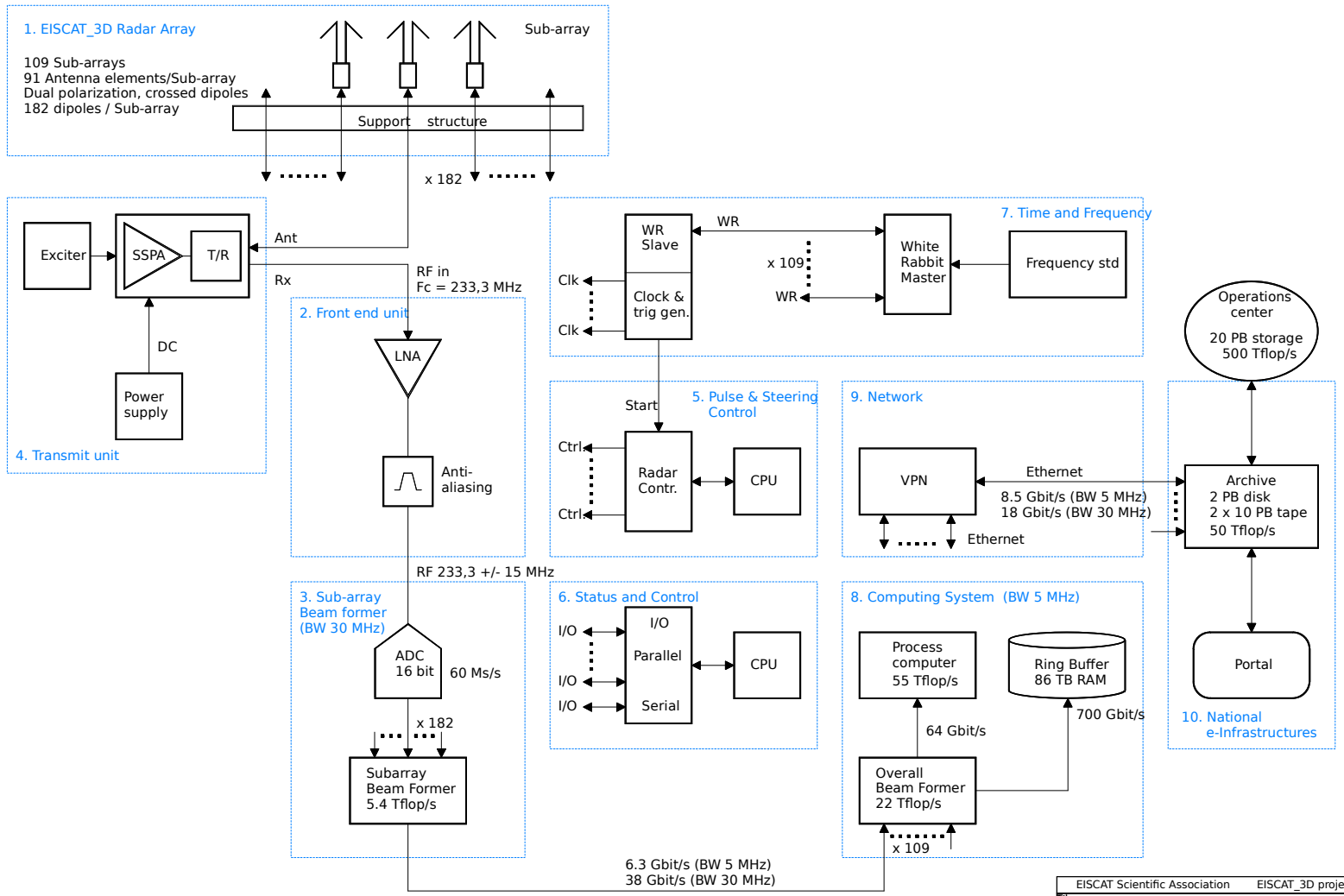

EISCAT Scientific Association		EISCAT_3D project	
File EISCAT_3D Block diagram 0. top level			
Size 421x298	Document Number	ver. 2014-02-20	Rev
date: Thursday, February 20, 2014		Sheet 6 of 10	

# Beamforming

---

Direction controlled by individual delays

– 60 cm separation between antennas

Beam width  $1^\circ$  (beam resolution)

→ delay 30 ps

Resolution  $\sim 6$  ps

# Tx beamforming

---

- Signal generated by exciter
- Amplified to 500W → total 10MW
- Transmission freq ~1kHz
- Modulation BW <5MHz
  - Baud length 200ns
  - Nominal resolution 30m

# Rx beamforming

Two stages

■ Subarray (91\*2)

- ADC
- FIR filter (FPGA)
  - Delay
  - Shift
  - LP filter
- Total no taps 36-240

■ Fullarray (109\*2)

- CPU/GPU cluster

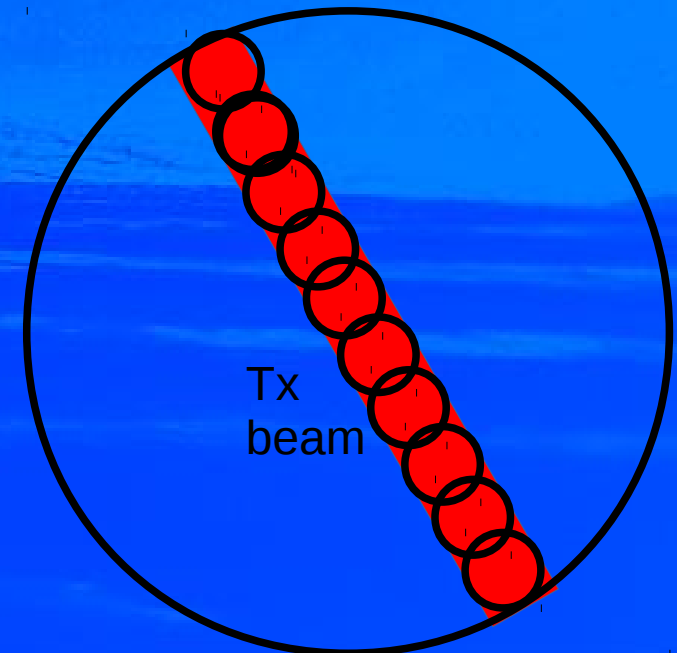
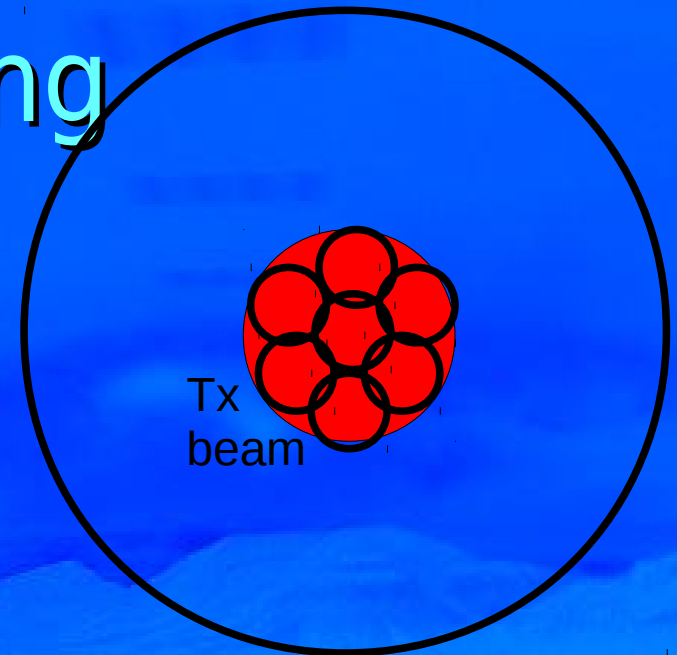

# Operation Centre

Control operation

Collect data from sites

- 20 PB buffer

Process 500 Tflop/s

- 3D profiling

- Reduce to physical parameters

Send to archive

- 2-4 PB/year

Serve users

- Portal for access & control

