

Interoperability between Information Systems of Portuguese Higher Education Institutions

Lígia M. Ribeiro¹, Rui H. Pereira², Osvaldo Pacheco³, Mário Bernardes⁴, Ricardo T. Martins⁵

¹ Universidade do Porto, Faculdade de Engenharia, R. Dr. Roberto Frias, 4200-465 Porto, Portugal, lmr@fe.up.pt

² Instituto Politécnico do Porto, ISCAP, Portugal, rhp@iscap.ipp.pt

³ Universidade de Aveiro, Departamento de Electrónica, Telecomunicações e Informática, Campus Universitário de Santiago, 3810-193 Aveiro, Portugal, orp@ua.pt

⁴ Universidade de Coimbra, Serviço de Gestão de Sistemas de Informação e Infraestruturas de Comunicação R. Arco da Traição, 3000-056 Coimbra, Portugal, mjb@uc.pt

⁵ Universidade de Aveiro, Serviços de Tecnologias de Informação e Comunicação, Campus Universitário de Santiago, 3810-193 Aveiro, Portugal, ricardo@ua.pt

Keywords

Interoperability platforms, information systems, cloud computing, electronic administration

1. ABSTRACT

The main thrust of this work is to present an interoperability platform between information systems of higher education institutions in Portugal and the main advantages and benefits its use has already allowed within an academic community of about 100,000 users. This interoperability platform, running on a cloud computing environment, was a major result of a project called "IES+Perto", meaning "Higher Education Institutions Closer", involving some of the most prestigious Portuguese universities and the largest polytechnic in the country. It was developed with a unifying but not intrusive perspective, so that each institution would continue to be solely responsible for the organization and delivery of its information.

A common mobility strategy for digital content supported by an application for mobile devices, and a set of services for electronic data transfer between institutions for the academic processes of student national mobility and joint courses of study, have been developed using the interoperability platform.

The project IES+Perto and the interoperability platform in particular have contributed very positively to innovation, administrative modernization and electronic management of the institutions involved, creating conditions for the extension of services to other higher education institutions, as has already happened by supporting new initiatives that the project IES+Perto proponents and other higher education institutions submitted for funding under a new application to the National Administrative Modernization Support System, which were approved.

2. OVERVIEW OF THE PROJECT IES+PERTO

The project IES+Perto was a collaborative and resource sharing project between four Portuguese higher education institutions (HEI), financed with 1.7 million euros by the National Administrative Modernization Support System (SAMA). The project provides 87,000 students, 6,000 professors and researchers and 3,500 other employees from the universities of Porto, Aveiro, and Coimbra and the Polytechnic Institute of Porto with new information technology (IT) services, exploring the benefits of interoperability, open standards and cloud computing, to advance a development strategy headed for administrative modernization and rationalization of costs in the higher education context.

The project was able to create important synergies not only between the actors directly implicated in carrying out the project, but also among employees of different departments of the organizational structure of the partner institutions that have made significant contributions to the objectives to be achieved, besides other national bodies such as the National Foundation for Scientific Computation

(FCCN), a branch of the National Foundation for Science and Technology (FCT), and the National Security Office (GNS).

The results of the project highlight a federated cloud computing environment interconnecting existing private clouds of the partner institutions and, built on top of the federated cloud, an interoperability platform which enables access, communication and interaction with the information provided by the information systems of each institution. This interoperability platform enabled the development of common applications and services in a fast and efficient way, despite the deep differences in the implementation of the information systems of each institution.

Taking advantage of the interoperability platform, a common strategy to explore academic information through mobile devices was designed, resulting in the development of an application that includes a set of features to facilitate easy access to services of the partner institutions. It was used furthermore to implement interfaces to enable the electronic data transfer between institutions for national student mobility programs and joint courses of study. Aiming for the complete dematerialization of academic processes, an application library was developed for digital signature with the Citizen Card, looking after the innovativeness of administrative services and the confidence of stakeholders. Some preliminary results of the project IES+Perto have been presented in a previous work (Ribeiro & Valente, 2015).

The developments were carried out using open and interoperability standards to minimize maintenance costs and future licensing needs and facilitate interconnection with other applications for higher education.

An inter-institutional cooperation agreement between the partner institutions was established to ensure governance and shared management of the federated cloud and the interoperability platform, as well as applications and services it supports or will be supporting in the future, creating conditions for the extension of services to other higher education institutions beyond the four already implied, as is already the case.

3. DEVELOPMENT OF AN INTEROPERABILITY PLATFORM

3.1. Context

A consortium of higher education institutions or other sister organizations responsible for delivering information systems and academic applications for higher education does not exist in Portugal. Only FCCN, the Portuguese NREN (National Research and Education Network), provides connectivity services and related applications and services to the academic community. It follows that each institution develops or acquires its own tailored information system, although there are specific agreements for the use of information systems developed in the context of a single institution by other institutions. The existing information systems are very different in scope, integration capabilities and standards compliance. This scenario does not favor the ability to share information and services automatically between institutions. However the demands on higher education have been changing fast, much as a result of the global economic and financial background, but also due to the rapid pace of technological advancement. In particular, student mobility and the use of mobile devices are the “new normal” of operations that challenge higher education IT services.

Aiming to increase the level to which technology is leveraged for the benefit of the academic community, the partners of the project IES+Perto decided strategically on developing an interoperability platform between their information systems, bearing in mind its applicability to other institutions of higher education.

3.2. Overall architecture and integration

Considering on the one hand the significant differences existing between the information systems and related applications of the various higher education institutions, and, on the other, the need for each institution to organize and freely manage its information space, and given the growing need for HEIs to share information and create common services, an interoperability platform was designed in the context of the project IES+Perto as a means of integrating and transforming information existing on local HEIs' information systems to support data exchange and the build of conjoint applications.

This interoperability platform aims to expose the HEIs' information systems to their stakeholders as a unique and standard REST/SOAP-based service. The platform architecture follows the Enterprise Service Bus (Chappell, 2004) paradigm in order to provide information consumers with a consistent view of several heterogeneous data sources. These service standardization requirements are beyond interfacing issues and data mappings, because complex adaptations based on business logic rules are required.

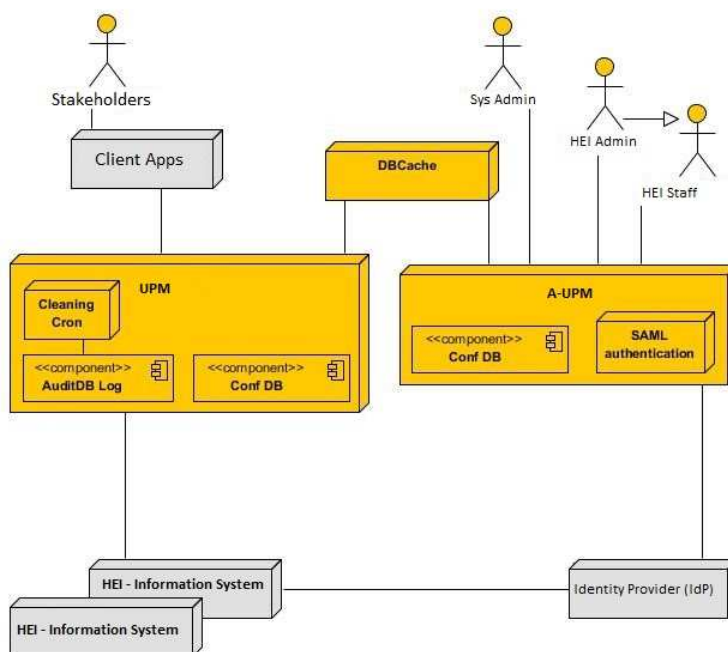

Figure 1 Platform architecture

The platform architecture was conceived with scalability in mind. The system is composed by two types of main module: (1) A-UPM (Admin - Ubiquity Provider Module) and (2) UPM (Ubiquity Provider Module). Additionally, other subsystems such as cache, database of configurations and logs, complete the system. The A-UPM provides a user interface for system administration tasks. These tasks are performed by HEI staff for administrating their services, as well as a main system administrator. On the other hand, the UPM modules are engines without direct human interaction that receive the client requests and support service mappings. In Figure 1, we present how these two types of module and subsystems are interconnected. The UPM modules were developed in order to be added to a cluster, enabling redundancy and load balancing. Besides the overall capacity of the system being very scalable, it is also flexible, because these cluster nodes can be geographically dispersed according to the service consuming needs.

Concerning the system performance, two levels of cache were introduced in the UPM modules: (1) C1 caches the output results of the platform; (2) C2 caches the data gathered from the HEIs' information systems. The C2 cache policy is based on a TTL (Time to Live) parameter, which is related to the HEIs' service. Notice that some services are very static, such as students' personal data. On the other hand, the students' grades data are very volatile, especially at the end of the semester. In our tests, this simple approach proved to be very efficient. However, more complex cache policies could be implemented in the future.

At the C1 cache level, the policy is very similar. The invocations submitted to the platform are also cached according to a TTL parameter. However, additional mechanisms are required in order to guarantee that wrong users do not gain unauthorized access to cached data. Thus, this cache level has separated contexts for each access authorization. That is to say, if one user performs exactly the same request as another, the cached data is not used. In this case, only the data cached at the C2 cache level will be used, thus introducing high performance gains.

In order to enable business logic rules in the service mappings, the platform allows that special modules, the Handlers, can be introduced into the system in order to extend its base adaptation mechanisms. These Handlers are written in Java programming language and use an API provided by the platform. The API provides abstraction regarding the technical details when invoking the HEIs' services, as well as transparent caching mechanisms.

Figure 2 depicts one example of a sequence of interactions between an external client and HEIs' information systems being handled by the platform. In this figure, one can observe a stakeholder invoking a service which triggers the execution of the Handler. The platform deals with client invocations and forwards each request to the appropriate Handler using the identifiers received in the request.

Invocations to the platform require four mandatory arguments: (1) bsUIID—an identifier of the operation to be executed; (2) an identifier of the HEI; (3) an API key that enables access control of client applications; and (4) a container that contains all arguments of the requested action. This container is, indeed, the input source of arguments passed to the Handler. The first and second identifiers together permit the platform to find which Handler must be applied in the requested action.

The mechanism processing starts by searching for the requested data in the C1 cache. In the example presented in Figure 2, no cached data is found. Hence, the request is delivered to the Handler. In the former step, the Handler gets data (Obj1) from the HEI's information system using the programming API of the platform. Notice that the use of the C2 cache is transparent to the Handler. After getting Obj1, the Handler performs some data processing based on the specific business rules of the target HEI for which it was written. At the next execution step, it invokes another web service in order to obtain additional data (Obj2) for completing its task. Finally, the result is delivered to the platform and recursively to the client.

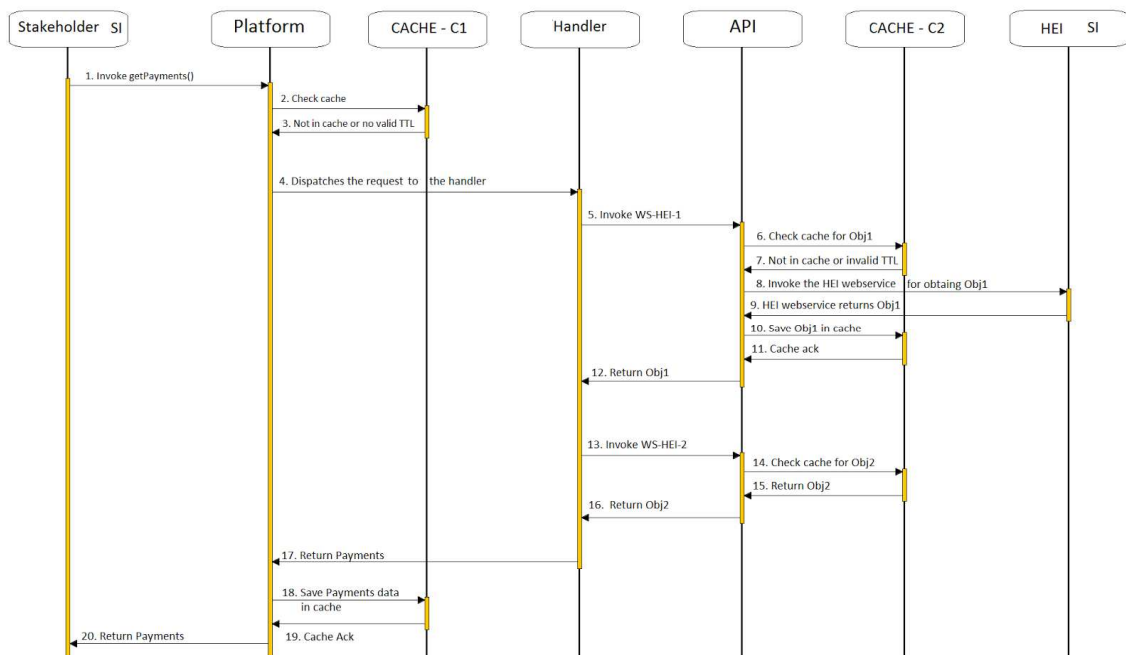

Figure 2 Handler invocation

Due to the use of a programming language and the platform programming environment, these Handlers are able to manage high levels of complexity regarding the adaption problem, business logic rules and data sources' heterogeneity. During the implementation phase of the services, many variations were observed in the HEIs' data models and concepts. Without this versatility of the platform, it would have been impossible to achieve our goals.

3.3. Deployment in a community cloud

After identifying the architecture of the interoperability platform, another important step was the definition of a computational and network model to support it, with adequate capacity in terms of performance, availability and future growth. This section briefly describes the approach followed by the HEIs and the implementation carried out in the context of the project IES+Perto.

The adoption of a common strategy by the involved HEIs for cloud computing implementations in order to share solutions, and build a knowledge base and a community cloud was among the main objectives of the project IES+Perto. This infrastructure allows appropriate response to the requirements for supporting the interoperability platform.

Considering the previous experience in the field of the HEIs involved, it was decided to adopt OpenStack software (OpenStack, n.d.) to create the private clouds and KVM (Kernel-based Virtual Machine) as the virtualization solution. Hence a community cloud named cloud4IES was built and is now a distributed platform that interconnects HEIs' private clouds over the national research and educational RCTS network (Network for Science, Technology and Society), managed and operated by FCCN.

To extend each private cloud beyond its own data center to the other HEIs data centers, FCCN deployed three VLANs (one for each cloud) using private addressing (RFC 1918). These VLANs are implemented over RCTS+, a RCTS service for applications needing high performance switching connectivity without Internet access (FCCN, *RCTS Plus*, n.d.). Figure 3 shows the private clouds of the universities of Aveiro (UA), Coimbra (UC) and Porto (UP) connected through the RCTS+ VLANs. To support the interaction between components of the interoperability platform, a fourth VLAN was added.

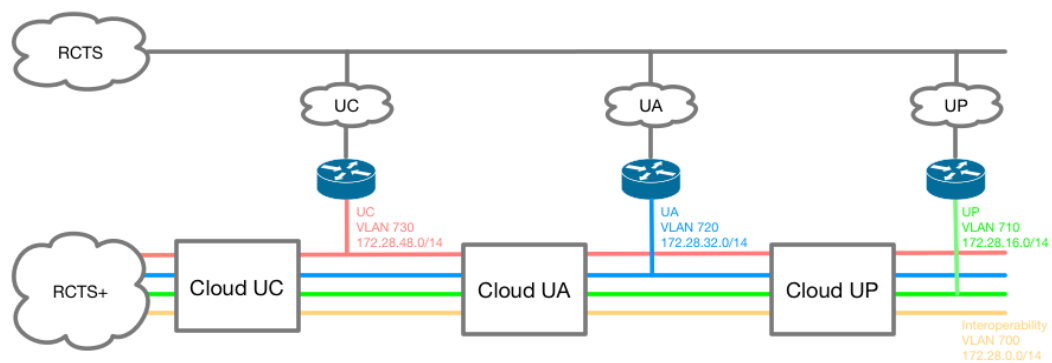

Figure 3 Cloud4IES VLANs interconnection

This was an efficient approach because it permitted the interconnection of the universities' private clouds in a very short time over the NREN that already connected them, profiting from a generous amount of bandwidth. With this solution, a HEI can easily host equipment from another university, providing that each institution manages its own address space and the security policies of its private and distributed cloud. Further, in future, private clouds' interconnection over RCTS+ will enable the integration of cloud4IES with external operators and public clouds.

Over this platform, the virtual data center VDC-PI4IES was implemented, allowing the sharing between all the HEIs of a replicated and synced infrastructure that enables redundant and high availability services for the interoperability platform, providing ubiquitous access to local universities information systems (see Figure 4). If the load increases, load balancing between more instances of the interoperability platform modules UPM and A-UPM may be easily configured.

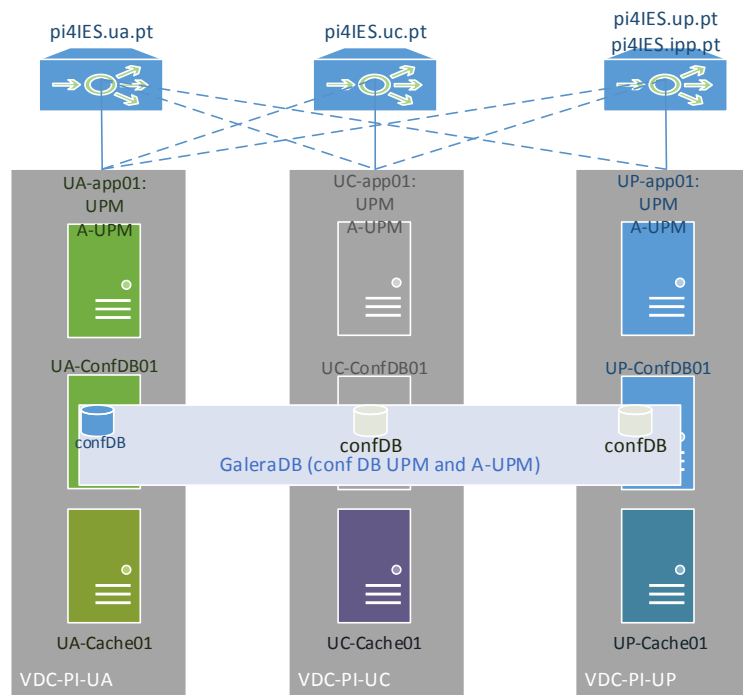

Figure 4 VDC-PI4IES architecture

The last step in the cloud4IES implementation was to provide a way for cloud administrators to manage their remote resources hosted in another university. This was achieved through the federation of all the private clouds' dashboards, a graphical interface to access, provision and automate cloud-based resources. Each private cloud is configured with a Shibboleth Service Provider (SP) and integrated with the national infrastructure for authentication and authorization (RCTSaaI) (FCCN, RCTSaai, n.d.) that connects the Shibboleth (Shibboleth, n.d.) Identify Provider (IdP) of each university.

4. EXPLORING THE INTEROPERABILITY PLATFORM FOR COLLABORATIVE SERVICES

A set of broker services is available on the interoperability platform for supporting a mobile app for the academic community and the transfer of student data between HEIs for national mobility programmes and joint courses (see Figure 5).

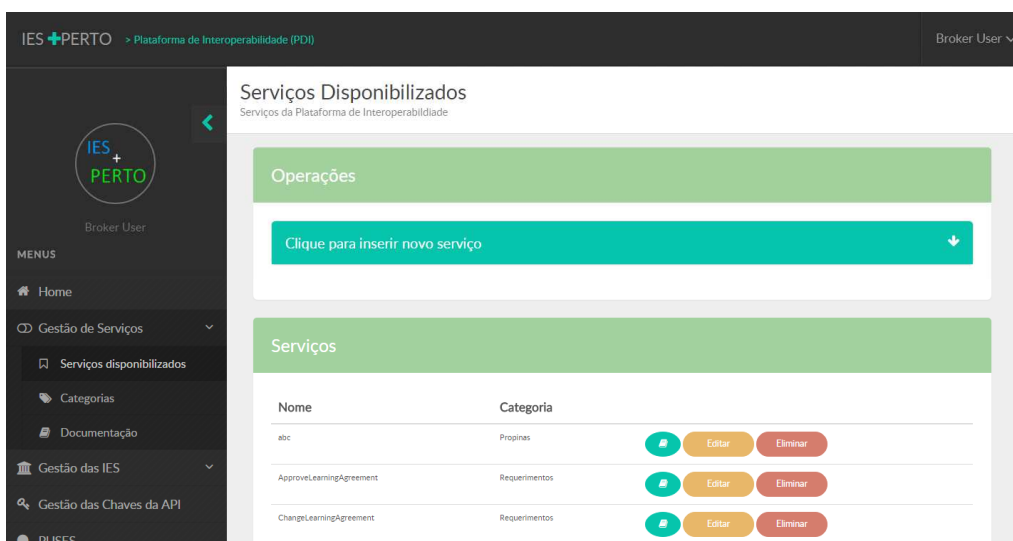

Figure 5 Interoperability platform services

The mobile application is customizable to each institution and adapts to the services available through the interoperability layer provided by the interoperability platform. The app was developed using open source technologies with support for iOS and Android platforms. It supports the authentication of users via Shibboleth and data access authorization via OAuth protocol (OAuth, n.d.). Communication between the mobile application and PI4IES takes place via HTTPS, no personal information being sent unencrypted over the network.

The app was developed for all members of the academic community and includes a set of features for each category of members. For instance, for students it includes features regarding academic information, the student's current account—allowing the student to generate ATM references for payments—or more general features such as those related to canteens, with reservation possibilities, or the possibility of requesting notifications in advance concerning the status of queues in different institutional services (see Figure 6).

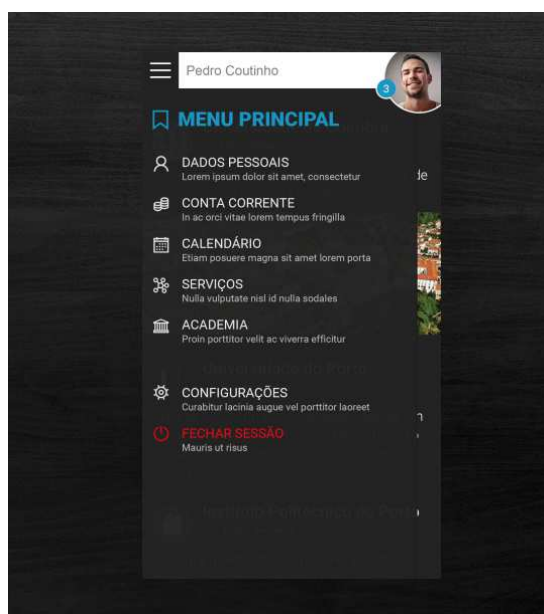

Figure 6 IES+Perto Mobile APP

Over the last decades, and in particular from the beginning of the current century, the substantial increase in the number of foreign students in higher education (ICEF Monitor, 2015) raises the need for digital student data portability, as recognized by the Groningen Declaration on Digital Student Data Depositories Worldwide “... digital student data portability and digital student data depositories are becoming increasingly concrete and relevant realities, and in the years to come, they will contribute decisively to the free movement of students and skilled workers on a global scale” (Groningen Declaration, 2012).

In Portugal, national student mobility is also real and present and, together with students' enrolments in joint courses, justifies enabling simplified access to student data by the institutions involved. In the context of the project IES+Perto, the interoperability platform was therefore used to implement student data transfer between the partner institutions cooperating in national mobility programs and joint courses. Besides the development of the necessary Handlers on the interoperability platform, local service layers were also developed to make the interconnection of each HEI information system with the interoperability platform services layer. Services supported included student enrolments, learning agreements and transcripts of records, both individual and group search, payment plans and status of current accounts in respect to joint courses. A pilot phase involving the academic and the international relations services to validate the student data portability is now starting.

Together with the development of an application library for digital signature with the national Citizen Card and a data repository with features of digital preservation of electronic documents, a significant improvement of information security, specifically in the preservation and availability of documents, was introduced.

5. EFFECTS AND IMPACT

5.1. Administrative modernization and electronic management

The project IES+Perto has allowed the achievement of a set of initiatives that embody significant improvements to the academic community of the four participating institutions, already being extended to other higher education institutions in Portugal, with additional added-value.

The interoperability platform was a major achievement of the project, allowing high levels of technological integration with the information systems of each institution, being developed according to a non-intrusive unifying perspective, so that each HEI continues to be responsible for organizing its own information. This makes possible the fast and smooth further development of common applications and services for HEIs.

The application for mobile devices built on top of the interoperability platform allows the interaction of the academic community with the respective institutional services, thus obviating travel needs at a physical counter. Furthermore, the design and implementation of targeted services for mobile platforms, exploiting open standards and interoperability, entail immediate benefits to all the national academic community, including the approximately 300,000 students in public higher education. Apart from these, the solution will also provide obvious benefits to third parties with which the HEIs interact.

As far as we are aware, the electronic transfer of student data implemented using the interoperability platform for national mobility programs and joint courses was the first effort of electronic transfer of data between higher education institutions in Portugal for academic purposes, translating into efficiency gains in service to the community.

In addition, the application library implemented a digital signature with the national Citizen Card, contributing to the dematerialisation of processes, this being a main driver for improvements in the quality of service to the community and the increase of the confidence of stakeholders.

Therefore the results achieved have a significant impact on the internal services of the HEIs. This impact is realized in a further simplification and dematerialisation of processes by exploiting new service models supported by IT, linking the virtual and face-to-face service channels.

5.2. Innovation and best practices

The interoperability platform developed in the context of the IES+Perto project is the result of an innovative initiative that, at the same time, implemented several best practices. In fact, it is the first time in Portugal that four HIEs gathered to form a consortium not for research purposes, but for building a platform that is intended to address common needs. To ensure the future management of the platform, the involved HIEs signed a protocol that creates an administrative board to produce regulation and evaluate new members, and also a technical board, formed by specialists of each institution. This way, no extra costs will be involved in the management of the platform.

The interoperability platform, completely implemented with open source tools and following open standards, also constitutes a useful case in the adoption of several best practices. First, the optimization resulting from sharing computational resources in a cloud computing environment should be highlighted. Secondly, the sharing of human resources and their expertise has also led to substantial benefits, integrating technical teams and enabling collaboration in the development of new projects.

Finally, by running business processes over the interoperability platform, there is a clear improvement in the quality of service of the involved institutions, dematerializing the exchange of information and reducing overall operational costs.

In the context of ICT, interoperability is commonly accepted as bringing innovation, although the correlation between interoperability and innovation is complex, interoperability being a very context-specific concept (Gasser & Palfrey, 2007). We argue that the interoperability platform developed in the context of project IES+Perto actually conveyed innovation because it allows seamless data integration and transmission between academic institutions, facilitating the development of new services to the users. In particular, it allows the promotion of new services aimed at mobile platforms, offering up a distinctive application that reveals a competitive

advantage not only in the public context but also the private. Also, both the use of open source technologies and standards and the agreement established between the partner institutions to maintain and develop further the federated cloud and the interoperability platform built on top of it assure the sustainability of these resources and the prospect of the innovation continuum. To the extent that cloud interoperability is a challenging issue and many obstacles still exist (Toosi, Calheiros, & Buyya, 2014) we can also say that the operation of a federated cloud environment between the partner organizations was itself innovative.

6. CREATING COOPERATION NETWORKS

The exchange of knowledge and experiences between the technical teams of the four partner institutions was a key benefit of this initiative. An active and open sharing of knowhow allowed a better and efficient response to the challenges that arose in the reorganization of the data centers and virtualization environments, as well as defining and implementing the cloud computing model and connectivity that supports it. These synergies also included the academic and external relations services, to define requirements for the electronic data exchange between institutions.

This teamwork, performed with great motivation and commitment, translated into added benefits for directly involved employees and for institutions, allowing for cross-analysis and joint improvement of processes and procedures. Therefore, in terms of inter-institutional cooperation, a network of contacts was established, materialized in the teams involved which worked together, sharing problems, solutions and knowledge.

The above mentioned network of cooperation has already borne fruit, namely the successfully submission of a new joint project involving additional partners. This new project, called “IES em Rede”—meaning “Higher Education Institutions in Network”—is financed with three million euros by the National Administrative Modernization Support System; it starts in March 2016 and joins two other universities, Beira Interior and Trás-os-Montes e Alto Douro. With the project “IES em Rede”, the HEIs will develop new user cases for the interoperability platform.

The eGovernment Action Plan 2011-2015 (Digital Agenda for Europe, n.d.) defines administrative burden reduction as a key priority for achieving the “efficient and effective government” objective. The European Council Conclusions on October 2013 state that: “Efforts should be made to apply the principle that information is collected from citizens only once, in due respect of data protection rules”. The “once only” principle states that citizens and businesses must have the right to provide information only once to a public authority. Offices of public administration should be able to take steps to share this data internally, while respecting data protection rules, so that no additional burden falls on citizens and businesses.

Another effective strategy is to produce default digital services that are so compelling and easy to use that all those who can use them will choose to do so whilst those who can’t are not excluded. Although the concepts of the “once only” principle, “digital by default” and making electronic procedures the dominant channel for delivering e-government services can be easily understood, their practical implementation encounters many obstacles, such as policy, legal and technological issues, as well as data protection requirements.

According to the Study on eGovernment and the Reduction of Administrative Burden (SMART 2012/0061) (Digital Agenda for Europe, 2014), more than 70 percent of EU countries have undertaken initiatives to put into practice the “once only” principle. The “once only” principle was transposed into Portuguese law in May 2014. Two of the most important areas of application of the “once only” principle in the HEIs are academic information exchange (certificates and contextual information) and research information management.

Figure 7 presents a proposal for information system architecture to support the application of the “once only” principle in academic area. This architecture integrates the PI4IES, the interoperability platform of public administration (iAP) and payroll management platform, simplifying the process of interaction between the information systems of HEIs and iAP. The presentation layer is composed of the Citizen Portal, the Portal for Higher Education and other applications that may be developed in the future.

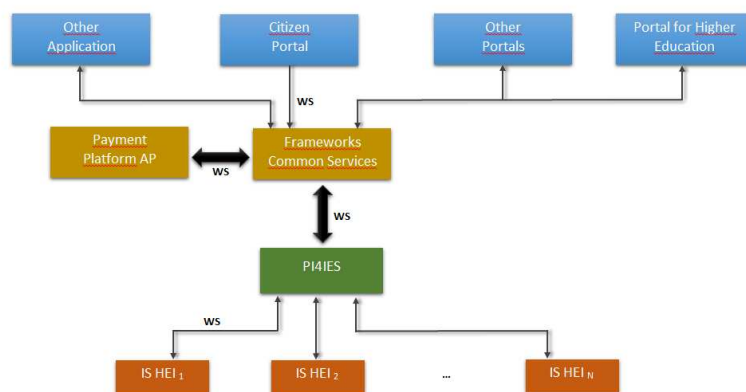

Figure 7 Proposal architecture for supporting the “once only” principle

7. CONCLUSION

The project IES+Perto was a very successful project, the interoperability platform and the federated cloud that supports it being the most impressive results accomplished. An agreement was therefore established among the partner institutions to enable the sustained operation of these resources and their further development, including the extension of use to other higher education institutions, and that has already happened.

The interoperability platform allows the easy, non-intrusive and integrated provision of electronic services for the academic community across multiple higher education institutions, allowing efficiency and productivity gains, fostering both internal and cross-institutional collaboration, being an important instrument for the modernization and innovation of higher education institutional services, taking advantage of information and communication technologies.

Acknowledgement

This work has been supported by the Portuguese Administrative Modernization Support System (SAMA) of the Operational Program Competitiveness Factors, COMPETE, under the National Strategic Reference Framework (QREN) and the European Union (EU).

8. REFERENCES

- David A. Chappell (2004). *Enterprise Service Bus*. O’Reilly Media, ISBN 0-596-00675-6
- Digital Agenda for Europe (n.d.). *European eGovernment Action Plan 2011-2015*. Retrieved February 4, 2016, from <https://ec.europa.eu/digital-agenda/en/european-egovernment-action-plan-2011-2015>
- Digital Agenda for Europe (2014). *Final report: Study on e-government and the reduction of administrative burden (SMART 2012/0061)*. Retrieved February 4, 2016, from <https://ec.europa.eu/digital-agenda/en/news/final-report-study-egovernment-and-reduction-administrative-burden-smart-20120061>
- Gasser, U., & Palfrey, J. (2007). *Breaking down digital barriers: How and when ICT interoperability drives innovation*. Berkman Publication Series. The Berkman Center for Internet & Society, Harvard University. Retrieved February 3, 2016, from <https://cyber.law.harvard.edu/interop/pdfs/interop-breaking-barriers.pdf>
- Groningen Declaration (2012). *Full text of the Groningen Declaration*. Retrieved January 27, 2016, from <http://www.groningendeclaration.org/full-text-groningen-declaration>
- FCCN (n.d.). *RCTS Plus: Connectivity and infrastructure: Services*. Retrieved January 26, 2016, from <https://www.fccn.pt/en/services/connectivity-and-infrastructure/rcts-plus/>

- FCCN (n.d.). *RCTSaai Federation: Connectivity and infrastructure: Services*. Retrieved February 5, 2016, from <https://www.fccn.pt/en/services/connectivity-and-infrastructure/rctsaai-federation/>
- ICEF Monitor (2015). *The state of international student mobility in 2015: Market intelligence for international student recruitment*. Retrieved January 27, 2016, from <http://monitor.icef.com/2015/11/the-state-of-international-student-mobility-in-2015/>
- OAuth Community Site. (n.d.). Retrieved February 5, 2016, from <http://oauth.net/>
- OpenStack Open Source Cloud Computing Software. (n.d.). Retrieved February 5, 2016, from <https://www.openstack.org/>
- Ribeiro, L. M., & Valente, L. (2015). Using cloud computing to foster closer links between higher education institutions. In *EUNIS 21st Congress Book of Abstracts - The Journey to Discovery* (pp. 330-332). Dundee, UK: Abertay University. Retrieved February 12, 2016, from http://www.eunis.org/wp-content/themes/eunis/assets/EUNIS2015_Book_of_Abstracts.pdf
- Shibboleth. (n.d.). Retrieved February 5, 2016, from <https://shibboleth.net/>
- Toosi, A. N., Calheiros, R. N., & Buyya, R. (2014). Interconnected cloud computing environments: Challenges, taxonomy, and survey. *ACM Computing Surveys*, 47(1), 7:1-7:47. doi:10.1145/2593512. Retrieved February 5, 2016, from <http://www.cloudbus.org/papers/InterCloud-ACMCS.pdf>

9. AUTHORS' BIOGRAPHIES



Lúgia Maria Ribeiro has been Principal Researcher at the Faculty of Engineering of the University of Porto since 2002. She received her degree in Applied Mathematics in 1977 from the Faculty of Sciences of the University of Porto and holds a PhD in Engineering Science from the University of Minho. She was pro-rector at the University of Porto between 2006 and 2014, being responsible for ICT. Between 2004 and 2006, she was President of EUNIS, after being Vice-President for two years. She is presently a member of the EUNIS Board of Directors.

Her main research areas of interest are computer simulation, high performance computing, information systems, electronic administration and informal learning spaces. <pt.linkedin.com/in/ligiamribeiro>



Rui Humberto Pereira is Invited Assistant Professor at the Polytechnic Institute of Porto - ISCAP since 1998 and is software development team leader at the Polytechnic Institute of Porto. He received his degree in Electrical and Computer Engineering in 1997 at the Faculty of Engineering of the University of Porto and holds a PhD in Software Engineering from the University of Vigo. He has developed his research activities in the areas of information systems, decision support systems, interoperability and database systems, having participated in various national projects. He is author of several articles published in national and international journals.



Osvaldo Pacheco has been Assistant Professor at the Department of Electronics, Telecommunications and Informatics of the University of Aveiro since 1996 and is a researcher at the Institute of Electronics and Informatics Engineering of Aveiro. He has been pro-rector at the University of Aveiro since 2010, being responsible for ICT. Over recent years, he has developed his research activities in the area of information systems and in the area of decision support systems, having participated in various national and international projects. He is author of several articles published in national and international journals and of a book.



Mário Bernardes is currently ICT director at Coimbra University, where he has been developing activity in system and network administration for more than thirty years. His educational experience dates from 2004, through the teaching of several curricular units in Internet technologies and information systems at the Faculty of Economics and Faculty of Humanities at master's level. He is member of the Institute of Electrical and Electronics Engineers and co-author of two books, "TCP, Teoria e Prática" and "Administração de Redes Informáticas".



Ricardo Martins is IT Engineer at the University of Aveiro since 1997. In the past decade he was responsible for directing the IT Support Team at the same University and for the execution of several projects in Datacenter, Communications, Security and Systems areas. Now, and since 2013, he is the ICT Director at the University of Aveiro.