

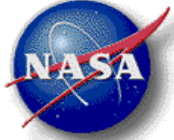

Thermal Hydraulics for Nuclear Space Applications

*Mike Houts
Sonny Mitchell
Ken Aschenbrenner
Melissa Van Dyke*

NASA Marshall Space Flight Center



Nuclear Thermal Propulsion (NTP)

[STMD \(GCD\) Nuclear Thermal Propulsion Video](#)

<https://www.youtube.com/watch?feature=youtu.be&v=miy2mbs2zAQ&app=desktop>

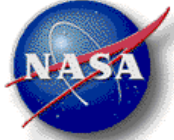

Background: *NTP Benefits*

- For human Mars missions, NTP can reduce crew time away from earth from >900 days to <500 days while still allowing ample time for surface exploration
 - Reduce crew exposure to space radiation, microgravity, other hazards
- NTP can enable abort modes not available with other architectures
 - Potential to return to earth anytime within 3 months of earth departure burn, also to return immediately upon arrival at Mars
- Stage/habitat optimized for use with NTP could further reduce crew exposure to cosmic rays and provide shielding against any conceivable solar flare
- NTP can reduce cadence and total number of SLS launches
- NTP has potential for reducing cost, increasing flexibility, and enabling faster response times in cis-lunar space
- First generation NTP is a stepping stone to fission power systems and highly advanced nuclear propulsion systems that could further improve crew safety and architectural robustness



Why is NTP Attractive for Human Missions to Mars?

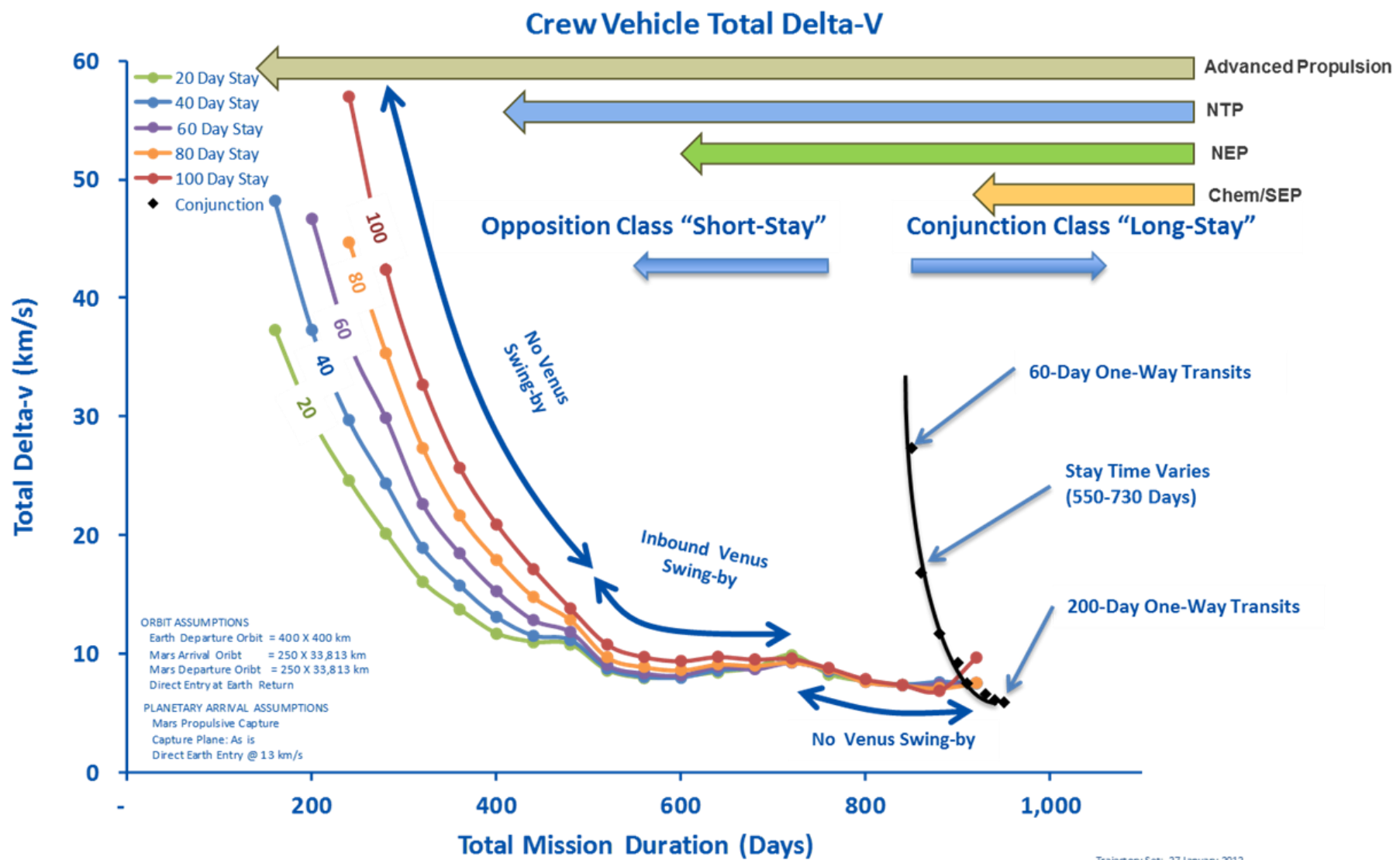

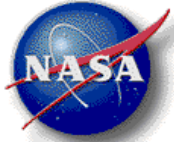

How Might Initial NTP Systems Work?

- Propellant heated directly by a nuclear reactor and thermally expanded/accelerated through a nozzle
- Low molecular weight propellant – typically Hydrogen
- Thrust directly related to thermal power of reactor: $100,000 \text{ N} \approx 450 \text{ MW}_{\text{th}}$ at 900 sec
- Specific Impulse directly related to exhaust temperature: 830 - 1000 sec (2300 - 3100K)
- Specific Impulse improvement over chemical rockets due to lower molecular weight of propellant (exhaust stream of O₂/H₂ engine actually runs hotter than NTP)

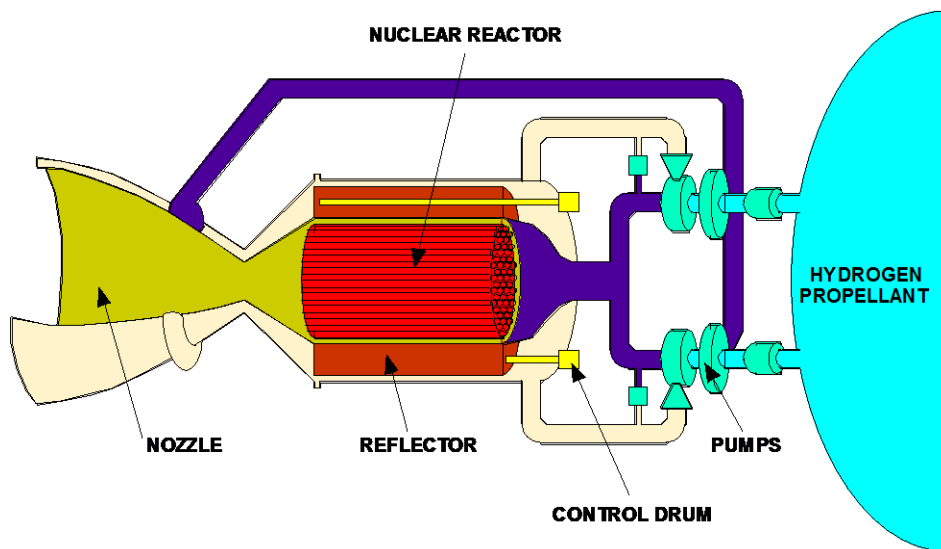

Major Elements of a Nuclear Thermal Rocket

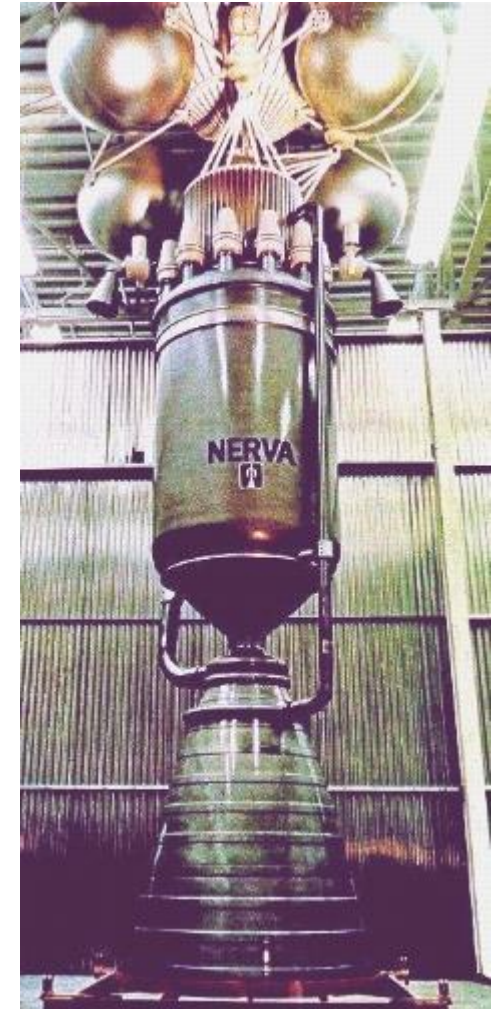

NERVA Nuclear Thermal Rocket Prototype

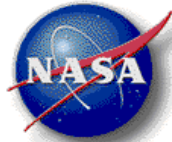

How Might Initial NTP Systems Work?

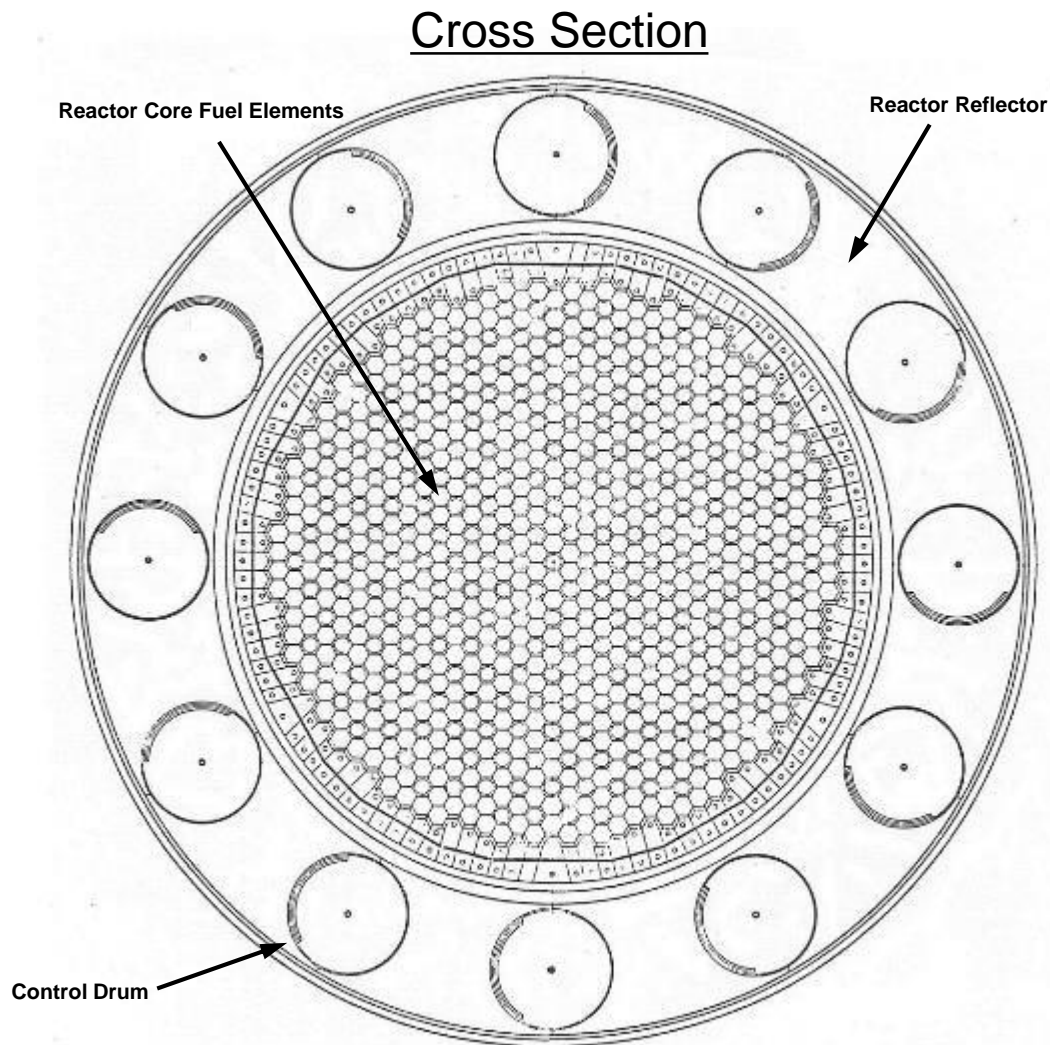
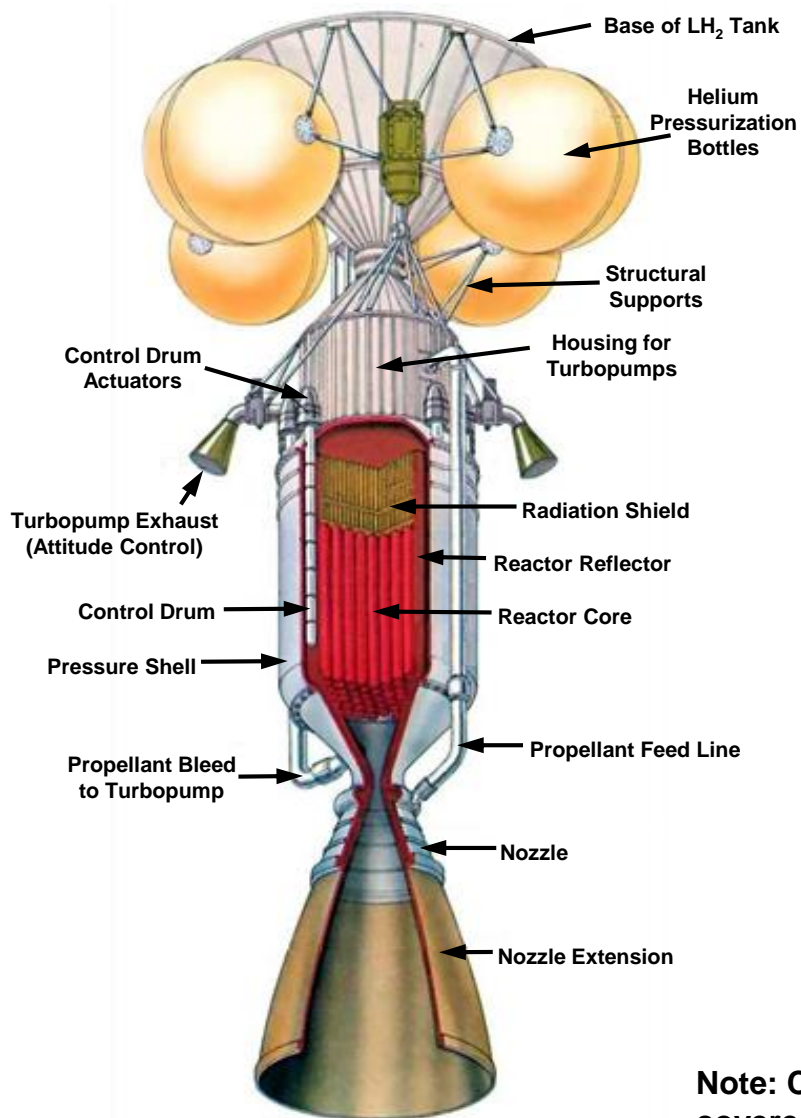

Note: Control drums rotate to control reactivity. Portion of circumference covered with neutron absorber and remainder is reflector.

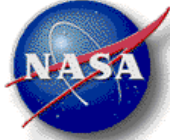

Nuclear Thermal Propulsion (NTP) and Space Fission Power (SFP) Thermal Hydraulic Considerations

- First generation NTP systems will use H_2 as propellant (coolant).
- H_2 used to cool nozzle, neutron reflector, structure, moderator tie tubes, and fuel. Temperature increase of > 2500 K (turbopump to reactor outlet) in < 1 second.
- NTP requires rapid startup. Warm critical to ~ 500 MW in < 30 seconds.
- NTP has short operating time (typically < 15 minutes/burn), but decay heat removal still required.
- Potential option to use neutron and gamma heating to pressurize propellant tank.

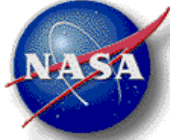

Nuclear Thermal Propulsion (NTP) and Space Fission Power (SFP) Thermal Hydraulic Considerations

- First generation space fission power systems may use heat pipes for cooling, especially at unit power levels < 50 kWe.
- Higher power fission systems may be heat pipe cooled, gas-cooled, or cooled by an alkali metal.
- Performance benefit from high temperature operation.
- Desire long-life, no maintenance.

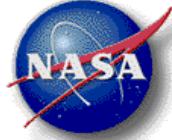

NTP Ground Testing May also Benefit from State-of-the-Art Thermal Hydraulics (Exhaust Capture Concept)

Total Containment NTP Exhaust System

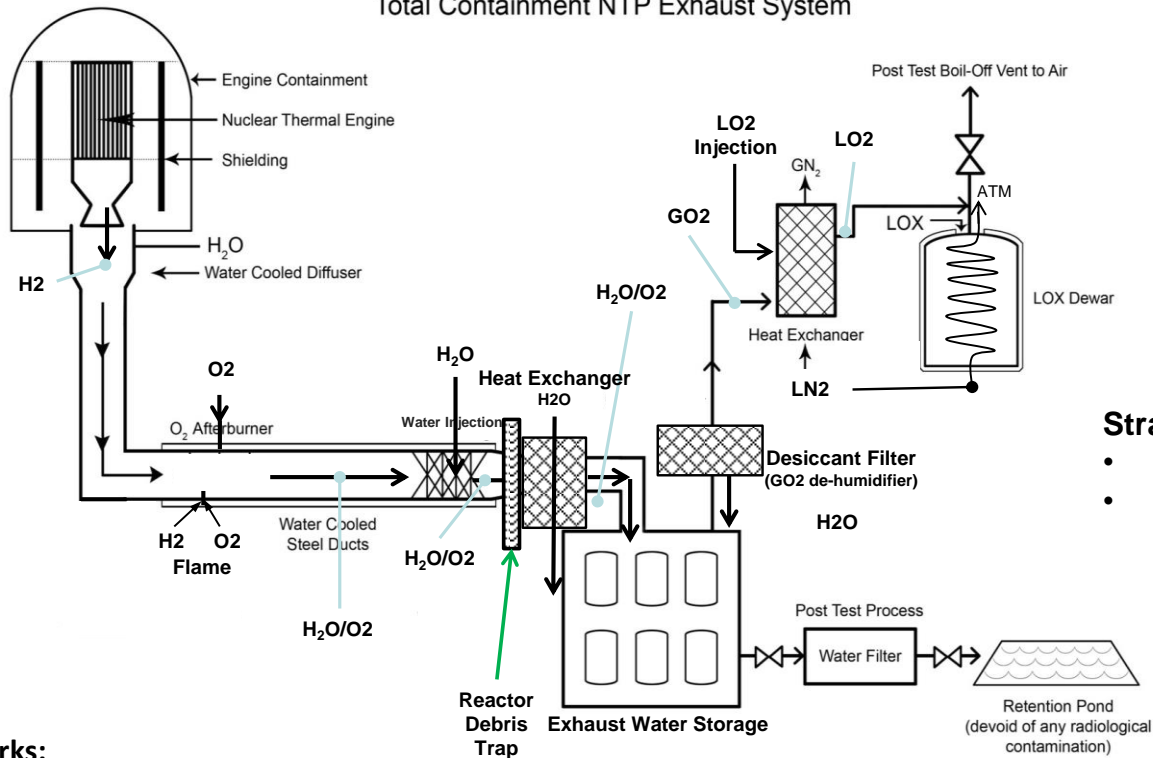

Strategy:

- Fully Contain engine exhaust
- Slowly drain containment vessels after test

How it works:

- Hot hydrogen exhaust from the NTP engine flows through a water cooled diffuser that transitions the flow from supersonic to subsonic to enable stable burning with injected LO₂
 - Products include steam, excess O₂ and potentially, a small fraction of noble gases (e.g., xenon and krypton)
- Water spray and heat exchanger dissipates heat from steam/O₂/noble gas mixture to lower the temperature and condense steam
- Water tank farm collects H₂O and any radioactive particulates potentially present in flow.
 - Drainage is filtered post test.
- Heat exchanger-cools residual gases to LN₂ temperatures (freezes and collects noble gases) and condenses O₂.
 - LOX Dewar stores LO₂, to be drained post test via boil-off

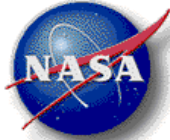

SSC's Acoustic Buffer Zone

Illustration of Comparable NRC-Designated Planning Zones

13,800 Acre
Fee Area/"Exclusion Area"
(20 mi²)

"Fee Area" Avg. Radius ~ 2.5 mi

125,000 Acre
Buffer Zone/"Low-Population Zone"
(195 mi²)

"Buffer Zone" Avg. Radius ~ 7.9 mi

•Slidell, LA
•Population ~ 27,000
•PCD from A3 ~ 8 miles
=> LPZ < 6 miles

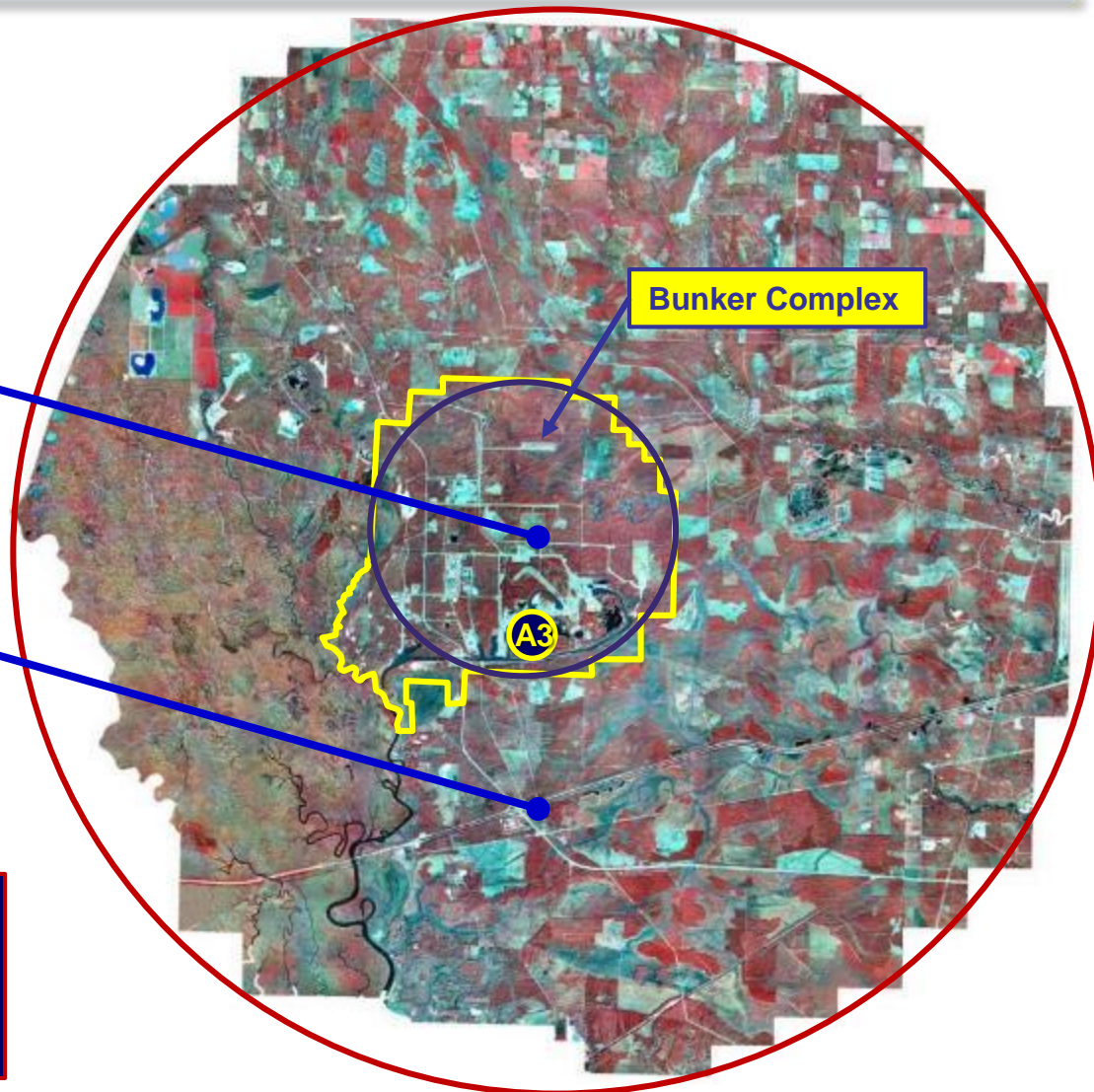

PCD (Population Center Distance ~8 miles) > 1.333 x LPZ ~ 1.333 x 6 miles ~ 8.0 miles

Ref.: NRC Regulatory Guide 4.7

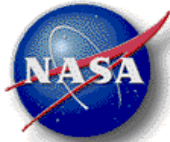

Advances in Thermal Hydraulics Could Help Enable Extremely Advanced Systems

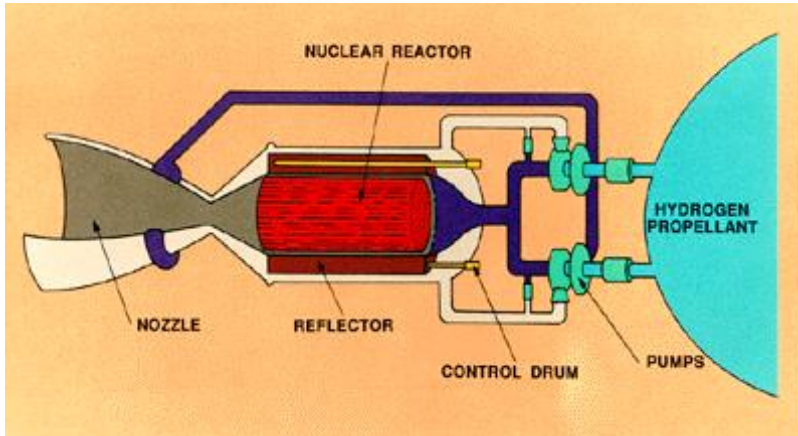

SOLID CORE NUCLEAR ROCKET

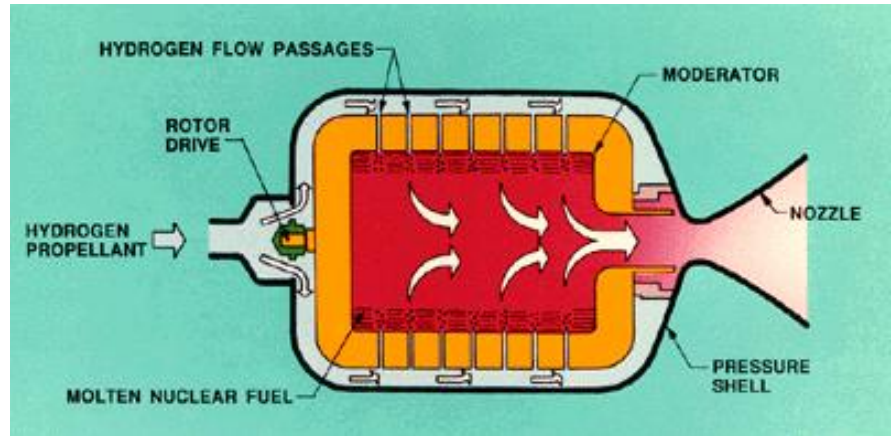

LIQUID CORE NUCLEAR ROCKET

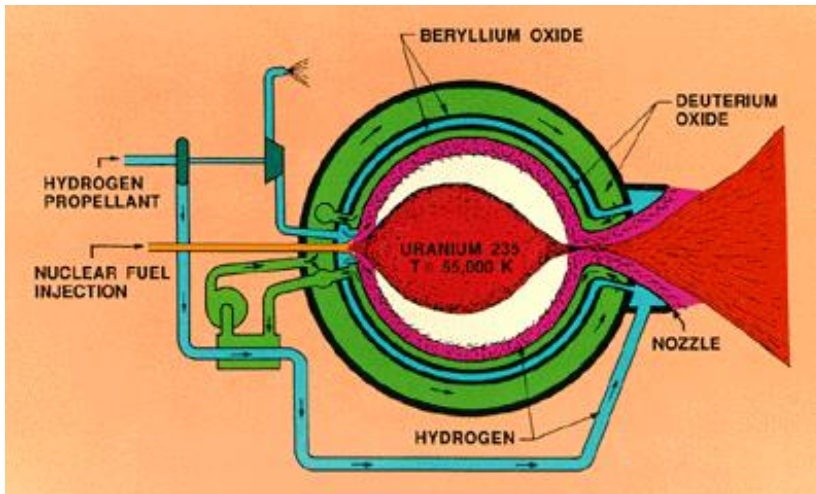

Open-Cycle Gas Core Nuclear Rocket

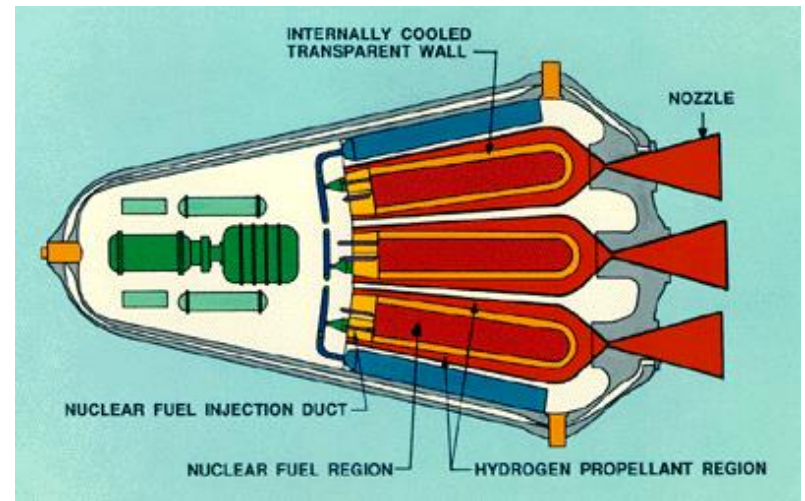

Closed-Cycle Gas Core Nuclear Rocket

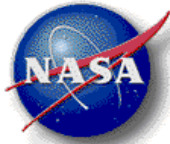

Nuclear Thermal Propulsion (NTP) and Space Fission Power (SFP) Fuels

- Space reactors require specialty fuels.
- NTP requires very high power density (~ 5 MW/L) and very high temperature (up to 2850 K) for short periods of time (~ 2 hours) and at low burnup ($\sim 0.1\%$).
- SFP requirements vary with application. Low power systems (~ 1 kWe) benefit from high U-235 density. High power systems benefit from fuels with high temperature, high burnup capability.

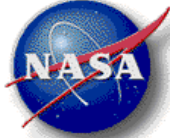

Can NTP systems using Low-Enriched Uranium (LEU) be Developed?

- Directly reduce cost through savings related to safeguards and security
- Indirectly (and more significantly) reduced cost through enabling use of an optimal development approach and team
- Consistent with ongoing programs to convert operational Highly Enriched Uranium (HEU) systems to LEU
- Consistent with US policy. “The United States is committed to eliminating the use of HEU in all civilian applications, including in the production of medical radioisotopes, because of its direct significance for potential use in nuclear weapons, acts of nuclear terrorism, or other malevolent purposes.” (2012 White House “Fact Sheet”)

Initial LEU Conceptual Designs Very Promising

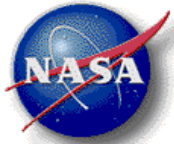

Evolving LEU Designs Have Significant Potential Advantages

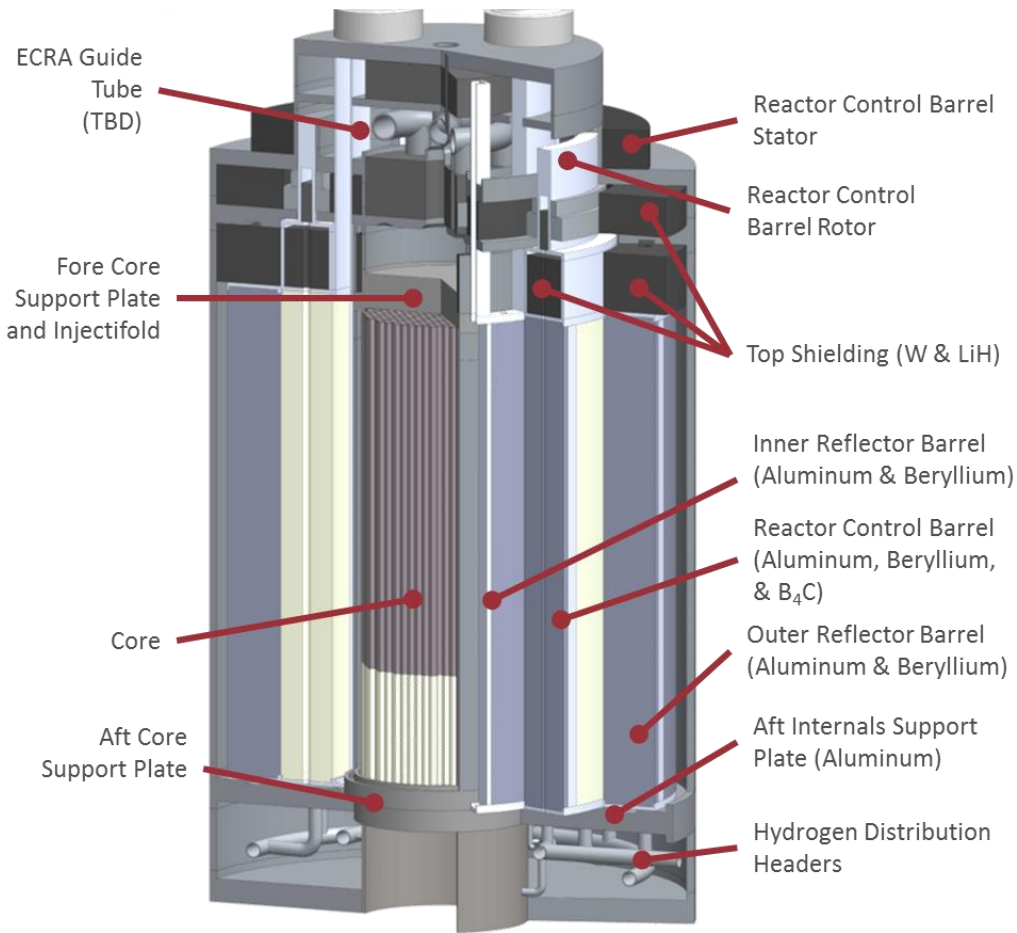

- Graded Mo to Mo/W approach reduces engine mass and need for W-184.
- Multiple potential cermet fuel fabrication options. Optimize for performance and affordability.
- Potential for dual-use core design. Optimize for NTP, but close derivatives potentially applicable to high performance space fission power systems.

Courtesy BWXT

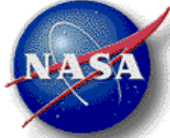

LEU Fission System Considerations

- Greatly reduced safeguards considerations if LEU is used. US encourages use of LEU in nuclear programs around the world.
- No uniquely hazardous materials in fission systems prior to operation. LEU toxicity comparable to depleted uranium. Depleted uranium used in shielding for industrial radiography cameras, trim weights in aircraft (up to 1500 kg in Boeing 747-100), sailboat keels, ammunition, armor plating, etc. Beryllium used in most modern spacecraft. James Webb telescope contains ~300 lbs of beryllium.
- Primary potential hazard from space fission systems is inadvertent criticality while personnel are in very close proximity (i.e. ground processing). Highly affected radius is < 10 m. System design and procedures for precluding inadvertent criticality during ground processing can be made independent of launch vehicle specifics.
- For criticality (with significant fissions) to occur during a launch failure the system must remain geometrically intact while safety mechanisms are simultaneously removed. Designs to preclude this can be made independent of launch vehicle specifics.

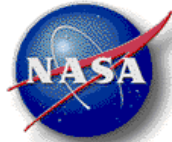

Previous NTP Engine Designs (Rover / NERVA)

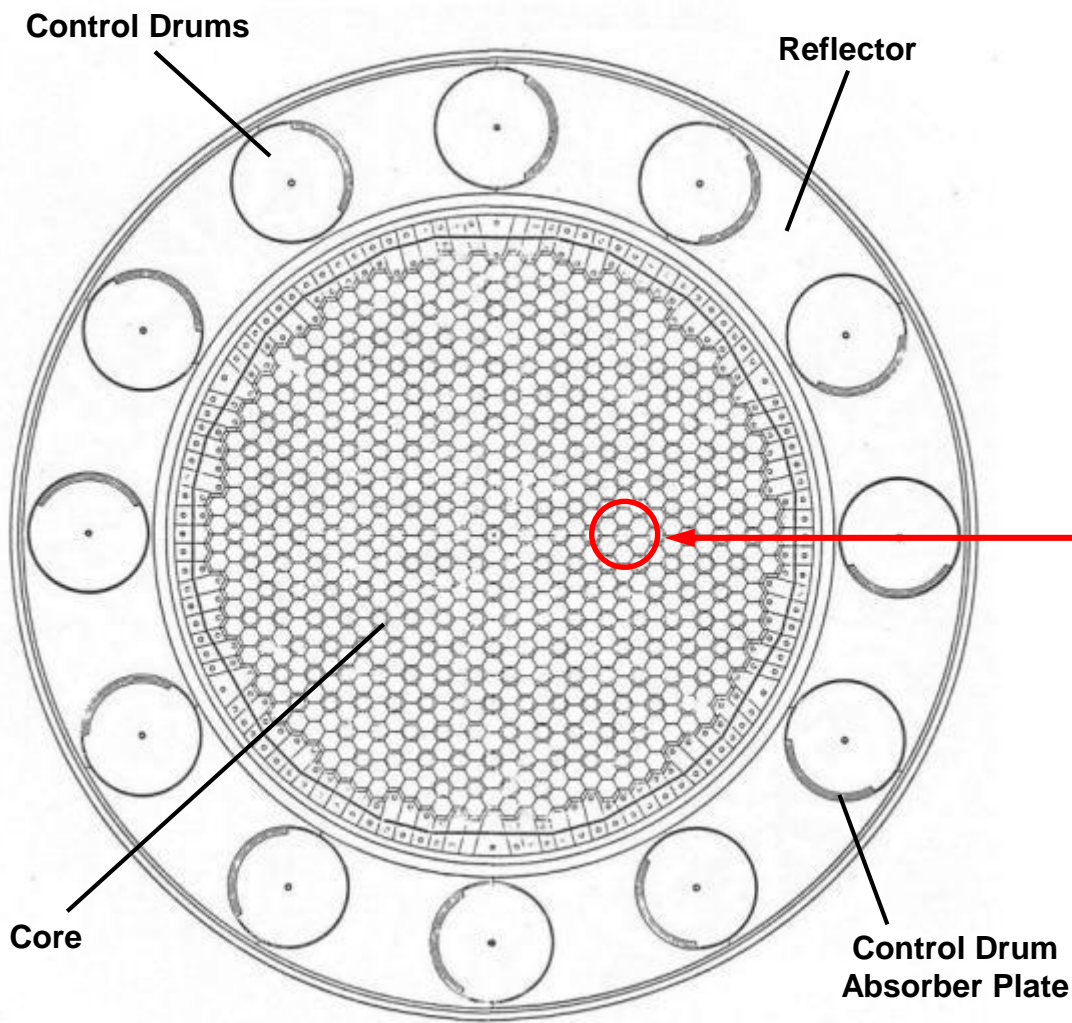

NERVA Reactor Cross Section

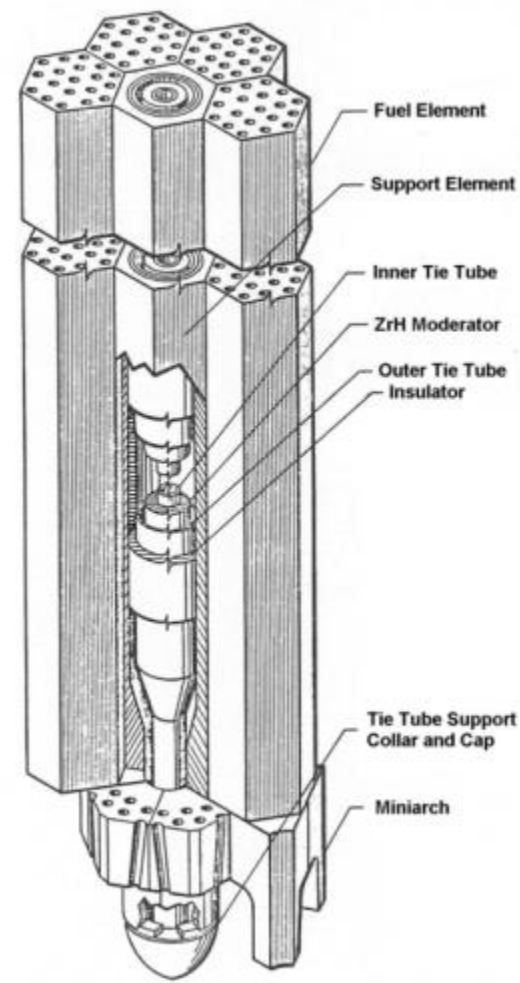

Fuel Segment Cluster



20 NTP Engines Designed, Built, and Tested During Rover/NERVA

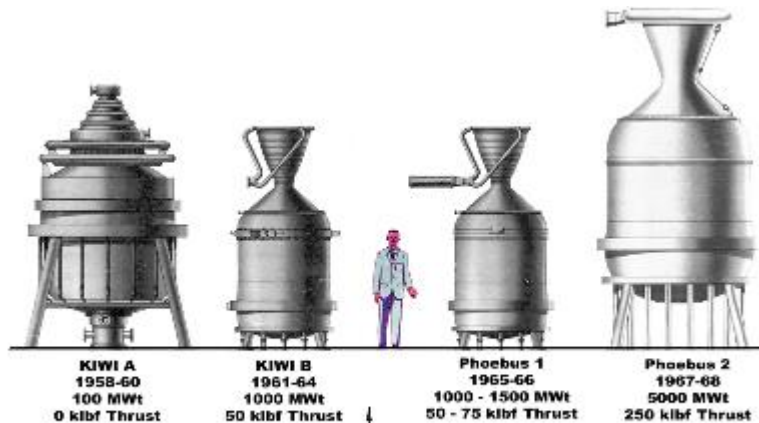
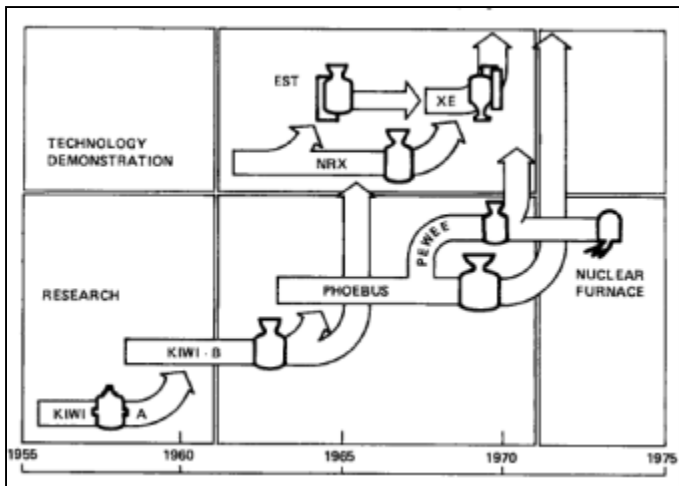

NRX series begins (6 system tests) as part of the NERVA program

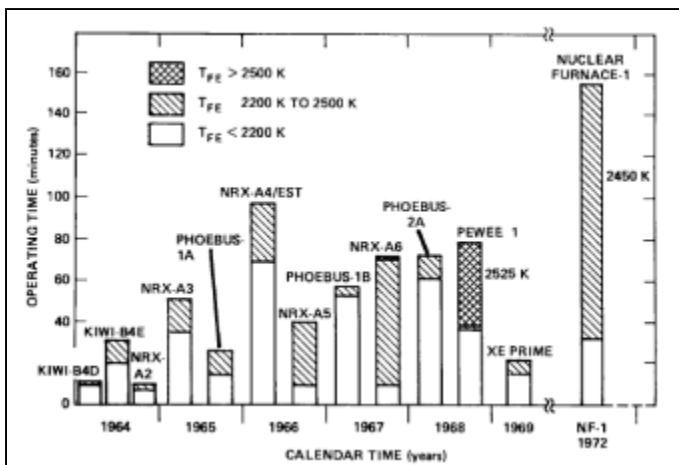

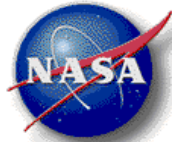

Fission Can Provide the Energy for Either Nuclear Thermal or Nuclear Electric Propulsion Systems

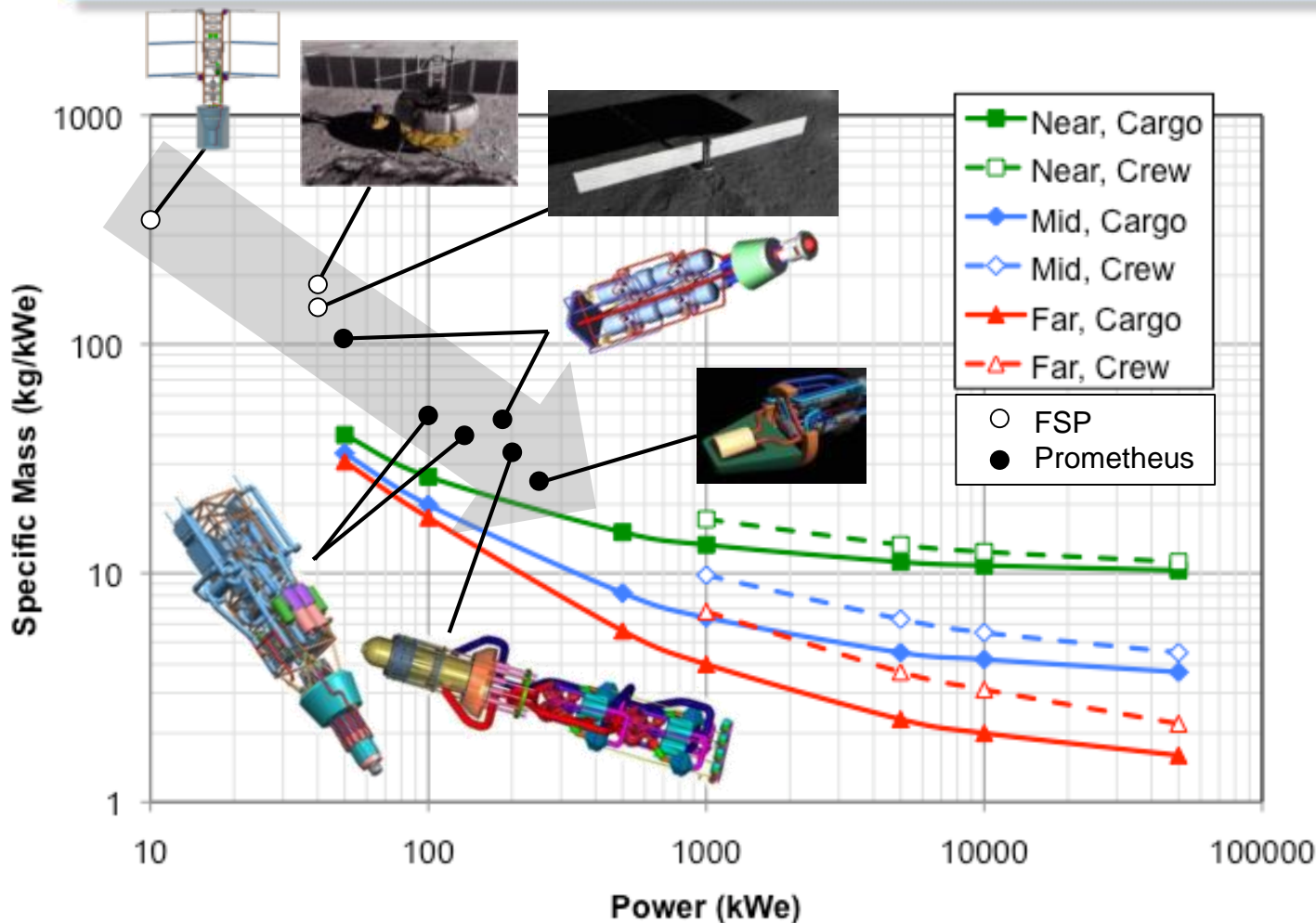

- NEP Power System Performance Projections from 2001 STAIF Conference
- Fission Surface Power and Prometheus Concepts Superimposed

Near=Liq Metal Rx, Brayton, 1300K, 6 kg/m², 200 Vac (Available ~10 yrs)
 Mid=Liq Metal Rx, Brayton, 1500K, 3 kg/m², 1000 Vac (Available ~ 15-20 yrs)
 Far=Liq Metal Rx, Brayton, 2000K, 1.5 kg/m², 5000 Vac (Available ~ 25-30 yrs)
 Cargo=Instrument rated shielding, 1.6x10¹⁵ nvt, 1.2x10⁸ rad @ 2 m
 Crew=Human rated shielding, 5 rem/yr @ 100 m, 7.5° half angle

Chart courtesy
 Lee Mason,
 NASA GRC

Kilopower-Enabled Concepts Family



- **Common Design Features include:**
 - 0.5 to 10 kWe; >10 year design life
 - Utilize available UMo reactor fuel from DOE-NNSA
 - Minimize thermal power to simplify reactor design and control
 - Incorporate passive Na heat pipes for reactor heat transport
 - Leverage power conversion technologies from RPS Program (TE, Stirling)
 - Design system so that it can be tested in existing DOE nuclear facilities

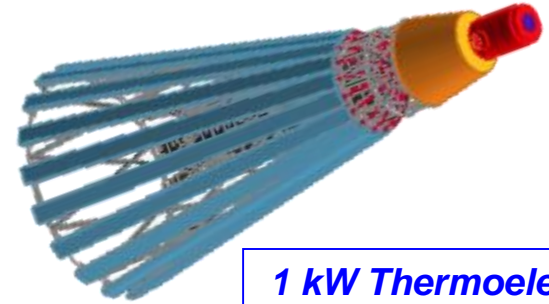

1 kW Thermoelectric
Approx. 4 m long
600 kg or 1.7 W/kg

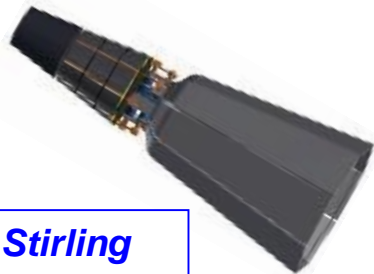

800 W Stirling
Approx. 2.5 m long
400 kg or 2 W/kg

3 kW Stirling
Approx. 5 m long
750 kg or 4 W/kg



10 kW Stirling
Approx. 4 m tall
1800 kg or 5 W/kg



1 kWe-class Technology Demonstration establishes foundation for range of systems and capabilities

Latest Configuration of 1 kW_e Krusty Nuclear Demonstration

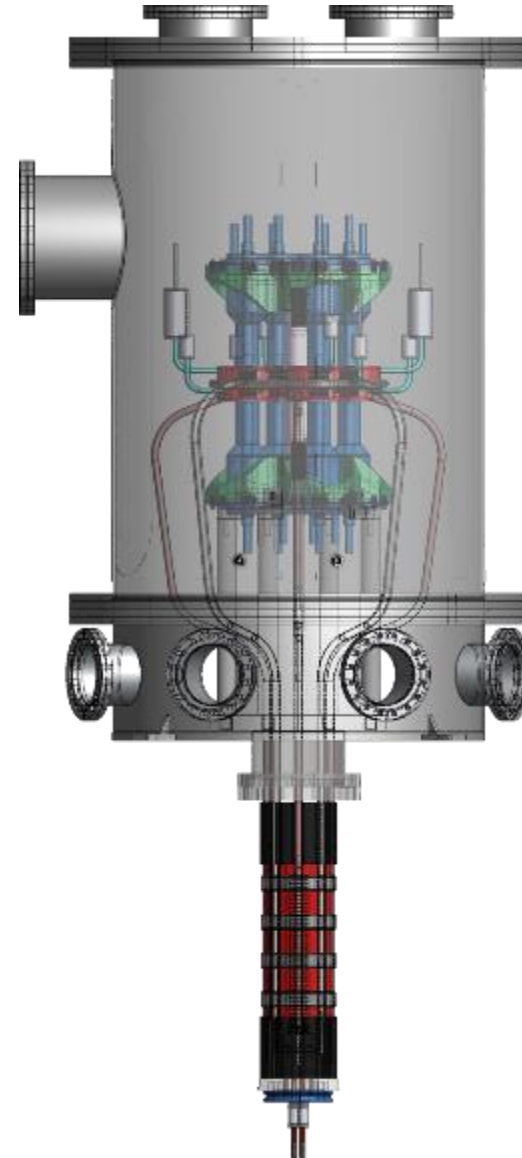
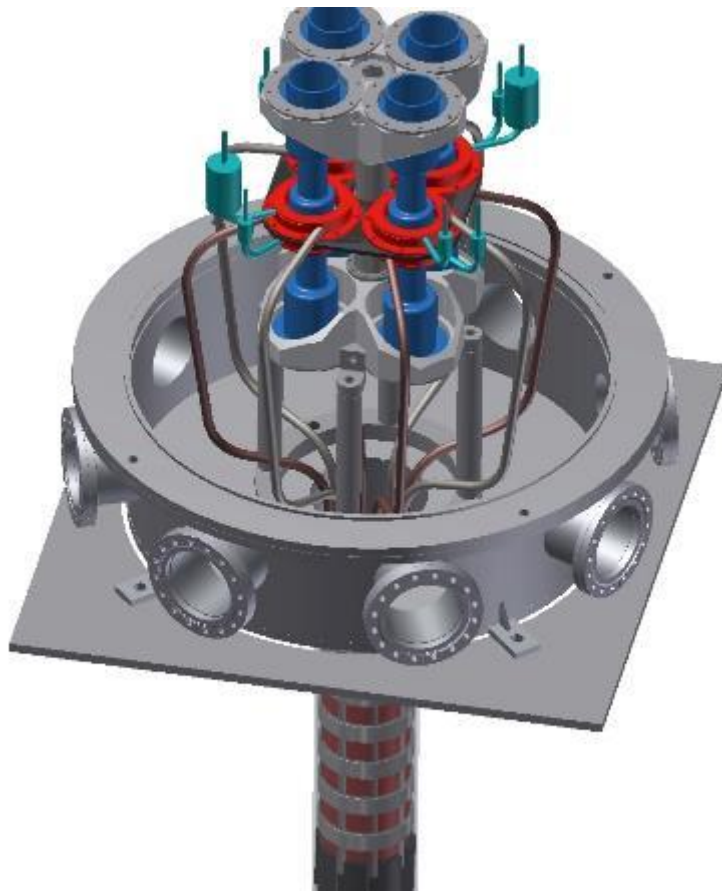

Comparison of HEU vs LEU at 10 kWe (masses (and mass difference) lower if use in-situ shielding)

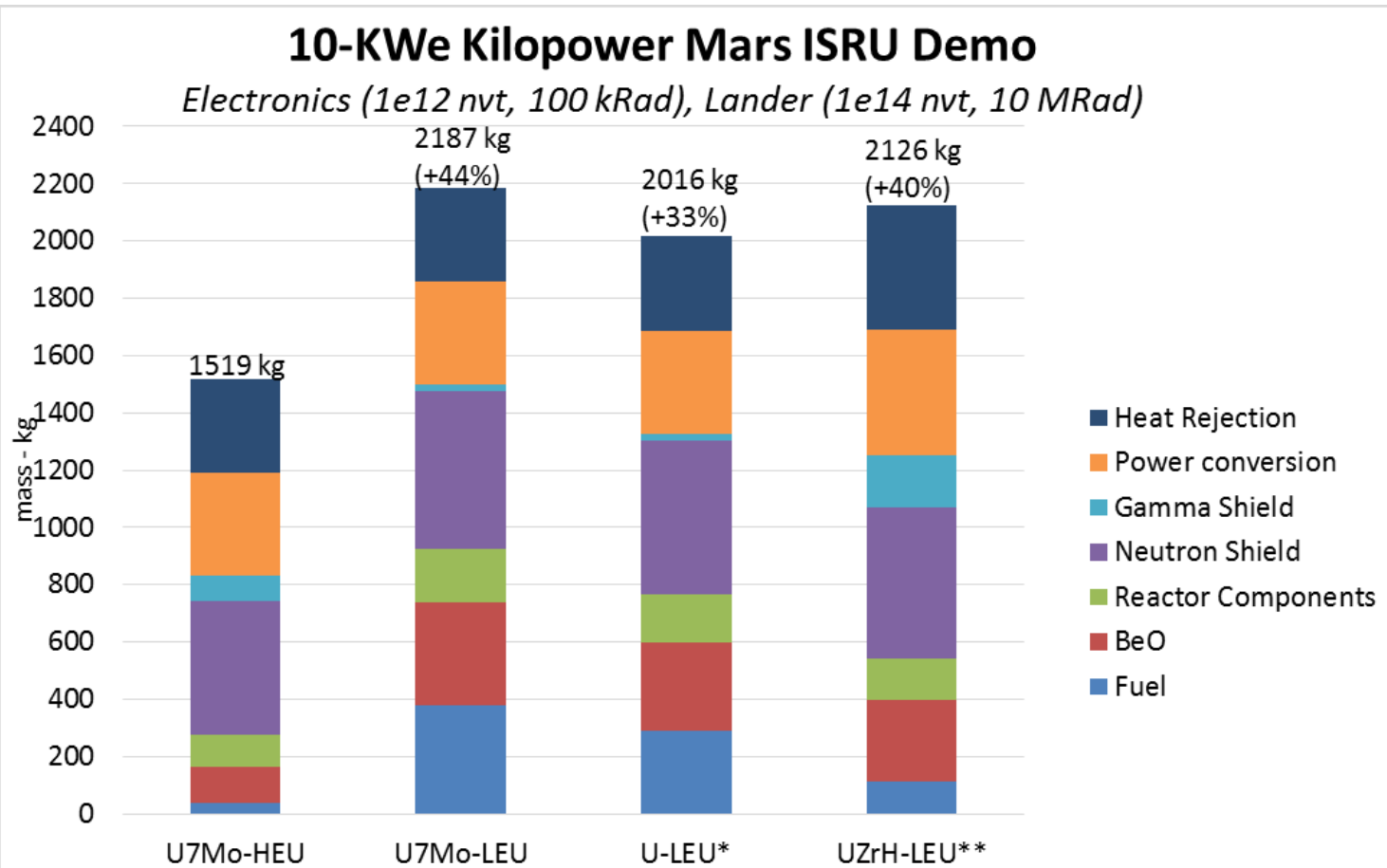

*Un-alloyed U reduces mass, but adds low/modest risk in fuel performance and is different than KRUSTY fuel.

**The UZrH mass shown is extremely optimistic -- neutronically ideal (entire core in single can) and hydrogen loss is 10x less than previous GA estimates; more importantly, development time/cost/risk will be substantially higher for any



Observations

- Space fission power and propulsion systems are game changing technologies for space exploration.
- First generation NTP systems could provide significant benefits to sustained human Mars exploration and other missions.
 - Potential for Earth-Mars transit times of 120 days; 540 day total Mars mission times; reduced crew health effects from cosmic radiation and exposure to microgravity; robust Mars architectures including abort capability.
 - Faster response times, improved capability, and reduced cost for cis-lunar operations. NTP derivatives could enable very high power systems on lunar surface (ISRU) and in space.
- Advanced space fission power and propulsion systems could enable extremely ambitious space exploration and development.