

Accepted Manuscript

Application of response surface methodology for the optimisation of micro friction surfacing process

V.I. Vitanov, N. Javaid, D.J. Stephenson

PII: S0257-8972(10)00278-1
DOI: doi: [10.1016/j.surfcoat.2010.04.011](https://doi.org/10.1016/j.surfcoat.2010.04.011)
Reference: SCT 15666

To appear in: *Surface & Coatings Technology*

Received date: 16 November 2009
Accepted date: 5 April 2010



Please cite this article as: V.I. Vitanov, N. Javaid, D.J. Stephenson, Application of response surface methodology for the optimisation of micro friction surfacing process, *Surface & Coatings Technology* (2010), doi: [10.1016/j.surfcoat.2010.04.011](https://doi.org/10.1016/j.surfcoat.2010.04.011)

This is a PDF file of an unedited manuscript that has been accepted for publication. As a service to our customers we are providing this early version of the manuscript. The manuscript will undergo copyediting, typesetting, and review of the resulting proof before it is published in its final form. Please note that during the production process errors may be discovered which could affect the content, and all legal disclaimers that apply to the journal pertain.

Application of Response Surface Methodology for the Optimisation of Micro Friction Surfacing Process

ACCEPTED MANUSCRIPT

Application of Response Surface Methodology for the Optimisation of Micro Friction Surfacing Process

V. I. Vitanov^a, N. Javaid^b, D.J. Stephenson^b

^a School of Engineering and Computing Sciences, Durham University, Durham, DH1 3LE ^a Telephone: 44 (0) 1913342407, ^a Fax: 44 (0) 1913342377, E-mail: v.i.vitanov@durham.ac.uk (corresponding author)

^b School of Applied Sciences, Cranfield University, Building 70, Cranfield, MK43 0AL, UK.

Abstract

The aim of this work is to identify relationships between the input variables and the process response and to develop predictive models that can be used in the design of new friction surfacing applications. Moreover to investigate the use of standard CNC machines for friction surfacing. The experimental design techniques and response surface methodology were used to investigate and select the combination of factor levels that produced the optimal response. The main effect of the velocity ratio obtained by dividing the feed rate of mechtrode with traverse rate of substrate was observed to be the most significant factor on the process response. Based on the results of optimisation it was observed that the lower to intermediate levels of rotational speed and intermediate to higher levels of velocity ratio produced good coating quality.

Keywords: Friction surfacing, factorial design, response surface methodology, optimisation

1. Introduction

The process in its simplest form involves a rotating consumable rod of coating material that is brought in contact with the substrate under an axial pressure. The heat generated by friction is sufficient to generate a hot plasticized zone within the consumable rod and when the mechtrode is traversed over the substrate, the coating is deposited in the form of a layer (figure 1).

Insert figure 1

This process derives its importance from the need for very hard or corrosion resistant coatings that can be applied to cheaper and tougher substrates in wide variety of material combinations [1]. An important distinction from other coating techniques is the absence of liquid phase, which subsequently results in negligible dilution [2]. The mechanical removal of the oxide films during the process by the scouring action of the formed plasticized layer is another distinct feature of the friction surfacing process [3]. A wide variety of material combinations have been tried ranging from Stainless Steels (austenitic & martensitic) to Nickel and Cobalt based alloys, thereby emphasizing the usefulness of this novel technique [4]. However, the use of friction surfacing process for new applications has been limited due to the difficulty of monitoring and control of the process outputs (bond quality and coating dimensions) specified in most industrial requirements [5]. A variable that is considered to be the most significant and primarily responsible for the coating quality is the temperature at the bond interface [6]. The variation of this temperature with thermo-physical properties (mechtrode and substrate) and substrate geometries result in a complex process response [7]. Empirical investigations are normally required to determine optimum parameters that will produce the required process response.

The approach adopted in industry for the selection of critical process parameters for new coating materials and substrate geometry involves lengthy experimental work usually by

varying one parameter at a time and observing the effect on the process response. Moreover; the commercial implementation of this process is based on specially designed and developed machines which limit the number of applications and require significant initial investment. For the technology to expand and to be commercially viable the use of standard machines for the friction surfacing process with a capability for processing a variety of substrate geometries and material combinations is required. Therefore, the purpose of the presented research was to investigate the use of standard CNC machine for the friction surfacing process and to demonstrate the use of statistical techniques for the selection and optimisation of process parameters when designing new applications.

2. Material and experimental methods

2.1 Materials

The selected materials for substrate and mechtrode were Stainless Steel 316 and Stellite 6, respectively. The Stellite 6 was selected as a coating material because of the specific requirement of high impact wear resistance. The original Stellite was developed at the beginning of the 20th century by Elwood Haynes and consisted of Co with Cr as the single alloying element [8]. Later, additions of W and Mo improved the wear characteristics and further modifications by adding Ni, Si and Mn developed other Stellites for use in high temperature and high impact wear situations. The nominal composition of Stellite 6 (wt %) is given in Table 1.

Insert table 1

2.2 Experimental Details

The experimental work on micro friction surfacing was conducted by adapting a CNC machine for the purpose. The rotational speed (rpm), the feed rate of mechtrode (V_z) and the traverse rate of the substrate (V_x) were the essential machine input parameters. The normal force which is set directly on dedicated machines (for friction surfacing) was represented by

the feed rate V_z of the mechtrode because of the specific requirements of the CNC controller. Normal force (F_n) and substrate temperatures at specific locations were the measurable in process parameters. Bond strength (s) and coating thickness (t) were the process outputs that were measured after the completion of the run. The substrate geometry and its dimensions (mm) are shown in figure 2. The selected geometry allows the process response to be investigated on the basis of variation in substrate thickness.

Insert figure 2

The temperature measurements were taken by using thermocouples (K-type) positioned at the bottom surface of the substrate along the centreline in the traverse direction. The placement ensured that the temperature profile was recorded on each part of the substrate (thick and thin sections) over the deposition length. The substrate shape and thermocouple locations are shown in figure 2. The force was measured by using Kistler, force and torque sensor. The substrate was fixed by means of a special cam locking mechanism that engaged the sides of the substrate. A dedicated program was developed in the Labview software for data acquisition purposes. The bond strength was measured by the push off test as discussed in [5, 9] and the coating thickness was measured by using coordinate measuring machine (CMM).

The experimental run started on the thick portion of the substrate with fixed parameters and half way through the run (over the thin section of the substrate) the parameters were changed. The temperature was measured at four locations at the bottom surface of the substrate, and the measurements from the locations T1 & T2 (figure 2) were used in the analysis since these locations were away from the touch down zone of the process and substrate transition area (change in substrate thickness). The T1 was used to determine the repeatability of temperature measurements, whereas the average force and the measured peak temperature (T2) during the deposition phase were used to establish the relationships between process variables. The figure 3 illustrates the measured force and temperature profiles during the process.

Insert figure 3

2.3 Design of experiments

The (statistical) design of experiments (*DOE*) is an efficient procedure for planning experiments so that the data obtained can be analyzed to yield valid and objective conclusions [10]. The task starts with identifying the input variables and the response (output) that is to be measured. For each input variable, a number of levels are defined that represent the range for which the effect of that variable is desired to be known.

The experiments were designed against a three-level full factorial investigation (3^3 factorial designs), that required 27 runs in total to be performed. The reason for selecting three-level design was that the third level for a factor facilitates investigation of a quadratic relationship between the response and each of the factors [11]. The table 2 indicate the investigated factors and their corresponding levels against which the experimental design was prepared.

Insert table 2

The results from the full factorial investigation for the selected material combination and substrate geometry are shown in table 3. The parameters of traverse rate (V_x), feed rate (V_z) and rotational speed (*RPM*) were varied to investigate the process response of coating thickness (along the length of the deposit), coating regularity and bond strength. Whereas the normal force and the temperature at the bottom surface of the substrate are variables which were measured during the process.

Insert table 3

The term regularity corresponds to the standard formulated (table 4) based on the variation in thickness of the deposited layer. The coating regularity was introduced to monitor the variation in coating thickness since the desired thickness on the component could only be achieved if the variation is small.

Insert table 4

2.4 Response Surface Methodology

Response Surface Methodology (RSM) can be regarded as a collection of statistical and mathematical techniques useful for optimizing objective functions. The methodology is based on approximation of the objective function by a low order polynomial on a small sub-region of the domain [12]. Given a response variable Y and k factors, X_1, \dots, X_k , the main purpose of RSM is to find the combination of factor levels to achieve the optimal response. For computational convenience, the variables are usually converted to coded or design variables, x_1, \dots, x_k , standardized so that the design centre is at the point $(x_1, \dots, x_k) = 0$. Moreover it is assumed that the true response is a function of the levels of the k design variables, $f(x_1, x_2, \dots, x_k)$, called the true response function [13].

In present work the RSM was applied to investigate/study the effect of input variables on the coating quality. Following the full factorial design, 27 values for each response were obtained and were used to estimate the coefficients of reduced and full second order models. Based on the analysis the effects (main and interaction) that were statistically significant were included in the developed models. A quadratic response surface with design variable inputs x_1 and x_2 and output variable y was formulated as:

$$y = \beta_0 + \beta_1 x_1 + \beta_2 x_2 + \beta_3 x_1^2 + \beta_4 x_2^2 + \beta_5 x_1 x_2$$

Where y is the response function and β_i ($i = 0, \dots, 5$) are the unknown coefficients that were estimated by least squares fitting of the model to the experimental results obtained at the design points. As in fitting any regression model, the analysis of the residuals from the fitted model is necessary to determine the adequacy of the least squares fit. This was achieved by an estimate of R-squared values. The normal probability plot becomes essential as it provides information about the absence of any serious violation of the normality assumption. For this assumption to be true the points in the plot will roughly form a straight line. After necessary validation of the obtained models, a visual interpretation of the functional relations was made by using different projections and graphic illustrations of the response surfaces.

3. Results and Discussion

3.1 Analysis of variance

The results of analysis are summarized in table 5.

Insert table 5

The R^2 values for the models, computed as $R^2 = (\text{Sum of squares attributed to the regression})/(\text{Total sum of squares})$, were above 0.60, that implied that at least 60% of the variability in the data for each response was explained by the models. In addition, the normal probability plots of the obtained residuals (figure 4) did not reveal anything particularly troublesome.

Insert figure 4

3.2 Fitted regression models

The three input variables selected for this study and their levels were described in table 2. Experimental design expressed in uncoded variables and the obtained response values were shown in table 3. Those response values were used to compute the model coefficients by using the least square method (table 6). The coefficients and the corresponding P-values obtained from the statistical test allowed us to conclude that the main effect of the velocity ratio (feed rate of mechtrode divided by the traverse rate of substrate) was the most significant factor on the process response. The P-value test is normally performed to determine the effects (main or interaction) in the model which are statistically significant.

Insert table 6

3.3 Interpretation of response surface models

The relationship between the responses and the experimental variables were illustrated graphically by plotting both the response values versus the experimental factor values simultaneously. Such plots were helpful in studying the effects of the variation of the factors in the domain studied and, consequently, in determining the optimal experimental conditions. The topography of the three-dimensional response surfaces were also illustrated by

isoresponse contour lines that represent curves of constant response on a two-variable plain. Response surfaces and isoresponse curves for each of the considered response variable were prepared by fixing the experimental factors at their intermediate levels.

3.3.1 Bond Strength Evaluation

To investigate the effect of rotational speed and velocity ratio on bond strength, the prepared surface and contour plots are shown in figure 5.

Insert figure 5

The general trend observed was that for a given velocity ratio the increase in rotational speed would decrease the bond strength; however for a given rotational speed the increase in velocity ratio would tend to increase the bond strength. These observations are not in accordance with earlier findings by [9] (“increase in rotational speed would increase the bond strength”). The increase in bond strength with increase in velocity ratio could be attributed to the higher force being applied at the bond interface.

3.3.2 Coating Thickness Evaluation

Reasonably good deposit thickness was achieved for the considered rotational speeds (800, 1000 & 1500 rpm) even at low velocity ratios (0.2 to 0.3). However, the higher rotational speeds tend to give lower coating thickness for a given velocity ratio. This process behaviour could be explained by considering that the frictional interface area reduces with increase in rotational speed, which results in lesser plasticized layer being generated thus reducing coating thickness.

Insert figure 6

3.3.3 Evaluation of Coating Regularity

Figure 7 illustrates the relationship between the coating regularity and velocity ratio at different rotational speeds. The coating regularity had almost similar relationship with

rotational speed and velocity ratio, as that was observed for average thickness. The coating regularity for lower and intermediate levels of rotational speed appeared to evolve as the velocity ratio was increased. However, the lower level of rotational speed at intermediate to high level of velocity ratio produced good coating regularity. The same line of reasoning could be followed as given for coating thickness (section 3.3.2) to explain the behaviour of coating regularity with process input parameters.

Insert figure 7

3.3.4 Evaluation of Measured Maximum Temperature

The relationship between measured peak temperature (bottom surface of the substrate), velocity ratio and rotational speed is shown below (figure 8);

Insert figure 8

It was observed that the measured peak temperatures (at the bottom of the substrate) were higher for extreme limits of the velocity ratio and rotational speed (levels: low-low and high-high). This effect could be attributed to a thinner deposit layer and hence the reduced distance between the frictional interface and bond interface. Moreover, it was observed from the plots (figures 5, 6, 7 and 8) that the higher temperatures were obtained for those values of rotational speed and velocity ratio, at which the coating quality falls off.

3.3.5 Evaluation of Measured Force

The figure 9 illustrates the relationship between force, rotational speed and velocity ratio. Based on the statistical analysis and the graphical study it was concluded that the effect of rotational speed (within the considered range) on the measured normal force, compared to velocity ratio was insignificant (very slight curvature) and that the velocity ratio was the single dominant factor contributing towards it. However, the relationship between force and velocity ratio was not completely linear as indicated by the analysis of variance.

Insert figure 9

3.3.6 Optimisation

The optimum range of input variables that produced desired results was estimated through the use of overlaid contour plots of the individual process responses (Bond strength, coating thickness and coating regularity).

Insert figure 10

The desired value for each response was calculated by allowing twenty percent variation in the maximum experimental value obtained for that response. The shaded area shown in figure 10 indicates the range of input variables that produced the desired process response. The determined optimal range of input variables required the process to be performed from the lower to intermediate levels for rotational speed and at slightly higher value than the intermediate level for velocity ratio, to produce the bond strength within the range of 1000 to 1200, coating thickness of above 1mm and coating regularity between 8 and 10 (table 4).

4. Conclusions

- The statistical analysis (ANOVA) indicated that the main effect of the velocity ratio (combined effect: calculated by dividing the feed rate of mechtrode with traverse rate of substrate) is the most significant factor on the process response.
- For a given traverse and feed rates increase in rotational speed reduced the coating quality. However, for a given rotational speed there was a specific ratio between feed and traverse rates that had to be maintained for a good bond to exist. Based on the results from optimisation it was observed that the lower to intermediate level of rotational speed at slightly higher value than the selected intermediate level for velocity ratio produced good coating quality.
- The effect of rotational speed on measured normal force was found to be insignificant compared to the velocity ratio (V_z/V_x) within the considered experimental range of

input variables. The peak temperature during the process was obtained for those values of input variables that resulted in poor coating quality.

- The response surface methodology was found to be effective for the identification and development of significant relationships between process variables. However, future empirical investigations could benefit from better representation of design space through the use of central composite designs, since it was observed that the relationships between process variables were highly non-linear.

Acknowledgements

This research was funded by the GIST-CT-2001-50108 EU grant. The authors wish to express their gratitude to Frictec UK and Circle Technical services for their industrial support.

References

- [1] S. B. Dunkerton, W. M. Thomas, Proc. 2nd Int'l. Surf. Eng. Conf., Stratford-upon-Avon, England, June 16-18, 1987, paper 45, 375-386.
- [2] W. M. Thomas, Research Report No. 303/1986, TWI, Abington, Cambridge, UK, (1986) 1-8.
- [3] W. M. Thomas, S. A. Westgate, 2nd special meeting on Flash and Friction Welding, organized by DVS, Aachen, September 3-4, 1987, pages 1-17.
- [4] E. D. Nicholas, W. M. Thomas. 67th AWS Annual Meeting, Atlanta, Ga, April 14-16, 1986, 17-27.
- [5] I. I. Voutchkov, A methodology for modelling, optimization and control of the friction surfacing process. PhD Thesis, Department of Mechanical and Manufacturing Engineering, University of Portsmouth, 2000.
- [6] G. M. Bedford, V. I. Vitanov, I. I. Voutchkov, International Conference on Advances in Materials and Processing Technologies, AMPT'99 and 16th Annual conference of the Irish Manufacturing Committee, IMC16, Dublin, Ireland, August 3-6, 1999, 341-347.
- [7] V. Hughes, A system model for optimization of boundary interface conditions in friction surfacing. PhD Thesis, Department of Mechanical and Manufacturing Engineering, University of Portsmouth, 2002.
- [8] Persson, D., (2005). On the Mechanisms behind the tribological performance of Stellites, PhD thesis submitted to the UPPSALA UNIVERSITY, Sweden (ISBN 91-554-6420-3).
- [9] B. Jaworski, Thermal modelling of the friction surfacing process. PhD Thesis, Department of Mechanical and Manufacturing Engineering, University of Portsmouth, 2003.
- [10] Anthony A. Giunta, Steven F. Wojtkiewicz Jr. and Michael S. Eldred (2003). Overview of modern design of experiments methods for computational simulations, Report (AIAA 2003-0649) by American Institute of Aeronautics and Astronautics, Sandia National Laboratories, Albuquerque, NM USA.
- [11] Engineering Statics Handbook, <http://www.itl.nist.gov/div898/handbook/> accessed on 27th June, 2005.
- [12] Lin, Y.-C., Fregly, B. J., Haftka, R. T., & Queipo, N. V. (2005) Surrogate-based contact modelling for efficient dynamic simulation with deformable anatomic joints. In Proceedings of the Tenth International Symposium on Computer Simulation in Biomechanics, Cleveland, OHIO, USA.
- [13] Sambucini, Valeria (1995). A reference prior for the analysis of a response surface, Dipartimento di Statistica Probability_ae Statistiche Applicate, Universit_a\La Sapienza, Piazzale Aldo Moro 5, Roma 00185, Italia.

List of figure captions

Figure 1: Friction Surfacing Process.

Figure 2: Geometry of the substrate and location of the thermocouples (T_1 and T_2) at bottom surface of substrate (all dimensions in mm).

Figure 3: Plot of experimental temperature and force measurements made by using thermocouples (at the bottom surface of the substrate) and force sensor at a traverse rate of 70mm/min.

Figure 4: Study of residuals of Strength, average thickness, regularity, peak temperature and measured force.

Figure 5: Graphical study of the response strength as a function of defined input variables of rotational speed and velocity ratio.

Figure 6: Graphical study of the response average thickness as a function of defined input variables of rotational speed and velocity ratio.

Figure 7: Graphical study of the response regularity (R) on the basis defined input variables of rotational speed and velocity ratio.

Figure 8: Graphical study of the response measured peak temperature at the bottom surface of the substrate as a function of defined input variables of rotational speed and velocity ratio.

Figure 9: Graphical study of the response average force measured during the deposition phase as a function of defined input variables of rotational speed and velocity ratio.

Figure 10: Graphical study of multiple responses (coating thickness, coating regularity and bond strength) to determine the optimal range of input variables.

Figures

(All figures - Microsoft word document object.)

(Please set the tab at 0.5 to retain the original formatting.)

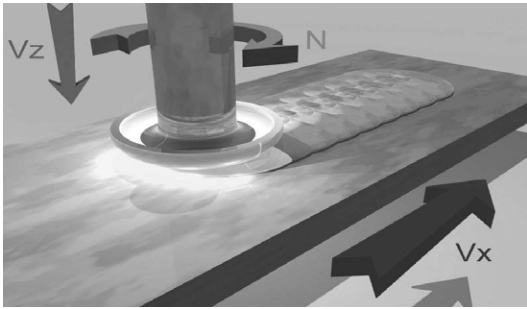

Fig 1. Friction Surfacing Process.

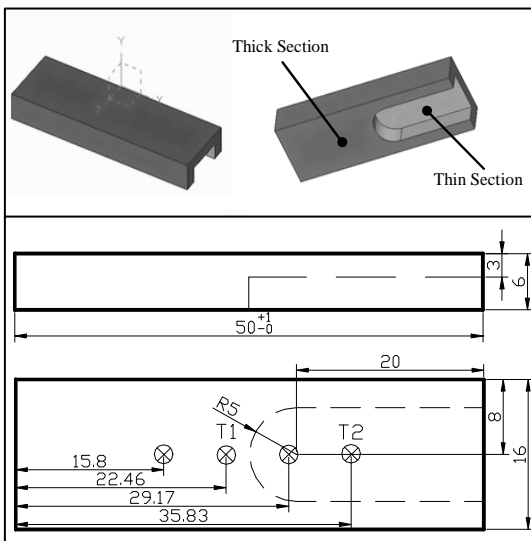

Fig 2. Geometry of the substrate and location of the thermocouples (t_1 and t_2) at bottom surface of substrate.

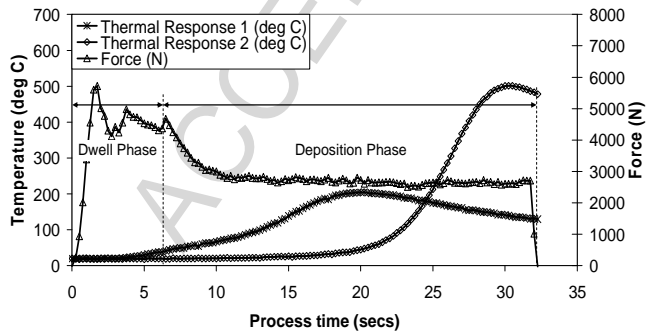

Fig 3. Plot of experimental temperature and force measurements made by using thermocouples (at the bottom surface of the substrate) and force sensor at a traverse rate of 70mm/min.

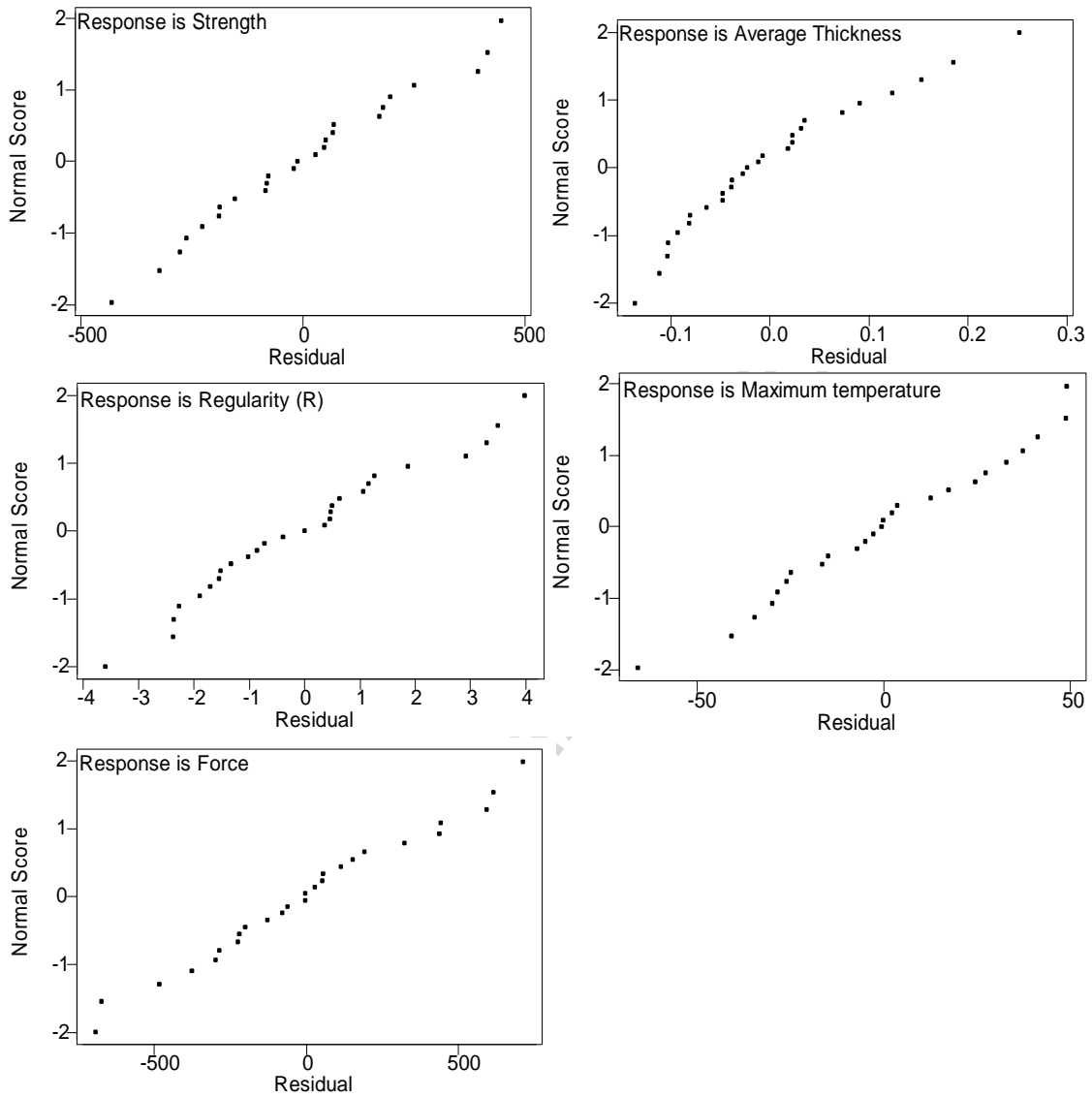
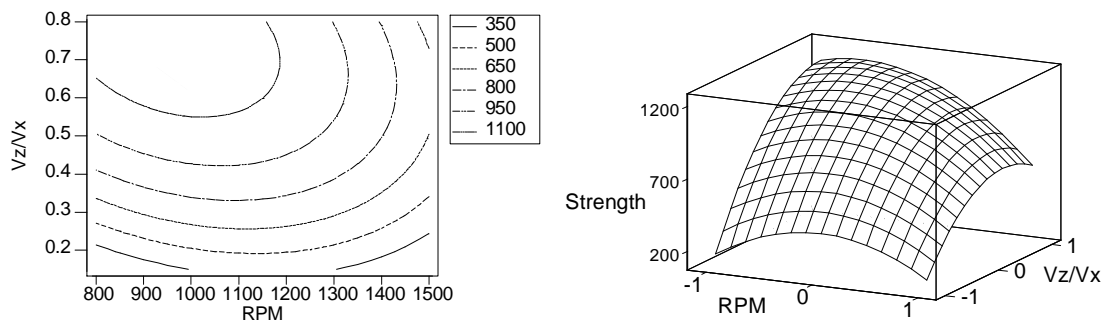

Fig 4. Study of residuals of Strength, average thickness, regularity, peak temperature and measured force.



Graphical study of the response strength as a function of defined input variables of rotational speed and velocity ratio.

Fig 5.

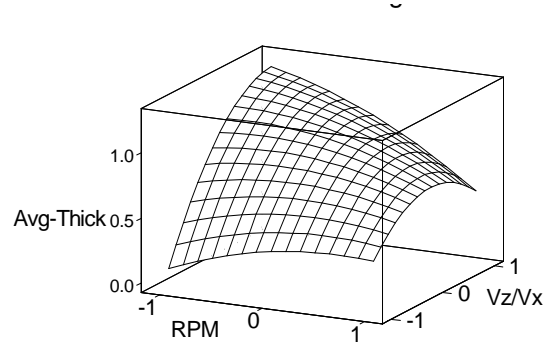
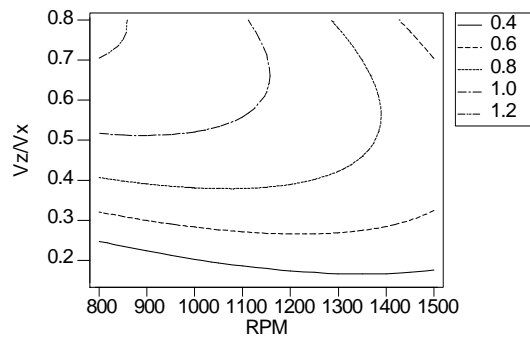

Fig 6.

Graphical study of the response average thickness as a function of defined input variables of rotational speed and velocity ratio.

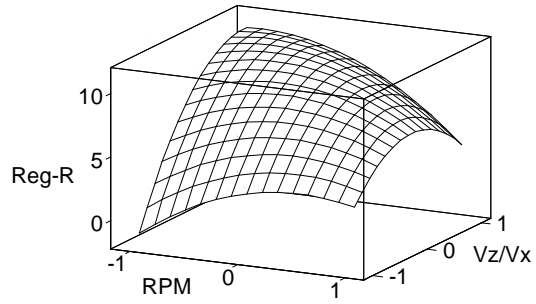
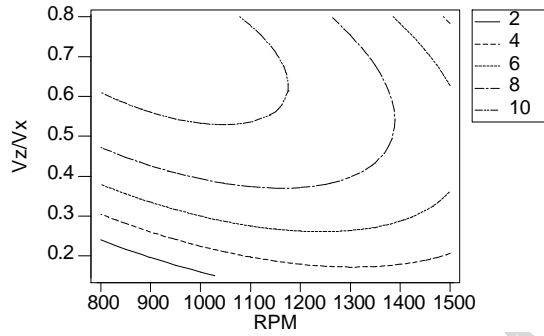

Fig 7.

Graphical study of the response regularity (R) on the basis defined input variables of rotational speed and velocity ratio.

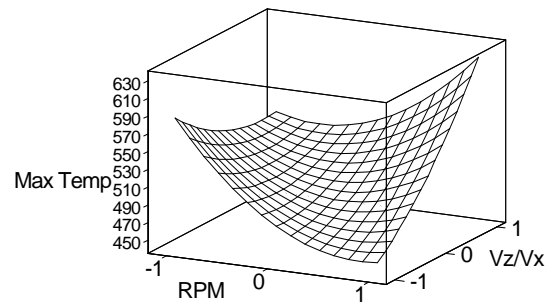
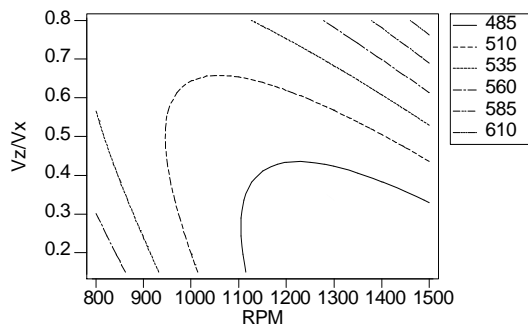

Fig 8.

Graphical study of the response measured peak temperature at the bottom surface of the substrate as a function of defined input variables of rotational speed and velocity ratio.

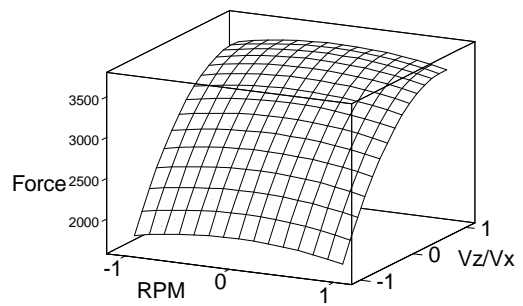
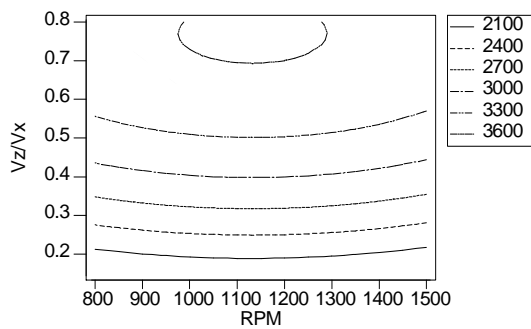

Fig 9.

Graphical study of the response average force measured during the deposition phase as a function of defined input variables of rotational speed and velocity ratio.

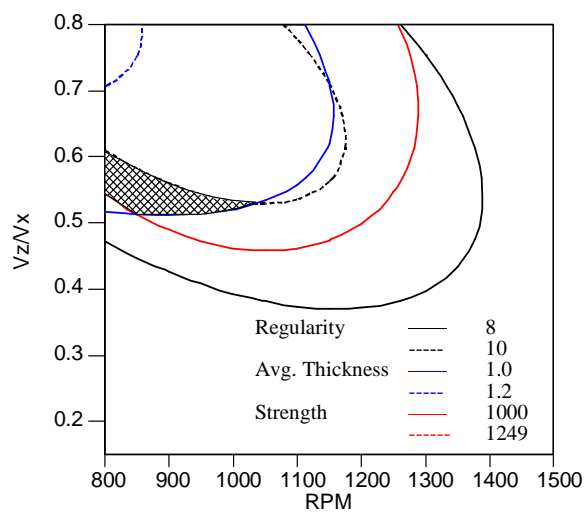

Fig 10. Graphical study of multiple responses (coating thickness, coating regularity and bond strength) to determine the optimal range of input variables.

Tables (Please set the tab at 0.5 to retain the original formatting.)

Table 1

Chemical composition of Stellite 6

Material	Element (%)								
	Co	Ni	Si	Fe	Mn	Cr	Mo	W	C
Stellite-6	balanced	3.0	2.0	3.0	2.0	28.0-32.0	1.50	3.5-5.5	0.9-1.4

Table 2

Factors and levels of the experimental design

S/No.	Factors	Levels		
		1	2	3
1.	RPM	800	1000	1500
2.	Vx (mm/min)	50	70	100
3.	Vz (mm/min)	15	25	40

Table 3

Factors and corresponding responses as per experimental design used

S#	RPM	Vx mm/min	Vz mm/min	Vz/Vx --	Force N	Thickness mm	Strength N	Temperature deg C	Regularity --
2.	800	50	25	0.50	2800	1.20	884	513	9
3.	800	50	40	0.80	3500	1.20	1026	545	10
4.	800	70	15	0.21	4100	0.30	139	623	0
5.	800	70	25	0.36	2900	0.75	1113	524	6
6.	800	70	40	0.57	3100	1.00	1026	520	10
7.	800	100	15	0.15	1800	0.00	203	444	0
8.	800	100	25	0.25	2000	0.35	167	592	0
9.	800	100	40	0.40	3000	0.70	1249	482	10
10.	1000	50	15	0.30	2800	0.60	1143	497	10
11.	1000	50	25	0.50	3200	1.00	896	544	10
12.	1000	50	40	0.80	3600	1.00	882	553	9
13.	1000	70	15	0.21	1500	0.40	180	504	0
14.	1000	70	25	0.36	2900	0.75	895	502	8
15.	1000	70	40	0.57	3300	1.00	881	509	9
16.	1000	100	15	0.15	1200	0.30	172	489	0
17.	1000	100	25	0.25	3000	0.65	596	506	6
18.	1000	100	40	0.40	3700	0.85	1168	467	10
19.	1500	50	15	0.30	2000	0.55	261	621	5
20.	1500	50	25	0.50	2950	0.55	536	564	5
21.	1500	50	40	0.80	3800	0.65	837	583	7
22.	1500	70	15	0.21	2500	0.55	499	479	7
23.	1500	70	25	0.36	2500	0.65	592	489	6
24.	1500	70	40	0.57	3000	0.60	644	549	4
25.	1500	100	15	0.15	1800	0.25	227	435	4
26.	1500	100	25	0.25	2700	0.70	546	439	4
27.	1500	100	40	0.40	2800	0.55	129	534	4

Table 4

Standard for thickness regularity

Regularity (%)	0-4	5-9	10-19	20-29	30-39	40-49	50-59	60-69	70-79	80-89	+90
Rating (R)	0	1	2	3	4	5	6	7	8	9	10

Table 5

AONVA table for the responses

Response	Source	Degrees of Freedom	Sum of Squares	Mean Square	F	P
Strength	Regression	5	1961782	392356	5.67	0.002
	Residual Error	19	1314146	69166		
	Total	24	3275928			
Avg Thickness	Regression	5	2.07589	0.415178	25.97	0.000
	Residual Error	21	0.33578	0.015989		
	Total	26	2.41167			
Regularity	Regression	5	240.269	48.0539	10.00	0.000
	Residual Error	21	100.916	4.8055		
	Total	26	341.185			
Temperature	Regression	5	34400.0	6880.0	6.06	0.002
	Residual Error	19	21574.9	1135.5		
	Total	24	55975.0			
Force	Regression	3	7837582	2612527	16.40	0.000
	Residual Error	22	3504822	159310		
	Total	25	11342404			

Table 6
 Estimated Regression Coefficients for the considered responses

Responses	Term	Coefficient	Standard Error	T	P
Strength	Constant	-2901	1608.80	-1.803	0.087
	RPM	5	2.92	1.559	0.135
	Vz/Vx	5566	1702.13	3.270	0.004
	RPM*RPM	-0.0018	0.00	-1.494	0.151
	Vz/Vx*Vz/Vx	-2915	1489.41	-1.957	0.065
	Vz/Vx* RPM	-2	0.91	-1.769	0.093
Avg Thickness	Constant	-2.039	0.719890	-2.833	0.010
	RPM	0.003	0.001258	2.084	0.050
	Vz/Vx	5.947	0.758566	7.839	0.000
	RPM*RPM	-8.34E-07	1E-06	-1.567	0.132
	Vz/Vx*Vz/Vx	-2.550	0.617736	-4.128	0.000
	RPM*Vz/Vx	-0.002	0.000431	-5.142	0.000
Regularity	Constant	-35.62	12.4802	-2.854	0.010
	RPM	0.05	0.0218	2.230	0.037
	Vz/Vx	67.14	13.1507	5.106	0.000
	RPM*RPM	-1.69E-05	0.0000	-1.842	0.080
	Vz/Vx*Vz/Vx	-30.41	10.7092	-2.839	0.010
	RPM*Vz/Vx	-0.02	0.0075	-3.308	0.003
Temperature	Constant	1221.9	206.894	5.906	0.000
	RPM	-1.0	0.348	-2.925	0.009
	Vz/Vx	-633.4	228.088	-2.777	0.012
	RPM*RPM	0.00033	0.000	2.252	0.036
	Vz/Vx*Vz/Vx	167.0	174.871	0.955	0.352
	RPM*Vz/Vx	0.5	0.121	4.071	0.001
Force	Constant	962	504.61	1.907	0.070
	RPM	-0.087	0.27	-0.326	0.747
	Vz/Vx	6905	1894.93	3.644	0.001
	Vz/Vx*Vz/Vx	-4472	1965.46	-2.275	0.033