



Strathprints Institutional Repository

Elliot, Ross Andrew and Enderwitz, Martin and Darbari, Faisal and Crockett, Louise Helen and Weiss, Stephan and Stewart, Robert (2012) *TVWS filter bank transceiver on OMAP-L137 evaluation module*. In: 5th European DSP in Education and Research Conference, 2012-09-13 - 2012-09-14, Amsterdam. (In Press)

Strathprints is designed to allow users to access the research output of the University of Strathclyde. Copyright © and Moral Rights for the papers on this site are retained by the individual authors and/or other copyright owners. You may not engage in further distribution of the material for any profitmaking activities or any commercial gain. You may freely distribute both the url (<http://strathprints.strath.ac.uk/>) and the content of this paper for research or study, educational, or not-for-profit purposes without prior permission or charge.

Any correspondence concerning this service should be sent to Strathprints administrator: <mailto:strathprints@strath.ac.uk>

TVWS FILTER BANK TRANSCEIVER ON OMAP-L137 EVALUATION MODULE

R.A. Elliot, M.A. Enderwitz, F. Darbari, L.H. Crockett, S. Weiss and R.W. Stewart

Centre for White Space Communications

Department of Electronic & Electrical Engineering, University of Strathclyde, Glasgow, Scotland, UK
 {ross.elliott,martin.enderwitz,faisal,louise.crockett,stephan,bob}@eee.strath.ac.uk

ABSTRACT

Communications devices operating in the TV white space (TVWS) spectrum will be strictly regulated, requiring compliance with spectral masks to protect incumbent users and sufficient frequency agility to allow access to numerous frequency bands at different times and locations. Therefore, future designs sampling directly at radio frequency (RF) have been proposed. The purpose of this paper is to demonstrate an implementation of such a transceiver at a scaled-down frequency implemented on the OMAP-L137 evaluation module, whereby the RF link can be replaced by the device's audio I/O, thus enabling easier observation and algorithm testing for students.

1. INTRODUCTION

In the UK, the television white space (TVWS) spectrum is split into 40 channels of 8MHz bandwidth, ranging from 470 to 790MHz. Access to this section of spectrum will be tightly governed by Ofcom who are expected to enforce a number of requirements to protect incumbent users [1]. These restrictions include strict adherence to spectral masks and a high level of frequency agility to allow devices to adjust frequency based on geo-location. The spectral mask, as outlined in Figure. 1, permits -55dB interference into adjacent channels and -69dB into next-adjacent channels.

Many current wireless standards are based on orthogonal frequency division multiplexing (OFDM) as a modulation scheme. However, OFDM offers only poor frequency selectivity unless very tight additional transmit and receive filters are employed. Therefore, multicarrier transceiver designs based on filter bank techniques, many of which predate OFDM [2, 3, 4, 5], have experienced a renaissance in recent years [6, 7, 8] due to their improved spectral resolution and advantages in synchronisation when compared to OFDM [17, 22].

Typically, operation of filter bank transceivers is confined to baseband where specific frequency bands are di-

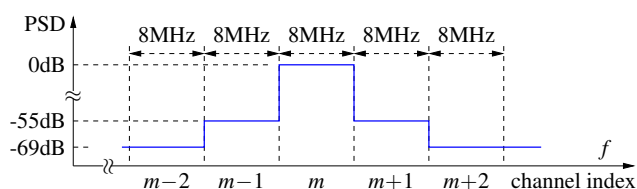

Figure 1: Spectral mask defining PSD levels in adjacent ($m \pm 1$) and next-adjacent 8MHz TVWS channels ($m \pm 2$) [1].

vided among different users or sub-channels. Operating a filter bank transceiver at radio frequency (RF), however, could yield the required frequency selectivity and agility demanded of TVWS devices. This is becoming a realistic possibility with the recent advancements in the development of high-speed digital-to-analogue converters (DACs) and analogue-to-digital converters (ADCs) [16]. Subsequently, filter bank based transceiver designs for the TVWS range, sampling directly at RF, have been suggested [11, 10, 12, 9].

In order to aid the understanding of the transceiver concept, this paper proposes a filter bank based design which is scaled down in frequency by several orders of magnitude, replacing the RF chain with high-frequency audio. Similar developments have been previously suggested for simpler transceiver designs such as a system for MIMO channel measurements [14], a baseband SC-FDMA transceiver [15], a software $\pi/4$ -DQPSK modem [21] and a differential QPSK modem [20] using audio I/O. An additional benefit of such a scaled-down version is the easier development of algorithms that will support the above TVWS transceiver in student projects, ranging from equalisation and synchronisation tasks [17] to TVWS-specific frequency-agile functions such as spectrum aggregation [19] or cognitive aspects.

To realise such a scaled-down implementation, the OMAP-L137 evaluation module (EVM) has been selected, which allows the use of a powerful dual-core processor, combining an ARM ARM926EJ-S applications processor with a Texas Instruments TMS320C6747 DSP, to realise the demanding complexity of the TVWS filter bank based transceiver [11]. Interfacing of the transmit and receive signals is carried out by the on-board DAC and ADC of the TLV320AIC3106 audio codec.

The remainder of this paper is organised as follows. Sec. 2 provides an overview of the proposed transceiver architecture operating at an RF sampling rate of 1.92GHz, while Sec. 4 introduces a version whereby sampling is scaled down by a factor of $2 \cdot 10^4$, enabling I/O via the OMAP-L137 audio codec at a sampling rate of 96kHz. Simulations and measurements are presented in Sec. 5 and conclusions are drawn in Sec. 6.

2. TRANSCEIVER DESIGN

2.1 System Overview

The aim of the transceiver system is to up- and down-convert the entire 40 TVWS channels between baseband and the UHF range 470–790MHz. The upconverter in the transmitter must be able meet the strict leakage requirements out-

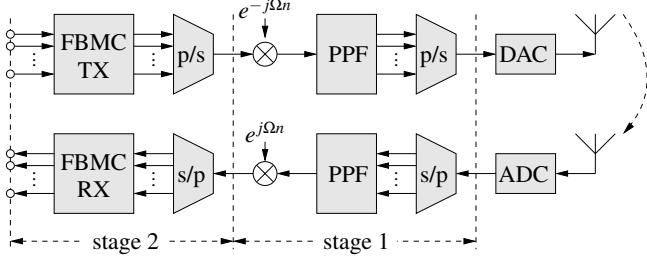

Figure 2: Proposed multi-stage TVWS filter bank transmitter (above) and receiver (below) with a polyphase filter (PPF) in stage 1 and an FBMC modulator in stage 2.

lined in the spectral mask [1] as shown in Fig. 1. This will be achieved through the use of a filter bank multicarrier (FBMC) system to provide acceptable frequency selectivity. The proposed transceiver design adopts a two-stage approach, as in [11, 10], to allow for modularity in the development and to reduce the number of input and output streams to the system [10]. Figure. 2 outlines the first two stages of the proposed transceiver design.

The bottom branch in Fig. 2 implements the receiver, which samples an input RF signal at f_s . In the first stage, an analytic signal is created by means of a complex valued polyphase bandpass filter. The 40 TVWS channels are then aligned so that they sit at DC by appropriate modulation with a complex valued exponential of normalised frequency Ω . In the second stage, the 40 TVWS channels are extracted by an analysis filter bank. The output of the filter bank is oversampled by a factor of two in order to ease synchronisation and further filtering of the separate channels. A third stage, which is for testing purposes and not shown in Figure. 2, performs preprocessing which creates an overall Nyquist system with the matching stage 3 of the transmitter.

The implementation of the transmitter uses matching dual components to the receiver, as shown in the top branch of Fig. 2, with the 40 TVWS channels being combined in stage 2 by means of an oversampled synthesis filter bank. The band position is corrected by modulation before being passed to stage 1 for complex bandpass filtering. The RF signal is formed by taking the real part of the analytic output. Again, a third stage for testing and measurement, not shown in Fig. 2, creates Nyquist systems with the matching stage 3 in the receiver.

2.2 Stage 1

The first stage of the filter bank receiver extracts the entire TVWS region, with a centre frequency of $f_c = 630\text{MHz}$, from the $f_s = 1.92\text{GHz}$ sampled RF signal. This creates an analytic baseband signal with the 40 8MHz channels aligned from DC. This is achieved through the use of an analytic bandpass filter with centre frequency f_c , and band limitation which allows decimation by a factor $K_1 = 5$. Alternative parameterisations exist here, as detailed in [10], but for the purposes of this work, only a single parameterisation will be discussed. Fig. 3 details the required filter characteristic for stage 1. Aliasing is permitted in the transition bands, en-

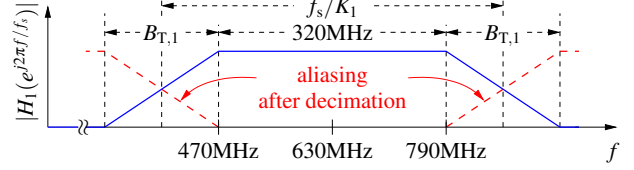

Figure 3: Stage 1 filter with passband width of 320MHz to capture TVWS spectrum, and with transition bandwidth $B_{T,1}$.

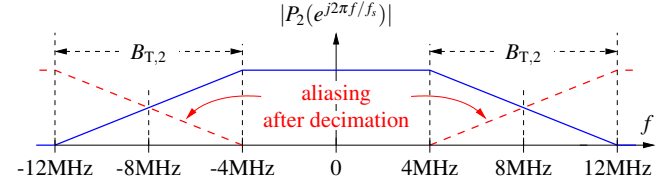

Figure 4: Stage 2 prototype filter with 8MHz passband width, transition bandwidth $B_{T,2}$ and decimation to 16MHz sampling rate.

abling a transition bandwidth $B_{T,1}$,

$$B_{T,1} = \frac{1.92\text{GHz}}{K_1} - 320\text{MHz} \quad (1)$$

In order to align the decimated TVWS region at DC, a correction by the lower frequency of 470MHz can be accomplished after aliasing by selecting $\Omega = 2\pi \cdot 470\text{MHz} \cdot \frac{K_1}{f_s}$.

The implementation of the stage 1 transmitter is the dual of the receiver, with a frequency shift by Ω followed by upsampling in the form of an interpolating bandpass filter $H_1(e^{j\Omega})$. Here the widened transition bands are not a problem due to the input signal to stage 1 adhering to the strict spectral mask characteristics. The real valued output from the analytic bandpass filter is then fed to the ADC operating at RF frequency.

2.3 Stage 2

A sampling rate of $f_s = 1.92\text{GHz}$ and decimation by $K = 5$ at stage 1 means that a total of $K_2 = 48$ individual TVWS channels need to be extracted in stage 2, with only 40 of those channels being utilised. A modulated filter bank is an efficient approach here due to the uniform ordering of the channels. The filter bank will be oversampled by a factor of two in order to ease the synchronisation of individual channels, while also easing the prototype filter characteristic. The characteristic, shown in Fig. 4, allows a maximum possible transition bandwidth $B_{T,2}$, and assumes that the Nyquist system imposed in stage 3 will ensure that all TVWS channels are perfectly band-limited.

The design here takes the form of an oversampled modulated generalised DFT (GDFT) filter bank, which allows the channels to be aligned in ascending order from DC to 320MHz.

2.4 Baseband Processing

Baseband processing is not formally part of the filter bank transceiver, but is needed to ensure that the signals are suit-

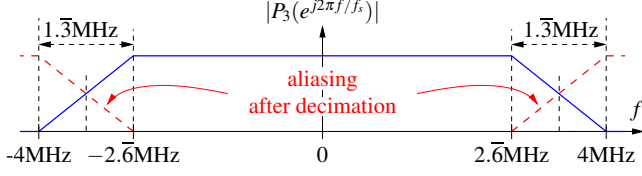

Figure 5: Stage 3 root Nyquist(3) characteristic. Sampled at 16MHz, this filter restricts the bandwidth to 5.3MHz.

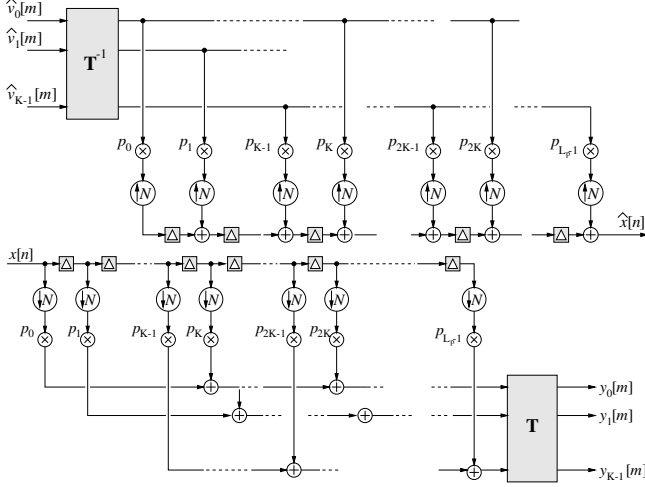

Figure 6: Polyphase implementation of (top) transmitter and (bottom) receiver filter bank based multicarrier modulation.

ably limited to 8MHz bandwidth in the transmitter, and that appropriate synchronisation and equalisation takes place in the receiver, thus creating an overall Nyquist system between transmitter and receiver. For convenience and testing as suggested in [11], a Nyquist(3) system may be operated here, requiring the baseband signals to be sampled at a frequency of ($\frac{16}{3}$)MHz. The corresponding filter characteristic for processing in the transmitter and receiver for such a stage 3 is detailed in Fig. 5. The spectral mask conditions defined in Fig. 1 must be met by the combination of the filters in stages 2 and 3.

3. FILTER BANK IMPLEMENTATION AND DESIGN

3.1 Filter Bank Implementation

The implementation of filter banks is crucial to the functionality and complexity of the overall transceiver system. We here have followed the implementation approach in [23, 24], which is equivalent to other efficient realisations [18]. The idea is depicted in Fig. 6, where a tap-delay-line is always operated at the lowest rate. The only multiplications which occur are with the prototype filter coefficient p_n , or are part of a modified fast Fourier transform operation.

3.2 Prototype Filter Realisation

To construct prototype filter coefficients that conform with spectral mask requirements in Fig. 1 [1], filters with length $L_1 = 600$ and $L_2 = 1200$ coefficients are required for stages

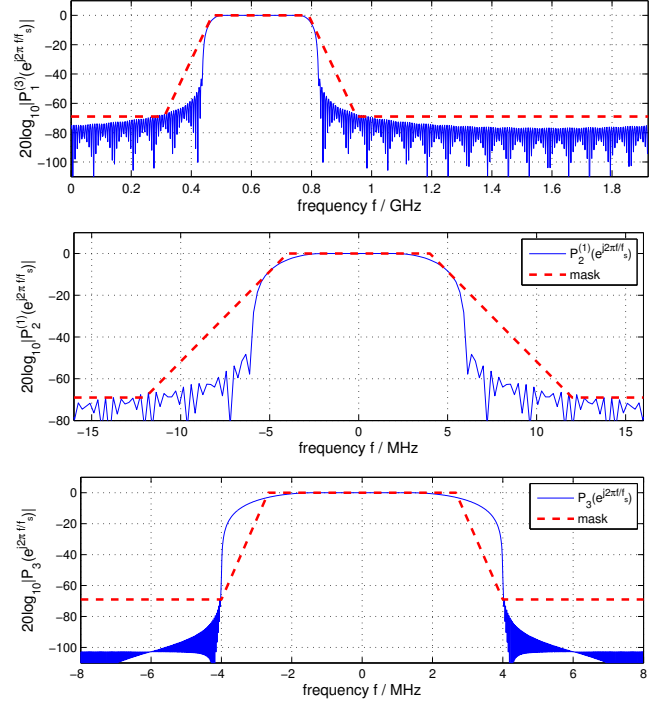

Figure 7: Magnitude responses of (top) stage 1, (middle) 2, and (bottom) 3 prototype filters.

1 and 2, respectively. The resulting magnitude responses of the prototype filters are shown in Fig. 7, detailing stage 1 and 2 filters, and additionally the stage 3 filter used for baseband processing. The filter characteristics are in floating point format and can be seen to satisfy the spectral mask requirements.

3.3 Computational Complexity

The implementation in Sec. 2.2 assumes a complex band-pass polyphase filter for stage 1, combined with a frequency shift Ω . With a filter length $L_1 = 600$, the complexity is $C_1 = L_1/K_1 + 1$ complex valued multiply accumulates (MACs). The filter bank implementation in stage 2, with the implementation detailed in Sec.3.1 leads to a complexity of $C_2 = L_2/K_2 + 2 \log_2 K_2$ complex MACs (CMACs) [23]. Therefore, overall implementation cost for only stages 1 and 2 is $C_1 + C_2 = 600/5 + 1 + 1200/48 + 12 \approx 158$ CMACs per sampling period. This complexity holds for both the transmitter and receiver parts of the proposed system. While this does not seem exorbitant, a sampling rate of 1.92GHz will impose a very significant computational burden that can only be addressed on a powerful FPGA with optimised parallel processing.

4. OMAP L-137 IMPLEMENTATION

The high computational complexity of the proposed filter bank transceiver motivates the implementation of a scaled down version operating at a lower frequency for educational and demonstration purposes. We here propose a scaling factor of $2 \cdot 10^4$, which brings the RF frequency of 1.92GHz into the audio range of 96kHz.

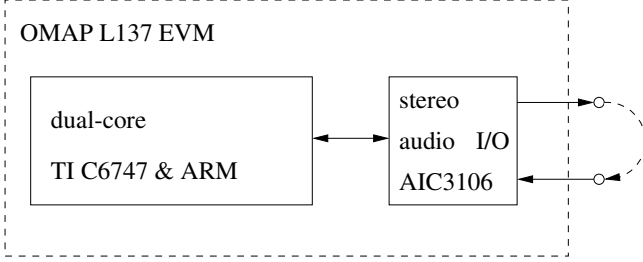

Figure 8: OMAP137 implementation with audio codec.

4.1 Relevant OMAP L-137 Features

For implementation of the scaled-down TVWS transceiver system, the OMAP L-137 evaluation module has been selected, which contains a Texas Instruments TMS320C6747 digital signal processor (DSP) and an on-board DAC and ADC on the OMAP’s TLV320AIC3106 audio codec. The audio codec can sample at a maximum rate of 96kHz, with a 3dB cut-off of the anti-alias and reconstruction filters at 43kHz. This permits simulation of the “RF” signal at 96kHz, with the scaled-down “UHF” band sitting in the frequency range from 23.5kHz to 39.5kHz, divided into 40 “TVWS” channels each with a bandwidth of 400Hz.

The DSP operates at a clock rate of 300MHz, and is capable of performing one CMAC within four clock cycles. Thus, a maximum of 75 MCMACs per second is achievable, which accommodates the required 96kHz · 158 CMACs = 15.168 MCMACs/s and any required overheads for memory moves and interrupt handling.

The overall setup is shown in Fig. 8, whereby the scaled-down RF signal is provided by the audio codec’s output, and can be looped-back into the same device, or connected to a second OMAP which performs the receiver functions.

4.2 Multirate System Issues

The overall system uses data streams exchanged with the audio codec based on a Texas Instruments loop-back application example supplied with the OMAP evaluation module. At 96kHz, coming from the ADC or going to the DAC, a block of $15 \cdot 128$ samples is utilised in both transmitter and receiver. Then, in both transmitter and receiver a tap-delay-line (TDL) is operated stage 1 as well as stage 2 for the implementation according to Fig. 6. For stage 1, the TDL runs at $96/K_1$ kHz = 19.2 kHz, and a block of $3 \cdot 128$ samples at this rate is held between stages 1 and 2. In stage 2, the TDL is operated at $19.2 \cdot \frac{2}{K_2}$ kHz = 800 Hz, yielding a block of 16 samples at the twice oversampled baseband rate within every of the 48 filter bank channels. Of these channels only the lower 40 are utilised, while the upper 8 channels are zero padded in the transmitter and discarded in the receiver.

To enable correct transient behaviour between blocks of data, all TDLs in the system have to be carried forward from one block to the next.

5. SIMULATIONS AND MEASUREMENTS

For the proposed system, all components are scaled down by a factor of $2 \cdot 10^4$. However, the relative cost per sampling

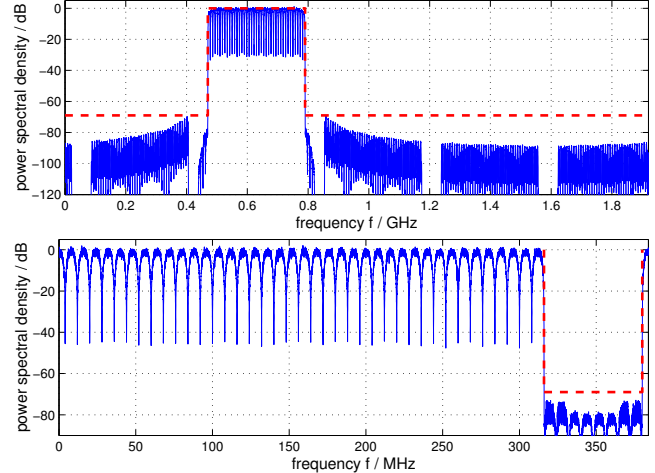

Figure 9: Power spectral densities of (top) stage 1 and (bottom) stage 2 signals, with spectral masks indicated as dashed lines.

period and the filter designs as outlined in Sec. 3.2 remain the same for the demonstrator at a sampling rate of 96kHz as compared to the RF version sampled at 1.92GHz. This section first explores the measured power spectral densities from system simulations in Sec. 5.1 before some measurements are discussed in Sec. 5.2

5.1 Power Spectral Densities

For a Matlab simulation with square-root Nyquist(3) filters operating in the baseband, i.e. creating signals that are strictly limited to within the 8MHz TVWS channels, power spectral density plots are provided in Fig. 9. The signal at stage 1 occupies the full TVWS region from 470 to 790MHz, while the stage 2 signal translates to the downconverted TVWS band region with $K_1 = 5$ and $K_2 = 48$ 8MHz channels, only the first 40 of which are occupied. The remaining 8 channels are vacated and display sufficiently low leakage. Overall, the spectral mask requirement of 69dB attenuation in next-adjacent channels [1] is met. Analysing the audio I/O of the OMAP system yields plots closely related to those in Fig. 9, with a differently scaled frequency axis, whereby the sampling rate is 96kHz, and the equivalent 400Hz channels occupy the range between 23.5 and 39.5kHz.

5.2 Measurements

Due to the filtering and upsampling in the transmitter, and the filtering and downsampling in the receiver, an increase in word length can be observed, particularly in the receiver. For the latter, the rate is reduced by a factor $5 \cdot 48 = 240 \approx 4^{3.953}$ leading to an increase in word length from the 16 bit accuracy of the ADC to $(16+3.953)$ dB with close to 120dB dynamic range.

For the RF system, where the 1.92GHz ADC has a lower resolution of approx. 12 bits, the ultimate aim will be to extract baseband signals with near 16 bit resolution, which can aid in providing the dynamic range that is required for wide-band communications systems.

6. CONCLUSION

Recent work on the design of a TVWS transceiver operating at an RF sampling rate of 1.92GHz has been reviewed, using an up- and downconversion via a two-stage filter bank approach. Employing an efficiently implemented filter bank as an up- or downconverter yields a flexible system, where the cost of extracting all 40 TVWS channels is not significantly higher than that of extracting a single channel, since the filter bank implementation's cost is primarily determined by the prototype filter, which is equivalent to a transmit or receive filter of a single channel system.

The design issues experienced with a DSP implementation of a TVWS transceiver demonstrator running on an OMAP L137 are similar to the RF system, but operate at a $2 \cdot 10^4$ scaled-down sampling frequency. Baseband signals of 400Hz bandwidth correspond to the 8MHz TVWS channels. The demonstrator will be a useful platform in future student projects, where the aim is to design synchronisation and equalisation algorithms, or also TVWS-specific approaches such as spectrum estimation, adaptive channel selection, or spectrum aggregation.

REFERENCES

- [1] S. J. Shellhammer, A. K. Sadek, and W. Zhang. Technical challenges for cognitive radio in the TV white space spectrum. In *Information Theory and Applications Workshop*, pp. 323–323, Feb. 2009.
- [2] M. Bellanger and J. Daguët. TDM-FDM transmultiplexer: Digital polyphase and FFT. *IEEE T. Comms.*, 22(9):1199–1205, Sep. 1974.
- [3] G. Bonnerot, M. Coudreuse, and M. Bellanger. Digital processing techniques in the 60 channel transmultiplexer. *IEEE T. Comms.*, 26(5):698–706, May 1978.
- [4] F. Takahata, Y. Hirata, A. Ogawa, and K. Inagaki. Development of a tdm/fdm transmultiplexer. *IEEE T. Comms.*, 26(5):726–733, May 1978.
- [5] F. Molo. Transmultiplexer realization with multistage filtering. *IEEE T. Comms.*, 30(7):1614–1622, July 1982.
- [6] S. Rahimi and B. Champagne. Perfect reconstruction DFT modulated oversampled filter bank transceiver. In *Europ. Signal Processing Conf.*, Barcelona, Aug. 2011.
- [7] F. J. Harris, C. Dick, and M. Rice. Digital receivers and transmitters using polyphase filter banks for wireless communications. *IEEE T. Microwave Theory & Tech.*, 51(4):1395–1412, Apr. 2003.
- [8] G. Cherubini, E. Eleftheriou, and S. Ölcer. Filter Bank Modulation Techniques for Very High-Speed Digital Subscriber Lines. *IEEE J. Sel. Areas Comms.*, 20(5):1016–1028, May 2002.
- [9] R. A. Elliot, M. A. Enderwitz, F. Darbari, L. H. Crockett, S. Weiss, and R. Stewart. Reconfigurable TVWS transceiver for use in UK and US markets. In *7th Int. Workshop Reconfg. Comms.-centric Systems-on-Chip*, York, UK, July 2012.
- [10] R. A. Elliot, M. A. Enderwitz, F. Darbari, L. H. Crockett, S. Weiss, and R. W. Stewart. Design considerations for a filter bank based TVWS transceiver. In *URSI UK Festival of Radio Science*, Durham, UK, Apr. 2012.
- [11] R. A. Elliot, M. A. Enderwitz, F. Darbari, L. H. Crockett, S. Weiss, and R. W. Stewart. Efficient TV white space filter bank transceiver. In *20th European Signal Processing Conference*, Bucharest, Aug. 2012.
- [12] M. A. Enderwitz, R. A. Elliot, F. Darbari, L. H. Crockett, S. Weiss, and R. W. Stewart. Digital RF multiplexing for a TVWS transceiver implementation. In *URSI UK Festival of Radio Science*, Durham, UK, Apr. 2012.
- [13] S. Haykin. Cognitive Radio: Brain-Empowered Wireless Communications. *IEEE J. Sel. Areas Comms.*, 53(2):201–220, Feb. 2005.
- [14] A. Kani, A. Wilzeck, T. Kaiser, and K. N. Haines. MIMO channel measurements with an educational XIXO audio channel testbed. In *2nd IEE/EURASIP Conference on DSPenabledRadio*, Sept. 2005.
- [15] S. Karabetos, E. Pikasis, T. Nikas, E. Zois, and A. Nassiopoulos. An educational baseband SC-FDMA transceiver using Matlab and the TMS320C6713 DSK. In *Europ. DSP Educ. & Res. Conf.*, pp. 6–10, 2010.
- [16] A. Lesellier, O. Jamin, J. Bercher, and O. Venard. Broadband digitization for cable tuners front-end. In *41st Europ. Microwave Conf.*, pp. 705–708, Oct. 2011.
- [17] A. M. Tonello and F. Pecile. Efficient architectures for multiuser FMT systems and application to power line communications. *IEEE T. Comms.*, 57(5):1275–1279, May 2009.
- [18] A. M. Tonello and T. Zheng. Bottom-up transfer function generator for broadband PLC statistical channel modeling. In *IEEE Int. Symp. Power Line Comms. & Appl.*, pp. 7–12, Dresden, Mar. 2009.
- [19] W. Wang, Z. Zhang, and A. Hang. Spectrum aggregation: Overview and challenges. *Network Protocols & Algorithms*, 2(1):184–196, 2010.
- [20] S. Weiss, M. R. Bennett, E. Gibson, and N. C. Tisdale. A Differential QPSK Modem Using the TMS320C6711 DSK. In *Europ. DSP Education & Research Symp.*, Birmingham, Nov. 2004.
- [21] S. Weiss, S. J. Braithwaite, and R. D. Stewart. $\pi/4$ D-QPSK Software Modem: A Student Project Using the TMS320C6201 EVM. In *3rd Europ. DSP Education & Research Conf.*, Paris, Sep. 2000.
- [22] S. Weiss, A. P. Millar, R. W. Stewart, and M. D. Macleod. Performance of transmultiplexers based on oversampled filter banks under variable oversampling ratios. In *18th Europ. Signal Processing Conf.*, pp. 2181–2185, Aalborg, Aug. 2010.
- [23] S. Weiss and R. Stewart. Fast Implementation of Oversampled Modulated Filter Banks. *Elec. Let.*, 36(17):1502–1503, Aug. 2000.
- [24] S. Weiss and R. W. Stewart. Fast Implementation of Oversampled Modulated Filter Banks. In *Europ. DSP Education & Research Conf.*, Paris, Sep. 2000.