

# ➤ Centre for Automotive Safety Research

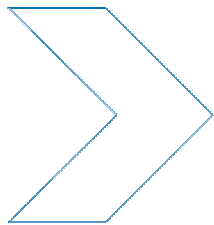

## Performance of bull bars in pedestrian impact tests

RWG Anderson, AL van den Berg, G Ponte, LD Streeter,  
AJ McLean

---

CASR REPORT SERIES

CASR020

July 2006



# Report documentation

---

REPORT NO.	DATE	PAGES	ISBN	ISSN
CASR020	July 2006	43	1 920947 22 1	1449-2237

## TITLE

Performance of bull bars in pedestrian impact tests

## AUTHORS

RWG Anderson, AL van den Berg, G Ponte, LD Streeter, AJ McLean

## PERFORMING ORGANISATION

Centre for Automotive Safety Research  
The University of Adelaide  
South Australia 5005  
AUSTRALIA

## SPONSORED BY

Motor Accident Commission  
GPO Box 1045  
Adelaide  
South Australia 5001  
AUSTRALIA

## AVAILABLE FROM

Centre for Automotive Safety Research  
<http://casr.adelaide.edu.au/reports>

## ABSTRACT

Thirteen bull bars and the five models of vehicle were tested to measure their performance in pedestrian impact tests. Three tests were used in the assessment: two tests using an impactor representing the upper leg of an adult pedestrian, and a test with an impactor representing the head of a child. The headform impact and one of the upper legform impacts were with the top rail of the bull bar, and the second upper legform impact was with the bumper section of the bull bar. Equivalent locations on the vehicle that the bull bars were attached to were also tested. The tests were conducted at 30 km/h. Two rating systems were developed to summarise the results. The first rates the performance of the bull bars and the fronts of the vehicles according to the New Car Assessment Program consumer rating system used in Europe and Australia. The second system rates the performance of the bull bars relative to the front of the vehicle to which they are attached. Overall, steel bull bars are significantly more hazardous for a pedestrian in the event of a collision than the front of the vehicle, as are the aluminium/alloy bull bars, but to a lesser extent than the steel bull bars. Overall, the polymer bull bars slightly improve the safety of the front of the vehicle. This study demonstrates the practicability of reporting the performance of bull bars in pedestrian impact tests. The system developed herein could form the basis of a consumer-oriented bull bar testing program.

## KEYWORDS

Bull bar, Pedestrian, Vehicle safety, Crash test

© The University of Adelaide 2006

The views expressed in this report are those of the authors and do not necessarily represent those of the University of Adelaide or the sponsoring organisation

## Summary

---

A bull bar is likely to increase the danger of a vehicle to other road users in a collision and yet, for many car owners, a bull bar rarely performs its ostensible purpose – protecting the vehicle from an animal strike. Despite discussion on the subject in the media, there is currently no readily available information for consumers on how much more of a risk to other road users a bull bar is likely to present.

The aim of this project was to work toward providing consumers with information on the risks to vulnerable road users associated with bull bars, so that they can make a more informed choice about whether to install a bull bar or, if they do decide to purchase a bull bar, incorporate information on pedestrian safety into their purchasing decision.

Thirteen bull bars were assessed for this study, as well as the front of each of the five models of vehicle to which the bull bars are designed to be fitted. The bull bars were chosen to represent the range of designs and materials used to construct the most common types of bull bar. The materials represented were steel, aluminium/alloy and polymer.

Three tests were used in the assessment: two tests using an impactor representing the upper leg of an adult pedestrian, and a test with an impactor representing the head of a child. The headform impact and one of the upper legform impacts were with the top rail of the bull bar, and the second upper legform impact was with the bumper section of the bull bar. Equivalent locations on the vehicle, that the bull bars were attached to, were also tested. The tests were conducted at 30 km/h.

Polymer bull bars recorded the lowest impact severity among tests conducted along the top rails of the bull bars and appeared to be less hazardous than the bonnet leading edge of the vehicles to which they were attached. On average, all of the bull bars, regardless of type, had a poorer impact performance than the original bumper of the vehicle, although the polymer bull bars were only slightly worse on average. The impacts recorded by the steel bull bars often were so severe that they exceeded the measuring range of the test equipment.

Two rating systems were developed to summarise the results. The first rates the performance of the bull bar and the front of the vehicle according to the injury tolerance criteria used by the New Car Assessment Program (NCAP) consumer rating system in Australia and Europe (although NCAP tests are conducted at 40 km/h). The second system rates the safety performance of the bull bar relative the front of the vehicle to which it is attached.

Overall, the steel bull bars tested were significantly more hazardous to a pedestrian than the front of the vehicle. This was also the case with aluminium/alloy bull bars, but to a lesser extent than the steel bull bars. The polymer bull bars of the type tested here were, in some tests, less hazardous for a pedestrian than the front of the vehicle that they are designed to protect.

The performance ratings of the bull bars, and the front of the vehicles to which they are attached, are contained in the body of this report and are also presented on the following page.

Performance of bull bars at 30 km/h, relative to the injury tolerance values used in this study

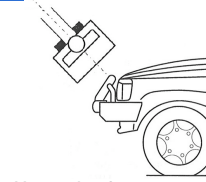
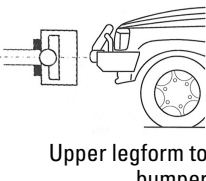
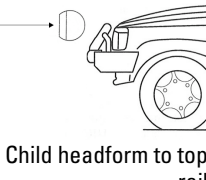
Test type	Vehicle	Front of vehicle	Steel bull bar	Aluminium/ alloy bull bar	Polymer bull bar
 Upper legform to top rail	Toyota Landcruiser	Poor	Poor	Poor	-
	Nissan Patrol	Marginal	Poor	Poor	Fair
	Ford Courier	Marginal	Poor	Poor	Poor
	Holden Rodeo	Poor	Poor	Poor	Fair
	Toyota Hilux	Marginal	Poor	Poor	-
 Upper legform to bumper	Toyota Landcruiser	Poor	Poor	Poor	-
	Nissan Patrol	Poor	Poor	Poor	Poor
	Ford Courier	Poor	Poor	Poor	Poor
	Holden Rodeo	Fair	Poor	Poor	Poor
	Toyota Hilux	Poor	Poor	Poor	-
 Child headform to top rail	Toyota Landcruiser	Poor	Poor	Poor	-
	Nissan Patrol	Fair	Poor	Poor	Marginal
	Ford Courier	Poor	Poor	Poor	Fair
	Holden Rodeo	Marginal	Poor	Marginal	Marginal
	Toyota Hilux	Poor	Poor	Poor	-

Aggressiveness of bull bars relative to the front of the vehicles to which they are attached

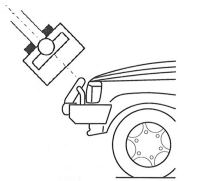
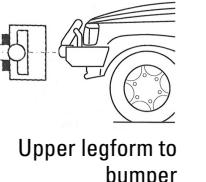
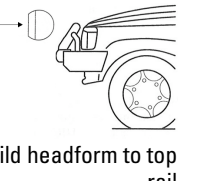
Test type	Vehicle	Steel bull bar	Aluminium/alloy bull bar	Polymer bull bar
 Upper legform to top rail	Toyota Landcruiser	Moderately more	Slightly more	-
	Nissan Patrol	Much more	Moderately more	Less
	Ford Courier	Much more	Moderately more	Slightly more
	Holden Rodeo	Moderately more	Less	Less
	Toyota Hilux	Much more	Moderately more	-
 Upper legform to bumper	Toyota Landcruiser	Moderately more	Moderately more	-
	Nissan Patrol	Slightly more	Less	Less
	Ford Courier	Moderately more	Slightly more	Less
	Holden Rodeo	Much more	Much more	Much more
	Toyota Hilux	Moderately more	Moderately more	-
 Child headform to top rail	Toyota Landcruiser	Much more	Moderately more	-
	Nissan Patrol	Much more	Moderately more	Slightly more
	Ford Courier	Moderately more	Slightly more	Less
	Holden Rodeo	Much more	Slightly more	Slightly more
	Toyota Hilux	Much more	Slightly more	-

There are formal testing Standards for bull bars, both here and overseas. The Australian Standard, AS 4876.1 2002 - Motor Vehicle Frontal Protection Systems, requires bull bars to satisfy impact test requirements using a child headform. A European Union (EU) Directive 2005/66/EC 'relating to the use of frontal protection systems' requires headform tests and tests with two types of legform, one representing the upper leg of an adult and, the other, the knee and lower leg of an adult.

The Australian Standard is not as stringent or as comprehensive as the EU Directive. Australian Standards are consensus documents that require the agreement of the parties involved in their development including, in this case, the manufacturers of the bull bars. Consequently, as noted in the Preface to the Australian Standard, "Child head impact criteria have been included incorporating values that are considered achievable." The EU Directive clearly does not accept this view of what is achievable. The EU has also issued a Directive on pedestrian safety and vehicle design, and passenger vehicles will have to satisfy impact test requirements. No such legislative requirement exists in Australia at present.

The Australian New Car Assessment Program tests and reports on the pedestrian safety performance of new vehicles to consumers in Australia and New Zealand. It is arguable that a similar consumer information system for bull bars should also exist, to publicise the level of pedestrian safety associated with individual makes and models of bull bar. It is to be expected that such a consumer information system would encourage the development of safer bull bars or, more generally, vehicle frontal protection systems.

# Contents

---

1	Introduction.....	1
1.1	The current situation regarding pedestrian fatalities in Australia .....	1
1.2	International developments in pedestrian safety .....	3
1.3	European Directive on Frontal Protection Systems.....	4
1.4	AS 4876.1 2002 - Motor Vehicle Frontal Protection Systems.....	4
1.5	Aim and outline of this study .....	5
2	Test procedure for the assessment of the bull bar and the front of the vehicle.....	6
2.1	Test parts.....	7
2.1.1	Part A tests.....	7
2.1.2	Part B tests.....	7
2.1.3	Part C tests .....	7
2.2	Bull bar mounting .....	9
2.3	Launching equipment.....	10
2.4	Velocity measurements.....	10
2.5	Impactors.....	11
2.6	Instrumentation .....	11
2.7	Signal conditioning.....	11
2.8	Data acquisition.....	11
2.9	Data processing .....	11
2.10	High speed video.....	12
2.11	Impact conditions.....	12
3	Bull bar and vehicle selection .....	13
4	Results.....	23
4.1	Impact speed and angle.....	23
4.2	Part A test results.....	23
4.3	Part B test results.....	26
4.4	Part C test results .....	28
5	Rating the performance of bull bars in these tests .....	30
6	Discussion.....	33
6.1	Headform impact results .....	33
6.2	OES bull bars and aftermarket bars .....	34
6.3	Implications .....	34
	Acknowledgments .....	36
	References .....	37

# 1 Introduction

---

Four-wheel-drive (4WD) vehicles are a popular choice for many motorists who do the majority of their driving in urban environments. Much has been spoken and written on the safety implications of these vehicles and the bull bars that are fitted to them. While the bars are popular on 'recreational' 4WDs, they are also often installed on work vehicles and conventional passenger cars and derivatives.

Bull bars are likely to increase the danger of the vehicle to other road users in a crash, and yet, for many car owners, they rarely perform their ostensible purpose – protecting the vehicle from animal strikes. However, they are (with some exceptions) legal additions to vehicles and are popular with consumers. Despite discussion on the subject in the media, there is currently no readily available information on the aggressiveness of bull bars, and consumers have no information on how much more of a risk to other road users a bull bar will present.

In 2002, Standards Australia issued Part 1 of a new Standard for frontal protection systems - AS 4876.1 2002 - Motor Vehicle Frontal Protection Systems. The term "Frontal Protection Systems" was used because it implies that there may be other ways to protect the front of a vehicle from disabling damage in the event of an animal strike than by fitting a conventional bull bar.

AS 4876 Part 1 deals with protection of children who are some risk of injury when struck by bull bars. Two other parts (dealing with effects on airbag deployment, and the effectiveness of a device in protecting the vehicle) have yet to be considered.

Australian Standards are consensus documents that require the agreement of the parties involved in their development including, in this case, the manufacturers of the bull bars. Consequently, as noted in the Preface to the Australian Standard, "Child head impact criteria have been included incorporating values that are considered achievable." A European Union Directive on vehicle frontal protection systems does not accept this view of what is achievable (see Sections 1.3 and 1.4).

The aim of this project is to work toward providing consumers with information on the risks to vulnerable road users associated with bull bars, so that they can make a more informed choice about whether to install a bull bar or, if they do decide to purchase a bull bar, incorporate information on pedestrian safety into their purchasing decision.

## 1.1 The current situation regarding pedestrian fatalities in Australia

Pedestrian fatalities account for about 14% of deaths on the roads in Australia (ATSB, 2004). This proportion has declined from a peak (in recent times) of about 20% in 1995. Figure 1.1 shows that the pedestrian fatalities are most common among young adults, and also in the aged population. The data used in this chart were compiled from the years 1989 – 2005.

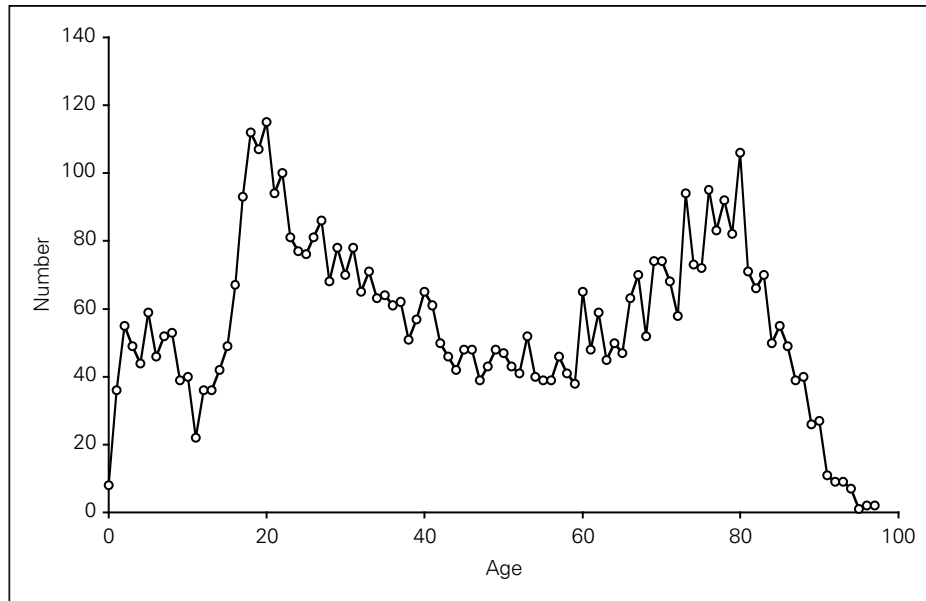

**Figure 1.1**  
 Number of pedestrian fatalities in Australia by age from 1/1/1989 to 31/10/2005

Using fatality data from the same period, Figure 1.2 shows the proportion of fatally injured motor vehicle occupants and pedestrians who were pedestrians. This Figure shows that, until the age of 14, Australians who die in crashes involving motor vehicles are more likely to die as a pedestrian than at any other age until an age of about 70. Data on serious injuries in South Australia show a similar pattern. These data show that for children, and for the elderly, pedestrian safety is just as important as vehicle occupant safety.

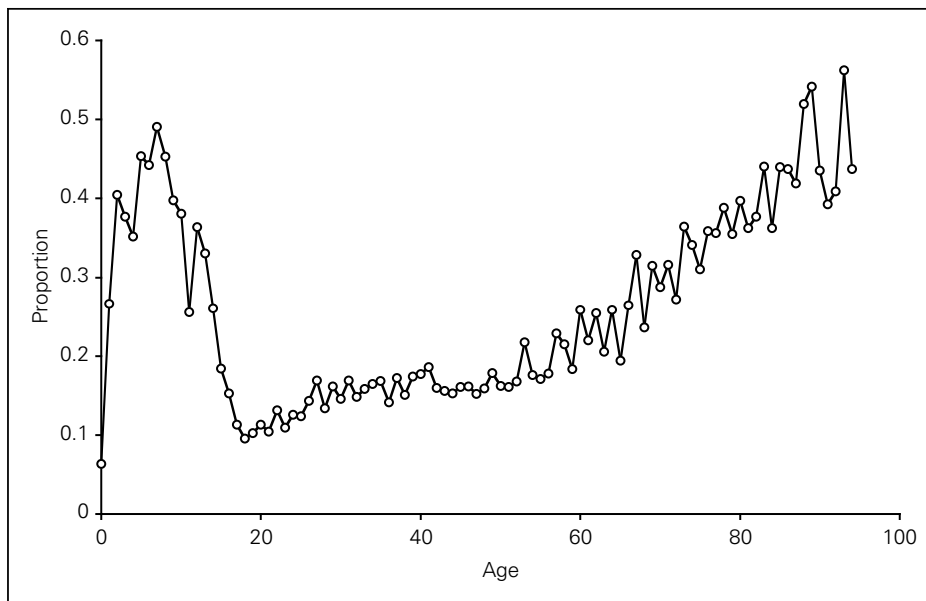

**Figure 1.2**  
 Proportion of car occupant and pedestrian fatalities that are pedestrians, by age, from 1/1/1989 to 31/10/2005

The extent to which bull bars are involved in pedestrian collisions and injury is not clear from readily available data. In 1996, the Federal Office of Road Safety estimated that bull bars were involved in 12% of fatal pedestrian collisions but may be involved in as many as 20%



(FORS, 1996), although it is not clear how the latter estimate was arrived at, nor whether these figures represent an increased risk of death due to the presence of the bull bar. More recently Attewell and Glase (2000) used Australian crash data to try and estimate the effect of bull bars on fatality statistics. They were not able to draw firm conclusions due to the incompleteness on the bull bar status of vehicles in their fatality database. Furthermore, there were (and are) few data on bull bar fitment rates, and that made it difficult to estimate risks associated with bull bar fitment. Mandatory reporting of bull bar fitment would facilitate the estimation of relative risks of injury and death associated with bull bars.

Previous physical tests (Lawrence, Rodmell and Osborne, 2000; McLean, Anderson and Streeter, 1998) have shown that bull bars can increase the severity of impacts with pedestrians but that not all bull bars are equally as dangerous. Attewell and Glase (2000) conclude that, on balance, bull bars are likely to increase the risk of injury to pedestrians.

In many areas of road and vehicle safety, road users are regulated and encouraged to make decisions to improve their personal safety, and the safety of their vehicles and their driving. With respect to child occupant safety, for example, child restraints are available to ensure that children are protected to the maximum extent possible in the event of a crash. Restraint use is supported (to some extent) by regulation, advocacy and advice. Parents are encouraged by road authorities, motoring organisations and public health advocates to correctly use appropriate restraints for children. It is consistent with other road safety measures that drivers be encouraged to ensure that the exterior of their vehicles is as safe as possible, and that safety is not compromised by the addition of dangerous accessories. This should include the safety problems associated with fitting dangerous bull bars to the vehicle.

## 1.2 International developments in pedestrian safety

One strategy being pursued to reduce the numbers of pedestrians killed and injured by motor vehicles, is the introduction of specific test methods to measure the levels of protection afforded to a pedestrian by a vehicle, should a collision occur.

In the late 1970s, the then European Experimental Vehicles Committee (EEVC) was one of the first groups to examine the possibility of developing a test procedure to evaluate the degree of pedestrian friendliness of the front of vehicles. Working Group 7 of the EEVC examined injury patterns and sources of injury among pedestrian casualties and fatalities. The data collected indicated that the most commonly injured regions of the body were (respectively) the head, lower limbs, arms, thorax and pelvis. When only severe injuries were examined, the head and lower limbs were most frequently involved (EEVC, 1994). Working Group 10 of the EEVC was formed as a result of a report of an ad hoc group that made further findings following the final report of Working Group 7. Working Group 10 was given the mandate to determine test methods and acceptance levels for assessing the protection afforded by pedestrians by the fronts of cars in an accident. They devised a set of impact tests to measure the risk of injury to the head of adults and children using free flight headforms, the upper leg of an adult using a guided impactor and the knee and tibia of an adult using a free flight leg impactor (EEVC, 1994). Working Group 10 was superseded by Working Group 17 (WG17) in 1997 who further refined the tests and test devices. Their report was released in 1998 (EEVC, 1998).

The International Standards Organisation (ISO) and the International Harmonised Research Activities Pedestrian Safety Committee (IHRA) are also developing test procedures for pedestrian protection. The test methods they are devising differ from the EEVC in certain aspects (particularly headform masses, impact speeds and angles) but they remain largely based on the work of the EEVC (Mizuno and Ishikawa, 2001).

Since 1 October 2005, new types of passenger vehicles sold in Europe must comply with a European Council Directive that will require certain performance requirements in child headform and full legform impact tests (2003/102/EC). All new vehicles (not only new types of vehicle) must comply from 31 December 2012. The tests are a variation on the EEVC WG17 proposed test methods. The child headform weighs 3.5 kg and is fired at 35 km/h. In 2010, new types of passenger vehicles will also have to comply with tests that use the EEVC WG17 upper legform, and an adult headform, and these tests will be mandatory for all new vehicles in 2015.

Japan has regulated to ensure that new models of passenger car and their derivatives introduced after 1 September 2005, and existing models after 1 September 2010, comply with pedestrian head impact performance requirements. The Japanese regulation uses a 3.5 kg child headform and a 4.5 kg adult headform, both of which are fired at 32 km/h. There are no requirements for a legform impact test at this stage.

While these regulations have been introduced only recently, the European and Australian New Car Assessment Programs (Euro NCAP and ANCAP) have been reporting the performance of vehicles in pedestrian impact tests for several years: since 1999, ANCAP have reported the performance of over 40 vehicles in pedestrian tests (Ponte et al., 2004). ANCAP uses the Euro NCAP testing protocols so the results of Euro NCAP assessments can be published in Australia also.

The current Euro NCAP protocol (v 4.1) is an adapted form of the EEVC WG17 test procedures and uses an impact speed of 40 km/h for all impactors (except for the upper legform impact speed, which is selected according to the frontal geometry of the vehicle).

### 1.3 European Directive on Frontal Protection Systems

The European Union has also issued a Directive on frontal protection systems (2005/66/EC). The purpose of the Directive is to ensure a level of pedestrian protection from vehicles fitted with bull bars. The Directive is closely linked to the testing requirements of the EU Directive 2003/102/EC for new types of passenger vehicle (see Section 1.2)

The Directive 2005/66/EC requires bull bars to be tested using a full legform, upper legform and headform. Compliance with 2005/66/EC will depend on bull bars performing in accordance with the same test provisions as those required by 2003/102/EC. In other words, new bull bars will be expected to offer the same level of protection to pedestrians as new passenger vehicles sold in Europe. An exception is where new aftermarket bull bars are designed for older (before October 2005) or large (>2.5 tonnes) vehicles. In these cases, the bull bar should be no more dangerous than the front of the vehicle, or, they must comply with relaxed performance requirements.

From the 25th of November 2006, new types of vehicles fitted with bull bars, and new types of aftermarket bull bars that do not comply will be refused certification of conformity under the EC type approval system 70/156/EEC. After the 25<sup>th</sup> of May 2007 such vehicles will also be refused registration in EU member states and new types of aftermarket bull bars that do not comply will not be able to be sold in Europe.

### 1.4 AS 4876.1 2002 - Motor Vehicle Frontal Protection Systems

Australian Standard 4876.1 concerns road user protection and specifies design requirements and pedestrian impact performance requirements of vehicle frontal protection systems (VFPS). The design requirements cover matters pertaining to geometry and to the sections used to construct the VFPS: essentially, vehicle frontal protection systems should conform to the shape of the car and should not have sharp edges.

The test of impact performance is intended to simulate an impact with the head of a child pedestrian. It specifies the use of an EEVC WG17 compliant child headform, which is spherical, weighing 2.5 kg, and is launched horizontally at 30 km/h at any part of the bar over 1000 mm from the ground. In practice, this means that many bull bars on the market will not require any testing at all, as only bull bars fitted to tall 4WD vehicles are higher than 1000 mm.

It might be said that this will 'deny' the consumer knowledge about the relative safety of the bull bar as a manufacturer might claim Standards compliance, on the basis of the geometry of the bar, without needing to meet any impact performance requirement.

On the other hand, The EEVC WG17 and Euro NCAP protocols use 1000 mm 'wrap-around-distance' as the lower boundary for child headform tests, and so it would be inconsistent to single out bull bars for special treatment in this respect.

The performance requirement in AS 4876.1 is that the Head Injury Criterion (HIC) value (based on impact acceleration) should be 1500 or less. In automotive safety testing, a HIC value of 1500 is not acceptable: a HIC value of 1000 is the normal limit. If a child's head was struck at 30 km/h, a bull bar that complied with the Standard might still be likely to inflict a serious injury. Therefore compliance with the Standard may not ensure that the bar is safe at impact speeds of 30 km/h.

As mentioned in Section 1.1, young adults and the elderly make up the largest proportion of pedestrian casualties and so there are sound reasons to target pedestrian safety interventions for the whole population and not just children. This is reflected in the Euro NCAP testing protocols, and a test to measure the risk of injury to adult pedestrians (such as the EEVC WG17 tests) in a collision with a bull bar-fitted vehicle is justified, even though it is absent from AS 4876.1.

## 1.5 Aim and outline of this study

The aim of this study is to report the performance of current bull bars and the vehicles to which they are fitted in tests designed to assess the risk that they pose to pedestrians.

This has been done by adopting the procedures outlines in AS 4876.1 and extending them to include upper legform impact tests and aligning performance requirements with Euro NCAP requirements.

Our original intention was to use test speeds in accordance with Euro NCAP protocols (40 km/h). However we reduced the speed to 30 km/h due to the stiffness of the most rigid bull bars, and the inability of our instrumentation to record the very high forces and accelerations produced by these bull bars tested at speeds of 40 km/h.

The tests consisted of a child headform impact test on the top rail of the bull bar, and two upper legform impact tests: one on the top rail of the bull bar and one on the bumper section of the bull bar.

The results of tests are presented in Section 5, and in Section 6 are simplified to indicate fair or poor performance, and also performance relative the front of the vehicle to which the bull bar is fitted.

## 2 Test procedure for the assessment of the bull bar and the front of the vehicle

---

The assessment procedure used for this study focuses on two body regions – the head of a child and the upper leg and pelvis of a pedestrian of adult stature. Each bull bar and vehicle front had three tests conducted on it: a child headform test, an upper legform to bumper test and an upper legform to upper rail/bonnet leading edge test. Each test was conducted at 30 km/h.

We chose 30 km/h rather than 40 km/h (as is used in ANCAP pedestrian testing) because a) preliminary testing showed that many of the bull bars were too stiff to yield useful information from impacts conducted at the higher speed, and b) 30 km/h is consistent with the Australian Standard (AS 4876.1 2002 - Motor Vehicle Frontal Protection Systems). It is reasonable to assume that tests conducted at 40 km/h would produce more severe impacts than those reported here.

While the Australian Standard only considers head impacts to children, bull bars can also be injurious to the upper leg and pelvis of adults in a crash (as discussed in Section 1). We therefore included, for the top of the bull bar, and for the equivalent location on the vehicle, an upper legform test that is similar to (but less severe than) the one used to assess the bonnet leading edge of the vehicle in the Australian New Car Assessment Program.

The upper legform test tool was also used to test the bumper section of each bull bar. Many bumper-replacement type bull bars use steel, aluminium, alloy or polymer sections to replace the bumper and support the stanchions. While the bumper of a car would normally be tested with the full legform in EEVC-style procedures, we had two reasons for choosing to use the upper legform instead. The first is that the ANCAP procedure already makes provision for the upper legform to be used instead of the full-legform when the bumper lower edge is more than 500 mm from the ground, which is the case in some 4WD vehicles. Secondly, the nature of the structure being tested is so rigid in many cases, that it is unlikely that useful information will be collected using the full legform: the part of the full legform representing the knee is not designed to perform under extreme force and, when it is exposed to such force, the joint usually reaches the end-stops of its range of motion. The aim of using the upper legform to test the bull bars was to produce a meaningful and consistent set of results that can be used to compare the performance of bull bars and the original bumper that the bull bar replaces.

Figures 2.1 and 2.2 and Table 2.1 summarise the types of tests used in this study, and the procedures are further outlined in the following sections.

The performance requirements we used are the same as those nominated by Euro NCAP for pedestrian safety assessment. The EU Directive 2005/66/EC nominates higher permissible loads in some tests, but we chose the Euro NCAP limits because:

- Our tests are being conducted at 30 km/h, rather than the 35 or 40 km/h used in the EU Directive, and thus the impact severity is less.
- Our performance requirements are more closely aligned with internationally accepted injury tolerance limits.

## 2.1 Test parts

### 2.1.1 Part A tests

An EEVC WG17 upper legform was used to test the top bar of each bull bar and the vehicle bonnet leading edge (Figure 2.1, Part A), in a similar way to the Euro NCAP Pedestrian Testing Protocol version 4.1, but at a lower test speed. The legform consists of a simply supported beam that represents an adult femur. The beam is covered in a flesh-like foam. The legform is constrained to move in one axis, normal to the orientation of the beam. The legform measures impact forces and the bending moment across the beam.

For the upper legform test of the bull bar top rail and for the comparison test of the bonnet leading edge:

- The geometry of the vehicle and bull bar was measured,
- The angle of the impactor was calculated using the procedure specified in Euro NCAP Pedestrian Testing Protocol version 4.1.,
- The centre of the impactor was aligned with of the top rail of the bull bar or the bonnet leading edge of the vehicle, and the test was conducted at 30 km/h, and
- The performance requirements were that the peak impact force on the impactor should be less than 5 kN, and the peak bending moment below 300 Nm. (Note that these performance requirements are specified by Euro NCAP for impact speeds of 40 km/h.)

### 2.1.2 Part B tests

An EEVC WG17 upper legform was used to test the bumper section of each bull bar and the vehicle's standard bumper (Figure 2.1, Part B)., in a similar way to the Euro NCAP Pedestrian Testing Protocol version 4.1 testing procedure for high bumper, but at a lower test speed. It was envisaged that the Part B test would be applied only if the bull bar had significant structural components at bumper height (see Table 2.1) but our assessment was that all bull bars tested had such structures, and consequently the test was applied to all bull bars.

- The centre of the upper legform impactor was raised to 500 mm from the ground and aligned with the bumper
- The impactor speed was 30 km/h, and the impact angle was horizontal.
- The performance requirements were that the peak impact force should be less than 5 kN, and the peak bending moment below 300 Nm.

### 2.1.3 Part C tests

The EEVC WG17 child headform test was applied at the impact speed specified in the Australian Standard AS 4876.1, and an identical comparison test was applied to the car itself (Figure 2.2). The headform consists of a 2.5 kg sphere, with a triaxial accelerometer mounted at the centre of gravity. The headform measures the impact deceleration, which is then analysed to produce the Head Injury Criterion value for the impact.

Only sections of the bar above 1000 mm were subjected to testing, in accordance with AS 4876.1.

- The centre of the headform was aligned with the centre of the top rail of the bull bar or leading edge of the vehicle (directly behind the bull bar impact point). If the centre of the top rail was below 1000 mm from the ground, then the centre of the

headform was aligned with the part of the top rail at 1000 mm from the ground (note that the vehicle ride heights were as specified by the vehicle manufacturer).

- The test was conducted at 30 km/h.
- The performance requirements were that the Head Injury Criterion value should be 1000 or less.

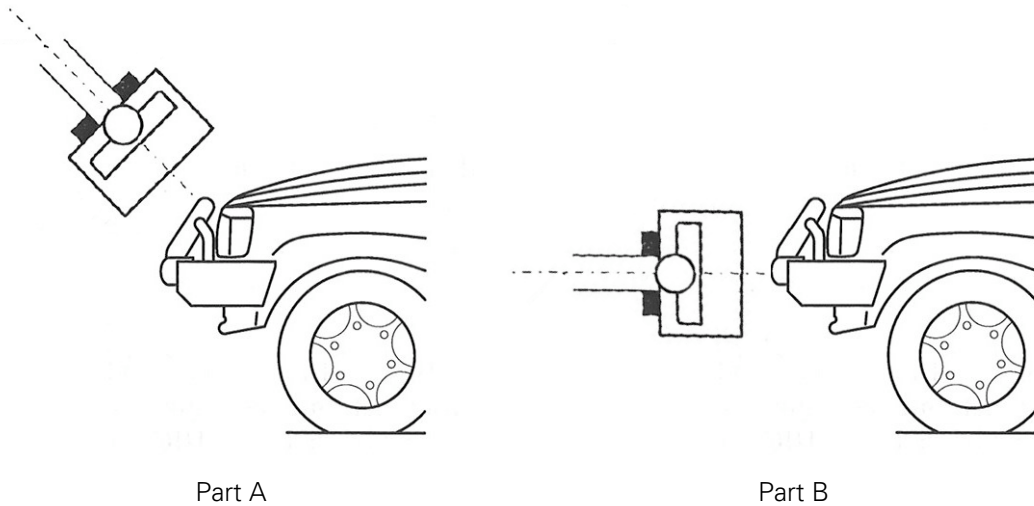

Figure 2.1  
Schematic of Part A and Part B tests, using the ANCAP upper-leg impactor

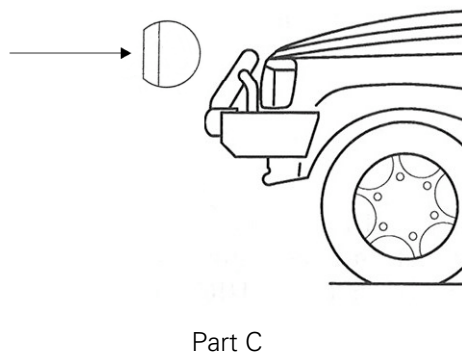
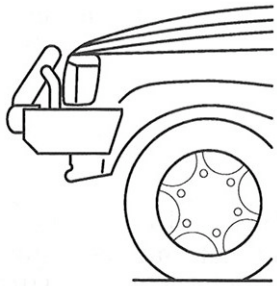
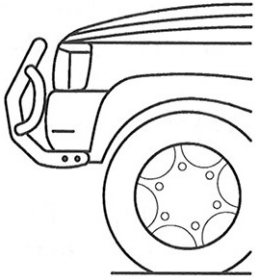
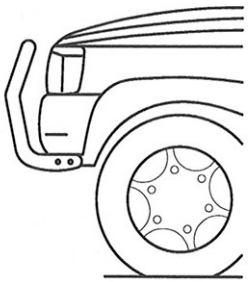

Figure 2.2  
Schematic of Part C test using the ANCAP child-headform

**Table 2.1**  
Test determination for different styles of bull bar

Type of bar	Part A	Part B	Part C
 Bumper replacement bull bar	Yes	Yes	Parts of bar > 1000 mm from ground
 Over-bumper bull bar	Yes	If substantial member at bumper height	Parts of bar > 1000 mm from ground
 Nudge bar	Yes	If substantial member at bumper height (e.g. mounting bar for spot-lights)	Parts of bar > 1000 mm from ground

## 2.2 Bull bar mounting

Two methods were used to mount the bull bars for testing. In most cases the bull bar was attached to the corresponding vehicle, according to the manufacturer's instructions. However, in some cases, mounting the bull bar to the vehicle would have required modification to the vehicle chassis rails. As the vehicles were to be (separately) crash tested by ANCAP after these pedestrian impact tests, the modifications could not be made, as the subsequent crash test might have been compromised. Instead, a universal chassis-rail rig was used (Figure 2.3).

The chassis rail rig was checked to ensure that the results of the tests would be a valid representation of the bull bar as it would be on the vehicle: we checked this by testing a bull bar on the rig and again on the vehicle. The results from each test (headform and upper legform) were almost identical (within a few percent) and the standard chassis rails were deemed to be an accurate replacement to a vehicle chassis.



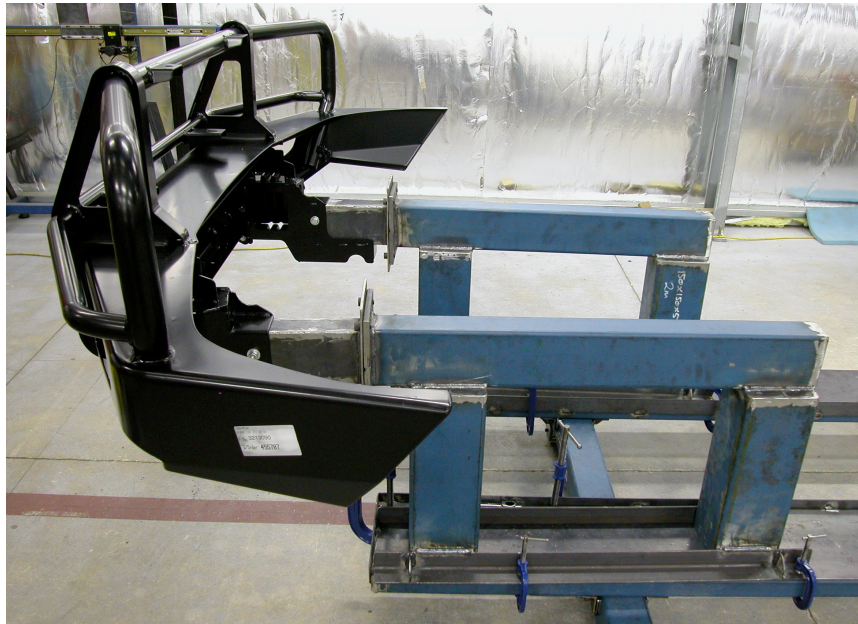

Figure 2.3  
Universal chassis-rail rig

## 2.3 Launching equipment

The headform and upper legform were launched at the required speed, direction and impact location using a machine, designated B2, developed by CASR specifically for launching pedestrian subsystem impactors (Figure 2.4). B2 is able to launch the impactors over a range of angles and speeds.

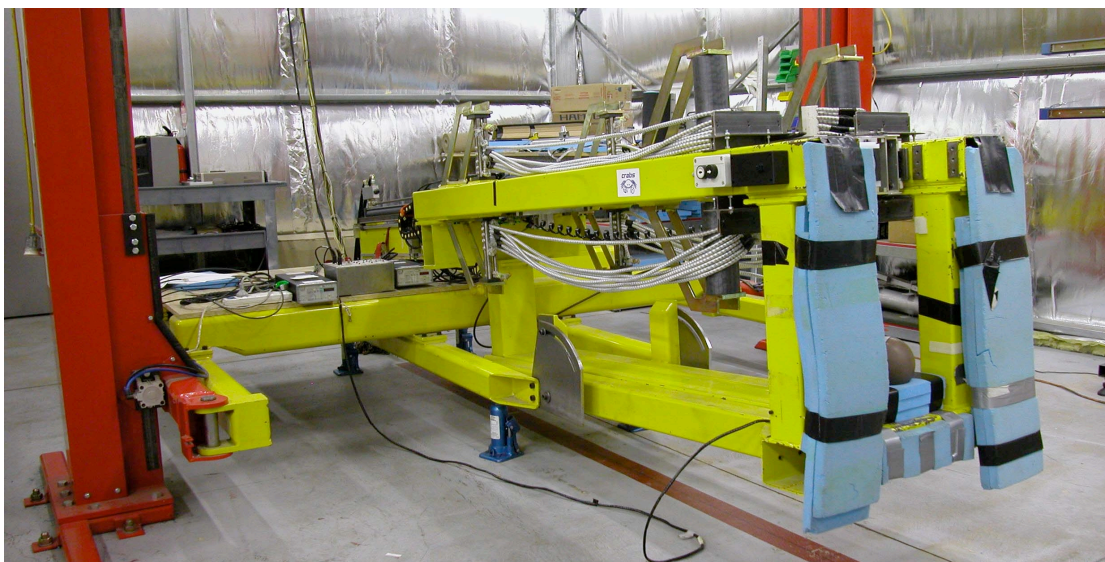

Figure 2.4  
CASR Impactor launch machine B2

## 2.4 Velocity measurements

The velocity of the headform and upper leg was measured in every test using a dual-beam laser measurement system. The system consists of two laser diodes separated by a known distance, set parallel to one another and in line with two receivers. The laser receivers are



connected to a counter-timer. The lasers and receivers were set so that the headform would break each of the laser beams in succession just before impact. The counter-timer recorded the interval between these events. The impact velocity was calculated by dividing the distance between the lasers by the time elapsed between the two laser signals.

## 2.5 Impactors

The headform used in this test was an EEVC WG17 2.5 kg Child Headform Impactor manufactured by First Technology Safety Systems. This headform was manufactured to comply with the child headform impactor specification as defined in the EEVC Working Group 17 Report dated December 1998, with September 2002 updates.

The certification criteria for the headform in AS 4876.1 are identical to the criteria in EEVC WG17 December 1998. However these criteria were modified in EEVC WG17 September 2002. The headform used in these tests complies with EEVC WG17 September 2002 not with EEVC WG17 December 1998.

The upper legform used in this test was manufactured by TRL limited.

## 2.6 Instrumentation

The accelerometer used in this test was a Model 7267A manufactured by Endevco. This is a replaceable element triaxial accelerometer designed to measure acceleration in three perpendicular axes. This accelerometer is specifically designed for use in anthropomorphic dummies used in automotive crash studies.

## 2.7 Signal conditioning

The amplifier used to drive the headform accelerometers was a Model 136 manufactured by Endevco. Signals were filtered with 10 kHz Butterworth low pass filters on each channel before sampling. The amplifier was set to supply an excitation of 10 volts to each of the accelerometer axes. The gain was set so that a full-scale reading corresponded to a 500 g acceleration.

The signals from the force transducers on the upper legform were amplified using an amplifier designed and built by CASR. Signals were filtered with 10 kHz Butterworth low pass filters before sampling. The force transducers were zeroed at  $-4$  V to allow a full scale output of 9 V, corresponding to a full scale reading of approximately 9 kN at each force transducer. The strain gauges used to calculate the bending moment were driven by a Model 136 amplifier manufactured by Endevco.

## 2.8 Data acquisition

All data were sampled with 12 bit single ended analogue-to-digital data acquisition system. The data were sampled at 50 kHz per channel.

## 2.9 Data processing

The sampled data were digitally filtered to a channel frequency class of 1000 Hz and an amplitude of 500 g as defined by ISO 6487: 1987, scaled into units of g (gravity) and the Head Injury Criterion (HIC) was calculated using routines programmed in MATLAB, a mathematical and signal processing software package.

The formula for HIC is as follows:

$$\text{HIC} = (t_2 - t_1) \left[ \frac{\int_{t_1}^{t_2} a \, dt}{t_2 - t_1} \right]^{2.5}$$

where “a” is the resultant impact acceleration in units of gravity (g) and  $t_1$  and  $t_2$  are times, in milliseconds, chosen to maximise the value of HIC.

## 2.10 High speed video

A high speed digital video camera was used to record the impact in each test. Impacts were videoed at 1000 frames per second. These videos were used to ensure that the impactors were correctly aligned with the bull bar or bonnet leading edge on impact.

## 2.11 Impact conditions

The tests were conducted under the following conditions:

- The headform was in 'free flight' at the moment of impact. The test results were not influenced by contact between the impactor and the propulsion system at any stage.
- The upper legform was constrained to move in one axis only (the longitudinal axis of the impactor).
- The stabilized temperature of the frontal protection system and the impactor for the dynamic child headform test was within the range of 20 (+/- 4) degrees C.
- The trajectory of the impactors immediately prior to impact was horizontal (+/- 2 degrees) and in a vertical plane parallel (+/- 2 degrees) to the fore and aft axis of the test frame.
- At the time of first contact the trajectory line through the centre of the impactor in each test was within 10 mm of the centre of the test position.
- The speed of the impactor in each test, at the moment of impact, was 8.33 (+/- 0.2) m/s (30 km/h +/- 0.72 km/h).

### 3 Bull bar and vehicle selection

---

The test program was coordinated with ANCAP's pedestrian testing program, and hence the vehicle selection was determined by ANCAP. ANCAP choose vehicles according the largest volume selling vehicles in the particular market segment. The vehicles in this study came from a 4WD testing program and work utility testing program. The vehicles tested were:

- Toyota Landcruiser (100 Series, manufactured Oct 2004)
- Nissan Patrol (manufactured Oct 2004)
- Ford Courier 4WD crew cab (manufactured July 2005)
- Toyota Hilux 4WD crew cab (manufactured Oct 2005)
- Holden Rodeo 4WD crew cab (manufactured Oct 2005)

Depending on the vehicle model, bull bars may be available to consumers at the time that the vehicle is purchased new. Bull bars supplied by the vehicle manufacturer or manufacturer's dealer are known as "factory" bull bars or "original equipment supplied" (OES) bull bars. Bull bars are also commonly purchased as an after-market accessory.

Bull bars available in Australia are manufactured from a range of materials. The majority are metal (commonly steel or aluminium/alloy). Polymer bull bars are also available and are usually a rotary moulded polyethylene product.

It was not possible to test every type, material and brand of bull bar available in Australia. Our choices were guided by the following criteria:

- For every vehicle, we would test up to three bull bars
- One of the bull bars fitted to each vehicle should be an OES product.
- For each vehicle, we would test a steel bull bar, an aluminium/alloy bull bar and a polymer bull bar
- Where bull bars of the same brand and material were very similar between vehicle models that we were testing, results from a single bull bar were used for both vehicle bull bar models.

The bull bars selected for testing are described in Table 3.1. The brand of each bull bar is not identified, but bull bars were selected from popular brands with national distribution.

**Table 3.1**  
**Bull bar descriptions**

Vehicle	Year	Steel bull bar	Aluminium/alloy bull bar	Polymer bull bar
Toyota Landcruiser 100	2004	Aftermarket bumper replacement	OES bumper replacement	Not available at the time of testing
Nissan Patrol	2004	OES bumper replacement	Aftermarket nudge-bar	Aftermarket bumper replacement
Ford Courier	2005	Aftermarket bumper replacement	OES bumper replacement	Aftermarket bumper replacement
Holden Rodeo	2005	Aftermarket bumper replacement (note 1)	OES bumper replacement	Aftermarket bumper replacement
Toyota Hilux	2005	OES bumper replacement	After market over-bumper style (note 2)	Not available at the time of testing

Notes:

1. The Holden Rodeo aftermarket steel bull bar was the same brand as, and was almost identical to, the Toyota Landcruiser aftermarket steel bull bar. Tests were performed on the Landcruiser bull bar and the results were used for both bull bars.
2. The Toyota Hilux aftermarket alloy bull bar was almost identical to the Nissan Patrol aftermarket alloy bull bar, except for the addition of wing sections. Tests were performed on the Patrol bull bar and the results were used for both bull bars.

The test locations were chosen to reflect moderate to severe impact locations on the bull bars.

The Part A test upper legform impact locations were a mixture of top-rail impacts mid-way between, and also closer to, the bull bar stanchions.

The Part B impact locations were chosen where the bull bars appeared to be structurally stiff, or where there was a significant mass of material surrounding the impact location.

For the Part C child headform impacts, we chose locations on the top rail, either close to or on the main bull bar stanchions, subject to the test locations being at least 1000 mm above the ground. For very stiff bull bars, we chose to test in the centre of the top rail, away from the stiffest part of the bar, to prevent damage to the headform.

For the vehicle comparison tests, we selected locations that were not necessarily directly behind the bull bar test locations, but were likely to produce the most severe impact. This was done on the reasoning that any point along the vehicle is equally as likely to be struck as any other point.

The bull bars and the impact locations for each test are illustrated in Figure 3.1 to Figure 3.16.



Figure 3.1  
Toyota Landcruiser test locations. Letters correspond to test locations for Part A, B and C tests

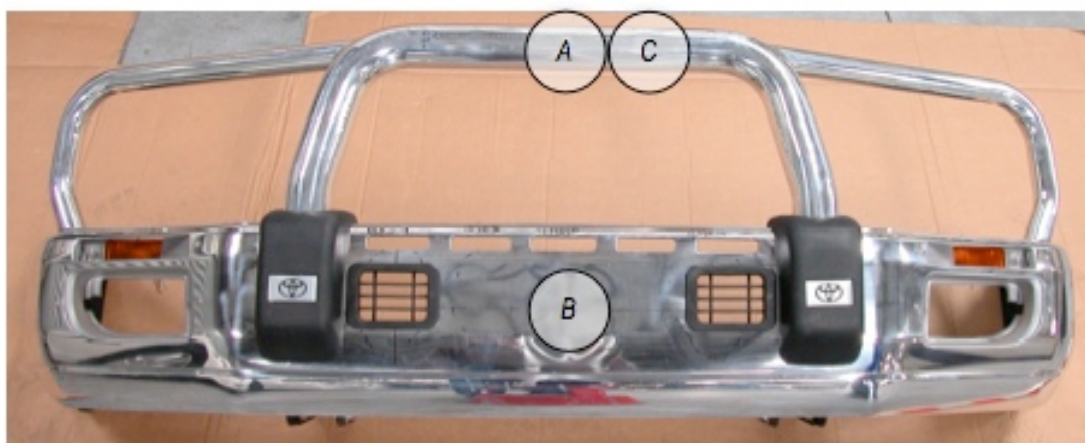

Figure 3.2  
Toyota Landcruiser OES alloy / aluminium bull bar test locations.  
Letters correspond to test locations for Part A, B and C tests



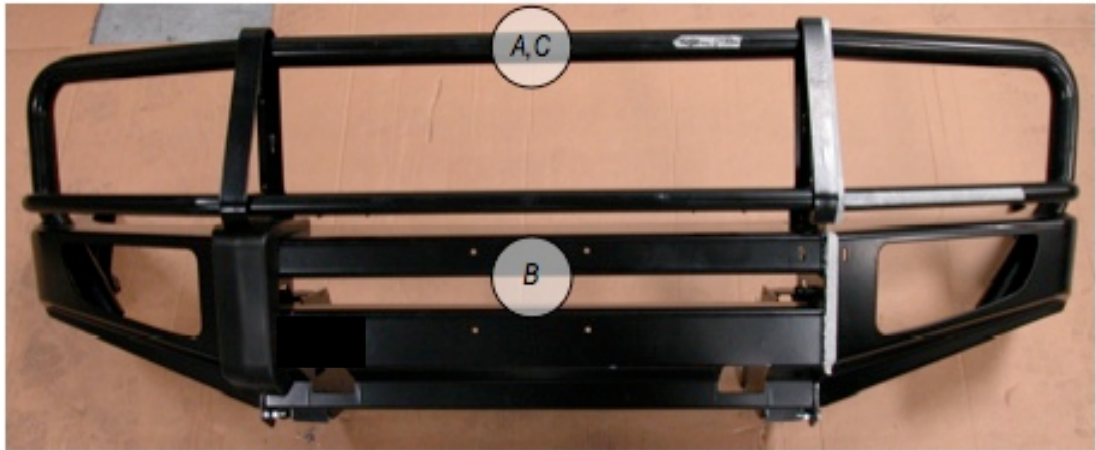

Figure 3.3  
Toyota Landcruiser aftermarket steel bull bar test locations.  
Letters correspond to test locations for Part A, B and C tests



Figure 3.4  
Nissan Patrol test locations. Letters correspond to test locations for Part A, B and C tests



Figure 3.5  
Nissan Patrol aftermarket alloy / aluminium nudge bar test locations.  
Letters correspond to test locations for Part A, B and C tests

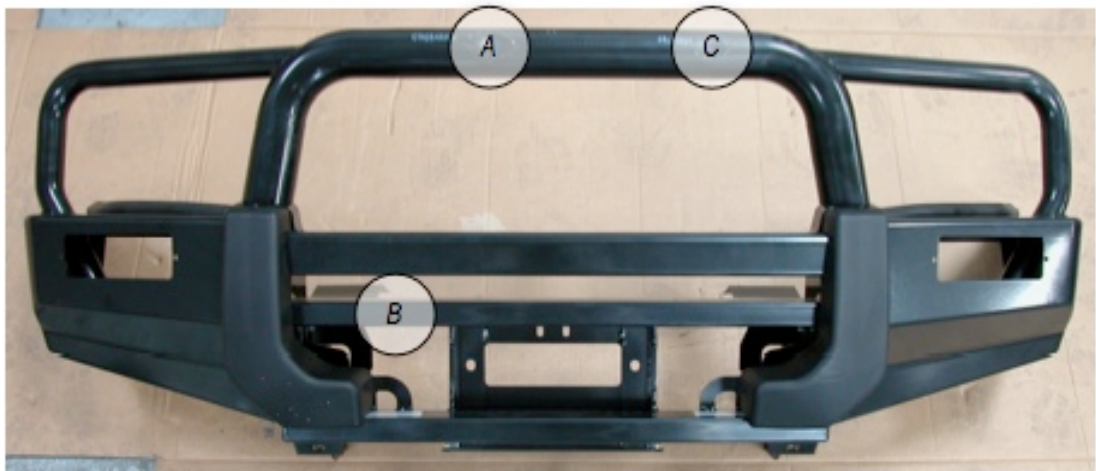

Figure 3.6  
Nissan Patrol OES steel bull bar test locations.  
Letters correspond to test locations for Part A, B and C tests



Figure 3.7  
Nissan Patrol aftermarket polymer bull bar test locations.  
Letters correspond to test locations for Part A, B and C tests



Figure 3.8  
Ford Courier test locations. Letters correspond to test locations for Part A, B and C tests





Figure 3.9  
Ford Courier aftermarket steel bull bar test locations.  
Letters correspond to test locations for Part A, B and C tests

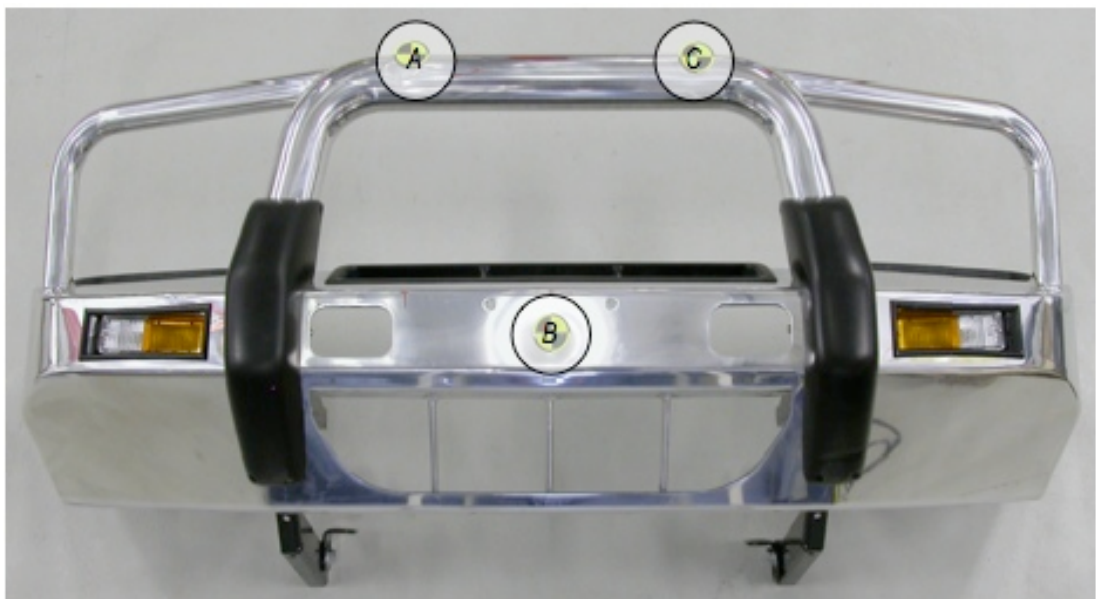

Figure 3.10  
Ford Courier OES alloy / aluminium bull bar test locations.  
Letters correspond to test locations for Part A, B and C tests



Figure 3.11  
Ford Courier aftermarket polymer bull bar test locations.  
Letters correspond to test locations for Part A, B and C tests



Figure 3.12  
Holden Rodeo test locations. Letters correspond to test locations for Part A, B and C tests

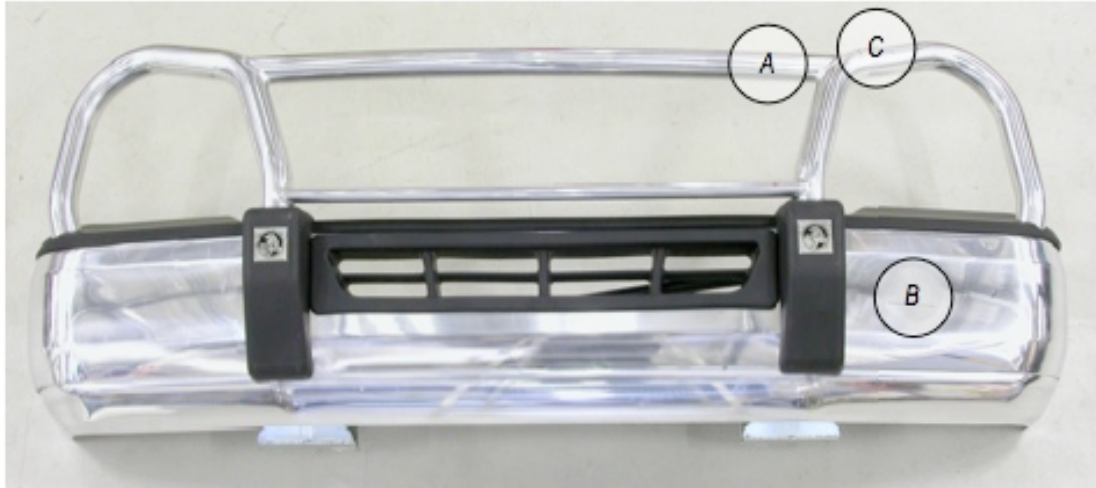

Figure 3.13  
Holden Rodeo OES alloy / aluminium bull bar test locations.  
Letters correspond to test locations for Part A, B and C tests

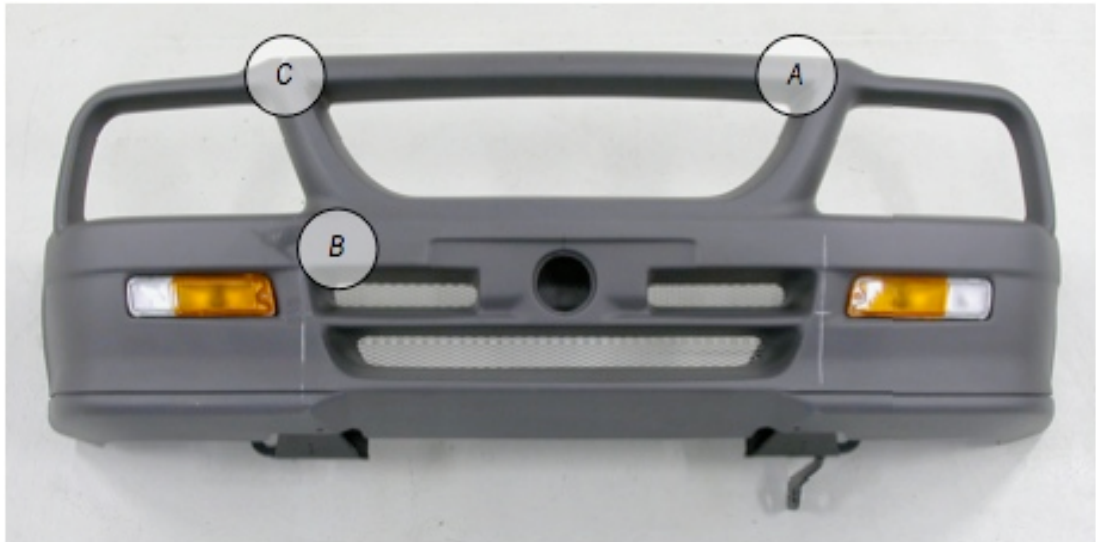

Figure 3.14  
Holden Rodeo aftermarket polymer bull bar test locations.  
Letters correspond to test locations for Part A, B and C tests





Figure 3.15  
Toyota Hilux test locations. Letters correspond to test locations for Part A, B and C tests



Figure 3.16  
Toyota Hilux OES steel bull bar test locations.  
Letters correspond to test locations for Part A, B and C tests

## 4 Results

The results for individual vehicles and the corresponding bull bars are presented here, with each bull bar being identified by the material that it is made from: steel, alloy/aluminium, or polymer. The alloy/aluminium bull bars consist of bull bars manufactured from low density metal.

### 4.1 Impact speed and angle

The impact speed was recorded in each test. Part A of the assessment protocol required a test angle to be computed and set, based on the geometry of the bull bar (or vehicle front). The nominal test speed for every test was 30 km/h which is equivalent to 8.33 m/s. Table 4.1 shows the actual test speeds and the angle of the impact from the horizontal.

**Table 4.1**  
Measured impact conditions for all tests

Vehicle	Vehicle test		Steel bull bar		Aluminium/alloy bull bar		Polymer bull bar	
	Vel (m/s)	Angle (deg.)	Vel (m/s)	Angle (deg.)	Vel (m/s)	Angle (deg.)	Vel (m/s)	Angle (deg.)
<b>Part A tests: Upper legform to bonnet leading edge / top rail</b>								
Toyota Landcruiser	8.41	27	8.32	23	8.25	13	(not available at time of testing)	
Nissan Patrol	8.48	25	8.36	17	8.40	17	8.35	16
Ford Courier	8.50	16	8.28	16	8.38	17	8.42	16
Holden Rodeo	8.34	25	(see Landcruiser steel results)		8.40	22	8.24	18
Toyota Hilux	8.36	22	8.33	20	(see Patrol alloy results)		(not available at time of testing)	
<b>Part B: Upper legform to bumper</b>								
Toyota Landcruiser	8.43	0	8.36	0	8.34	0	(not available at time of testing)	
Nissan Patrol	8.31	0	8.31	0	8.25	0	8.33	0
Ford Courier	8.30	0	8.27	0	8.25	0	8.27	0
Holden Rodeo	8.34	0	(see Landcruiser steel results)		8.31	0	8.34	0
Toyota Hilux	8.29	0	8.29	0	(see Patrol alloy results)		(not available at time of testing)	
<b>Part C: Child headform to bonnet leading edge / top rail</b>								
Toyota Landcruiser	8.29	0	8.39	0	8.42	0	(not available at time of testing)	
Nissan Patrol	8.25	0	8.32	0	8.33	0	8.30	0
Ford Courier	8.38	0	8.41	0	8.43	0	8.45	0
Holden Rodeo	8.43	0	(see Landcruiser steel results)		8.34	0	8.35	0
Toyota Hilux	8.38	0	8.38	0	(see Patrol alloy results)		(not available at time of testing)	

### 4.2 Part A test results

Part A tests consisted of an upper legform to upper rail (or bonnet leading edge) impact. The upper legform produces two measures of impact severity: Force and bending moment. The legform consists of a simply supported beam surrounded by rate-sensitive foam (Confor foam). The force is measured at two points: at each of the beam's supports. The total force is given by the sum of the two support forces.

The bending moment is measured by strain gauges placed at three points along the beam. The largest value measured by the three strain gauges is used to characterise the bending moment produced in the impact.

The impact force results of the tests are given in Table 4.2, by vehicle and bull bar (material) type. The result of the test with the bonnet leading edge is also shown. This latter test shows the performance of the vehicle without the bull bar. The average results from tests

with the bonnet leading edge of the vehicles and the top rail of the bull bars are tabulated in Table 4.2, and also graphed in Figure 4.1.

The results show that, by the measure of peak force generated in the test, the polymer bull bars produced the lowest force and that the results were at or under the Euro NCAP injury threshold value of 5.0 kN. Note though that the test speed used in this study was 30 km/h and that typical test speeds in Euro NCAP tests are generally higher, and so it should not be concluded that the polymer bull bars comply with Euro NCAP testing requirements. Nevertheless, the polymer bull bars appear to be safer than the leading edges of the vehicles that they are mounted to.

Aluminium/alloy bull bars appear to perform similarly to the bonnet leading edge of the vehicles tested, but slightly worse overall. In contrast, steel bull bars produced about twice the impact force as the leading edges of the vehicles. Note that the similarity between three of the results does not reflect any “clipping” of the data that occurred in other tests on the steel bull bars (e.g. see Table 4.3) but indicates very similar performance across the bull bars tested.

**Table 4.2**  
Results of upper legform impact (Part A) tests by individual vehicle: peak force (kN)

Vehicle	Bonnet leading edge	Steel bull bar	Aluminium/alloy bull bar	Polymer bull bar
Toyota Landcruiser	7.7	12.4	<b>6.3</b> <sup>3</sup>	Not available
Nissan Patrol	6.0	12.4 <sup>3</sup>	7.4	<b>4.2</b>
Ford Courier	5.7	12.4	8.5 <sup>3</sup>	<b>5.0</b>
Holden Rodeo	8.4	12.4 <sup>2</sup>	6.3 <sup>3</sup>	<b>4.4</b>
Toyota HiLux	<b>4.5</b>	13.3 <sup>3</sup>	7.4 <sup>2</sup>	Not available

Notes:

1. Bold figures denote best result
2. Denotes default result taken from another test on an equivalent bar (see Section 3)
3. Denotes results for tests on bull bars that are optionally factory fitted (OES)

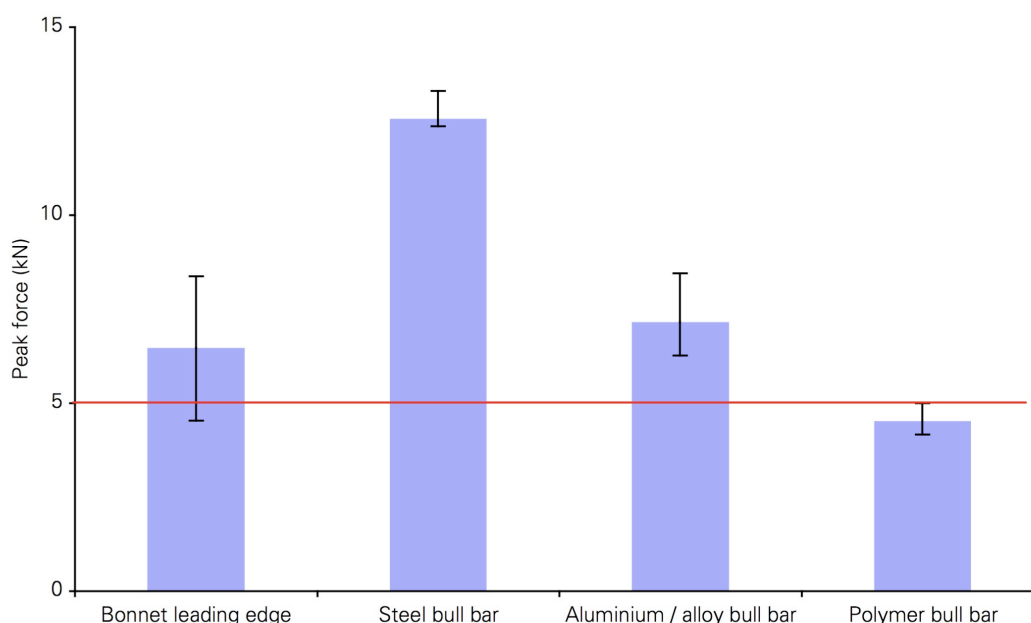

**Figure 4.1**  
Average peak force values from Part A tests on the bonnet leading edge and the top rail of the specified types of bull bar. The range of values measured in the tests is shown. The red line indicates the injury tolerance limit of 5 kN.

The tests also produced measures of the bending moment across the legform. The Euro NCAP limit for bending is 300 Nm. The bending moment results of the upper legform tests are shown in Table 4.3, and the average values in Figure 4.2. The polymer bull bars produced the lowest bending moments and were, on average, better performing than the front of the vehicle.

The alloy bull bar test results were generally similar to or worse than those for the fronts of vehicle, and the steel bull bars were much worse. In tests on the steel bull bars, the severity of the impact was so great that the measuring capability of the instrumentation was exceeded in every test.

The polymer bull bars produced, on average, bending moments less than the Euro NCAP injury threshold, but (as noted previously) at a lower impact speed than that which would be specified by the Euro NCAP protocol.

**Table 4.3**  
Results of upper legform impact (Part A) tests by individual vehicle: peak bending moment (Nm)

Vehicle	Leading edge	Steel bull bar	Aluminium/alloy bull bar	Polymer bull bar
Toyota Landcruiser	<b>469</b>	>1025 <sup>4</sup>	541 <sup>3</sup>	Not available
Nissan Patrol	364	>1022 <sup>3,4</sup>	635	<b>156</b>
Ford Courier	<b>372</b>	>1018 <sup>4</sup>	732 <sup>3</sup>	423
Holden Rodeo	608	>1025 <sup>2,4</sup>	538 <sup>3</sup>	<b>299</b>
Toyota HiLux	<b>362</b>	>1007 <sup>3,4</sup>	635 <sup>2</sup>	Not available

Notes:

1. Bold figures denote best result
2. Denotes default result taken from another test on an equivalent bar (see Section 3)
3. Denotes results for tests on bull bars that are optionally factory fitted
4. Over-range result. Peak bending moment clipped to this value

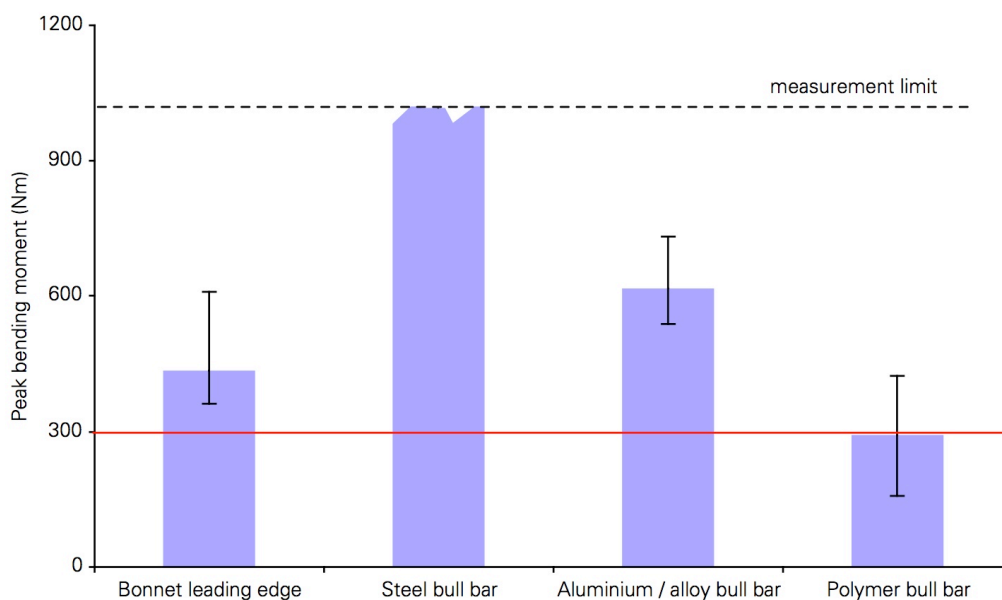

**Figure 4.2**  
Average peak bending moment values from Part A tests on the vehicles' leading edges and the top rails different types of bull bars. The error bars indicate the range of values measured in the tests on each type of bull bar. The red line indicates the injury tolerance limit of 300 Nm.

## 4.3 Part B test results

Part B tests consisted of an upper legform impact on the bumper section of the bull bar. The measures of impact severity and the threshold values for injury were identical to the part A tests.

The impact force results of the tests are given in Table 4.4, by vehicle and bull bar (material) type, and also graphed in Figure 4.3. The results of tests with the vehicle bumper are also given. These latter tests show the performance of the vehicles without the bull bar.

The bending moment results of the upper legform tests are shown in Table 4.5, and the average values in Figure 4.4.

It may be noted that, according to the bending moment produced in these tests, the bull bars performed similarly to or often only slightly worse than the vehicle itself. However, the peak impact force produced by the bumper sections of the steel bull bars and two of the aluminium/alloy bars was considerably higher than that for the vehicle bumper. The bumper section of the bull bar presents a broad, flat surface to the impactor, and hence bending across the impactor is not as pronounced as in tests with the top rail of the bull bar. However, the stiffness and mass of the bumper sections is such that the impact force produced is higher than in the tests of the top rails of the bull bars.

While some of the aluminium/alloy bars and the polymer bars performed similarly to the vehicle bumpers, all results, with the exception of one test, exceeded the injury threshold value of 5 kN.

**Table 4.4**  
Results of upper legform impact (Part B) tests by individual vehicle: peak force (kN)

Vehicle	Vehicle bumper	Steel bull bar	Aluminium/alloy bull bar	Polymer bull bar
Toyota Landcruiser	<b>6.9</b>	12.0	12.2 <sup>3</sup>	Not available
Nissan Patrol	11.7	13.6 <sup>3</sup>	7.3	<b>7.1</b>
Ford Courier	11.0	17.1	16.2 <sup>3</sup>	<b>6.8</b>
Holden Rodeo	<b>4.1</b>	12.0 <sup>2</sup>	9.4 <sup>3</sup>	11.9
Toyota HiLux	<b>7.2</b>	17.3 <sup>3</sup>	7.3 <sup>2</sup>	Not available

Notes:

1. Bold figures denote best result
2. Denotes default result taken from another test on an equivalent bar (see Section 3)
3. Denotes results for tests on bull bars that are optionally factory fitted



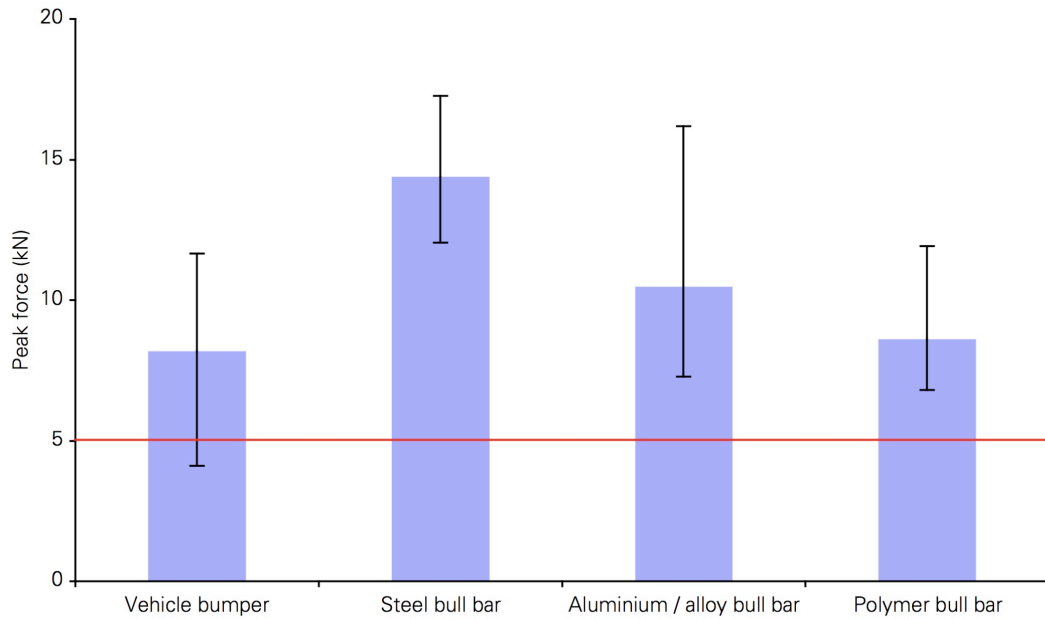

**Figure 4.3**  
Average peak force values from Part B tests on the vehicle bumper and the bumper areas of the specified types of bull bar. The range of values measured in the tests is shown. The red line indicates the injury tolerance limit of 5 kN.

**Table 4.5**  
Results of upper legform impact (Part B) tests by individual vehicle: peak bending moment (Nm)

Vehicle	Vehicle bumper	Steel bull bar	Aluminium/alloy bull bar	Polymer bull bar
Toyota Landcruiser	<b>406</b>	412	791 <sup>3</sup>	Not available
Nissan Patrol	726	<b>362</b> <sup>3</sup>	674	426
Ford Courier	693	982	>1034 <sup>3,4</sup>	<b>535</b>
Holden Rodeo	<b>88</b>	412 <sup>2</sup>	640 <sup>3</sup>	660
Toyota HiLux	<b>378</b>	740 <sup>3</sup>	674 <sup>2</sup>	Not available
Average	458	582	763	540

Notes:

1. Bold figures denote best result
2. Denotes default result taken from another test on an equivalent bar (see Section 3)
3. Denotes results for tests on bull bars that are optionally factory fitted
4. Over-range result. Peak bending moment clipped to this value

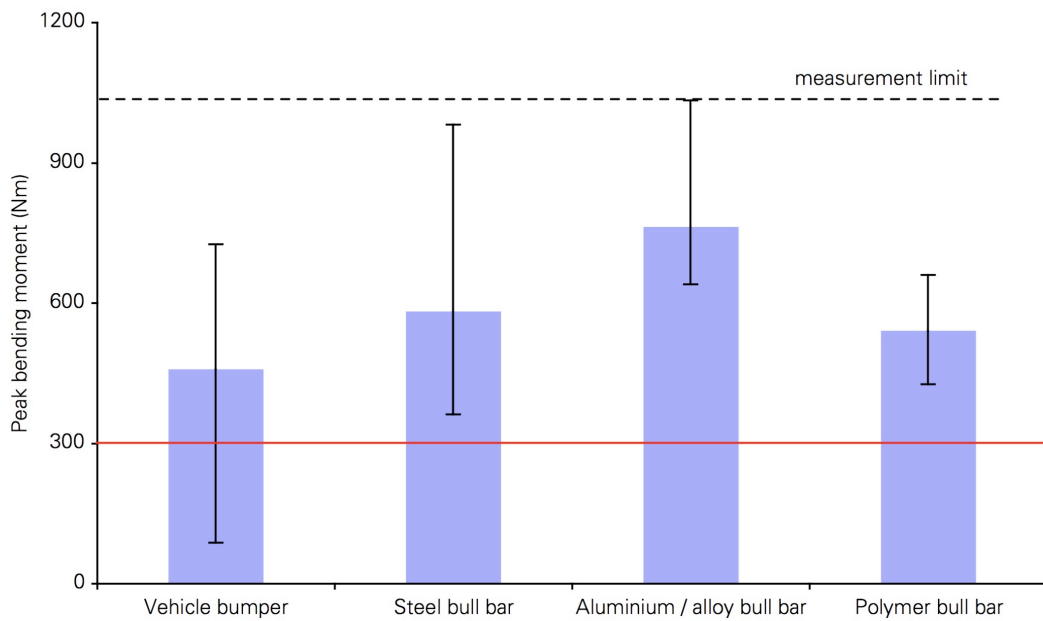

**Figure 4.4**  
Average peak bending moment values from Part B tests on the vehicle bumper and the bumper areas of different types of bull bar. The range of values measured in the tests is shown. The red line indicates the injury tolerance limit of 300 Nm.

## 4.4 Part C test results

Part C tests consisted of an impact between a 2.5 kg child headform, and parts of the top rail of the bull bar more than 1000 mm above the ground. The child headform is launched horizontally at 30 km/h. The headform acceleration produced by the impact is measured and used to calculate the Head Injury Criterion (HIC) value (see Section 2.9). The results of the Part C tests are given in Table 4.6.

The results show that the polymer bull bars produced the least severe headform impacts on average, but were more severe than the results of the tests on the corresponding vehicles in two of the three tests (Patrol and Rodeo). The steel and aluminium/alloy bull bars produced more severe impacts than either the polymer bull bars or the leading edge of the vehicle. In several of the tests of steel bull bars the HIC values listed are artificially low, as the acceleration exceeded the measurement range of the instrumentation.

Table 4.6  
Results of headform impact (Part C) tests by individual vehicle: HIC value

Vehicle	Bonnet leading edge	Steel bull bar	Aluminium/alloy bull bar	Polymer bull bar
Toyota Landcruiser	<b>1524</b> <sup>1</sup>	4749	2514 <sup>3</sup>	Not available
Nissan Patrol	<b>837</b>	>5817 <sup>3,4</sup>	2048	1162
Ford Courier	2156	5255	3092 <sup>3</sup>	<b>612</b>
Holden Rodeo	<b>1160</b>	>4749 <sup>2,4</sup>	1246 <sup>3</sup>	1232
Toyota HiLux	<b>1698</b>	>6384 <sup>3,4</sup>	2048 <sup>2</sup>	Not available

Notes:

1. Bold figures denote best result
2. Denotes default result taken from another test on an equivalent bar (see Section 3)
3. Denotes results for tests on bull bars that are optionally factory fitted
4. Acceleration was clipped. Actual HIC result higher than this value.

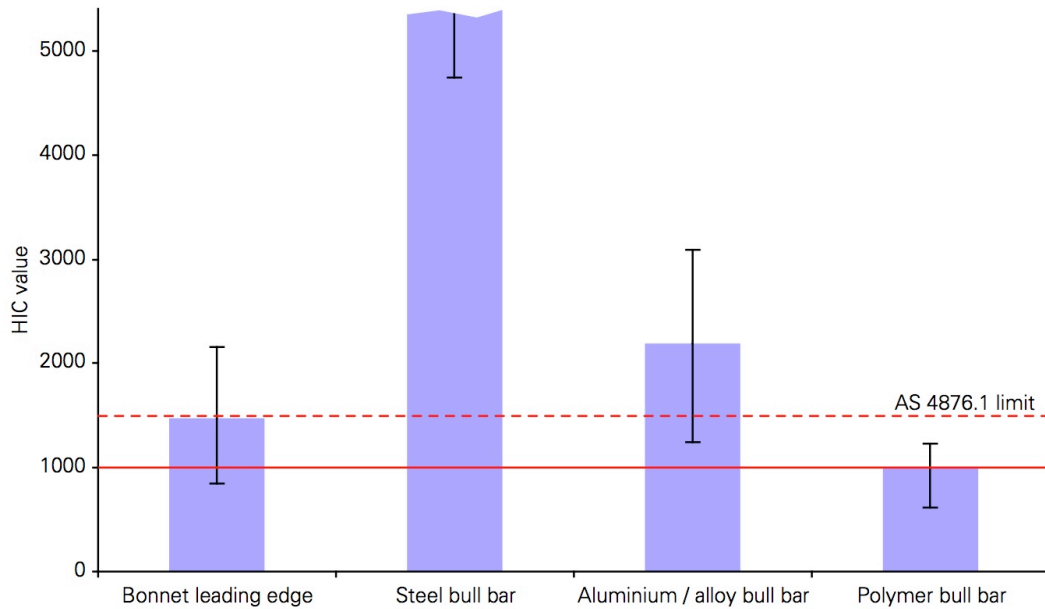

Figure 4.5  
Average Head Injury Criterion values from Part C tests on the bonnet leading edge and the specified types of bull bar. The range of values measured in the tests is shown. The red line indicates the injury tolerance limit of HIC 1000. The broken line indicates a HIC of 1500 as specified in AS4876.1. Note that the maximum recordable acceleration was 500 m/s<sup>2</sup>, and results from tests on the steel bull bars exceeded this value.

## 5 Rating the performance of bull bars in these tests

One of the aims of this report is to work towards consumer-oriented information on the relative safety of bull bars. In this section we develop a scoring system that distils the technical data presented in the previous section into a rating that is simple to interpret.

For consumers to gain a simple overview of pedestrian testing results, Euro NCAP and ANCAP employ a scoring system that conveys the relative safety performance of vehicles, in a reasonably simple manner. The Euro NCAP assessment protocol uses ‘higher performance limits’ (test results meeting the most stringent criteria) and ‘lower performance limits’ (less stringent criteria) to characterise test results as fair, marginal or poor. The parts of the assessment protocol relevant to this study, are reproduced in Table 5.1.

In the headform test, the assessment is based on the HIC value. The upper legform produces two measures of impact severity (force and bending moment), and it is the worse of the two measures that is used for the assessment.

In Table 5.2, the Euro NCAP assessment protocol is applied to the results of tests in this study. (Note that Euro NCAP and ANCAP use a test speed of 40 km/h, whereas the tests reported here were performed at 30 km/h; see Section 2 for details) It may be noted that the leading edge of the vehicle often performed poorly, but in 2 of the 15 tests of the leading edge of the vehicle, the performance was rated as “fair”. The poor performance of steel and aluminium/alloy bull bars is evident. The polymer bull bars performed better in the Part A upper legform tests and in the Part C headform tests, but performed poorly in the Part B tests of the bumper sections.

**Table 5.1**  
Rating system, using test performance limits, based on Euro NCAP assessment protocol version 4.1

	Fair	Marginal	Poor
Headform	HIC < 1000	1000 ≤ HIC ≤ 1350	HIC > 1350
Upper legform	Bending mom. ≤ 300 Nm	300 Nm < Bending mom. ≤ 380 Nm	Bending mom. > 380 Nm
	Sum of forces ≤ 5.0 kN	5.0 kN < Sum of forces ≤ 6.0 kN	Sum of forces > 6.0 kN

The overall impression of Table 5.2 is that the steel and aluminium/alloy bull bars degrade the performance of the front of the vehicle, and the polymer bull bars marginally improve the performance of the front of the vehicle.

A common criticism of bull bars is made on this particular point: that they increase the risk of injury to pedestrians. To explore this further, we propose a system for assessing the performance of the bull bars relative to the fronts of vehicle to which they are attached. This system is shown in Table 5.3. The ratio of the two test results is calculated (bull bar result : vehicle leading edge result). A ratio less than one indicates that the bull bar impact was less severe than the front of the vehicle.

The relative performance limits for each category are arbitrary, and were chosen to produce more differentiation in performance than the Euro NCAP protocol produced in Table 5.2. Note that, for the upper legform test results, the ratio of the impact force and ratio of the bending moment results are calculated, and the higher ratio is used to characterise the relative performance.

**Table 5.2**  
Performance of bull bars at 30 km/h, relative to the injury tolerance values used in this study

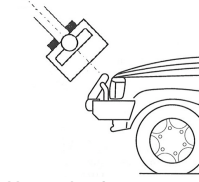
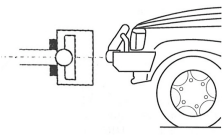
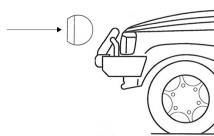
	Vehicle	Leading edge	Steel bull bar	Aluminium/alloy bull bar	Polymer bull bar
 Upper legform to top rail	Toyota Landcruiser	Poor	Poor	Poor	-
	Nissan Patrol	Marginal	Poor	Poor	Fair
	Ford Courier	Marginal	Poor	Poor	Poor
	Holden Rodeo	Poor	Poor	Poor	Fair
	Toyota Hilux	Marginal	Poor	Poor	-
 Upper legform to bumper	Toyota Landcruiser	Poor	Poor	Poor	-
	Nissan Patrol	Poor	Poor	Poor	Poor
	Ford Courier	Poor	Poor	Poor	Poor
	Holden Rodeo	Fair	Poor	Poor	Poor
	Toyota Hilux	Poor	Poor	Poor	-
 Child headform to top rail	Toyota Landcruiser	Poor	Poor	Poor	-
	Nissan Patrol	Fair	Poor	Poor	Marginal
	Ford Courier	Poor	Poor	Poor	Fair
	Holden Rodeo	Marginal	Poor	Marginal	Marginal
	Toyota Hilux	Poor	Poor	Poor	-

**Table 5.3**  
Relative assessment system, for bull bars compared to the front of vehicles to which they are attached

Less aggressive	Slightly more aggressive	Moderately more aggressive	Much more aggressive
Ratio of performance < 1.0	1.0 ≤ ratio < 1.5	1.5 ≤ ratio < 2.5	2.5 ≤ ratio

The results of applying the relative assessment system (Table 5.3) are shown in Table 5.4. Again the impression is that steel bull bars significantly degrade the safety performance of the front of the vehicle, the aluminium/alloy bull bars also degrade the performance of the vehicle, but to a lesser extent than the steel bull bars, and that the polymer bull bars slightly improve the vehicles' performance.

**Table 5.4**  
**Aggressiveness of bull bars relative to the front of the vehicle to which they attach**

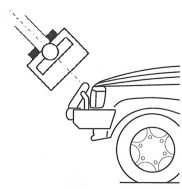
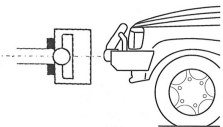
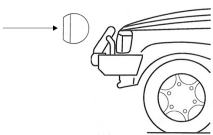
	Vehicle	Steel bull bar	Aluminium/alloy bull bar	Polymer bull bar
 <p>Upper legform to top rail</p>	Toyota Landcruiser	Moderately more	Slightly more	-
	Nissan Patrol	Much more	Moderately more	Less
	Ford Courier	Much more	Moderately more	Slightly more
	Holden Rodeo	Moderately more	Less	Less
	Toyota HiLux	Much more	Moderately more	-
 <p>Upper legform to bumper</p>	Toyota Landcruiser	Moderately more	Moderately more	-
	Nissan Patrol	Slightly more	Less	Less
	Ford Courier	Moderately more	Slightly more	Less
	Holden Rodeo	Much more	Much more	Much more
	Toyota HiLux	Moderately more	Moderately more	-
 <p>Child headform to top rail</p>	Toyota Landcruiser	Much more	Moderately more	-
	Nissan Patrol	Much more	Moderately more	Slightly more
	Ford Courier	Moderately more	Slightly more	Less
	Holden Rodeo	Much more	Slightly more	Slightly more
	Toyota HiLux	Much more	Slightly more	-

## 6 Discussion

---

The results of the tests performed in this study support the view that bull bars increase the risk of injury to pedestrians. However, polymer bull bars of the type tested here are, in some tests, less aggressive to a pedestrian than the front of the vehicle that they are designed to protect.

### 6.1 Headform impact results

While many of the bull bars performed poorly in the headform tests, it is also clear that the bonnet leading edge of most of the tested vehicles also performed poorly (Table 5.2). While the leading edges were, in many cases, less rigid than the steel bull bars and some of the aluminium/alloy bull bars, they too have not been designed to be safe in impacts with child or adult pedestrians, and in many cases pose a high risk of injury in pedestrian collisions.

Nevertheless, the results of the analysis shown in Table 5.4 demonstrate that the metal bull bars have a significantly worse impact performance than the bonnet leading edge of the vehicles. In two out of three headform tests, the polymer bull bars also performed worse than the vehicle but to a much lesser degree than the metal bars. However, it should be borne in mind that the vehicles performed fairly, or marginally in two tests and the polymer bull bar performed marginally in both of these cases. Furthermore, unlike the tests on the metal bars, the polymer bull bars were tested directly on the top of the bull bar stanchion, which was probably the stiffest location, making the comparisons less favourable to the polymer bars.

### Upper legform impact results

The Australian Standard AS 4876.1 does not include an impact that measures injury risk to adult pedestrians. In this study we used the EEVC WG17 upper legform impactor to examine the risk of upper leg injury to an adult pedestrian posed by a vehicle and a bull bar. As in the headform tests, we tested the bull bars at 30 km/h, rather than the 40 km/h nominated by the EU Directive, because the metal bull bars and most of the original equipment bumpers were very stiff. We were concerned that the tests at 40 km/h would have produced impacts beyond the range of our instrumentation, which would have meant that we would not have been able to discriminate the relative performance of the bull bars.

In tests with the top rail of the bull bars (Part A tests), only the polymer bull bars displayed acceptable impact performance, and they were mostly less aggressive in this regard than the leading edge of the vehicles that they were attached to.

Steel bars were very aggressive in Part A tests and an equivalent impact with a pedestrian's upper leg would almost certainly have resulted in severe pelvic and/or femoral injuries.

Part B tests of the bumper sections of bull bars and vehicles were almost uniformly poor, with the steel bars producing the highest impact forces, and aluminium/alloy bars the highest bending moments. The original bumper of one vehicle (Holden Rodeo) performed very well in this test and this resulted in the relative performance of all bull bars being in the "much more aggressive" category. While all polymer bull bars also performed poorly in Part B tests, they were less aggressive than the bumpers they replaced, with the exception of the Rodeo.

## 6.2 OES bull bars and aftermarket bars

All of the original equipment supplied (OES) bull bars tested in this study were metal bars. They performed poorly in all tests and, with the exception of one Part A test, they performed worse than the front of the vehicle. We are aware of at least one recent Australian-made vehicle for which there is an OES bar made from polymer (we were unable to test that bull bar for this study). However, to our knowledge, pedestrian impact performance was not used to guide the design of that bull bar. We are aware that the manufacturer of the aftermarket polymer bull bars tested in this study does conduct tests to assess the level of pedestrian safety of its bars.

It appears from the results of these tests that OES bull bar manufacturers, and most aftermarket suppliers, are not designing bull bars with pedestrian safety in mind, nor does it appear that the vehicle manufacturers require it. We recommend that vehicle manufacturers specify that OES bull bars are tested and, at least, comply with the Australian Standard AS 4876.1 and that the manufacturers of aftermarket bull bars do likewise.

## 6.3 Implications

On the basis of these tests, we can conclude that fitting a vehicle with a metal bull bar increases the risk of severe injury or death to a pedestrian in the event of a collision, even though many of the vehicles that these bull bars are fitted to also perform poorly. The steel bull bars we tested performed worse than aluminium/alloy bull bars in these simulated pedestrian collisions.

AS 4876.1 requires bull bars to pass a test using the EEVC WG17 child headform impactor used in this study. The requirement of the Standard is that the Head Injury Criterion (HIC) value should be 1500 or less when the impactor strikes the bull bar at 30 km/h. In automotive safety testing, a HIC value of less than 1000 is required and 1500 is not normally acceptable. If a child's head was struck by the bull bar at 30 km/h, a bar that just complied with the Standard would be expected to have a high risk of severely injuring that child. While it is true that if the steel bars tested in this study just complied with AS 4876.1 they would be less dangerous than they are at present, they would nevertheless only be safe at speeds lower than 30 km/h.

In this study, we intended to test bull bars at 40 km/h, however, as noted above, preliminary testing indicated that many impacts would be so severe that the accelerations produced would be too great to be measured by the instrumentation in the laboratory. There would have been little difference between the results of many of the tests if we had persevered with an impact speed of 40 km/h.

Product standards are often only agreed to after some compromises that allow for feasibility and other considerations. So while EEVC WG17 recommend a performance requirement of a HIC less than 1000 from an impact at 40 km/h, the AS 4876.1 requires only a HIC of 1500 or less from an impact at 30 km/h, which has only slightly more than half the impact energy of the EEVC recommendation. However, based on the results of this study, and despite the apparent compromises evident in the drafting of AS 4876.1, it remains to be seen whether or not it is feasible for steel bull bars to even meet the requirement of the Australian Standard, let alone a more stringent requirement. It is clear that metal bull bars of current design are, on the whole, unable to comply with AS 4876.1. It is possible that lighter weight designs, using aluminium/alloy materials might be able to do so but polymer bull bars appear to be much more benign than the metal bars. It is possible that, with suitable modification, polymer bull bars may be able to comply with more stringent performance criteria than that



required by AS 4876.1, and manufacturers of polymer bull bars should be encouraged to design their product to do so.

This highlights the disadvantage of the lower test speed and the less stringent performance requirements in AS 4876.1: Moderately aggressive materials and structures may be able to be made to pass the test, even when more benign materials are available. As a consequence, manufacturers will have less incentive to adopt the safest designs, even when it is feasible to do so. We recommend that bull bar manufacturers consider the impact performance of bull bars at higher speeds, as well as at the speed nominated in the Australian Standard, when considering bull bar designs and materials used in bull bars' manufacture.

AS 4876.1 is less stringent than the EU Directive relating to the use of frontal protection systems (2005/66/EC) which is itself a product of a negotiated agreement between the vehicle industry and the European Commission on pedestrian protection. Yet the Directive requires frontal protection systems to comply with legform test provisions, and requires a child/small adult headform test to be conducted at 35 km/h and for the HIC value to be below 1000.

However, at this stage the removal of a bull bar that just fails to meet the Australian Standard may not make a vehicle of the type tested here any safer, as there is no requirement that the vehicle itself should provide an adequate level of pedestrian protection. (Three of the five vehicles in this study do not meet the performance requirements of AS 4876.1).

On the other hand, many bull bars fail the requirements of the Standard by a large margin, and there can be little doubt that the removal of the most aggressive bull bars would make the corresponding vehicles safer in the event of a collision with a pedestrian.

Even on the basis of a limited number of tests, it appears that polymer bull bars have the potential to provide fair protection to pedestrians in the event of a collision. They might also be designed to be able to satisfy more stringent performance requirements than those contained in the Standard. If so, there may be little reason for the low-stringency requirements of the Australian Standard, and more stringent criteria might be stipulated, bringing AS 4876.1 into line with the requirements of a Standard such as EU Directive 2005/66/EC.

With this study, we have demonstrated the performance of bull bars in tests relating to pedestrian safety. It is possible to characterise the safety performance of bull bars relative to the vehicles to which the bars are commonly fitted and we hope that this information will be of interest to the owners of such vehicles. The Australian New Car Assessment Program (ANCAP) regularly reports on the pedestrian safety of new cars available in the Australian market and there may be a place for a similar system for aftermarket products such as bull bars.

This report has focussed solely on pedestrian safety and bull bar design. Bull bars may also increase the risk of injury in other types of collision. They are particularly dangerous to the occupants of other vehicles in side-impact collisions. Bull bars may also alter the crush characteristics of the vehicle to which they are attached and they may therefore adversely affect the impact performance of the vehicle, such as the timing of air bag deployment, and thereby compromise the safety of the vehicle's occupants. (As noted in the first section of this report, the effect of a bull bar on air bag deployment was originally intended to be part of AS 4876, as was the effectiveness of the bull bar in protecting the vehicle in the event of a collision with an animal.)

We recommend that road safety authorities and manufacturers consider all options to encourage consumers away from dangerous bull bars.

## Acknowledgments

---

This study was funded by the South Australian Motor Accident Commission (MAC) through a Project Grant to the Centre for Automotive Safety Research. The MAC Project Manager was Ross McColl. We are grateful for the in-kind support from the Australian New Car Assessment Program (ANCAP). ANCAP provided the vehicles for the comparison tests.

The Centre for Automotive Safety Research receives core funding from both MAC and the Department for Transport, Energy and Infrastructure.

The views expressed in this report are those of the authors and do not necessarily represent those of the University of Adelaide, the sponsoring organisations or other supporting organisations.

## References

---

- 2003/102/EC Directive number 102 of 2003, Official Journal of the European Union, 6 December 2003, L 321, pp 15 - 25
- 2005/66/EC Directive number 66 of 2005, Official Journal of the European Union, 25 November 2005, L 309, pp 37 - 54
- AS 4876.1-2002 Motor vehicle frontal protection systems, Part1: Road user protection, 17 September 2002, Standards Australia, Sydney, Australia, 24 p.
- ATSB 2004, Road deaths Australia: 2004 statistical summary, Australian Transport Safety Bureau, Australian Government, Canberra, Australia, 48 p.
- Attewell R., Glase K. 2000. Bull bars and trauma, Consultant Report 200, Australian Transport Safety Bureau, Australian Government, Canberra, Australia, 54 p.
- EEVC 1994, EEVC Working Group 10 report – Proposals for methods to evaluate pedestrian protection for passenger cars, November 1994
- EEVC 1998, EEVC Working Group 17 Report, Improved test methods to evaluate pedestrian protection afforded by passenger cars, December 1988
- EEVC 2002, EEVC Working Group 17 Report, Improved test methods to evaluate pedestrian protection afforded by passenger cars, December 1988 with September 2002 updates
- Euro NCAP 2004, European New Car Assessment Programme (Euro NCAP) pedestrian testing protocol, version 4.1, March 2004, 51 p.
- FORS 1996, Pedestrian fatalities in Australia, Monograph 7, Federal Office of Road Safety, Canberra, Australia, 4 p.
- ISO 6487:1987 Road vehicles – Measurement techniques in impact tests – Instrumentation, International Standards Organisation.
- Kuczmarski R.J., Ogden C.L., Guo S.S., et al. 2002. 2000 CDC growth charts for the United States: Methods and development. National Center for Health Statistics, Washington D.C..
- Lawrence G., Rodmell C., Osborne A. 2000. Assessment and test procedures for bull bars, TRL report 460, Transport Research Laboratories, Crowthorne, Berkshire, United Kingdom, 50 p.
- McLean A.J., Anderson, R.W.G., Streeter, L.D. 1998, Aggressiveness of bull-bars in the event of a collision with a child pedestrian: Head-form test results for three bull-bar products, Road Accident Research Unit, University of Adelaide, Australia, 12 p.
- Mizuno Y. and Ishikawa H. 2001, Summary of IHRA Pedestrian Safety WG activities – proposed test methods to evaluate pedestrian protection afforded by passenger cars, Paper 280, 17th International Technical Conference on the Enhanced Safety of Vehicles, June 4 – 7 2001, Amsterdam, The Netherlands.
- Ponte, G. van den Berg, A. Streeter, L.D., Anderson, R.W.G. 2004, Pedestrian protection in vehicle impacts: Further results from the Australian New Car Assessment Program, Proceedings of the 2004 Road Safety Research, Policing and Education Conference, 14-16 November, Perth, Australia.