

Engineering

Mechanical Engineering fields

Okayama University

Year 2004

Development of active icosahedron and
its application to virtual clay modeling

Jumpei Ochi
Okayama University

Tatsuya Hashimoto
Okayama University

Junichi Tanaka
Okayama University

Koichi Suzumori
Okayama University

Takefumi Kanda
Okayama University

This paper is posted at eScholarship@OUDIR : Okayama University Digital Information Repository.

http://escholarship.lib.okayama-u.ac.jp/mechanical_engineering/26

Development of Active Icosahedron and its Application to Virtual Clay Modeling

Jumpei OCHI, Tatsuya HASHIMOTO, Junichi TANAKA, Koichi SUZUMORI and Takefumi KANDA
Department of Systems Engineering, Okayama University
3-1-1 Tushima-naka, Okayama 700-8530
Japan

Abstract:

We have been developed an active link mechanism for physical man-machine interaction. We report an active icosahedron consisting of intelligent cylinders and its application to virtual clay modeling. Intelligent pneumatic cylinders are newly developed to realize active link mechanisms. This cylinder aims at a novel cylinder in which various sensors and control devices are built. Active link mechanisms are highly integrated and enhanced by intelligent cylinders. A control system is built for the active icosahedron. In the control system, a key element is a control program implementing drawing of a virtual model on display and controlling of active links. Virtual clays are deformed by the program based on the apex positions converted from cylinder lengths. The active icosahedron realized dynamic interaction with virtual objects in PC, showing the potential of the devices as a haptic interface.

1. INTRODUCTION

The foal of this research is realizing a new type of physical man machine interaction with a compact haptic interface. Especially a point we aim is to show virtual models with distributed physical information such as forces and deformation. We have been developing the active link mechanism shown in Figure 1 to accomplish this aim. We reported an active tetrahedron and an active icosahedron.[1]. This time we report development of an active icosahedron consisting of intelligent cylinders.

Virtual models in PC exist generally on three dimensional coordinate system and they have three dimensional position information. A virtual model is composed of the position information and has continuous surface. It is not easy to treat continuous surface using

conventional haptic interfaces which have low degree of freedom. Haptic interfaces are classified into two types as follows; a concentration type and a distribution type. Presentation of deformation is limited in the case of using by concentrated type presenting deformation at one point. Active link mechanisms are able to effectively treat continuous surface for reasons that these devices are distributed type and have deformable surfaces.

The concept of the active link mechanism as a haptic interface is shown in Figure 2. An operator can feel the deformation of a virtual model via the motion of the active link mechanism. A crucial sense is what give an operator visceral feels of the deformation. An aim of haptic technology is to give an operator touch feel on the virtual model to offset visual information. The active link mechanism is one way of haptic technology.

In the previous report we presented an active tetrahedron and its control system. This time we report the development of the active icosahedron and its control system. While the active icosahedron design is based on the active tetrahedron system, there are two improvements between them.

One improvement is its control system. We have newly developed a control algorithm for the active link mechanism and applied it to the active icosahedron. The algorithm is based on approximate calculation focusing on triangular surfaces which the active links forms. One of the features of the active link mechanisms is that all surfaces consisting of active links are triangular. Each triangular plane is determined by the lengths of three active links composing it. Therefore, the active polyhedron settles into shape uniquely. The program we newly developed can decide the shape of the

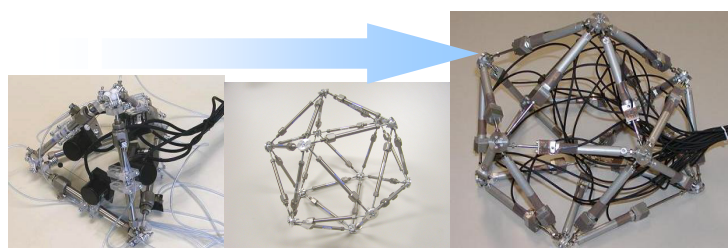

Figure 1 Active link mechanism family
Active tetrahedron (left), Active icosahedron (middle) and
Active icosahedron consisting intelligent cylinder (right)

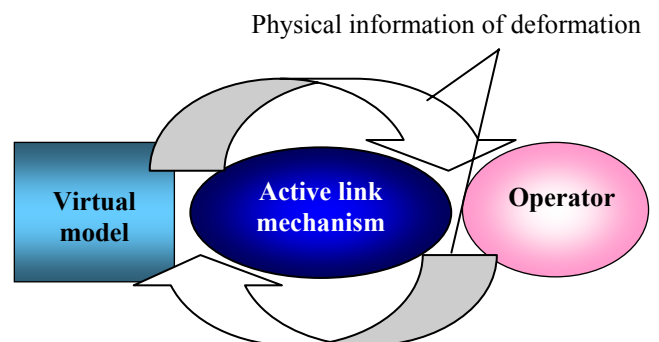

Figure 2 Concept of physical man-machine interaction (PMI) using
active link mechanism

polyhedron from length data of active links. It converts the length of each edge of the polyhedron to the position of polyhedron's apexes. This conversion makes the active polyhedron possible to work as a shape input interface to PC form the operator.

The other improvement is actuators composing an active polyhedron. The new developed actuators are intelligent pneumatic cylinders equipped with micro sensors. The intelligent pneumatic cylinder is specially developed to realize the active link mechanisms. Its purpose is to reduce the actuator size, and to improve detection ability of the length of cylinder and usability. These problems were found in the previous active tetrahedron, and using the intelligent cylinder improved these problems.

2. INTELLIGENT PNEUMATIC CYLINDER

2.1 Design of intelligent cylinder with built-in sensor

To build an active icosahedron system, compact servo actuators are essential. We have developed a new intelligent pneumatic cylinder, which has a linear optical encoder in its interior. Developed cylinder is shown in Figures 3 and 4. Its length is 135 mm in normal and the moving stroke is 40 mm. Main parts of the intelligent cylinder are a micro encoder, a cylinder rod and a housing fixing the sensor. Code stripes are



Figure 3. Intelligent cylinder and built-in sensor

inscribed in 0.6 mm pitch on the cylinder rod with laser

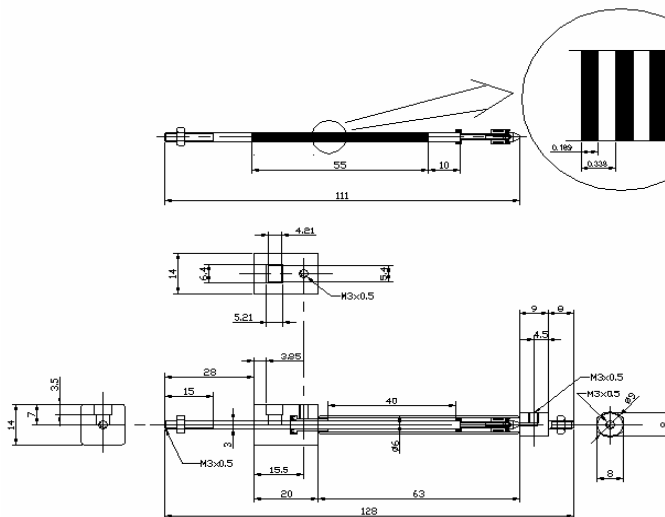

Figure 4. Design of intelligent cylinder

ablation so as to detect the cylinder motion with the encoder. The encoder housing is mounted on the end of the pneumatic cylinder.

Micro optical encoders shown in Figure 5 (left) were built into each pneumatic cylinder to realize analog control of pneumatic cylinder. It has a photodiode and a two-phase photo detector and is 5 by 6 mm in size. This sensor is so small that we can build it into the cylinder system. With illuminating light on the code stripe, the encoder detects the linear displacement and directions of the cylinder rod.

2.2 Control system of intelligent cylinder

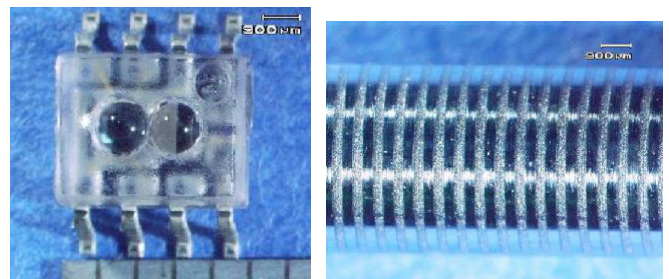

Figure 5. Micro encoder (left) and code stripe on the surface of cylinder rod (right)

The control system consists of a micro encoder, a generator of PWM (Pulse Width Modulation) pneumatic flow and a counter. Position control is achieved by a feedback loop with proportional control. The block diagram of this system is shown in Figure 6. Duty ratio D is calculated by e comparing the desired value X_d and the cylinder length X_c . Cylinder is driven by PWM generator based on the duty ratio D . Axial force F_c acting on cylinder rod is controlled by pressure P from compressor and duty ratio D .

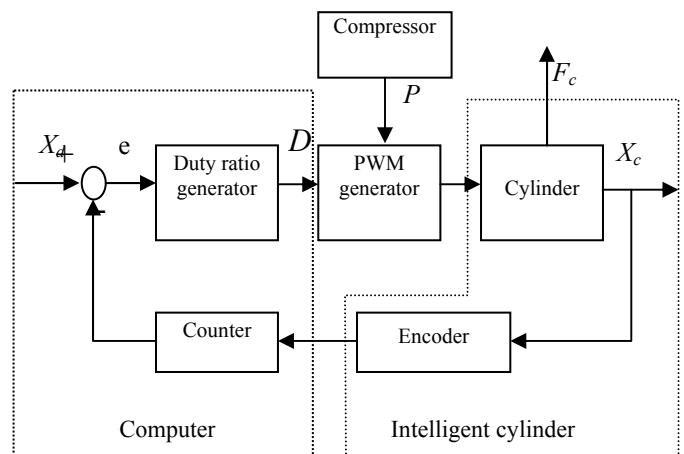

Figure 6. Control system of intelligent cylinder

3. ACTIVE ICOSAHEDRON CONSISTING OF INTELLIGENT CYLINDERS

2.1 Appearance of active icosahedron

We built an active icosahedron using the intelligent pneumatic cylinders. The active icosahedron is shown in Figure 12. It has thirty intelligent cylinders and twenty multi-DOF joints. Each cylinder is connected with the joints.

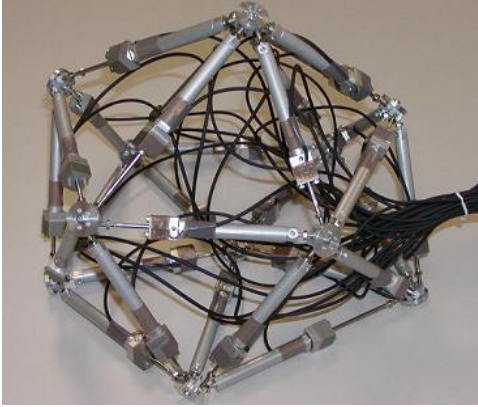

Figure 7. Active icosahedron composed of intelligent cylinders

2.2 Control system of active icosahedron

Control system of the active icosahedron is shown in Figure 8. An operator handles two inputs and one output. Two inputs signals are visual information from the display and physical information from the active icosahedron. The output is physical information given to the active icosahedron. The intelligent cylinders composing the active icosahedron detect its deformation. The length of cylinder is measured by a counter board in PC. The driver program acquires position information from the sensors mounted on the cylinders and controls the intelligent cylinder system in order to present physical information to an operator. At the same time, the program deforms also the shape of the virtual model in PC. OpenGL is used to visualize the virtual model on display. The virtual model follows the same shape as the active icosahedron, reflecting its real time motion of the operator.

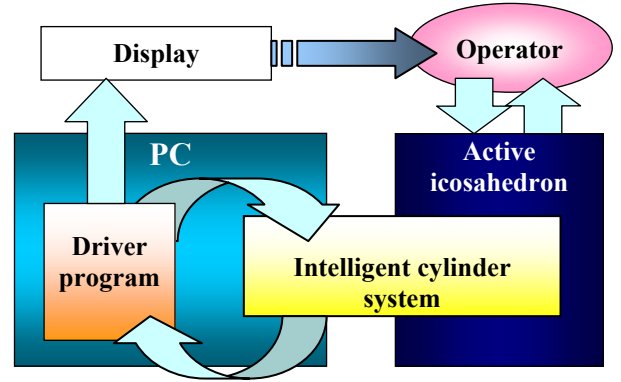

Figure 8. System of active icosahedron

2.3 Driver program

The virtual model in the driver program has arbitrary parameters of physical characteristics and is able to simulate various objects. If an operator changed these parameters, the active polyhedron's characteristics changes in the same way as the virtual model's. Specific block diagram is shown in Figure 9. X_v represents a virtual position vector of virtual model's apexes. This vector is used when an active polyhedron is deformed by the driver program. X_o represents position vector of the apexes of the active icosahedron, which is obtained from position vector from X_c of the cylinder length. X_e is given from X_v minus X_o . Driving force acting on each the apex of the virtual model F_a is obtained by dynamic equation shown as follows:

$$F_a = (M_v s^2 + D_v s + K_v) X_e \quad (1)$$

where M_v , D_v and K_v represent math, viscosity and elasticity of the virtual model, respectively. Those values can be given arbitrarily to realize desired mechanical characteristics of the model. F_p is obtained as F_a plus F_v , which means virtual force. F_d is obtained by converting F_p to the cylinder base coordinate. F_q is F_d plus F_s that comes from force sensor. F_c is the axial force of the intelligent cylinder. This program enables the active polyhedron to realize physical interaction in real time without time lag.

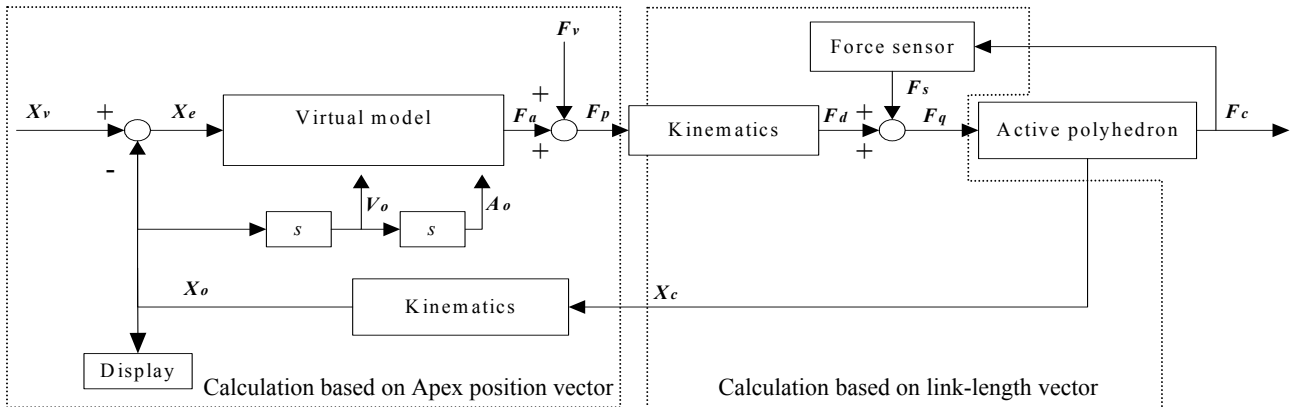

Figure 9. Block diagram of driver program

4. KINEMATICS IN THE ACTIVE POLYHEDRON SYSTEM

The essential role of the driver program is computing kinematics. Active polyhedron system has two kinds of vector. One is a vector belonging to link-length, and the other is a vector belonging to apex position of a virtual model and an active polyhedron. The vectors belonging to link-length are X_c and F_c . The vectors belonging to apex position are X_o and F_p .

Kinematic analysis of the active link mechanism needs a simple algorithm fast enough to perform real time simulation and imaging.

But it is generally difficult to solve inverse kinematics of a parallel link mechanism simply on geometric analysis. We developed a numerical calculation algorithm for active link mechanism to solve its kinematics, which uses four operations so that PC enables to keep high speed process.

As the first step, we focus on the input process from man to PC and a main discussion in this report is to formulate the algorithm determining the shape of the link mechanism from the cylinder length.

All surfaces of the active link mechanism are triangles. PC has a mathematical model of the active polyhedron. The form of an active polyhedron is uniquely decided by reason that all planes composing a polyhedron are triangle. Thus shape of all surfaces is determined from lengths of the cylinders.

As a matter convenience, the process to determine the shape of polyhedron is explained with focus on one triangle plane composing an active polyhedron. One triangle is shown in Figure 10. P_1 , P_2 and P_3 represent position vector of each triangle apex, while A, B and C are side of triangle

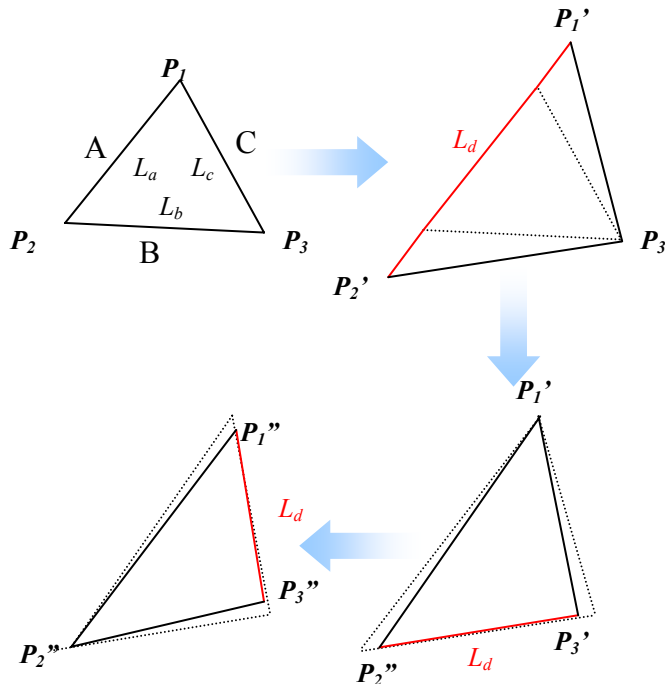

Figure 10. Calculation position of triangle composing active polyhedron with dependent on input length

respectively. These vectors are default. L is current length of side A.

The positions of the triangle apexes calculated from the length of cylinder are obtained follows;

$$P_n' = P_n + \frac{(P_n - P_{n+1})(L_d - L)}{2L} \quad (2)$$

$$P_{n+1}' = P_{n+1} + \frac{(P_{n+1} - P_n)(L_d - L)}{2L} \quad (3)$$

$$e = |L_d - L| \quad (4)$$

where L_d is the length of the cylinder and desired value to obtain position of apexes. L is a current length of the triangle. P_n is a position vector, where n is 1, 2 and 3. P_n' is a next position vector. e is a absolute value of L_d minus L . e is an error of convergent. These equations are obtained focusing on one side.

At the first step, focusing on side A in Figure 10, L_a is the length of side A and is obtained from P_2 and P_1 . Given alteration of cylinder length A is only detected, current length L_a needs to be same as desired length L_d . Vectors P_1 and P_2 are updated to P_1' and P_2' by adding a half value of the difference between L_d and L as shown in Equations (2) to (4). During this process L_b is kept constant. At the second step, focusing on the side B, the desired value L_d is the same as the length of L_b because the side B is not changed. P_2' and P_3' is determined by the equation (2) and (3). At the third step, in the same manner P_3' and P_1'' are updated by the equation (2) and (3). Iteration of these procedures results in the right position vectors of the apex of virtual model. Estimation of convergence is evaluated by summation of e in one time procedures.

The shape of the active polyhedron is determined by applying this algorithm to its all plane. Physical information is calculated based on position vectors of the apexes of active polyhedron. Each apex of the current system has the same parameters. Force vector is given by equation (1). Output forces are resolved to the vectors of each cylinder which is around apex.

5. TEST OF THE DRIVER PROGRAM

We tested the active icosahedron to make sure that it realizes real-time PMI. We attempt to use it as an input interface to modify the shape of the virtual model as the first trial of the driver program. The aim of the experiment is to confirm the convergence speed of the driver program, especially to confirm time lag to enable to draw the virtual model on display. If there is time lag between drawing and actual motion of the icosahedron, it makes operability worse.

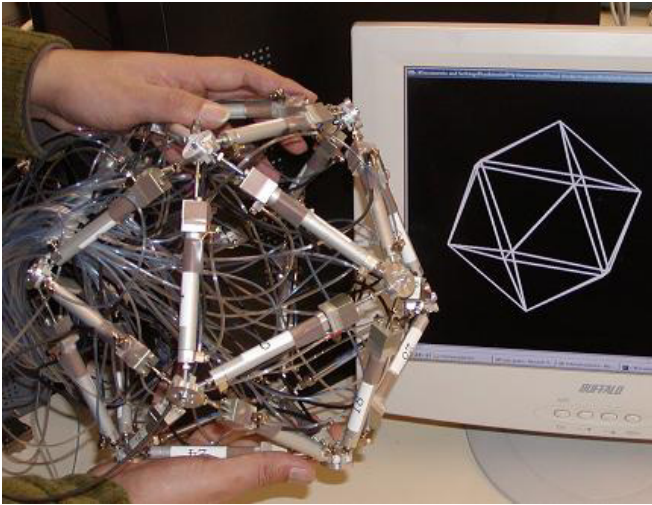

Figure 11. Test of input from active icosahedron

The appearance of experimental setup is shown as Figure 11. Deforming the active icosahedron, we demonstrated to confirm performance of the driver program. The active icosahedron worked correctly to deform the virtual model. The driver program made the virtual model converge promptly. Convergence speed is fast enough to calculate kinematics of active polyhedron.

6. APPLYING ACTIVE ICOSAHEDRON TO VIRTUAL CLAY

6.1 Virtual Clay

There are two ways to utilize the haptic interface in the case of presenting virtual models. One is to present virtual models via a haptic interface as a pointing device. An operator can feel the virtual objects by using a haptic interface. Most of concentration types of haptic interface are used in this manner. In the other haptic interfaces form a virtual model, haptic interfaces used in this manner are classified into distribution type probably. A point is which ways are suitable for the active polyhedrons. We think that current active polyhedron is better suited for latter way. Thus we applied the active icosahedron to virtual clay.

The virtual clay is currently composed of triangle surfaces. The number of triangles is 1280. The virtual clay is an expanded icosahedron model. Apexes of regular icosahedron are on a sphere shell. All triangle surfaces are divided into 4 regular triangle parts and new coming apexes are arranged on proximity sphere shell. The virtual clay comes to have 1280 faces by repeating the procedure. The current virtual clay model is based on plastic deformation with viscosity. We have not identified actual physical parameters of clay yet, thus the virtual clay might have physical parameters real clay.

6.2 Applying the Active Icosahedron to Virtual Clay

PMI with a virtual clay is shown in Figure 12. This figure shows an experiment of the virtual clay deformed by an operator. The active icosahedron system makes it possible for an operator to deform the virtual clay as confirming its shape on display. But the active icosahedron is not enough to complete freely deform the virtual mode due to a lack of input point.

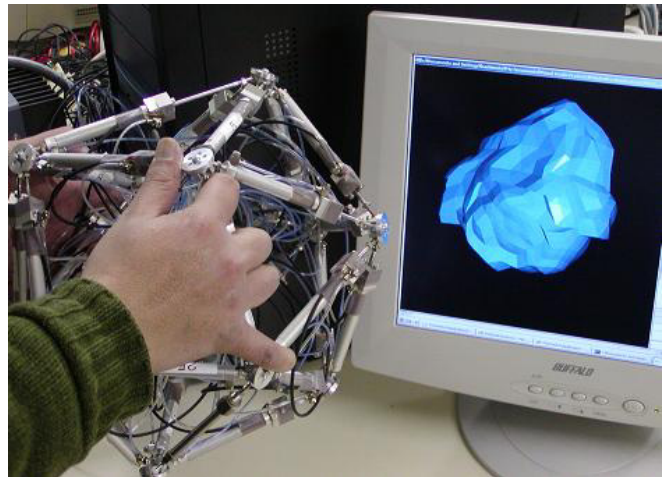

Figure 12. PMI with virtual clay

6.3 Virtual Clay using micro gyro gyroscopes

Mounting micro gyroscopes has two aims, one is to augment the input points, the other is to change view point by turning the active link mechanism. Figure 13 shows an experiment of deforming of a virtual clay using the icosahedron with a uniaxial gyroscope. An operator can switch operating modes: an input point augmenting mode and turning view point mode. Thus the operator can deform a virtual clay more dexterously with active icosahedron with a gyro.

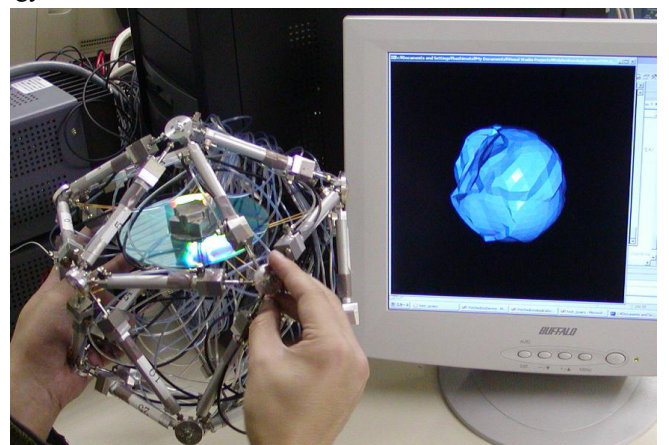

Figure 13. Virtual clay using uniaxial gyro

7. CONCLUSION

We developed a new haptic device consisting of active link mechanisms and applied it to physical man-machine interaction to prove potential of this device.

- An intelligent pneumatic cylinder was newly developed for the active icosahedron. The cylinder had a micro optical encoder in its inside and realized a servo mechanism very easily with a simple and compact mechanism. This cylinder was an essential actuator for the active icosahedron.
- The driver program for the active icosahedron was developed. The program had a virtual model in it and controlled the active icosahedron and the virtual model to work them in the same way. Changing physical parameters of the virtual model made operators feel the change of mechanical properties such as shape, viscosity and stiffness.
- Applying the active icosahedron to virtual clay showed that the system works successfully and the operator felt as if he/she touched the virtual clay.

- A micro gyroscope mounted on the active icosahedron realized a rotary input. Using micro gyroscopes enable the active polyhedron to handle dynamic deformation of the virtual clay.

ACKNOWLEDGEMENT

This research was supported by Grant-in Aid for Scientific Research on Priority Areas (c) (2) (13224071 and 14019068) from the Ministry of Education, Culture, Sports, Science and Technology in Japan.

REFERENCES

- [1] J. Ochi, T. Hashimoto, K. Suzumori and T. Kanda, "Active Link Mechanism for Physical Man-machine Interaction," Proceedings of the 2003 International Symposium on Micromechatronics and Human Science, Japan, pp.147-152, 2003.