

Dynamic Model and Control of a New Quadrotor Unmanned Aerial Vehicle with Tilt-Wing Mechanism

Kaan T. Oner, Ertugrul Cetinsoy, Mustafa Unel, Mahmut F. Aksit, Ilyas Kandemir, Kayhan Gulez

Abstract— In this work a dynamic model of a new quadrotor aerial vehicle that is equipped with a tilt-wing mechanism is presented. The vehicle has the capabilities of vertical take-off/landing (VTOL) like a helicopter and flying horizontal like an airplane. Dynamic model of the vehicle is derived both for vertical and horizontal flight modes using Newton-Euler formulation. An LQR controller for the vertical flight mode has also been developed and its performance has been tested with several simulations.

Keywords— Control, Dynamic model, LQR, Quadrotor, Tilt-wing, VTOL.

I. INTRODUCTION

Unmanned aerial vehicles (UAV) designed for various missions such as surveillance and exploration of disasters (fire, earthquake, flood, etc...) have been the subject of a growing research interest in the last decade. Among these aerial vehicles, airplanes with long flight ranges and helicopters with hovering capabilities are the major mobile platforms used in researches by many groups. Besides these commonly used aerial vehicles, the tilt-rotor aerial vehicles combining the advantages of horizontal and vertical flight have been gaining popularity recently. Because these new vehicles have no conventional design basis, many research groups build their own tilt-rotor vehicles according to their desired technical properties and objectives. Some examples to these tilt-rotor vehicles are large scaled commercial aircrafts like Boeing's V22 Osprey [1], Bell's Eagle Eye [2] and smaller scale vehicles like Arizona State University's HARVee [3] and Compigne University's BIROTAN [4] which consist of two rotors. Examples to other tilt-rotor vehicles with quad-rotor configurations are Boeing's V44 [5] (an ongoing project for the quad-rotor version of V22) and Chiba University's QTW UAV [6] which is a completed project.

Different controllers designed for the VTOL vehicles with quad-rotor configurations exist in the literature. Cranfield University's LQR controller [7], Swiss Federal Institute of Technology's PID and LQ controllers [8] and Lakehead University's PD² [9] controller are examples to the controller

developed on quad-rotors linearized dynamic models. Among some other control methods of quad-rotor vehicles are CNRS and Grenoble University's Global Stabilization [10], Swiss Federal Institute of Technology's Full Control of a Quadrotor [11] and Versailles Engineering Laboratory's Backstepping Control [12] that take into account the nonlinear dynamics of the vehicles.

This paper reports the current work on the modeling and position control of a new tilt-wing aerial vehicle (SUAVi: Sabanci University Unmanned Aerial Vehicle) that is capable of flying in horizontal and vertical modes. The vehicle consists of four rotating wings and four rotors, which are mounted on leading edges of each wing. This 1 m long and 1 m wide aerial vehicle is one of the first of its kind among tilt-wing vehicles on that scale range. The predicted flight times for this vehicle are 20 minutes for vertical flight in hover mode and 1.5 – 2 hours for horizontal flight at 40 – 70 km/h flight speeds.

The organization of this paper is as follows: in Section II the dynamic models for the vertical and the horizontal flight modes of the vehicle are obtained using Newton-Euler formulation. In Section III a position controller is developed for position control of the vehicle in vertical flight mode using LQR approach. Simulation results and conclusions are provided in Section IV and Section V, respectively.

II. DYNAMIC MODEL OF THE VEHICLE

The vehicle is equipped with four wings that are mounted on the front and at the back of the vehicle and can be rotated from vertical to horizontal positions. Fig. 1 below shows the aerial vehicle in horizontal and vertical flight modes.

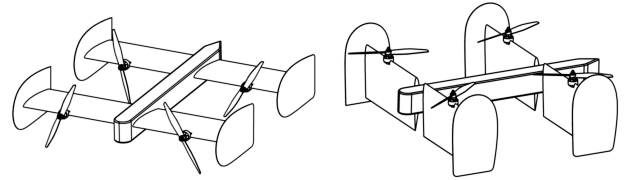

Fig. 1. Aerial Vehicle in Horizontal and Vertical Flight Modes

With this wing configuration, the vehicle's airframe transforms into a quad-rotor like structure if the wings are at the vertical position and into an airplane like structure if the wings are at the horizontal position. To keep the control complexity on a minimum level, the rotations of the wings are used as

K.T. Oner, E. Cetinsoy, M. Unel and M. F. Aksit are with Sabanci University, Orhanli-Tuzla, 34956, Istanbul TURKEY (corresponding author: munel@sabanciuniv.edu)

I. Kandemir is with Engineering Faculty, Gebze Institute of Technology (GYTE), Cayirova-Gebze, 41400, Kocaeli TURKEY. (e-mail: kandemir@gyte.edu.tr)

K. Gulez is with the Department of Electrical Engineering, Yildiz Technical University (YTU), Barbaros Bulvari-Yildiz, 34349, Istanbul, TURKEY (e-mail: gulez@yildiz.edu.tr)

attitude control inputs in addition to motor thrust inputs of the vehicle in horizontal flight mode. Therefore the need of additional control surfaces that are put on trailing edges of the wings on a regular airplane are eliminated. Two wings on the front can be rotated independently to act like the ailerons while two wings at the back are rotated together to act like the elevator. This way the control surfaces of a regular plane in horizontal flight mode are mimicked with minimum number of actuators.

A. Vertical Flight Mode

In vertical flight mode, the mechanical structure of the vehicle is very similar to a quad-rotor vehicle and the dynamics of the vehicle can be approximated by the model given below:

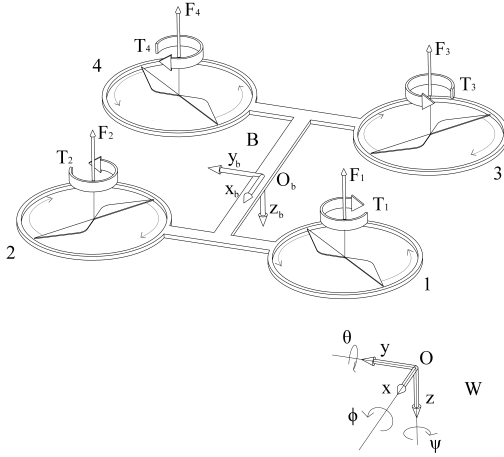

Fig. 2. Aerial Vehicle in Vertical Flight Configuration

The two reference frames given in Fig. 2 are body fixed reference frame $B : (O_b, x_b, y_b, z_b)$ and earth fixed inertial reference frame $W : (O, x, y, z)$. Using this model, the equations describing the position and attitude of the vehicle are obtained by relating the 6 DOF kinematic equations with the dynamic equations. The position and linear velocity of the vehicle's center of mass in world frame are described as,

$$P = \begin{bmatrix} x \\ y \\ z \end{bmatrix}, V = \dot{P} = \begin{bmatrix} \dot{x} \\ \dot{y} \\ \dot{z} \end{bmatrix}$$

The attitude and angular velocity of the vehicle in world frame are given as,

$$\alpha = \begin{bmatrix} \phi \\ \theta \\ \psi \end{bmatrix}, \omega = \dot{\alpha} = \begin{bmatrix} \dot{\phi} \\ \dot{\theta} \\ \dot{\psi} \end{bmatrix}$$

where, ϕ , θ , ψ are named roll, pitch and yaw angles respectively. The equations for the transformation of the angular and linear velocities between world and body frames are given in equations (1) and (2):

$$V_b = \begin{bmatrix} u \\ v \\ w \end{bmatrix} = T_{bw}(\phi, \theta, \psi) \cdot V \quad (1)$$

where

$$T_{bw}(\phi, \theta, \psi) = R_x(\phi)R_y(\theta)R_z(\psi)$$

$$\omega_b = \begin{bmatrix} p \\ q \\ r \end{bmatrix} = E(\phi, \theta) \cdot \omega \quad (2)$$

where

$$E(\phi, \theta) \cdot \omega = \begin{bmatrix} 1 & 0 & -\sin(\theta) \\ 0 & \cos(\theta) & \sin(\phi)\cos(\theta) \\ 0 & -\sin(\theta) & \cos(\phi)\cos(\theta) \end{bmatrix}$$

In this underactuated system, besides creating the lift forces, counterclockwise rotating propellers 1 and 4 create torques (T_1 and T_4) in clockwise direction whereas clockwise rotating propellers 2 and 3 create torques (T_2 and T_3) in counterclockwise direction (Fig. 2). That way the attitude of the vehicle is preserved if equal lifting forces are created by each rotor. The vehicle will move along x axis, if the pitch angle of the vehicle is changed either by reducing the lift forces created by rotors 1 and 2 or increasing the lift forces created by rotors 3 and 4 by the same amount. The vehicle will move along y axis, if the roll angle of the vehicle is changed either by reducing the lift forces created by rotors 2 and 4 or increasing the lift forces created by rotors 1 and 3 by the same amount. The yaw angle of the vehicle is controlled by trading lift forces from counterclockwise rotating propellers to clockwise rotating propellers or vice versa. The dynamic equations for the forces and torques acting on the vehicle's center of gravity are given in equations (3) and (4):

$$F_{tot}^v = M_b \dot{V}_b + \omega_b \times (M_b \cdot V_b) \quad (3)$$

where

$$M_b = \begin{bmatrix} m & 0 & 0 \\ 0 & m & 0 \\ 0 & 0 & m \end{bmatrix}$$

$$M_{tot}^v = I_n \dot{\omega}_b + \omega_b \times (I_n \cdot \omega_b) \quad (4)$$

where

$$I_n = \begin{bmatrix} I_u & 0 & 0 \\ 0 & I_v & 0 \\ 0 & 0 & I_w \end{bmatrix}$$

I_u , I_v and I_w are moment of inertias in the body reference frame. The total force F_{tot}^v acting on the vehicle's center of gravity is the sum of the lifting forces F_{cg}^v created by the rotors, the gravity F_g and the aerodynamic forces F_a^v which is considered as a disturbance, namely

$$F_{tot}^v = F_{cg}^v + F_g + F_a^v \quad (5)$$

where

$$F_{cg}^v = \begin{bmatrix} F_x^v \\ F_y^v \\ F_z^v \end{bmatrix} = \begin{bmatrix} 0 \\ 0 \\ -(F_1 + F_2 + F_3 + F_4) \end{bmatrix}$$

$$F_g = \begin{bmatrix} -\sin(\theta) \\ \sin(\phi)\cos(\theta) \\ \cos(\phi)\cos(\theta) \end{bmatrix} \cdot mg$$

The total torque M_{tot}^v acting on the vehicle's center of gravity (cog) is the sum of the torques M_{cg}^v created by the rotors and the aerodynamic torques M_a^v which is again considered as a disturbance, namely

$$M_{tot}^v = M_{cg}^v + F_a^v \quad (6)$$

where

$$M_{cg}^v = \begin{bmatrix} M_x^v \\ M_y^v \\ M_z^v \end{bmatrix} = \begin{bmatrix} l_s & -l_s & l_s & -l_s \\ l_l & l_l & -l_l & -l_l \\ \lambda_1 & \lambda_2 & \lambda_3 & \lambda_4 \end{bmatrix} \begin{bmatrix} F_1 \\ F_2 \\ F_3 \\ F_4 \end{bmatrix}$$

l_l and l_s are the distances of rotors to the center of gravity of the vehicle in x and y directions. Note also that $T_i = \lambda_i F_i$ for $i = 1, 2, 3, 4$ and sum of torques created by the rotors result in a yaw moment along the z axis in vertical flight mode:

$$M_z^v = \sum_i T_i$$

The parameters of the vehicle used in dynamic modeling are given in Table I below.

TABLE I
MODELING PARAMETERS

Symbol	Description	Dimension/Magnitude
m	mass	4 kg
l_s	rotor distance to cog along y axis	0.25 m
l_l	rotor distance to cog along x axis	0.25 m
I_u	moment of inertia	0.195 kgm^2
I_v	moment of inertia	0.135 kgm^2
I_w	moment of inertia	0.135 kgm^2
$\lambda_{1,4}$	torque/force ratio	0.01 Nm/N
$\lambda_{2,3}$	torque/force ratio	-0.01 Nm/N

B. Horizontal Flight Mode

In horizontal flight mode, the mechanical structure of the aerial vehicle forms the airframe of a four winged airplane with two wings on the front and two wings at the back. The aerodynamic lift and drag forces that are considered as external disturbance in vertical flight mode need to be taken into account in dynamic modeling for horizontal flight. Fig. 3 shows the aerial vehicle in horizontal flight mode. The lift forces F_L^i and drag forces F_D^i for $i = 1, 2, 3, 4$ generated by each wing are obtained from the equations:

$$F_L^i = -\frac{1}{2} c_L(\theta_i) \rho A \cdot V^2 \quad (7)$$

$$F_D^i = -\frac{1}{2} c_D(\theta_i) \rho A \cdot V^2 \quad (8)$$

where the angle of attack for each wing is given by θ_i . Because the wings at the back are rotated together their angle of attacks are the same for all time ($\theta_3 = \theta_4$). Note that the lift coefficient $c_L(\theta_i)$ and the drag coefficient $c_D(\theta_i)$ are not constant variables, but functions of angle of attack θ_i for each wing. The total force F_{tot}^h acting on the vehicle's center of gravity is the sum of the forces F_{cg}^h created by the rotors, the gravity F_g , the lift and drag forces generated by the wings

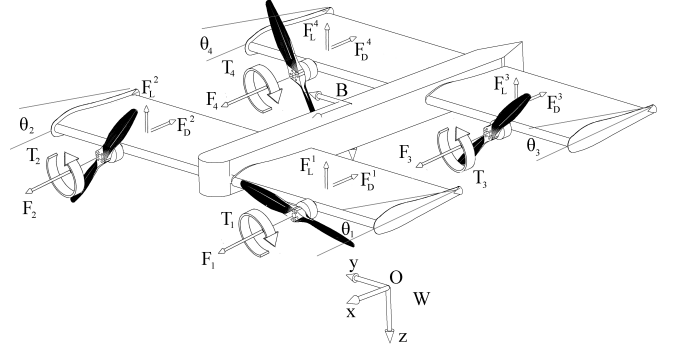

Fig. 3. Aerial Vehicle in Horizontal Flight Configuration

F_w and the aerodynamic forces F_a^h which is considered as a disturbance, namely

$$F_{tot}^h = F_{cg}^h + F_g + F_w + F_a^h \quad (9)$$

where

$$F_{cg}^h = \begin{bmatrix} F_x^h \\ F_y^h \\ F_z^h \end{bmatrix} = \begin{bmatrix} F_1 + F_2 + F_3 + F_4 \\ 0 \\ 0 \end{bmatrix} \quad (10)$$

$$F_w = \sum_i F_L^i + \sum_i F_D^i = \begin{bmatrix} -(c_D(\theta_1) + c_D(\theta_2) + 2c_D(\theta_3)) \frac{\rho A}{2} V^2 \\ 0 \\ -(c_L(\theta_1) + c_L(\theta_2) + 2c_L(\theta_3)) \frac{\rho A}{2} V^2 \end{bmatrix} \quad (11)$$

The total torque M_{tot}^h acting on the vehicle's center of gravity is the sum of the torques M_{cg}^h created by the rotors, M_w created by the drag/lift forces of the wings and the aerodynamic torques M_a^h which is again considered as a disturbance, namely

$$M_{tot}^h = M_{cg}^h + M_w + M_a^h \quad (12)$$

where

$$M_{cg}^h = \begin{bmatrix} M_x^h \\ M_y^h \\ M_z^h \end{bmatrix} = \begin{bmatrix} -\lambda_1 & -\lambda_2 & -\lambda_3 & -\lambda_4 \\ 0 & 0 & 0 & 0 \\ l_s & -l_s & l_s & -l_s \end{bmatrix} \begin{bmatrix} F_1 \\ F_2 \\ F_3 \\ F_4 \end{bmatrix} \quad (13)$$

$$M_w = \begin{bmatrix} -(c_L(\theta_1) - c_L(\theta_2)) \frac{\rho A}{2} V^2 l_s \\ -(c_L(\theta_1) + c_L(\theta_2) - 2c_L(\theta_3)) \frac{\rho A}{2} V^2 l_l \\ -(-c_D(\theta_1) + c_D(\theta_2)) \frac{\rho A}{2} V^2 l_s \end{bmatrix} \quad (14)$$

Note that the sum of torques created by the rotors result in a roll moment along the x axis in horizontal flight mode:

$$M_x^h = \sum_i T_i$$

The dynamic equations obtained for 6 DOF rigid body transformation of the aerial vehicle in inertial reference frame W are also valid for the dynamic model in horizontal flight mode:

$$F_{tot}^h = M_b \dot{V}_b + \omega_b \times (M_b \cdot V_b) \quad (15)$$

$$M_{tot}^h = I_n \dot{\omega}_b + \omega_b \times (I_n \cdot \omega_b) \quad (16)$$

III. LQR CONTROLLER DESIGN

To design a position controller for vertical flight mode of the UAV, first the equations obtained in Section III.A are put into state-space form. The state vector X consists of the position (P), the attitude (α), the linear velocity (V_b) and the angular velocity (ω_b):

$$X = \begin{bmatrix} P \\ V_b \\ \omega_b \\ \alpha \end{bmatrix} \quad (17)$$

In light of equations (1)-(6) the following equation is obtained:

$$\dot{X} = \begin{bmatrix} \dot{P}_e \\ \dot{V}_b \\ \dot{\omega}_b \\ \dot{\alpha} \end{bmatrix} = \begin{bmatrix} T_{be}^{-1}(\alpha_e) \cdot V_b \\ M_b^{-1} \cdot [F_{tot}^v - \omega_b \times (M_b \cdot V_b)] \\ I_n^{-1} \cdot [M_{tot}^v - \omega_b \times (I_n \cdot \omega_b)] \\ E^{-1}(\alpha_e) \cdot \omega_b \end{bmatrix} \quad (18)$$

which is a nonlinear plant of the form

$$\dot{X} = f(X, u) \quad (19)$$

Although the state vector contains 12 variables, the aerial vehicle is an underactuated system with 4 DOF. Therefore the control parameters of the plant are chosen to be the position $P(x, y, z)$ and yaw angle (ψ). In order to simplify the controller design, the actuating forces and torques are decomposed into four virtual control inputs (u_i) as follows:

$$u = \begin{bmatrix} u_1 \\ u_2 \\ u_3 \\ u_4 \end{bmatrix} \begin{bmatrix} -(F_1 + F_2 + F_3 + F_4) \\ l_s \cdot [(F_1 + F_3) - (F_2 + F_4)] \\ l_l \cdot [(F_1 + F_2) - (F_3 + F_4)] \\ \lambda_1 F_1 + \lambda_2 F_2 + \lambda_3 F_3 + \lambda_4 F_4 \end{bmatrix} \quad (20)$$

For LQR controller design, the dynamic equations of the vehicle are linearized around some nominal operating condition point, e.g. hovering condition. A , B and C matrices of the linearized system are computed as follows:

$$A = \begin{bmatrix} \frac{\partial f_1(X, u)}{\partial X_1|_{x=x_n}} & \dots & \frac{\partial f_1(X, u)}{\partial X_{12}|_{x=x_n}} \\ \vdots & \ddots & \vdots \\ \frac{\partial f_{12}(X, u)}{\partial X_1|_{x=x_n}} & \dots & \frac{\partial f_{12}(X, u)}{\partial X_{12}|_{x=x_n}} \end{bmatrix}$$

$$B = \begin{bmatrix} \frac{\partial f_1(X, u)}{\partial u_1|_{u=u_n}} & \dots & \frac{\partial f_1(X, u)}{\partial u_4|_{u=u_n}} \\ \vdots & \ddots & \vdots \\ \frac{\partial f_{12}(X, u)}{\partial u_1|_{u=u_n}} & \dots & \frac{\partial f_{12}(X, u)}{\partial u_4|_{u=u_n}} \end{bmatrix}$$

$$C = I$$

where I is 12×12 identity matrix.

A controller in the form:

$$u(t) = -K(X(t) - X_{ref}) \quad (21)$$

is selected to stabilize the system, where X_{ref} is the reference state. The feedback gain matrix K is found by minimizing the following cost function

$$J = \int_0^{\infty} [(X(t) - X_{ref})^T Q (X(t) - X_{ref}) + u(t)^T R u(t)] dt \quad (22)$$

where Q and R are semi-positive and positive definite weighting matrices of the state and control variables respectively.

IV. SIMULATION RESULTS

The performance of the LQR controller is evaluated on the nonlinear dynamic model of the vehicle given by (18) in MATLAB/Simulink. Q and R matrices used in LQR design are selected as:

$$Q = 10^{-1} \cdot I$$

$$R = \begin{bmatrix} 10^{-1} & 0 & 0 & 0 \\ 0 & 10 & 0 & 0 \\ 0 & 0 & 10 & 0 \\ 0 & 0 & 0 & 10 \end{bmatrix}$$

where I is the 12×12 identity matrix.

Starting with the initial position $P_i = (0, 0, -10)^T$ and initial attitude $\alpha_i = (0, 0, 0)^T$ of the vehicle, the simulation results given in Fig. 4 and Fig. 5 show the variation of the position and attitude state variables for the reference inputs $P_r = (3, 3, -15)^T$ and $\psi_r = 0$ under ideal operating conditions without any external disturbance.

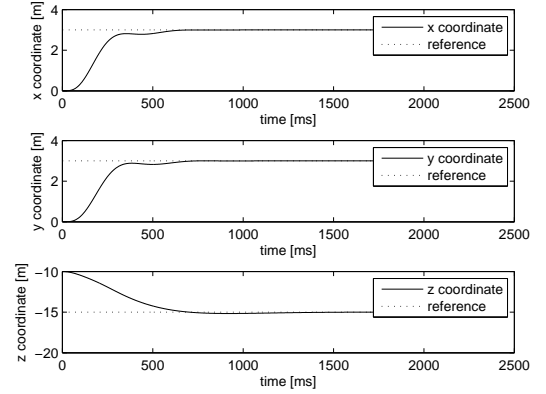

Fig. 4. Position control of the vehicle under no disturbance condition

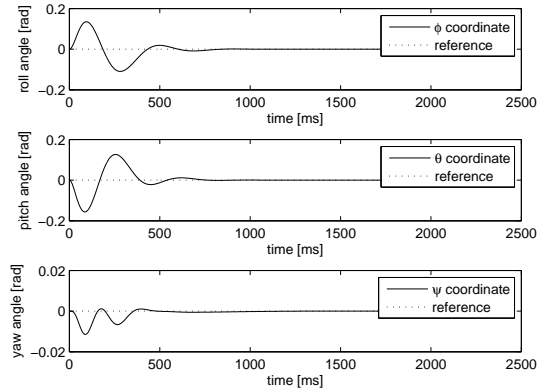

Fig. 5. Attitude control of the vehicle under no disturbance condition

Note that position and angle references are tracked with negligible steady state errors. The lift forces generated by each rotor are shown in Fig. 6. The control effort is small and the

magnitude of the forces that need to be generated don't exceed the physical limits (≈ 12 N) of the rotors and remain in the $\pm 20\%$ margin of nominal thrust.

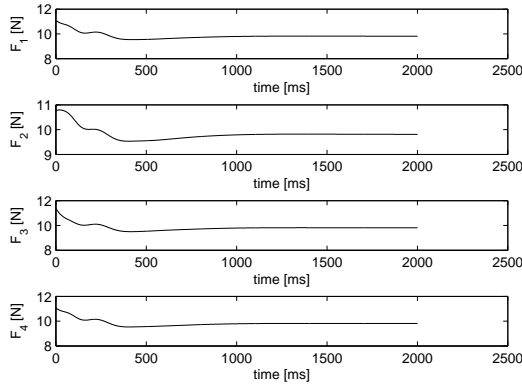

Fig. 6. Forces generated by the motors

The robustness of the LQR controller is evaluated by repeating the simulation with the same initial conditions and references after adding the aerodynamic disturbance force F_a^v and disturbance torque M_a^v to the model. These disturbances are modeled with Gaussian random variables of zero mean and 0.01 variance that represent small airstreams and winds. Fig. (7) and (8) show the variation of the position and attitude variables under these disturbance conditions. Notice that the system is again stabilized with the same controller and the position errors due to the disturbance are approximately on the order of 0.1 m, whereas the attitude errors are approximately on the order of 2.5 degrees. The lift forces generated by each rotor are shown in Fig. 9. Fig. 10 shows the tracking performance of the controller for a rectangle and circle shaped trajectory reference while maintaining $\psi_r=0$ yaw angle reference under disturbance conditions. Note that good tracking performance is obtained using the LQR controller with the same parameters. The lift forces generated by each rotor are shown in Fig. 11.

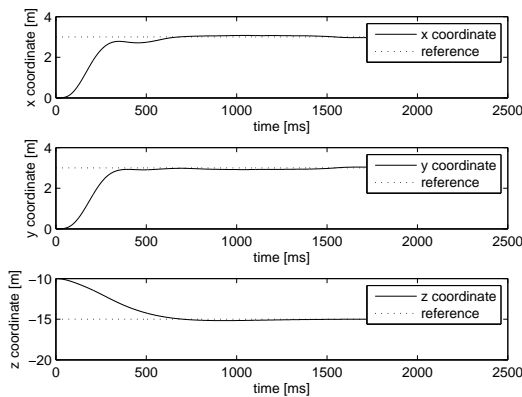

Fig. 7. Position control of the vehicle under disturbance condition

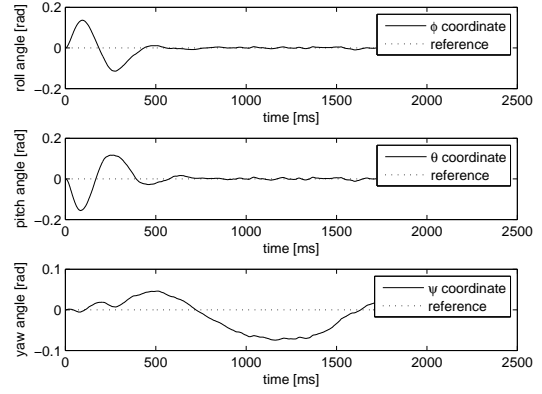

Fig. 8. Attitude control of the vehicle under disturbance condition

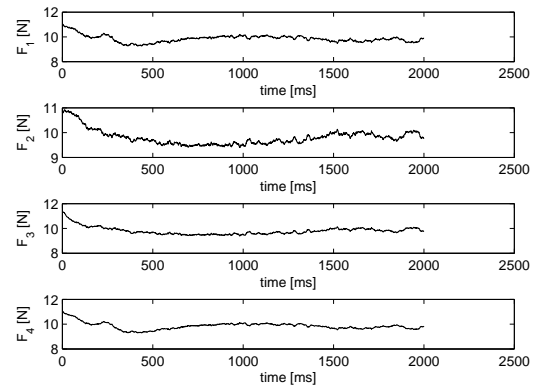

Fig. 9. Forces generated by the motors under disturbance condition

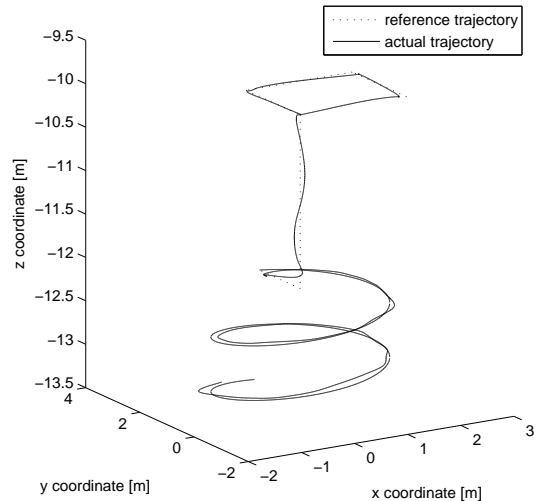

Fig. 10. Rectangle and circle shaped reference tracking under disturbance condition

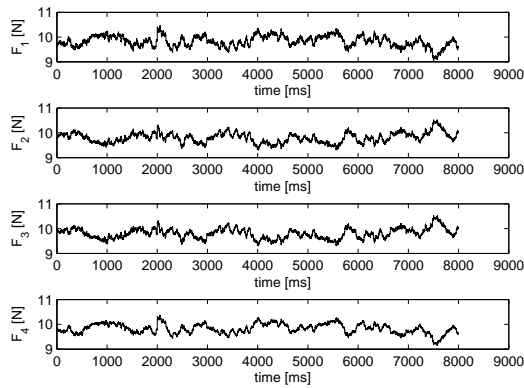

Fig. 11. Forces generated by the motors for the rectangle and circle shaped reference trajectory under disturbance condition

V. CONCLUSION AND FUTURE WORKS

In this paper the current work on modeling and position control of a new tilt-wing aerial vehicle (SUAVi) is reported. The dynamic models of the vehicle are obtained for vertical and horizontal flight modes and an LQR based position control algorithm is developed and applied to the nonlinear dynamic model of the vehicle in vertical flight mode. Results are verified with simulations in Matlab/Simulink. A good position tracking performance is obtained using this controller. Future work will include improvements on the dynamic model and design of a unified position controller for vertical and horizontal flight modes. The ongoing construction of the vehicle will be completed and the experiments will be performed on the actual vehicle.

ACKNOWLEDGMENTS

Authors would like to acknowledge the support provided by TUBITAK under grant 107M179.

REFERENCES

- [1] Boeing, V-22 Osprey, (2008, September 13). Available: <http://www.boeing.com/rotorcraft/military/v22/index.htm>
- [2] The Bell Eagle Eye UAS, (2008, September 13). Available: <http://www.bellhelicopter.com/en/aircraft/military/bellEagleEye.cfm>
- [3] J.J. Dickeson, D. Miles, O. Cifdalo, Wells, V.L. Rodriguez, A.A., "Robust LPV H Gain-Scheduled Hover-to-Cruise Conversion for a Tilt-Wing Rotorcraft in the Presence of CG Variations," *American Control Conference. ACC '07*, vol., no., pp.5266-5271, 9-13 July 2007
- [4] F. Kendoul, I. Fantoni, R. Lozano, "Modeling and control of a small autonomous aircraft having two tilting rotors," *Proceedings of the 44th IEEE Conference on Decision and Control, and the European Control Conference*, December 12-15, Seville, Spain, 2005
- [5] Snyder, D., "The Quad Tiltrotor: Its Beginning and Evolution," Proceedings of the 56th Annual Forum, *American Helicopter Society*, Virginia Beach, Virginia, May 2000.
- [6] K. Nonami, "Prospect and Recent Research & Development for Civil Use Autonomous Unmanned Aircraft as UAV and MAV," *Journal of System Design and Dynamics*, Vol.1, No.2, 2007
- [7] I. D. Cowling, O. A. Yakimenko, J. F. Whidborne and A. K. Cooke, "A Prototype of an Autonomous Controller for a Quadrotor UAV," *European Control Conference 2007 Kos*, 2-5 July, Kos, Greece, 2007.

- [8] S. Bouabdallah, A. Noth and R. Siegwart, "PID vs LQ Control Techniques Applied to an Indoor Micro Quadrotor," *Proc. of 2004 IEEE/RSJ Int. Conference on Intelligent Robots and Systems*, September 28 - October 2, Sendai, Japan, 2004.
- [9] A. Tayebi and S. McGilvray, "Attitude Stabilization of a Four-Rotor Aerial Robot" *43rd IEEE Conference on Decision and Control*, December 14-17 Atlantis, Paradise Island, Bahamas, 2004.
- [10] A. Hably and N. Marchand, "Global Stabilization of a Four Rotor Helicopter with Bounded Inputs", *Proc. of the 2007 IEEE/RSJ Int. Conference on Intelligent Robots and Systems*, Oct 29 - Nov 2, San Diego, CA, USA, 2007
- [11] S. Bouabdallah and R. Siegwart, "Full Control of a Quadrotor", *Proc. of the 2007 IEEE/RSJ Int. Conference on Intelligent Robots and Systems*, Oct 29 - Nov 2, San Diego, CA, USA, 2007.
- [12] Tarek Madani and Abdelaziz Benallegue, "Backstepping Control for a Quadrotor Helicopter", *Proc. of the 2006 IEEE/RSJ Int. Conference on Intelligent Robots and Systems*, October 9 - 15, Beijing, China, 2006.