

A NOVEL AP2 DOMAIN TRANSCRIPTION FACTOR FROM  
*Lycopersicon esculentum*, FUNCTIONS IN TOBACCO MOSAIC VIRUS  
PATHOGENESIS

by

BURCU DARTAN

Submitted to the Graduate School of Engineering and Natural Sciences  
in partial fulfillment of  
the requirements for the degree of  
Master of Science

Sabanci University

July 2004

A NOVEL AP2 DOMAIN TRANSCRIPTION FACTOR FROM  
*Lycopersicon esculentum*, FUNCTIONS IN TOBACCO MOSAIC VIRUS  
PATHOGENESIS

APPROVED BY:

Assoc. Prof. Zehra Sayers

.....

(Dissertation Supervisor)

Dr. Damla Bilgin

.....

(Co-Supervisor)

Prof. Meral Yücel

.....

Dr. Alpay Taralp

.....

Assistant Prof. Cengiz Yakıcıer

.....

DATE OF APPROVAL:

.....

© Burcu Dartan 2004

All Rights Reserved

## ABSTRACT

In this work, one of the established plant defense proteins namely that corresponding to the class EREBP-like transcription factors containing the AP2 domain was examined to identify a possible role in Tobacco Mosaic Virus Pathogenesis. In particular, a putative AP2-domain EREBP-like transcription factor –JERF1- from tomato cDNA was subcloned into various expression vectors in order to test for its potential role in virus response in *Solanaceae*. The gene silencing experiments, in which death was observed subsequent to silencing of the *JERF1* gene and TMV infection, have shown that this particular gene might be involved in the TMV infection cycle in *Solanaceae*. The results of a yeast mating assay conducted in this study has also implied that JERF1 is an interactor of plant P58<sup>IPK</sup>. This possibility would in turn suggests that JERF1 may be involved in plant-virus interaction. Overexpression, yeast-protein expression, and GFP-fusion constructs have also been prepared to support functional analyses of this putative transcription factor. It would follow to reason that this study of the recently sequenced JERF1 describes the first attempt to understand the function of this protein in plant-virus interaction.

## ÖZET

Bu çalışmada, EREB protein benzeri transkripsiyon faktörlerine karşılık gelen, AP2 alanına sahip olan ve bitki savunma proteinlerinden olan bir protein, Tütün Mozaik Virüsü (TMV) patojenesisindeki muhtemel rolünün tanımlanması için incelenmiştir. Özellikle, AP2 alanına sahip EREB protein benzeri bu transkripsiyon faktörü-JERF1-domates cDNA'sından klonlanmış ve virus duyarlılığında ya da dirençliliğinde rolünü bulabilmek için değişik vektörlere takılmıştır. *JERF1* geninin susturulduğu ve tütün mozaik virüsünün enfeksiyonunun yapıldığı gen susturulması deneyleri, bu genin *Solanacea* ailesinde TMV enfeksiyon döngüsünde görev aldığını gösterir. Maya çiftleştirme deneyleri de JERF1 proteininin bitki P58<sup>IPK</sup> proteini ile etkileştiğini göstermiştir ve bu JERF1'in bitki virus etkileşiminde yer alabileceğini belirtir. Ayrıca, bu transkripsiyon faktörünün fonksiyonel analizi için bu gen, overekspresyon, maya-protein ekspresyonu ve GFP-bileşik vektörlerine takılmıştır. Bu çalışma, yakın zamanda dizisi belirlenen JERF1 proteininin, bitki-virus etkileşimindeki işlevini tanımlamak için atılan ilk adımı oluşturmaktadır.

*To my family with all my heart,*

*Rest & be thankful in a world where nothing is random...*

## ACKNOWLEDGEMENTS

I am grateful to Prof. Dr. Zehra Sayers for her supervision and to Dr. Damla Bilgin for her endless support, advise and help throughout this study.

I also would like to express my appreciation to Dr. Alpay Taralp who has taught me how to think, analyze and criticize in the way paving through being a scientist. My special thanks go to Dr. Metin Bilgin who has given me new inspirations when I was stuck during my study. I also would like to thank to Dr. Fahriye Ertuğrul and Dr. Sedef Tunca who have taught me how to conduct a scientific experiment and helped me with my research.

My deepest appreciation goes to my parents Belgin and Besim Ömer Dartan, my aunts, my uncles, my cousins and my grandparents who have gifted me my life and personality.

Moreover I would like to thank to my sisters Didem Demirbaş, Funda Güngör, Gözde Vrana, Işın Nur Cicerali, Senem Tuğ and Tuğçe Güleryüz for their valuable friendship during my undergraduate and graduate education.

Thanks also go to my colleagues Çetin Baloğlu, H.Ümit Öztürk, Kıvanç Bilecen, Özgür Gül and Özgür Kütük for their help in this study.

I also would like to offer my sincere appreciation to my dearest SU GIRLS- Burcu Kaplan, Elanur Şireli, E. Süphan Bakkal, Filiz Dede and Yasemin Türkeli- for their encouragement and friendship throughout my study. Finally, I would like to express my intense gratitude to my friend A. Barış Karagözler without whom I would not bring about this thesis.

## TABLE OF CONTENTS

TABLE OF CONTENTS.....	viii
1 INTRODUCTION .....	1
2 OVERVIEW .....	2
2.1 Signal perception and transduction in plant defense responses.....	4
2.1.1 Resistance Genes and Resistance Protein Function .....	5
2.2 Resistant and Susceptible Host Responses.....	10
2.2.1 Similarities of PCD between Plants and Animals .....	13
2.2.2 Secondary Signaling Molecules in Plant Defense Responses .....	14
2.3 Viruses and Viral Pathogenicity .....	15
2.3.1 Host Defense Responses against Viruses .....	16
2.4 Transcription Factors .....	20
2.5 A novel AP2 domain TF from tomato.....	23
2.6 Aim of the study .....	23
3 MATERIALS AND METHODS .....	24
3.1 Materials .....	24
3.1.1 Chemicals .....	24
3.1.2 Primers.....	24



3.1.3	Enzymes.....	24
3.1.3.1	Restriction enzymes.....	24
3.1.3.2	Ligase .....	25
3.1.3.3	Taq Polymerase .....	25
3.1.3.4	Reverse Transcriptase.....	25
3.1.4	Commercial Kits.....	25
3.1.5	Vectors.....	25
3.1.6	Cells .....	26
3.1.7	Buffers and solutions .....	26
3.1.8	Culture medium .....	26
3.1.8.1	Liquid medium .....	26
3.1.8.2	Solid medium.....	26
3.1.8.3	Yeast SC (Synthetic Complete) Medium .....	26
3.1.8.4	YPD Medium.....	27
3.1.8.5	AT Medium .....	27
3.1.9	Sequencing.....	27
3.1.10	Equipments .....	28
3.2	Methods .....	28
3.2.1	Plant growth.....	28
3.2.2	RNA isolation from the plant .....	28
3.2.3	Preparation of cDNA from total RNA.....	29

3.2.3.1	GENE RACER™ Invitrogen.....	29
3.2.3.2	RT-PCR .....	30
3.2.4	PCR .....	30
3.2.5	Isolation of DNA fragments from gels .....	31
3.2.6	Sub cloning into pCR-II-TOPO4 vector.....	31
3.2.7	Subcloning .....	32
3.2.7.1	Subcloning into plant silencing vectors.....	32
3.2.7.2	Cloning into protein over expression vectors.....	32
3.2.7.3	Cloning into protein expression vector:.....	32
3.2.8	Gateway Cloning .....	32
3.2.8.1	Cloning into Gateway Donor vectors .....	33
3.2.8.2	Cloning into Gateway Destination vectors.....	33
3.2.9	Ligation.....	33
3.2.10	Preparation of <i>E.coli</i> competent cells .....	34
3.2.11	Transformation of competent <i>E.coli</i> cells.....	34
3.2.12	Plasmid isolation.....	35
3.2.13	Restriction Enzyme Digestions .....	35
3.2.14	Agarose gel electrophoresis.....	35
3.2.15	Preparation of <i>A.tumefaciens</i> competent cells.....	36
3.2.16	Transformation of competent <i>A.tumefaciens</i> cells.....	36
3.2.17	Transformation of Yeast cells.....	36

3.2.18	Mating Assay .....	37
3.2.19	Frozen stocks of cells .....	37
3.2.20	Sequence verification .....	38
3.2.21	Surface Sterilization of <i>N. benthamiana</i> seeds .....	38
3.2.22	Silencing analysis .....	38
3.2.22.1	Virus induced gene silencing.....	38
3.2.22.2	Virus challenging.....	39
3.2.23	Transient transformation of <i>Arabidopsis thailana</i> .....	39
4	RESULTS .....	40
4.1	Total RNA Isolation from Plant .....	40
4.2	cDNA Preparation .....	41
4.3	PCR Amplification of <i>JERF1</i> for subcloning.....	41
4.4	Subcloning of <i>JERF1</i> into various expression vectors .....	42
4.4.1	Subcloning to pCR <sup>®</sup> 4-TOPO for sequencing .....	42
4.4.2	Verification of the sub cloning of <i>JERF1</i> into pCR <sup>®</sup> 4-TOPO in E.coli .....	43
4.4.3	Characterization of <i>JERF1</i> gene .....	44
4.4.4	PCR Amplification for cloning into expression vectors.....	45
4.4.5	Gel purification of <i>JERF1</i> .....	46
4.4.6	Digestion of <i>JERF1</i> with proper restriction endonucleases .....	47
4.4.7	Digestion of different expression vectors for cloning of <i>JERF1</i> .....	48
4.4.8	Ligation.....	49

4.4.9	Cloning of <i>JERF1</i> gene .....	50
4.4.10	Sequence confirmations of constructs prepared .....	55
4.5	Silencing Analysis of <i>JERF1</i> .....	56
4.5.1	Plant observation .....	56
4.6	GFP-fusion protein Expression and Localization Analysis of <i>JERF1</i> .....	62
4.6.1	Transformations of constructs into <i>A.tumefaciens</i> .....	62
4.6.2	Transient expression of GFP constructs in <i>A. thaliana</i> .....	63
4.7	Protein-protein interaction analysis of JERF1 .....	64
4.7.1	Yeast Transformations.....	64
4.7.2	Mating Assay .....	65
4.8	Subcloning into Yeast Protein Expression Vector by Homologous Recombination .....	66
5	DISCUSSION.....	70
6	CONCLUSION .....	75
	REFERENCES .....	77
	APPENDIX A.....	85
	APPENDIX B .....	87
	APPENDIX C .....	93
	APPENDIX D.....	98
	APPENDIX E .....	100

## ABBREVIATIONS

<b>Aba</b>	: Absisic Acid
<b>ADR</b>	: Activated disease resistance
<b>AP2</b>	: Apetala2
<b>ARC</b>	: Apoptosis gene products,Resistance, CED-4
<b>Avr</b>	: Avirulence
<b>CC</b>	: Coiled coil
<b>DRE</b>	: Drought-responsive element
<b>dsRNA</b>	: Double-stranded RNA
<b>EREBP</b>	: Ethylene-responsive element binding protein
<b>ERF</b>	: Ethylene-responsive factor
<b>GDP</b>	: Guanosine diphosphate
<b>GTP</b>	: Guanosine triphosphate
<b>HR</b>	: Hypersensitive response
<b>IFN</b>	: Interferon
<b>IL</b>	: Interleukin
<b>JA</b>	: Jasmonic Acid
<b>LRR</b>	: Leucine-rich-repeat
<b>MAPK</b>	: Mitogen-activated protein kinase

<b>MAPKKK</b>	: Mitogen-activated protein kinase kinase kinase
<b>NBS</b>	: Nucleotide-binding-site
<b>PCD</b>	: Programmed cell death
<b>PKR</b>	: Interferon-induced protein kinase
<b>PR</b>	: Pathogenesis-related
<b>PVX</b>	: Potato virus X
<b>R</b>	: Resistance
<b>RBM</b>	: Regulatory domain-binding motif
<b>ROS</b>	: Reactive oxygen species
<b>Rp</b>	: Receptor protein
<b>SA</b>	: Salicylic Acid
<b>SAR</b>	: Systemic acquired resistance
<b>SIPK</b>	: Salicylic Acid-inducible protein kinase
<b>SOD</b>	: Superoxide dismutase
<b>ssRNA</b>	: Single-stranded RNA
<b>TEV</b>	: Tobacco etch virus
<b>TF</b>	: Transcription factor
<b>TIR</b>	: Toll- and Interleukin like receptor
<b>TM</b>	: Transmembrane
<b>TMV</b>	: Tobacco mosaic virus
<b>TPR</b>	: Tetratricopeptide repeat
<b>WIPK</b>	: Wound-inducible protein kinase

## LIST OF FIGURES

Figure 2.1: Schematic description of signal transduction in plants (Shinozaki and Dennis, 2003).....	3
Figure 2.2: Representation of the location and structure of the five main classes of plant disease resistance proteins. (Dangl and Jones, 2001) .....	5
Figure 2.3: Models for protein-protein interactions that might underlie plant-pathogen “gene-for-gene” recognition. Models that encompass interactions that could be consistent with the “guard” hypothesis are underlined (Martin <i>et al.</i> , 2003). .....	10
Figure 2.4 Complexity of Signaling Events Controlling Activation of Defense Responses. (Hammond-Kosack and Jones, 1996) .....	15
Figure 2.5: Structural representation of mammalian PKR and target sites for viral-directed PKR inhibition (Gale Jr and Katze, 1998) .....	18
Figure 2.6: Mammalian PKR maturation pathway and sites of viral-directed regulation (Gale Jr and Katze, 1998) .....	18
Figure 4.1: 1.2% agarose gel electrophoresis of total RNA isolation from tomato.....	40
Figure 4.2: Figure showing the primer sites corresponding to <i>JERF 1</i> .....	41
Figure 4.3: Amplification of <i>JERF1</i> from cDNA with primers 190 and 194.....	42
Figure 4.4: Colony PCR of transformed <i>E.coli</i> Top 10 cells containing the pCR <sup>®</sup> 4-TOPO vector ligated with <i>JERF1</i> (DB90).....	43
Figure 4.5: Electrophoretic analysis of DB90 construct digested with <i>EcoRI</i> and undigested plasmid .....	44

Figure 4.6: 1% Agarose gel electrophoresis result showing the amplification of *JERF 1* with different primers for different expression vectors. DNA molecular weight markers, different samples and electrophoresis conditions are indicated on the gel photograph.. 46

Figure 4.7: 1% Agarose gel electrophoresis result after the purification of PCR products of *JERF1* amplified with different primers..... 47

Figure 4.8: 1% Agarose gel electrophoresis result of the digestion of *JERF1* gene with proper restriction endonucleases for expression vectors. .... 48

Figure 4.9: Electrophoretic analysis of different vector digestions with different restriction endonucleases. .... 49

Figure 4.10: 1% Agarose gel electrophoresis showing the colony PCR result of pTRV2+ *JERF1* transformation..... 50

Figure 4.11: 1% Agarose gel electrophoresis photograph showing the colony PCR result of the transformation of pJG4-5+ *JERF1* into *E.coli* TOP10 cells..... 51

Figure 4.12: 1% Agarose gel electrophoresis photograph showing the colony PCR result of the transformation of pTBSI+ *JERF1* into *E.coli* TOP10 cells..... 52

Figure 4.13: 1% % Agarose gel electrophoresis photograph showing the colony PCR result of the transformation of pRTL2-GUS/NIaΔBam + *JERF1* into *E.coli* TOP10 cells. 1-16= PCR of 16 different colonies of pRTL2-GUS/NIaΔBam + *JERF1* transformation with primers 190 and 194. (+)=PCR amplification of *JERF1*+ pCR-4-TOPO with primers 190 and 194 as positive control. (-)= negative control. .... 53

Figure 4.14: 1% Agarose gel electrophoresis of colony PCR of DB109. 1= PCR amplification with primers 190 and 194 of colony grown after BP reaction, 2= PCR amplification of *JERF1*+ pCR-4-TOPO with primers 190 and 194 as positive control. 3= PCR amplification with primers 190 and 196 of colony grown after BP reaction. 4= PCR amplification of *JERF1*+ pCR-4-TOPO with primers 190 and 196 as positive control. 5= PCR amplification with primers 195 and 194 of colony grown after BP reaction. 6= PCR amplification of DB90 with primers 195 and 194 as positive control. 7= negative control. .... 54

Figure 4.15: 1% Agarose gel electrophoresis of colony PCR with primers 190 and 194 of 12 colonies grown on selective media. 2, 3, 4, 5, 6, 12= colonies grown after transformation of GFP-N- Bin +*JERF1* constructs. 1, 7, 8, 9, 10, 13= colonies grown after transformation of GFP-C- Bin +*JERF1* constructs. 11= PCR amplification of *JERF1*+ pCR-4-TOPO with primers 190 and 194 as positive control. (-)= negative control. .... 55



Figure 4.16: Control wild-type (nn) plant which is neither silenced nor TMV infected	57
Figure 4.17: Control nn plant which is not silenced but TMV infected .....	58
Figure 4.18: Control NN plant which is not silenced but TMV infected .....	59
Figure 4.19: NN plant that is <i>JERF1</i> silenced and TMV infected.....	60
Figure 4.20: nn plant that is <i>JERF1</i> silenced and TMV infected .....	61
Figure 4.21: nn plant that is <i>JERF1</i> silenced and TMV infected .....	61
Figure 4.22: 1% Agarose gel electrophoresis of colony PCR with primers 190 and 194 showing the presence of <i>JERF1</i> gene in <i>A.tumefaciens</i> transformed with GFP-N-Bin+ <i>JERF1</i> construct. 1-16= colonies grown after transformation of GFP-N- Bin + <i>JERF1</i> constructs. (+)= = PCR amplification of <i>JERF1</i> + pCR-4-TOPO with primers 190 and 194 as positive control. (-)= negative control. ....	62
Figure 4.23: 1% Agarose gel electrophoresis of colony PCR with primers 190 and 194 showing the presence of <i>JERF1</i> gene in <i>A.tumefaciens</i> transformed with GFP-C-Bin+ <i>JERF1</i> construct. 1-16= colonies grown after transformation of GFP-C- Bin + <i>JERF1</i> constructs. (+)= = PCR amplification of <i>JERF1</i> + pCR-4-TOPO with primers 190 and 194 as positive control. (-)= negative control .....	63
Figure 4.24: Electrophoresis analysis of colony PCR with primers 190 and 194 of 5 yeast EGY48 and 5 yeast RFY206 colonies grown on selective medium after transformation with DB112 construct.....	64
Figure 4.25: Mating Assay Result showing the in vivo interaction of Plant P58IPK with <i>JERF1</i> .....	65
Figure 4.26: 1% Agarose gel electrophoresis result showing the amplification of <i>JERF1</i> with primers 207 and 208. ....	66
Figure 4.27: 1% agarose gel electrophoresis showing the <i>HindIII</i> digestion of the vector pEGKG. Samples were run at 100 V for 1.5 hours .....	67
Figure 4.28: Electrophoresis analysis of colony PCR with primers 190 and 194 of 4 yeast EGY 48 colonies and 4 RFY206 colonies grown on selective medium after transformation with pEGKG and <i>JERF1</i> .....	68

Figure 4.29: Electrophoresis analysis of colony PCR with primers 190 and 194 of 6 *E.coli* colonies grown after electroporation of pEGKG+*JERF1* construct into *E.coli* cells. .... 69

A NOVEL AP2 DOMAIN TRANSCRIPTION FACTOR FROM  
*Lycopersicon esculentum*, FUNCTIONS IN TOBACCO MOSAIC VIRUS  
PATHOGENESIS

by

BURCU DARTAN

Submitted to the Graduate School of Engineering and Natural Sciences  
in partial fulfillment of  
the requirements for the degree of  
Master of Science

Sabanci University

July 2004

A NOVEL AP2 DOMAIN TRANSCRIPTION FACTOR FROM  
*Lycopersicon esculentum*, FUNCTIONS IN TOBACCO MOSAIC VIRUS  
PATHOGENESIS

APPROVED BY:

Assoc. Prof. Zehra Sayers .....

(Dissertation Supervisor)

Dr. Damla Bilgin .....

(Co-Supervisor)

Prof. Meral Yücel .....

Dr. Alpay Taralp .....

Assistant Prof. Cengiz Yakıcıer .....

DATE OF APPROVAL: .....

© Burcu Dartan 2004

All Rights Reserved

## ABSTRACT

In this work, one of the established plant defense proteins namely that corresponding to the class EREBP-like transcription factors containing the AP2 domain was examined to identify a possible role in Tobacco Mosaic Virus Pathogenesis. In particular, a putative AP2-domain EREBP-like transcription factor –JERF1- from tomato cDNA was subcloned into various expression vectors in order to test for its potential role in virus response in *Solanaceae*. The gene silencing experiments, in which death was observed subsequent to silencing of the *JERF1* gene and TMV infection, have shown that this particular gene might be involved in the TMV infection cycle in *Solanaceae*. The results of a yeast mating assay conducted in this study has also implied that JERF1 is an interactor of plant P58<sup>IPK</sup>. This possibility would in turn suggests that JERF1 may be involved in plant-virus interaction. Overexpression, yeast-protein expression, and GFP-fusion constructs have also been prepared to support functional analyses of this putative transcription factor. It would follow to reason that this study of the recently sequenced JERF1 describes the first attempt to understand the function of this protein in plant-virus interaction.

## ÖZET

Bu çalışmada, EREB protein benzeri transkripsiyon faktörlerine karşılık gelen, AP2 alanına sahip olan ve bitki savunma proteinlerinden olan bir protein, Tütün Mozaik Virüsü (TMV) patojenesisindeki muhtemel rolünün tanımlanması için incelenmiştir. Özellikle, AP2 alanına sahip EREB protein benzeri bu transkripsiyon faktörü-JERF1-domates cDNA'sından klonlanmış ve virus duyarlılığında ya da dirençliliğinde rolünü bulabilmek için değişik vektörlere takılmıştır. *JERF1* geninin susturulduğu ve tütün mozaik virüsünün enfeksiyonunun yapıldığı gen susturulması deneyleri, bu genin *Solanacea* ailesinde TMV enfeksiyon döngüsünde görev aldığını gösterir. Maya çiftleştirme deneyleri de JERF1 proteininin bitki P58<sup>IPK</sup> proteini ile etkileştiğini göstermiştir ve bu JERF1'in bitki virus etkileşiminde yer alabileceğini belirtir. Ayrıca, bu transkripsiyon faktörünün fonksiyonel analizi için bu gen, overekspresyon, maya-protein ekspresyonu ve GFP-bileşik vektörlerine takılmıştır. Bu çalışma, yakın zamanda dizisi belirlenen JERF1 proteininin, bitki-virus etkileşimindeki işlevini tanımlamak için atılan ilk adımı oluşturmaktadır.

*To my family with all my heart,*

*Rest & be thankful in a world where nothing is random...*



## ACKNOWLEDGEMENTS

I am grateful to Prof. Dr. Zehra Sayers for her supervision and to Dr. Damla Bilgin for her endless support, advise and help throughout this study.

I also would like to express my appreciation to Dr. Alpay Taralp who has taught me how to think, analyze and criticize in the way paving through being a scientist. My special thanks go to Dr. Metin Bilgin who has given me new inspirations when I was stuck during my study. I also would like to thank to Dr. Fahriye Ertuğrul and Dr. Sedef Tunca who have taught me how to conduct a scientific experiment and helped me with my research.

My deepest appreciation goes to my parents Belgin and Besim Ömer Dartan, my aunts, my uncles, my cousins and my grandparents who have gifted me my life and personality.

Moreover I would like to thank to my sisters Didem Demirbaş, Funda Güngör, Gözde Vrana, Işın Nur Cicerali, Senem Tuğ and Tuğçe Güleryüz for their valuable friendship during my undergraduate and graduate education.

Thanks also go to my colleagues Çetin Baloğlu, H.Ümit Öztürk, Kıvanç Bilecen, Özgür Gül and Özgür Kütük for their help in this study.

I also would like to offer my sincere appreciation to my dearest SU GIRLS- Burcu Kaplan, Elanur Şireli, E. Süphan Bakkal, Filiz Dede and Yasemin Türkeli- for their encouragement and friendship throughout my study. Finally, I would like to express my intense gratitude to my friend A. Barış Karagözler without whom I would not bring about this thesis.

## TABLE OF CONTENTS

TABLE OF CONTENTS.....	viii
1 INTRODUCTION .....	1
2 OVERVIEW .....	2
2.1 Signal perception and transduction in plant defense responses.....	4
2.1.1 Resistance Genes and Resistance Protein Function .....	5
2.2 Resistant and Susceptible Host Responses.....	10
2.2.1 Similarities of PCD between Plants and Animals .....	13
2.2.2 Secondary Signaling Molecules in Plant Defense Responses .....	14
2.3 Viruses and Viral Pathogenicity .....	15
2.3.1 Host Defense Responses against Viruses .....	16
2.4 Transcription Factors .....	20
2.5 A novel AP2 domain TF from tomato.....	23
2.6 Aim of the study .....	23
3 MATERIALS AND METHODS .....	24
3.1 Materials .....	24
3.1.1 Chemicals .....	24
3.1.2 Primers.....	24

3.1.3	Enzymes.....	24
3.1.3.1	Restriction enzymes.....	24
3.1.3.2	Ligase .....	25
3.1.3.3	Taq Polymerase .....	25
3.1.3.4	Reverse Transcriptase.....	25
3.1.4	Commercial Kits.....	25
3.1.5	Vectors.....	25
3.1.6	Cells .....	26
3.1.7	Buffers and solutions .....	26
3.1.8	Culture medium .....	26
3.1.8.1	Liquid medium .....	26
3.1.8.2	Solid medium.....	26
3.1.8.3	Yeast SC (Synthetic Complete) Medium .....	26
3.1.8.4	YPD Medium.....	27
3.1.8.5	AT Medium .....	27
3.1.9	Sequencing.....	27
3.1.10	Equipments .....	28
3.2	Methods .....	28
3.2.1	Plant growth.....	28
3.2.2	RNA isolation from the plant .....	28
3.2.3	Preparation of cDNA from total RNA.....	29

3.2.3.1	GENE RACER™ Invitrogen.....	29
3.2.3.2	RT-PCR .....	30
3.2.4	PCR .....	30
3.2.5	Isolation of DNA fragments from gels .....	31
3.2.6	Sub cloning into pCR-II-TOPO4 vector.....	31
3.2.7	Subcloning .....	32
3.2.7.1	Subcloning into plant silencing vectors.....	32
3.2.7.2	Cloning into protein over expression vectors.....	32
3.2.7.3	Cloning into protein expression vector:.....	32
3.2.8	Gateway Cloning .....	32
3.2.8.1	Cloning into Gateway Donor vectors .....	33
3.2.8.2	Cloning into Gateway Destination vectors.....	33
3.2.9	Ligation.....	33
3.2.10	Preparation of <i>E.coli</i> competent cells .....	34
3.2.11	Transformation of competent <i>E.coli</i> cells.....	34
3.2.12	Plasmid isolation.....	35
3.2.13	Restriction Enzyme Digestions .....	35
3.2.14	Agarose gel electrophoresis.....	35
3.2.15	Preparation of <i>A.tumefaciens</i> competent cells.....	36
3.2.16	Transformation of competent <i>A.tumefaciens</i> cells.....	36
3.2.17	Transformation of Yeast cells.....	36

3.2.18	Mating Assay .....	37
3.2.19	Frozen stocks of cells .....	37
3.2.20	Sequence verification .....	38
3.2.21	Surface Sterilization of <i>N. benthamiana</i> seeds .....	38
3.2.22	Silencing analysis .....	38
3.2.22.1	Virus induced gene silencing.....	38
3.2.22.2	Virus challenging.....	39
3.2.23	Transient transformation of <i>Arabidopsis thailana</i> .....	39
4	RESULTS .....	40
4.1	Total RNA Isolation from Plant .....	40
4.2	cDNA Preparation .....	41
4.3	PCR Amplification of <i>JERF1</i> for subcloning.....	41
4.4	Subcloning of <i>JERF1</i> into various expression vectors .....	42
4.4.1	Subcloning to pCR <sup>®</sup> 4-TOPO for sequencing .....	42
4.4.2	Verification of the sub cloning of <i>JERF1</i> into pCR <sup>®</sup> 4-TOPO in <i>E.coli</i> .....	43
4.4.3	Characterization of <i>JERF1</i> gene .....	44
4.4.4	PCR Amplification for cloning into expression vectors.....	45
4.4.5	Gel purification of <i>JERF1</i> .....	46
4.4.6	Digestion of <i>JERF1</i> with proper restriction endonucleases .....	47
4.4.7	Digestion of different expression vectors for cloning of <i>JERF1</i> .....	48
4.4.8	Ligation.....	49

4.4.9	Cloning of <i>JERF1</i> gene .....	50
4.4.10	Sequence confirmations of constructs prepared .....	55
4.5	Silencing Analysis of <i>JERF1</i> .....	56
4.5.1	Plant observation .....	56
4.6	GFP-fusion protein Expression and Localization Analysis of <i>JERF1</i> .....	62
4.6.1	Transformations of constructs into <i>A.tumefaciens</i> .....	62
4.6.2	Transient expression of GFP constructs in <i>A. thaliana</i> .....	63
4.7	Protein-protein interaction analysis of JERF1 .....	64
4.7.1	Yeast Transformations.....	64
4.7.2	Mating Assay .....	65
4.8	Subcloning into Yeast Protein Expression Vector by Homologous Recombination .....	66
5	DISCUSSION.....	70
6	CONCLUSION .....	75
	REFERENCES .....	77
	APPENDIX A.....	85
	APPENDIX B .....	87
	APPENDIX C .....	93
	APPENDIX D.....	98
	APPENDIX E .....	100

## ABBREVIATIONS

<b>Aba</b>	: Absisic Acid
<b>ADR</b>	: Activated disease resistance
<b>AP2</b>	: Apetala2
<b>ARC</b>	: Apoptosis gene products,Resistance, CED-4
<b>Avr</b>	: Avirulence
<b>CC</b>	: Coiled coil
<b>DRE</b>	: Drought-responsive element
<b>dsRNA</b>	: Double-stranded RNA
<b>EREBP</b>	: Ethylene-responsive element binding protein
<b>ERF</b>	: Ethylene-responsive factor
<b>GDP</b>	: Guanosine diphosphate
<b>GTP</b>	: Guanosine triphosphate
<b>HR</b>	: Hypersensitive response
<b>IFN</b>	: Interferon
<b>IL</b>	: Interleukin
<b>JA</b>	: Jasmonic Acid
<b>LRR</b>	: Leucine-rich-repeat
<b>MAPK</b>	: Mitogen-activated protein kinase

<b>MAPKKK</b>	: Mitogen-activated protein kinase kinase kinase
<b>NBS</b>	: Nucleotide-binding-site
<b>PCD</b>	: Programmed cell death
<b>PKR</b>	: Interferon-induced protein kinase
<b>PR</b>	: Pathogenesis-related
<b>PVX</b>	: Potato virus X
<b>R</b>	: Resistance
<b>RBM</b>	: Regulatory domain-binding motif
<b>ROS</b>	: Reactive oxygen species
<b>Rp</b>	: Receptor protein
<b>SA</b>	: Salicylic Acid
<b>SAR</b>	: Systemic acquired resistance
<b>SIPK</b>	: Salicylic Acid-inducible protein kinase
<b>SOD</b>	: Superoxide dismutase
<b>ssRNA</b>	: Single-stranded RNA
<b>TEV</b>	: Tobacco etch virus
<b>TF</b>	: Transcription factor
<b>TIR</b>	: Toll- and Interleukin like receptor
<b>TM</b>	: Transmembrane
<b>TMV</b>	: Tobacco mosaic virus
<b>TPR</b>	: Tetratricopeptide repeat
<b>WIPK</b>	: Wound-inducible protein kinase



## LIST OF FIGURES

Figure 2.1: Schematic description of signal transduction in plants (Shinozaki and Dennis, 2003).....	3
Figure 2.2: Representation of the location and structure of the five main classes of plant disease resistance proteins. (Dangl and Jones, 2001) .....	5
Figure 2.3: Models for protein-protein interactions that might underlie plant-pathogen “gene-for-gene” recognition. Models that encompass interactions that could be consistent with the “guard” hypothesis are underlined (Martin <i>et al.</i> , 2003). .....	10
Figure 2.4 Complexity of Signaling Events Controlling Activation of Defense Responses. (Hammond-Kosack and Jones, 1996) .....	15
Figure 2.5: Structural representation of mammalian PKR and target sites for viral-directed PKR inhibition (Gale Jr and Katze, 1998) .....	18
Figure 2.6: Mammalian PKR maturation pathway and sites of viral-directed regulation (Gale Jr and Katze, 1998) .....	18
Figure 4.1: 1.2% agarose gel electrophoresis of total RNA isolation from tomato.....	40
Figure 4.2: Figure showing the primer sites corresponding to <i>JERF 1</i> .....	41
Figure 4.3: Amplification of <i>JERF1</i> from cDNA with primers 190 and 194.....	42
Figure 4.4: Colony PCR of transformed <i>E.coli</i> Top 10 cells containing the pCR <sup>®</sup> 4-TOPO vector ligated with <i>JERF1</i> (DB90).....	43
Figure 4.5: Electrophoretic analysis of DB90 construct digested with <i>EcoRI</i> and undigested plasmid .....	44

Figure 4.6: 1% Agarose gel electrophoresis result showing the amplification of *JERF 1* with different primers for different expression vectors. DNA molecular weight markers, different samples and electrophoresis conditions are indicated on the gel photograph.. 46

Figure 4.7: 1% Agarose gel electrophoresis result after the purification of PCR products of *JERF1* amplified with different primers..... 47

Figure 4.8: 1% Agarose gel electrophoresis result of the digestion of *JERF1* gene with proper restriction endonucleases for expression vectors. .... 48

Figure 4.9: Electrophoretic analysis of different vector digestions with different restriction endonucleases. .... 49

Figure 4.10: 1% Agarose gel electrophoresis showing the colony PCR result of pTRV2+ *JERF1* transformation..... 50

Figure 4.11: 1% Agarose gel electrophoresis photograph showing the colony PCR result of the transformation of pJG4-5+ *JERF1* into *E.coli* TOP10 cells..... 51

Figure 4.12: 1% Agarose gel electrophoresis photograph showing the colony PCR result of the transformation of pTBSI+ *JERF1* into *E.coli* TOP10 cells..... 52

Figure 4.13: 1% % Agarose gel electrophoresis photograph showing the colony PCR result of the transformation of pRTL2-GUS/NIaΔBam + *JERF1* into *E.coli* TOP10 cells. 1-16= PCR of 16 different colonies of pRTL2-GUS/NIaΔBam + *JERF1* transformation with primers 190 and 194. (+)=PCR amplification of *JERF1*+ pCR-4-TOPO with primers 190 and 194 as positive control. (-)= negative control. .... 53

Figure 4.14: 1% Agarose gel electrophoresis of colony PCR of DB109. 1= PCR amplification with primers 190 and 194 of colony grown after BP reaction, 2= PCR amplification of *JERF1*+ pCR-4-TOPO with primers 190 and 194 as positive control. 3= PCR amplification with primers 190 and 196 of colony grown after BP reaction. 4= PCR amplification of *JERF1*+ pCR-4-TOPO with primers 190 and 196 as positive control. 5= PCR amplification with primers 195 and 194 of colony grown after BP reaction. 6= PCR amplification of DB90 with primers 195 and 194 as positive control. 7= negative control. .... 54

Figure 4.15: 1% Agarose gel electrophoresis of colony PCR with primers 190 and 194 of 12 colonies grown on selective media. 2, 3, 4, 5, 6, 12= colonies grown after transformation of GFP-N- Bin +*JERF1* constructs. 1, 7, 8, 9, 10, 13= colonies grown after transformation of GFP-C- Bin +*JERF1* constructs. 11= PCR amplification of *JERF1*+ pCR-4-TOPO with primers 190 and 194 as positive control. (-)= negative control. .... 55

Figure 4.16: Control wild-type (nn) plant which is neither silenced nor TMV infected	57
Figure 4.17: Control nn plant which is not silenced but TMV infected .....	58
Figure 4.18: Control NN plant which is not silenced but TMV infected .....	59
Figure 4.19: NN plant that is <i>JERF1</i> silenced and TMV infected.....	60
Figure 4.20: nn plant that is <i>JERF1</i> silenced and TMV infected .....	61
Figure 4.21: nn plant that is <i>JERF1</i> silenced and TMV infected .....	61
Figure 4.22: 1% Agarose gel electrophoresis of colony PCR with primers 190 and 194 showing the presence of <i>JERF1</i> gene in <i>A.tumefaciens</i> transformed with GFP-N-Bin+ <i>JERF1</i> construct. 1-16= colonies grown after transformation of GFP-N- Bin + <i>JERF1</i> constructs. (+)= = PCR amplification of <i>JERF1</i> + pCR-4-TOPO with primers 190 and 194 as positive control. (-)= negative control. ....	62
Figure 4.23: 1% Agarose gel electrophoresis of colony PCR with primers 190 and 194 showing the presence of <i>JERF1</i> gene in <i>A.tumefaciens</i> transformed with GFP-C-Bin+ <i>JERF1</i> construct. 1-16= colonies grown after transformation of GFP-C- Bin + <i>JERF1</i> constructs. (+)= = PCR amplification of <i>JERF1</i> + pCR-4-TOPO with primers 190 and 194 as positive control. (-)= negative control .....	63
Figure 4.24: Electrophoresis analysis of colony PCR with primers 190 and 194 of 5 yeast EGY48 and 5 yeast RFY206 colonies grown on selective medium after transformation with DB112 construct.....	64
Figure 4.25: Mating Assay Result showing the in vivo interaction of Plant P58IPK with <i>JERF1</i> .....	65
Figure 4.26: 1% Agarose gel electrophoresis result showing the amplification of <i>JERF1</i> with primers 207 and 208. ....	66
Figure 4.27: 1% agarose gel electrophoresis showing the <i>HindIII</i> digestion of the vector pEGKG. Samples were run at 100 V for 1.5 hours .....	67
Figure 4.28: Electrophoresis analysis of colony PCR with primers 190 and 194 of 4 yeast EGY 48 colonies and 4 RFY206 colonies grown on selective medium after transformation with pEGKG and <i>JERF1</i> .....	68

Figure 4.29: Electrophoresis analysis of colony PCR with primers 190 and 194 of 6 *E.coli* colonies grown after electroporation of pEGKG+*JERF1* construct into *E.coli* cells. .... 69

## 1 INTRODUCTION

Several proteins have been shown to be involved in plant defense systems opposing biotic and abiotic stresses. One subgroup of these proteins is the AP2 domain containing EREBP-like transcription factors and moderate responses by regulation of various signaling pathways in plants. The AP-2 domain is unique to plants and found to be evolutionarily conserved in *Solanaceae* and *Brassicaceae*. Besides the role of AP2-domain transcription factors in biotic and abiotic stress resistance, they are found to be playing a role in developmental and metabolic processes of plants (Reviewed by Zhang, 2003).

A recently sequenced putative transcription factor has been found to contain an AP2 domain and named as JERF1. This putative transcription factor might be functioning as Jasmonic acid and Ethylene Response Factor (Huang *et al.*).

A partial clone of JERF1 has been found to be interacting with plant P58<sup>IPK</sup> (Bilgin D.D, unpublished data). This implies that JERF1 might be involved in plant-virus interaction. However, there has been no other published data about the role of this putative transcription factor.

In order to obtain functional information about this putative transcription factor, it has been subcloned into various expression vectors. The silencing, overexpression, protein-protein interaction and GFP-fusion protein expression constructs prepared in this work have been used for functional analyses of this putative transcription factor. Silencing experiments in which death was observed in TMV infected *N.benthamiana* plants succeeding *JERF1* silencing implies that JERF1 might be involved in TMV susceptibility of plants.

## 2 OVERVIEW

Plant diseases are the most important obstacles in agriculture. In 1994, Brears and Ryals have estimated that the worldwide crop loss due to plant diseases have exceeded \$ 100 billion. Increased human populations and the demand for food bring about the extensive use of chemical pathogen control. Applications of fungicides and pesticides help control plant diseases but chemical control is not only economically costly but also environmentally undesirable. Therefore, more effective utilization of natural genetic disease resistance mechanisms with novel and environmentally friendly active ingredients for chemical control has been of much concern for research. This results in the study of plant diseases and resistance mechanisms in a much more detailed manner and development of new strategies based on plant's own defense mechanism for disease control.

Plants are sessile organisms and they have to survive in various environmental conditions during growth and development. Plants use various environmental signals such as light, temperature and water availability in order to regulate their normal growth, germination and flowering. However, severe conditions such as drought, low temperature, heat, high salinity of the soil or flooding have adverse effects on plant growth and development and constitute the abiotic stresses. Plant gene expression levels change in response to different environmental signals. Plants perceive the environmental signal and start a cascade of events finally altering gene expression and physiological responses (Shinozaki and Dennis, 2003) (See Fig: 2.1).

Fungi, bacteria, nematodes, insects and viruses create biotic stress in the plants by using their photosynthetic products, replication machinery etc. Plants have evolved highly sophisticated species and pathogen specific response mechanisms to perceive the attacks from pathogens and in turn give an adaptive response. For the past century, it is

known that plants own genetically inherited resistance mechanisms to combat phytopathogenic fungi, bacteria and viruses, etc. However, with the development of molecular biology, the understanding of the basis of these relationships has improved significantly.

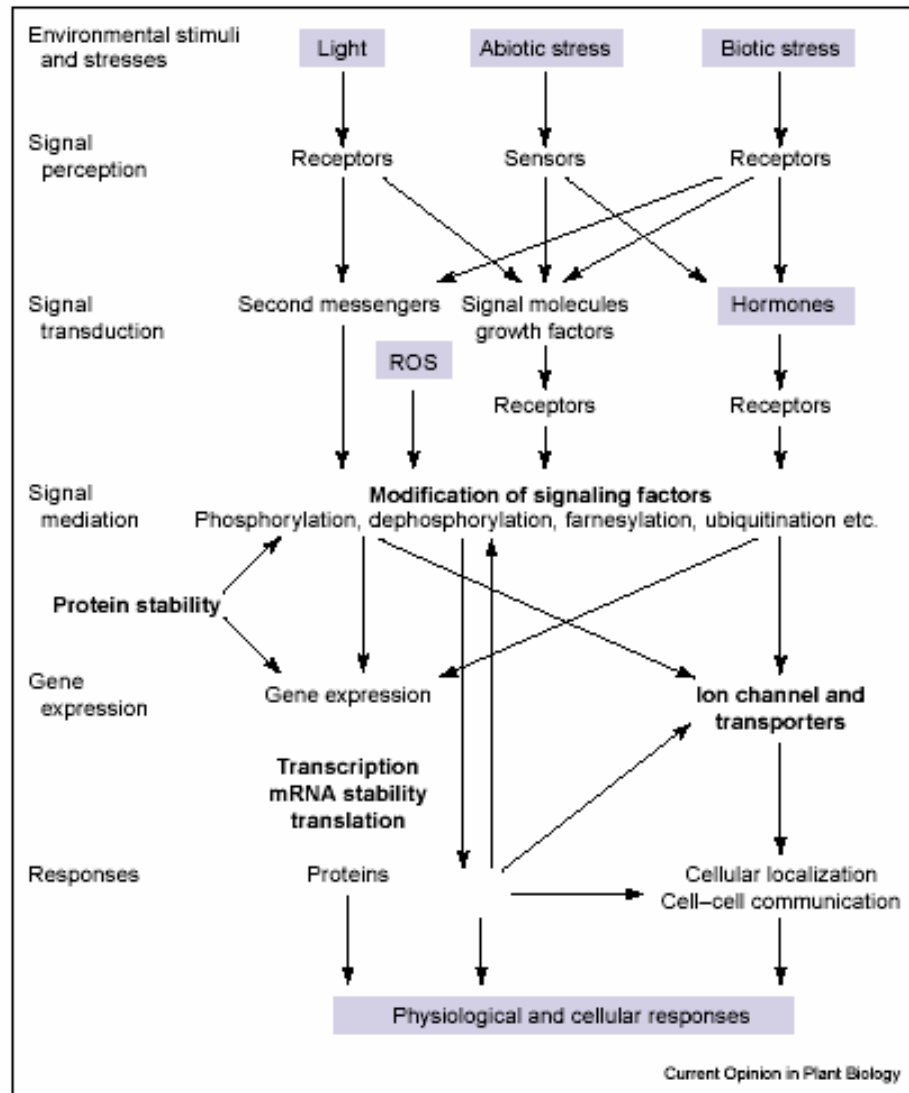

Figure 2.1: Schematic description of signal transduction in plants (Shinozaki and Dennis, 2003)

Combined genotypes of host and pathogen govern the plant resistance and susceptibility that are dependent on a complex exchange of signals and responses occurring under specific environmental conditions. The long process of host-pathogen co-evolution has made plants develop various elaborate mechanisms to avoid pathogen

attack. Defense mechanisms may be preformed, such as the physical and chemical barriers to hinder pathogen infection, or induced only after pathogen attack. Induced plant defense responses include a network of signal transduction and rapid activation of gene expression following pathogen infection just like animal immune responses (Yang *et al.*, 1997).

## 2.1 Signal perception and transduction in plant defense responses

Plants can be divided into two categories according to the response that they administer upon a pathogen attack. Plant's nomination as "Resistant" or "Susceptible" depends on the timely recognition of the invading pathogen and rapid and effective activation of host defense mechanisms. A plant is referred as "Resistant" if it is capable of rapidly invoking a wide variety of defense responses in order to prevent pathogen colonization. On the other hand, a "Susceptible" plant is generally severely damaged or even killed by the pathogen infection. Pathogen-encoded molecules that are able to activate defense responses in plants when recognized by the host are called "Elicitors". The interaction of pathogen elicitors with host receptors activate a signal transduction cascade that might include protein phosphorylation, ion fluxes, reactive oxygen species (ROS) generation and other signaling events (Yang *et al.*, 1997).

The resistance (*R*) genes encode the receptors for recognition of specific elicitors or ligands. The potential damage that can be caused when a plant is infected by a pathogen can be limited by the recognition of the pathogen. The interaction between a dominant avirulence (*avr*) gene in the pathogen and the corresponding dominant resistance (*R*) gene in the host is explained by the so-called "gene-for-gene interaction". This model proposes that the activation of defense responses requires the expression of a matching pair plant *R* gene and pathogen *avr* gene (Flor, 1971).



### 2.1.1 Resistance Genes and Resistance Protein Function

Plant-pathogen interaction is provided by specific interactions between pathogen avr gene loci and alleles of corresponding plant disease resistance (R) locus. Disease resistance occurs when the avr and corresponding R genes are present in both host and pathogen. On the other hand, disease results when either is absent or inactive. Recognition of avr-dependent signals by R gene products and initiation of the signal-transduction events that activates defense mechanisms and arrest of the pathogen growth is the simplest model accounting for the genetic interaction between avr and R genes. It has been found that functional R genes isolated so far demonstrate resistance to a wide range of pathogen taxa including bacteria, viruses, fungi, nematodes, oomycetes and even insects. However, R gene products share striking structural similarities. This suggests that certain signaling events are held in common in plant defense (Reviewed by Dangl and Jones, 2001 and Martin *et al.*, 2003).

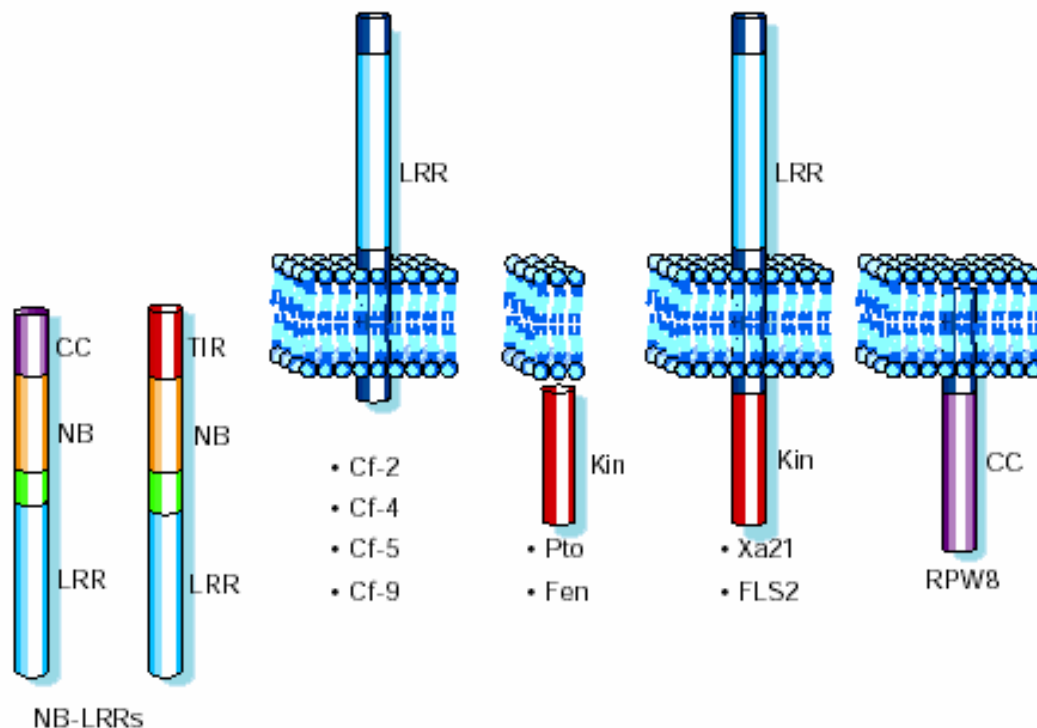

Figure 2.2: Representation of the location and structure of the five main classes of plant disease resistance proteins. (Dangl and Jones, 2001)

:

Numerous R genes have been cloned from several plant species and they can be grouped into 5 classes according to the protein they code (See Fig: 2.2). The first class encodes a cytoplasmic receptor-like protein that contains a Leucine-rich-repeat (LRR) domain and a nucleotide-binding site (NBS).

C-terminus of NBS domain is found in APAF-1 and CED-4 proteins, which have a role in programmed cell death among animal cells, and is called as ARC (apoptosis, R gene products and CED-4) (Van der Biezen and Jones, 1998). There is an N-terminal sub-domain containing a consensus kinase 1a (P-loop), kinase 2 and kinase 3 motifs which are found in a large variety of nucleotide-binding proteins. This suggests that R proteins might control plant cell death by their NBS- ARC domains when activated via LRR-dependent recognition of the plant pathogen.

The NBS-LRR group can be subdivided into two. The first subgroup contains a TIR (Toll-IL-1R homology region) domain that shows homology to cytoplasmic domains of the *Drosophila* developmental gene Toll and the mammalian immune response gene encoding the interleukin-1 receptor (IL-1R). *Drosophila* Toll and mammalian and avian IL-1R not only show structural similarities but also share homologous downstream signaling components including adaptor proteins, kinases and transcription factors. Toll and IL-1R are membrane-bound proteins that have role in innate cellular resistance responses of animals. (Lemaitre *et al.*, 1996; Medzhitov *et al.*, 1997) Upon binding of ligand to the extracellular domains of Toll and IL-1R, the intracellular domains of these receptors activate the signaling pathway in order to avoid the pathogen attack. (Volpe *et al.*, 1997; Yang and Steward, 1997). R proteins containing N-terminal TIR domains are; *N* gene from tobacco (Whitham *et al.*, 1994), L6 of flax (Lawrence *et al.*, 1995), RPP, RPP10, RPP14 (Botella *et al.*, 1998), RPP5 (Parker *et al.*, 1997), RPS4 (Gassmann *et al.*, 1999) and M (Anderson *et al.*, 1998) from *Arabidopsis thaliana*. LRR domain is present in many proteins of diverse function and is found to be involved in protein-protein interactions (Kobe and Deisenhofer, 1994). Domain swaps and TIR and NBS comparisons of flax rust resistance L gene have shown that L regions are involved in recognition specificity of the R protein with its effectors (Ellis *et al.*, 1999; Luck *et al.*, 2000).

The second subgroup contains putative coiled-coil domains (CC-NB-LRR). The CC structure is a repeated heptad sequence has interspersed hydrophobic amino acid residues. There are two or more alpha helices whose interaction form a super coil and is thought to function in protein-protein interactions, oligomerization and oligomerization-dependent nucleic acid binding (Reviewed by Martin *et al.*, 2003). Reconstruction of a functional Rx protein by co-expression of CC-NBS domain with LRR region and CC domain with NBS-LRR show that intramolecular interactions are important for response. Upon pathogen recognition, conformational changes in Rx occur that cause the disruption of intramolecular interactions and initiate the signaling cascade (Moffett *et al.*, 2002).

The third class proteins encode a serine-threonine kinase with homology to mammalian Raf, IRAK and Drosophila Pelle kinases in IL insensitive response pathways. *Pto* gene from tomato is an example for this group (Sessa *et al.*, 2000). Pto kinase confers resistance to strains of *Pseudomonas* bacteria that express *avrPto* that directly interacts with Pto kinase. It has been found that *Prf* gene located in *Pto* gene cluster is also required for Pto-specified responses. The function of Prf is not exactly known but is supposed to be guarding the Pto upon *avrPto* interaction and activating the host defense. Pto has been found to interact with other protein kinases such as Pti1 and Pti 4/5 and 6 transcription factors which have sequence similarity to ethylene-responsive factors (ERFs) and regulate expression of PR proteins (Reviewed by Pedley and Martin, 2003)

The fourth class encodes a putative transmembrane receptor with an extracellular LRR domain and an intracellular serine-threonine kinase domain. *Xa21* gene from rice is an example for this type of *R* genes (Song *et al.*, 1995)

The newest found *R* gene forms the fifth group that encodes a small, probable membrane protein with a possible coiled-coil domain and essentially no other homology to known proteins. First and third group of *R* genes lack transmembrane (TM) domains and are thought to be localized intracellularly.

Few R proteins do not fit into these five classes. *Hs1pro-1* nematode resistance gene from sugar beet has been found to represent a novel resistance gene class (Ellis and Jones, 1998).

It is suggested that R proteins in general colocalize with their pathogen effectors. All of the R proteins belonging to group 1 and their effectors are found to be associated with the plasma membrane. Effectors of the second group R proteins carrying transmembrane and extracellular LRR domains are found to be extracellular. Since localization of R proteins depends on the effectors localization, R proteins that recognize more than one effectors may localize to more than once subcellular location and translocation of some R proteins may take place during signaling (Reviewed by Martin *et al.*, 2003).

Due to the low abundance of R proteins in plant cells the patterns of protein-protein interactions of R protein-mediated recognition of effectors are largely unknown. An important model for these interactions is named as “guard” hypothesis whose essential concept is the recognition of an effector-taking place indirectly as recognition of an interaction of that effector with a target of its virulence function (See Fig: 2, 3). When guard is absent, plant defense is somehow down-regulated by interaction of the effector and its target. This releases nutrients to the apoplast or contributes to pathogenesis. For plant- pathogen systems in which guard model can apply, new members of R protein recognition complexes might be uncovered by identification of host targets or virulence factors.

The second model is the simplest model interpreting the gene-for-gene hypothesis. In this model R protein and Avr protein directly interact and activate the defense mechanism. However, there has been no evidence showing the direct interaction of effectors with R proteins.

In the third model named as Bridge model, binding of the effector independently to the R protein and to a third protein recruits one to another. Downstream signaling for defense is activated by the effector-dependent interaction of the two proteins. In order to

confirm this model, interaction of the effector with both plant proteins by means of distinct domains has to be shown.

The fourth model is called the Matchmaker that proposes that effector induces direct interaction between the R protein and a third protein by a conformational change in one or both of the proteins.

In Affinity Enhancement model the interaction of the effector with the R protein, a third protein or both stabilize a pre-existing, weak interaction between the two plant proteins. The downstream signaling is then activated by the increased abundance of the complex and defense response is induced.

The Derepression model proposes that the effector disrupts an interaction of the R protein and the effector derepresses a third protein that negatively regulates the activity of the R protein and by this way defense response. In order to apply this model to a given system, there must be the interaction of the R protein and a third protein and down regulation or mutagenesis of the third protein should activate defense in the absence of the effector.

In the last model, which is called the Dual Recognition, model independent interactions between the effector and the R gene and the third protein are required for the resistance (Reviewed by Martin *et al.*, 2003)

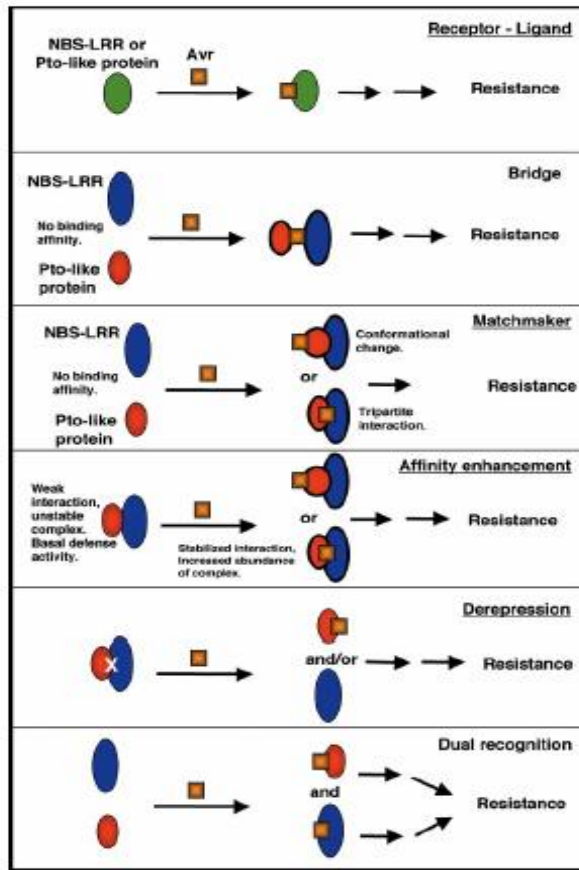

Figure 2.3: Models for protein-protein interactions that might underlie plant-pathogen “gene-for-gene” recognition. Models that encompass interactions that could be consistent with the “guard” hypothesis are underlined (Martin *et al.*, 2003).

## 2.2 Resistant and Susceptible Host Responses

Upon recognition of an avirulence protein, a signal transduction cascade that leads to the induction of a number of plant defenses, which either directly or indirectly inhibit pathogen growth and multiplication, is activated. These defenses involve the hypersensitive response (HR), ROS generation, cell wall fortification, benzoic acid and salicylic acid accumulation, pathogenesis-related (PR) and other defense related protein induction, lipoxygenase enzyme activity increase and phytoalexin accumulation (Hammond-Kosack and Jones, 1996) (See Fig:2.4).

Within minutes of pathogen attack, local plant defense responses are activated. Sometimes defense responses also arise in tissues far from the invasion site and even in

neighboring plants within hours of infection. Pathogens activate systemically a specific subset of PR (Pathogenesis-related)-type genes by a mechanism known as “Systemic Acquired Resistance” (SAR). In order to confer SAR, necrotic lesions must form due to the initial infection as a part of Hypersensitive Response (HR) or as a symptom of disease (Buchanan, Gruissem, Jones, 2000). Although the exact mechanisms are not known in detail, lignifications, induction of PR proteins and conditioning are the basic mechanisms involved in SAR. Lignification causes the strengthening of cell walls so that plant cells become more resistant to enzymes of pathogens. During SAR, *PR-1*, *PR-2* and *PR-5* transcripts were found to be accumulated in *Arabidopsis thaliana* and tobacco. PR proteins which are activated during SAR are different than the ones in HR and are therefore named as systemically induced (SAR) proteins. Although the exact function is not known, plants whose PRs are activated have shown increased resistance to pathogens. Several studies have shown that pathogen pretreated plants react more rapidly and more efficiently to a challenge by second infection. In these manners, SAR similar to immunization in mammals, is specific for broad range of pathogens, and is important as much as the innate immune response of plants (Reviewed by Sticher *et al.*, 1997).

Pathogen infection is generally unlikely to result in a diseased plant. There are four main reasons for failure of pathogens to infect plants successfully. These are: pathogens are generally recognized in the plant as nonhost which prevents the support of the life-strategy requirements of the pathogen; nonhost resistance of the plant which possess a preformed structural barrier or toxic compound oppose the pathogen infection; defense mechanisms activated upon recognition of the attacking pathogen and environmental changes that kill the pathogens whereas plants have already adapted to these changes and can survive. As mentioned before, pathogen infection can be sensed by the plant, which subsequently activates its defense responses. One of the most important responses given by the plant is the rapid activation of defense reactions in association with host cell death and called the “Hypersensitive Response (HR)”. Since dead cells contain high levels of antimicrobial, antifungal and antiviral molecules they are not subsequently attacked by pathogens anymore. Moreover, protective secondary metabolites can also be synthesized and cell walls can be reinforced around the HR site so that pathogen is controlled at the area of infection. HR is programmed genetically in

the plant and is a consequence of new host transcription and translation (Buchanan, Gruissem, Jones, 2000).

One of the best-characterized plant response mechanisms upon a pathogen infection is Pto-mediated resistance to bacterial speck disease in tomato caused by the bacterial pathogen, *Pseudomonas syringae* pv.tomato. In this model, a transcription factor Pti4 is activated when the pathogen attacks the plant (Gu *et al.*, 2000). Pto kinase then phosphorylates the available Pti4 that facilitates its localization into nucleus, DNA binding and interaction with other transcription factors that activate the pathogenesis-related (PR) proteins that control the defense responses (Gu *et al.*, 2002).

The final step of activated events is the death of a single cell or group of cells, even sometimes death of the whole organism in order to prevent the pathogen growth and multiplication. In 1965, Lockshin and Williams were the first to mention the phrase “programmed cell death (PCD)” to describe the activation of suicide pathways in response to external or internal stimuli. Then in 1972, Kerr *et al.* gave the name “apoptosis” in which a distinct morphology was observed in programmed cell death (PCD) mechanism. Currently the term apoptosis is the name given to death of an animal cell that results from genetically ordered series of physiological and morphological events. On the other hand, another death type known as “necrosis” occurs in response to injurious environmental stimuli and is not genetically controlled (Birch *et al.*, 2000). Morphological features of apoptosis in mammals include the chromatin and cytoplasm condensation, nuclear and cellular convolution, cell shrinkage, nucleus disintegration, DNA fragmentation, apoptotic body formation and phagocytosis of apoptotic bodies. (Reviewed by Birch *et al.*, 2000).

A cell suicide pathway is also found to be activated upon recognition of an invading pathogen in plants. This pathway is thought to be involved in defense mechanisms against infection. *AvrRpt2* gene containing *Pseudomonas syringae* has been found to interact with *Rps2* gene of *Arabidopsis thaliana* triggering the coordinated activation of cell death and defense mechanisms including activation of PR proteins (Mittler *et al.*, 1997).



Plants have been found to confer similar morphological features of apoptosis in animals. Nuclear fragmentation and formation of membrane-bound structures similar to apoptotic body formations of animals have been observed in response to tomato toxin (Wang, 1996). Moreover, cytoplasm and nucleus condensation was observed in tobacco plants during PCD upon virus infection (Mittler *et al.*, 1997).

Similar to mammals, cysteine proteases have been identified in cell death responses in development of plants (Jones *et al.*, 1996). The presence of similar NBS domains in the proteins Apaf-1 and R genes (Van Der Biezen and Jones, 1998); and detection of a Bcl-2 homologue localized into mitochondria, chloroplasts and nuclei in tobacco (Dion *et al.*, 1997) proposes that similar programmed cell death mechanisms can be involved in defense mechanisms of both plants and animals.

### **2.2.1 Similarities of PCD between Plants and Animals**

Protein phosphorylation in which Mitogen-activated protein kinase (MAPK) cascades are found to be important in apoptosis of animal cells (Jarpe *et al.*, 1998). R gene also has been found to contain a serine-threonine kinase domain which can be used for phosphorylation of downstream transcription factors and PR proteins (Zhou *et al.*, 1997). Salicylic acid inducible protein kinase (SIPK) a MAPK activated by salicylic acid has been shown to be activated by Tobacco mosaic virus (TMV) infection in plants (Zhang and Klessig, 1998). Another MAPK from tobacco called WIPK- wound inducible protein kinase- is also found to be induced by TMV (Zhang and Klessig, 1998) show that MAPK are also found to be important in PCD of plants.

Increases of extracellular Ca<sup>2+</sup> levels in response to pathogen attack (Suzuki *et al.*, 1995; Levine *et al.*, 1996) suggests that Ca<sup>2+</sup> plays an important role in signaling defense responses leading to cytochrome c is released from mitochondria, which is the universal feature of apoptosis in mammals (Krebs,1998). Cytosolic calcium levels have an impact on signaling cascades by activating protein kinases and protein phosphatases to promote modification of proteins involved in PCD of plants (Buchanan, Gruissem, Jones, 2000).

Another striking feature of apoptosis is the accumulation of radicals such as  $O^{2-}$  and  $H_2O_2$  that are known as reactive oxygen species (ROS) that leads to the oxidative burst of the cells in order to prevent pathogen growth.  $O^{2-}$  and  $H_2O_2$  have been detected in tobacco leaves when infected with TMV and necrotic lesions were induced in these plants (Doke and Ohashi, 1988).

### 2.2.2 Secondary Signaling Molecules in Plant Defense Responses

Secondary signaling molecules including Salicylic acid (SA), ethylene, and jasmonic acid (JA) have been found to be involved in plant defense responses (Reviewed by Yang *et al.*, 1997). NahG phenotype of tobacco and *Arabidopsis thaliana* plants which has lost the ability to accumulate SA have been shown to exhibit poor induction of PR genes and have been more susceptible to normally avirulent pathogens (Gaffney *et al.*, 1993; Delaney *et al.*, 1994). Jasmonate has been implicated in plant responses to wounding and insect feeding (Reymond *et al.*, 2000). The perception and signal transduction of Jasmonate is not fully known yet. COI1 gene encoding an F-box protein is the only cloned defense regulator gene in Jasmonate response (Xie *et al.*, 1998).

Ethylene perception and signal transduction is the best-known pathway in plant growth and development. Ethylene receptors have been found to be similar to bacterial two-component histidine kinase receptors. When ethylene is absent, the downstream negative regulator CTR1 that functions as a MAPKKK represses ethylene receptors ETR1, ERS1, ETR2, EIN4 and ERS2. Binding of ethylene inhibits receptor activation of CTR1 by inhibition or promotion of histidine autophosphorylation. Absence of CTR1 activates C-terminus of another protein called EIN2 whose subcellular location is not known yet. Activation of EIN2 then activates several transcription factors, which are either ethylene-responsive element binding proteins (EREBP) or ethylene-response-factors (ERF) that bind to the GCC box promoter element of ethylene-regulated genes (Reviewed by Chang and Shockey 1999).

Potentiation experiments that imply the increase of magnitude and kinetics of defense responses associated with different pathways suggest that there might be a cross talk between SA, ET and JA signaling. ET has been found to potentiate the SA-mediated induction of PR-1 gene expression in *Arabidopsis thaliana* (Lawton *et al.*, 1994), *PR-1* transcripts of tobacco have been superinduced upon treatment of SA, and Methyl JA compared to single effects of these molecules (Xu *et al.*, 1994).

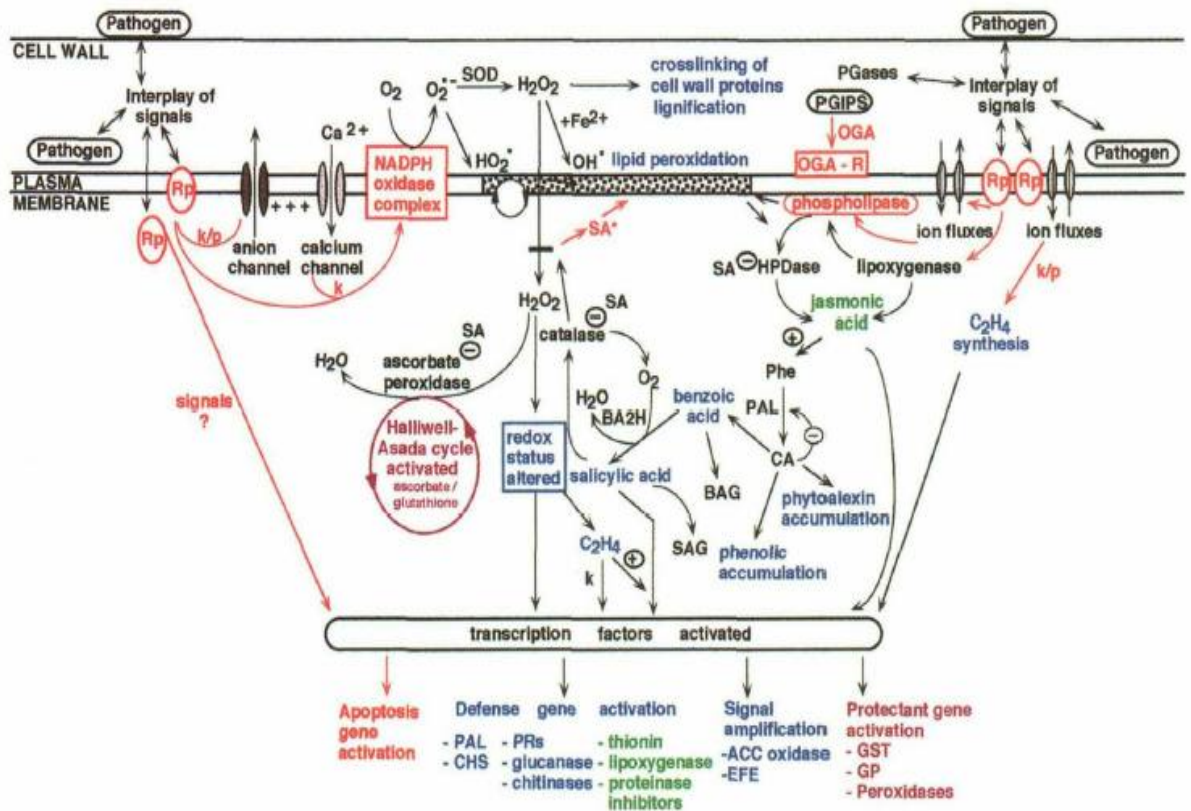

Figure 2.4 Complexity of Signaling Events Controlling Activation of Defense Responses. (Hammond-Kosack and Jones, 1996)

### 2.3 Viruses and Viral Pathogenicity

As being simple, acellular viruses are a unique group of infectious agents. A complete virus particle consists of one or more molecules of DNA or RNA but not together at the same time (except human cytomegalovirus containing a DNA genome and four mRNAs); carbohydrates; lipids and additional proteins. In extracellular phase

(called virions), viruses cannot reproduce independent of living cells. They exist primarily as replicating nucleic acids that induce host metabolism to synthesize virion components in the intracellular phase and eventually complete virus particles or virions are released from the host.

All virions are constructed around a nucleocapsid core which is composed of a nucleic acid (either DNA or RNA) and held within a protein coat called the capsid.

Viruses can employ all four possible nucleic acid types: single-stranded DNA, double-stranded DNA, single-stranded RNA and double-stranded RNA. Plant viruses generally have single-stranded RNA genomes. Most RNA viruses contain single-stranded RNA (ssRNA) as their genetic material. The RNA strand is called the plus strand or positive strand when RNA base sequence is identical with that of viral mRNA, called minus or negative strand when the viral RNA genome is complementary to viral mRNA. Most of the RNA viruses are known to contain segmented genomes meaning that the genome is divided into fragments each coding for one protein.

An outer membrane layer called an envelope bound many viruses. Sometimes envelope proteins might project from the envelope surface as spikes or peplomers. These spikes are thought to be involved in virus attachment to the host surface.

Although viruses lack true metabolism and can not reproduce independently of living cells they may carry one or more enzymes such as an RNA-dependent RNA polymerase that serves as a replicase and RNA transcriptase, essential to completion of their life cycles (Prescott, Harley and Klein, 2002).

### **2.3.1 Host Defense Responses against Viruses**

Viral infection occurs when the virus enters into the host cell, replicates its genome and moves into the neighboring cells and through the plant by its vascular system (Carrington *et al.*, 1996).

Upon viral infection, plants give responses such as hypersensitive cell death response, systemic acquired resistance and gene silencing (Baker *et al.*, 1997, Waterhouse *et al.*, 2001). A microarray research has shown that invasion of different types of viruses induce genes involved in plant defense including the resistance genes, cell rescue, cell death and ageing, signal transduction such as protein kinases and transcription such as DNA-binding proteins and Transcription factors in *Arabidopsis thaliana* (Whitham, 2003).

Virus interactions with plant resistance genes can best explained by Rx-mediated resistance against potato virus X (PVX). Upon recognition of the PVX, coat protein, which is the elicitor by Rx receptor, mechanisms to suppress accumulation of the virus including Hypersensitive Response start (Bendahmane *et al.*, 1995).

One of the most important cellular antiviral responses discovered in mammalian systems is the Interferon-Induced Protein Kinase (PKR). PKR is the critical element of IFN-induced cellular antiviral response. RNA-activated Protein Kinase (PKR) is constitutively expressed in all mammalian tissues at low levels and is composed of an NH<sub>2</sub>-terminal regulatory domain and a COOH-terminal protein kinase catalytic domain (See Fig:2.5). It has been found that PKR is rapidly activated upon binding double-stranded RNA (dsRNA) via its two NH<sub>2</sub> regulatory domain-binding motifs (dsRBM). Upon activation, PKR undergoes conformational alteration and dimerization process that triggers its catalytic activities. PKR is found to be involved in growth factor and calcium-mediated signal transduction, regulation of transcription and induction of apoptosis. However, the most important function of PKR that is targeted for regulation by viruses is the control of mRNA translation initiation mediated through the phosphorylation of translation initiation factor eIF-2 $\alpha$ . Binding of viral-encoded or cellular dsRNAs to PKR activates PKR and autophosphorylation following dimerization of PKR takes place. Activated PKR phosphorylates eIF-2 $\alpha$ . This blocks eIF-2-B by exchanging GDP with GTP and eIF-2 stays inactive in a complex with GDP. As a result, viral replication is blocked at the level of protein synthesis. PKR is also found to contribute to regulation expression of IFN-inducible genes by phosphorylation of I $\kappa$ B (Reviewed by Gale Jr and Katze, 1998) (See Fig: 2.6).

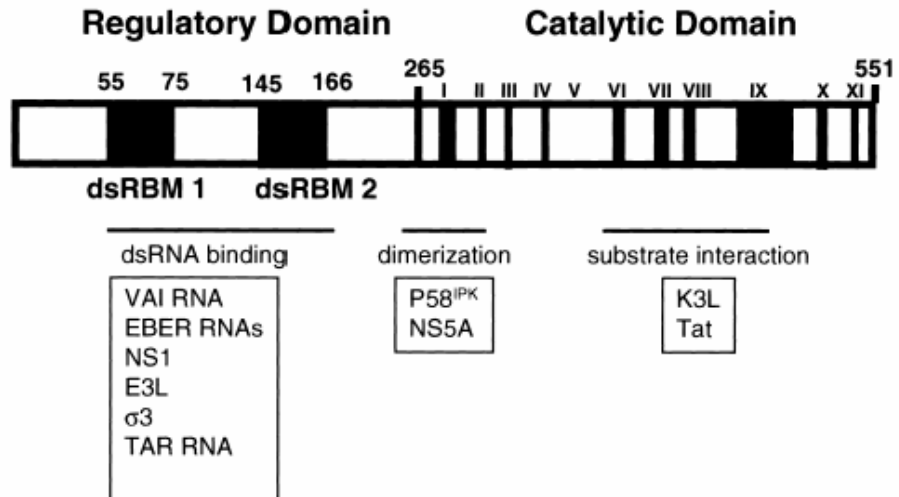

Figure 2.5: Structural representation of mammalian PKR and target sites for viral-directed PKR inhibition (Gale Jr and Katze, 1998)

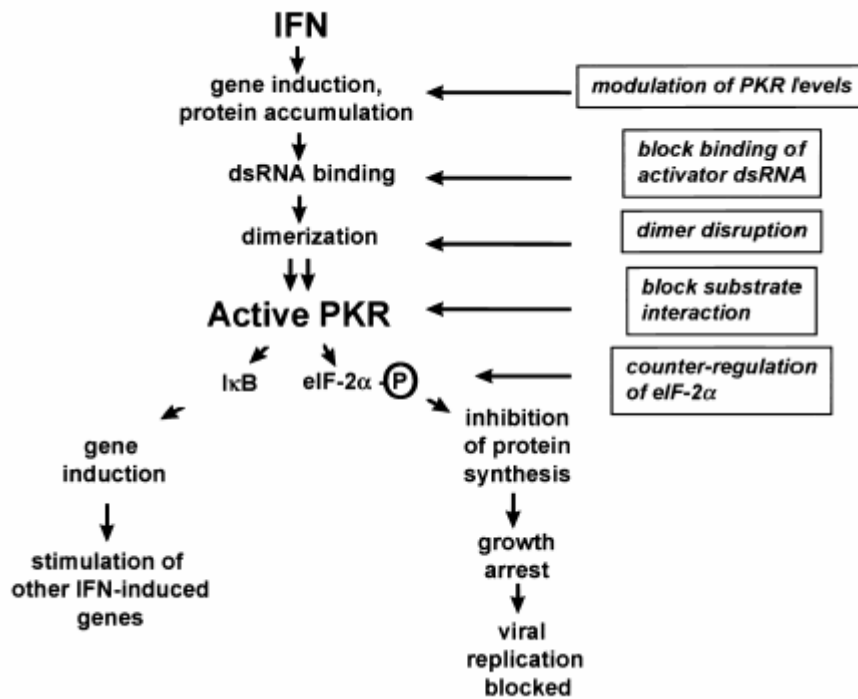

Figure 2.6: Mammalian PKR maturation pathway and sites of viral-directed regulation (Gale Jr and Katze, 1998)

Many viruses have developed strategies to block PKR function in order to avoid deleterious effects upon viral replication due to PKR-mediated eIF-2 $\alpha$  phosphorylation. (See Fig: 2.6). These are, inhibitors binding to conserved dsRNA binding domains or sequestering RNA activators and therefore interfering with the dsRNA-mediated activation of PKR; inhibitors interfering with kinase dimerization; inhibitors blocking the kinase catalytic site and PKR-substrate interactions; inhibitors altering the physical levels of PKR and finally inhibitors regulating eIF-2 $\alpha$  phosphorylation or components downstream from eIF-2 $\alpha$ . Between these blocking strategies, influenza virus that results in the activation of inhibitor of PKR (P58IPK) uses the most interesting one. P58IPK is a member of tetratricopeptide repeat (TPR) family of proteins that possess 9 tandemly arranged TPR motifs known to mediate homotypic and heterotypic protein-protein interactions. P58IPK is found to be constitutively expressed but resides in an inactive complex with specific inhibitory molecules (I-P58IPK) in uninfected mammalian cells. Influenza virus infection disrupts the P58IPK/ I-P58IPK complex and activates P58IPK. Activated P58IPK forms a complex with PKR and results in inhibition of both PKR phosphorylation and activity (Reviewed by Gale Jr and Katze, 1998).

Biochemical and immunological comparisons have shown a cytosolic and ribosome associated protein named as pPKR similar to mammalian PKR is present in plants (Langland *et al.*, 1995). Another study showing wheat eIF2 $\alpha$  can act as a substrate for PKR and functionally interacts with mammalian eIF2 $\alpha$  phosphorylation pathway (Gil *et al.*, 2000).

Recently a plant ortholog of P58IPK is found to be functioning in viral pathogenesis in plants. Massive cell death observed in wild-type Nb P58IPK silenced *N.benthamiana* plants when challenged with Tobacco mosaic virus (TMV) and tobacco etch virus (TEV) imply that plant P58IPK protein is required for development of viral symptoms since death has not been induced in TMV and TEV infected wild-type *N. benthamiana* and *Arabidopsis* plants. Increased levels of phosphorylated eIF-2 $\alpha$  upon viral infection in the NbP58IPK –silenced plants and rescuing of P58IPK –silenced plants by *Bos taurus* P58IPK Bt P58IPK expression from virus infection shows that PKR might function in virus infection of plants like mammalian systems (Bilgin *et al.*, 2003). Yeast-two-hybrid screen has shown that plant P58IPK interacts with a

transcription factor which is thought to be involved in virus susceptibility (Bilgin, unpublished data).

## 2.4 Transcription Factors

Transcription factors are proteins that modulate the rate of initiation of mRNA synthesis by interacting with the promoter regions of target genes through sequence-specific binding of DNA. Transcription factors function in gene transcription regulation depending on the tissue, cell type in response to internal or external signals. Transcription factor activity can be regulated by cellular concentrations of regulatory proteins transcriptionally or by phosphorylation, acetylation, hydroxylation, nitrosylation, glutathiolation, intra- and intermolecular S-S bridge formation, myristoylation, farnesylation, ubiquitination or glycosylation post-transcriptionally. By this way protein conformations may be altered, interaction with other regulatory proteins can be allowed or subcellular localization can be affected. These changes then affect DNA binding, affinity, activation potential, nuclear localization and /or protein stability (Reviewed by Vom Endt *et al.*, 2002). ORFeome analysis of *Arabidopsis* transcription factors have shown that transcription factor genes are highly expressed in vegetative organs, flower organs and germinating seed showing the importance of transcription factors in developmental and metabolic processes (Gong *et al.*, 2004). Overexpression analyses have shown that TFs are involved in many processes such as development, hormone action, biotic stress resistance, abiotic stress resistance and biochemistry of plants (Reviewed by Zhang, 2003).

APETALA 2(AP2) is a member of a complex system of genes that regulate *Arabidopsis* flower initiation and development. It plays a central role in the gene network controlling *Arabidopsis* flower homeotic gene expression, flower development and seed coat development. It has been found that AP2 is expressed in nonfloral and floral tissues and organs in *Arabidopsis* and encodes a polypeptide of 432 amino acids containing a 68-amino acid repeated motif called the AP2 domain. AP2 domain is necessary for AP2 genetic functions such as floral meristem identity establishment,



sepal and petal organ identity specification and the spatial control of AG homeotic gene expression. This domain has been found to contain an 18-amino acid conserved core region, which can theoretically form an amphipathic  $\alpha$ -helix. Protein-protein interactions are mediated by these amphipathic  $\alpha$ -helices through formation of coiled-coil structures. Due to the interactions of AP2 with AP1 and LFY that function in nucleus and role in regulation of AG gene expression AP2 protein is hypothesized to function as a nuclear transcription factor (Jofuku *et al.*, 1994).

Several genes that encode AP2 domain containing proteins are found in *Arabidopsis* and tobacco and characterization of these genes have revealed that AP2 domain has been evolutionarily conserved in both *Arabidopsis* and tobacco. There has been found to be two subfamilies of AP2 domain containing proteins in *Arabidopsis* designated as AP2-like and EREBP-like and both proteins have been found bind to DNA in a sequence specific manner. It is also shown that AP2 domain is sufficient for binding of EREB-like proteins to DNA.

Expressions of EREB-like proteins in floral and vegetative tissues, indirect or direct regulation of gene expression by AP2 during reproductive and vegetative development and presence of AP2-domain containing proteins in maize, rice, castor bean and several members of the *Brassicaceae* strongly suggests that AP2 domain is an important and evolutionarily conserved element necessary for the structure and function of EREB-like and AP2 like proteins (Okamuro *et al.*, 1997)

Induction of aba (Abscisic acid-deficient) and abi (Absisic acid-insensitive *Arabidopsis* mutants) genes by drought, salt and cold suggests the existence of an Absisic acid (ABA)-independent pathway leading to rapid responses to drought or cold. This pathway functions through members of the AP2/EREBP family of transcription factors that recognize the drought-responsive element (DRE) in their target promoters. Many of the AP2/EREBP transcription factors are found to be functioning in plant development and hormone-dependent gene expression. AP2/EREBP family proteins contain a highly conserved region of about 60-70 amino acids called the AP2 domain which makes them unique to plants. AP2 domain with its 2 regions : a 20 amino acid long N-terminal stretch rich in basic and hydrophilic residues (YRG element) and a C-

terminal sequence that can form an amphipathic  $\alpha$ -helix (RAYD element) is a new type of DNA-binding module. YRG element is thought to be the element responsible for DNA binding and RAYD element is believed to contribute to DNA interaction or mediate protein-protein associations (Reviewed by Kizis *et al.*, 2001).

A number of common cis-acting elements and their cognate binding factors have been identified by functional dissection of PR (pathogen-responsive) gene promoter regions. Several of the PR genes have been found to contain a GCC box in their promoter regions.

Transcription factors that bind to the GCC box (TAAGAGCCGCC) of PR genes are specifically called as Ethylene-responsive element binding proteins were first isolated from tobacco and later renamed as Ethylene response factors (ERFs). ERF domain was believed to be closely related to AP2 domain. However, in 2000 Ohme-Takagi *et al.* has shown that ERFs possess a highly conserved DNA binding domain with a novel and unique form of DNA recognition. ERFs from different taxa all share common features such as being induced by biotic and abiotic stresses and mediating the expression of GCC box-containing genes. A novel research has shown that activated disease resistance 1 (ADR1) gene that confers broad-spectrum disease resistance is also involved in drought-resistance of *Arabidopsis* plants. This result proposes that there are shared multiple nodes in both biotic and abiotic signaling pathways and the outputs of these pathways may functionally overlap in a significant manner (Chini *et al.*, 2004).

ERFs isolated from tomato -Pti 4, Pti 5 and Pti 6- interact with tomato *Pto* resistance gene and bind to the GCC box *cis* element. Moreover, Pti 4/5/6 have been found to be localized to nucleus and *Arabidopsis* cells. ET-regulated PR genes were found to be activated by the expression of Pti 4 in *Arabidopsis* suggesting that Pti 4 might regulate the expression of genes in the ET signaling pathway. Plants overexpressing *Pti4/5* and *6* have been found to show increased resistance to pathogens. Gu *et al.* suggest a model for the role of Pti 4 in PR Gene Expression proposing that *Pti 4* gene activated upon pathogen attack produces the substrate for Pto kinase phosphorylation. The phosphorylated Pti 4 is then localized into nucleus and binds to DNA and/ or interacts with other transcription factors. This activates different subset of

PR genes and provides the plant with control of the defense responses. It is also hypothesized that Pti 4 may play a role in mediating the communication between SA and ET/JA signaling pathways (Gu *et al.*, 2000).

## **2.5 A novel AP2 domain TF from tomato**

A novel AP2 domain TF (JERF1) from has been isolated from tomato *Lycopersicon esculentum* and is supposed to be responsive to stress. This particular transcription factor contains an AP2 DNA binding domain, a conserved DNA binding domain, a basic region in its N-terminal region that might function as a nuclear location signal, and an acidic C-terminal region that might act as an activation domain for transcription. It may specifically interact with GCC-box. There has been no published data in literature for the role of JERF1 showing its role in virus susceptibility or resistance. Plant P58IPK like was found to interact with a partial clone of JERF1 in a yeast-two hybrid screen (Bilgin, D.D Unpublished data). Based on the interaction with plant P58IPK and sequence characteristics of JERF1 it is suggested that JERF1 might be involved in plant-virus interaction.

## **2.6 Aim of the study**

The aim of this study is to clone and characterize the *JERF1* gene from tomato *Lycopersicon esculentum*, to analyze its role in tobacco mosaic virus susceptibility of plants and to detect the subcellular localization of the JERF1 protein.

## **3 MATERIALS AND METHODS**

### **3.1 Materials**

#### **3.1.1 Chemicals**

All chemicals were supplied by Fluka (Switzerland), Merck (Germany), Riedel de Hën (Germany), and SIGMA (USA).

#### **3.1.2 Primers**

Primers were designed according to the *Lycopersicon esculentum* transcription factor *JERF1* gene (TIGR; TC 124207) and synthesized by Proligo (France), Iontek (Turkey) and SeqLab (Germany). The sequences of the primers used are given in Appendix A.

#### **3.1.3 Enzymes**

##### **3.1.3.1 Restriction enzymes**

*EcoRI*, *NotI*, *SacI*, *Hind III*, *XbaI*, *BamHI*, *KpnI* (Promega and Fermentas)

### **3.1.3.2 Ligase**

T4 DNA Ligase (Fermentas)

### **3.1.3.3 Taq Polymerase**

Expand High Fidelity PCR System (Roche), Taq Master mix (QIAGEN)

### **3.1.3.4 Reverse Transcriptase**

Omniscript Reverse Transcriptase (QIAGEN)

## **3.1.4 Commercial Kits**

Qiaquick<sup>®</sup> Gel Extraction Kit (250) (QIAGEN)

Qiaprep<sup>®</sup> Spin Miniprep Kit (250) (QIAGEN)

QIAGEN<sup>®</sup> Plasmid Midi Kit (100) (QIAGEN)

TOPO<sup>®</sup> TA Cloning Kit (Invitrogen)

## **3.1.5 Vectors**

Maps of all vectors can be found in Appendix B.

pCR<sup>®</sup>-II-TOPO4<sup>®</sup> (Invitrogen)

pGR106

pTRV2

pJG4-5

pTBSI

pRTL2-GUS/NIaΔBam

pEGKG

pDONR-221<sup>®</sup> (Invitrogen)

GFP-N-Bin was kindly donated by Dr. John Doonan (John Innes Centre, Norwich, UK).

GFP-C-Bin was kindly donated by Dr. John Doonan (John Innes Centre, Norwich, UK).

### **3.1.6 Cells**

*E.coli* strains TOP10, DH5 $\alpha$ , *Agrobacterium tumefaciens* LBA4404.pBBR1MCS virGN54D, yeast EGY 48, yeast RFY206, *Arabidopsis thaliana* suspension culture, and BY2 suspension culture.

### **3.1.7 Buffers and solutions**

All buffers and solutions, except those provided with commercial kits, were prepared according to Sambrook *et al.*, 2001. Buffers, their compositions and preparations are presented in Appendix C

### **3.1.8 Culture medium**

#### **3.1.8.1 Liquid medium**

LB (Luria-Bertani) Broth from SIGMA was used to prepare liquid culture media for bacterial growth.

#### **3.1.8.2 Solid medium**

LB (Luria-Bertani) Agar from SIGMA was used for the preparation of solid culture media for bacterial growth.

#### **3.1.8.3 Yeast SC (Synthetic Complete) Medium**

1, 5 g Yeast Nitrogen Base (without ammonium sulfate and amino acids)

5.0 g ultra pure ammonium sulfate

2.15 g complete amino acids stock mixture

20 g dextrose

20 g agar (only for solid medium)

Add ddH<sub>2</sub>O to 1 liter

Medium was autoclaved and stored at 4<sup>0</sup>C

#### **3.1.8.4 YPD Medium**

10 g yeast extract

20 g peptone

20 g glucose

2% agar

Add ddH<sub>2</sub>O to 1 liter

Medium was autoclaved and stored at 4<sup>0</sup>C

#### **3.1.8.5 AT Medium**

4.4 g MS media

30 g sucrose

0.05 mg kinetin

0.5 mg NAA, pH 5.8

Add ddH<sub>2</sub>O to 1 liter

Medium was autoclaved and stored at 4<sup>0</sup>C

#### **3.1.9 Sequencing**

Sequencing service was commercially provided by SEQLAB (Germany) and Iontek (Turkey).

### **3.1.10 Equipments**

List of all the equipments used during this study are presented in Appendix E.

## **3.2 Methods**

### **3.2.1 Plant growth**

*Lycopersicon esculentum* seeds were sprinkled down into wet perlite and left 2 days for vernalization. After 2 days they were incubated at 24<sup>0</sup>C, in dim light for germination. After germination the incubation was done at 24<sup>0</sup>C for 16 hours light and 8 hours dark. Seedlings emerge within 2 weeks time and then they are transferred into soil which is mixed with perlite in a ratio of 1:2 (1 units of perlite, 2 units of soil). Hormone mixture was added to the soil and plants were watered 3 times a week. Leaf tissues were collected for sampling by cutting them with clean scissors and frozen in liquid nitrogen. Tissues were stored at -80<sup>0</sup>C until RNA isolation.

### **3.2.2 RNA isolation from the plant**

2 gr of leaf tissue was grinded for RNA isolation. Solution D was added and the tissues were homogenated by baked mortar and pestle. Homogenates were taken into a RNase free falcon. 2ml of 2M sodium acetate (pH 4.0) and 16 ml of water-equilibrated phenol was added onto the homogenates and vortexed. 4 ml of chloroform was added and falcons were vortexed and left on ice for 15 minutes. Samples were then centrifuged at 6000rpm for 30 min at 4<sup>0</sup>C. The upper, aqueous phase which contains the RNA was transferred to a new tube by 25 ml RNase free pipet taking care to avoid the precipitated material at the layer between two phases that contains the genomic DNA and proteins.

The RNA from the aqueous phase was precipitated by adding 1 equal volume of isopropanol and stored on ice for 1 hour. Samples were then centrifuged at 7500 rpm for



15 minutes at 4 °C in order to pellet RNA. The pellet was washed twice with 70% ethanol, each time followed by centrifugation at 7500 rpm for 2 minutes in order to remove salts which would interfere with subsequent CTAB precipitation by forming a chemical precipitate. RNA was then resuspended in 4 ml of water and 1.3 ml of 5M NaCl was added. 16 ml of CTAB/urea was added which selectively precipitates the RNA. Samples were centrifuged for 15 minute at 7500 rpm and aqueous phase was discarded. RNA pellet was resuspended in 4 ml of 7M GuCL. Resuspended RNA was then precipitated by adding 8 ml of cold ethanol and incubated at -20<sup>0</sup>C for 1-2 hours. Samples were then centrifuged for 15 minutes at 7500 rpm and at the end pellet was washed with 5 ml of 70% ethanol which was then centrifuged again at 7500 rpm for 5 minutes. The supernatant was discarded and RNA was resuspended in 500-1000µl of RNase-free-water. All the equipments for RNA isolation were baked before the procedure at 180<sup>0</sup>C overnight. In order to calculate the RNA concentration, optical density at 260 nm was measured and calculation was done according to the formula:  
Conc. (µg/µl) = OD<sub>260</sub> x 40 x DF

### **3.2.3 Preparation of cDNA from total RNA**

#### **3.2.3.1 GENE RACER™ Invitrogen**

GENE RACER™ Invitrogen allows the amplification of only full length transcript ends by eliminating truncated mRNAs. This technique is based on selective ligation of an RNA oligonucleotide to full length 5' ends of decapped mRNA by using T4 RNA ligase. In this method, first, total RNA isolated from tomato was dephosphorylated by mixing with 1µl of calf intestinal phosphatase (CIP), 1µl of CIP buffer and incubated at 50<sup>0</sup>C for 1 hour. Samples were then centrifuged at 13,000 rpm for 1 minute and placed on ice. 90 µl RNase free H<sub>2</sub>O and 100 µl phenol: chloroform was added onto the samples and was centrifuged for 5 minutes at room temperature at 13,000 rpm. Aqueous phase was transferred to a new tube and 2 µl mussel glycogen (10 mg/ml), 10 µl 3M sodium acetate (pH5.2) and 220 µl 95% ethanol was added and vortexed. Samples were frozen on dry ice for 10 minutes and then centrifuged at maximum speed for 20 minutes at 4<sup>0</sup>C to pellet the RNA. Supernatant was removed and 500 µl 75% ethanol was added and vortexed. Samples were then centrifuged for 2 minutes at 4<sup>0</sup>C and ethanol was removed. Centrifugation was repeated to remove the

remaining ethanol and samples were air dried for 2 minutes at room temperature. Pellet was resuspended in RNase free water. 1  $\mu$ l of 10X tobacco acid pyrophosphatase (TAP) and 2  $\mu$ l TAP was added onto 7  $\mu$ l of RNA and samples were mixed and centrifuged prior to incubation at 37<sup>0</sup>C for 1 hour. Samples were then centrifuged and placed on ice. RNA was precipitated as explained above. After precipitation, 7  $\mu$ l dephosphorylated, decapped RNA was added to the tube containing lyophilized GENE RACER™ RNA Oligo (0.25  $\mu$ g) and sample was pipetted up and down to mix and spinned to be collected at the bottom. Incubation was done at 65<sup>0</sup>C for 5 minutes in order to relax the 2<sup>o</sup> structure of RNA and tubes were placed on ice for 2 minutes and then centrifuged. Subsequently 1  $\mu$ l of 10X Ligase Buffer, 1  $\mu$ l of 10mM ATP and 1  $\mu$ l of T4RNA Ligase was added and samples were incubated at 37<sup>0</sup>C for 1 hour. RNA was precipitated as done in the first step except that pellet was resuspended in sterile water and run on gel.

### **3.2.3.2 RT-PCR**

Qiagen Omniscript Reverse Transcription enzymes and reagents were used and the concentrations for primers and template RNA were determined according to the available manual.

94<sup>0</sup>C, 3 minutes

94<sup>0</sup>C, 1 minute

50<sup>0</sup>C, 1 minute

72<sup>0</sup>C, 45 seconds

72<sup>0</sup>C, 12 minutes

4<sup>0</sup>C, on hold

A total of 35 cycles

### **3.2.4 PCR**

Recommended reaction volumes and final concentrations of the Qiagen Taq Master Mix PCR components were used for PCR reaction mixture.

94<sup>0</sup>C, 2 minutes  
94<sup>0</sup>C, 30 seconds  
53<sup>0</sup>C, 45 seconds  
72<sup>0</sup>C, 90 seconds  
72<sup>0</sup>C, 7 minutes  
4<sup>0</sup>C, on hold  
a total of 35 cycles

### **3.2.5 Isolation of DNA fragments from gels**

DNA fragments were purified from 1% Agarose Gel with Qiaquick<sup>®</sup> Gel Extraction Kit (250) (QIAGEN). DNA fragment was excised from agarose with a clean and sharp scalpel and weighed in a sterile eppendorf tube. 3 volumes of QC buffer were added to 1 volume of gel (100 mg ~ 100 µl) and the tube was incubated at 50<sup>0</sup>C for 10 minutes until the gel slice completely dissolves. 1 gel volume of isopropanol was added to the sample and mixed. Sample was transferred into QIAquick column and centrifuged for 1 minute. The flow-through was discarded. For washing, 0.75 ml of Buffer PE was added and centrifuged for 1 minute. The flow-through was discarded and samples were then centrifuged for an additional 1 minute at 13,000 rpm. QIAquick column was placed into a clean 1.5 ml microcentrifuge tube and DNA was eluted in EB buffer. Elution was done according to the intensity of the DNA on the gel prior to isolation. For increased DNA concentrations, elution was done at 30 µl of EB and for more dilute concentrations, elution was done at 50 µl of EB.

### **3.2.6 Sub cloning into pCR-II-TOPO4 vector**

TOPO TA Cloning<sup>®</sup> Kits provide cloning of PCR products directly from PCR reaction in a rapid and efficient manner. pCR<sup>®</sup> -TOPO vectors included in TOPO TA Cloning<sup>®</sup> Kits contain covalently bound topoisomerase I and 3'-T overhangs so that

PCR products can directly be ligated into the vector so that the need for restriction enzyme digestion and ligation is skipped.

*JERF1* gene was amplified and subcloned into pCR-II-TOPO4 (Invitrogen) vector by mixing 4 µl of insert with 1 µl of vector and 1 µl of salt solution. Mixture was incubated at room temperature for 30 minutes.

### **3.2.7 Subcloning**

Basic procedures were carried out according to Manniatis *et al.*, 1989.

#### **3.2.7.1 Subcloning into plant silencing vectors**

*JERF1* gene was amplified with primers 162 and 163 in order to be cloned into vectors pGR106 and pTRV.

#### **3.2.7.2 Cloning into protein over expression vectors**

*JERF1* gene was amplified with primers 199 and 200 in order to be cloned into vector pRTL2-GUS/NiΔBam.

#### **3.2.7.3 Cloning into protein expression vector:**

*JERF1* gene was amplified with primers 207 and 208 in order to be cloned into vector pEGKG.

### **3.2.8 Gateway Cloning**

Gateway<sup>®</sup> Technology of Invitrogen was used in order to clone *JERF1*. Gateway<sup>®</sup> Technology is a rapid method for cloning one or more genes into any protein expression system. Gene or fragment of DNA is amplified with primers containing *attB* Gateway adapter sequences and directly ligated into a donor vector by the enzyme BP clonase without any need for restriction enzyme digestion to produce sticky or blunt ends and conventional ligation procedures. Once the fragment of gene of interest is inserted into donor vector then this construct is named as entry clone and *ccdB* fragment of the

original donor vector is released as a by-product. Entry clones can then be incubated with Gateway<sup>®</sup> Destination Vectors in order to insert the gene or DNA fragments directly into the destination vector so that an Expression clone is obtained at the end of the reaction which is named as LR reaction. Expression clones can be fitted to any expression needs for further experiments

### **3.2.8.1 Cloning into Gateway Donor vectors**

*JERF1* was amplified with gateway primers BD1 and BD5 in order to be cloned into Gateway Donor Vector pDONR<sup>TM</sup>221 (Invitrogen). Cloning was done via BP reaction by mixing 100ng of DNA with 1.3 µl of BP clonase buffer, 1.3 µl of BP clonase enzyme and 1 µl of vector. Mixture was incubated at room temperature overnight.

### **3.2.8.2 Cloning into Gateway Destination vectors**

In order to ligate *JERF1* into GFP-N-Bin and GFP-C-Bin destination vectors, entry clone which was prepared by BP reaction was first linearized with *PvuI* restriction endonuclease and LR reaction was carried out. LR reaction mixture includes 100 ng of entry clone, 1 µl of vector, 1.3 µl of LR buffer and 1.3 µl of LR enzyme and was incubated at room temperature overnight.

### **3.2.9 Ligation**

PCR amplified and purified *JERF1* containing different restriction enzyme sites were ligated with pGR106, pTRV, pJG4-5, pTBSI, and pRTL2-GUS/NIaΔBam. DNA fragments to be used in ligation were generally purified from agarose gels. Ligation mixture contained 1 µL (10 units) T4 DNA Ligase (Fermentas), 1X ligation buffer (supplied by the manufacturer), approximately 20 ng/ µL DNA with the inserts to vector molar ratio of 1:1 to 5:1 and distilled water. Reaction mixtures were incubated at 16<sup>0</sup>C overnight.

### 3.2.10 Preparation of *E.coli* competent cells

Frozen stock of one *E.coli* strain called DH5 and TOP10 cells were streaked on an LB plate in sterile conditions, and cultured overnight at 37°C. About ten to twelve large colonies were isolated with a loop, inoculated to 250 ml of SOB medium in a 2-liter flask for efficient aeration. The culture was grown to  $A_{600}$  of 0.6 at 18°C, with vigorous shaking (200 - 250 rpm). The flask was removed from the incubator and placed on ice for 10 min. The culture was transferred to two separate sterile centrifuge tubes (250 ml each) and spun at 2500xg for 10 min. at 4 °C. The pellet was suspended in 80 ml of ice-cold TE (Appendix D), incubated in ice bath for 10 min., and centrifuged as done previously. The cell pellet was gently resuspended in 20 ml of TE, and DMSO was added with gentle swirling to a final concentration of 7%. After incubating in an ice bath for 10 min. the cell suspension was dispensed by 0.4l into eppendorf tubes and immediately chilled by immersion in liquid nitrogen. The frozen competent cells were stored at -80°C. At this condition, they can be kept for at least a few months without a detectable loss of competence.

### 3.2.11 Transformation of competent *E.coli* cells

Ligation mixtures were transformed into endonuclease deficient strains of *E.coli* TOP10. 100 µl of cells was mixed with ligation mixtures and left on ice for 30 minutes. Then the mixtures were incubated at 42°C for 90 seconds and taken on ice for 2-3 minutes. 900 µl of LB was added onto the mixture and samples are incubated at 37°C shaking at 300 rpm for 1 hour. 100 µl of mixture was plated onto LB agar containing the proper antibiotics. Remaining 900 µl was centrifuged at 13,000 rpm for 1 minute and 800 µl of supernatant was discarded. Pellet was resuspended in the remaining 100 µl solution and spreaded onto selective LB agar plates. Plates were incubated at 37°C overnight. Positive colonies were selected and grown on liquid LB culture containing the appropriate antibiotic for both preparing glycerol stocks and plasmid isolation.

### **3.2.12 Plasmid isolation**

Plasmid isolation was done with QIAprep<sup>®</sup> Spin Miniprep Kit (250) (QIAGEN). Pelleted bacterial cells were resuspended in 250 µl Buffer P1 and transferred to a microcentrifuge tube. 250 µl Buffer P2 was added and the tubes were gently inverted 4-6 times to mix. 350 µl of N3 buffer was added and mixed immediately by inverting the tube. Tubes were left on ice for 10 minutes and then centrifuged for 10 minutes at 13,000 rpm. Supernatants were applied to QIAprep column and centrifuged for 60 seconds. The flow-through was discarded and column was washed with QIAprep spin column by adding 0.75 ml Buffer PE and centrifuging for 60 seconds. The flow-through was discarded and tubes were centrifuged for 2 minutes to remove the residual wash buffer. QIAprep columns were placed in a clean 1.5 ml centrifuge tube and DNA was eluted with 50 µl of EB buffer.

### **3.2.13 Restriction Enzyme Digestions**

Purified plasmids containing the *JERF1* gene were digested with the appropriate restriction enzymes according to the suppliers' instructions for verification of the presence of the corresponding gene and further cloning experiments.

### **3.2.14 Agarose gel electrophoresis**

Agarose gels were used for DNA analysis at a concentration of 1%. The final concentration of ethidium bromide in the gels was 0.5 µg/mL. The electrophoresis buffer used was 0.5 X TBE. Purified plasmids and digested plasmids were analyzed by agarose gel electrophoresis. Appropriate DNA markers were used for size and concentration determination. In addition, concentration and OD<sub>260/280</sub> ratio were monitored by absorption measurements.

### **3.2.15 Preparation of *A.tumefaciens* competent cells**

A single colony of *A.tumefaciens* was inoculated in 2 ml of LB containing the proper antibiotic at 28<sup>0</sup>C shaking at 250 rpm for overnight. The overnight culture was transferred to 50 ml LB without antibiotic in a sterile flask and incubated at 250 rpm, 28<sup>0</sup>C until the optical density is 0.3. Cultures were spinned in sterile 50 ml screw cap tubes at 4<sup>0</sup>C 3000 g for 15 minutes. The supernatant was then removed and pellet was resuspended in 1ml ice cold, freshly prepared 10mM CaCl<sub>2</sub>. The suspension was kept on ice for some time and 100 µl of aliquots were taken into sterile eppendorf tubes and quick-frozen in liquid nitrogen. Prepared competent cells were stored at -80<sup>0</sup>C.

### **3.2.16 Transformation of competent *A.tumefaciens* cells**

5 µl of plasmid was layered on 100 µl competent *A.tumefaciens* cells while cells were in frozen form and incubated at 37<sup>0</sup>C for 5 minutes. 900 µl LB was added onto the cells and incubated at 28<sup>0</sup>C 250 rpm for 4 hours. Cells were centrifuged for 2 minutes at 12000g to pellet the bacteria. 900 µl from the supernatant was removed and pellet was resuspended in the remaining 100 µl. The suspension was spreaded on LB plates containing the proper antibiotic for selection. The plates were incubated at 28<sup>0</sup>C for 2 days.

### **3.2.17 Transformation of Yeast cells**

Several yeast colonies, 2-3 mm in diameter were inoculated into 1 ml of YPD medium and vortexed to disperse the clumps. Mixture was then transferred into a flask containing 50 ml of YPD and incubated at 30<sup>0</sup>C for 16-18 hours with shaking at 250 rpm until the OD<sub>600</sub> reached 1.5. 30 ml of overnight culture was transferred to a flask containing 300 ml of YPD so that the OD<sub>600</sub> of the diluted culture was 0.2-0.3. Culture was incubated at 30<sup>0</sup>C for 3 hours with shaking at 230 rpm until the OD<sub>600</sub> is 0.4-0.6. Cells were placed in 50 ml tubes and centrifuged at 1,000 g for 5 minutes at room temperature. The supernatants were discarded and cells were resuspended in sterile



distilled water. Cells were pooled into one tube which was then centrifuged at 1,000 g for 5 minutes at room temperature. The supernatant was decanted and cell pellet was resuspended in 1.5 ml of freshly prepared, sterile 1X TE/1X LiAc. 0.1 µg of plasmid DNA and 0.1 mg of salmon sperm carrier DNA was added to a fresh 1.5 ml tube and mixed. 0.1 ml of yeast competent cells were added to each tube and mixed by vortexing. 0.6 ml of sterile PEG/LiAc solution was added to each tube and vortexed at high speed for 10 seconds to mix. Mixture was incubated at 30°C for 30 minutes with shaking at 200 rpm. 70 µl of DMSO was added and mixed by gentle inversion. Heat shock was applied for 15 minutes at 42°C and cells were then chilled on ice for 1-2 minutes. Subsequently cells were centrifuged for 5 seconds at 14,000 rpm at room temperature and supernatant was removed. Cells were then resuspended in 0.5 ml of sterile 1X TE buffer and 100 µl of cells were plated onto SC agar plates with the proper selection. Plates were then incubated up-side-down at 30°C until the colonies appear.

### **3.2.18 Mating Assay**

DB112 construct (pJG4-5+*JERF1*) containing EGY48 and RFY 206 yeast cells and bait plasmids containing RFY 206 yeast cells were grown overnight in YPD liquid medium at 30°C with shaking at 250rpm. The next day 10 µl cultures were streaked onto YPD plates in parallel lines and plates were incubated at 30°C until lines of colonies appear. Yeast cells to be mated were transferred to a fresh YPD plate by velvet so that the streaks from the two plates were perpendicular to each other and the plates were incubated at 30°C overnight. Diploid colonies form where the two strains intersect. Replica from the YPD plate is transferred to the proper selection plates and incubated at 30°C until the interactors grow on these plates.

### **3.2.19 Frozen stocks of cells**

Frozen stocks of *E.coli*, *A.tumefaciens* and yeast cells containing different plasmids with *JERF1* sequence were prepared in 15% glycerol and kept at -80°C.

### 3.2.20 Sequence verification

QIAprep<sup>®</sup> Spin Miniprep Kit (250) (QIAGEN) purified corresponding plasmids containing DNA sequences for *JERF1* were sent for sequence analysis.

### 3.2.21 Surface Sterilization of *N. benthamiana* seeds

¼ of 1.5 ml eppendorf tube was filled with seeds and water was added into the tube and spinned for a short time in order to take away the dust and other stuff by removing the water. 500 µl of 75 % ethanol was added and vortexed for 1.5-2 minutes and spinned down in minispin centrifuge. The ethanol was removed and 500 µl bleach solution (1:1 Bleach-H<sub>2</sub>O + 0.05 of Tween 20) was added. Seeds were vortexed for 5 minutes and bleach solution was removed. This step was repeated and subsequently seeds were rinsed with sterile ddH<sub>2</sub>O for 5 times. 1 ml of 0.4% agarose was added onto the seeds and they were plated on MS medium with a micropipette. Seeds were left at 4<sup>0</sup>C for three days for vernalization and then moved into incubator for germination.

### 3.2.22 Silencing analysis

#### 3.2.22.1 Virus induced gene silencing

Virus induced gene silencing of *N. benthamiana* was done according to protocols given by Liu *et al.* (2002) and Bendahmane *et al.* (2000). *N. benthamiana* plants were grown in pots at 25<sup>0</sup>C under 16 hours light and 8 hours dark. Constructs containing *JERF1* in pTRV2 and pGR106 were transformed into *Agrobacterium tumefaciens* LBA4404.pBBR1MCSvirGN54D chemically. 5 ml cultures were grown overnight at 28<sup>0</sup>C in LB broth containing the proper antibiotics. The next day they were inoculated into 50 ml LB media which included the proper antibiotics, 10 mM MES and 20 µM acetosyringone and culture was grown at 28<sup>0</sup>C overnight. *Agrobacterium* cells were harvested and resuspended in infiltration media which contained 10 mM MgCl<sub>2</sub>, 10 mM MES, 200 µM acetosyringone. Optical density was adjusted to 2.0 and left at room temperature for 3 hours. *Agrobacterium* cells were then infiltrated into plant leaves by using needles.

### **3.2.22.2 Virus challenging**

After 2 weeks from silencing lower leaves of *N.benthamiana* plants were rubbed with 100 µl of Tobacco mosaic virus (TMV) with sterile sponges.

### **3.2.23 Transient transformation of *Arabidopsis thaliana***

*Arabidopsis thaliana* Col0 suspension cultures were subcultured weekly and grown in AT medium. Dilution was done in the ratio of 1:5 in a total of 50 ml (10 ml of suspension culture and 40 ml of AT medium).

Expression vectors containing the *JERF1* gene were transformed into *Agrobacterium tumefaciens* LBA4404.pBBR1MCSvirGN54D chemically. Transformed *Agrobacterium* was grown in 28°C overnight in LB broth containing the proper antibiotics. Upon subculturing of *Arabidopsis thaliana*, 50 µl of *Agrobacterium* was inoculated into suspension cultures of 3 ml and they were incubated for 2 days at 25°C with shaking at 200 rpm.

## 4 RESULTS

### 4.1 Total RNA Isolation from Plant

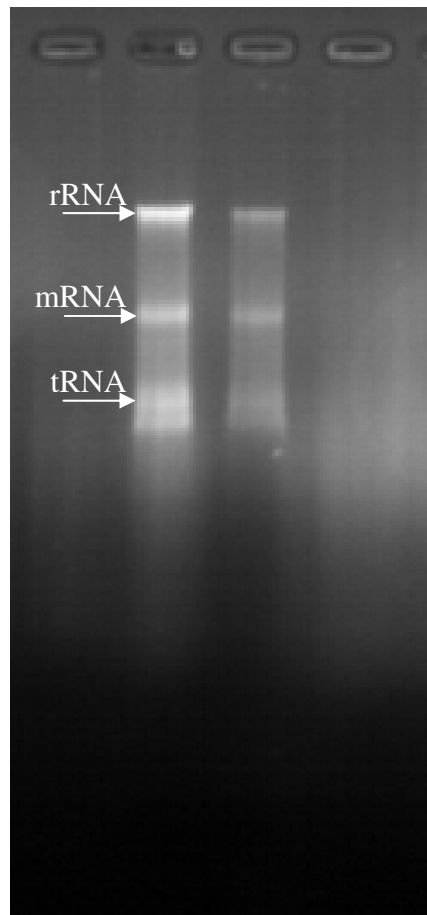

Figure 4.1: 1.2% agarose gel electrophoresis of total RNA isolation from tomato.

Total RNA was isolated from tomato cDNA and ran on 1.2% agarose gel under RNase-free conditions. Three bands corresponding to rRNA, mRNA and tRNA were easily seen on agarose gel.

## 4.2 cDNA Preparation

At first Gene Racer™ Kit from Invitrogen was used for amplification of full-length cDNA ends. However, this method did not give any results.

cDNA from total RNA isolated from tomato was then prepared by QUIAGEN Omniscript® Reverse Transcriptase for cloning experiments.

## 4.3 PCR Amplification of *JERF1* for subcloning

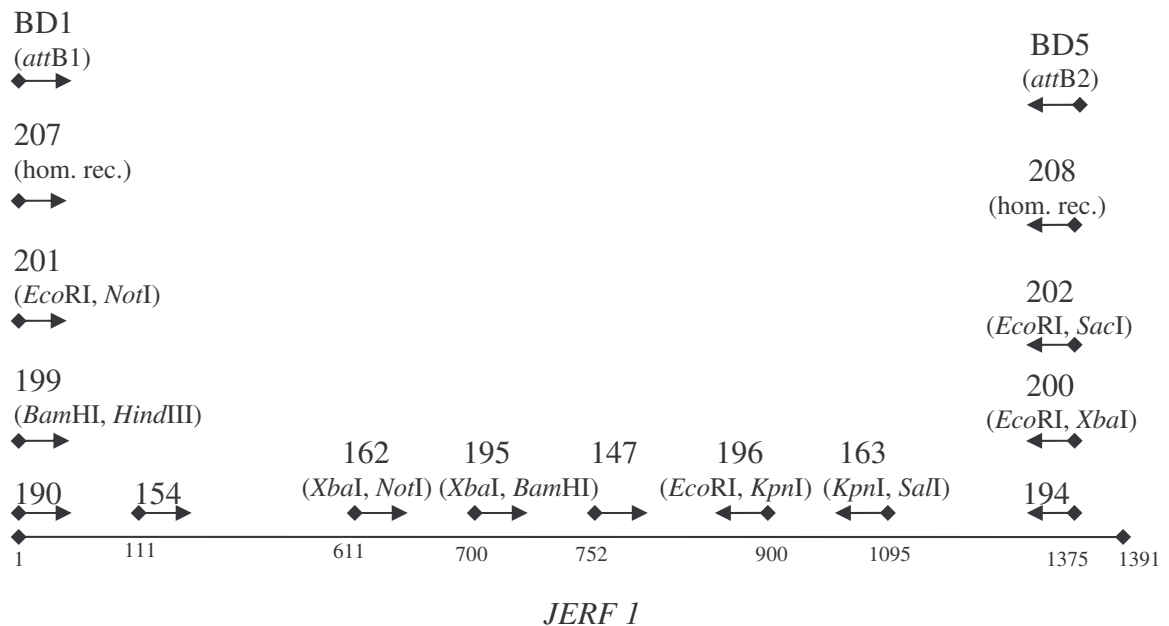

Figure 4.2: Figure showing the primer sites corresponding to *JERF1*

*JERF1* was amplified from tomato cDNA library by using the primers 190 and 194. The sequences of the primers are shown in Appendix A. 190 and 194 were designed according to the sequence of *JERF1* from the 5' end forward and from the

1375th base reverse. Therefore, on 1% agarose gel electrophoresis, a band corresponding to around 1,4 kb is expected. The band obtained from PCR amplification of *JERF1* is shown in figure 4.3.



Figure 4.3: Amplification of *JERF1* from cDNA with primers 190 and 194.

#### 4.4 Subcloning of *JERF1* into various expression vectors

##### 4.4.1 Subcloning to pCR<sup>®</sup>4-TOPO for sequencing

TOPO vector is a “TA” vector. PCR products of *JERF1* were ligated into pCR<sup>®</sup>4-TOPO vector by following the instructions given in the vector manual. pCR<sup>®</sup>4-TOPO

vector was used for rapid cloning and sequencing of *JERF1*. This vector provides the 3'-T overhangs so that PCR products can directly be ligated. *E.coli* Top 10 cells were then transformed with the ligation mixtures so that the plasmid multiplication was achieved. Transformed cells were selected on Ampicillin LB media which is proper for the selection of pCR<sup>®</sup>4-TOPO vector. Next day colony PCR with gene specific primers 190 and 194 was done in order to check the insert (See Fig: 4. 4). The construct prepared was named as DB90.

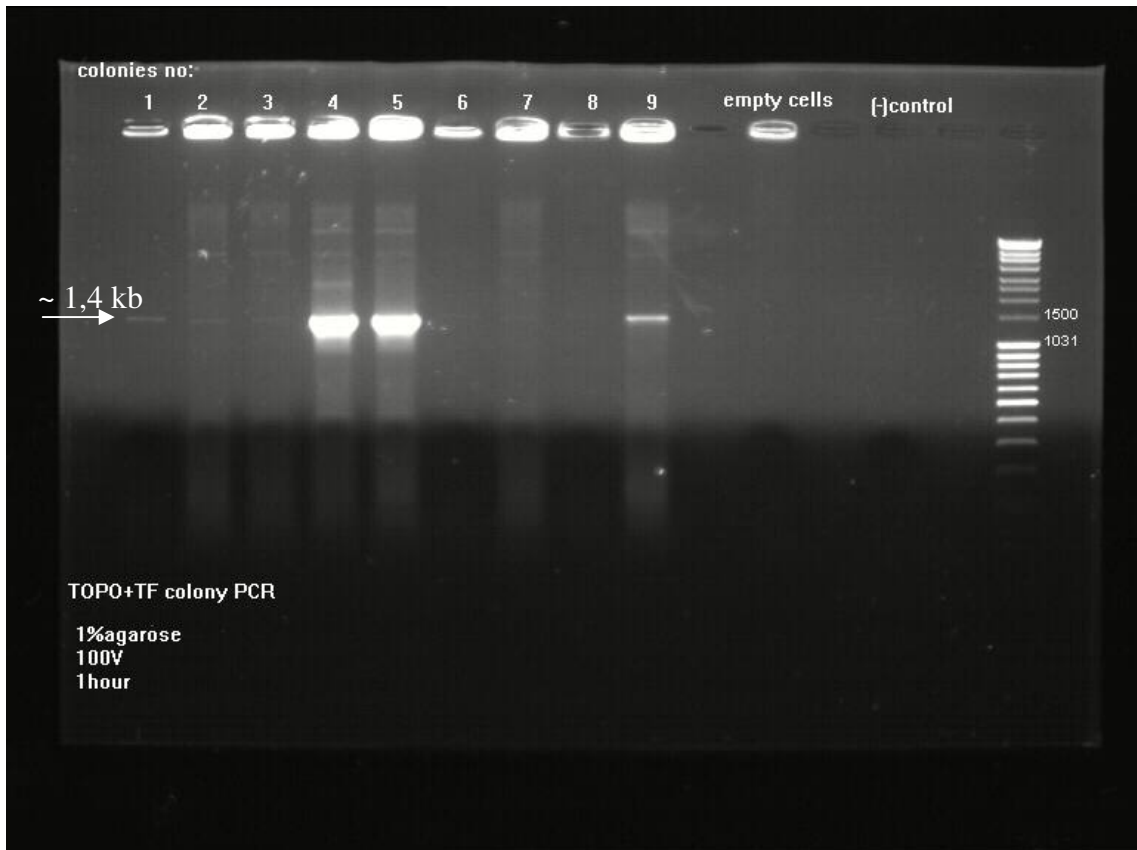

Figure 4.4: Colony PCR of transformed *E.coli* Top 10 cells containing the pCR<sup>®</sup>4-TOPO vector ligated with *JERF1*(DB90)

#### 4.4.2 Verification of the sub cloning of *JERF1* into pCR<sup>®</sup>4-TOPO in *E.coli*

pCR<sup>®</sup>4-TOPO vectors contains *EcoRI* sites flanking the PCR product insertion. Therefore, DB90 was digested with *EcoRI* endonuclease in order to verify the presence of *JERF1* in the construct. *JERF1* does not have any internal *EcoRI* sites. By this

digestion *JERF1* should be cut from the vector pCR<sup>®</sup>4-TOPO which should give a band of 1,4kb corresponding to *JERF1* and 4.0 kb corresponding to the pCR<sup>®</sup>4-TOPO vector (See Fig: 4.5).

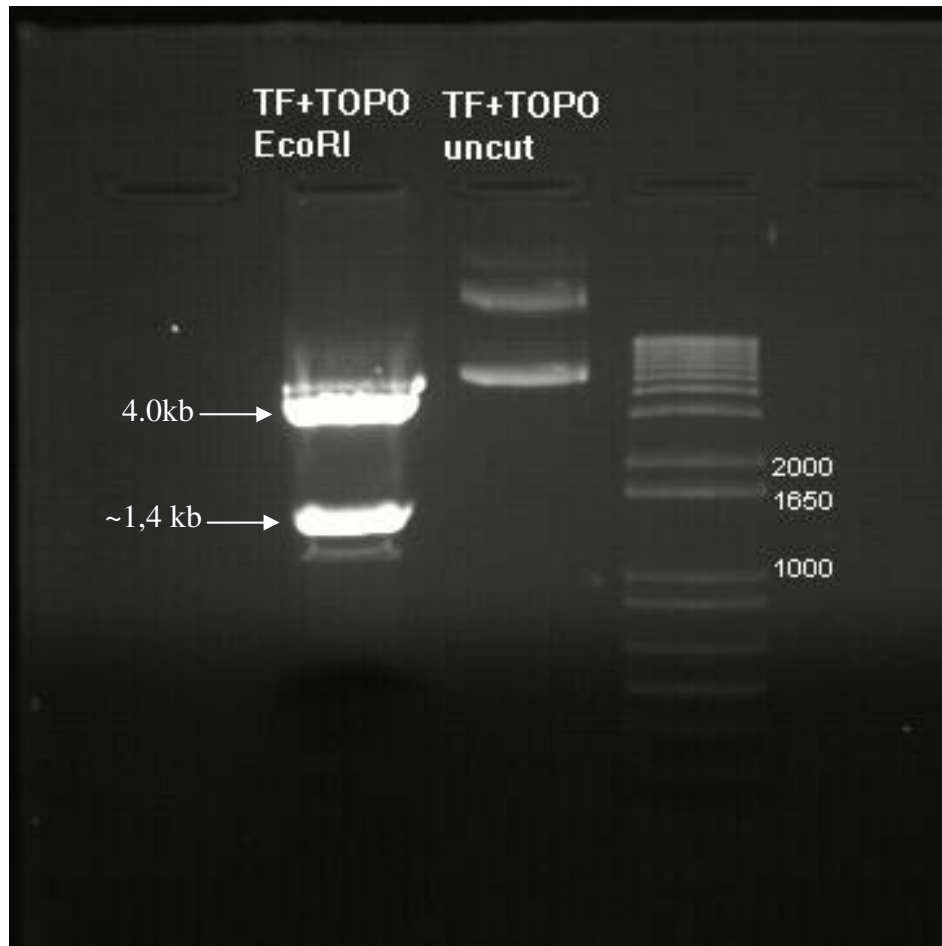

Figure 4.5: Electrophoretic analysis of DB90 construct digested with *EcoRI* and undigested plasmid

#### 4.4.3 Characterization of *JERF1* gene

Sequence analysis of the cloned gene was done by using universal M13 primer pair. The sequencing result was blasted in TIGR tomato and NCBI databases. It matched with the *JERF1* sequence of the NCBI accession number AY044235. Sequencing results are shown in Appendix C.



#### 4.4.4 PCR Amplification for cloning into expression vectors

Primers containing the proper restriction endonuclease recognition sites were designed for in frame insertion of *JERF1* into vectors pGR106 and pTRV2 for silencing, pRTL2-GUS/Ni $\Delta$ Bam for over expression, pJG4-5 and pTBSI for yeast mating assay, pDONR<sup>TM</sup>221 for gateway cloning and finally pEGKG for yeast protein expression. Primer sequences, restriction sites and the corresponding expression vector maps are shown in Appendix A and Appendix B respectively. DB90 was used as template for amplification of *JERF1* gene and PCR was carried out by using a proofreading Taq DNA polymerase.

It has been shown that a 200-500 base pair region is enough for virus-induced gene silencing of genes. Therefore, PCR was done with primers 162 and 163 for cloning of *JERF1* into the silencing vectors pGR106 and pTRV2. These primers correspond to around 500 base pair region in the gene (See Fig: 4.6). This region was blasted in TIGR and NCBI databases and found to be unique to *JERF1*.

*JERF1* was cloned into pRTL2-GUS/Ni $\Delta$ Bam vector for over-expression *in planta*. Primers 199 and 200 contained the *Bam*HI and *Xba*I recognition sites respectively so that *JERF1* could be cloned between *Bam*HI and *Xba*I sites in the vector. We obtained 1,4kb PCR product with primers 199 and 200, corresponding to full length of *JERF1* (See Fig: 4.6).

In order to clone and express the *JERF1* gene in yeast, pJG4-5 and pTBSI vectors were used. These constructs were then used for yeast mating assay for protein-protein interaction analysis. Primers 201 forward and 202 reverse contain the *Eco*RI, *Not*I and *Sac*I recognition sites in order to clone the *JERF1* gene into pJG4-5 and pTBSI vectors respectively. The forward primer 201 was designed according to 5' and 202 reverse was designed from 1375 th base of the *JERF1* gene (See Fig: 4.6).

*JERF1* was amplified with primers containing Gateway adapter sequences, BD1 and BD5 in order to be inserted into the donor vector pDONR<sup>TM</sup> 221. Primers BD1 and BD5 contained the corresponding *att*B sites for direct insertion into the donor vector. *att*B sites totally are about 60 base pairs long therefore from this amplification a longer fragment than the full length *JERF1* is obtained (See Fig: 4.6).

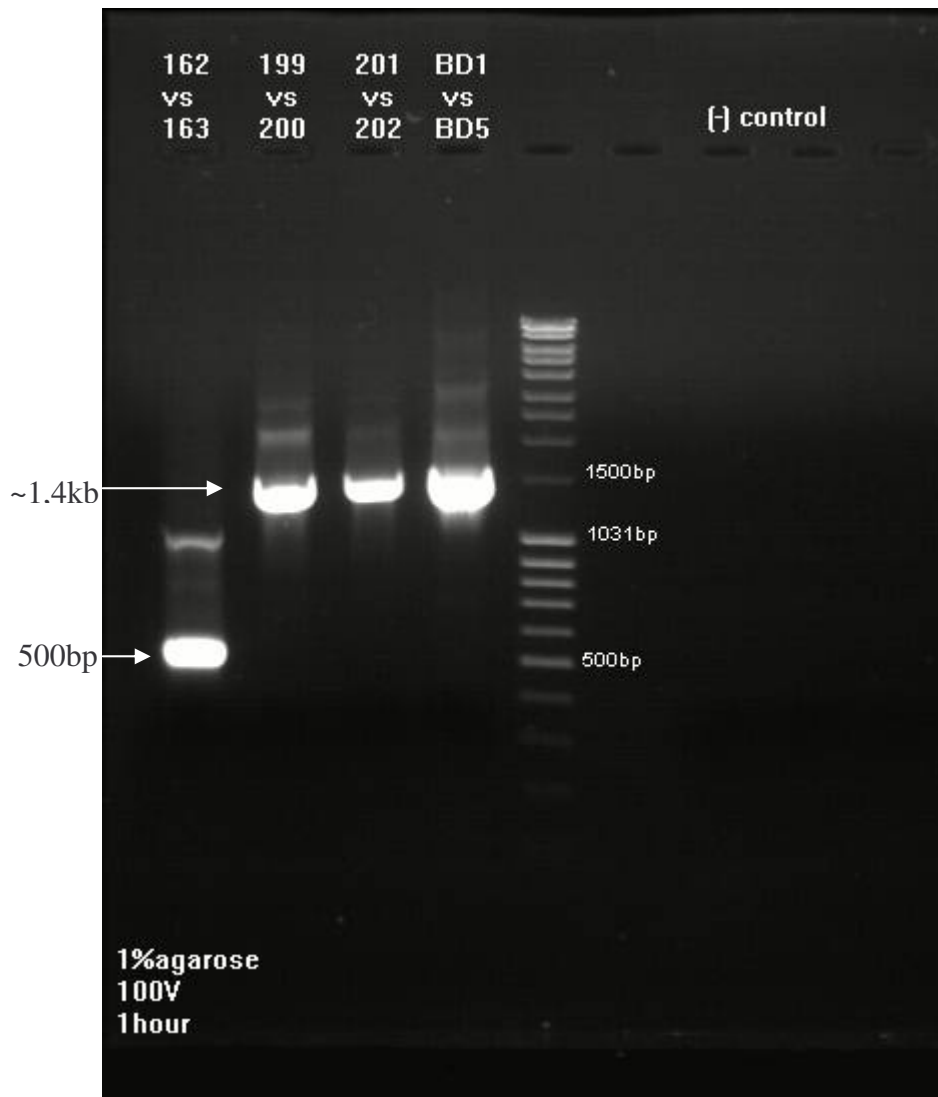

Figure 4.6: 1% Agarose gel electrophoresis result showing the amplification of *JERF 1* with different primers for different expression vectors. DNA molecular weight markers, different samples and electrophoresis conditions are indicated on the gel photograph.

#### 4.4.5 Gel purification of *JERF1*

After PCR amplification whole PCR product was run on gel and isolated from gel in order to clean the contaminants. Gel extraction was performed with Qiaquick<sup>®</sup> Gel Extraction Kit (250) (QIAGEN). 5  $\mu$ l of purified sample was loaded on the gel to check whether the PCR product had been purified and its concentration was enough for further cloning experiments (See Fig: 4.7).

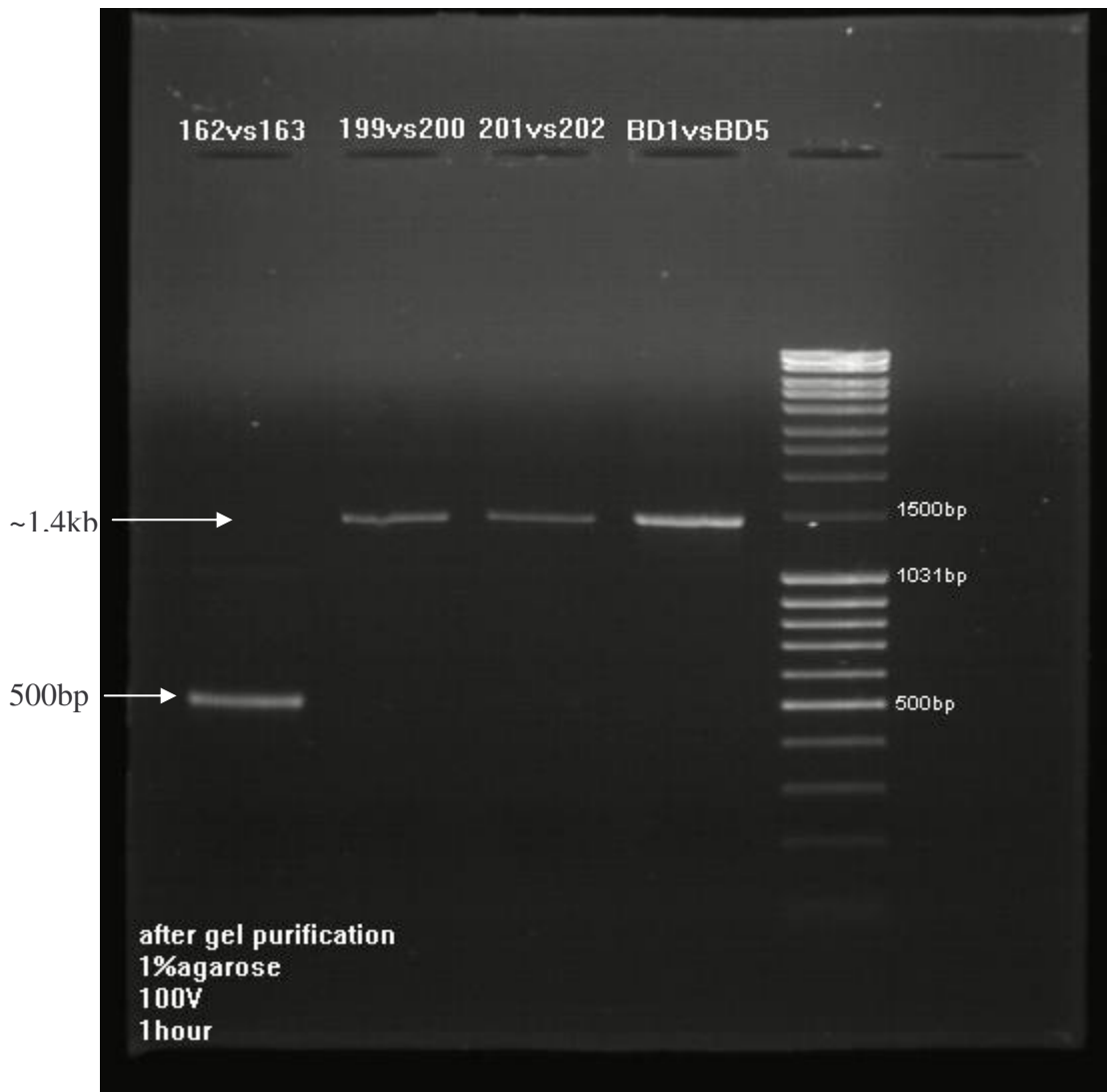

Figure 4.7: 1% Agarose gel electrophoresis result after the purification of PCR products of *JERF1* amplified with different primers.

#### 4.4.6 Digestion of *JERF1* with proper restriction endonucleases

*JERF1* amplified with different primers for different expression vectors were digested with the proper restriction endonucleases in order to be inserted into the desired plasmids (See Fig: 4.8).

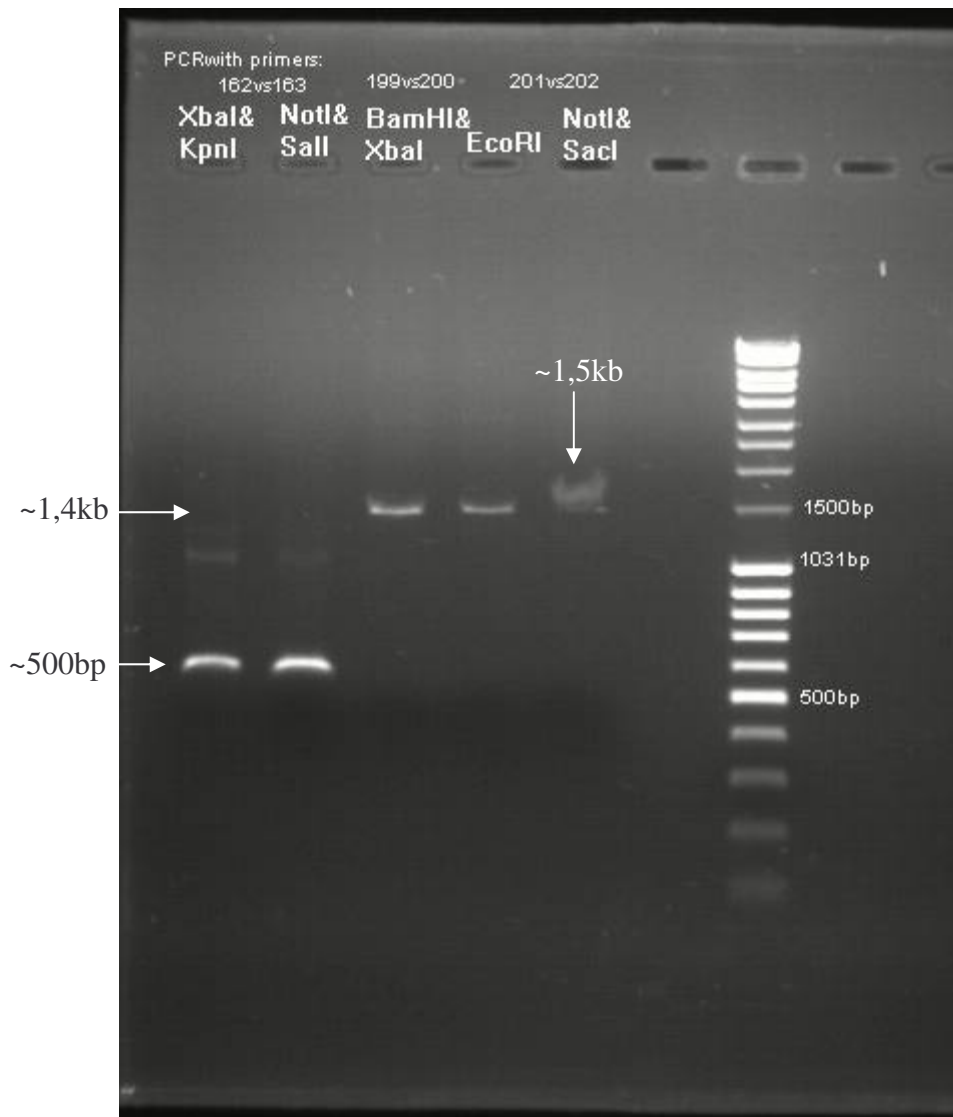

Figure 4.8: 1% Agarose gel electrophoresis result of the digestion of *JERF1* gene with proper restriction endonucleases for expression vectors.

#### 4.4.7 Digestion of different expression vectors for cloning of *JERF1*

pTRV2, pGR106, pRTL2-GUS/NIaΔBam, pJG4-5 and pTBSI were digested with restriction endonucleases *XbaI* and *KpnI*, *NotI* and *SalI*, *BamHI* and *XbaI*, *EcoRI*, *NotI* and *SacI* respectively and gel purified for ligation process (See Fig: 4.9).

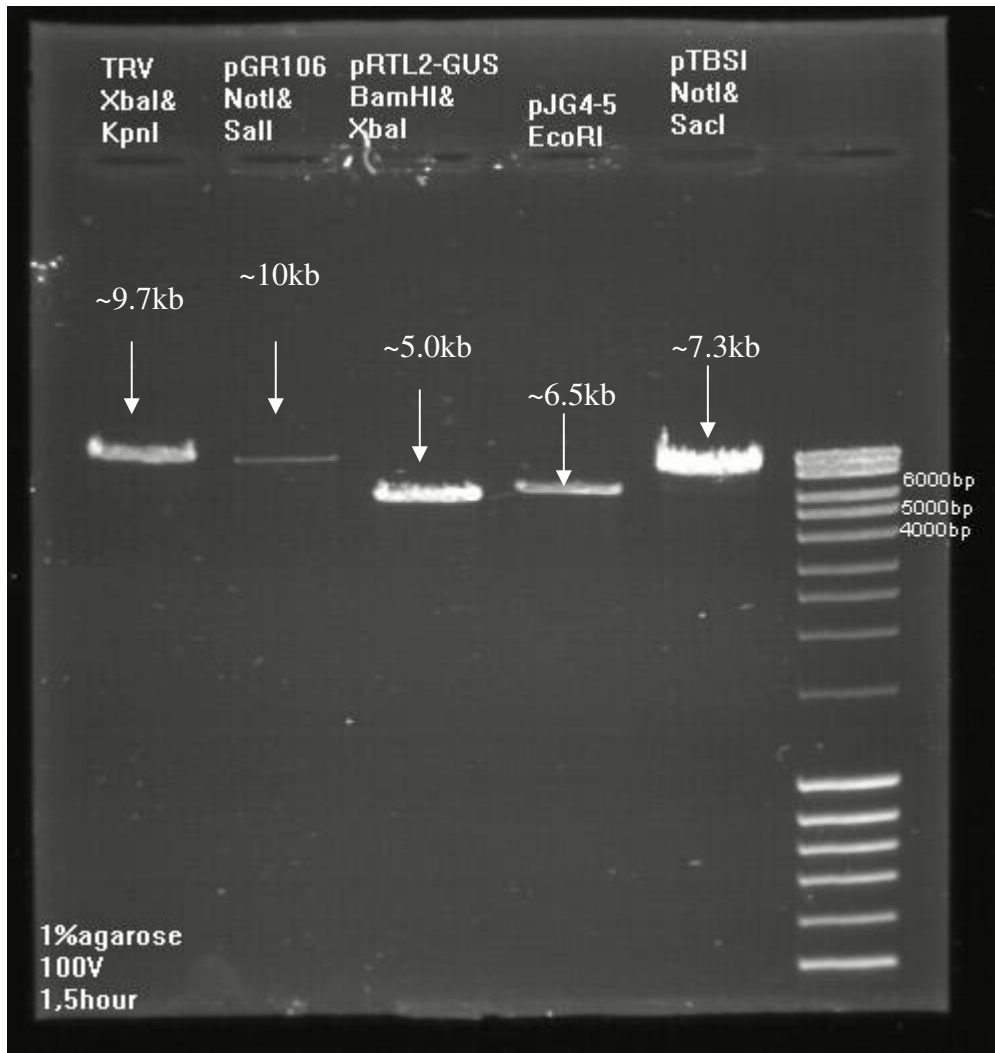

Figure 4.9: Electrophoretic analysis of different vector digestions with different restriction endonucleases.

#### 4.4.8 Ligation

PCR amplified fragments were ligated into corresponding vectors for further analysis of the gene. Ligations were done following precipitating the vector and fragment by Ethanol overnight so that the efficiency was higher.

PCR amplified *JERF1* with primers BD1 and BD 5 was ligated into vector pDONR™ 221 by BP reaction so that the entry clone DB109 (pDONR™ 221+*JERF1*) was obtained. After BP reaction *JERF1* was inserted into destination vectors GFP-N-Bin and GFP-C-Bin by LR reaction so that the expression clones DB110 (GFP-N-Bin + *JERF1*) and DB 111 GFP-C-Bin+ *JERF1*) were obtained.

#### 4.4.9 Cloning of *JERF1* gene

The constructs prepared by ligating *JERF1* fragment into pTRV2 and pGR106 and full length *JERF1* into pJG4-5, pTBSI and pRTL2-GUS/Ni $\Delta$ Bam were transformed into *E.coli* TOP10 cells chemically. DB109, DB110 and DB111 were transformed into *E.coli* DH5  $\alpha$  since this strain shows the highest efficiency of transformation with Gateway vectors. Transformants that were grown on the proper antibiotic selection LB medium were screened by colony PCR with gene specific primers to check whether they contain the insert. Colony PCR results of the different constructs are shown below.

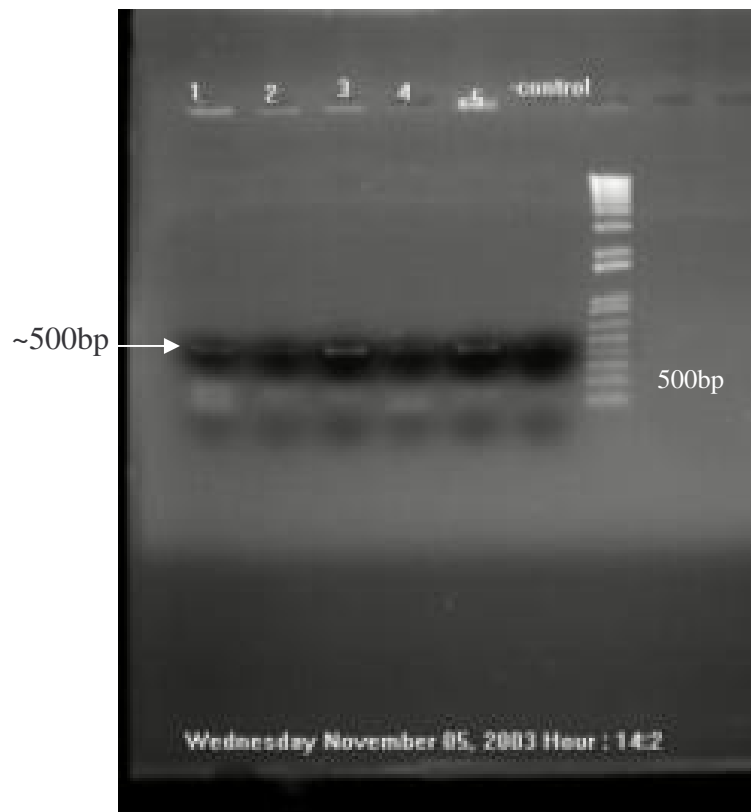

Figure 4.10: 1% Agarose gel electrophoresis showing the colony PCR result of pTRV2+ *JERF1* transformation

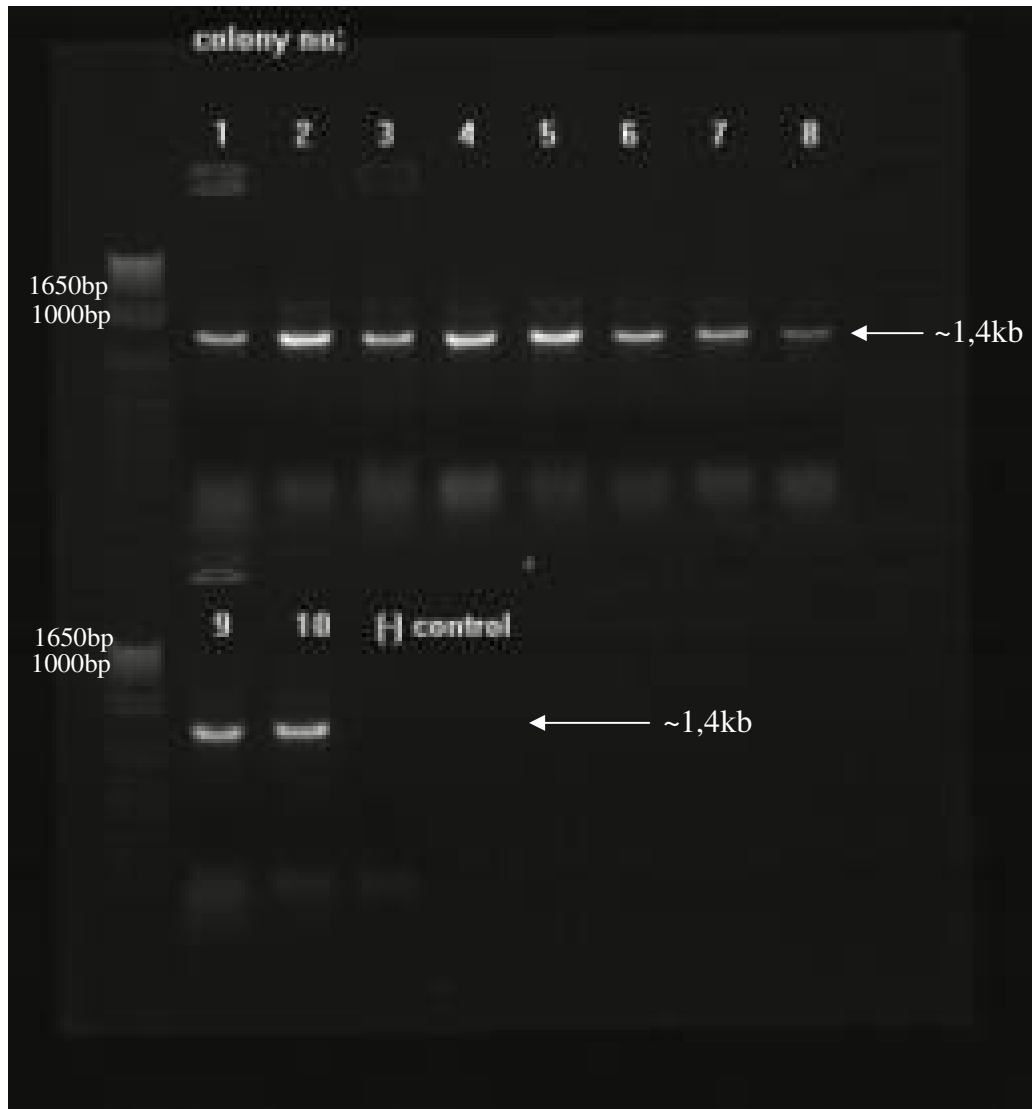

Figure 4.11: 1% Agarose gel electrophoresis photograph showing the colony PCR result of the transformation of pJG4-5+ *JERF1* into *E.coli* TOP10 cells.

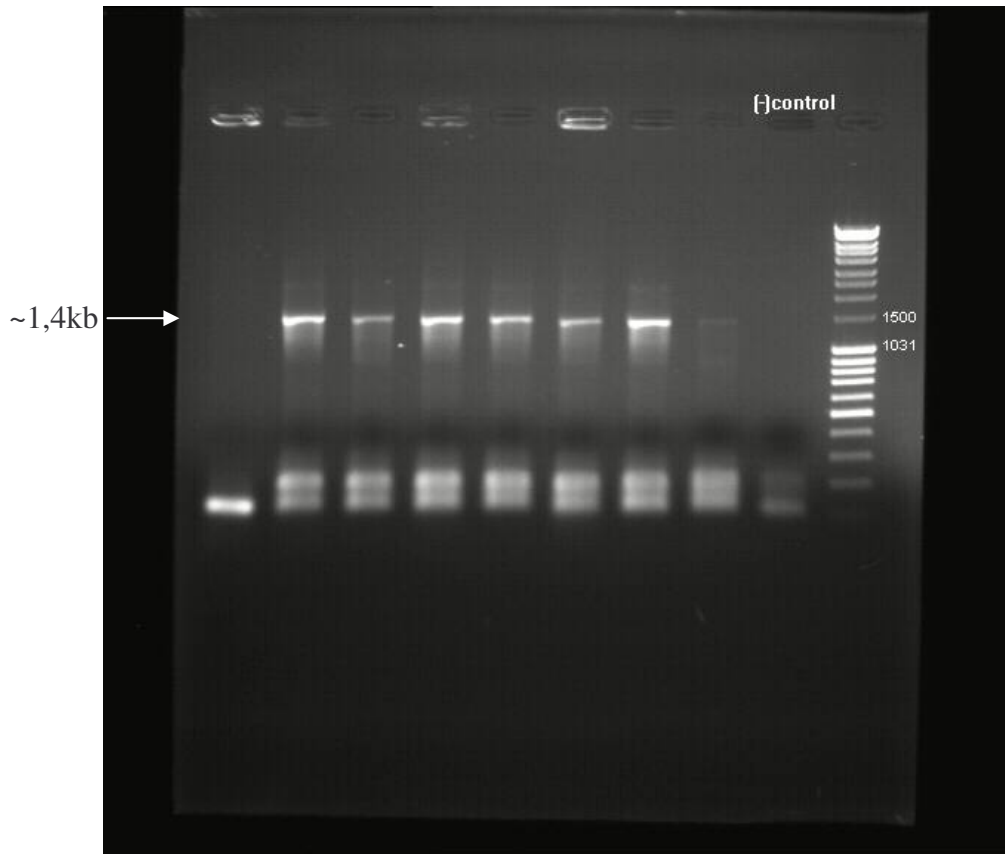

Figure 4.12: 1% Agarose gel electrophoresis photograph showing the colony PCR result of the transformation of pTBSI+ *JERF1* into *E.coli* TOP10 cells.



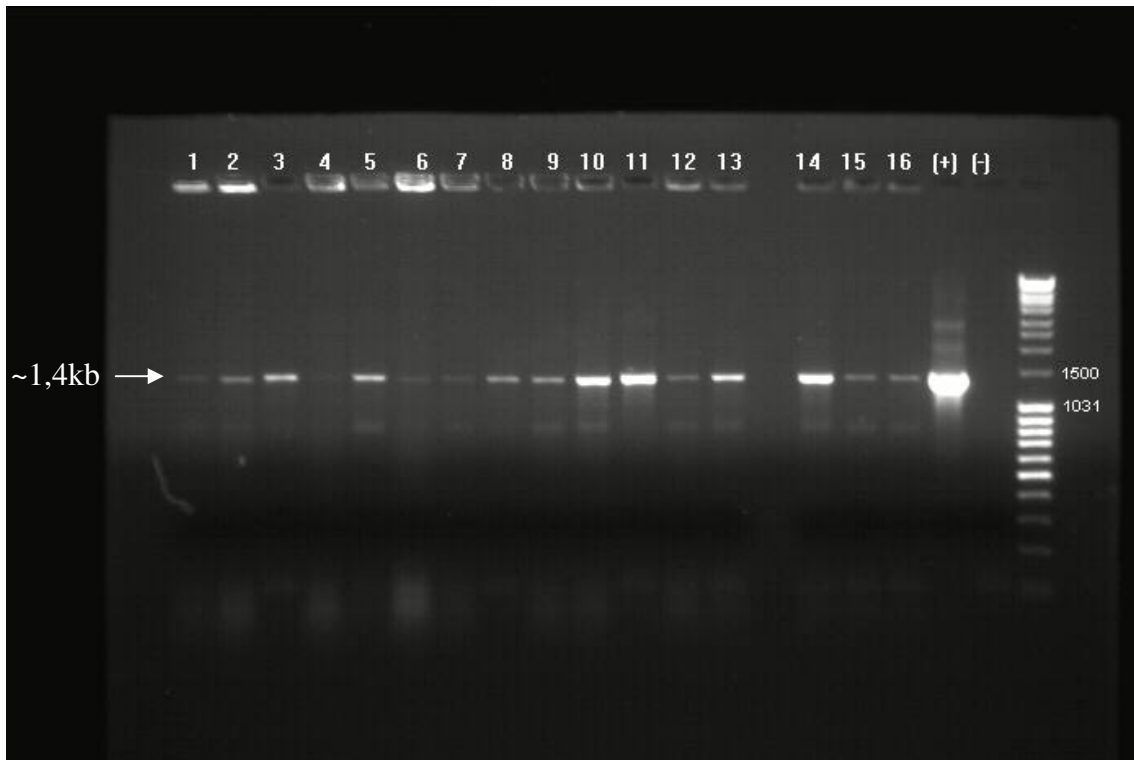

Figure 4.13: 1% Agarose gel electrophoresis photograph showing the colony PCR result of the transformation of pRTL2-GUS/Nia $\Delta$ Bam + *JERF1* into *E.coli* TOP10 cells. 1-16= PCR of 16 different colonies of pRTL2-GUS/Nia $\Delta$ Bam + *JERF1* transformation with primers 190 and 194. (+)=PCR amplification of *JERF1*+ pCR-4-TOPO with primers 190 and 194 as positive control. (-)= negative control.

Only a single colony grew after transformation of DB 109. Colony PCR was done with different primers to check the presence of the gene in the construct. PCR of 190 and 194 is expected to give the full length *JERF1* which is about 1, 4 kb. PCR analysis with internal primers of 190 and 196 and 195 and 194 is expected to give fragments of 900 bp and 700 bp respectively. DB90 construct was used as positive control for the PCR reaction.

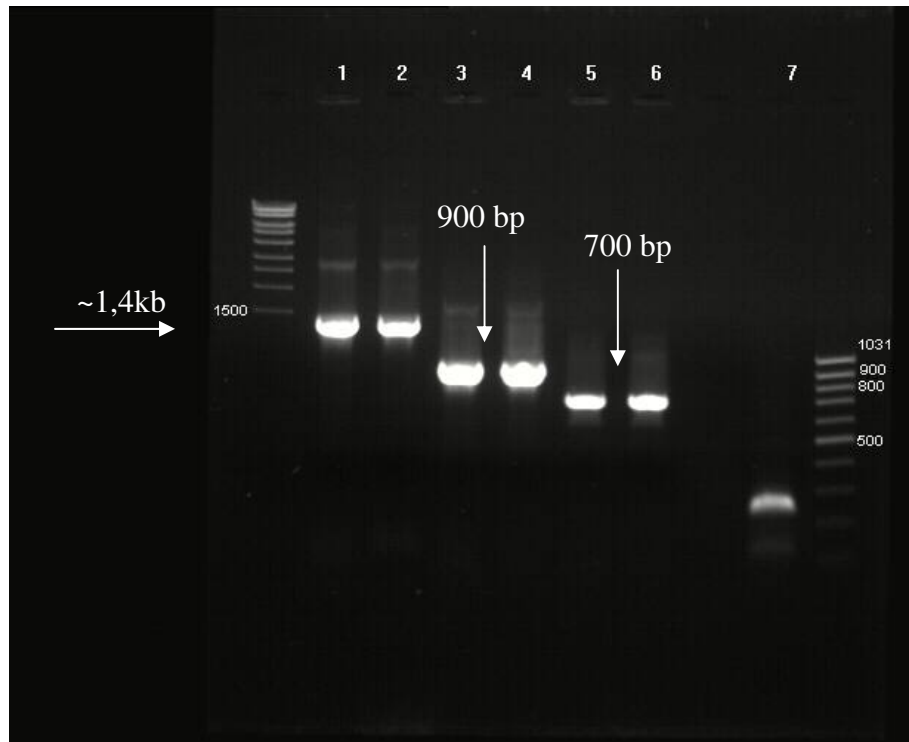

Figure 4.14: 1% Agarose gel electrophoresis of colony PCR of DB109. 1= PCR amplification with primers 190 and 194 of colony grown after BP reaction, 2= PCR amplification of *JERF1*+ pCR-4-TOPO with primers 190 and 194 as positive control. 3= PCR amplification with primers 190 and 196 of colony grown after BP reaction. 4= PCR amplification of *JERF1*+ pCR-4-TOPO with primers 190 and 196 as positive control. 5= PCR amplification with primers 195 and 194 of colony grown after BP reaction. 6= PCR amplification of DB90 with primers 195 and 194 as positive control. 7= negative control.

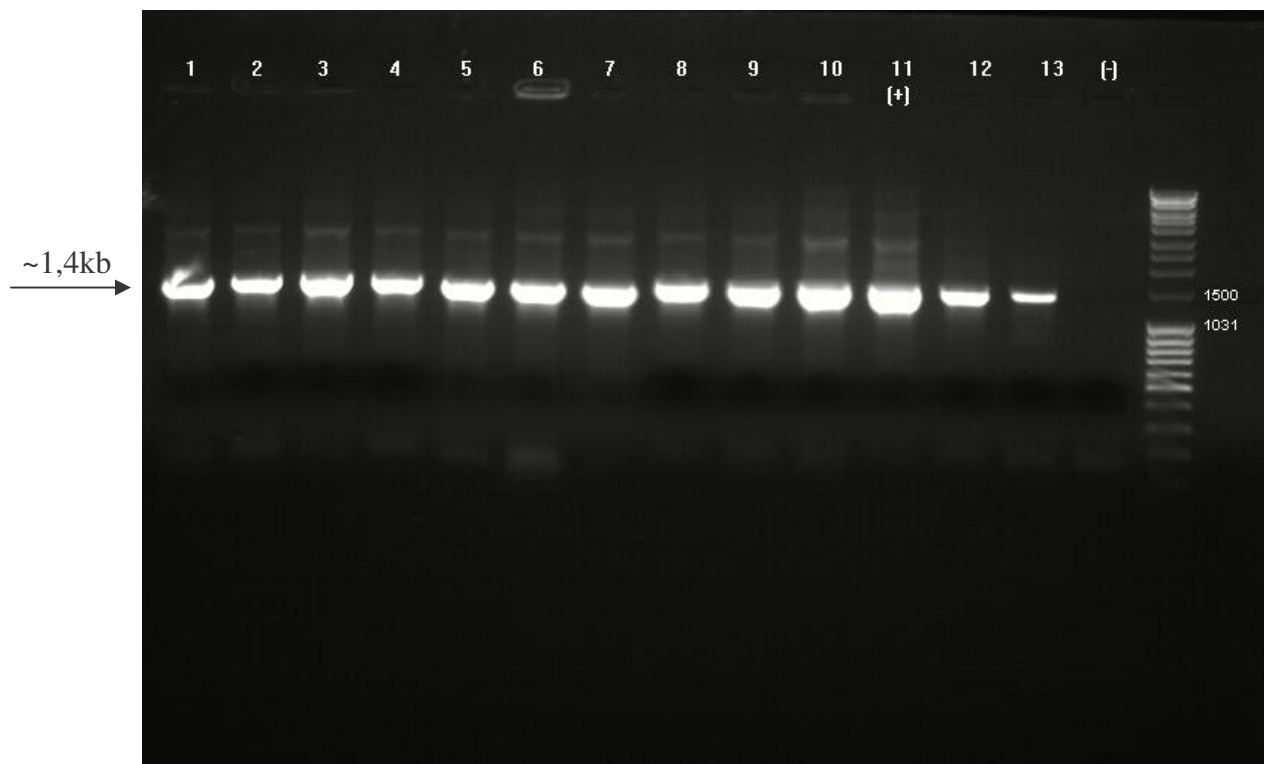

Figure 4.15: 1% Agarose gel electrophoresis of colony PCR with primers 190 and 194 of 12 colonies grown on selective media. 2, 3, 4, 5, 6, 12= colonies grown after transformation of GFP-N- Bin +*JERF1* constructs. 1, 7, 8, 9, 10, 13= colonies grown after transformation of GFP-C- Bin +*JERF1* constructs. 11= PCR amplification of *JERF1*+ pCR-4-TOPO with primers 190 and 194 as positive control. (-)= negative control.

#### 4.4.10 Sequence confirmations of constructs prepared

Sequence alignments of the constructs with *JERF1* (TIGR; TC 124207) have shown that the gene is successfully inserted into vectors pDONR™ 221, GFP-N-Bin and GFP-C-Bin. Colonies were grown on selective medium after transformation and gave the fragment of 1, 4 kb by PCR with primers 190 and 194. Sequence alignments are shown in Appendix C.

## 4.5 Silencing Analysis of *JERF1*

*JERF1* was silenced by virus-induced gene silencing (VIGS) method in *N. benthamiana* plants in order to predict its function in viral pathogenesis. In order to silence the gene constructs TRV2+ *JERF1* (DB226) and pGR106+*JERF1* (DB213) were transformed into *A.tumefaciens* hyper virulent strain LBA4404. pBBR1MCS virGN54D chemically and the transformants were selected on LB agar plates containing the rifampicin (25 µg/ml) and kanamycin (50 µg/ml) antibiotics. Colony PCR was performed with gene specific primers for *JERF1* for checking the presence of the gene before plant infection. Prior to infiltration *Agrobacterium* cultures were grown until the optical density reached 2. After plant growth for 3 weeks *Agrobacterium* containing the constructs were infiltrated into leaves and left for 2 weeks for the silencing. Then the plants were challenged with Tobacco Mosaic Virus (TMV) by infecting the leaves. *JERF1*-silenced *N.benthamiana* plants were observed after 3 weeks following virus infection. Both susceptible (nn) genotype and resistant (NN) genotype plants were used for this experiment. Observation of the virus infected- *JERF1*-silenced wild-type plants has shown a massive death phenotype whereas no massive death was observed in virus infected- *JERF1*-silenced resistant plants.

### 4.5.1 Plant observation

After 15 days of plant growth, leaves were infiltrated with *Agrobacterium* containing DB226 and DB 213 constructs for silencing which takes about 15 days. Then plants were challenged with TMV and observed daily. Silencing results are shown below. Silencing experiments has been done in duplicates but has to be repeated for confirmation.



Figure 4.16: Control wild-type (nn) plant which is neither silenced nor TMV infected



Figure 4.17: Control nn plant which is not silenced but TMV infected



Figure 4.18: Control NN plant which is not silenced but TMV infected



Figure 4.19: NN plant that is *JERF1* silenced and TMV infected





Figure 4.20: nn plant that is *JERF1* silenced and TMV infected



Figure 4.21: nn plant that is *JERF1* silenced and TMV infected

## 4.6 GFP-fusion protein Expression and Localization Analysis of *JERF1*

In order to see the sub-cellular localization of *JERF1*, the gene was inserted into GFP fusion vectors, GFP-N-Bin and GFP-C-Bin. GFP constructs DB110 and DB 111 were inserted into *A.tumefaciens* hyper virulent strain LBA4404.pBBR1MCSvirGN54D for transient expression of the protein in *A.thaliana* Col-O suspension cultures.

### 4.6.1 Transformations of constructs into *A.tumefaciens*

Constructs DB110 and DB111 were transformed into *A.tumefaciens* hyper virulent strain LBA4404.pBBR1MCSvirGN54D chemically. Transformants were selected on LB agar media containing kanamycin (50 µg/ml) and rifampicin (25 µg/ml) antibiotics. Colonies grown were screened by colony PCR with primers 190 and 194 for the presence of the gene. 95% transformation efficiency was achieved.

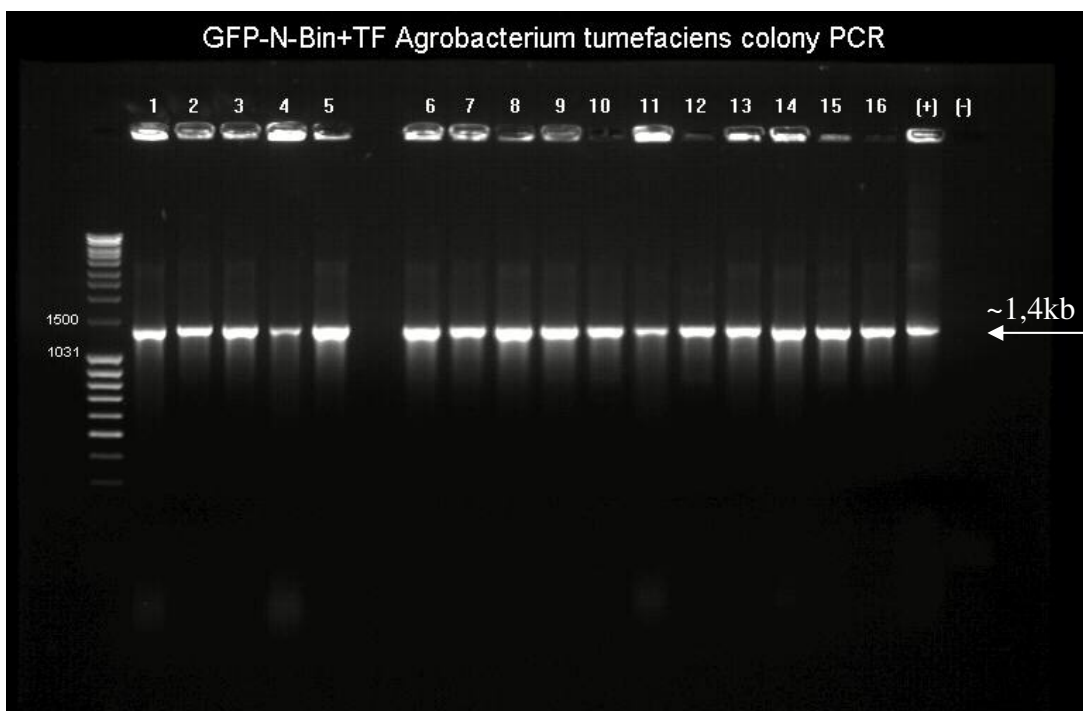

Figure 4.22: 1% Agarose gel electrophoresis of colony PCR with primers 190 and 194 showing the presence of *JERF1* gene in *A.tumefaciens* transformed with GFP-N-Bin+*JERF1* construct. 1-16= colonies grown after transformation of GFP-N-Bin+*JERF1* constructs. (+)= PCR amplification of *JERF1*+ pCR-4-TOPO with primers 190 and 194 as positive control. (-)= negative control.

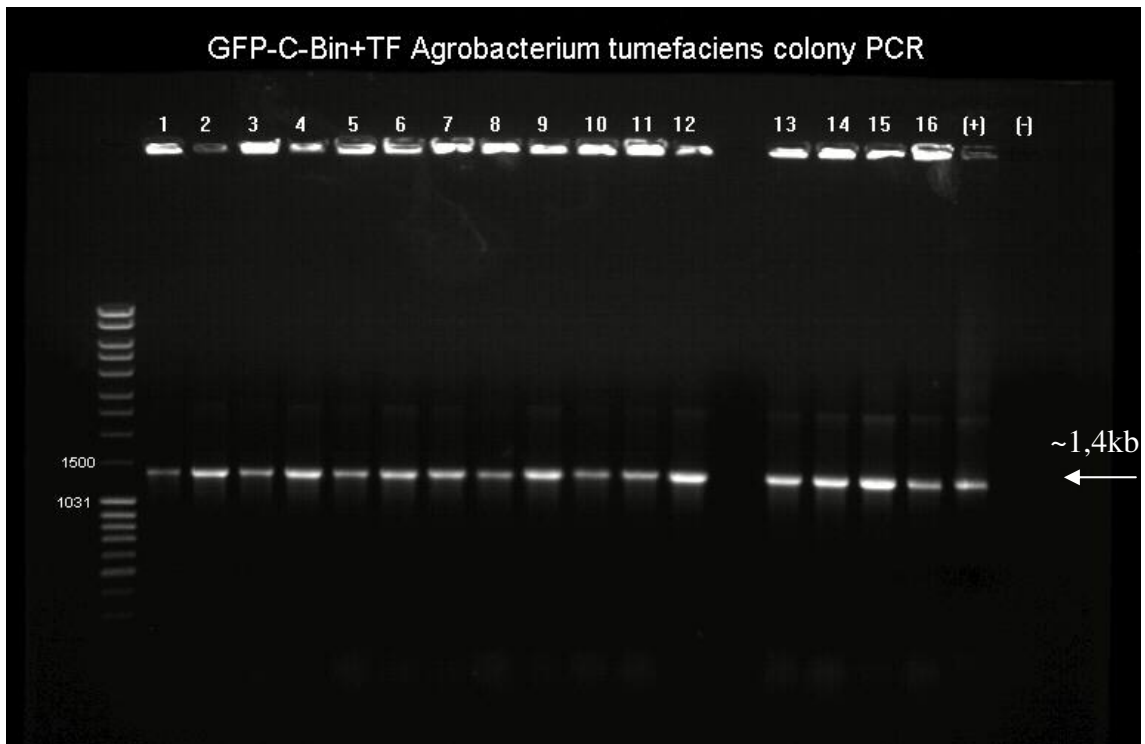

Figure 4.23: 1% Agarose gel electrophoresis of colony PCR with primers 190 and 194 showing the presence of *JERF1* gene in *A.tumefaciens* transformed with GFP-C-Bin+*JERF1* construct. 1-16= colonies grown after transformation of GFP-C- Bin+*JERF1* constructs. (+)= = PCR amplification of *JERF1*+ pCR-4-TOPO with primers 190 and 194 as positive control. (-)= negative control

#### 4.6.2 Transient expression of GFP constructs in *A. thaliana*

*A.thaliana* Col-O suspension cultures were inoculated with *Agrobacterium* containing the DB110 and DB111 constructs following the subculturing of the suspensions. After incubation of 2 days with *Agrobacterium*, the suspensions were observed under inverted and fluorescent microscope for GFP expressions. (Data not shown)

## 4.7 Protein-protein interaction analysis of JERF1

In order to observe the interactors of JERF1, yeast-mating assay was performed. For mating-assay, first yeast strains EGY 48 and RFY 206 were transformed with pJG4-5+*JERF1* (DB112) and pTBSI+*JERF1* (DB113) constructs. Then the recombinant yeast were mated with Plant P58<sup>IPK</sup> containing yeast.

### 4.7.1 Yeast Transformations

pJG4-5+*JERF1* and pTBSI+*JERF1* constructs were transformed into yeast EGY 48 and RFY 206 by Li-Ac method. The transformants were selected on –trp and –ura media for selection. DB113 transformed yeast did not grow on the selective media whereas DB112 transformations gave several colonies. The yeast colonies grown on selective media after transformation were screened by colony PCR with gene specific primers 190 and 194 (See Fig: 4.24).

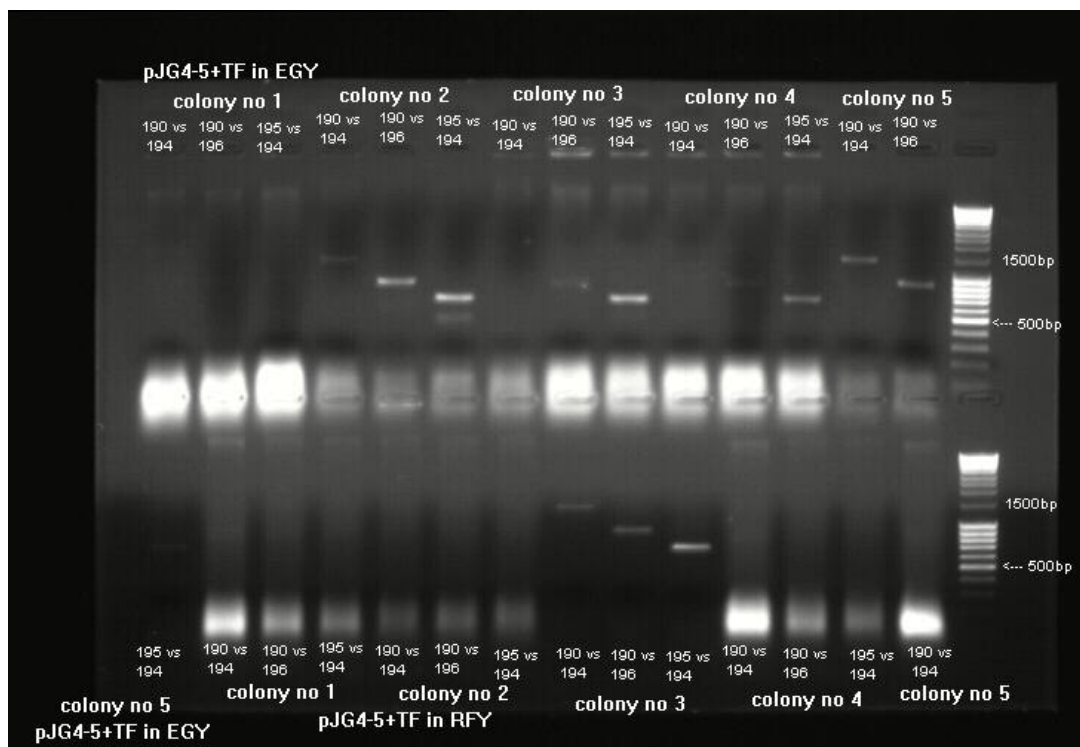

Figure 4.24: Electrophoresis analysis of colony PCR with primers 190 and 194 of 5 yeast EGY48 and 5 yeast RFY206 colonies grown on selective medium after transformation with DB112 construct.

#### 4.7.2 Mating Assay

Plant P58<sup>IPK</sup> had been ligated into pTBSI vector previously and transformed into RFY 206 yeast cells. DB112 containing EGY48 yeast cells were mated with Plant P58<sup>IPK</sup>+ pTBSI transformed RFY 206 yeast cells and DB112 containing RFY 206 yeast cells were mated with Plant P58<sup>IPK</sup>+ pTBSI transformed RFY 206 as negative control. 3 colonies were observed in the plate where *JERF1*+pJG4-5 construct containing EGY yeast cells mated with Plant P58<sup>IPK</sup>+ pTBSI construct containing RFY yeast cells. In the lower part of the plate, *JERF1*+pJG4-5 construct containing RFY yeast cells were mated with Plant P58<sup>IPK</sup>+ pTBSI construct containing RFY yeast cells as negative control (See Fig: 4.25).

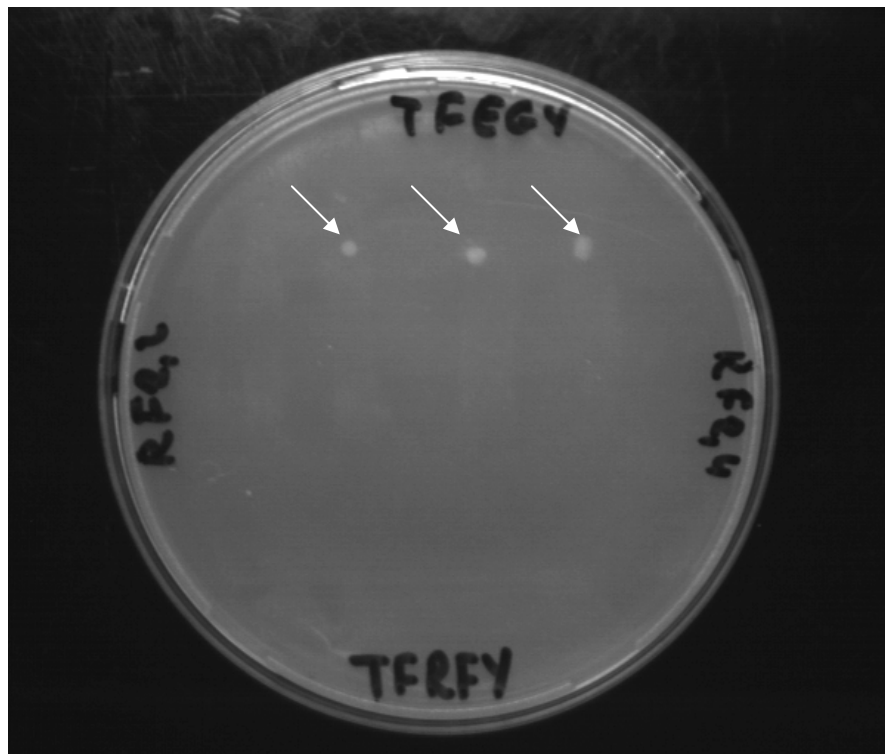

Figure 4.25: Mating Assay Result showing the in vivo interaction of Plant P58<sup>IPK</sup> with *JERF1*

#### 4.8 Subcloning into Yeast Protein Expression Vector by Homologous Recombination

*JERF1* was amplified with primers 207 and 208 which were specifically designed for cloning into expression vector pEGKG by homologous recombination. A full length of *JERF1* which corresponds to about 1,4 kb on the agarose gel electrophoresis was obtained from this amplification (See Fig: 4.26).

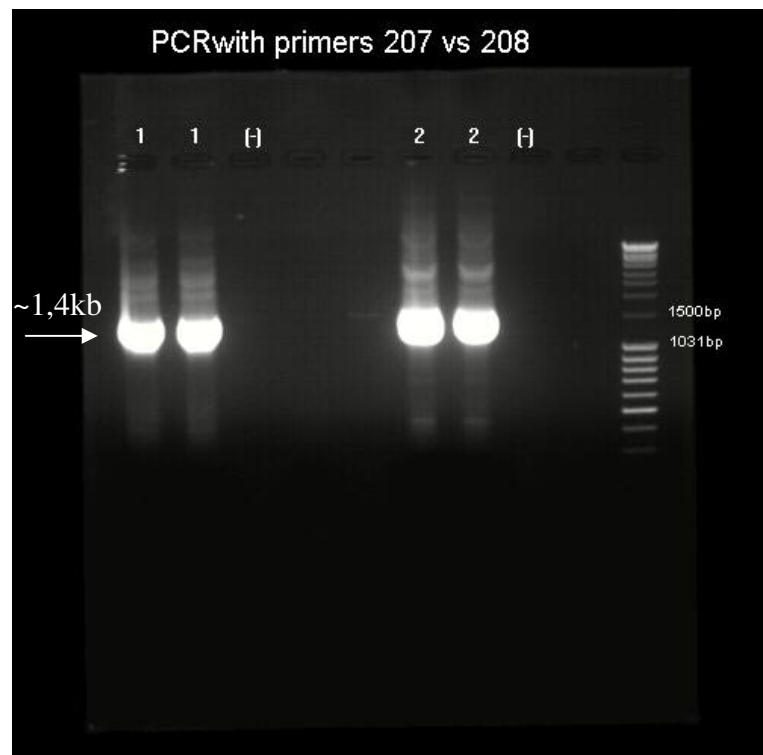

Figure 4.26: 1% Agarose gel electrophoresis result showing the amplification of *JERF1* with primers 207 and 208.

pEGKG was digested with *HindIII* for linearization for cloning of the *JERF1* gene. Total digestion was run on gel for gel purification (See Fig: 4.27).

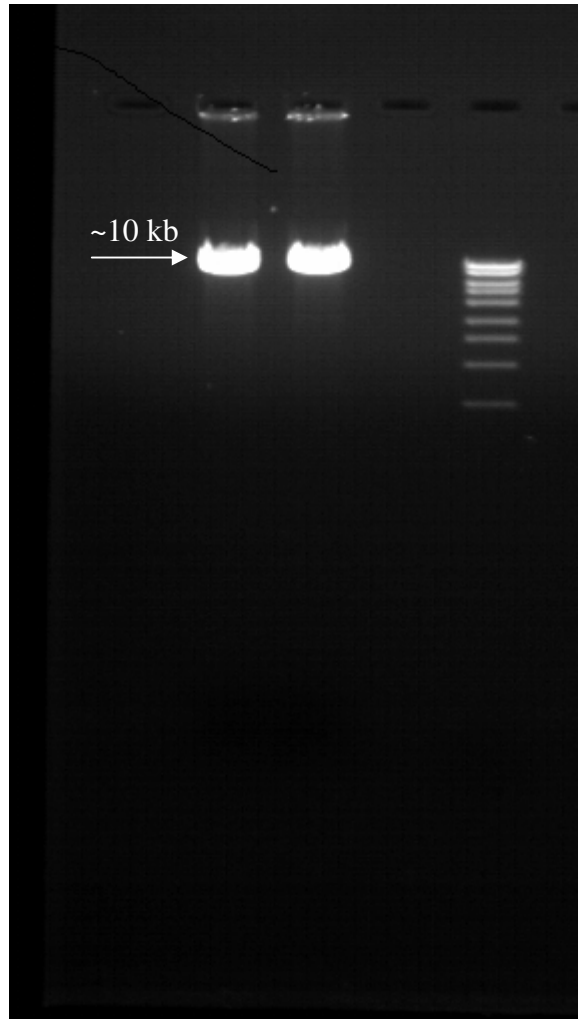

Figure 4.27: 1% agarose gel electrophoresis showing the *Hind*III digestion of the vector pEGKG. Samples were run at 100 V for 1.5 hours

*JERF1* amplified with primers 207 and 208 was cloned into pEGKG by homologous recombination in yeast EGY48 strain. 1  $\mu$ l of PCR product and 1  $\mu$ l of digested pEGKG were transformed into yeast EGY48 cells by LiAc method. The transformants were selected on the proper selective medium and grown colonies were screened for the presence of *JERF1* with PCR amplification with primers 190 and 194 (See Fig: 4.28).



Figure 4.28: Electrophoresis analysis of colony PCR with primers 190 and 194 of 4 yeast EGY 48 colonies and 4 RFY206 colonies grown on selective medium after transformation with pEGKG and *JERF1*.

Plasmid was isolated from colony 3 and electroporated into *E.coli* TOP10 cells for plasmid rescue. Electroporated *E.coli* samples were grown overnight at 37°C and the next day PCR was done with primers 190 and 194 to check the insert (See Fig: 4.29).



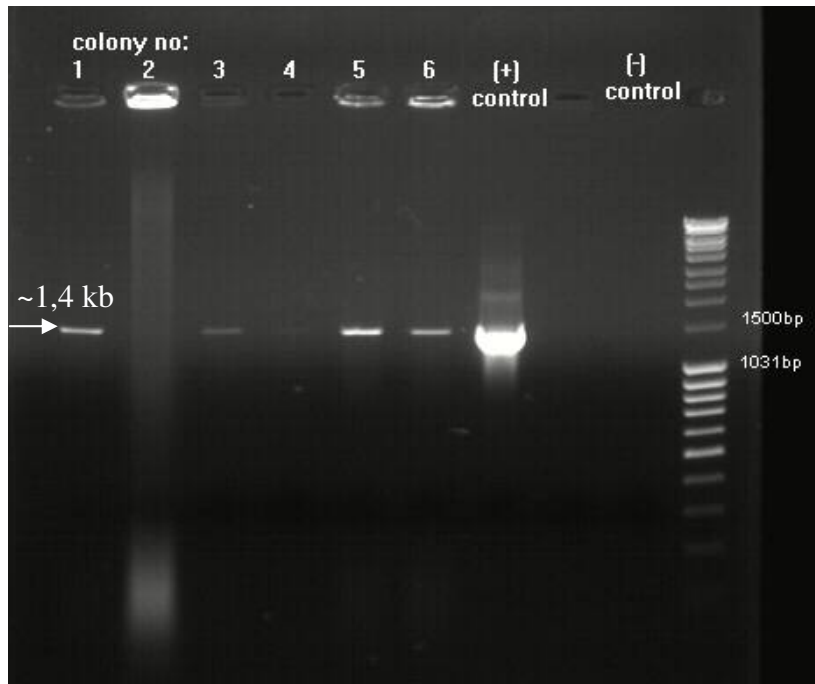

Figure 4.29: Electrophoresis analysis of colony PCR with primers 190 and 194 of 6 *E.coli* colonies grown after electroporation of pEGKG+*JERF1* construct into *E.coli* cells.

## 5 DISCUSSION

Apetala 2/ethylene responsive factor (AP2/ERF) proteins are AP2 domain containing transcription factors and form the second largest transcription factor family in plants. The AP2 transcription factor family is one of several that are unique to the plant lineage (Reichman *et al.*, 2000). AP2 domain was first identified by Jofuku *et al.* 1994. The conserved domain was found in homeotic gene APETALA2 (AP2) and in ethylene-responsive element binding proteins (EREBPs) from tobacco (Ohme-Takagi *et al.*, 1995). AP2 transcription factor family contains the subfamily of ethylene response factor (ERF). 125 genes of *Arabidopsis thaliana* AP2 TFs are categorized into two subfamilies (Sakuma *et al.*, 2002). A subfamily contains those that are similar to the dehydration-responsive element binding (DREB) genes, and the B subfamily is the one similar to AtERF1. Gutterson and Reuber recently (2004 August) reorganized the categories. The gene number increased to 145 and consistent with the previous categorization.

We have identified an AP2 domain containing putative transcription factor in *L. esculentum*. It has been named as *JERF1* because of its putative role as jasmonic acid and ethylene response factor (Huang R.F. *et al.*). *JERF1* was identified as an interactor of p58<sup>IPK</sup> in a yeast two-hybrid analysis (Bilgin D.D unpublished data). Sequence analysis revealed a 594 bp long partial gene sequence that showed high homology to AY044235 in NCBI database. By using gene specific primers 190 forward and 194 reverse we have cloned the full length gene from tomato leaf 1<sup>st</sup> strand cDNA library and subcloned it into pCR<sup>®</sup>4-TOPO vector for sequencing. This construct has been given the name DB90. Gene sequence confirms 100% homology to *JERF1* (Appendix C).

Functional analyses of *JERF1* included the silencing, overexpression, protein-protein interaction and localization experiments. For each step, the gene had to be sub-cloned into specific vectors for that function. Different primers containing different restriction enzyme sites compatible with the vector multiple cloning sites were designed according to AY044235 sequence of *JERF1* from the 5' end as forward and 3' end as reverse. By using the DB90 construct as template the *JERF1* gene was amplified to be inserted into different expression vectors.

For virus induced gene silencing experiments two different VIGS vectors were used. One of them is potato virus X based pgR106 and the other one is Tobacco Rattle Virus based pTRV2. *N* gene transgenic (NN) and wild type *N. benthamiana* plants (nn) were used for VIGS experiments. A 500 bp long *JERF1* 3' was amplified with PCR for cloning. The 500 bp region was selected after aligning *JERF1* with other AP2 domain genes. This region is specific to *JERF1* gene.

When NN *N. benthamiana* plants are infected with TMV, plant develops HR at the site of infection and induces cell death in order to prevent replication and spread of the virus. *JERF1* gene was silenced in NN *N. benthamiana* background by using PVX vector pgR106. After 2 weeks, silenced plants were challenged with TMV. No difference was observed between *JERF1* non-silenced and silenced, TMV challenged NN *N. benthamiana* plants. All induced cell death at the site of infection upon TMV infection. There was no effect on N-mediated resistance to TMV in NN plants.

TMV infection of wild-type (nn) *N. benthamiana* plants does not develop cell death upon infection. However, silencing of *JERF1* caused massive cell death in wild-type *N. benthamiana* plants when challenged with TMV. The experiments were done in duplicates and both plants showed the same response. These results imply that *JERF1* protein is required for development of viral symptoms and prevention of nonhost resistance

For timing of the silencing, phytoene desaturase (PDS) gene was used as one of the controls (Ruiz *et al* 1998). PDS gene silenced plants become susceptible to photo

bleaching and the silenced leaves become white. The plants at the same age and conditions are used in parallel for silencing experiments (data not shown).

The silencing experiments that were done with pTRV2 did not show any massive death in wild-type *N. benthamiana* plants. We believe we faced some technical difficulties in the application of this particular silencing experiment series. The silencing experiment is performed by mixing pTRV1 with pTRV2; vectors carry RNA1 and RNA2 of Tobacco Rattle Virus, respectively (Liu *et al.*, 2002). The two vectors have to be mixed in 1:1 ratio OD 600nm 0.5-1, if these conditions cannot be maintained properly the silencing does not work. Northern or RT-PCR analysis experiments of the silenced plants would give more reliable data for silencing of *JERF1*. However, despite we collected and frozen tissue samples due to time limitations experiments could not be performed.

AP2/ERF genes function in a variety of stress regulation. A-subfamily TFs predominantly plays a role in the regulation of abiotic stress responses (C-repeat binding factor CBF and DREB). B-subfamily contains all AP2 genes that are involved in disease resistance responses. ERF genes are regulated by a variety of disease related stimuli, such as infection by virulent and avirulent pathogens; Several ERF TFs are transcriptionally regulated not only by pathogens, but also plant hormones like ethylene, jasmonic acid, salicylic acid which are important signaling components during plant-pathogen interactions (Cheng *et al.*, 2002, Fujimoto *et al.*, 2000, Lorenzo *et al.*, 2003). For example; Pti-4, Pti-5 and Pti-6 interact with tomato disease resistance protein Pto in yeast two-hybrid assays fall into this category. This data was the first to suggest the involvement of this ERF subfamily involvement in the regulation of plant disease resistance pathways (Zhou *et al.*, 1997). Especially Pti-4 and AtERF1 are induced not only by pathogen infection but also by salicylic acid as well as jasmonic acid and ethylene. Overexpression of Pti-4 in *Arabidopsis thaliana* induces defense genes and produces enhanced resistance to *E. orontii* and increased tolerance to *P. syringae* (Gu *et al.*, 2002). For overexpression analysis of *JERF1* gene in plant, pRTL2-GUS/N1aΔBam vector was used. This vector contains a Cauliflower Mosaic Virus minimal 35S promoter, a multiple cloning site and NOS terminator. However due to time limitations overexpression analysis could not be performed. The future work includes the

production of transgenic plants with high expression levels of *JERF1*, to observe the TMV infection pattern and responses given to different pathogen infection of these transgenic plants.

A partial clone of *JERF1* has been found to be an *in vivo* interactor of plant P58<sup>IPK</sup> (Bilgin D.D., unpublished data). During this study, the interaction of whole length *JERF1* and plant P58<sup>IPK</sup> has been confirmed by yeast mating assay. *JERF1* was inserted into vectors pJG4-5 and pTBSI. Yeast EGY48 and RFY206 cells were then transformed by these constructs. Mating was done with transformed EGY and RFY yeast cells containing the *JERF1*+pJG4-5 construct and P58<sup>IPK</sup> +pTBSI containing RFY206 cells. Colonies grown on selective media after the mating of transformed EGY cells containing *JERF1* with RFY cells containing plant P58<sup>IPK</sup> indicate that these two proteins interact *in vivo*. The result of mating experiment also puts forward the role of *JERF1* in plant-virus interaction.

During this study, *JERF1* was also inserted into yeast vector pEGKG for heterologous protein expression. pEGKG is a GST fusion vector which will provide the purification of *JERF1* protein. One of the future works is the isolation of *JERF1* protein for *in vitro* protein-protein interactions. pEGKG-*JERF1* construct will be isolated from *E.coli* and transformed into a yeast strain whose proteases are inhibited so that high levels of protein expression will be obtained.

Finding of subcellular localization of the *JERF1* protein was also attempted during this study. To observe where *JERF1* is localized before and after virus infection, the gene was subcloned into 2 GFP fusion proteins. GFP-N-Bin vector contains GFP signal at the N terminus whereas GFP-C-Bin vector contains GFP signal at the C terminus of the inserted gene. These two constructs were both prepared in order to minimize the possibility of GFP to obstruct proper folding of the *JERF1* protein. Microscopic observations have clearly shown that GFP is expressed in *Arabidopsis thaliana* cell culture. However subcellular localization could not be observed because it needs a confocal microscope. Another reason for not seeing the localization might be the clustering of *Arabidopsis* cells. Since suspension cultures were used in this

experiment, single cell formation is not possible because the plant cells have the tendency to form calli.

## 6 CONCLUSION

Although gene sequence of *JERF1* is present in the databases, there has been no functional data about JERF1 in the literature. In this study, we have cloned full length *JERF1* from tomato cDNA. In order to obtain information about the function of JERF1, we have subcloned the gene into several expression vectors including silencing, overexpression, yeast mating assay, yeast protein expression and GFP-fusion vectors.

We have observed a death phenotype in *JERF1*-silenced susceptible (nn) *N. benthamiana* plants upon challenging with TMV. This implies the possible role of JERF1 in virus pathogenicity of tomato plants.

In order to confirm the role of JERF1 in virus pathogenicity, overexpression analysis was aimed however, due to time limitations, this experiment could not be finalized.

GFP-fused JERF1 constructs can be used for analysis of subcellular localization of the protein. Confocal microscopy and cellular fractionation assays will give information about the subcellular localization of the protein.

Yeast mating assay implies that JERF1 interacts with plant P58<sup>IPK</sup>. Other interactors of JERF1 can be found by mating assays with other proteins. Moreover, *in vitro* protein-protein interaction experiments will demonstrate the interactors of JERF1 protein so that the possible role of JERF1 in a specific signaling pathway can be characterized.

Due to time limitations, most of the functional analyses could not be accomplished. Future works include, stable transformant plants carrying silencing constructs, analysis of mutant plants of *JERF1*, *in vitro* and *in vivo* protein-pull down assays to find out the interactors of JERF1; chromatin IP to check the DNA binding sites of JERF1 and northern blotting to see the expression levels of *JERF1* in different tissues and in different plants of normal and stress subjected plants. Combination of these studies will probably give the overall picture of JERF1 functioning in plants



## REFERENCES

1. Baker B, Zambryski P, Staskawicz B, Dinesh-Kumar SP, “Signalling in Plant-Microbe Interaction” *Science* 276 (1997) 726-733.
2. Bendahmane A, Köhm BA, Dedi C, Baulcombe DC, “The Coat Protein of Potato Virus X is a Strain-Specific Elicitor of *Rx1*-mediated Virus Resistance in Potato” *Plant J.* 8 (1995) 933-941.
3. Bilgin DD, Liu Y, Schiff M, Dinesh-Kumar SP, “P58<sup>IPK</sup>, a Plant Ortholog of Double-Stranded RNA-Dependent Protein Kinase PKR Inhibitor, Functions in Viral Pathogenesis” *Developmental Cell* 4 (2003) 651-661.
4. Birch PRJ, Avrova AO, Dellagi A, Lacomme C, Santa Cruz S, Lyon GD. “Programmed Cell Death in Plants in Response to Pathogen Attack” *Annual Plant Reviews.* 4 (2000) 175-197
5. Botella BA, Parker JE, Frost LN, Bittner-Eddy PD, Beynon JL, Daniels MJ, Holub EB, Jones JDG, “Three Genes of the *Arabidopsis* RPP1 Complex Resistance Locus Recognize distinct *Peronospora Parasitica* Avirulence Determinants” *Plant Cell* 10 (1998) 1847-1860.
6. Buchanan BB, Gruissem W, Jones RL, “Biochemistry & Molecular Biology of Plants” Second Impression, *American Society of Plant Physiologists* 2000.
7. Carrington JC, Kasschau KD, Mahajan SK, Schaad MC, “Cell-to-Cell and Long-Distance Transport of Viruses in Plants” *Plant Cell* 8 (1996) 1669–1681.
8. Chang C, Shockey JA, “The Ethylene-Response Pathway: Signal Perception to Gene Regulation” *Curr. Opin. Plant Biol.* 2 (1999) 352-358.
9. Cheng WH, Endo A, Zhou L, Penney J, Chen HC, Arroyo A, Leon P, Nambara E, Asami T, Seo M, Koshiba T, Sheen J. “A unique short-chain

- dehydrogenase/reductase in Arabidopsis glucose signaling and abscisic acid biosynthesis and functions” *Plant Cell*. 11 (2002)2645-26499.
10. Chini A, Grant JJ, Seki M, Shinozaki K, Loake GJ, “Drought Tolerance Established by Enhanced Expression of the CC-NBS-LRR Gene, ADR1, Requires Salicylic Acid, EDS1 and ABI1” *Plant J*. 38 (2004) 810-822.
  11. Dangl JL, Jones JDG, “Plant Pathogens and Integrated Defence Responses to Infection” *Nature* 411 (2001) 826-833.
  12. Delaney TP, Uknes S, Vernooij B, Friedrich L, Weymann K, Negrotto D, Gaffney T, Gut-Rella M, Kessmann H, Ward E, Ryals J, “A Central Role of Salicylic Acid in Plant Disease Resistance” *Science* 266 (1994) 1247-1250.
  13. Dion M, Chamberland H, St-Michel C, Plante M, Darveau A, Lafontaine JG, Brisson LF, “Detection of a Homologue of bcl-2 in Plant Cells” *Biochem. Cell Biol.* 75 (1997) 457-461.
  14. Doke N, Ohashi Y, “Involvement of an O<sub>2</sub> Generating System in the Induction of Necrotic Lesions on Tobacco Leaves Infected with Tobacco Mosaic Virus” *Physiol. Mol. Plant Pathol.* 32 (1988) 163-175.
  15. Ellis J, Jones D, “Structure and Function of Proteins Controlling Strain-Specific Pathogen Resistance in Plants” *Curr. Opin. Plant Biol.* 1 (1998) 288-293.
  16. Ellis JG, Lawrence GJ, Luck JE, Dodds PN, “Identification of Regions in Alleles of the Flax Rust Resistance Gene *L* That Determine Differences in Gene-for-Gene Specificity” *Plant Cell* 11 (1999) 495-506.
  17. Flor HH, “Current Status of the Gene-for-Gene Concept” *Annu. Rev. Phytopathol.* 9 (1971) 275-296.
  18. Fujimoto SY, Ohta M, Usui A, Shinshi H, Ohme-Takagi M “Arabidopsis ethylene-responsive element binding factors act as transcriptional activators or repressors of GCC box-mediated gene expression” *Plant Cell*. 3 (2000):393-404
  19. Gaffney T, Friedrich L, Vernooij B, Negrotto D, Nye G, Uknes S, Ward E, Kessmann H, Ryals J, “Requirement of Salicylic Acid for the Induction of Systemic Acquired Resistance” *Science* 261 (1993) 754-756.

20. Gale Jr. M, Katze MG, “Molecular Mechanisms of Interferon Resistance Mediated by Viral-Directed Inhibition of PKR, the Interferon-Induced Protein Kinase” *Pharmacol. Ther.* 78 (1998) 29-46.
21. Gassmann W, Hinsch ME, Staskawicz BJ, “The Arabidopsis RPS4 bacterial-resistance gene is a member of the TIR-NBS-LRR family of disease-resistance genes” *Plant J.* 3 (1999) 265-77
22. Gil J, Esteban M, Roth D, “In Vivo Regulation of Protein Synthesis by Phosphorylation of the  $\alpha$  Subunit of Wheat Eukaryotic Initiation Factor 2” *Biochemistry* 39 (2000) 7521-7530.
23. Gong W, Shen Y-P, Ma L-T, Pan Y, Du Y-L, Wang D-H, Yang J-Y, Hu L-D, Liu X-F, Dong C-X, Ma L, Chen Y-H, Yang X-Y, Gao Y, Zhu D, Tan X, Mu J-Y, Zhang D-B, Liu Y-L, Dinesh-Kumar SP, Li Y, Wang X-P, Gu H-Y, Qu L-J, Bai S-N, Lu Y-T, Li J-Y, Zhao J-D, Zuo J, Huang H, Deng XW, Zhu Y-X, “Genome-Wide ORFeome Cloning and Analysis of Arabidopsis Transcription Factor Genes” *Plant Physiology* 135 (2004) 773-782.
24. Gu Y-Q, Wildermuth MC, Chakravarthy S, Loh Y-T, Yang C, He X, Han Y, Martin GB, “Tomato Transcription Factors Pti4, Pti5 and Pti6 Activate Defense Responses when Expressed in Arabidopsis” *Plant Cell* 14 (2002) 817-831.
25. Gu Y-Q, Yang C, Thara VK, Zhou J, Martin GB, “Pti4 is Induced by Ethylene and Salicylic Acid and its Product is Phosphorylated by the Pto Kinase” *Plant Cell* 12 (2000) 771-786.
26. Gutterson N, Reuber TL, “Regulation of disease resistance pathways by AP2/ERF transcription factors” *Curr. Opin. Plant Biol.* 7 (2004) 465–471
27. Hammond-Kosack KE, Jones DJG, “Resistance Gene-Dependent Plant Defense Responses” *Plant Cell* 8 (1996) 1773-1791.
28. Jarpe MB, Widmann C, Knall C, Schlesinger TK, Gibson S, Yujiri T, Fanger GR, Gelfand EW, Johnson GL, “Anti-Apoptotic versus Pro-Apoptotic Signal Transduction: Check-Points and Stop Signs along the Road to Death” *Oncogene* 17 (1998) 1475-1482.

29. Jofuku KD, den Boer BGW, Montagu MV, Okamoto JK, "Control of Arabidopsis Flower and Seed Development by the Homeotic Gene *APETHALA2*" *Plant Cell* 6 (1994) 1211-1225.
30. Jones CG, Tucker GA, Lycett GW, "Pattern of Expression and Characteristics of a Cysteine Proteinase cDNA from Germinating Seeds of Pea (*Pisum sativum* L.)" *Biochim. Biophys. Acta.* 129 (1996) 613-615.
31. Kiziz D, Lumbreras V, Pagès M, "Role of AP2/EREBP Transcription Factors in Gene Regulation During Abiotic Stress" *FEBS Letters* 498 (2001) 187-189.
32. Kobe B, Deisenhofer J, "The Leucine-Rich Repeat: A Versatile Binding Motif" *Trans Biochem. Sci.* 19 (1994) 415-421.
33. Krebs J, "The Role of Calcium in Apoptosis" *Biometals* 11 (1998) 375-382.
34. Langland JO, Langland LA, Browning KS, Roth DA, "Phosphorylation of Plant Eukaryotic Initiation Factor-2 by the Plant-encoded Double-stranded RNA-dependent Protein Kinase, pPKR, and Inhibition of Protein Synthesis *in Vitro*" *Journal of Biol. Chem.* 271 (1996) 4539-4544.
35. Lawrence GJ, Finnegan EJ, Ayliffe MA, Ellis JG, "The *L6* Gene for Flax Rust Resistance is Related to the Arabidopsis Bacterial Resistance Gene *RPS2* and the Tobacco Viral Resistance Gene *N*" *Plant Cell* 7 (1995) 1195-1206.
36. Lawton KA, Potter SL, Uknes S, Ryals J, "Acquired Resistance Signal Transduction in Arabidopsis is Ethylene Independent" *Plant Cell* 6 (1994) 581-588.
37. Lemaitre B, Nicolas E, Michaut L, Reichhart J-M, Hoffmann JA, "The Dorsoventral Regulatory Gene Cassette *spätzle/Toll/cactus* Controls the Potent Antifungal Response in Drosophila Adults" *Cell* 86 (1996) 973-983.
38. Levine A, Pennell RI, Alvarez ME, Palmer R, Lamb C, "Calcium-Mediated Apoptosis in Plant Hypersensitive Disease Resistance Response" *Curr. Biol.* 6 (1996) 427-437.
39. Liu Y, Schiff M, Dinesh-Kumar SP, "Virus-induced gene silencing in tomato" *Plant J.* 6 (2002) 777-786.

40. Lorenzo O, Piqueras R, Sanchez-Serrano JJ, Solano R, "ETHYLENE RESPONSE FACTOR1 integrates signals from ethylene and jasmonate pathways in plant defense" *Plant Cell* 1(2003) 165-178.
41. Luck JE, Lawrence GJ, Dodds PN, Shepherd KW, Ellis JG, "Regions outside of the Leucine-Rich Repeats of Flax Rust Resistance Proteins Play a Role in Specificity Determination" *Plant Cell* 12 (2000) 1367-1377.
42. Martin GB, Bogdanove AJ, Sessa G, "Understanding the Functions of Plant Disease Resistance Proteins" *Annu. Rev. Plant Biol.* 54 (2003) 23-61.
43. Medzhitov R, Preston-Hurlburt P, Janeway CA, "A Human Homologue of the Drosophila Toll Protein Signals Activation of Adaptive Immunity" *Nature* 338 (1997) 394-397.
44. Mittler R, Del Pozo O, Meisel L, Lam E, "Pathogen-Induced Programmed Cell Death in Plants, a Possible Defense Mechanism" *Developmental Genetics* 21 (1997) 279-289.
45. Moffett P, Farnham G, Peart J, Baulcombe DC, "Interaction between Domains of a Plant NBS-LRR Protein in Disease Resistance-Related Cell Death" *EMBO J.* 21 (2002) 4511- 4519.
46. Ohme-Takagi M, Shinshi H, "Ethylene-inducible DNA binding proteins that interact with an ethylene-responsive element" *Plant Cell.* 2 (1995) 173-82
47. Okamoto JK, Caster B, Villarreal R, Montagu MV, Jofuku KD, "The AP2 Domain of *APETALA2* Defines a Large New Family of DNA Binding Proteins in Arabidopsis" *Proc. Natl. Acad. Sci. USA* 94 (1997) 7076-7081.
48. Parker JE, Coleman MJ, Szabo V, Frost LN, Schmidt R, van der Biezen EA, Moores T, Dean C, Daniels MJ, Jones JD, "The Arabidopsis downy mildew resistance gene *RPP5* shares similarity to the toll and interleukin-1 receptors with N and L6" *Plant Cell.* 6 (1997) 879-894
49. Pedley KF, Martin GB, "Molecular Basis of Pto-mediated Resistance to Bacterial Speck Disease in Tomato" *Annu. Rev. Phytopathol.* 41 (2003) 215-243.

50. Prescott LM, Harley JP, Klein DA, "Microbiology" Fifth Edition, *McGraw Hill* 2002
51. Reymond P, Weber H, Dammond M, Farmer EE, "Differential Gene Expression in Response to Mechanical Wounding and Insect Feeding in *Arabidopsis*" *Plant Cell* 12 (2000) 707-719.
52. Riechmann JL, Heard J, Martin G, Reuber L, Jiang C-Z, Keddie J, Adam L, Pineda O, Ratcliffe OJ, Samaha RR, Creelman R, Pilgrim M, Broun P, Zhang JZ, Ghandehari D, Sherman BK, Yu G-L, "Arabidopsis Transcription Factors: Genome-Wide Comparative Analysis Among Eukaryotes" *Science* 290 ( 2000) 2105-2110.
53. Ruiz MT, Voinnet O, Baulcombe DC "Initiation and maintenance of virus-induced gene silencing" *Plant Cell*. 6 (1998) 937-946
54. Sakuma Y, Liu Q, Dubouzet JG, Abe H, Shinozaki K, Yamaguchi-Shinozaki K, "DNA-Binding Specificity of the ERF/AP2 Domain of Arabidopsis DREBs, Transcription Factors Involved in Dehydration- and Cold-Inducible Gene Expression" *Biochem. Biophys. Res. Commun* 290(2002) 998-1009.
55. Sessa G, D'Ascenzo M, Martin GB, "Thr38 Ser198 are Pto Autophosphorylation Sites Required for the AvrPto-Pto-mediated Hypersensitive Response" *EMBO J*. 19 (2000) 2257-2269.
56. Shinozaki K, Dennis ES, "Cell Signaling and Gene Regulation Global Analysis of Signal Transduction and Gene Expression Profiles" *Curr. Opin. Plant Biol*. 6 (2003) 405-409.
57. Song W-Y, Wang G-L, Chen L-L, Kim H-S, Pi L-Y, Holsten T, Gardner J, Wang B, Zhai W-X, Zhu L-H, Fauquet C, Ronald P, "A Receptor Kinase-like Protein Encoded by the Rice Disease Resistance Gene, *Xa21*" *Science* 270 (1995) 1804-1806.
58. Sticher L, Mauch-Mani B, Metraux JP, "Systemic acquired resistance" *Annu. Rev. Phytopathol*. 35 (1997) 235-70

59. Suzuki K, Fukuda Y, Shinshi H, “Studies on Elicitor-Signal Transduction leading to Differential Expression of Defense Genes in Cultured Tobacco Cells” *Plant Cell Physiol.* 36 (1995) 281-289.
60. van der Biezen EA, Jones JDG, “The NB-ARC Domain: A Novel Signalling Motif shared by Plant Resistance Gene Products and Regulators of Cell Death in Animals” *Curr. Biol.* 8 (1998) R226-R227.
61. Volpe F, Clatworthy J, Kaptein A, Maschera B, Griffin A-M, Ray K, “The IL-1 Receptor Accessory Protein is Responsible for the Recruitment of the Interleukin-1 Receptor Associated Kinase to the IL-1/IL-1 Receptor I Complex” *FEBS Letters* 419 (1997) 41-44.
62. Vom Endt D, Kijne JW, Memelink J, “Transcription Factors Controlling Plant Secondary Metabolism: What Regulates the Regulators?” *Phytochemistry* 61 (2002) 107-114.
63. Waterhouse PM, Wang M-B, Lough T, “Gene Silencing as an Adaptive Defence Against Viruses” *Nature* 411 (2001) 834-841.
64. Whitham S, Dinesh-Kumar SP, Choi D, Hehl R, Corr C, Baker B, “The Product of the Tobacco Mosaic Virus Resistance Gene *N*: Similarity to Toll and the Interleukin-1 Receptor” *Cell* 78 (1994) 1101-1115.
65. Xie DX, Feys BF, James S, Nieto-Rostro M, Turner JG, “An Arabidopsis Gene Required for Jasmonate-Regulated Defense and Fertility” *Science* 280 (1998) 1091-1094.
66. Xu Y, Chang P F L, Liu D, Narasimhan M L, Raghothama K G, Hasegawa P M, Bressan R.A “Plant defense genes are synergistically induced by ethylene and methyl jasmonate” *Plant Cell.* 6 (1994) 1077–1085
67. Yang J, Steward R, “A Multimeric Complex and the Nuclear Targeting of the *Drosophila* *reI* Protein Dorsal” *Proc. Natl. Acad. Sci. USA* 94 (1997) 14524-14529.
68. Yang Y, Shah J, Klessig DF, “Signal Perception and Transduction in Plant Defense Responses” *Genes and Development* 11 (1997) 1621-1639.

69. Zhang JZ, “Overexpression Analysis of Plant Transcription Factors” *Curr. Opin. Plant Biol.* 6 (2003) 430-440.
70. Zhang S, Klessig DF, “Resistance Gene *N*-mediated *de novo* Synthesis and Activation of a Tobacco Mitogen-Activated Protein Kinase by Tobacco Mosaic Virus Infection” *Proc. Natl. Acad. Sci. USA* 95 (1998) 7433-7438.
71. Zhou J, Tang X, Martin GB, “The Pto kinase conferring resistance to tomato bacterial speck disease interacts with proteins that bind a *cis*-element of pathogenesis-related genes” *EMBO J.* 11 (1997) 3207-3218.
72. Zhu T, “Global Analysis of Gene Expression Using GeneChip Microarrays” *Curr. Opin. Plant Biol.* 6 (2003) 418-425.



## APPENDIX A

### Primer Sequences:

A1) 190 forward primer

5' TTCAAATTG AGCTTTTTCTCCATTAAAATT 3'

A2) 194 reverse primer

5' TTATGAAAACAAGGATACATACTTACATAT 3'

A3) 195 forward primer

5' GGTCTAGAGGATCCGTCAGTTTTTTTCGAAGAGAAACCAG 3'

*XbaI*    *BamHI*

A4) 196 reverse primer

5' GGGAATTCGGGGTACCGGATGAGATCTCTGGAGTCCTTGCAC 3'

*EcoRI*    *KpnI*

A5) 199 forward primer

5' GGGGATCCAAGCTTGATGTTCAAATTGAGCTTTTTCTCCATT 3'

*BamHI*    *HindIII*

A6) 200 reverse primer

5' GGGAATTCTCTAGAGTTATGAAAACAAGGATACATACTT 3'

*EcoRI*    *XbaI*

A7) 201 forward primer

5' GGGAATTCCCGCGGCCGCCATGTTCAAATTGAGCTTTTTCTCC 3'

*EcoRI*            *NotI*

**A8)** 202 reverse primer

5' GGGAATTCCCGAGCTCGGTTATGAAAACAAGGATACATACTTTAT 3'

*EcoRI*      *SacI*

**A9)** 207 forward primer

5' GGGGGTCTAGACTCCATGGGTCGACTCGAGATGTTCAAATTGAGCTTTTTCTCCA

Homologous recombination site

TAAA 3'

**A10)** 208 reverse primer

5' GCGAGGCAGATCGTCAGTCAGTCACGATGATTATGAAAACAAGGATACATACTT

Homologous recombination site

ACATAT 3'

**A11)** BD1 forward primer

5' GGGACAAGTTTGTACAAAAAGCAGGCTTTTTCAAATTGAGCTTTTTCTCC 3'

*attB1*

**A12)** BD5 reverse primer

5' GGGGACCACTTTGTACAAGAAAGCTGGGTTTTATGAAAACAAGGATACATA 3'

*attB2*

**A13)** 162 forward primer

5' CCCTCTAGACGCGGCCGCCAAAAGGCACTTCGTGAGGAAACC 3'

*XbaI*      *NotI*

**A14)** 163 reverse primer

5' CCCGGTACCGTCGACCCAATTTCCCTCGAGATATGGGAT 3'

*KpnI*      *SalI*

**A15)** 154 forward primer

5' GATTTGGTACCTCCTAGCCGGATTTCTCGCCGG 3'

**A16)** 147 reverse primer

5' CACATTCTCGAAGCCGTACGTCTTGGTTGC 3'

## APPENDIX B

### Vector Maps

#### B1) pCR<sup>®</sup>-II-TOPO4<sup>®</sup> (Invitrogen)

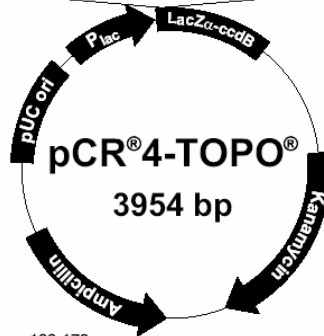
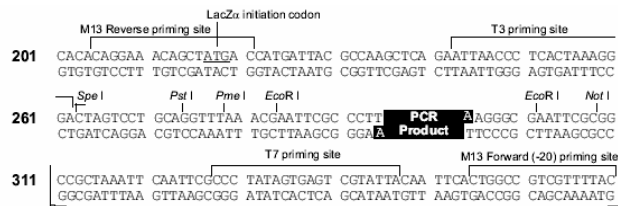

#### Comments for pCR<sup>®</sup>4-TOPO<sup>®</sup> 3954 nucleotides

*lac* promoter region: bases 2-216  
 CAP binding site: bases 95-132  
 RNA polymerase binding site: bases 133-178  
 Lac repressor binding site: bases 179-199  
 Start of transcription: base 179  
 M13 Reverse priming site: bases 205-221  
 LacZα-*ccdB* gene fusion: bases 217-810  
   LacZα portion of fusion: bases 217-497  
   *ccdB* portion of fusion: bases 508-810  
 T3 priming site: bases 243-262  
 TOPO<sup>®</sup> Cloning site: bases 294-295  
 T7 priming site: bases 328-347  
 M13 Forward (-20) priming site: bases 355-370  
 Kanamycin promoter: bases 1021-1070  
 Kanamycin resistance gene: bases 1159-1953  
 Ampicillin (*bla*) resistance gene: bases 2309-3061 (c)  
 Ampicillin (*bla*) promoter: bases 3062-3158 (c)  
 pUC origin: bases 3159-3832  
 (c) = complementary strand

B2) pGR106

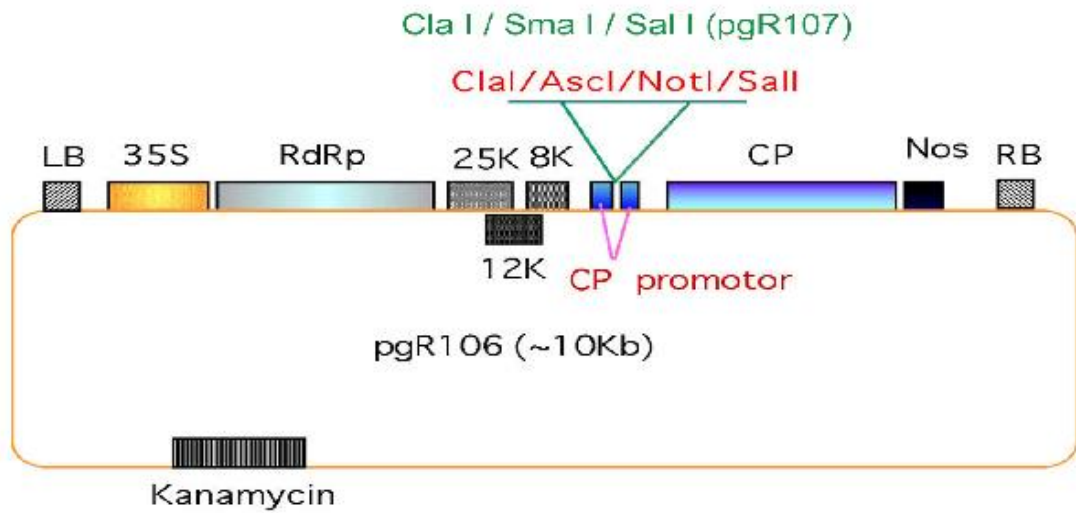

B3) pTRV2

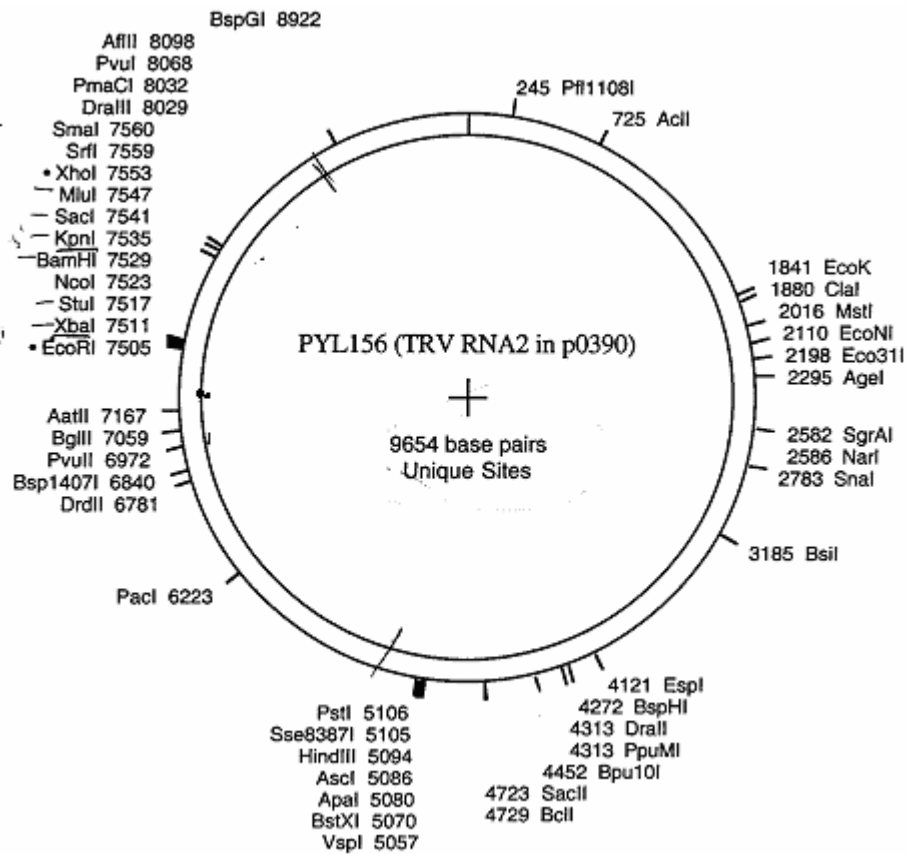

## B4) pJG4-5

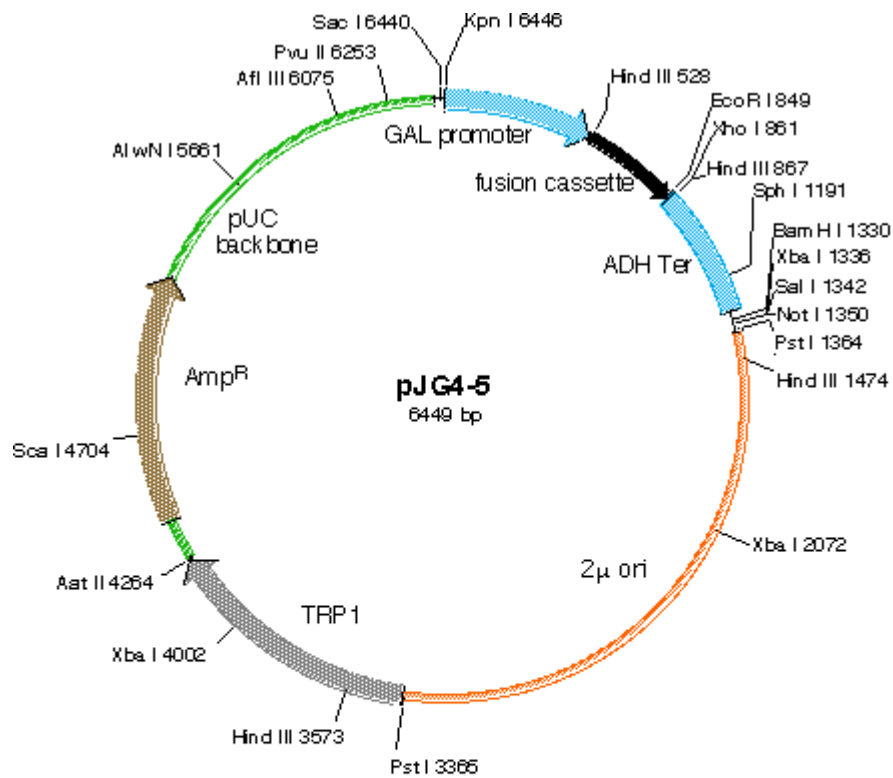

fusion cassette:

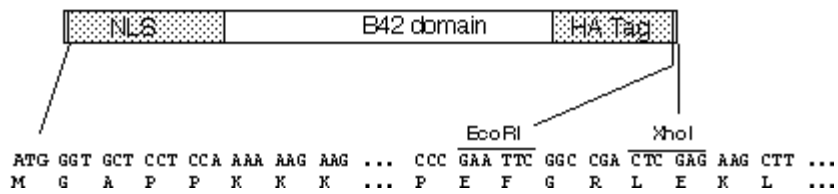

B5) pTBSI

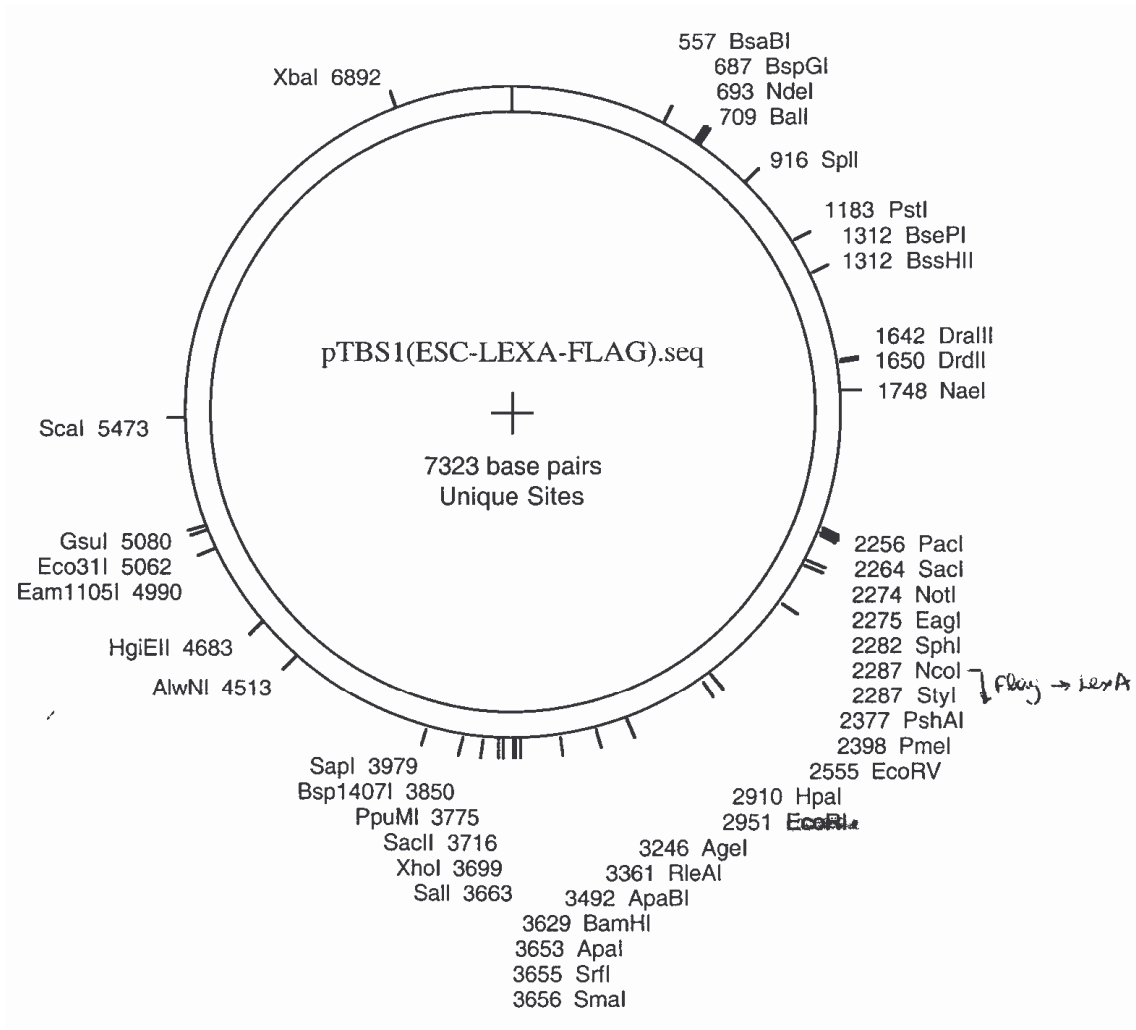

B6) pRTL2-GUS/NiaΔBam

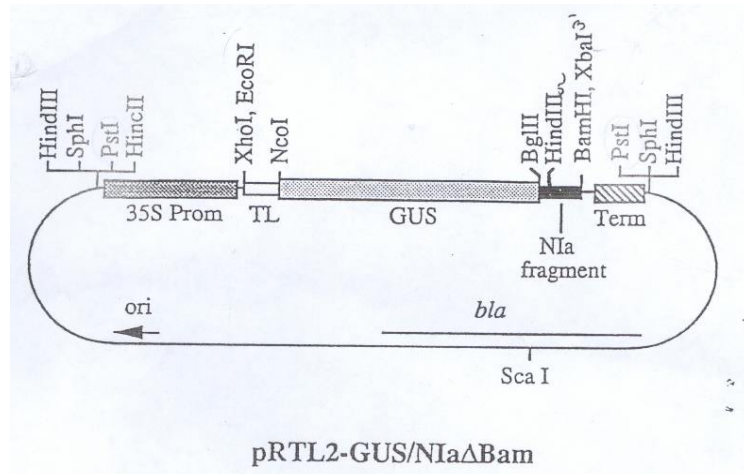

B7) pEGKG

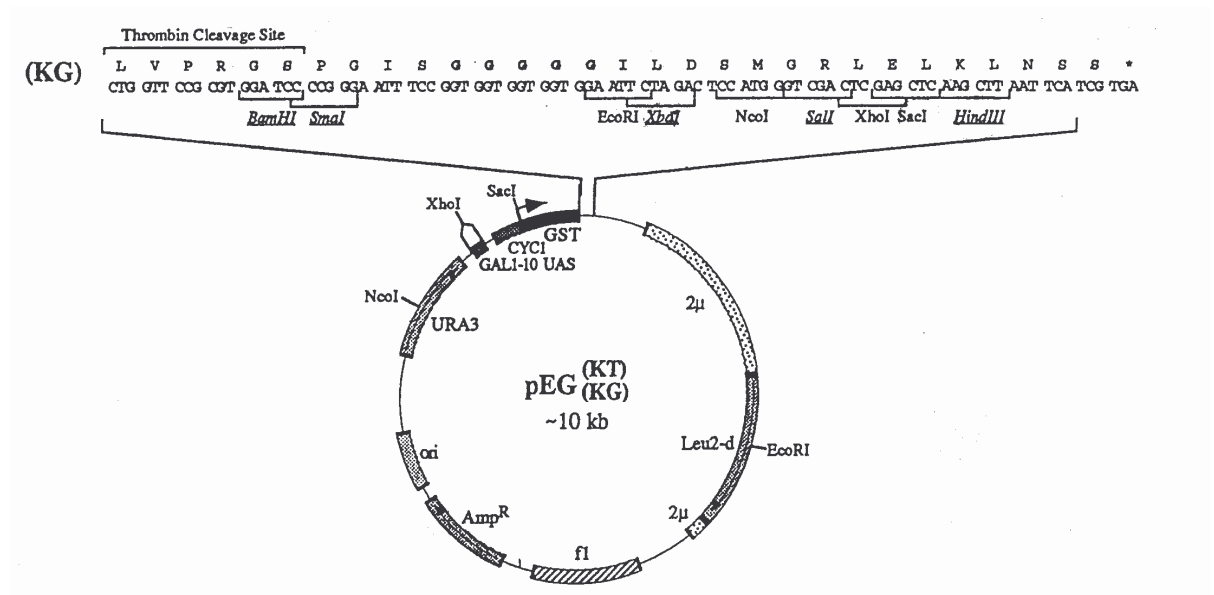

## B8) pDONR-221<sup>®</sup> (Invitrogen)

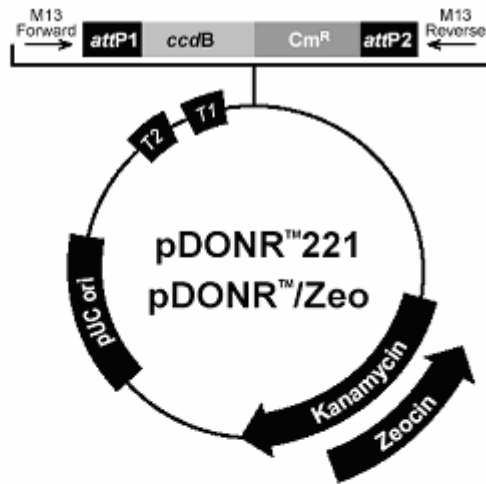

Comments for:

	pDONR <sup>™</sup> 221 4762 nucleotides	pDONR <sup>™</sup> /Zeo 4291 nucleotides
<i>rrmB</i> T2 transcription termination sequence (c):	268-295	268-295
<i>rrmB</i> T1 transcription termination sequence (c):	427-470	427-470
M13 Forward (-20) priming site:	537-552	537-552
attP1:	570-801	570-801
<i>ccdB</i> gene (c):	1197-1502	1197-1502
Chloramphenicol resistance gene (c):	1847-2506	1847-2506
attP2 (c):	2754-2985	2754-2985
M13 Reverse priming site:	3027-3043	3027-3043
Kanamycin resistance gene:	3156-3965	---
EM7 promoter (c):	---	3486-3552
Zeocin resistance gene (c):	---	3111-3485
pUC origin:	4086-4759	3615-4288
(c) = complementary strand		

## B9) GFP-N-Bin

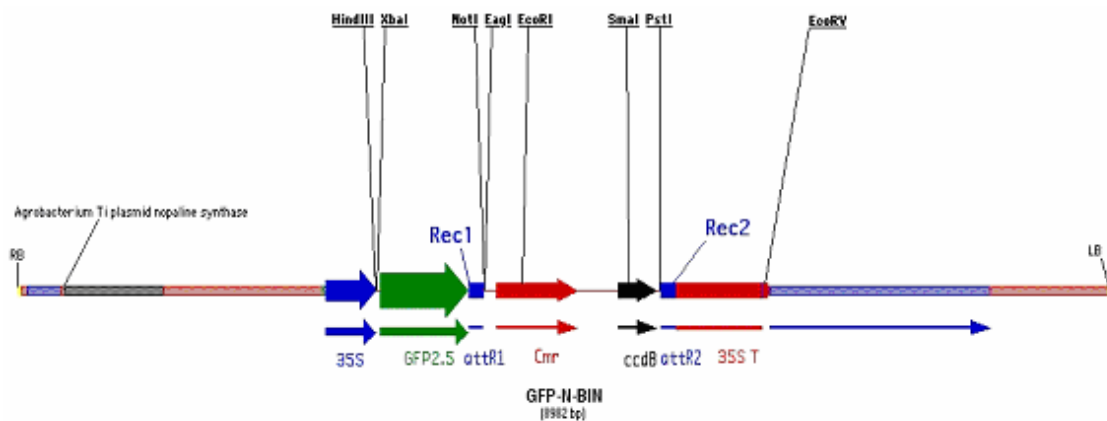



## APPENDIX C

All the sequence alignments in the Appendix C were done on the SDSC Biology Workbench

### C1) Sequence alignment of DB90 with JERF1

```
Name: DB90           Len: 1391  Check:  9060   Weight: 1.00
Name: JerfOriseq    Len: 1391  Check:  8138   Weight: 1.00
//
      1                               60
DB90  ..CAAATTGAGCTTNTTCTCCATTAATAATCTCTCTGCAAATTTATAGTTNTTCTTTTT
JERfOriseq TTCAAATTGAGCTTTTTCTCCATTAATAATCTCTCTGCAAATTTATAGTTTCTTTTT
      1                               60

      61                               120
DB90  CACTTTTTGAGAAGAAATCAAAGCTATGTGTGGTGGTGAATTATCTCCGATTTGGTAC
JERfOriseq CACTTTTTGAGAAGAAATCAAAGCTATGTGTGGTGGTGAATTATCTCCGATTTGGTAC

      121                              180
DB90  CTCCTAGCCGGATTTCTCGCCGGTTAACCCTGATTTTCTATGGGGTACATCCGATCTGA
JERfOriseq CTCCTAGCCGGATTTCTCGCCGGTTAACCCTGATTTTCTATGGGGTACATCCGATCTGA

      181                              240
DB90  ACAAGAAGAAGAAGAAC.....AATTACCACTCAAAGCCCTTGAGGTNTAAGTTTATTG
JERfOriseq ACAAGAAGAAGAAGAACCCCTAGTAATTACCACTCAAAGCCCTTGAGGTCTAAGTTTATTG

      241                              300
DB90  ACCNTGAAGATGAATTTGAAGCTGACTTTCAGCACTTCAAGGATAATTCTGATGATGATG
JERfOriseq ACCTTGAAGATGAATTTGAAGCTGACTTTCAGCACTTCAAGGATAATTCTGATGATGATG

      301                              360
DB90  ATGATGTGAAGGCATTTGGCCCCAAATCCGTGAGATCTGGTGATTCAAACGCGAAGCTG
JERfOriseq ATGATGTGAAGGCATTTGGCCCCAAATCCGTGAGATCTGGTGATTCAAACGCGAAGCTG

      361                              420
DB90  ACAGATCCTCCAAGAGAAAGAGGAAGAATCAGTACCGGGGGATCAGACAGCGTCTTGGG
JERfOriseq ACAGATCCTCCAAGAGAAAGAGGAAGAATCAGTACCGGGGGATCAGACAGCGTCTTGGG

      421                              480
DB90  GTAAGTGGGCAGCTGAAATACGTGATCCAAGGAAAGGTATTCGAGTCTGGCTTGGTACTT
JERfOriseq GTAAGTGGGCAGCTGAAATACGTGATCCAAGGAAAGGTATTCGAGTCTGGCTTGGTACTT

      481                              540
DB90  TCAATTCAGCCGAAGAGGCAGCCAGAGCTTATGATGCTGAGGCGGAAGGATCAGAGGCA
JERfOriseq TCAATTCAGCCGAAGAGGCAGCCAGAGCTTATGATGCTGAGGCGGAAGGATCAGAGGCA

      541                              600
DB90  AGAAAGCTAAGGTGAACTTTCCTGATGAAGCTCCAGTGTCTGTTTCAAGACGTGCTATTA
JERfOriseq AGAAAGCTAAGGTGAACTTTCCTGATGAAGCTCCAGTGTCTGTTTCAAGACGTGCTATTA

      601                              660
DB90  AGCAAAATCCCCAAAAGGCACTTTCGTGAGGAAACCTGAACACAGTTTCAGCCCAACATGA
JERfOriseq AGCAAAATCCCCAAAAGGCACTTTCGTGAGGAAACCTGAACACAGTTTCAGCCCAACATGA

      661                              720
DB90  CTTATATTAGTAACCTGGATGGTGGATCTGATGATTCGTTTCAGTTTTTTTGAAGAGAAAC
JERfOriseq CTTATATTAGTAACCTGGATGGTGGATCTGATGATTCGTTTCAGTTTTTTTGAAGAGAAAC
```

```

721 780
DB90 CAGCAACCAAGCAGTACGGCTTCGAGAATGTGTCTTTTACTGCTGTAGATATGGGACTGG
JERF1Oriseq CAGCAACCAAGCAGTACGGCTTCGAGAATGTGTCTTTTACTGCTGTAGATATGGGACTGG

781 840
DB90 GCTCAGTTTCCCCTTCAGCCGGTACAAATGTTTACTTCAGCTCTGATGAAGCAAGTAACA
JERF1Oriseq GCTCAGTTTCCCCTTCAGCTGGTACAAATGTTTACTTCAGCTCTGATGAAGCAAGTAACA

841 900
DB90 CTTTGTACTGCTCTGATTTTCGGTTGGGCTGAACCGTGTGCAAGGACTCCAGAGATCTCAT
JERF1Oriseq CTTTGTACTGCTCTGATTTTCGGTTGGGCTGAACCGTGTGCAAGGACTCCAGAGATCTCAT

901 960
DB90 CTGTCTGTGCGAAGTTCTGGAAACCAATGAGACTCATTGATGATGATTCCAGACCGG
JERF1Oriseq CTGTCTGTGCGAAGTTCTGGAAACCAATGAGACTCATTGATGATGATTCCAGACCGG

961 1020
DB90 AGAAAAAAGTGAAGTCCTGTTCCAGCACTTCATTGACAGTTGACGGTAACACTGTGAACA
JERF1Oriseq AGAAAAAAGTGAAGTCCTGTTCCAGCACTTCATTGACAGTTGACGGTAACACTGTGAACA

1021 1080
DB90 CGCTATCTGAAGAGCTATCGGCTTTTGAATCCCAGATGAAGTTCTTGCAGATCCCATATC
JERF1Oriseq CGCTATCTGAAGAGCTATCGGCTTTTGAATCCCAGATGAAGTTCTTGCAGATCCCATATC

1081 1140
DB90 TCGAGGGAAATTGGGATGCATCGGTTGATGCCTTCTCAATACAAGTGCAATTCAGGATG
JERF1Oriseq TCGAGGGAAATTGGGATGCATCGGTTGATGCCTTCTCAATACAAGTGCAATTCAGGATG

1141 1200
DB90 GTGGAAACGCCATGGACCTTTGGTCTTCGATGATGTACCTTCTTAATGGGAGGTGCCT
JERF1Oriseq GTGGAAACGCCATGGACCTTTGGTCTTCGATGATGTACCTTCTTAATGGGAGGTGCCT

1201 1260
DB90 ACTAAGCTGCATACACATCTTCCCTTGCTAAGTTTTGTAAATAACGCTTCATTGAGTGA
JERF1Oriseq ACTAAGCTGCATACACATCTTCCCTTGCTAAGTTTTGTAAATAACGCTTCATTGAGTGA

1261 1320
DB90 AGTTTGCGCCTGCGTTTACGTTTATCACCAAACAAAAGACTATATATGTGTTGTATTAA
JERF1Oriseq AGTTTGCGCCTGCGTTTACGTTTATCACCAAACAAAAGACTATATATGTGTTGTATTAA

1321 1380
DB90 TTTATTCAAAATTTACTCGTTTGATATATGTAAGTATGTATCCTTGTTCATAAAA...
JERF1Oriseq TTTATTCAAAATTTACTCGTTTGATATATGTAAGTATGTATCCTTGTTCATAAAAAAA

1381 1391
DB90 .....
JERF1Oriseq AAAAAAAAAA

```

## C2) Sequence alignment of DB 109 with JERF1

```

114 173
DB109 TTCAAATTGAGCTTTTTCTCCATTAATAATCTCTCTGTAAATTTATAGTTTTCTTTTT
JERF1Oriseq TTCAAATTGAGCTTTTTCTCCATTAATAATCTCTCTGCAAATTTATAGTTTTCTTTTT
1

174 233
DB109 TTCACTTTTTGAGAAGAAATCAAAGCTATGTGTGGTGGTGCAATTATCTCCGATTTGGT
JERF1Oriseq TTCACTTTTTGAGAAGAAATCAAAGCTATGTGTGGTGGTGCAATTATCTCCGATTTGGT

234 293
DB109 ACCTCCTAGCCGGATTTCTCGCCGGTTAACCGCTGATTTTCTATGGGGTACATCCGATCT
JERF1Oriseq ACCTCCTAGCCGGATTTCTCGCCGGTTAACCGCTGATTTTCTATGGGGTACATCCGATCT

294 353
DB109 GAACAAGAAGAAGAAGAACCTTAGTAATTACCACTCAAAGCCCTTGAGGTCTAAGTTTAT
JERF1Oriseq GAACAAGAAGAAGAAGAACCTTAGTAATTACCACTCAAAGCCCTTGAGGTCTAAGTTTAT

354 413
DB109 TGACCTTGAAGATGAATTTGAAGCTGACTTTCAGCACTTCAAGGATAATTCTGATGATGA
JERF1Oriseq TGACCTTGAAGATGAATTTGAAGCTGACTTTCAGCACTTCAAGGATAATTCTGATGATGA

```

414 473  
DB109 TGATGATGGTGAAGGCATTTGGCCCCAAATCCGTGAGATCTGGTGATTCAAACCTGCCGAAG  
JERF1Oriseq TGATGATGGTGAAGGCATTTGGCCCCAAATCCGTGAGATCTGGTGATTCAAACCTGCCGAAG

474 533  
DB109 CTGACAGATCCTCCAAGAGAAAAGAGGAAGAATCAGTACCGGGGGATCAGACAGCGTCCTT  
JERF1Oriseq CTGACAGATCCTCCAAGAGAAAAGAGGAAGAATCAGTACCGGGGGATCAGACAGCGTCCTT

534 593  
DB109 GGGGTAAGTGGGCAGCTGAAATACGTGATCCAAGGAAAGGTATTTCGAGTCTGGCTTGGA  
JERF1Oriseq GGGGTAAGTGGGCAGCTGAAATACGTGATCCAAGGAAAGGTATTTCGAGTCTGGCTTGGA

594 653  
DB109 CTTTCAATTCAGCCGAAGAGGCAGCCAGAGCTTATGATGCTGAGGCGCGAAGGATCAGAG  
JERF1Oriseq CTTTCAATTCAGCCGAAGAGGCAGCCAGAGCTTATGATGCTGAGGCGCGAAGGATCAGAG

654 713  
DB109 GCAAGAAAAGCTAAGGTGAACTTTCCTGATGAAGCTCCAGTGTCTGTTTCAAGACGTGCTA  
JERF1Oriseq GCAAGAAAAGCTAAGGTGAACTTTCCTGATGAAGCTCCAGTGTCTGTTTCAAGACGTGCTA

714 773  
DB109 TTAAGCAAAAATCCCCAAAAGGCACTTCGTGAGGAAACCCTGAACACAGTTTCAGCCCAACA  
JERF1Oriseq TTAAGCAAAAATCCCCAAAAGGCACTTCGTGAGGAAACCCTGAACACAGTTTCAGCCCAACA

774 833  
DB109 TGACTTATATTAGTAACTTGGATGGTGGATCTGATGATTCGTTTCAGTTTTTTTCGAAGAGA  
JERF1Oriseq TGACTTATATTAGTAACTTGGATGGTGGATCTGATGATTCGTTTCAGTTTTTTTCGAAGAGA

834 893  
DB109 AACCCAGCAACCAAGCAGTACGGCTTCGAGAATGTGTCTTTTACTGCTGTAGATAT.GGAC  
JERF1Oriseq AACCCAGCAACCAAGCAGTACGGCTTCGAGAATGTGTCTTTTACTGCTGTAGATATGGGAC

894 953  
DB109 TGGGCTCAGTTTCCCTTCAGCCGGGACAAATGTTTACTTCAGCCTCTGATGAAGCAAGT  
JERF1Oriseq TGGGCTCAGTTTCCCTTCAGCTGGTACAAATGTTTACTTCAG.CTCTGATGAAGCAAGT

954 1013  
DB109 .ACACTTTTGACTGCTCTGATTTTCGGTTGGGCTGAACCGTGTCAAAGG.CTCCCAGAGA  
JERF1Oriseq AACACTTTTGACTGCTCTGATTTTCGGTTGGGCTGAACCGTGTGC.AAGGACT.CCAGAGA

1014 1073  
DB109 TCTCATCTG.TCTGGCCGGAGTTCT.GAAACCAATGAGACTCATTTTGGTGATGATTCCC  
JERF1Oriseq TCTCATCTGTTCTGTGCGAAAGTTCTGGAAACCAATGAGACTCATTTTGGTGATGATTCCA

1074 1097  
DB109 GACCCGGAGAAAAAACCTGAAGTCCTGTTC  
JERF1Oriseq GA.CCAGAGAAAAAA.CTGAAGTCCTGTTC

### C3) Sequence alignment of DB 110 with JERF1

29 88  
DB110 ACTTTTTGAGAAGAAATCAAAGCTATGTGTGGTGGTGAATTATCTCCGATTTGGTACC  
JERF1Oriseq ACTTTTTGAGAAGAAATCAAAGCTATGTGTGGTGGTGAATTATCTCCGATTTGGTACC  
62

89 148  
DB110 CCTCCTAGCCGGATTTCTCGCCGGTTAACCGCTGATTTTCTATGGGGTACATCCGATCTG  
JERF1Oriseq CCTCCTAGCCGGATTTCTCGCCGGTTAACCGCTGATTTTCTATGGGGTACATCCGATCTG

149 208  
DB110 AACCAAGAAGAAGAACCCTAGTAATTACCACTCAAAGCCCTTGAGGTCTAAGTTTATT  
JERF1Oriseq AACCAAGAAGAAGAACCCTAGTAATTACCACTCAAAGCCCTTGAGGTCTAAGTTTATT

209 268  
DB110 GACCTTGAAGATGAATTTGAAGCTGACTTTCAGCACTTCAAGGATAATTCTGATGATGAT  
JERF1Oriseq GACCTTGAAGATGAATTTGAAGCTGACTTTCAGCACTTCAAGGATAATTCTGATGATGAT

269 328  
DB110 GATGATGTGAAGGCATTTGGCCCCAAATCCGTGAGATCTGGTGATTCAAACCTGCCGAAGCT  
JERF1Oriseq GATGATGTGAAGGCATTTGGCCCCAAATCCGTGAGATCTGGTGATTCAAACCTGCCGAAGCT

```

329                                     388
DB110 GACAGATCCTCCAAGAGAAAAGAGGAAGAATCAGTACCGGGGGATCAGACAGCGTCCTTGG
JERF1Oriseq GACAGATCCTCCAAGAGAAAAGAGGAAGAATCAGTACCGGGGGATCAGACAGCGTCCTTGG

389                                     448
DB110 GGTAAGTGGGCAGCTGAAATACGTGATCCAAGGAAAGGTATTTCGAGTCTGGCTTGGTACT
JERF1Oriseq GGTAAGTGGGCAGCTGAAATACGTGATCCAAGGAAAGGTATTTCGAGTCTGGCTTGGTACT

449                                     508
DB110 TTCAATTCAGCCGAAAGAGGCAGCCAGAGCTTATGATGCTGAGGCGGAAGGATCAGAGGC
JERF1Oriseq TTCAATTCAGCCGAAAGAGGCAGCCAGAGCTTATGATGCTGAGGCGGAAGGATCAGAGGC

509                                     568
DB110 AAGAAAAGCTAAGGTGAACTTTCCTGATGAAGCTCCAGTGTCTGTTTCAAGACGTGCTATT
JERF1Oriseq AAGAAAAGCTAAGGTGAACTTTCCTGATGAAGCTCCAGTGTCTGTTTCAAGACGTGCTATT

569                                     628
DB110 AAGCAAAATCCCCAAAAGGCACTTCGTGAGGAAACCCTGAACACAGTTCAGCCCAACATG
JERF1Oriseq AAGCAAAATCCCCAAAAGGCACTTCGTGAGGAAACCCTGAACACAGTTCAGCCCAACATG

629                                     688
DB110 ACTTATATTAGTAACTTGGATGGTGGATCTGATGATTCGTTTCAGTTTTTTTCGAAGAGAAA
JERF1Oriseq ACTTATATTAGTAACTTGGATGGTGGATCTGATGATTCGTTTCAGTTTTTTTCGAAGAGAAA

689                                     748
DB110 CCAGCAACCAAGCAGTACGGCTTCGAGAATGTGTCTTTTACTGCTGTAGATATGGGACTG
JERF1Oriseq CCAGCAACCAAGCAGTACGGCTTCGAGAATGTGTCTTTTACTGCTGTAGATATGGGACTG

749                                     808
DB110 GGCTCAGTTTCCCCTTCAGCCGGTACAAATGTTTACTTCAGCTCTGATGAAGCAAGTAAC
JERF1Oriseq GGCTCAGTTTCCCCTTCAGCTGGTACAAATGTTTACTTCAGCTCTGATGAAGCAAGTAAC

809                                     868
DB110 ACTTTTACTGCTCTGATTTTCGGTTGGGCTGAACCGTGTGCAAGGACTCCAGAGATCTCA
JERF1Oriseq ACTTTTACTGCTCTGATTTTCGGTTGGGCTGAACCGTGTGCAAGGACTCCAGAGATCTCA

869                                     928
DB110 TCTGTTCTGTCGGAAGTTCTGGAAACCAATGAGACTCATTTCGATGATGATTCCAGACCG
JERF1Oriseq TCTGTTCTGTCGGAAGTTCTGGAAACCAATGAGACTCATTTCGATGATGATTCCAGACCA

929                                     988
DB110 GAGAAAAAAGTGAAGTCCTGTTCCAGCACTTCATTGACAGTTGACGGT.ACACTGTG.AC
JERF1Oriseq GAGAAAAAAGTGAAGTCCTGTTCCAGCACTTCATTGACAGTTGACGGTAACTGTGAAC

989                                     1048
DB110 ACGCTATCT.AAGAAGC.ATCGGCTTTTGAATCCCAGA.GAAGTTCTTGCA.ATCCCATATA
JERF1Oriseq ACGCTATCTGAAG.AGCTATCGGCTTTTGAATCCCAGATGAAGTTCTTGCAATCCCATA

1049                                     1100
DB110 TCTCG.GGGAAA.TGGG.ATGCATCGGTTGAT.CCTTCCTCAATACAAGTGAATT
JERF1Oriseq TCTCGAGGGAAATGGG.ATGCATCGGTTGATGCCTTCCTCAATACAAGTGAATT
1133

```

#### C4) Sequence alignment of DB 111 with JERF1

```

26                                     85
DB111 .....GAGAAGAAATCAAAGCTATGTGTGGTGGTGAATTATCTCCGATTTGGTACC
JERF1Oriseq ACTTTTGTGAGAAGAAATCAAAGCTATGTGTGGTGGTGAATTATCTCCGATTTGGTACC
62

86                                     145
DB111 CCTCCTAGCCGATTTCTCGCCGGTTAACCCTGATTTTCTATGGGGTACATCCGATCTG
JERF1Oriseq CCTCCTAGCCGATTTCTCGCCGGTTAACCCTGATTTTCTATGGGGTACATCCGATCTG

146                                     205
DB111 AACAAAGAAGAAGAAGAACCCCTAGTAATTACCACTCAAAGCCCTTGAGGTCTAAGTTTATT
JERF1Oriseq AACAAAGAAGAAGAAGAACCCCTAGTAATTACCACTCAAAGCCCTTGAGGTCTAAGTTTATT

206                                     265
DB111 GACCTTGAAGATGAATTTGAAGCTGACTTTCAGCACTTCAAGGATAATTCTGATGATGAT
JERF1Oriseq GACCTTGAAGATGAATTTGAAGCTGACTTTCAGCACTTCAAGGATAATTCTGATGATGAT

```

266 325  
 DB111 GATGATGTGAAGGCATTTGGCCCCAAATCCGTGAGATCTGGTGATTCAAACCTGCGAAGCT  
 JERF1Oriseq GATGATGTGAAGGCATTTGGCCCCAAATCCGTGAGATCTGGTGATTCAAACCTGCGAAGCT

326 385  
 DB111 GACAGATCCTCCAAGAGAAAAGAGGAAGAATCAGTACCGGGGGATCAGACAGCGTCCTTGG  
 JERF1Oriseq GACAGATCCTCCAAGAGAAAAGAGGAAGAATCAGTACCGGGGGATCAGACAGCGTCCTTGG

386 445  
 DB111 GGTAAGTGGGCAGCTGAAATACGTGATCCAAGGAAAGGTATTTCGAGTCTGGCTTGGTACT  
 JERF1Oriseq GGTAAGTGGGCAGCTGAAATACGTGATCCAAGGAAAGGTATTTCGAGTCTGGCTTGGTACT

446 505  
 DB111 TTCAATTCAGCCGAAGAGGCAGCCAGAGCTTATGATGCTGAGGCGCGAAGGATCAGAGGC  
 JERF1Oriseq TTCAATTCAGCCGAAGAGGCAGCCAGAGCTTATGATGCTGAGGCGCGAAGGATCAGAGGC

506 565  
 DB111 AAGAAAAGCTAAGGTGAACCTTTCCTGATGAAGCTCCAGTGTCTGTTTCAAGACGTGCTATT  
 JERF1Oriseq AAGAAAAGCTAAGGTGAACCTTTCCTGATGAAGCTCCAGTGTCTGTTTCAAGACGTGCTATT

566 625  
 DB111 AAGCAAAAATCCCCAAAAGGCACTTCGTGAGGAAACCCTGAACACAGTTCAGCCCAACATG  
 JERF1Oriseq AAGCAAAAATCCCCAAAAGGCACTTCGTGAGGAAACCCTGAACACAGTTCAGCCCAACATG

626 685  
 DB111 ACTTATATTAGTAACTTGGATGGTGGATCTGATGATTCGTTTCAGTTTTTTTCGAAGAGAAA  
 JERF1Oriseq ACTTATATTAGTAACTTGGATGGTGGATCTGATGATTCGTTTCAGTTTTTTTCGAAGAGAAA

686 745  
 DB111 CCAGCAACCAAGCAGTACGGCTTCGAGAATGTGTCTTTTACTGCTGTAGATATGGGACTG  
 JERF1Oriseq CCAGCAACCAAGCAGTACGGCTTCGAGAATGTGTCTTTTACTGCTGTAGATATGGGACTG

746 805  
 DB111 GGCTCAGTTTCCCCTTCAGCCGGTACAAAATGTTTACTTCAGCTCTGATGAAGCAAGTAAC  
 JERF1Oriseq GGCTCAGTTTCCCCTTCAGCTGGTACAAAATGTTTACTTCAGCTCTGATGAAGCAAGTAAC

806 865  
 DB111 ACTTTTACTGCTCTGATTTTCGGTTGGGCTGAACCGTGTGCAAGGACTCCAGAGATCTCA  
 JERF1Oriseq ACTTTTACTGCTCTGATTTTCGGTTGGGCTGAACCGTGTGCAAGGACTCCAGAGATCTCA

866 925  
 DB111 TCTGTTCTGTCGGAAGTTCTGGAAACCAATGAGACTCATTGATGATGATTCCAGACCG  
 JERF1Oriseq TCTGTTCTGTCGGAAGTTCTGGAAACCAATGAGACTCATTGATGATGATTCCAGACCA

926 985  
 DB111 GAGAAAAAAGTGAAGTCTGTTCCAGCCCTTCATTGACAGTTTGACGGTAA.CCTGTGAA  
 JERF1Oriseq GAGAAAAAAGTGAAGTCTGTTCCAGCACTTCATTGACAG.TTGACGGTAACACTGTGAA

986 1045  
 DB111 CACGCTATCTGAAAGAGCTATCGGCTTTTTGAATCCCA.ATGAAAGTTCTTGACAGATCCC  
 JERF1Oriseq CACGCTATCTG.AAGAGCTATCGGC.TTTTGAATCCCAGATG.AAGTTCTTGACAGATCCC

1046 1105  
 DB111 ATCTCGAGGGGAAATTTGGGGATGGCATCGGTTGATGCCCTTCCTCAA.AC.AAGTGCCA  
 JERF1Oriseq ATCTCGA.GGGAAATT.GGGAT.GCATCGGTTGATG.CCTTCCTC.AATAC.AAGTGC..

1106 1151  
 DB111 ATTTCA..GGATGG.GGAAACCCCATGGGCCTTTGGTCCTTCGATG  
 JERF1Oriseq AATTCA..GGATGGTGGAAACGCCATGGACCTTTGGTCCTTCGATG

## APPENDIX D

### BUFFERS AND SOLUTIONS

#### **Tris Borate EDTA Buffer (TBE) (5X):**

Tris base: 54 g

Boric Acid: 27.5 g

EDTA (0.5M pH8): 20 ml

Completed to 1L

#### **PEG/LiAc Solution (Polyethylene Glycol / Lithium Acetate):**

PEG 4000: 8 ml of 50% PEG

TE Buffer: 1 ml of 10X TE

LiAc: 1ml of 10X LiAC

Completed to 10 ml

#### **10 X TE Buffer:**

0.1M Tris-Hcl

10mM EDTA

pH adjusted to 7.5

**10X LiAc:**

1M Lithium Acetate pH adjusted to 7.5 with dilute acetic acid and autoclaved

## APPENDIX E

### Equipments

Autoclave:	Hirayama, Hiclave HV-110, JAPAN
	Certoclav, Table Top Autoclave CV-EL-12L, AUSTRIA
Balance:	Sartorius, BP211D, GERMANY
	Sartorius, BP221S, GERMANY
	Sartorius, BP610, GERMANY
	Schimadzu, Libror EB-3200 HU, JAPAN
Centrifuge:	Eppendorf, 5415C, GERMANY
	Eppendorf, 5415D, GERMANY
	Eppendorf, 5415R, GERMANY
	Kendro Lab. Prod., Heraeus Multifuge 3L, GERMANY
	Hitachi, Sorvall RC5C Plus, USA
	Hitachi, Sorvall Discovery 100 SE, USA
Deepfreeze:	-70° C, Kendro Lab. Prod., Heraeus Hfu486 Basic, GERMANY
	-20° C, Bosch, TÜRKİYE
Distilled Water:	Millipore, Elix-S, FRANCE
	Millipore, MilliQ Academic, FRANCE
Electrophoresis:	Biogen Inc., USA
	Biorad Inc., USA



Gel Documentation: UVITEC, UVIdoc Gel Documentation System, UK  
 Biorad, UV-Transilluminator 2000, USA

Ice Machine: Scotsman Inc., AF20, USA

Incubator: Memmert, Modell 300, GERMANY  
 Memmert, Modell 600, GERMANY

Laminar Flow: Kendro Lab. Prod., Heraeus, HeraSafe HS12, GERMANY

Magnetic Stirrer: VELP Scientifica, ARE Heating Magnetic Stirrer, ITALY  
 VELP Scientifica, Microstirrer, ITALY

Microliter Pipette: Gilson, Pipetman, FRANCE  
 Mettler Toledo, Volumate, USA

Microwave Oven: Bosch, TÜRKİYE

pH meter: WTW, pH540 GLP MultiCal<sup>®</sup>, GERMANY

Power Supply: Biorad, PowerPac 300, USA  
 Wealtec, Elite 300, USA

Refrigerator: +4° C, Bosch, TÜRKİYE

Shaker: Forma Scientific, Orbital Shaker 4520, USA  
 GFL, Shaker 3011, USA  
 New Brunswick Sci., Innova<sup>™</sup> 4330, USA

Spectrophotometer: Shimadzu, UV-1208, JAPAN  
 Shimadzu, UV-3150, JAPAN  
 Secoman, Anthelie Advanced, ITALY

Speed Vacuum: Savant, Speed Vac<sup>®</sup> Plus Sc100A, USA  
 Savant, Refrigerated Vapor Trap RVT 400, USA

Thermocycler: Eppendorf, Mastercycler Gradient, GERMANY

Vacuum: Heto, MasterJet Sue 300Q, DENMARK

Water bath: Huber, Polystat cc1, GERMANY

## REFERENCES

1. Baker B, Zambryski P, Staskawicz B, Dinesh-Kumar SP, “Signalling in Plant-Microbe Interaction” *Science* 276 (1997) 726-733.
2. Bendahmane A, Köhm BA, Dedi C, Baulcombe DC, “The Coat Protein of Potato Virus X is a Strain-Specific Elicitor of *Rx1*-mediated Virus Resistance in Potato” *Plant J.* 8 (1995) 933-941.
3. Bilgin DD, Liu Y, Schiff M, Dinesh-Kumar SP, “P58<sup>IPK</sup>, a Plant Ortholog of Double-Stranded RNA-Dependent Protein Kinase PKR Inhibitor, Functions in Viral Pathogenesis” *Developmental Cell* 4 (2003) 651-661.
4. Birch PRJ, Avrova AO, Dellagi A, Lacomme C, Santa Cruz S, Lyon GD. “Programmed Cell Death in Plants in Response to Pathogen Attack” *Annual Plant Reviews.* 4 (2000) 175-197
5. Botella BA, Parker JE, Frost LN, Bittner-Eddy PD, Beynon JL, Daniels MJ, Holub EB, Jones JDG, “Three Genes of the *Arabidopsis* RPP1 Complex Resistance Locus Recognize distinct *Peronospora Parasitica* Avirulence Determinants” *Plant Cell* 10 (1998) 1847-1860.
6. Buchanan BB, Gruissem W, Jones RL, “Biochemistry & Molecular Biology of Plants” Second Impression, *American Society of Plant Physiologists* 2000.
7. Carrington JC, Kasschau KD, Mahajan SK, Schaad MC, “Cell-to-Cell and Long-Distance Transport of Viruses in Plants” *Plant Cell* 8 (1996) 1669–1681.
8. Chang C, Shockey JA, “The Ethylene-Response Pathway: Signal Perception to Gene Regulation” *Curr. Opin. Plant Biol.* 2 (1999) 352-358.
9. Cheng WH, Endo A, Zhou L, Penney J, Chen HC, Arroyo A, Leon P, Nambara E, Asami T, Seo M, Koshiba T, Sheen J. “A unique short-chain

- dehydrogenase/reductase in Arabidopsis glucose signaling and abscisic acid biosynthesis and functions” *Plant Cell*. 11 (2002)2645-26499.
10. Chini A, Grant JJ, Seki M, Shinozaki K, Loake GJ, “Drought Tolerance Established by Enhanced Expression of the CC-NBS-LRR Gene, ADR1, Requires Salicylic Acid, EDS1 and ABI1” *Plant J*. 38 (2004) 810-822.
  11. Dangl JL, Jones JDG, “Plant Pathogens and Integrated Defence Responses to Infection” *Nature* 411 (2001) 826-833.
  12. Delaney TP, Uknes S, Vernooij B, Friedrich L, Weymann K, Negrotto D, Gaffney T, Gut-Rella M, Kessmann H, Ward E, Ryals J, “A Central Role of Salicylic Acid in Plant Disease Resistance” *Science* 266 (1994) 1247-1250.
  13. Dion M, Chamberland H, St-Michel C, Plante M, Darveau A, Lafontaine JG, Brisson LF, “Detection of a Homologue of bcl-2 in Plant Cells” *Biochem. Cell Biol.* 75 (1997) 457-461.
  14. Doke N, Ohashi Y, “Involvement of an O<sub>2</sub> Generating System in the Induction of Necrotic Lesions on Tobacco Leaves Infected with Tobacco Mosaic Virus” *Physiol. Mol. Plant Pathol.* 32 (1988) 163-175.
  15. Ellis J, Jones D, “Structure and Function of Proteins Controlling Strain-Specific Pathogen Resistance in Plants” *Curr. Opin. Plant Biol.* 1 (1998) 288-293.
  16. Ellis JG, Lawrence GJ, Luck JE, Dodds PN, “Identification of Regions in Alleles of the Flax Rust Resistance Gene *L* That Determine Differences in Gene-for-Gene Specificity” *Plant Cell* 11 (1999) 495-506.
  17. Flor HH, “Current Status of the Gene-for-Gene Concept” *Annu. Rev. Phytopathol.* 9 (1971) 275-296.
  18. Fujimoto SY, Ohta M, Usui A, Shinshi H, Ohme-Takagi M “Arabidopsis ethylene-responsive element binding factors act as transcriptional activators or repressors of GCC box-mediated gene expression” *Plant Cell*. 3 (2000):393-404
  19. Gaffney T, Friedrich L, Vernooij B, Negrotto D, Nye G, Uknes S, Ward E, Kessmann H, Ryals J, “Requirement of Salicylic Acid for the Induction of Systemic Acquired Resistance” *Science* 261 (1993) 754-756.

20. Gale Jr. M, Katze MG, “Molecular Mechanisms of Interferon Resistance Mediated by Viral-Directed Inhibition of PKR, the Interferon-Induced Protein Kinase” *Pharmacol. Ther.* 78 (1998) 29-46.
21. Gassmann W, Hinsch ME, Staskawicz BJ, “The Arabidopsis RPS4 bacterial-resistance gene is a member of the TIR-NBS-LRR family of disease-resistance genes” *Plant J.* 3 (1999) 265-77
22. Gil J, Esteban M, Roth D, “In Vivo Regulation of Protein Synthesis by Phosphorylation of the  $\alpha$  Subunit of Wheat Eukaryotic Initiation Factor 2” *Biochemistry* 39 (2000) 7521-7530.
23. Gong W, Shen Y-P, Ma L-T, Pan Y, Du Y-L, Wang D-H, Yang J-Y, Hu L-D, Liu X-F, Dong C-X, Ma L, Chen Y-H, Yang X-Y, Gao Y, Zhu D, Tan X, Mu J-Y, Zhang D-B, Liu Y-L, Dinesh-Kumar SP, Li Y, Wang X-P, Gu H-Y, Qu L-J, Bai S-N, Lu Y-T, Li J-Y, Zhao J-D, Zuo J, Huang H, Deng XW, Zhu Y-X, “Genome-Wide ORFeome Cloning and Analysis of Arabidopsis Transcription Factor Genes” *Plant Physiology* 135 (2004) 773-782.
24. Gu Y-Q, Wildermuth MC, Chakravarthy S, Loh Y-T, Yang C, He X, Han Y, Martin GB, “Tomato Transcription Factors Pti4, Pti5 and Pti6 Activate Defense Responses when Expressed in Arabidopsis” *Plant Cell* 14 (2002) 817-831.
25. Gu Y-Q, Yang C, Thara VK, Zhou J, Martin GB, “Pti4 is Induced by Ethylene and Salicylic Acid and its Product is Phosphorylated by the Pto Kinase” *Plant Cell* 12 (2000) 771-786.
26. Gutterson N, Reuber TL, “Regulation of disease resistance pathways by AP2/ERF transcription factors” *Curr. Opin. Plant Biol.* 7 (2004) 465–471
27. Hammond-Kosack KE, Jones DJG, “Resistance Gene-Dependent Plant Defense Responses” *Plant Cell* 8 (1996) 1773-1791.
28. Jarpe MB, Widmann C, Knall C, Schlesinger TK, Gibson S, Yujiri T, Fanger GR, Gelfand EW, Johnson GL, “Anti-Apoptotic versus Pro-Apoptotic Signal Transduction: Check-Points and Stop Signs along the Road to Death” *Oncogene* 17 (1998) 1475-1482.

29. Jofuku KD, den Boer BGW, Montagu MV, Okamoto JK, "Control of Arabidopsis Flower and Seed Development by the Homeotic Gene *APETHALA2*" *Plant Cell* 6 (1994) 1211-1225.
30. Jones CG, Tucker GA, Lycett GW, "Pattern of Expression and Characteristics of a Cysteine Proteinase cDNA from Germinating Seeds of Pea (*Pisum sativum* L.)" *Biochim. Biophys. Acta.* 129 (1996) 613-615.
31. Kiziz D, Lumbreras V, Pagès M, "Role of AP2/EREBP Transcription Factors in Gene Regulation During Abiotic Stress" *FEBS Letters* 498 (2001) 187-189.
32. Kobe B, Deisenhofer J, "The Leucine-Rich Repeat: A Versatile Binding Motif" *Trans Biochem. Sci.* 19 (1994) 415-421.
33. Krebs J, "The Role of Calcium in Apoptosis" *Biometals* 11 (1998) 375-382.
34. Langland JO, Langland LA, Browning KS, Roth DA, "Phosphorylation of Plant Eukaryotic Initiation Factor-2 by the Plant-encoded Double-stranded RNA-dependent Protein Kinase, pPKR, and Inhibition of Protein Synthesis *in Vitro*" *Journal of Biol. Chem.* 271 (1996) 4539-4544.
35. Lawrence GJ, Finnegan EJ, Ayliffe MA, Ellis JG, "The *L6* Gene for Flax Rust Resistance is Related to the Arabidopsis Bacterial Resistance Gene *RPS2* and the Tobacco Viral Resistance Gene *N*" *Plant Cell* 7 (1995) 1195-1206.
36. Lawton KA, Potter SL, Uknes S, Ryals J, "Acquired Resistance Signal Transduction in Arabidopsis is Ethylene Independent" *Plant Cell* 6 (1994) 581-588.
37. Lemaitre B, Nicolas E, Michaut L, Reichhart J-M, Hoffmann JA, "The Dorsoventral Regulatory Gene Cassette *spätzle/Toll/cactus* Controls the Potent Antifungal Response in Drosophila Adults" *Cell* 86 (1996) 973-983.
38. Levine A, Pennell RI, Alvarez ME, Palmer R, Lamb C, "Calcium-Mediated Apoptosis in Plant Hypersensitive Disease Resistance Response" *Curr. Biol.* 6 (1996) 427-437.
39. Liu Y, Schiff M, Dinesh-Kumar SP, "Virus-induced gene silencing in tomato" *Plant J.* 6 (2002) 777-786.

40. Lorenzo O, Piqueras R, Sanchez-Serrano JJ, Solano R, "ETHYLENE RESPONSE FACTOR1 integrates signals from ethylene and jasmonate pathways in plant defense" *Plant Cell* 1(2003) 165-178.
41. Luck JE, Lawrence GJ, Dodds PN, Shepherd KW, Ellis JG, "Regions outside of the Leucine-Rich Repeats of Flax Rust Resistance Proteins Play a Role in Specificity Determination" *Plant Cell* 12 (2000) 1367-1377.
42. Martin GB, Bogdanove AJ, Sessa G, "Understanding the Functions of Plant Disease Resistance Proteins" *Annu. Rev. Plant Biol.* 54 (2003) 23-61.
43. Medzhitov R, Preston-Hurlburt P, Janeway CA, "A Human Homologue of the Drosophila Toll Protein Signals Activation of Adaptive Immunity" *Nature* 338 (1997) 394-397.
44. Mittler R, Del Pozo O, Meisel L, Lam E, "Pathogen-Induced Programmed Cell Death in Plants, a Possible Defense Mechanism" *Developmental Genetics* 21 (1997) 279-289.
45. Moffett P, Farnham G, Peart J, Baulcombe DC, "Interaction between Domains of a Plant NBS-LRR Protein in Disease Resistance-Related Cell Death" *EMBO J.* 21 (2002) 4511- 4519.
46. Ohme-Takagi M, Shinshi H, "Ethylene-inducible DNA binding proteins that interact with an ethylene-responsive element" *Plant Cell.* 2 (1995) 173-82
47. Okamoto JK, Caster B, Villarreal R, Montagu MV, Jofuku KD, "The AP2 Domain of *APETALA2* Defines a Large New Family of DNA Binding Proteins in Arabidopsis" *Proc. Natl. Acad. Sci. USA* 94 (1997) 7076-7081.
48. Parker JE, Coleman MJ, Szabo V, Frost LN, Schmidt R, van der Biezen EA, Moores T, Dean C, Daniels MJ, Jones JD, "The Arabidopsis downy mildew resistance gene *RPP5* shares similarity to the toll and interleukin-1 receptors with N and L6" *Plant Cell.* 6 (1997) 879-894
49. Pedley KF, Martin GB, "Molecular Basis of Pto-mediated Resistance to Bacterial Speck Disease in Tomato" *Annu. Rev. Phytopathol.* 41 (2003) 215-243.

50. Prescott LM, Harley JP, Klein DA, "Microbiology" Fifth Edition, *McGraw Hill* 2002
51. Reymond P, Weber H, Dammond M, Farmer EE, "Differential Gene Expression in Response to Mechanical Wounding and Insect Feeding in *Arabidopsis*" *Plant Cell* 12 (2000) 707-719.
52. Riechmann JL, Heard J, Martin G, Reuber L, Jiang C-Z, Keddie J, Adam L, Pineda O, Ratcliffe OJ, Samaha RR, Creelman R, Pilgrim M, Broun P, Zhang JZ, Ghandehari D, Sherman BK, Yu G-L, "Arabidopsis Transcription Factors: Genome-Wide Comparative Analysis Among Eukaryotes" *Science* 290 ( 2000) 2105-2110.
53. Ruiz MT, Voinnet O, Baulcombe DC "Initiation and maintenance of virus-induced gene silencing" *Plant Cell*. 6 (1998) 937-946
54. Sakuma Y, Liu Q, Dubouzet JG, Abe H, Shinozaki K, Yamaguchi-Shinozaki K, "DNA-Binding Specificity of the ERF/AP2 Domain of Arabidopsis DREBs, Transcription Factors Involved in Dehydration- and Cold-Inducible Gene Expression" *Biochem. Biophys. Res. Commun* 290(2002) 998-1009.
55. Sessa G, D'Ascenzo M, Martin GB, "Thr38 Ser198 are Pto Autophosphorylation Sites Required for the AvrPto-Pto-mediated Hypersensitive Response" *EMBO J*. 19 (2000) 2257-2269.
56. Shinozaki K, Dennis ES, "Cell Signaling and Gene Regulation Global Analysis of Signal Transduction and Gene Expression Profiles" *Curr. Opin. Plant Biol*. 6 (2003) 405-409.
57. Song W-Y, Wang G-L, Chen L-L, Kim H-S, Pi L-Y, Holsten T, Gardner J, Wang B, Zhai W-X, Zhu L-H, Fauquet C, Ronald P, "A Receptor Kinase-like Protein Encoded by the Rice Disease Resistance Gene, *Xa21*" *Science* 270 (1995) 1804-1806.
58. Sticher L, Mauch-Mani B, Mettraux JP, "Systemic acquired resistance" *Annu. Rev. Phytopathol*. 35 (1997) 235-70



59. Suzuki K, Fukuda Y, Shinshi H, “Studies on Elicitor-Signal Transduction leading to Differential Expression of Defense Genes in Cultured Tobacco Cells” *Plant Cell Physiol.* 36 (1995) 281-289.
60. van der Biezen EA, Jones JDG, “The NB-ARC Domain: A Novel Signalling Motif shared by Plant Resistance Gene Products and Regulators of Cell Death in Animals” *Curr. Biol.* 8 (1998) R226-R227.
61. Volpe F, Clatworthy J, Kaptein A, Maschera B, Griffin A-M, Ray K, “The IL-1 Receptor Accessory Protein is Responsible for the Recruitment of the Interleukin-1 Receptor Associated Kinase to the IL-1/IL-1 Receptor I Complex” *FEBS Letters* 419 (1997) 41-44.
62. Vom Endt D, Kijne JW, Memelink J, “Transcription Factors Controlling Plant Secondary Metabolism: What Regulates the Regulators?” *Phytochemistry* 61 (2002) 107-114.
63. Waterhouse PM, Wang M-B, Lough T, “Gene Silencing as an Adaptive Defence Against Viruses” *Nature* 411 (2001) 834-841.
64. Whitham S, Dinesh-Kumar SP, Choi D, Hehl R, Corr C, Baker B, “The Product of the Tobacco Mosaic Virus Resistance Gene *N*: Similarity to Toll and the Interleukin-1 Receptor” *Cell* 78 (1994) 1101-1115.
65. Xie DX, Feys BF, James S, Nieto-Rostro M, Turner JG, “An Arabidopsis Gene Required for Jasmonate-Regulated Defense and Fertility” *Science* 280 (1998) 1091-1094.
66. Xu Y, Chang P F L, Liu D, Narasimhan M L, Raghothama K G, Hasegawa P M, Bressan R.A “Plant defense genes are synergistically induced by ethylene and methyl jasmonate” *Plant Cell.* 6 (1994) 1077–1085
67. Yang J, Steward R, “A Multimeric Complex and the Nuclear Targeting of the *Drosophila* reI Protein Dorsal” *Proc. Natl. Acad. Sci. USA* 94 (1997) 14524-14529.
68. Yang Y, Shah J, Klessig DF, “Signal Perception and Transduction in Plant Defense Responses” *Genes and Development* 11 (1997) 1621-1639.

69. Zhang JZ, “Overexpression Analysis of Plant Transcription Factors” *Curr. Opin. Plant Biol.* 6 (2003) 430-440.
70. Zhang S, Klessig DF, “Resistance Gene *N*-mediated *de novo* Synthesis and Activation of a Tobacco Mitogen-Activated Protein Kinase by Tobacco Mosaic Virus Infection” *Proc. Natl. Acad. Sci. USA* 95 (1998) 7433-7438.
71. Zhou J, Tang X, Martin GB, “The Pto kinase conferring resistance to tomato bacterial speck disease interacts with proteins that bind a *cis*-element of pathogenesis-related genes” *EMBO J.* 11 (1997) 3207-3218.
72. Zhu T, “Global Analysis of Gene Expression Using GeneChip Microarrays” *Curr. Opin. Plant Biol.* 6 (2003) 418-425.