

**THE SOFT-FOCUS LENS AND ANGLO-AMERICAN
PICTORIALISM**

William Russell Young, III

**A Thesis Submitted for the Degree of PhD
at the
University of St. Andrews**

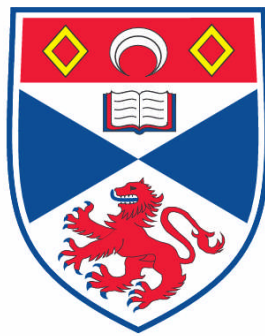

2008

**Full metadata for this item is available in the St Andrews
Digital Research Repository
at:**

<https://research-repository.st-andrews.ac.uk/>

Please use this identifier to cite or link to this item:

<http://hdl.handle.net/10023/505>

This item is protected by original copyright

**This item is licensed under a
[Creative Commons License](#)**

The Soft-Focus Lens
and Anglo-American Pictorialism

William Russell Young, III
B.S.B.A., M.B.A., M.A.

Submitted in fulfillment of the requirements for
Doctor of Philosophy

April 30, 2007

Declarations

(i) I, William Russell Young, III, hereby certify that this thesis, which is approximately 90,000 words in length, has been written by me, that it is the record of work carried out by me and that it has been written by me and that it has not been submitted in any previous application for a higher degree.

April 30, 2007

William Russell Young, III

(ii) I was admitted as a research student in January, 2001, and as a candidate for the degree of Doctor of Philosophy in Art History; the higher study for which this is a record was carried out in the University of St. Andrews between 2001 and 2007.

April 30, 2007

William Russell Young, III

(iii) I hereby certify that the candidate has fulfilled the conditions of the Resolution and Regulations appropriate for the degree of Doctor of Philosophy in the University of St. Andrews and that the candidate is qualified to submit this thesis I application for that degree.

April 30, 2007

Thomas Normand, Ph.D.

Acknowledgements

The author wishes to gratefully acknowledge various forms and degrees of contribution from the following individuals and institutions, without which this thesis would be diminished in quality. I sincerely apologize for any inadvertent omissions.

Scholars, M. Susan Barger, PhD, Robert Bretz, William Crawford, Roy Flukinger, Pamela Roberts, Richard Rudisill, PhD, Peter Stubbs, Paul Van Walree, Mike Ware, PhD.; Archivists and Librarians, *George Eastman House*, Becky Simmons, Mike Yates, Todd Gustavson, David Wooters, Janice Madhu; *Ohio University Archives* staff; *Harry Ransom Humanities Research Center, University of Texas*, Barbara Brown, Eric Beggs; *Perry-Castaneda Library, University of Texas*; *National Library of Scotland*; *Marion Center Newhall Library, College of Santa Fe*, Allison Colborne; *New Mexico State Library*, Susanne Caro; *Whistler Centre, Glasgow University*, Nigel Thorpe, PhD; *Photographic Archives, State of New Mexico*, Arthur Olivas (retired); Photographers, Patrick Alt, John Barnier, Ed Dams, Prof. Phil Davis, † Peter & Aase Goldsmith, Konrad Gotz, † Roy Hungerford, ARPS, Terry King, FRPS, Kerik Kouklis, Charles Lewis, David Lewis, Charlie Manion †, Sean McKenna, Robert Nugent, Mark Osterman, Charles Palmer, MD, James Pitts, Eric Renner, Ted Rice, III, Roy Robertson, FRPS, Robert Schlaer, PhD, Al Starkweather, Sr., Donald Stewart, PhD, ARPS; Photographic Equipment Dealers, Jim Andrachi (Midwest Photographic Exchange), Nick Argyros, Seth Broder (Cameraeccentric), Chris Davies, Charles Duckworth, Fred Newman & Dennis Kibbe, (The View Camera Store), Jay Tepper; Camera Designers, Kevin Finney, Jim Galvin †, Kurt Mottweiler; Book Dealers, Leo's Art Books, Fred & Elizabeth Pajerski Booksellers, Photo-Eye Books; Others, Barbara Robertson, Albert Starkweather, Jr., Dr. Dwight Thibodeaux, and my enduring gratitude to Tom Normand, Ph.D.

Abstract

The history, practice and aesthetic of the soft focus lens in photography is elucidated and developed from its earliest statements of need to the current time with a particular emphasis on its role in the development of the Pictorialist movement. Using William Crawford's concept of photographic 'syntax,' the use of the soft focus lens is explored as an example of how technology shapes style.

A detailed study of the soft focus lenses from the earliest forms to the present is presented, enumerating the core properties of pinhole, early experimental and commercial soft focus lenses. This was researched via published texts in period journals, advertising, private correspondence, interviews, and the lenses themselves. The author conducted a wide range of in-studio experiments with both period and contemporary soft focus lenses to evaluate their character and distinct features, as well as to validate source material.

Nodal points of this history and development are explored in the critical debate between the diffuse and sharp photographic image, beginning with the competition between the calotype and daguerreotype. The role of George Davison's *The Old Farmstead* is presented as well as the invention of the first modern soft focus lens, the *Dallmeyer-Bergheim*, and its function in the development of the popular Pictorialist lens, the Pinkham & Smith *Semi-Achromatic*. The trajectory of the soft focus lens is plotted against the Pictorialist movement, noting the correlation betwixt them, and the modern renaissance of soft focus lenses and the diffuse aesthetic.

This thesis presents and unique history of photography modeled around the determining character of technology and the interdependency of syntax, style and art.

Illustrations

- 1.1 D. W. Wynfield *Field Talfourd*
- 1.2 Cutaway diagram of the Petzval design
- 1.3 Cutaway diagram of the Dallmeyer Rapid Rectilinear design
- 1.4 Illustration of increased coverage by the cone of light...
- 1.5 Julia Margaret Cameron *Magdalene Brookfield*
- 1.6 Julia Margaret Cameron *The Twilight Hour*

- 2.1 Two staid American cabinet cards
- 2.2 Celine Laguarde *Profile Sanguine gum bichromate portrait*

- 3.1 Henry Herbert La Thangue *An Autumn Morning*
- 3.2 Sir George Clausen *Hoeing Turnips*
- 3.3 Frank Meadow Sutcliffe *Fetching in the Line*

- 4.1 Configuration of the Dallmeyer Rapid Landscape design
- 4.2 *Dallmeyer-Bergheim* lens, final type design
- 4.3 Cutaway diagram of the original *Dallmeyer-Bergheim* design
- 4.4 Direct scan of F. Holland Day's letter to Frederick Evans
- 4.5 Alvin Langdon Coburn *Henry Smith*
- 4.6 Grubb Aplanat design of 1857
- 4.7 Kodak Soft Focus Lens circa 1950
- 4.8 Circa 1900 Landscape Lens
- 4.9 Pinkham & Smith *Semi-Achromatic* Series I No. 3
- 4.10 The first Pinkham & Smith advertisement
- 5.1 Positive lenses
- 5.2 Spherical Aberration
- 5.3 Image of a point source when spherical aberration is present
- 5.4 Illustration of spherical aberration showing the band of focus
- 5.5 Chromatic aberration showing differing focus by color
- 5.6 Longitudinal chromatic aberration
- 5.7 Two reflections of the same light source...
- 5.8 An elaborate and undoubtedly highly efficient rectangular...
- 5.9 Gundlach *Achromatic Meniscus 6 inch f/6*
- 5.10 Fujinon *SF 250 mm. f/5.6*
- 5.11 Graphic demonstration of the distinction between the circle...
- 5.12 A set of Waterhouse stops
- 5.13 pinpoint light sources photographed slightly out of focus
- 5.14 Alvin Langdon Coburn *Notre Dame*
- 5.15 Gertrude Kasebier *The Lesson or The Picture Book*
- 5.16 Alfred Stieglitz *Hedwig Stieglitz*
- 5.17 Edouard Boubat *no title*
- 5.18 Heinrich Kühn *untitled* autochrome

- 6.1 Spectral sensitivity comparisons of films
- 6.2 Kodak *Portrait Lens* cemented achromat
- 6.3 *Veritar* (and *Verito*) diagram
- 6.4 Tina Modotti *Edward Weston*
- 6.5 Diagram of the earliest version of the Dallmeyer-Bergheim lens
- 6.6 Cutaway diagram of the Adjustable Landscape lens of Pulligny & Puyo
- 6.7 Engraved scale of focus correction on an *Objectif Anachromatique*
- 6.8 Busch *Perscheid* symmetric soft focus lens
- 6.9 Perforated diaphragm from an *Imagon* lens
- 6.10 Illustration of function of the *Imagon* perforated diaphragm
- 6.11 Cutaway diagram of the *Imagon* lens
- 6.12 An early advertisement for the monorail camera devised by Kühn
- 6.13 Dr. Adalbert Defner *Portrait of Heinrich Kühn*
- 6.14 An 8x10 Burke & James *Rembrandt Master Pictorialist* portrait camera
- 6.15 Russ Young *Glen Aultman*
- 6.16 Two large format cameras showing the rapid evolution
- 6.17 Heinrich Kühn *untitled portrait of Alfred Stieglitz*
- 6.18 Silhouette of Alfred Stieglitz holding a *Graflex* camera
- 6.19 Folmer & Schwing focal plane shutter
- 6.20 Agfa-Ansco 5x7 view camera
- 6.21 John Paul Edwards *untitled*
- 6.22 John Paul Edwards *untitled* detail
- 6.23 Ernest Knee *untitled portrait of Edward Weston*
- 6.24 Ansel Adams portraits with wide and normal lenses
- 6.25 4x5 ground glass image
- 6.26 Diagrammatic explanation of focusing the *Imagon*
- 6.27 Diagrammatic explanation of the soft focus lens and focus
- 6.28 The spectral sensitivity of ordinary film (“P”) and the human eye
- 6.29 Dallmeyer *Soft Focus* Six Inch lens
- 6.30 George H. Seeley *The Burning of Rome*
- 6.31 Ansel Adams *Lodgepole Pines*
- 6.32 Margrethe Mather (?) *untitled* Edward Weston with Graf *Variable*
- 6.33 E. H. Weston *untitled* portrait
- 6.34 Edward Henry Weston *Toxophilus*
- 6.35 F. Holland Day *The Storm God*
- 6.36 A 1902 risqué worded advertisement for printing paper

- 7.1 Alvin Langdon Coburn *Weir’s Close*
- 7.2 Alvin Langdon Coburn *Clouds in the Grand Canyon*
- 7.3 E. H. Weston *View from Mt. Wilson*
- 7.4 J. P. Edwards *Portrait of an Artist*
- 7.5 Illustration from *California the Beautiful*
- 7.6 A page from *The Old Spanish Missions of California*
- 7.7 Imogen Cunningham *Margrethe Mather and Edward Weston*
- 7.8 William E. Dassonville *Boat Rail and Reflections*

- 7.9 Ansel Adams *Eagle Dance, San Ildefonso Pueblo New Mexico*
- 7.10 William Mortensen *Johan the Mad*
- 7.11 Four representatives of the numerous photographic magazines
- 7.12 Hugo Henneberg *Pommeranian Motif*
- 7.13 Hugo Henneberg *Row of Poplars*
- 7.14 Modern 'flou-net' manufactured by Bronica
- 7.15 Shadows produced by the pattern of an Eastman *Diffusion Disk*
- 7.16 1928 Leica advertisement for the 'camera of the future'
- 7.17 Frank R. Nivison, *A Concert in the Nursery*
- 7.18 L. H. Longwell *The Cigarette*

Table of Contents

Declarations	i
Acknowledgements	ii
Abstract	iii
List of Illustrations	iv
Chapter 1: Syntax and Solutions	1
Chapter 2: New Syntaxes, New Horizons	42
Chapter 3: Naturalistic Photography	69
Chapter 4: Development of the Soft Focus Lens	96
Chapter 5: Principles of the Soft Focus Lens	133
Chapter 6: Soft Focus Lens Practice	174
Chapter 7: The Demise of the Soft Focus Lens in Particular and Pictorialism more Generally	251
Conclusions	321
Appendix A: Soft Focus Innovation Time Line	337
Appendix B: Photographers by Year of Birth	342
Appendix C: Photographers and their Lenses	345
Bibliography	347

Chapter 1: Syntax & Solutions

I was not looking at it [photography] solely from the usual vantage point of the art historian- from above, as it were, predominantly in visual or formalistic terms- but equally from below, from the point of view of the evolving technology that had made photography possible.¹
William Crawford (1978)

The Syntax of Photography

William M. Ivins (1881-1961) first elucidated the concept of syntax in 1953,² noting the importance of how the image of a print was constructed by various systems of lines.

Moreover, Ivins stated that for a given process of printmaking, the method only allowed specific families of tones to be created from those lines. Although his main interest was in printmaking and communications, he does also touch on photography.

He was not as well versed in the issues of photography as he was in printmaking (thirty years as curator of prints at the Metropolitan Museum certainly qualified him to make studied statements on printmaking) and made both errors of omission and fact. As far as Ivins was concerned, photography had no syntax. Photohistorian William Crawford (1948-current) argued that if the appearance of a daguerreotype was so radically different from a platinum print, then photography must have syntax. He convincingly sets forth the statement that “the photographer can only do what the technology available at the time permits him to do.”³

Specifically, Crawford defines photographic syntax as technology. “It is whatever combination is in use. The combination determines how well the technology can see and thus

¹ William Crawford *Keepers of Light* (Dobbs Ferry, NY: Morgan & Morgan, 1979) unpaginated “Introduction.”

² William M. Ivins *Prints and Visual Communications* (London: Routledge and Kegan, Paul, Ltd., 1953).

³ Crawford 1979, p. 6.

sets the limits on what photographers can communicate in their work.”⁴ For example, a photographer using a daguerreotype (which has an ISO of <0.5) would find it was impossible to record on the plate an image of a horse in motion, even at a very slow walk. This absurdly basic concept had eluded art historians until 1979, and still is not a part of the consciousness of many today.

The photographic syntax is composed of several elements, just like that of printmaking. It begins with the elements capturing the image: film, camera, lens, etc., and ends with the printing⁵ of the final image; it is a system of many parts, with nearly infinite combinations and permutations, all of which create a syntax of photography.

When the photographer attempts to record an image, the choices of lens, camera and film all influence syntax. It begins as soon as the photographer reaches for the camera; a hand held 35 mm camera produces a far different syntax than a 12 x 20 view camera. The former is the standard work-horse of photojournalism whereas the 12 x 20 would be virtually hopeless in the same situation. The lens not only alters perspective but its aperture may eliminate the possibility of working in anything but bright light. Kodak’s color transparency film from the 1940s until the 1980s, *Kodachrome*, was too insensitive for indoor photographs without supplemental light sources (such as a flash bulb).

After the image has been recorded on a negative, it has to be converted into a positive image for viewing. In the pre-digital era this involved making a wet processed print in the darkroom. The exact same negative could be printed in any one of many positive processes; a color gum-bichromate print, a platinotype and a gelatin silver print of the same negative

⁴ Crawford 1979, p. 6.

⁵ Direct positive processes such as daguerreotypes and Polaroids do not require a printing step, but they have been in the minority of photographic processes since the passing of the tintype.

produce strikingly different images with measurable differences. The color palette of the platinotype and silver gelatin prints are circumscribed within relatively narrow portions of the spectrum whereas the gum-bichromate print can be virtually any color or combination of colors. A silver-gelatin paper has always been a manufactured item of commerce and not possible for the photographer to make in the darkroom. Platinotype papers were once abundant on the camera store shelf with a number of manufacturers involved although a photographer could make them by hand. Only one company made any quantity of commercially prepared gum-bichromate papers; as a rule they were made by the photographer.

In the case of the three papers above, only the gum-bichromate paper was nearly always made by the final user; the platinotype might be and the silver gelatin papers never were darkroom fabricated but always were an article of commerce. It is obvious that the gum-bichromate paper, since it was created by the final users, could be precisely tailored to their aesthetic demands. Not only could virtually any color or colors be chosen, but the size was limited only by the availability of paper sheets, and the texture of the paper and its inherent color were all deliberate choices of the artist and not dictated by commercial interests such as profit.

Crawford put it succinctly and brilliantly when he noted that “at bottom, photography is a running battle between vision and technology. Genius is constantly frustrated — and tempered- by the machine.”⁶ The artist-photographers may have an idea well resolved in their minds but be unable to execute the physical manifestation because the current technology is inadequate to the challenge. A simple example is that before the perfection of the gum-

⁶ Crawford 1979, p. 6.

bichromate print (1892), the photographer could envision an image in color (monochrome) but could not possibly produce it physically. It is impossible to circumvent technological limitations.

The syntax of photography was clearly recognized by some of the early Pictorialists. Frederick H. Evans states it very directly in terms that Ivins would certainly understand: “Photography is essentially a means of the perfect rendering of half-tones, of detail, of gradation. It is not, as in etching, a means of saying things by line, or by suggesting things by spaces; it is not, as in engraving, a means of showing things by a multiplicity of lines, or of fine hatching, or dots, etc.; it is not, as in wash-drawing, a means of giving bold or tender masses, nor is it akin to pencil-drawing, or pen-and-ink work, or to lithography.”⁷

Perceptive critic and photographer Andrew Pringle, in 1893, gave an example of two forms of syntax, in the form of the camera and the reproduction: “The hand-camera has given birth to a school of workers in small sizes, some of the productions being gems in their own way... but on an account of the minuteness of the detail, it is almost impossible to obtain suitable reproductions of the originals by any mechanical process such as required for illustrating a book or journal.”⁸ Pringle was one of the first to recognize the limitations of photo-mechanical reproduction, an issue which plagues Pictorial prints up to the present day. Although the concept of “syntax” had no label at the time, most, if not all, Pictorialists were familiar with the concept; Stieglitz’ choice of photogravure to print the most crucial images in an issue of *Camera Work* was a choice dictated by syntax. Although it was unable to capture many of the nuances of the prints, it was, nonetheless, the finest method then known for

⁷ Frederick H. Evans, “Glass Versus Paper” *Camera Work*, No. 10, April, 1905, reprinted in Anne Hammond ed. *Frederick H. Evans: Selected Texts and Bibliography* (Oxford: Clio Press, 1992) p. 67.

⁸ Andrew Pringle, “The Naissance of Art in Photography” *The Studio* Vol. I, No. 3, June 1893, p. 95.

reproduction of a photographic image.

The first few years of photography were a period of constant experimentation and there was little standardization of any aspect, a necessary requirement for commercial production. A second criterion for commercial interests is a market large enough to support the manufacture of the object; this too prevented commercial scale manufacture in photography's early years. By the mid-daguerrian era, circa 1848, absolutely anything required for a photographic studio could be purchased from a supplier. Photographers had gone from being custom designers and builders to customers. Photographers no longer directed the technical and aesthetic developments of photography- manufacturers did instead. The bold experiments of Robert Adamson were supplanted by the photographer asking the photographic equipment supplier "what was everyone else doing now?"

It is a subtle but crucial concept, this difference in the inventive role of the photographer. Utilizing Crawford's construct, the machine was tailored by the artist in the early and dynamic years whereas only a few years later, the photographers used what was available at the photographic store. In one case, the artist's vision leads the manufacture; in the other, the manufacturer leads the photographer's vision. Although some photographers such as Southworth & Hawes of Boston had a refined aesthetic and were masters of the daguerrian craft, most of their equipment was bought from the store, and thus, their aesthetic possibilities were immediately circumscribed. Their fame rests more on performing the tasks of artist better than their competitors rather than leading in innovation.

To a great extent, the artist-photographer was lead by the photographic industry from circa 1848 until the 1890s. Technological advances, nearly all achieved by industrial researchers, were in the direction of perfecting the existing methods rather than looking for

radical solutions and innovations. After the introduction of the wet-plate negative in 1851, recording media did not move forward until dry plates were perfected in the late 1880s. Wet plates were a very high resolution process, although their relative insensitivity to light (and exclusive sensitivity to blue and ultra-violet light) required a tripod for the camera even under brightly lit conditions. During the entirety of the wet plate era, albumen prints were nearly the exclusive method of printing the glass plate negatives. Albumen printing, introduced in 1850, held the entire market until P. H. Emerson succeeded in pointing out the virtues of platinotypes in the late 1880s, and remained the most popular printing material until circa 1895. The albumen print was characterized by a very glossy surface which preserved the fine details of the wet plate glass negatives. Thus, from the mid-1850s until the late 1880s or early 1890s, photography's syntax was dictated by the almost exclusive use of wet plate negatives and albumen prints.⁹

Lenses (or other image forming devices such as pinholes) are a major variable in the syntax of the image. The very earliest years of photography found lens designers seeking to make wider aperture ("faster") lenses which, because they admitted more light to the sensitive medium, shortened the exposure, thus making commercial portraiture feasible. Joseph Maria Petzval (Hungary, 1807-1891) elegantly solved the problem in 1840 with the introduction of an f/3.7 lens that would take decades to exceed. From c.1800 until 1886, only two glass types, crown and flint, were available for lens construction. Thus, with the speed issue essentially solved and the availability of glasses constraining design, most of the lens developments were largely directed toward higher resolution and higher contrast lenses (largely achieved by better correction of aberrations) with flatter fields. The increasing perfection of lenses and the

⁹ *The Albumen and Salted Paper Book* by James M. Reilly (Rochester, NY: Light Impressions, 1980) succinctly summarizes this pairing in Chapter 4, "Albumen Paper".

nearly glass-smooth shiny surface of the albumen print created more and more accurate replications of what the eye saw, i.e. a well defined and full tonal range.

By the late 1860s and early 1870s, this had become a distinct disadvantage in the major money producing realm of photography, portraiture. While the diminutive carte-de-visite (approximately 2.25 x 3.5 inches) had been the rage (c. 1856-1870s), their petite rendition of a portrait concealed many a flaw in the sitter's visage. Cabinet card sized portraits (4.0 x 5.5 inches, or nearly 300% greater surface area than the CDV) became the rage in the late 1860s and as time passed, even larger sizes such as "boudoir" and "imperial" became fashionable to those who could afford them.

These larger portraits were painfully realistic; every defect in the sitter was clearly visible in the print. Something had to be done to keep the customers happy (and the money flowing to photographers). The solution was the invention of retouching— representing a change in syntax.

From the beginning of calotype portraiture, artist-photographers had used hand work to add or delete from the truthful image emblazoned by the sun on the paper negative. Nowhere is this more apparent than on Hill & Adamson's calotypes with nearly all of their surviving calotypes showing some degree of hand work. Typically, however, this was to overcome the various shortcomings of the image induced by the current technologies. Hair lines were separated from the background; ill defined areas which were outside of the lens depth-of-field were sharpened; paper defects covered over. These necessary corrective actions form part of the syntax of calotypy, and the lack of ability to retouch a daguerreotype forms part of its syntax.

H. P. Robinson (England, 1830-1901) wrote “the idea of retouching on the negative very tardily dawned on the photographic community, and it came slowly into general practice, until about the year 1867, when its uses were generally recognized, and its abuses, of course, quickly followed.”¹⁰ The new hand work skill of retouching went into new realms of changing reality, not simply correcting the syntax of the process. As the carte-de-visite passed into oblivion and larger prints, made for display in public rooms of the home, rose to fashion, there was an obvious need to remove or reduce the various “defects” of the sitters, ranging from minor issues such as “bad hair”, to skin pores or large ears. The technology of photography had become too good and the syntax was displeasing to the paying customers. Retouching became *de riguer* in the portrait trade and the skill of the lens maker was deliberately negated by the skill of the retoucher, creating extremely discordant images wherein the eyes were usually tack sharp but virtually no skin texture was to be seen. It is difficult to understand why this extremely artificial construct was acceptable to the man in the street. Moreover, portraits became more expensive since a skilled retoucher could demand a good salary.

In summary, the syntax of photography is technology. Every decision made by the artist-photographer is limited by the available technology. “Each [photograph] is the culmination of a process in which the photographer makes his decisions and discoveries within a technological framework.”¹¹

There are two basic loci for photographic syntax: the recording of the image on the light sensitive medium and the translation of the negative image into a positive image for

¹⁰ H. P. Robinson, *The Studio and What to do in It*, London, 1891 (reprint Arno Press, New York, 1973), p. 117.

¹¹ Crawford 1979, p. 6.

viewing. The recording technology may be more complex than the translating technology but runs a large gamut from the hand held box camera at one extreme to the 12 x 20 inch view camera on a large tripod at the other end. In any case, though, there are four common elements in any method of image recording:

1. a device to organize the light rays into an optical image (usually a lens),
2. a timing method (usually a shutter),
3. a light proof container (the camera),
4. a light sensitive medium (film) to capture the formed image.

In the normal pictorial applications of photography, the largest single variable in determining the final appearance (syntax) of the photographic print would be the lens. The lens determines the perspective, angle of view, depth of field, resolution and numerous other variables which compose the image in the camera. Old uncoated lenses produce an image with a decidedly different visual appearance from a modern lens¹². The same scene viewed through an ultra-wide angle lens may hardly be recognizable as identical if viewed with a telephoto lens. Contemporary commercial photographers strive to build their lens bank with a single brand of lens such that the inter-lens variations are minimized.

The gross control of image appearance is the purview of the lens; it is the single most important variable in the syntax of the negative. In any time period, most photographers owned but a single camera body but perhaps an extensive selection of lenses. Too much importance cannot be placed on the role of the lens as a syntactical choice by the artist-photographer.

¹² This is chiefly because of flare due to uncoated elements as well as substantial differences in the type of glass used.

The Earliest Syntactical Arguments

Even at the dawn of photography, two camps were forming regarding the syntax of the medium. They were defined by their support of either the calotype or the daguerreotype as the path to be followed in the development of the field. The exponents of the daguerreotype praised its nearly infinite resolution; the exponents of the calotype believed its softness of definition was a great asset:

M. Daguerre answers by putting an eyeglass into our hand. Then we perceive the smallest folds of a piece of drapery; the lines of a landscape invisible to the naked eye. With the aid of a spying-glass we bring the distances near. In the mass of buildings, of accessories, or imperceptible traits which compose a view of Paris are taken from the *Pont des Arts*, we distinguish the smallest details; we count the paving-stones, we see the humidity caused by the rain; we read the inscription on a shop sign.¹³

A better summary of the virtues of the daguerrian image could not be written. Almost never in the early reviews of daguerrian virtues is the matter of ‘art’ mentioned, but veracity to nature, or perhaps hyper-veracity, since the unaided human eye is not capable of resolving the details in a well made daguerreotype “The astonishment was, however, greatly increased when, on applying the microscope, an immense quantity of details, of such extreme fineness that the best sight could not seize them with the naked eye, were discovered.”¹⁴ The technology of photography had gripped the popular mind with its amazing feats, not because of inherent artistic virtue.

The daguerreotype had major syntax shortcomings, however. First and foremost, it is properly a negative image on the silver plated copper sheet; only at a narrow angle of

¹³ Translated from *Le Commerce* by *The Literary Gazette*, Jan. 19, 1839, p. 43, quoted in Crawford, p. 34.

¹⁴ *The Literary Gazette (London)*, 13 July 1839, reprinted in Newhall *Photography: Essays and Images* (1980), p. 18.

geometry is there revealed a positive image, and then if and only if, it reflects a dark surface. The earliest portraits were an unappealing steel gray-blue, causing a pallor on even the healthiest sitter. An early syntax correction remedied this by using a gold toning bath which not only made the image more permanent but converted the cold tone to a warm tone, a major improvement for the process. Further syntactical corrections included dabbing a bit of rouge on the sitters' cheeks and picking out any gold jewelry with a touch of gold paint.

Other syntactical corrections would be few in number for the daguerrian process, primarily limited to hand coloring to bring the image more into a duplicate of reality. The delicate image composed of mercury on silver was not amenable to modification. And, of course, they were unique images, like a Polaroid, not available in multiples unless copied in the studio. The process was slow, expensive (due to the cost of materials), and the chemicals were extremely hazardous. Few improvements were possible and this lack of flexibility hastened the end of the daguerrian era when the collodion process was invented.

Adherents of the calotype appreciated the lack of resolution, the polar extreme from the daguerreotype. One of its greatest practitioners, David Octavius Hill (1802-1870), wrote:

The rough surface & unequal texture throughout of the paper is the main cause of the calotype failing in details before the process [or 'precision'] of Daguerreotypy- & this is the very life of it. They look like the imperfect work of a man- and not the much diminished perfect work of God.¹⁵

This is not a very definite description, more on philosophic terms than a statement about art or science per se. It reveals much about the mind of Hill and the approach he took to the then new medium.

¹⁵ David Octavius Hill in a letter to Henry Bicknell, 17 January 1849, George Eastman House, cited in Sara Stevenson *Facing the Light* (Edinburgh: National Museum of Scotland, 2002) p.53.

More might be divulged by an astute observer, not a photographer but someone well familiar with it and more accustomed to writing about art and science. Hugh Miller, scientist, essayist and subject of Hill & Adamson's camera was ideally suited for the task. He wrote in 1843, the year they made his portrait on Calton Hill:

Here, for instance, is a portrait exactly after the manner of Raeburn [Sir Henry Raeburn 1756-1823]. There is the same broad freedom of touch; no nice miniature stiplings, as if laid on by the point of a needle- no sharp-edged strokes; all is solid, massy, broad; more distinct at a distance than when viewed at hand. The arrangement of the lights and shadows seems rather the result of a happy haste, in which half the effect was produced by design, half by accident, than of great labour and care; and yet how exquisitely true the general aspect! Every stroke tells and serves, as in the portraits of Raeburn, to do more than relieve the features; it serves also to indicate the prevailing mood and predominant power to the mind.¹⁶

Miller's astute observations on the calotype not only beautifully summarized that process but perfectly described the avant-garde of the Pictorialist movement that would explode onto the art world fifty years later, moreover note that the emphasis is on aesthetics rather technical issues. As will be later evident, many pictorialists held Hill & Adamson's images as brilliant and classical exemplars for their emerging art movement of the 1890s.

All of these arguments over syntax essentially come to a halt in 1851, not because the debate was resolved but due to a revolutionary and unforeseen change in the syntax: the invention of the wet collodion process by Frederick Scott Archer [England 1813-1857]. It was more sensitive to light than either the daguerreotype or the calotype, produced a glass base negative without the texture of the calotype paper, printed far faster than a calotype negative, and perhaps most importantly, Archer gave it to the world with no patent restrictions. The daguerreotype died almost instantly- it possessed virtually no advantage over

¹⁶ Hugh Miller, *The Witness*, 12 July 1843, cited in Crawford, p. 35.

collodion. The calotype lingered for a decade or so as it still found some use for traveling photographers in hot climates (in the form of LeGray's waxed paper modification) but those were few and far in between. The collodion process would rule supreme, world over, until superseded by the dry plate more than thirty years later. Archer would have made a fortune had he patented it; instead he died an unappreciated pauper six years later.

First Calls for Diffusion

As early as the 1850s there were challenges to the already dominant paradigm of photography, that is, it should be high resolution. Importantly, these art critics were not photographers themselves but rather dwelt in the accepted art world of the time, which excluded photography from its ranks. Painter Sir William J. Newton (England 1785-1869), in a controversial address to the initial meeting of the Photographic Society of London, spoke in 1853:

At the same time I do not conceive it to be necessary or *desirable* for an *artist* to represent or aim at the attainment of every minute detail, but to endeavor at producing a broad and general effect, by which means the *suggestions* which nature offers, as represented by the Camera, will assist his studies materially: and indeed, for this purpose, I do not consider it necessary that the whole of the subject should be what is called *in focus*; on the contrary, I have found many instances that the object is better obtained by the whole subject being a little *out of focus*, thereby giving greater breadth of effect, and consequently, more *suggestive* of the true character of nature. I wish, however, to be understood as applying these observations to artists only, such productions being considered as private *studies* to assist him in his compositions¹⁷

Newton was a well respected painter and certainly cannot be faulted for partial knowledge of the field of art; he is speaking from a life time of observation and practice. At the time, he was also the Vice-President of The Photographic Society. His paper is often only partially

¹⁷ Sir William J. Newton, *Journal of the Photographic Society* 1, 1853, reprinted in *Essays and Images*, Beaumont Newhall, 1980, p. 79.

quoted and the caveat in the following issue that his suggestions were valid for “artists only, such productions being considered as private studies”¹⁸ is usually not included. In the same paper, he later comments specifically on calotypes and clearly is not enthusiastic about their softness; therefore his words should be carefully considered if applying them to photographs to be sold commercially either as art or in more mundane applications. Its citation in other histories of photography requires its inclusion here; whether it has any direct application to the practice of photography needs a great deal more scrutiny than has been applied heretofore.

At the following meeting, a letter dated 15 April 1853, was read from non-member E. W. Dallas. In it, Dallas responds to Newton’s ideas and proposes the world’s first photographic lens design to further the artist’s aims. He suggests that the glass of the lens be “partially streaked” rather than optically perfect, such that “some of the sharpness of the image is destroyed, and the more delicate details are lost...”¹⁹ Apparently this fell on deaf ears for there is no trace of the plan having been implemented. It is, however, far and away the earliest printed solution to the problem of too much sharpness reducing the artistic quality of photographic images by technological means. It is equally interesting that simpler solutions so common in the early 1900s such as placing a diffusing material in front of the lens or diffusing during printing do not seem to have been considered in the mid-1800s.

Lady Elizabeth Eastlake (English 1809-1903), another well qualified observer of the art world, wrote more directly about photography in her long essay of 1857. Her husband, Sir Charles Eastlake, was president of the Royal Academy and the Photographic Society (of London), and she was certainly included in many an artistic debate. Written by someone with a keen enthusiasm for the medium, she is directly discussing photography, its weaknesses and

¹⁸ Sir William J. Newton, untitled, *Journal of the Photographic Society* 2 (1 April 1853) p. 14.

¹⁹ E. W. Dallas, “Correspondence” *Journal of the Photographic Society* 3 (21 April 1853) p. 44

strengths, in the first twenty years of its existence:

Mere broad light and shade, with the correctness of general forms and absence of all convention, which are the beautiful conditions of photography, will, when nothing further is attempted, give artistic pleasure of a very high kind; it is only when greater precision and detailed are superadded that the eye misses the further truths which should accompany the further finish.²⁰

Lady Eastlake's essay addresses the issue of artistic 'truth' directly and unequivocally states that when too much detail (technical perfection) has been included in the photograph, the artistic goals (aesthetic perfection) suffer. The steady advance of photographic technology had progressed so far by 1857 that with the combination of the wet plate negative and the albumen print, a high level of detail was retained- too high, in fact, for artistic photography as viewed by some.

One of the major British photographers of the wet plate era was Francis Frith (England 1820-1899), a master of travel photography and perhaps the largest single publisher of British, Continental and Near Eastern images of the period. He believed that by 1859 "the construction and manufacture of these instruments [cameras and lenses] has approached very nearly to perfection, and leaves little or nothing to be desired."²¹ This speaks to the tremendous advances in the technology of photography in a scant two decades. Although he was aware that travel photographs had to be full of detail, he also had serious reservations about how much detail should be retained in an artistic photograph.

We now come to the disadvantages of this attribute: for it happens, by a singular fatality, that upon it hangs the chief reproach to photographic reproductions as works of Art. The fact is, that it is *too truthful*. It insists upon giving us 'the truth, the whole truth, and nothing but the truth.' Now, we want, in Art, the first and last of these conditions, but we can dispense very well with the middle term. Doubtless, it is truly

²⁰ Lady Elizabeth Eastlake, *Quarterly Review*, April, 1857, reprinted in Newhall 1980, p. 91.

²¹ Francis Frith, "The Art of Photography", *The Art Journal* 5 (1859), reprinted in Newhall 1980, p. 117.

the province of Art to improve upon nature, by control and arrangement, as it is to copy her closely in all that we *do* imitate; and, therefore, we say boldly, that by the non-possession of these privileges, photography pays a heavy compensation to Art, and must for ever remain under an immense disadvantage in this respect.²²

Frith equates “the whole truth” with the current level of resolution achieved by 1859, that is, the equipment and chemistry produced a system which was capable of capturing too sharp an image for the result to be considered art. How might the syntax of photography be altered so that it could enter the realms of the art world?

Robinson’s observation of the common application of retouching by 1867 shows one response to correcting the “too truthful” technology (cited earlier). Another response, which did not require hiring a skilled retoucher, and could be performed without calling on non-photographic skills, was to reduce the resolution of the lens, as E. W. Dallas had proposed (cited earlier).

Adjusting the Syntax- Claudet’s Claims

Pre-eminent lens designer John Dallmeyer (German 1830-1883), who would certainly have been acutely aware of lens related matters, considered a paper by George Wharton Simpson in 1864 to be the first call for a lens which would produce a softened image. It is interesting to speculate why Dallmeyer did not acknowledge Dallas’ idea. He emigrated to England in 1851; he was at least living in England at the time. It may be that Dallmeyer, as a designer, was not concerned with a solution regarding the glass quality but only dealing with the actual construction and design. Regardless, Simpson’s lens was viewed by the

²² Francis Frith, in Newhall 1980, p. 117

Photographic Society of Scotland on April 12, 1864.²³

Another lens designer, J. Traill Taylor (Scotland c.1827-1895),²⁴ may predate Simpson. He presented a two-part paper, both of which were read before the Photographic Society of Scotland; the first part on April 1, 1863, the second part on April 12, 1864. If the entire paper was written in 1863, then he has precedence. Alas, this is now impossible to determine. But there is no doubt about his precedence for designing the first soft focus *landscape* lens; the debate of 1866-67 centered entirely on *portrait* lenses. His landscape lens design “gives a picture *generally sharp* all over the plate, but particularly sharp nowhere. In short, it has no real focus at all.”²⁵ Interestingly, in the 1863 paper on *portrait* lenses, he recommends against a lens with the same characteristics.²⁶

Jean Francois Antoine Claudet (France 1797-1867), an experienced, high profile photographer began what became a series of submissions in the *BJP* regarding his claims to have invented and implemented the first methods of diffusion of focus. In the premier article printed on August 31st, 1866, Claudet had suggested “causing the lens to move in and out during the exposure so as to have the sharpest point of definition moving from the tip of the nose to the part of the sitter farthest away from the camera.”²⁷ This paper by Claudet was certainly well received by the audience; in fact, “The CHAIRMAN said that in describing the moving of the lens to obtain softness as the greatest improvement in photography since its

²³ Editor’s footnote to John Dallmeyer “On A New Portrait Lens,” *BJP*, 15 April 1864, p.606. Simpson’s lens was shown in Edinburgh on 12 April 1864.

²⁴ Taylor is one of those key persons who have largely slipped through the grasp of photohistorians. He founded the Edinburgh Photographic Society, was the editor of the *BJP* after Shadbolt resigned, was an associate of Talbot, Brewster and Ponton, invented magnesium flash powder, dying unexpectedly while on a trip to visit his property in Florida. I am indebted to Peter Stubbs for most of this information on this luminary.

²⁵ J. T. Taylor “Popular Notes on Photographic Lenses, Part II- Landscape Lenses” *BJP* April 15, 1864 p.135.

²⁶ J. T. Taylor “Popular Notes on Photographic Lenses, Part I- on Portrait Lenses” *BJP* April 1, 1863, p. 140.

²⁷ A. Claudet “On a New Process for Equalising the Definition of all Planes of a Solid Figure Represented in a Photographic Picture” *BJP* August 31, 1866, Vol. XII, No. 330, p. 415.

introduction, M. Claudet had been guilty of no exaggeration.”

Nonetheless, his claim as to priority was hotly disputed in the next *BJP* issue by a person who signed his letter to the editor with the pseudonym “An Old Photographer.” He related that the idea of moving the lens during exposure was an old one:

I modified it by having the camera quite rigid during the exposure, and causing the lens to travel in and out, so as to ensure that softness arising from all parts being alternately in and out of focus, and I found that by this means I obtained much artistic beauty by sacrificing undesirable details.²⁸

He further notes that this concept “was much talked about in private circles... [and] must date back at least a dozen of years”, implying that it was practiced circa 1854, coinciding with Dallas’ proposal. Thus this anonymous correspondent seems to point to at least some photographers having heeded the Newton paper’s suggestions; would that we knew who “An Old Photographer” really was.

Perhaps George Davison’s recollection in 1890 describes one of those photographers: “MR. JOHN LEIGHTON said he read a paper thirty-seven and a half years ago [1852-53] in that room upon photography ... it was the day of waxed paper and box cameras. He recollected a most laudable attempt of Mr. Smee, F.R.S., to produce, by binocular perspective on one plane, a picture by taking buildings by a moving camera, and he (Mr. Leighton) applied the same system to portraiture. During the taking of the picture the camera was shifted backward and forward, this produced more or less haze upon those parts in front and behind the plane of vision.”²⁹ This seems to be the direct antecedent of Claudet’s proposal and if correct, the entire question is resolved. Alas, as no one in the 1860s debate recalled Mr. Leighton’s practice, so the debate raged on.

²⁸ Letter to the Editors “Out of Focus” *BJP* September 7, 1866, Vol. XIII, No. 331, page 433.

²⁹ George Davison “Impressionism in Photography” *BJP* 26 Dec 1890 p. 826.

Was Claudet's idea original, as he claimed, or perhaps did "An Old Photographer" have a failing memory? In the next issue of *BJP*, Claudet musters several of the prominent names in photography; "not one of these gentlemen had ever heard that the same discovery had been made by any person prior to the meeting."³⁰ Claudet challenges him to sign his name and give evidence.

He may have been "An Old Photographer", but he was not slow to rise to Claudet's challenge (and implicit accusation of fabrication). He notes that he was present thirteen years before when Sir William Newton read his paper and moreover that following Newton, "the reading of a paper by Mr. Buss *On the Use of Photography to Artists*, the subject of moving the lens during exposure was discussed in consequence of some remarks by Sir William Newton and Mr. [George] Shadbolt."³¹ Further substantiation is given by "An Old Photographer", noting that:

Mr. [Oscar Gustave] Rejlander, the well-known artist-photographer, used, *many years ago*, to focus first on the tip of the nose, and make a scratch or ink mark on his lens, and then focus on the most distant parts of the face or figure, making a second mark on the lens mounting, and during the progress of the exposure moved the lens from the one mark to the other. Mr. Rejlander was so far from retaining this proceeding as a secret, that he spoke of it on many occasions and to several brother artists.³²

Was this true? A subsequent writer to the editors suggested going straight to the source³³ - Mr. Rejlander — to find out and the editors so acted and awaited his reply which was printed in the October 26th issue.

³⁰ Letter to the Editors entitled "M. Claudet on Priority of Discovery" *BJP* September 14, 1866, Vol. XIII, No. 332, page 445.

³¹ Letter to the Editors entitled "Priority of Discovery" *BJP* September 21, 1866, Vol. XIII, No. 333, p. 457.

³² "Priority of Discovery" *BJP* September 21, 1866, p. 457

³³ John Bayham Letter to the Editors "Altering the Focus of the Lens" *BJP*, October 12, 1866, Vol. XIII, No. 336, p. 493.

Until then, Claudet goes on the offensive again in the next *BJP* issue and has been assailed by at least two others besides “An Old Photographer.” He does not cite any new facts but continues to maintain the priority of his discovery. The editors place another letter directly after his, by another anonymous writer, “L. X.” who cites an earlier *BJP* reference to moving a lens during exposure. The editors include the original text and it seems quite certain that Claudet does not have priority of discovery, but instead Rev. J. B. Reade, who was written about in June, 1865:

The Rev. J. B. Reade once thought he had discovered a means by which soft pictures could be taken. He focussed the nearest part of the sitter, the tip of his nose for instance, and made a mark on the camera lens tube. He then focussed the part of the sitter farthest removed from the lens, such as his ears or the back of his head, if that were possible, making another mark on the lens. He then, during the exposure, and by means of the rack and pinion, caused the lens to move in and out from one mark to the other.³⁴

By now Claudet is no longer on firm ground, Reade³⁵ being established as having, in print, the idea before him. Further evidence, in a way more damning, comes when Rejlander responds to the editors’ query on October 26th. He recounts how he used the moving lens method very soon after Newton’s talk: “I think I was very much pleased with the result, for a I took some specimens to London to show to that knightly painter [Newton] as *a novelty*, because I had read his words on ‘out of focus’.”³⁶ This definitely establishes a very early date, just as “An Old Photographer” had asserted, but Rejlander condescends to call it ‘a novelty’. He enumerates the various problems with actually implementing the method and implies it was too cumbersome for portraits. Thus Claudet was not the inventor, and even if he was, it

³⁴ L. X. Letter to the Editors “M. Claudet’s Discovery” *BJP*, October 5, 1866, Vol. XIII, No. 335. The editor’s reprint is from *BJP* June 16, 1865, XII, p. 319.

³⁵ Rev. Reade also recognized there was a slight difference in that Claudet moved only the rear lens element and he, Reade, moved the entire lens. Reade believed “M. Claudet’s method not quite so good as his own” as regarded the final image. *BJP* Nov. 18, 1866, Vol. XIII, No 341, p. 549.

³⁶ O. J. Rejlander, “O. J. Rejlander on ‘Out of Focus’ *BJP* October 26, 1866, Vol. XIII, No. 338, pp. 508-509.

was not a worthwhile technique suitable for portraiture.

Rejlander mentions, almost as an aside, a more practical method of obtaining greater depth or diffusion:

I have now taken away the rack and pinion from my tube, and lined it with black velvet; and when I do sometimes wish to overtask my lens, I place a card close in front of it with a very small aperture, which I remove after a certain exposure, and then finish with half the full aperture. This, I think, is so well known that I would not say it has been exclusively practised by me.³⁷

This method requires only a bit of manual dexterity during exposure, not nearly so much as Claudet's method and the photographer can observe the sitter during the exposure rather than the marks on the lens tube. Claudet's technique would almost require an assistant so that the photographer can observe the subject's expression and motionlessness during the exposure. Rejlander's idea is an optically sound one; each aperture produces an image with slightly different circles of confusion and depth of field so that the final image is a composite of the two, with some areas in focus from each contributing exposure (but with differing circles of confusion) and some areas that exceed the depth-of-field of one aperture but not the other smaller aperture. The end result is visually very effective, softening the image in a gentle, unobtrusive manner.

Claudet always had to have the last word it seems, and had Rev. Reade read a long paper for him which was printed in the November 16th *BJP*. Defeated in originality of one idea, he posits yet another method:

³⁷ Rejlander, October 26, 1866, pp. 508-509. Karl Struss informed the author of a similar method that he used c.1910 by changing the aperture between multiple exposures. He used three consecutive apertures on each image. Struss, in his patent application, also listed lining the tube with black velvet as a way to reduce flare. It seems too great a coincidence that Struss used two of Rejlander's methods. There was also a mechanical method that operated on the same principle, Taylor's Patent attachment, which spun a disk with eight apertures of varying diameters in front of the lens during exposure.

I thought of making use of a contracting or moveable diaphragm I had invented, which during the sitting could gradually reduce the aperture of the lens until it was shut entirely. The effect of this diaphragm was to contract gradually the circle of confusion, and in doing so to impart to the picture a degree of definition which, being mixed with the soft effect produced by spherical aberration, communicated a more agreeable expression to the likeness, and concealed the defects of the physiognomy without losing the character of the features. I considered this a great improvement, and so it was in reality.³⁸

Only Claudet could have thought a method this cumbersome was an improvement. There is the additional question of how he computed the proper exposure time- with a constantly varying aperture this would be a mathematician's nightmare. The effect would depend on exactly how the aperture was changed; since more light comes through the larger aperture than the small aperture, if the speed of aperture change was constant, then the image formed by the larger aperture would have a disproportionate weighting. To make the effect equalized, the speed of change would have to be logarithmic, moving much more quickly at the larger apertures and very slowly at the smaller apertures. Since Claudet does not discuss this in such a lengthy manner, he probably created very few photographs in this way. He so much as admits that his various methods had problems in reality, noting that when he showed them to the audience, "These specimens are the first attempts, made without a long experience of the process at a bad season of the year [autumn], and with all the difficulties inseparable from the want of practice with proper instrumental means." In other words, he is making excuses for far from perfect photographs made by himself with his own methods.

In the round table discussion which followed his paper, [John Jabez Edwin] Mayall and [Cornelius Jabez] Hughes were particularly critical of his prints. Hughes noted that it "was no new process or discovery, but one which had been tried again and again, and to be

³⁸ A. Claudet, "On a Means of Introducing Harmony and Artistic Effect in Photographic Portraits by Equalising the Definition of the Various Planes of Focus" *BJP* November 16, 1866, Vol. XIII, No. 341, p. 547.

surmounted with trouble, causing more good pictures to be spoiled and bad ones to be produced than had been done by any other process.”³⁹ It is safe to conclude that Claudet’s ideas were neither new nor useful. Except to Claudet himself, it was now a resolved issue.

Nonetheless, he refused to drop the controversy and in May, 1867, submitted yet another paper⁴⁰; this contained a refinement in that a mechanical method of properly moving the rear element of the lens during the exposure. It was fraught with most of the same problems as the original, including too much complexity, and, as usual, does not seem to have been adopted by anyone else, or perhaps even himself. Whether he was a tireless egomaniac or simply could not accept defeat is difficult to discern.

Dallmeyer’s Solution

John Dallmeyer enters into the diffusion fray almost immediately after Claudet’s paper. Although printed by the *BJP* on December 21st, the paper itself was read by Dallmeyer in front of the Photographic Society of London on the 11th, only three weeks after Claudet’s harsh appraisals by Mayall, Hughes and others. Dallmeyer’s long article was prefaced by a two column long editorial which said that since Claudet’s revival of the issue, “diffusion of focus... has occupied the attentions of photographers more than any other topic.”⁴¹

Furthermore, they note that the following article by Dallemeyer, detailing his ‘new’ design, is not the first lens of such design, but rather that honor goes to J. Traill Taylor, who published his design in the *BJP* on April 15, 1864.

³⁹ Mr. Mayall quoted in “London Photographic Society” *BJP* November 16, 1866, Vol. XIII, No. 341, p. 550.

⁴⁰ A. Claudet, “On a Self-Acting Focus-Equaliser, or the Means of Producing the Differential Movements of the Two Lenses of a Photographic Optical Combination, Which is Capable, During the Exposure, of Bringing Consecutively all the Planes of a Solid Figure in Focus, Without Altering the Size of the Various Images Superimposed” *BJP* May 17, 1867, Vol. XIV, No. 367, pp. 232-233.

⁴¹ Editors, “A New Lens with Diffused Focus” *BJP* December 21, 1866, Vol. XIII, No. 346, p. 604.

First, however, Mr. Dallmeyer shall speak. In just the third paragraph, he gives Claudet a blast:

The method of obtaining the desired amount of diffusion of focus by a movement of the lens or camera during exposure, as brought before you at the last meeting of this Society [Claudet], was shown to be objectionable on many grounds. Moreover, the results so obtained and exhibited were generally pronounced inferior to those produced without the movement by Mr. [Henry Peach] Robinson, Mr. Hughes, and others, with a lens manufactured by me, viz., a modification of my triple achromatic lens, which was brought before you at the close of last year [1865].⁴²

George Davison, writing in 1889, may be describing that lens “Mr. Blanchard describes a special triplet with aperture of the central lens much enlarged, made for him by Mr.

Dallmeyer for the same purpose; a lens which was afterward displaced by the D series, with its dispersing arrangement for the back combination.”⁴³

Dallmeyer’s solution was as simple as Claudet’s was complex. The well corrected, normally sharp lens had a rear element which could be unscrewed in very small increments, inducing positive spherical aberration, to obtain any level of diffusion. This repositioning minimally disturbed other corrections of aberrations but mainly affected spherical aberration. It is the original lens manufactured for the purpose of a diffused image. The basic principle of a shifting lens element of an otherwise well corrected lens was still in use in the 1980s, and if newer soft focus lenses are ever put into production again, the principle remains at the foundation of soft focus design.

⁴² J. H. Dallmeyer, “On a New Portrait Lens” *BJP* December 21, 1866, Vol. XIII, No. 346, p. 604.

⁴³ George Davison, “Pinhole Pictures” *Photograph*, April 4, 1889, p. 241.

Julia Margaret Cameron's Methods & Influence

All the while this debate was raging in London, there was an active photographer trying to create an art career in photography whose 'large heads' were markedly unsharp (this is a generalization- some were reasonably sharp)⁴⁴. Julia Margaret Cameron (1815-1879) actively exhibited in the Photographic Society of London's annual salons of 1864-1868 (and elsewhere), precisely the period of the raging debates. Yet her name almost never appears in the photographic journals of those times. Although she received some positive critical reviews, those were rarely by photographers or in the photographic press. On the whole, her images were praised for various aspects resulting from the lack of sharpness but criticized for poor technique. This would seem to indicate that some aspects of the photographic world were prepared for the concept of a less than totally sharp image but no one else cared to take the concept to heart and develop it to a more refined solution.

There has been a great deal of thoroughly uninformed text written about her work, especially if her art could be appropriated for modern political motives. For example, feminist author Lindsay Smith's total lack of grasp of photographic technology: "Early lenses had a relatively narrow depth of field and lengthy exposures necessary for recording objects occupying different spatial planes tended to bleach out areas such as the surrounding sky for example."⁴⁵ She has no concept of the issue of blue sensitivity of wet collodion negatives or the basic principles of optics. Also, Smith argues as if all of Mrs. Cameron's images were unsharp, when many are actually fairly sharp.

Photohistorian Helmut Gernsheim (Germany 1913-1995), himself trained as a

⁴⁴ For instance, *G. F. Watts with hat*, 1864, shows the pores in his face and great detail in his beard.

⁴⁵ Lindsay Smith, *The Politics of Focus: Women, Children, and Nineteenth Century Photography* (Manchester: Manchester University Press, 1998), p. 18.

photographer, concluded “it was not without justification that her pictures were considered by most photographers ‘bungling pupil’s work.’ More serious was the fact that her poor technique prevented the photographic press, and especially the British photographic press, from recognizing their photographic merits.”⁴⁶ Furthermore, she never wrote to any of the photographic publications instead choosing to ignore them.⁴⁷

Even Emerson, prophet of diffusion, evaluated her harshly: “Neither was Mrs. Cameron’s positively chromatic focusing on the right track- it was not legitimately artistic; not naturalistic; because the out-of-focus planes were all treated alike and she aimed for the effect of the Italian Masters- instead of endeavoring to render the true visual impression.”⁴⁸ Nor perhaps was she original in her use of ‘artistic focus.’ The only instruction she ever received in photography was from David Wilkie Wynfield⁴⁹ (1837-1887) whose “method was to adjust the camera slightly out of focus, which softened and did away with the stereotyped hard look of the professional photographs of the day.”⁵⁰ Although his results were superficially similar to Cameron’s there were two major differences, firstly, his were only whole plate sized, 6½ x 8½ inches and, secondly, he was technically proficient. His work was generally better received than hers although he eschewed publicity, afraid it would reflect poorly on his career as a painter, whereas she sought it. She may have also consulted her brother in law, Lord Sommers, an officer of the Photographic Society of London.⁵¹

⁴⁶ Helmut Gernsheim, *Julia Margaret Cameron*, (Millerton, NY: Aperture, 1975) p. 62

⁴⁷ P. H. Emerson, *Sun Artists*, 5, Oct. 1890 (London: Kegan Paul, Trench, Trubner & Co.) p.38.

⁴⁸ Emerson, Oct. 1890, p. 39.

⁴⁹ Juliet Hacking, *Princes of Bohemia*, (London: National Portrait Gallery, 2000), p.9.

⁵⁰ M. H. Stephen Smith quoted by Colin Ford in *Julia Margaret Cameron, 19th Century Photographer of Genius* (London: National Portrait Gallery, 2003), p. 83.

⁵¹ Gernsheim 1975, p. 28.

Figure 1.1: D. W. Wynfield *Field Talfourd* undated whole plate albumen print. From the costuming to the lighting and pose, this image is nearly indistinguishable from Cameron's images (Juliet Hacking *Princes of Victorian Bohemia* plate 22).

Her method of obtaining the unsharp images has been a matter of debate since her own time and needs to be answered definitively herein. In the intervening 140+ years since her prints were first submitted to a salon, speculation about her methods of diffusion has misled several eminent photohistorians. Without any supporting documentation, Beaumont Newhall asserted that “she purposely used badly made lenses and was the first to have them specially built to give poor definition, When printing the negatives, she would sometimes put a piece of glass between the paper and the negative to decrease even more the precision of detail so inherent in the wet plate process.”⁵² If this was true then she invented soft focus lenses but, alas, it is without any documentation and in conflict with all known information. His wife, Nancy Newhall, took a different and equally erroneous track: Cameron’s “first apparatus was so ill-sorted that she could not have achieved sharp focus.”⁵³ German photohistorian Volker Kahmen also stated “Julia Margaret Cameron tried to achieve this same effect by using faulty lenses.”⁵⁴ This is widely repeated after 1900 in photography magazines, indicating that the direct analysis by Emerson (see below) had already been lost or at least, deliberately ignored.

As best can be discerned, she only used two lenses in her career. The first was a French lens, a twelve inch focal length *Petzval* design manufactured by *Jamin*⁵⁵; the second was an English Dallmeyer thirty inch focal length f/8 *Rapid Rectilinear* designed to cover an 18 x 22 inch plate. The former was used by Cameron on a 9 x 11 inch format camera and the latter on a 12 x 15 inch format camera. The Jamin was bought by Alvin Langdon Coburn

⁵² Beaumont Newhall, *Photography 1839-1937* (New York: Museum of Modern Art, 1937). He still repeats the erroneous information about the lens in *The History of Photography from 1839 to the Present Day* (New York: Museum of Modern Art, 1964) p.64.

⁵³ Nancy Newhall, *From Adams to Stieglitz* (New York: Aperture Foundation, Inc., 1999), p. 54. She seems to have ignored the variation in sharpness in Cameron’s prints.

⁵⁴ Volker Kahmen, *Photography as Art* Brian Tubb trans (London: Studio Vista, 1974) p.21.

⁵⁵ The Jamin lens is in the Royal Photographic Society Collection at the National Museum of Photography, Film & Television, Bradford. I was unable to examine it as it was in transit from the RPS in Bath to the museum.

from Cameron's daughter; he later gave it to the Royal Photographic Society.⁵⁶

The *Petzval* design was one of the earliest (1840) lenses designed explicitly for the purpose of photography. It has a flat field only 36 degrees or so⁵⁷; beyond that it has a pronounced curve and has pronounced astigmatism. Within that angle, the definition is excellent even if the aperture is wide open but deteriorates gradually toward the outer parts “as can be seen in many of the classical early portraits such as those by Julia Margaret Cameron. However, it can be argued that this was actually a good thing, as it tended to stress the portrait and suppress the unwanted background;”⁵⁸ see *Magdalene Brookfield* later in this chapter for an example of this appearance. Use of a *Petzval* would not have given Cameron's images a unique look as nearly every portrait photographer of the era used the *Petzval* design of lens.

Since Cameron acquired her first camera as a gift from son Charles in January, 1864⁵⁹, the *Jamin* was likely to be a previously-owned lens, however, since *Jamin*'s name was dropped from the lenses in 1860 after a merger with *Darlot*.⁶⁰ It is unusual that it had a “fixed stop” as this would seem to indicate a pre-Waterhouse stop model; after John Waterhouse's invention of 1858, lens makers rapidly moved to make their lenses compatible with it. As a second-hand lens, it could have been damaged or defective in some non-obvious manner although Thomas Dallmeyer would almost certainly have discovered any problems during his examination (see below). Thus this lens was almost certainly made before 1859.

⁵⁶ Alvin Langdon Coburn, letter to Helmut Gernsheim, September 27th 1957, one page, University of Texas Humanities Research Center.

⁵⁷ John Tennant *The Photo-Miniature* Vol. 1 No. 1 April 1899 p. 28.

⁵⁸ Rudolf Kingslake *A History of the Photographic Lens*, (Boston: Academic Press, Inc, 1989) p. 36.

⁵⁹ Ford 2003, p. 35

⁶⁰ Kingslake 1989, p. 247.

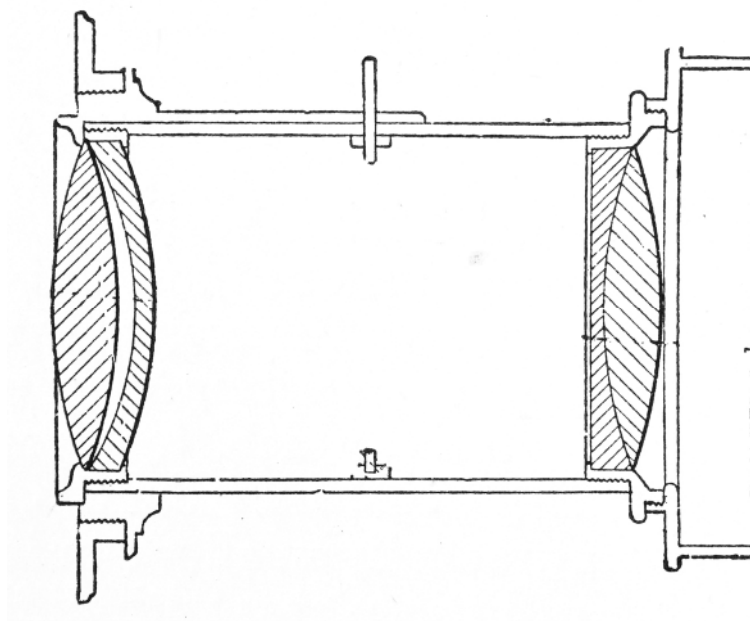

Figure 1.2: cutaway diagram of the Petzval design (Paul N. Hasluck *The Book of Photography* Fig. 43 page 32)

The *Rapid Rectilinear* design debuted in 1866, the year in which Mrs. Cameron purchased it, so hers was probably purchased as a new lens. One of its main attributes was correction for spherical aberration, thus it would not behave as a soft focus lens.⁶¹ It was a design of great virtue, “and lenses of this type were fitted to all the better cameras for nearly sixty years, a record scarcely surpassed by any other lens.”⁶² It is somewhat puzzling why Cameron used a thirty inch focal length model as a twenty four inch would have easily covered her plate size, been less expensive and required less bellows extension from the camera.

⁶¹ Rudolf Kingslake, *Lenses in Photography* (New York: A. S. Barnes and Company, Inc., 1963) p. 140.

⁶² Kingslake 1989, p. 59.

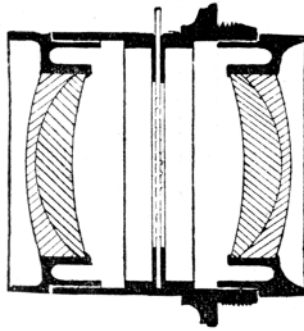

Figure 1.3: cutaway diagram of the Dallmeyer Rapid Rectilinear design (Paul N. Hasluck *The Book of Photography* Fig. 505 page 365)

Emerson had her *Jamin* examined by Thomas Dallmeyer, son of John Dallmeyer and a great lens designer himself. Dallmeyer's tests revealed that the *Petzval* had a fixed aperture of $f/6$ or $f/7$ and had no outstanding spherical aberration (the normal basis for a soft focus lens) but did have, as one would expect, positive chromatic aberration.⁶³ Colin Ford misinterprets this severely, concluding that "it would have been virtually impossible with such a lens to get a close-up portrait in focus on the 28 x 23 cm (11 x 9") plates used in Julia Margaret's camera."⁶⁴ That is simply not true; a 12 inch lens will produce a life-sized object when the bellows is extended to 24 inches. This is an optical law. Additionally none of Cameron's studies on this size of plate are life sized; therefore, she needed less than 24 inches of bellows, perhaps 20 inches or even less. The cone of coverage of a lens increases with decreasing distance, thus her lenses, as she utilized them, would cover a larger negative than the maker specified (specifications always made for infinity focus). What may be true is that the twelve inch *Petzval* would not produce a circle of acceptable definition at infinity for an 11 x 9" plate, but would, however, produce a cone of illumination adequate for Cameron's normal working distances.

⁶³ Emerson 1890, p. 36.

⁶⁴ Ford 2003, p. 42.

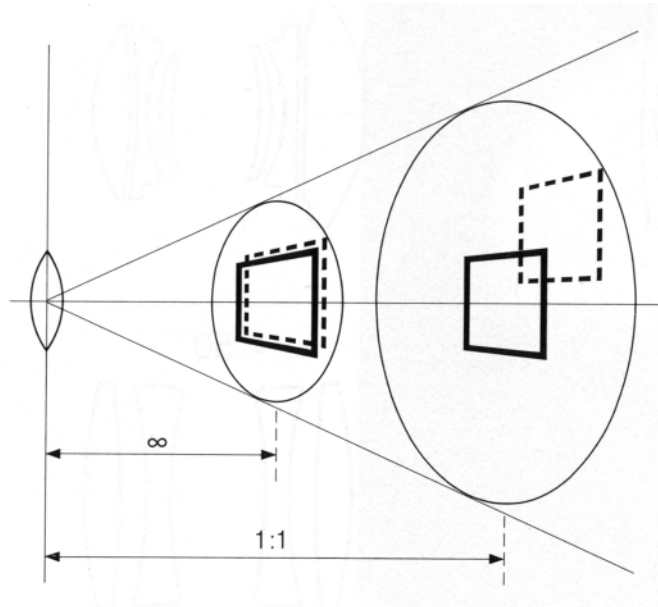

Figure 1.4: illustration of increased coverage by the cone of light from a lens at a working ratio of 1:1 as compared to infinity focus (*Kodak Large Format Photography* p. 37)

However, as Emerson notes and any professional photographer of the wet plate era would have also recognized, though the image appeared sharp on the screen, owing to the positive chromatic aberration, the picture would be out of focus on the plate when exposed.⁶⁵ The standard remedy of the era was to advance the focus $1/40^{\text{th}}$ of the focal length of the lens. At that position the chemical focus would be approximately correct although the visual image on the ground glass was now out of focus.

A *Petzval* was (and remains) an ideal lens for portraiture and one of the classic lenses of all times. It had a long period of use, longer than probably any other design. “So successful was this design that today nearly one hundred years later {1938}, the *Petzval* type of lens is

⁶⁵ Emerson 1890, p. 37.

still made and highly esteemed by portrait photographers.”⁶⁶ The design is also found in projection lenses to the present time.

Her *Jamin Petzval* lens had a fixed stop of about $f/6$ and she used the Dallmeyer at its maximum aperture of $f/8$. These relatively fast apertures (in an era of $f/12$ - $f/15$ lenses) gave a very shallow depth of field, one of the characteristics of all of her portraits. The *Jamin*'s “fixed stop” could be removed entirely to create a larger aperture of $f/3.7$ or another aperture could be substituted to obtain any smaller f /number. The Dallmeyer was fitted with Waterhouse stops⁶⁷ and thus she could have easily stopped the lens down for greater depth of field rather than using it wide open at $f/8$. Utilizing a program⁶⁸ to calculate depth of field, entering the data for her lenses and approximate studio conditions one finds that:

(A) For the *Jamin* 12 inch (305 mm) lens at $f/6.7$ focused at 5 feet, the depth of field is a paltry $2\frac{1}{4}$ inches.

(B) For the Dallmeyer 30 inch (720 mm) lens at $f/8$ focused at 10 feet, the depth of field is only $1\frac{3}{4}$ inches.

In an era that placed a high value on the sharpness of the subject, she stands almost entirely alone in using such a shallow depth of field, one that would be considered very minimal even by today's standards. Her various biographers (Gernsheim, Weaver, Ford) fail to ask a key question: did she deliberately shoot her lenses at or near their maximum aperture in order to maintain a very shallow depth of field? Not being particularly well informed technically, did she not realize there were alternatives? Or was she constrained by

⁶⁶ C. B. Neblette, *Photography, Its Principles and Practice*, 3rd ed. (New York: D. Van Nostrand Company, 1938) p.31.

⁶⁷ *A Lens Collector's Vade Mecum* 3rd p. 63 states that Dallmeyer used Waterhouse stops from the very beginning of his company.

⁶⁸ www.dofmaster.com/dofjs.html, May, 2006.

technology? In other words, was this an aesthetic decision or one dictated by photographic syntax?

The most obvious answer is that in order to keep her exposures as short as possible, the largest aperture was used. The wet plate process was extremely slow by modern standards. The exposure was further lengthened because of the bellows extension factor. Cameron's portraits are, on the whole, nearly life sized, especially the 12 x 15 prints. In order to produce a life sized image on the negative (denominated 1:1), the lens must be twice its focal length from the film.⁶⁹ Thus, her *Jamin* 12 inch lens must have been 24 inches from the film. In modern photographic parlance, this lens is operating as a "macro" or close-up lens. The focal length of a lens and the attendant apertures are determined at infinity; when focusing so closely, the *effective* aperture needs to be calculated. The formula is:

$$\text{Effective fN} = \text{fN} \times v/f \quad (70)$$

Where f is the marked focal length, v is the actual bellows extension and fN is the marked aperture. Using the formula for the 12 inch *Jamin* lens at 1:1 it becomes

$$f6 \times 24/12 = \text{effective } f/12$$

The difference between $f/6$ and $f/12$ is two stops, thus her exposure has increased by four times. For instance, if the base exposure was 10 seconds, with a 1:1 ratio the exposure becomes $10 \times 4 = 40$ seconds. Cameron's exposures were already far longer than the average professional photographer who used all the light possible with little attention to its direction (almost always overhead) or quality (very flat). Cameron by comparison sometimes used only a narrow slit of light to define her sitters, such as in *My Niece Julia Jackson now Mrs.*

⁶⁹ Leslie Stroebel, *View Camera Technique* 4th ed revised (Boston: Focal Press, 1980) p. 111.

⁷⁰ Stroebel 1980, p. 86.

Herbert Duckworth (April, 1867), *Clinton Parry* (1868) or *Sir Henry Taylor* (1865) and this requires roughly 400% more exposure than broad, direct daylight. She disdained the use of head-clamps and other supports commonly used in professional studios and as a result, there is unavoidable motion on the part of her sitters during these long exposures, especially by the elderly. Frederick Evans concluded her diffusion was “often as much induced by movement of the sitter as by unwise focussing, as witness the great head of Carlyle.”⁷¹

The rare out-of-doors, full length images such as *Magdalene Brookfield* (May, 1865) and *The Gardener’s Daughter*, 1867 would have required far less time because (1) they are in direct although slightly cloud-diffused sunlight and (2) at these greater distances, bellows factors would have been insignificant. The former, made with the *Jamin* lens, is quite sharp and shows what level of performance a Petzval design can provide under more typical usage and certainly disproves Colin Ford’s assumption as stated earlier, that this lens could not cover the format. An example of the performance of the *Rapid Rectilinear* can be seen in *The Twilight Hour* (unknown man and Kate Keown, 1874) where the oak leaves within the shallow depth of field are sharp and contrasty yet neither figure is sharp, although this may be because of subject movement. However, her boldly striped dress is not sharp, and it would not have moved.

⁷¹ Frederick Evans, “Exhibition of Photographs by Julia Margaret Cameron” *The Amateur Photographer* Vol. 40, No. 1033, 21 July 1904, p. 43

Figure 1.5: Julia Margaret Cameron *Magdalene Brookfield*, May, 1865, 10 ⁵/₈ x 8³/₄, made with the *Jamin Petzval* lens (Colin Ford *Julia Margaret Cameron* p. 126)

Figure 1.6: Julia Margaret Cameron *The Twilight Hour*, 1874, 13 $\frac{1}{8}$ x 11 inches, made with the *Rapid Rectilinear* lens (Colin Ford *Julia Margaret Cameron* p. 145)

The Dallmeyer f/8 at 1:1 effectively becomes an f/16 lens. Assuming that Gernsheim and Ford measured it correctly, it has a 30 inch focal length. In order to shoot a subject at 1:1, the bellows must be extended 60 inches or nearly five feet! It is difficult to imagine Cameron and her sitter in her small glass house with this monster camera. Furthermore, this magnitude of extension taxes the stability of any camera, especially a wooden one. It is safe to speculate that the large camera most likely had sagged and settled somewhat during the long exposures, further degrading the image sharpness.

Her son, H. H. H. Cameron, a photographer himself, recalled that “when focussing and she came to that which was beautiful to her, she stopped there, instead of screwing the lens to the more clearly defined focus which at that time all photographers aimed to secure.”⁷² Cameron herself, in a letter to Sir John Herschel [England 1782-1871], asked “What is focus- & who has a right to say what focus is the legitimate focus?”⁷³ It is, therefore, not surprising that her images were unsharp; what is more amazing is that some are sharp.

To summarize Mrs. Cameron’s two lenses, they were the state of the art for the time, widely used and well respected. There was absolutely nothing unusual about them, nor were they in any way designed as soft focus lenses. The lack of critical sharpness was almost certainly due to: (1) Mrs. Cameron was unaware of the issue of chromatic aberration and thus did not focus optimally, (2) the multi-minute exposures of unsupported (i.e., no head clamps) subjects caused the sitters to move somewhat, (3) although not understood by the optical

⁷² H. H. H. Cameron, interviewed by “GW” (Gleeson White) in “Photographic Portraiture: An Interview with Mr. H. H. Hay Cameron” reprinted in *The Birth of the Studio, 1893-1895*, Simon Houfe, editor (Woodbridge, Suffolk: Antique Collectors’ Club, 1976), p. 50-51. He is essentially quoting from her *Annals of My Glass House*.

⁷³ Julia Margaret Cameron to Sir John Herschel, dated 31 Dec 1864, cited in Ford 2003, p. 87

designers of the 1860s, a normal lens suffers considerable loss of resolution when used at 1:1, (4) the camera probably settled during the long exposures, and lastly, (5) she often focused as she wanted, not as technique dictated.

What is unusual is that she did not acquire Dallmeyer's other 1866 lens design, the variable softness *Patent Portrait* lens. Because of her isolation from the photographic fraternity, she may have been unaware of it. Or did she not desire to have the softness in her images to be caused by a lens? On its face, it would seem that the *Patent Portrait* lens would have been perfect for her needs and aesthetic vision. Perhaps this is the best argument that she did not intend to produce softened effects but was simply not able to regularly produce sharp images. In an era before high quality enlargements could be printed, she was willing to accept the compromise between image size and sharpness, attempting to create larger negatives (referring in particular to the 12 x 15 inch size) than most professional photographers of the time could manage, and was not concerned with the sharpness. When submitting prints to salons of the 1860s, any print that large (the normal size was 'whole-plate' or 6½ x 8½ inches) would garner immediate attention rather regardless of the technical defects it contained.

Because Mrs. Cameron's diffusion was totally uncontrolled and therefore varied substantially from negative to negative, and, if the argument above is correct, she should not be considered the prophet of diffused focus images, but rather, a dilettante-amateur who lacked the technical sophistication (and, perhaps, the motivation) to produce a consistent image quality.

Summary

William Crawford was the first to elucidate the concept that the syntax of photography is technology. The photographic syntax begins with the elements capturing the image: film, camera, lens, etc., and ends with the printing⁷⁴ of the final image; it is a system of many parts, with nearly infinite combinations and permutations, all of which create a syntax of photography. The two which usually most influence the visual appearance of the print are the lens and the printing method.

Early in photography's history the debate between the diffused image and the sharp image was framed as the contrast between the calotype and the daguerreotype, both of which were swept away by the wet collodion negative. The new process was combined with the albumen printing process to create an extremely sharp final print, which revealed many of the sitter's flaws in a portrait. The syntax of photography had become too truthful and required adjustment by means of retouching, a tedious hand process which required highly skilled technicians.

There had been calls for diffusion to be introduced into photograph as early as 1853, almost exclusively by artists in other media or art-critics, as a matter of producing artistic images. Largely these calls fell on deaf ears and photographers did not move to the concept until it impacted the financial gains of the portrait trade. After a year or so of debate amongst London camera club members, John Dallmeyer invented the first soft focus lens, the *Patent Portrait*, in 1866. It should be noted that its purpose was to reduce expensive retouching in the portrait trade rather than to create artistic images.

At that same time, an amateur photographer was creating large prints, some of which

⁷⁴ Direct positive processes such as daguerreotypes and Polaroids do not require a printing step, but they have been in the minority of photographic processes since the passing of the tintype.

were very diffuse in nature. Julia Margaret Cameron strove to produce an artistic rendering of her subjects rather than an objective description. Her methods were inconsistent and unreliable and although they garnered some attention in the larger art world, they were largely criticized or ignored by fellow photographers. With her withdrawal from photography, the aesthetic of the diffused image essentially vanished until the revival of the 1890s.

Chapter 2: New Syntaxes, New Horizons

It is scarcely to be wondered that all the impulses forward should emanate rather from the amateur than the professional. The former pursues the art for pleasure, the latter for profit. The one can try all manner of experiments, and whether he succeeds or fails, he secures his object - agreeable occupation. The professional has all his energies directed to make things pay. He has too much at stake to speculate.¹
Jabez Hughes (1863)

The New Syntax- Collodion

The years from Archer's announcement of wet collodion in 1851 until the early 1880s could be called the reign of collodion. Collodion in its manifold applications (the ubiquitous tintype, ambrotype and wet plate negative) ruled the entire photographic world. It offered such overwhelming advantages over the daguerreotype and calotype that the professional photographers switched to it almost instantly. However, it was a difficult to master process, using potentially explosive ingredients (collodion), a potent poison (cyanide), and requiring the darkroom to be close at hand. Further, the coating of the glass plate with the syrupy collodion took substantial manual dexterity; the difficulty increases geometrically with the area of the glass plate. Whereas the calotype had been within the reach of motivated amateurs, the wet collodion essentially was not. There are notable exceptions, such as Julia Margaret Cameron and Clementina, Viscountess Hawarden (England 1822-1865), but such amateur involvement was unusual. The need for a darkroom close at hand limited those exceptional amateurs to photographing in interiors and grounds around their grand homes; the landscape was scarcely noticed by them.

¹ Jabez Hughes, *BJP* (1 Dec 1863) cited in Ford 2003, p. 86

Due to the slow emulsions of the wet plate era combined with the Victorian mindset that the *raison d' être* of a photograph was to be a perfect simulation of reality and therefore *must* be as sharp as possible, the real dawning of the medium was delayed until 1889 when there was a true revolution regarding the role of photography. A new attitude theorized that it could be art; perhaps in direct opposition to its previous role as science. On the other hand, professional photography had become stale and moribund in the 1870-1890 period with almost no changes in either aesthetics or technology

“The period from 1870 to 1890 was one of transition and was singularly barren of progress in pictorial work. The old ideas had lost their vitality, whilst new ideas were not generally accepted.”² The dulllest period of photography, the 1870-1890 years, can largely be attributed to photographers blindly following trends originated by manufacturers, whose interests lay in profits, not aesthetics. Badly painted back drops, contrived faux props and a myriad of vignette devices all helped keep the makers in the black and consumers in the dark. An examination of a hundred random cartes-de-visite will illustrate the homogeneity and lack of individualism so representative of the era.

² J. Dudley Johnston “Phases of Development in the Development of Pictorial Photography in Britain and America” *The Photographic Journal* (Dec., 1923) p. 573.



Figure 2.1: Two staid American cabinet cards representative of portraiture in the 1870-1885 period (collection of the author)

Although many studio-oriented conventions of Pictorialism eventually are absorbed into the professional mainstream, most of the darkroom-oriented technical advances in printing were not; these techniques were typically slow, results not precisely repeatable, and might require significant experience to master. Professionals sought to produce prints as rapidly and cheaply as possible to enhance their cash stream.

This fossilized approach to photography was swept away by a radical change in syntax: the transition from wet plate negatives to dry plates and soon thereafter, to flexible roll film. This was the most significant change in photographic syntax since the invention of photography and was not equaled again until digital photography in the 1990s. There were also corresponding changes in printing media; the platinum print was introduced on the commercial market, the daguerreotype had totally disappeared, tintypes

had dwindled to a small percentage of their former market share, enlarged negatives become more feasible, and cameras aimed at amateur photographers were immense commercial successes. An amateur market had developed, for better or worse, and photography was no longer the exclusive domain of the professional.

Dr. Richard Leach Maddox (England 1816-1902) is generally credited with the invention of the dry plate in 1871. Unlike the wet collodion process, the dry plate was not perfect as invented and required several years of further development to be of practical use. In particular, Maddox's plates were much less sensitive to light than wet collodion. The first commercially sold plates were made by London photographer John Burgess in 1873; they had problems as well. The Liverpool Dry Plate Company introduced a much improved version in 1876 but it failed to be a financial success because of the marked conservatism and unreserved skepticism of professional photographers. The chemical and physical problems were soon resolved and by 1879 the firm of Mawson & Swan was utilizing an automatic coating machine to insure nearly perfect plates each time.

The advantages were undeniable. As Gernsheim noted, "photographers could no longer deny the superiority of dry plates, their good keeping qualities, their simplicity of development, and above all, their wonderful rapidity..."³ By 1882 or so, the revolution was complete — almost all professionals were using dry plates — and with them amateurs as well. "Pictorial photography received a large accession of votaries in consequence of the greater facilities offered by the introduction of the gelatino-bromide or dry-plate process, which, although dating from 1880, did not notably affect the

³ Helmut Gernsheim, *The Rise of Photography 1850-1880* (London: Thames & Hudson, 1998) p. 255.

photographic communities until some years afterwards.”⁴ The era of amateur involvement in photography was now technologically enabled to proceed.

The higher speed of the new dry plates also allowed hand-held cameras to finally become a reality. For all practical purposes, every exposure made from 1839 until dry plates had been made with the camera on a tripod or other stationary rest. As a matter of syntax, this exerted significant control in the selections of the subjects and compositions by any photographer. By the 1890s, hand cameras, both the cheap box cameras of the total amateur as well as Graflex-type reflex cameras used by more advanced amateurs and professionals, allowed photography to go on the move almost anywhere there was enough light. Suddenly a camera might be seen in almost any context and without any notice (as compared to erecting a tripod which signaled to anyone in sight that a photograph would soon be made). The Graflex and its commercial variants were widely used by Pictorialists; Stieglitz, Annan, Coburn, Post, Anderson, Hagemeyer and Weston were among those who took advantage of its unique syntactical possibilities.

In photographic syntax, changes in the process creating the negative are always accompanied by corresponding changes in printing methods. This is essentially necessary because the contrast range of the negative must be matched fairly precisely by the printing medium. The calotype had been matched to salted paper; the wet-plate to albumen. With the advent of the dry plate negative, new printing methods were bound to follow. The platinum print (or platinotype) was introduced to the English market in 1880⁵ and soon became the major printing method promoted by “art” photographers. The

⁴ A. Horsley Hinton “Pictorial Photography” *The Encyclopaedia Britannica* 11th ed. (Cambridge: University Press) p. 521

⁵ Luis Nadeau, *Encyclopedia of Printing, Photographic and Photomechanical Processes* (New Brunswick: Atelier Luis Nadeau, 1994) p. 389.

market penetration was initially retarded because in addition to the expense of the paper, inventor William Willis (England 1841-1923) required a license as well, costing five shillings, regardless of whether the user was an amateur or professional.⁶ After Peter Henry Emerson's strong recommendation in 1889, it became the prime printing medium for artistic photographers and to a great extent remained so until after World War I.

By the 1890s, photographers were inventing their own printing processes, such as gum bichromate and oil, which became the lightning rod for criticism of Pictorialism in general. This became the first time since the earliest years of photography that photographers would lead the industrial manufacturers rather than the other way around. On the whole, pictorial inventions and modifications such as gum prints and oil prints never represented more than a tiny segment of the international photographic market and were entirely ignored by the larger manufacturers.

⁶ Crawford 1979, p. 76.



Figure 2.2: Sanguine gum bichromate portrait *Profile* by Celine Laguarde, the apotheosis of early pictorialist art (“Art in Photography” *The Studio* 1905 plate F.1)

Manufacturers regained near total control as flexible roll film and box cameras came to dominate the world market for the next seventy years (the first Kodak box camera was marketed in 1888); the “rank” amateur had become the target of the photographic manufacturers. Advanced amateurs such as the Pictorialists, did not represent enough of a market segment for the large manufacturers to cater to that niche. However, many small new-start companies such as The Platinotype Company would be bought up by the larger companies *if* they have demonstrated successful market

penetration. Eastman Kodak would appropriate any good idea, regardless of the original source, should the market conditions demonstrate a profit was probable, not just possible.

Accompanying the new syntax of roll film, printing paper sensitive enough to be exposed to artificial light was mass marketed by Eastman (Kodak) beginning in 1884.⁷ Prints could be made day and night enabling factories to produce thousands of prints in a short time and amateurs could print at night after work. Matte surfaced silver bromide prints, deliberately imitating platinotypes, were introduced by Eastman Kodak in 1894 as *Platino*. Lacking any of the significant attributes of platinotypes (tonal range, longevity, color) the sole comparison was the matt surface — but that was enough to attract amateurs not willing to work with platinum papers or uneducated enough to believe the two were indeed equivalents.

Moreover, for the first time, enlargements were now practical. Virtually all printing processes prior to silver bromide were sensitive solely to blue and ultra-violet light and required printing by sunlight. Only a contact print could be made — one where the negative was in direct contact with the paper and the resulting print was precisely the same size as the negative. Although the concept of enlargement, that is, making a direct print larger than the negative, dates to Talbot, the printing media were too insensitive to light until the late 1880s. There had been the use of “solar” enlargers, huge boxes on tilting mounts, which tracked the sun, as early as the 1860s but they were cumbersome, required good sun light, constant attention and the heat generated often broke the collodion negative. Now, however, a gas light or the newly invented electric bulbs could

⁷ Josef Maria Eder *History of Photography* Edward Epstean trans. (New York: Dover Publications, 1978) p. 440.

provide enough light. No longer was a large camera necessary in the field in order to produce a large print.

The creation of the first new optical glass since before the invention of photography occurred at the Schott optical works in Jena. They introduced several new types of glass beginning in 1886 that allowed lens designers previously undreamt of possibilities. Freed by the new glasses, designers soon began creating previously impossible objectives with undreamt-of levels of aberration correction. The first true anastigmats were made by Zeiss in 1890⁸ and heralded a new category of lenses that gave photographers unprecedented sharpness in their negatives.

Social change had helped create an upper-middle class in America; they had some leisure, disposable income, and aspirations resulting in America's "Gilded Age." Although the British economy was not as robust and the entrenched social class system was slow to allow for the *nouveau riche*, a solid middle class was developing there as well. These people would soon swell the ranks of amateur photography and become the dominant market for photographic supplies, a much larger and more lucrative segment than the professional market which had previously been the nearly sole consumer of equipment and supplies.

Images formed by Pinhole

The concept of the diffused photograph essentially lay moribund from not long after Dallmeyer's patent of 1868 until new life was breathed into it by the rise of pinhole photography. By its definition, the pinhole produces a less sharp image than a lens

⁸ Eder 1978, p. 408.

although it has the advantage of an infinite depth of field, extending from the pinhole surface to infinity.

Pinholes as imaging devices had been known for centuries, perhaps as early as 400 B.C.,⁹ but it was probably not adapted to photography until the polymath Sir David Brewster experimented with using them to create images utilizing a camera. Writing from St. Andrews in 1856, Sir David Brewster noted that “The Rev. Mr. Egerton and I have obtained photographs of a bust, in the course of ten minutes, with a very faint sun, and through an aperture of less than the hundredth of an inch; and I have no doubt that when chemistry has furnished us with a material more sensitive to light, a camera without lenses, and only a pin-hole, will be the favourite instrument of the photographer.”¹⁰ In other words, the syntax of photography had to change before pinholes could emerge as serious image-forming devices.

Lens designer John Dallmeyer had also experimented with pinholes before 1866 but concluded “the image so obtained is too feeble and indistinct to be of any practical use to the photographer.”¹¹ It’s likely that most lens designers had some first-hand familiarity with pinhole formed images as a function of their education.

There seems to be a substantial gap in pinhole interest until an article by Capt. William de Wiveleslie Abney (England 1843-1920) in the *Photographic Society’s Journal* (April 22, 1881). It does not appear to have caused anyone to further the idea and actually take pinhole pictures; it was a technically oriented article which did not inspire

⁹ Eric Renner, *Pinhole Photography, Rediscovering a Historic Technique*, 3rd ed. (Boston: Focal Press, 2004), p. 4.

¹⁰ Sir David Brewster *The Stereoscope, Its History, Theory, and Construction* (reprint of the 1856 edition, Hastings-on-Hudson, NY: Morgan & Morgan, Inc., 1971), p. 137.

¹¹ Dallmeyer, December 21, 1866, p. 605.

such action.¹² Nonetheless, it probably served to promote discussion around the tea kettles in the burgeoning camera clubs of the United Kingdom.

The *BJP* published a two-part article in March and April of 1885 detailing pinhole photography.¹³ The author had shown pinhole photographs to the Newcastle-on-Tyne and Northern Counties Association the year before (1884) and although the article is largely mathematically oriented, it is clear that this author has had practical experience with the pinhole, not just philosophical or mathematically derived. His images must have been of good quality, as he compares a photograph taken with a rapid rectilinear and a pinhole, saying “I should expect them to be identical.”¹⁴ This is the earliest *BJP* article detailing practical pinhole photography and it should be noted that this was read not in London but in Newcastle, indicating interest from well outside of the major clubs in large metropolitan centers. It would be most interesting to know what inspired Proctor to make serious practical inquiries into pinhole photography.

Two year later, although there is not much mention in the major photographic publications, Forgan would write that nonetheless “a good deal of interest has been taken of late in pinhole photography, considerable attention having been bestowed upon it in France, and afterwards among photographers in this country.”¹⁵ Pinhole photography is so widespread, he says, that few have not seen a pinhole photograph. He also gives an account of his camera, made from a rough pine box, indicating that pinhole photographers were already eschewing the products of mass manufacturing at this early stage. Forgan gives a five point list of the advantages of pinhole, chief among them being

¹² Nonetheless, it is utilized by George Davison in his first article in *Photography*, 4 April 1889, p. 240.

¹³ Barnard S. Proctor, “Lessons Derived from Pin-Hole Photographs” *BJP* Vol. XXXII, No. 1299, March 27, 1885 pp. 204-205 and Vol. XXXII, No. 1300, April 3, 1885, pp. 221-222.

¹⁴ Proctor, April 3, 1885, p. 221.

¹⁵ W. Forgan, “Pinhole Photography” *BJP* Vol. XXXIV No. 1438, Nov. 25, 1887, pp. 234-235.

low cost. He never mentions any aesthetic advantage of the diffused image. The pinhole is finally moving from the exclusive realm of science and into the hands of active amateur photographers.

A critical change in syntax, i.e., the speed of dry plates as compared to wet plates, is pointed out in an 1888 *BJP* article. “This photographer, on a sunny day, made pinhole exposures as short as ten seconds.”¹⁶ Thus, pinhole photography is now technically enabled but still there is no mention of the aesthetic qualities of a diffuse image. Probably much like today, there was a substantial percentage of amateur photographers whose involvement in photography was driven by the desire to experiment with new technology rather than produce significant images.

French photographer Capt. René Colson had experimented with pinhole and published his findings in a French journal which was translated and printed in the *BJP* in 1888.¹⁷ His paper was not about using a pinhole for art but was working towards establishing the relationship between the pinhole size and image sharpness. Its role is not important for the mathematics involved but because it brought the topic of practical pinhole photography before the English photographic audience.

Soon thereafter, Lord Rayleigh (1842-1919), one of the pre-eminent scientists of the era, published a brief article in *The Photographic Journal* on both the mathematics and empirical testing of long focal length pinholes¹⁸. The idea of a 9 foot focal length pinhole probably interested very few photographers, professional or amateur. It did,

¹⁶ Professor William H. Pickering, “The Pinhole Camera” *The Photographic News* March 2, 1888, p. 137. A subsequent note by the editors (March 30, 1888, p. 195) indicates Pickering’s article was originally published in *Anthony’s Bulletin* and therefore must have received notice in America as well.

¹⁷ *BJP*, Vol. XXXV, No. 1465, June 1, 1888, pp. 343-344. Colson had published a slightly earlier paper in *Bulletin de la Societe Francaise de Photographie* in January, 1887, but I find no English republication.

¹⁸ Lord Rayleigh, “Pinhole Photography,” *The Photographic News* September 20, 1889, p. 611.

however, bring the issue of pinhole photography to the correct venue — photographers rather than scientists.

Also in 1889, Emerson suggests in *Naturalistic Photography* that “in cases where the length of time is immaterial, this method would be a worthy field for experiment.”¹⁹ At last, a major and highly vocal artist-photographer brought the issue of pinhole imaging to the fore. A year later, he modifies the earlier statement with “this equally diffused softness, although preferable to 'sharpness,' is a meretricious device, as I recently pointed out, and not in accordance with nature.”²⁰ Nonetheless, it was too late to retract his earlier and widely circulated statement; the topic was now on the table for photographers to examine on their own.

George Davison’s (England 1854-1930) first published article (excluding letters to the editor and other short contributions) appears in the April 4th, 1889 issue of Photography. His account of how to construct and use a pinhole camera is very sound and thorough, indicating he has already accumulated a fair body of experience with one. He immediately argues for an aesthetic basis for pinhole photography, probably the first time anyone has done so: “we enter a personal testimony in favour of soft, broad and true renderings of nature by pinhole photography in pure landscape, as giving greater aesthetic pleasure than the work done by most lenses.”²¹

Where do the definition votaries demand the detail? If all over the picture, in distance as well as in near objects, all are brought into one plane, and perspective is lost. If only in one portion of the scene, and the rest falling away, they will be at a loss to explain why detail should be more definite or specially sharp in that plane, or rather in that curved area... but in landscape the effect of one plane only

¹⁹ P. H. Emerson, *Naturalistic Photography for Students of the Art, Book II* (New York: E. & F. Spon, 1889) p. 132.

²⁰ Emerson 1890, p. 39.

²¹ Davison 4 April 1889, p. 241

being sharp, where unimportant objects right across the picture in that plane are emphasized, is disturbing and unnatural.²²

Here Davison has pointed out the deficiencies in Emerson's 'naturalistic focusing' and perhaps here lies the beginning of Emerson's antagonism, despite the fact that Davison is interpreted as his surrogate in the press during the next year or so.

Moreover, Davison is not championing only the pinhole: "Although practical instruction in pinhole photography is made at the centre of this paper, we are not concerned for the exclusive use of a pinhole, only for the effect obtained thereby. Let anything that will give it be used, whether it be pinholes, special lenses, printing through the back of the glass of a negative, or moving the plate to and fro during exposure."²³ Since there was no other soft focus ("special") lens in existence in 1889, Davison must be referring to the Dallmeyer Patent Portrait of 1866, which was still in production thirty years later.

Pinhole photography must be relatively widespread in the amateur community by now (1889) as he notes that there is a ready-made pinhole camera manufactured in the United States by the Ready Fotografer Co.²⁴ Several other makers will follow suit and the commercially manufactured pinhole camera became widely available, at least in England and America.

Lord Rayleigh's thoughts had turned from the science of pinholes to making photographs with a pinhole by 1891. His attitude has made a marked change from the applications of science to the possibilities of art as witnessed by his philosophizing: "...in

²² Davison ,4 April 1889, p. 241.

²³ Davison ,4 April 1889, p. 241.

²⁴ Davison ,4 April 1889, p. 241.

landscape photography, where a high degree of definition is often unnecessary...²⁵ Was Davison's paper the cause of Rayleigh's new view?

Davison's Pinhole Principles

Unlike Emerson, Davison never published a book of his theories and practices. However, his magazine articles are extensive and he may actually have more words in print regarding the subject of focus than Emerson has in *Naturalistic Photography* (given that focus is only one small issue in the text). Additionally, Davison may have had more credibility with amateurs than Emerson, given the number of awards he had garnered in his two years in photography; in 1887 he "carried off more prizes this year than any competitor, professional or amateur."²⁶ By 1893, no less a critic than Alfred Stieglitz notes that *The Onion Field* is "world-renowned, and has been medaled wherever shown."²⁷ *The Onion Field* was still exhibited in 1901 at the Glasgow International Exhibition, indicating its transition to iconic status in a decade.²⁸ Davison was the first *avant-garde* modernist photographer — he used a process well outside the main stream (pinhole), and was a founder of the first modernist group in photography (Linked Ring) which was a secessionist movement (from the Photographic Society of Great Britain). *An Old Farmstead* was taken on an outing with the Camera Club (London) on an outing to Gomshall, May 1889 and was first exhibited in 1890 at Photographic Society of Great

²⁵ Lord Rayleigh, "On Pin-hole Photography" *Philosophical Magazine and Journal of Science*, Vol. 23, 1891, p. 89.

²⁶ *Amateur Photographer* 6 January 1888, cited in Brian Coe, "George Davison: Impressionist-Anarchist" *British Photography in the Nineteenth Century*, Mike Weaver, ed., (Cambridge: Cambridge University Press, 1989) p. 218.

²⁷ Alfred Stieglitz, "The Joint Exhibition at Philadelphia" (*American Amateur Photographer*, May, 1893) reprinted in Richard Whelan, *Stieglitz on Photography* (New York: Aperture, 2000) p. 41.

²⁸ William Buchanan, "The Art of the Photographer: J. Craig Annan" *Photography_1900* Julie Lawson, Ray McKenzie, A. D. Morrison-Low eds. (Edinburgh: National Museums of Scotland, 1992) p. 40.

Britain. J. Dudley Johnston (England 1868-1955) believed “the consensus of opinion is that the first visible sign of the break with older Victorian tradition is to be found in Davison's picture “An Old Farmhouse” or, as it was called later, “The Onion field.”²⁹ It is perhaps the one image that could be referenced today as the ‘first modern photograph’ in that it was a complete break with the traditional syntaxes of photography.

Davison’s position as “editorial contributor” (1889-1897) of *Photography* magazine allowed wide and almost instantaneous (in contrast to a book) diffusion of his thoughts; it claimed the largest circulation of any photographic magazine of the time.³⁰ Between his writings and his awards, Davison was a highly visible, but nonetheless quite modest, amateur photographer of high standing. Unlike the wealthy and elitist Emerson, Davison worked for a living and had to find the time for his photographic endeavors. Given this, his output, both photographic and written, is remarkable.

His first full length article (April 4th 1889) was a very practical and reasonably comprehensive set of instructions; his next full length article on Sept. 19th covers the philosophical components of “definition and diffusion.” The third installment, October 17th, works through some of the specific arguments for diffusion and five methods of obtaining it. A month later, November 14th, he returns to practical but advanced pinhole techniques. The final article, printed December 12th, is a mix of ‘loose ends’ including references to Claudet’s method, Dallmeyer’s lens, and interposing celluloid betwixt negative and printing paper. If all five articles were arranged in one publication and re-edited, it would still have value for modern pinhole photographers. These five articles

²⁹ J. Dudley Johnston “Pictorial Photography” *The Encyclopaedia Britannica* 14th ed (Cambridge: University Press, 1929) p. 831.

³⁰ Brian Coe, “George Davison: Impressionist-Anarchist” *British Photography in the Nineteenth Century*, Mike Weaver, ed., (Cambridge: Cambridge University Press, 1989) p. 241.

encapsulate much of what Davison said in print elsewhere during the next two years and thus are extensively quoted in the following pages.

The April article is a very practical, hands-on approach to making pictures by pinhole. Davison cites Abney's paper of 1881³¹ and its conclusions regarding calculating the proper size of pinhole given the pinhole-to-film distance. He then discusses ways to make a good pinhole and methods to mount it on a standard camera; clearly he has significant experience with pinhole photography and is not plagiarizing what had already been written, a not uncommon practice then or now in photographic literature.

Despite being cast as a votary of Emerson in the vocal disputes which followed publication of *Naturalistic Photograph*, Davison has already disagreed with Emerson in a central issue: differential focusing:

If all over the picture, in distance as well as in near objects, all are brought into one plane, and perspective effect is lost. If only in one portion of the scene, and the rest falling away, they will be at a loss to explain why detail should be more definite or specially sharp in that plane, or rather in that curved area... but in landscape the effect of one plane only being sharp, where unimportant objects right across the picture in that plane are emphasized, is disturbing and unnatural.³²

Furthermore, in the April 4th article on pinhole photography, Davison concludes “we are not concerned for the exclusive use of a pinhole, only for the effect obtained thereby. Let anything that will give it be used...”³³ He thus reveals his basic philosophy is one of the diffused image, not differential focusing with an otherwise sharp lens.

Davison's next article is not until September 19th. This article takes a completely different tack than the prior one: addressing the contrary stand of Henry Peach Robinson (England 1830-1901). He needed to address H. P. Robinson's theories because he has

³¹ Capt. W. de W. Abney, *Photographic Society's Journal*, April 22, 1881.

³² Davison April 4, 1889 p. 241.

³³ Davison April 4, 1889 p. 241.

been the leading writer/authority on “art photography” since the first publication of Pictorial Photography in 1869. This book was *the* successful tome of the time on art photography, having been reprinted in 1879, 1881 and 1893 in Britain; foreign editions included American (1881), French (1885) and German (1886). With it, Robinson had established himself as the key theoretician of artistic photography. By the time of Davison’s paper, Robinson had also authored *The Art and Practice of Silver Printing (1881)*, *Picture Making by Photography (1884)* and *The Studio and What to Do in It (1885)*, *Letters on Landscape Photography* (American edition, 1888). Any new upstart in artistic photography would have to begin by confronting Robinson’s ideas head-on.

Davison disputed H. P. Robinson’s well-known contention that definition is the distinctive quality of photography and that “all photographic work not sharply defined in its details is base art and ought to be forbidden.”³⁴ Davison argues that if anything, fuzziness is more an element of photography than sharpness since it is so much easier to achieve. Instead, he proposes “its distinctive feature is much rather the power it has of giving at one stroke a natural scene with all its perfection of drawing and delicacy of tone.”³⁵ His refutation of Robinson’s photo-collages is very sophisticated and not based on their artificial appearance but because the method will “destroy all delicate harmonies and the beauty of outlines melting into, or coming decisively against, atmospheric distance or other tones, and with the destruction of these qualities goes that which is

³⁴ G. D. (George Davison), “Definition and Diffusion” *Photography* Sept. 19, 1889, p. 529. It is worth noting that by 1893, Robinson had adopted Davison’s stance; see his *Elements of a Pictorial Photography*, pp. 57, 59, 70, 81.

³⁵ Davison Sept. 19, 1889, p. 529.

distinctive, best, and truest in our particular art.”³⁶ Thus, Davison argued, Robinson’s own imagery is counter-photographic.

Having successfully refuted Robinson’s famous and long standing arguments, Davison now turns to Emerson, although not by name. Nonetheless, it is difficult to imagine that any well-informed reader would not be aware of the intended target. He revisits the Ludwig Ferdinand von Helmholtz (German 1821-1894) findings regarding the eye’s functions (see further on page 73), appearing to be building an identical argument to Emerson. He concludes, however, that those arguments are irrelevant: “Although, however, the eye may see sharp detail in one very narrow point, that is not the way the mind of the artist operates in looking upon and enjoying a beautiful scene. The interest attaching to seeing this detail is quite distinct from that of the enjoyment of the subject which makes the picture. Sharp detail even in the principal object is absolutely destructive of the highest effect to be attained by the artist.” He has unequivocally separated himself from Emerson’s “naturalistic” school based on physiology and has instead turned to how an *artist* perceives a scene. Davison is linking his theories to the Impressionist movement in painting, a truly modern base compared to Emerson’s Naturalism, which plagiarized the theories of that English school of painting.

Moreover, this article makes some of the earliest calls for a specific soft-focus lens: “For such an instrument as is here required we must look to the opticians. It cannot be expected, however, that the optician will trouble himself to produce any other than what is called a scientific instrument, one of precision, unless artists show the necessity, and make a demand for lenses suited to express more exactly what they require. It is

³⁶ Davison Sept. 19, 1889, p. 529.

hoped that some will do this.”³⁷ Four more years will pass before Thomas Dallmeyer designs the first modern soft focus lens, the Dallmeyer-Bergheim, and ironically, Emerson unintentionally helped.

Davison’s third article (October 17, 1889) follows the second by only a month and hardly mentions pinhole. Rather he confronts one of the major anti-soft focus arguments that the eye accommodates and sees everything sharply, summarizing “that mere suggestion of objects outside the limits of sharper vision when the eye is fixed upon one point of interest, or that impression of a scene which is gained by a general observation of its characteristics.”³⁸ For the first time, he mentions Emerson by name when confronting his theories.

The central focus of his article, however, is methods of obtaining the desired softness. He enumerates them as the putting of the principal object slightly out of focus, all beyond being more so, using a lens with spherical aberration, Claudet’s method of moving the lens during exposure, use of a pinhole rather than a lens and printing though a diffusing sheet. The use of a lens possessing spherical aberration is prophetic of the development of the modern soft focus lens, preceding the invention of the *Dallmeyer-Bergheim* lens by several years.

The next article written on November 14, 1889, centers again on pinholes as an imaging device. He supplements the advice given in the first (April 4th) article on practical pinhole use by further detailing issues encountering in the field when using pinholes. Once again, it’s quite clear that Davison has substantial field experience, and his advice is still sound today. In his final article (December 12th) follows his standard

³⁷ Davison Sept. 19, 1889, p. 530.

³⁸ Davison 17 October 1889, p. 585.

pattern of stating an anti-soft focus argument, then defeating it, and going into some technical details. He gives a fair amount of detail on the variant methods of using a diffusing sheet betwixt the negative and printing paper, noting that “it is a very old practice.”³⁹

Aware of Claudet’s old proposal of moving the lens, Davison dismisses it as impractical, as had been concluded more than thirty years before. The thrust of this article resides in the last few paragraphs where he again raises the idea of controlled spherical aberration to soften the image. “The aim of the optician for this purpose must be to produce a lens which will give depth and softness at the same time, spherical aberration remaining even with a fairly small diaphragm,”⁴⁰ a goal which has yet to be achieved.

The Society of Arts Communication, 1890

The December 12th article was the final of the series but a year later what was perhaps Davison’s most important paper was printed. In that year’s interval much had changed, including the widespread dissemination of *Naturalistic Photography* and the formation of the Linked Ring by dissidents from The Photographic Society.

The tone was totally at variance from the previous set of articles; those had been aimed at amateur photographers who wished to attempt pinhole photography or had aspirations as “artist-photographers.” This article was a communication delivered to the prestigious Society of Arts, an honor that was never extended to Emerson, and another indication that his contemporaries valued Davison’s thoughts more highly than Emerson’s. The fact that the address was to an influential arts group rather than

³⁹ Davison 12 December 1889, p. 685.

⁴⁰ Davison 12 December 1889, p. 685.

photographers was beyond a doubt a major coup for photography as an art and Davison as its leading proponent.

Davison reveals his breadth of art history and theoretical understanding as he slowly unwinds his impeccable arguments. At its root, this is a call for revolution patterned after the “revolt against conventionalism” led by “those painters who have been variously called impressionist, naturalistic, and the like.”⁴¹ He walks a thin line combining principles from ‘naturalism’ with ‘impressionism’ to synthesize a third school.

In reviewing the painter’s art, ‘chained by dogma’ and beset with ‘unnatural conventions’, he may be making a reference to Emerson who spent a great number of words in *Naturalistic Photography* reviewing the achievements of past art, and using them to discover principles to support his views of ‘naturalism’ (more will be said on this in the next chapter).

Davison only once refers to Emerson in this paper; the reader/listener instead should refer to “Mr. Francis Bate's book, *The Naturalistic School of Painting*, a fresh, direct, convincing little work which every photographer should read, and in parts re-read, and to which I wish to express my own indebtedness.”⁴² This book is exceedingly rare today and as far as can be researched by a reference librarian, no known copy of the first or second edition exists; no certain publication data can be found for the first edition but the second edition was printed in 1887, before Emerson’s book. H. Francis Bate (1853-1950) was an English painter and educator. Nonetheless, this may explain why Davison’s thinking is at odds with Emerson’s even at the outset — his thinking followed Bate rather than Emerson. Emerson took great offence at Davison’s statement,

⁴¹ Davison 26 December 1890, p.821.

⁴² Davison 26 December 1890, p.822.

Suggestions have been made that I get some of my ideas from a book, called 'Naturalistic Painting.' I have a letter in my possession from an artist wherein is stated clearly and exactly that Mr. Bate has read a paper of mine on *Naturalistic Photography before* his first article appeared in the 'Artist.' At the Society of Arts, the other day, a paper was read by Mr. Davison - an amateur without training, and with superficial knowledge - in which my *old* ideas were freely and impudently handed about and no credit given me.⁴³

Davison did no such thing or even infer that Emerson's ideas came from Bate, only his own. Emerson is clearly hyper-sensitive about the issue; it would be revealing to know precisely why. The only time Davison mentions Emerson is in the concluding paragraph, quoting him in a positive manner.

Davison defines the naturalistic position as “a scene which appeals to our experience of nature — harmonious and truthful” which will “affect most powerfully our aesthetic sensibility” and can only be “secured by a direct reference to nature.”⁴⁴

The core of Davison's thrust is “to put forward the claims of photography...to be admitted as a capable means of artistic expression.”⁴⁵ He delicately draws in the audience of painters, giving the ideas “of some classes of painters who have despised and condemned photography” along with some similar photographers who viewed “any reform or movement which promised better artistic expression as ‘apeing the conventionalities of painting.’” But most importantly, the argument of the mechanical nature of photography is defeated by the issue of style, that is, “two photographers separately treating the same subject will produce two impressions, almost, if not quite, as different in qualities as would two impressionist painters in monochrome.”⁴⁶ “The mere

⁴³ P. H. Emerson “Death of Naturalistic Photography” in *Naturalistic Photography for Students of the Art* 3rd ed 1891 (reprinted New York: Arno Press, 1973) unpaginated addendum

⁴⁴ Davison 26 December 1890, p.822.

⁴⁵ Davison 26 December 1890, p.822.

⁴⁶ Davison 26 December 1890, p.822.

fact of the means including more mechanism is not a disadvantage if the result be more truthful and life-like.”⁴⁷

He is listing the various fallacies of arguments against photography, turning next to “the doctrine that minute definition is the distinctive quality of photography, and that, therefore, this should be made the most of in artistic work.” Of all the specious arguments about photography’s nature, this one is the most tenacious, resurrected dozens of times in the anti-soft focus debates in the 1900-1915 period and put forth vehemently forty years later by Edward Weston, Ansel Adams, Beaumont Newhall, Helmut Gernsheim, and others. Davison states the rebuttal simply and directly: “it is no more the distinguishing feature of photography than is exaggerated perspective, or indeed, the want of definition that is diffusion or softness.” Even more importantly, “such definition is not the distinctive characteristic of *seeing*,”⁴⁸ harkening back to Emerson and Helmholtz. Davison even pokes fun at them: “it is certainly very refreshing in its audacity to be told that because photographers have consented to smirch the fair name of their art by the general use of albumenized paper and small stops therefore this is to be its character forever.”⁴⁹

Another persistent accusation against soft focus is that it is “imitating the natural characteristics of a certain school of painting. It might with equal force, or no force, be alleged that those in favour of minute definition are, in their sharpist tendencies, apeing the characteristics of the old miniature workers.”⁵⁰

Davison addresses what he considers photography’s two great advantages: (1) “nothing gives so truthful a record in drawing” and (2) nothing “gives so delicately

⁴⁷ Davison 26 December 1890 p.823.

⁴⁸ Davison 26 December 1890 p.823.

⁴⁹ Davison 26 December 1890 p.824.

⁵⁰ Davison 26 December 1890 p.823.

correct a relation of tones.”⁵¹ This latter subject becomes a major rallying point for those advocating soft focus in the years to follow. Davison notes that “the subject of focus has altogether overshadowed the more important matter of tone...” a charge leveled at the f/64 school forty years later.

Davison concludes that if the two guidelines stated above, following the naturalistic theories of representation, then photography will be elevated “to its proper place amongst the foremost black and white processes.”⁵²

In the discussion which followed the presentation, another leader of the photographic art movement and co-founder of The Linked Ring, Alfred Maskell, summarized the paper as “a plea for the application of impressionist feelings or naturalistic principles to artistic photography.”⁵³ Davison used the term ‘naturalistic’ quite a number of times and only occasionally ‘impressionistic’- without differentiating them. Given that he chose to title the paper “Impressionism in Photography” rather than ‘naturalism’ one would expect an emphasis on the former rather than the latter.

Another contributor to the discussion was W. E. Debenham, who had just recently published a paper, which although it gave a balanced review of the pros and cons of differential and soft focus, concluded that “that photographs should be sharp all over, and that a near object should be as sharp as a far-off one.”⁵⁴ His response to Davison’s paper is exclusively concerned with “the arguments in favour of blurring a photograph” which were fallacious. Although he did not consider Davison “an extreme advocate of blurring” and “recognized the artistic character of Mr. Davison’s work, but thought it would be still

⁵¹ Davison 26 December 1890 p.823.

⁵² Davison 26 December 1890 p.824.

⁵³ Alfred Maskell “Discussion” *BJP* 26 December 1890 p. 825.

⁵⁴ W. E. Debenham “Is Blurring Desirable in a Photograph?” *The Photographic News* 14 November 1890 p. 883.

better if he would use smaller diaphragms and give better definition generally.”⁵⁵ For Debenham, his entire retort (approximately 600 words) addresses one paragraph of Davison’s approximately 7,000 word presentation, and is a good example of the fixation by those opposed to diffusion of focus. This is the same Debenham whose actions led to Robinson’s censure and the rejection of Davison’s image in the 1891 RPS salon which precipitated the Linked Ring formation.⁵⁶

Summary

If a single spokesman of the artistic-photography movement was in evidence at the outset, that person would surely be George Davison and not Dr. Emerson. Furthermore, Davison’s stimulus was likely not from Emerson’s tomes, as Emerson claimed, but from Francis Bate. It is important to consider the subject matter of Davison; he was almost solely concerned with the landscape, to the exclusion of portraiture, the nude, still lifes and other topics which will become the focus of Pictorialist lenses in the future. Given the sensitivity of film and the apertures of pinholes, they were limited to objects in direct sun light at this time (1890).

In the years before the invention of new soft focus lenses, his advocacy of the pinhole for artistic photographs was complete. “I favour them as giving the most pleasing softened quality of definition of any means yet employed in photography, and because such diffusion seems to me fairly to give the impression as regards focus which the mind

⁵⁵ Debenham 26 December 1890 p. 825.

⁵⁶ Margaret Harker *The Linked Ring* (Heinemann: London, 1979) p.53

selectively receives from many subjects.”⁵⁷ This also serves as the definition of impressionist photography for Davison.

Davison did not make a great differentiation between ‘naturalism’ and ‘impressionism’ in the Society of Arts paper, although at many other times, he clearly criticized naturalism, at least as described by Emerson:

...it seems to me that the bearing of merely optical phenomena upon the question has been over-estimated and too exclusively considered. The investigation of these phenomena is of great interest, but, after all, one is brought back to the conviction that the treatment in an artist's work is a matter of feeling, the results of complicated mental impressions, reactions and analysis. He can be bound by no one limiting rule as to what he must do in all cases.⁵⁸

For Davison the test was “Is it art?” and for his critics, “Is it photographic?” This framed the debate between Pictorialism and ‘straight’ photography for the next hundred years. Despite the rapid ascension and adoption of digital photography in the first decade of the 21st century wherein veracity is a moot point, the same lines can largely be drawn even now.

⁵⁷ George Davison “The Focus Question” *The Photographic News* 14 November 1890 p. 883.

⁵⁸ George Davison, 14 November 1890, p. 883.

Chapter 3: Naturalistic Photography

The only epoch-making book ever issued in connection with photography is Dr. P. H. Emerson's 'Naturalistic Photography,' the book which laid the broad and strong foundation of the present pictorial school of photography.¹
H. Snowden Ward and Catherine Weed Ward (1899)

Emerson's 1889 tome *Naturalistic Photography for Students of the Art* was a benchmark handbook on the state of photographic knowledge required to be an advanced amateur. It is important to note that unlike nearly all photographic handbooks which preceded it, this is not addressed to the professional but the amateur, reflecting the change in technology which had brought photography within the purview of a dedicated amateur. It marks a turning point in the bibliographic history of photography. Further, Emerson's assumptions that the art of the past is worth study for emulating the 'classic' formulas is a very Victorian look at the past glories and lionizing tradition; Davison, on the other hand, represents looking at the present to see the future of art, meaning a complete break with the past if necessary.

Discussed today mostly for advocacy of "naturalistic focus," the book was a strong seller and went through three editions in ten years. It was generally well written and readable (except the sections relevant to focus and aesthetics), providing a very sound and thorough grounding in state of the art methods. Most advanced amateurs of the 1890s on both sides of the Atlantic probably read one of the three editions, if for no other reason than to be able to carry on informed discussions with other amateurs, especially in the atmosphere of exchange in the burgeoning camera clubs. Emerson himself gave a

¹ H. Snowden Ward and Catherine Weed Ward, "Current Topics" *The Photogram* Volume VI. No. 72, April, 1899, p. 387.

special edition to camera clubs all over Britain.² Without its publication, dissemination and discussion, the Pictorialist movement would have been postponed by a decade or more – or perhaps, never have occurred. Stieglitz considered him the man to whom pictorial photography owed the most.³ That is not to say that Emerson originated or created Pictorialism, however; he certainly did not approve of it, as he says in not uncertain phrasing contained in a letter to Stieglitz: “You will I feel one day agree with me that you have banked[?] your talents on a *Strumpet!* — i.e., pictorial photography.”⁴ A sound assessment is to say that *Naturalistic Photography* enabled the formation of Pictorialism (discussed further in Chapter Four).

First, Emerson’s sources and methods must be understood. It is intriguing that for the number of books and journal articles which have cited or concerned Emerson over the last 100+ years, how few have critically examined his writings. He has been variously construed as the patron saint of the f/64 school (see Nancy Newhall below, who used her biography of Emerson chiefly as a platform to praise and promote Stieglitz and the later f/64 Group) or, more often, the founder of Pictorialism, both of which are far from the mark. Except for Marien⁵ and to a much lesser extent, Rosenblum,⁶ there has been little consideration of either *where* he found his ideas on photography or *how*, through the lens of various theories, he processed and amalgamated them. Instead, most writers have

² Beaumont Newhall, *The History of Photography* revised edition, (New York: The Museum of Modern Art, 1964) p. 97.

³ Alfred Stieglitz, “Pictorial Photography” *Scribners Magazine* 26 (Nov. 1899) reprinted in *Alfred Stieglitz, Photographs and Writings*, Sara Greenough and Juan Hamilton (Washington: National Gallery of Art, 1983) p. 185.

⁴ Letter from Emerson to Stieglitz dated 26/11/02, in Nancy Newhall *P. H. Emerson* (Millerton, NY: Aperture, 1975) p. 117.

⁵ Mary Warner Marien “Peter Henry Emerson: The Taxonomy of a Crow’s Nest” *History of Photography* (Vol. 21, No. 2, Summer, 1997) pp. 102-109.

⁶ Naomi Rosenblum *A World History of Photography* (New York: Abbeville, 1984) pp. various.

concentrated on critical art-historical analyses of his images and writings.⁷ Furthermore, no one has attempted to objectively evaluate many of his key technical concepts in the light of whether they are correct or erroneous. Both his input and his output must be considered before any accurate summation of his influence can be achieved.

Marien describes him as “an intellectual grazer,” who “practiced appropriation; in scholarly terms, he verged on plagiarism.”⁸ It is the contention of this chapter that his contradictions and inconsistencies which plague certain portions of Naturalistic Photography are the consequences of his inability to synthesize and reconcile contradictory ideas that were appropriated without adequate intellectual resource.

A decade later, another doctor and major Pictorialist photographer, Carl Christian Heinrich Kühn (German 1866-1944), like Emerson, will also base his arguments on the physiology and psychology of human vision but will reach substantially different conclusions regarding focus; more will be said about Kühn’s contributions in subsequent chapters.

Influences & Sources

There were three categories of Emerson’s sources: those that he readily acknowledged, such as Helmholtz, those he begrudgingly acknowledged, e.g., Roland Rood, and those he refused to acknowledge or denied, e.g., Francis Bate. It is likely that educated persons of his time would have more readily deduced his influences than we can from 120 years removed.

⁷ For instance, the various articles in *Life and Landscape: P. H. Emerson, Art & Photography in East Anglia 1885-1900* and the three relevant chapters in *British Photography in the Nineteenth Century, the Fine Art Tradition*.

⁸ Marien Summer, 1997, p. 107.

Emerson was heavily influenced by the researches and publications of Hermann Ludwig Ferdinand von Helmholtz, best known for the Young-Helmholtz trichromatic theory of color vision which hypothesized there were separate receptors in the eye for red, green and blue.⁹ In the discipline of ophthalmology his inventions of the ophthalmoscope to see into the eye and the ophthalmometer to measure how the eye focuses, are still in use. A German polymath, optics was only one small area of his wide ranging interest.

The ophthalmoscope allowed Helmholtz to see through the cornea into the human eye. By its aid he studied the eye in a depth that had never been equaled. In 1867 his 874 page *magnum opus*, *Handbuch der Physiologischen Optics* (Liepzig: Voss) was published and is still cited today. He also published more ‘popular’ books as well, including *Popular Lectures on Scientific Subjects* (London: Longmans, 1873, 2nd ed.1881). The former deals with aberrations of the eye; the latter includes the chapter, “On the Relation of Optics to Painting.” It is tempting to consider that Emerson read *Handbuch der Physiologischen Optics* whilst studying medicine at King’s College, (M.R.C.S. 1879), and that he read *Popular Lectures on Scientific Subjects* in 1881 whilst studying for his M.B. at Cambridge (1881-85). It is equally possible that his attention was first drawn to Helmholtz by a book in wider circulation, *Modern Chromatics*, printed in 1879 with a second edition in 1883 (it went to a third edition in 1890). The ninth chapter is entitled “The Colour Theory of Young and Helmholtz” and gives the topic a most thorough discussion.¹⁰

⁹ W. H. A. Fincham and M. H. Freeman, *Optics*, 8th ed. (London: Butterworths, 1976) p. 274.

¹⁰ Ogden N. Rood *Modern Chromatics: Students' Text Book of Color with Applications To Art and Industry* (1879) reprinted (New York: Van Nostrand Reinhold, 1967). Ogden Rood was the father of Roland Rood, an art critic whose writings appear in *Camera Work*.

Marien has proven that Emerson did not always consult the original text when quoting from it, noting that in the case of Huxley, “Emerson does not quote from Huxley’s address, but chose instead to lift Huxley’s ideas from an obscure science primer.”¹¹ Hence, his own understanding was often superficial or might even be erroneous, given his failures to read the source material. This reinforces the view of Emerson as a pseudo-scientist, compared to the role he attributes to himself as a doctor and trained scientist (especially when criticizing other writers). *Handbuch der Physiological Optics* was not available in an English translation until 1924, adding to doubts regarding Emerson having read it at King’s College.

Emerson also mentions Ogden Rood’s book as a source in “The Death of Naturalistic Photography” but not in the original 1889 text.¹² Due to criticisms of the first edition, he appears to have been more thorough in later editions regarding sources.

Emerson sought to create an artistic photograph by emulating natural law; to deduce the rules of nature, he drew upon science “The best artists have always tried to interpret nature, and express by their art an impression of nature as nearly as possible similar to that made on the retina of the human eye, it will be well to inquire on scientific grounds what the normal human eye really does see.”¹³ Although he sought to free photography from “scientific realism,” he nonetheless drew on science to establish and justify his precepts; “All good art has its scientific basis.”¹⁴ Helmholtz is certainly not his only scientific reference point but is the key source for Emerson’s crucial theories on vision. As to the veracity of Emerson’s interpretations, that is beyond the scope of this

¹¹ Marien Summer, 1997, p. 106.

¹² P. H. Emerson “Death of Naturalistic Photography “ (1891) in *Naturalistic Photography* 3rd ed. 1899, reprinted (New York: Arno Press, 1973), unpaginated fifth page.

¹³ Emerson 1899, p. 97,

¹⁴ Emerson 1899, p. 120.

thesis; they are important, regardless, because of their influence on the art of photography and the general discussion they stirred regarding the role(s) of photography.

Emerson's collaborator in some of his canal adventures and portfolio productions was landscape painter Thomas Frederick Goodall (England 1857-1944). Goodall and Emerson met in the summer of 1885, before any known Emerson statements on focusing are known, nearly at the outset of his interest in photography. It could be suggested that Emerson's introduction and perhaps master class in 'naturalism' were from the uncredited Goodall.

Goodall was then a member of the New English Arts Club, whose members included Sir George Clausen (1852-1944), Henry Herbert La Thangue (1859-1929) and John Singer Sargent (1856-1925). La Thangue had studied in Paris during the 1880s when the paintings of Millet and his followers were the subject of much attention. Sargent was a confidant of Claude Monet and he was highly influenced by French Impressionism, of course. Both La Thangue and Sargent knew the work of Jules Bastien-Lepage (1848-1884), the most influential French artist in Britain in the 1880s.¹⁵ Bastien-Lepage's *Les Foins* was exhibited in London in 1880. Described as "Impressionist in the background, but calling for greater naturalism in the foreground and figure,"¹⁶ this painting may have been seen by Goodall. This description of Bastien-Lepage's technique sounds like a page from *Naturalistic Photography*. Indeed, Emerson credits Bastien-Lepage as one of the "pioneers who established the naturalistic trend."¹⁷

¹⁵ Kenneth McConkey, *British Impressionism* (London: Phaidon Press Limited, 1989) p. 156.

¹⁶ McConkey 1989, p. 28.

¹⁷ Kenneth McConkey, "Dr. Emerson and the Sentiment of Nature" in *Life and Landscape: P. H. Emerson, art and photography in East Anglia 1885-1900* (Norwich: Salisbury Centre for Visual Arts, 1986) p. 49.

When Emerson first met Goodall in 1885, La Thangue was with Goodall. These painters had already discovered the aesthetic potential of the Broads. Soon La Thangue moved to Norfolk in the late 1880s.¹⁸ La Thangue's painting, *The Hedger* (1888), with its well formed figure against a most indistinct background forms an image almost precisely conforming to Emerson's dicta. McConkey believes that Emerson could have met a number of young painters at Southwold as well.

Figure 3.1 : Henry Herbert La Thangue *An Autumn Morning* 1897. This treatment is the painterly analog to Emerson's differential focus. The main subject is sharp throughout but the background visual confusion is such that the male figure nearly vanishes. The effect in the lower half background is very similar to astigmatism in a lens (Kenneth McConkey *British Impressionism* plate 11).

¹⁸ McConkey 1986, p. 44.

Emerson knew Clausen personally- he had bought one of his paintings in 1886¹⁹ and corresponded with him.²⁰ This is hardly surprising given that Clausen was J. Havard Thomas' fellow student in the South Kensington Training Schools (now the Royal College of Art).²¹ Letters from Emerson to Thomas beginning in 1888 (post-Goodall contact) show that Emerson "was in favour of the progressive rustic naturalists like Clausen and La Thangue..."²² Thomas was a close friend of Emerson's and they exchanged ideas in person as well.²³

Figure 3.2: Sir George Clausen *Hoeing Turnips* 1884. Clausen's figures and arrangements are noticeably less obviously posed than Emerson's photographs (Kenneth McConkey *British Impressionism* plate 16).

¹⁹ Mc Conkey 1986, p. 48

²⁰ Letters from Clausen to PHE, in *Life and Landscape: P. H. Emerson, art and photography in East Anglia 1885-1900* (Norwich: Salisbury Centre for Visual Arts, 1986) pp. 8-10.

²¹ Fiona Pearson, "The Correspondence Between P. H. Emerson and J. Havard Thomas" in *British Photography in the Nineteenth Century*, Mike Weaver, ed. (Cambridge: Cambridge University Press, 1989) p. 197. Thomas was one of Emerson's few long term friends.

²² McConkey 1986, p. 56.

²³ Emerson 1899, p. 80.

Thus it is obvious that much of Emerson's critical thinking about subject matter, treatment and 'differential focus' originated with his contacts with contemporary painters, some in his immediate geographic locale. He was clearly sensitive to this possibility when in the Third Edition (1899) he specifically states that "Suggestions have been made that I get some of my ideas from a book, called 'Naturalistic Painting.' I have a letter in my possession from an artist wherein is stated clearly and exactly that Mr. Bate has read a paper of mine on *Naturalistic Photography* before his first article appeared in the 'Artist.'²⁴ Painter, teacher and author Francis Bate (1853-1950) wrote *The Naturalistic School of Painting*²⁵ and this may be the source of George Davison noting at the time (*BJP* January 30, 1891) that Emerson "merely adapted to photographic methods ideas current amongst certain artists." As noted in Chapter Two, Davison credits his own source of influence as Bate. According to Nancy Newhall, Bate was serialized in *The Artist* beginning March 1, 1886;²⁶ Emerson immediately protested that his ideas were his own. Robinson also wrote in 1889 that Bate "was the source of much that is written on the subject, and the principle is *illustrated* [emphasis mine] by example by Dr. Emerson."²⁷

Perhaps the prime question left to be resolved regarding the painters' influences is the extent of the role of Thomas Goodall in introducing and elaborating the concept to Emerson. It is probable that Goodall's views in their cooperative publication, *Notes on Perspective Drawing and Vision* in 1891 constituted the main contribution despite Emerson's listing as first author. Beyond that, it is impossible to determine how much of

²⁴ Emerson 1899, unpaginated.

²⁵ Francis Bate *The Naturalistic School of Painting* (London: The Artist, 1887 2nd ed)

²⁶ Nancy Newhall 1975, p. 94.

²⁷ H. P. Robinson from *The Amateur Photographer* quoted in Nancy Newhall *P. H. Emerson* (Millerton NY:Aperture, 1975) p. 65

Emerson's text is Goodall's thoughts. Goodall was a career painter; Emerson was a career dilettante.

Emerson may have had at least one uncredited photographic influence as well: Frank Meadow Sutcliffe (1853-1941). Margaret Harker observed that "many of his photographs reveal that he used differential focusing well in advance of Emerson's pronouncement on Naturalistic photography in 1886."²⁸ Sutcliffe was well known for his 'naturalistic' views of Whitby and its denizens by the time Emerson wrote *Naturalistic Photography*. Emerson may have used Sutcliffe's documentation of Whitby as a model for his own documentation of the Fens. This needs to be investigated further to determine if a definite link can be established. He certainly was aware of, and approved of Sutcliffe's work.²⁹

²⁸ Harker 1979, p. 162.

²⁹ Emerson's evaluation as a "complete triumph of naturalism" appeared in *Photographic Times*, Feb. 13, 1891, p. 491, cited in Anne Hammond, "Naturalistic Vision and Symbolist Image" Michael Frizot ed. *The New History of Photography* (Köln: Könemann, 1998) p. 295.

Figure 3.3: Frank Meadow Sutcliffe *Fetching in the Line* date unknown. Sutcliffe clearly used whatever depth of field seemed appropriate to the image and was not dogmatic as was Emerson. This is a fine example of his use of very shallow depth of field, also known as ‘differential focus.’ (Michael J. Shaw *Every Now and Then* p. 23)

Naturalistic Focus

This discussion considers only the first edition of *Naturalistic Photography for Students of the Art* as it was the one which launched the new movement and was most influential. The third edition, printed a decade later, is not consulted unless it illuminates statements in the first edition (Emerson removed from sale the second edition when he recanted his theories); by the time the last edition was printed, the movement had matured and to a great extent had already been modified into proto-Pictorialism.

Emerson's vitriolic retraction had no effect whatsoever; "... the thoughts which the book had stirred were not to be stilled by its withdrawal."³⁰

Emerson attacked the principles and person of H. P. Robinson mercilessly. Like Davison, Emerson had to disprove the dominant paradigm before proceeding with proving the worth of his own theories. Davison's approach to Robinson was, as has been stated previously, largely based on the aesthetics of montaged images. Emerson's conflict with Robinson is essentially an issue of syntax. Robinson had sought to overcome the problems associated with the insensitivity of the wet-plate in the studio by multiple images pasted together; by contrast, Emerson learned photography after the dry plate became dominant and photographed exclusively in the outdoors. He understood little of the issues which had confronted Robinson when he wrote *Pictorial Photography* in 1869. It is ironic that when Emerson charges those he dislikes (Davison, for instance) as being ill-qualified to speak because they had not studied art, he did not realize that Robinson could have made a well-founded case for the same with him. Robinson built his theories on well-accepted principles of painters, especially composition and refinement, two issues largely skirted by Emerson. In the thirty years which elapsed between the first edition of *Pictorial Photography* and that of *Naturalistic Photography*, tastes had changed from the 'picturesque' (a term more correct for Robinson's aesthetic) to an art world framed by the revolution of Whistler and the Impressionists. For all of his modern posturing, Emerson was behind the times as well.

Emerson's focus theory is complex and difficult to fully comprehend. It "*is not* merely a photograph with one plane sharp and the rest fuzzy, as asserted by the

³⁰ Hinton 1911, p. 522.

muddle-headed idiot”³¹ (and as asserted by Gernsheim,³² Hammond,³³ Haworth-Booth,³⁴ Rice,³⁵ Sternberger³⁶ *et al*), nor was it simply “soft focus” as Newhall stated.³⁷ In fact, some of his photographs are totally out of focus; “the whole picture here is *out of focus*, deliberately thrown out of focus.”³⁸ Emerson’s own appraisal of the focus issue was “that true focus is but one point amongst many desiderata for a perfect naturalistic photograph, and that not the most vital point by any means.”³⁹ Nonetheless, contemporary photohistorians have fixated on this one element of Emerson’s philosophy, perhaps because it is simpler than delving into the depths of his writings and grappling with apparent inconsistencies to resolve them in the manner that an 1889 photographer would have been required to perform. It is important to resolve at least some of the key declarations here in order to understand Emerson’s vicious attacks on Davison, and to contrast them to the use of the soft-focus lens, which will become a major tool and visual signature of Pictorialist artists.

What follows are some of Emerson’s key points, both positive and negative which effect focus; a short critique follows each category.

³¹ P. H. Emerson “What is a Naturalistic Photograph?” *The American Annual of Photography and Photographic Times Almanac* (New York: Scovill & Adams Company, 1895) p. 122.

³² Helmut Gernsheim, *Creative Photography* (New York: Bonanza Books, 1962) p. 119.

³³ Anne Kelsey Hammond, “Aspects of the Photomechanical Print” *British Photography in the Nineteenth Century*, Mike Weaver, ed., (Cambridge: Cambridge University Press, 1989), p. 175.

³⁴ Mark Haworth-Booth, *Photography: An Independent Art* (Princeton: Princeton University Press, 1997) p. 93.

³⁵ Shelley Rice, “Parallel Universes” *Pictorial Effect, Naturalistic Vision* Ellen Handy editor (Norfolk, VA: The Chrysler Museum, 1994) p. 61.

³⁶ Paul Spencer Sternberger, *Between Amateur and Aesthete* (Albuquerque: University of New Mexico Press, 2001) p. 39

³⁷ Newhall, 1964, p. 99.

³⁸ P. H. Emerson, *To The Student*, frontispiece in *Pictures of East Anglian Life*_Portfolio, May 1890.

³⁹ Emerson May 1890.

Emerson's Positive Actions

“Helmholtz says ‘all other parts of the retinal image beyond that which falls on the central spot are imperfectly seen,’ so that the image which we receive by the eye is like a picture minutely and elaborately finished in the centre, but only roughly sketched at the border.”⁴⁰ Emerson’s own images fail to ever meet this criterion, being either sharp in a single plane or not sharp anywhere. In fact, Cameron’s images meet this dictum quite well. A camera lens must have a fair degree of coma and astigmatism to evince this effect; by Emerson’s time, none were bad enough to be used this way. Circa 1910 a new category of ‘portrait lens’ was developed in America which behaves exactly as Helmholtz describes, yielding a sharp central region falling off rapidly towards the margins; the *Vitax* lens is a good example.

“Again he [Helmholtz] says, ‘Whatever we want to see we look at and see it accurately; what we do not look at, we do not as a rule care for at the moment, and so do not notice how imperfectly we see it.’ Now all this is most important in connection with art, as we shall show later, we must beg the student therefore to hold it fast.”⁴¹ This becomes *the* core issue for the debate on soft focus from Emerson’s time up to the present. Those who advocate soft focus agree with Helmholtz; those who are ‘purists’ contend that the eye moves so much and so often that the entirety of the scene is always interpreted as being sharp. This argument does not affect those who follow Whistler’s “art for art’s sake” but only those who cling to the “naturalistic school.”

“Experience has shown, that it is always necessary to throw the principal object slightly (often only just perceptibly) out of focus, to obtain a natural appearance, except

⁴⁰ Emerson 1889, p. 101-102.

⁴¹ Emerson 1889, p. 102.

when there is much moisture in the air, as on a heavy mist-laden grey day, when we have found that the principal object (out of doors) may be focussed *quite sharply*, and yet appear natural, for the mist scattering the light softens the contours of all objects. Nothing in nature has a hard outline, but everything is seen against something else, and its outlines fade gently into that something else, often so subtly [sic] that you cannot quite distinguish where one ends and the other begins. In this mingled decision and indecision, this lost and found, lies all the charm and mystery of nature. This is what the artist seeks, and what the photographer, as a rule, strenuously avoids.”⁴² In other words, Emerson strives to make all scenes conform to one seen on a misty day; if it is not misty and atmospheric, he contends that moving it out of focus will simulate the effect. This precludes any photography on bright sunny days, of course, unless he can make them *appear* as if a misty day. Should that be the case, he then violates his own concept of “truth in nature” by altering the true appearance, especially by lowering the tones.

From the First Edition: “it should be made just *as sharp as the eye sees it and no sharper*, for it must be remembered the eye does not see things as sharply as the photographic lens, for the eye has faults due to dispersion, spherical aberration, astigmatism, aerial turbidity, blind spot, and beyond twenty feet it does not adjust perfectly for different planes.”⁴³

From the Third Edition: “the principal object in the picture must be fairly sharp, *just as sharp as the eyes see it, and no sharper*; but everything else, and all other planes of the picture, must be subdued, so that the resulting print shall give an impression to the

⁴² Emerson 1889, p. 150.

⁴³ Emerson 1889, p. 119.

eye as nearly identical as possible to the impression given by the natural scene.⁴⁴ Heavily re-written for the third edition, this may reflect his desire to deflect future criticism by removing specific causes of softness. As critical as he is of using spherical aberration to form a diffused image, it seems particularly politic to remove any mention of that defect in the human eye.

“The rule in focussing, therefore, should be, focus for the principal object of the picture, but all else must not be sharp; and even that principal object must not be as perfectly sharp as the optical lens will make it.”⁴⁵

“Thus, then, in taking a photograph we must remember that theoretically speaking, up to twenty feet the picture can be made sharper all over than beyond that distance; for the eye has all these perspectives acting within that distance.”⁴⁶ Again, he presumes a high saturation of particulate in the air to degrade the resolution and tone. His use of isochromatic film (sensitive to blue and ultraviolet only) would already exaggerate the degree of haze in the air compared to the panchromatic human eye.

“What is the best lens for artistic purposes? That lens is *Dallmeyer's new long-focus rectilinear landscape lens*. This summer [1888] we used one of these lenses and were delighted with it” “and with open aperture the outlines of the image are softly rendered and in addition, the values seem to us to be more truly rendered by it.”⁴⁷ This is *not* the rapid rectilinear as used by Cameron and Robinson but an entirely different design granted a UK provisional patent in 1888. This is a rare lens today and there is controversy over the precise design although it is certain that three glass elements were

⁴⁴ Emerson 1899, p. 72.

⁴⁵ Emerson 1889, p. 119.

⁴⁶ Emerson 1889, p. 113.

⁴⁷ Emerson 1889, p. 135-136.

used rather than the RR's four. It possessed a maximum aperture of f/14 making it useless except in the outdoors.⁴⁸ Dallmeyer made other lenses at this time (and earlier) with much faster apertures (f/3 for example). If Emerson had wanted fine control the plane of focus by controlling the lens aperture setting, it would have made more sense to use a faster lens with a shallower depth of field, even a standard Rapid Rectilinear operated at f/8; some available Dallmeyer lenses were as fast as f/3. Certainly expense was not a prohibition to acquisition for Emerson. Before the advent of lens coatings to reduce reflections inside the lens causing flare, the three-element lens should possess noticeably higher contrast than four -element lenses of his familiarity; that would contravene his desire for a relatively flat rendition of a scene, however.

In the third edition, Emerson names the Dallmeyer D Rapid Rectilinear as the desirable lens to use.⁴⁹ This is a dramatically different lens from the Dallmeyer recommended in the First Edition. Properly named as "Rapid Rectilinear Portrait & Group Type D," it was a very fast lens for the time with a maximum aperture of f/4.⁵⁰ This lens would conform to the criticisms stated above and allow very fine control of depth of field, especially in the longer focal lengths (if the f/number is held constant, the depth of field decreases as focal length increases). He also details the use of the new Dallmeyer Telephotographic Lens which he requested Dallmeyer to invent but does not necessarily advocate its purchase by the reader.

⁴⁸ Matthew Wilkinson and Dr. Alex Neill Wright *A Lens Collector's Vademecum* (CD) 2nd ed 1999, entry for "1887 Rectilinear Landscape."

⁴⁹ Emerson 1899, p. 54.

⁵⁰ Wilkinson and Wright 1999, entry for "Rapid Rectilinear Portrait & Group Type D."

Emerson's Negative Actions

Not soft focus: "This equally diffused softness, although preferable to 'sharpness,' is a meretricious device, as I recently pointed out, and not in accordance with nature."⁵¹

Here Emerson is referring to Julia Margaret Cameron but this can be generalized as seen by other pronouncements (below).

"The naturalistic method of focusing [has]...no connection with a general *soft sharpness* such as that produced by Mrs. Cameron's badly-corrected 'Jamin lens,' or by pin-holes, or by throwing the *whole* of the picture out of focus- practices all inferior from the naturalistic standpoint... to my focusing method- which is a deliberate and conscious act to be modified according to circumstances."⁵² Nonetheless, as already noted, he did occasionally throw the entire image out of focus.

Not a gum print: "We are hard bound by the mechanical conditions of our craft, and if these workers require that 'perfect freedom' which they are always crying for, let them become artists and adopt media where there *is* perfect freedom, and leave us poor photographers alone."⁵³ Is this a smokescreen for another agenda? In Emerson's advocacy of platinum printing it is not clear if he has ever attempted any other method or if the platinotype represented the entire breadth of his experience. Since "Platinum is by far the easiest photographic printing process, so far as technique is concerned,"⁵⁴ might it be considered that he was incompetent in other methods which required greater craft? Frederick Evans was candid enough to admit his methods, including platinum printing,

⁵¹ Emerson October, 1890,, p. 39.

⁵² Emerson 1899, p.171.

⁵³ Dr. P. H. Emerson, "Bubbles" *Photograms of the Year, 1900* (London: Illiffe & Sons, 1900) pp. 35-36.

⁵⁴ Paul Anderson "Special Printing Processes" in Keith Henney and Beverly Dudley eds *Handbook of Photography* (New York: Whittlesey House, 1939) p. 479.

were used because they were the easiest; he also admitted that gum printing was quite beyond him.⁵⁵

Not a pinhole: “But such a 'pinhole' photograph is absolutely ruined by lack of tone, and since the exposures required to produce pictures without lenses very roughly from one to thirty minutes, this method cannot be seriously considered here... Indeed, we have never seen anything done by a pinhole that could not be better or as well done by a lens, and the best things we have seen could never have been done by a 'pinhole.’”⁵⁶ The phrasing raises the question as to whether this is more a slur on Davison than a statement of Emerson’s aesthetic beliefs. Both Davison and Alfred Maskell made excellent photographs of people using pinholes so the length of exposure was clearly not a defining issue.

“The answer is that some very fair pictures have been taken without a lens, but since our wish as producers of pictures is to give as true an appearance of nature as possible, we must make use of lenses, because a pin-hole is not sufficiently flexible to meet our needs... we get flatness, and modelling is always ruined.”⁵⁷ It is difficult to ascertain precisely what Emerson sees as a fault here. If he is using “flatness” to describe bad perspective, it is remediable since perspective is solely a function of focal length — simply use a shorter or longer effective focal length pinhole and the perspective will change as desired. If by “flatness” he means low contrast, more time in the developer will raise the contrast to whatever level is required; he illustrates this in a chart.⁵⁸

⁵⁵ Frederick Evans *The Photographic Journal* April 30, 1900, in Newhall *Photography: Essays and Images* p. 179.

⁵⁶ Emerson 1899, p. 14.

⁵⁷ Emerson 1899, p. 20.

⁵⁸ Emerson 1899, p. 100.

Not soft focus by any means: “Mr. Davison has done some interesting experiments in this direction, but we are certain that the pinhole camera is of no practical use; whatever can be done with it, can be better done by employing a lens with positive spherical aberration which has every advantage artistically considered, but it is undesirable. With Dallmeyer's original portrait lens, the quality can be introduced at will, by unscrewing the back combination; in our opinion, not a *desideratum*.”⁵⁹

“One of the effects of my throwing the principal object slightly out of focus, on some occasions, is to obtain a truer tonality. Spherical aberration of course affects the tone of the resulting image. It lowers it throughout and indiscriminately, and is, therefore, inartistic.”⁶⁰ One of Emerson’s deductions is correct, “the effect [of spherical aberration] is to diffuse and reduce the contrast of the fine detail in the image as the highlights spreads into the shadows.”⁶¹ An out-of-focus image caused by differential focus also lowers the contrast, however; this is the operating principle of some auto-focus camera lenses today. He may be splitting hairs by contending that the tonality of the part of the subject in focus is correctly rendered (although he says here “the principal subject slightly out of focus); in any case, the out of focus areas are reduced. Like many other of Emerson’s declarations, this one is difficult to reconcile with fact. He repeats it often in various guises and it is one of his central arguments for having the subject not in best focus.

“But, at the same time, it must be distinctly understood that the so-called ‘fuzziness’ must not be carried to the length of *destroying the structure* of any object, otherwise it becomes noticeable, and by attracting the eye detracts from the general

⁵⁹ Emerson, as 22, pp. 41-42.

⁶⁰ Emerson as 22, p. 53.

⁶¹ *Kodak Professional Portrait Techniques* (Rochester: Eastman Kodak, 1980) p. 10.

harmony, and is then just as harmful as excessive sharpness would be.”⁶² A statement of this nature is often repeated by practitioners of soft focus over the next thirty or more years; likewise by their critics. It is so subjective that the precise meaning resides with the author and in that circumstance exclusively. The evasive nature allows it to be used for or against almost any degree of diffusion.

“Sharp focusing, too, by making objects tell relatively too strongly, throws them out of tone, and so ruins the picture.”⁶³ Heinrich Kühn, writing in 1928 agreed with this, saying that the corrected lens “gives an unnatural contrast of unpleasantly sharp parts of the picture on one hand and a certain fogginess on the other, which runs counter to artistic feeling.”⁶⁴ This was in part a technological issue based on the exposure latitude of film (which for both men meant glass plates). One of the great advances in film between the writings of Emerson and Kühn was the increase of tonal scale which could be captured; this has continued to be improved up to the present and is a very significant difference between 1928 and currently. Additionally, the use of lens coatings to reduce flare, better anti-halation backing for film and the use of panchromatic films (Emerson advocated isochromatic film) all change the variables involved in the tonal range possible to capture on film. There are also subtle differences between film on glass plates and film on flexible carrier bases.

“When sharpness is obtained by stopping down, the diaphragm cuts off light and injures normal brilliancy, flattens the modelling, cuts off useful aberrations, exaggerates

⁶² Emerson as 22, p. 72

⁶³ Emerson, as 22, p. 76

⁶⁴ Heinrich Kühn “On Soft Focus Objectives” *The German Annual of Photography 1928-29* (Berlin: Robert & Bruno Schultz, 1928?) unpaginated.

shadows and so throws the picture out of tone.”⁶⁵ Although the diaphragm does reduce light intensity and reduces spherical aberration, the “normal brilliancy” is retained simply by compensating with longer exposure time. It would deepen the shadows if and only if there was not the compensation of a longer exposure. This should have been obvious as the principle is one of the most basic in photography. This is probably one of the areas where Emerson was so dismayed by the researches of Hurter and Driffield.

Summary of Emerson’s Other Guidelines

When *Naturalistic Photography* is carefully mined for its key points, focus is but one of a number of elements. A summary of his key points is listed below; many do not address focus or issues that will lead on to the soft-focus lens but form the basis for ‘naturalism’ to smoothly transition into ‘pictorialism.’ Even a cursory examination of the 1895-1910 period will demonstrate how many of the major figures adhered to at least some salient points of Emerson’s dictums —and point to his influence for two decades after his first edition was printed.

All of these together form Emerson’s ‘naturalistic’ philosophy and none was meant to be taken by itself or without the many layers of further expansion in the text. The first edition is cited unless the third edition states the issue more clearly or Emerson has modified his views.

1. The entire purpose is to “give the student a clear insight into the first principles of art” which taken together form ‘naturalism.’ (1st, p. 9)
2. “...work can always be referred to a standard - Nature.” (1st, p. 22)
3. Some painting, sculpture, woodblock, etching & engraving is worth studying.

⁶⁵ Emerson, as 22, p. 76-77.

4. The best artists have created “an impression of nature as nearly as possible similar to that made on the retina of the human eye.” (1st, p. 97)
5. Therefore, focus “should be made just *as sharp as the eye sees it and no sharper...*” (3rd, p. 72)
6. All prints are made by contact, not enlargement.
7. Low tones, that is, the grays and black, are preferable to a full tonal range with bright whites (3rd, p. 136)
8. Platinum paper is far superior to silver-based papers for low toned subjects. (3rd, p. 136)
9. Use of only long focal length lenses, at least twice the length of the long side of the negative (3rd, p. 33)
10. Any size of negative can produce art; cropping is allowed. (3rd, p. 8-9)
11. Prints may be toned, especially red and sepia. (1st, p. 195)

.It is exceedingly difficult to reconcile these dictums with Nancy Newhall’s assertion that the Group f.64 were “‘Purists’ - photographers pure to the bone and true to Emerson's teachings in everything but focus.”⁶⁶

Emerson was the first high profile advocate of the relatively new platinotype. The “ordinary silver printing-paper is undesirable, for it exaggerates the darkness of the shadows, a fatal error.”⁶⁷ In reality, both silver-based papers and platinum shared the characteristic of poor black tone separation; the silver paper achieved a blacker tone, however.⁶⁸ This dictum of Emerson’s may relate to his calling for the use of ‘thin’ negatives, meaning there is little detail in the shadows to be printed. Normally a photographer will add exposure to the negative in order to provide adequate shadow detail. His working methods “meant printing the shadows light, and it also must have meant being careful not to overdevelop the negative. Emerson's prints thus tend to be flat, the shadows showing comparatively little separation of tones.”⁶⁹ Further, the platinotype paper was a dead-matt surface, which “automatically compresses shadow tones (unlike a

⁶⁶ Nancy Newhall 1975, p. 135.

⁶⁷ Emerson 1889, p. 116

⁶⁸ Dick Arentz *Platinum & Palladium Printing* (Boston: Focal Press, 2000) p. 99.

⁶⁹ Crawford 1978, p. 82.

glossy surface, which extends them), but the paper can give considerably more contrast and separation than Emerson advocated.”⁷⁰

Emerson utilized only a small portion of the tonality which could be achieved by a platinotype. In particular, he did little to exploit the “great subtlety in the rendition of whites” of which platinum was capable of capturing.⁷¹ In order to keep his prints low and subdued, he has minimized the lighter tones both by excluding them from the composition as well as by minimal development which reduces the brilliance of the lighter tones. In many of his prints, only the sky is a white or near white, and given his use of isochromatic film, that was unavoidable unless photography was limited to heavily overcast days.

Summary

A key error of Emerson’s was to still tie art to scientific principles and not be free to simply produce beauty; as much as he admired Whistler, this was a Whistlerian concept he could not reconcile. On the contrary, Whistler directly refuted his most basic assertion, that Nature was the basis for art. “That Nature is always right, is an assertion, artistically, as untrue, as it is one whose truth is universally taken for granted - Nature is very rarely right, to such an extent even, that it might almost be said that Nature is usually wrong - that is to say - the condition of things that shall bring about the perfection of harmony worthy a picture, is rare, and not common at all.”⁷² How could Emerson ever reconcile this with his philosophy? For him, there was an objective truth whereas

⁷⁰ Crawford 1979, p. 99.

⁷¹ Arentz 2000, p. 99.

⁷² James M. Whistler “Ten O’clock Lecture” 1885 from the Whistler Centre Archives, University of Glasgow.

Whistler and Davison believed in a personal expression. It was a head-on collision of science and the human need for personal expression. His painter-friend Clausen had warned him “don’t try to make art scientific” to no avail.⁷³

Emerson’s theory was exclusively tied to the landscape, believing that all art was tied to nature with a capital “N.”. When criticizing portraits by Demachy, he characterized him as having the “inability to see pictures in nature and no one can be an artist without that.”⁷⁴ This is a classic Emerson inconsistency; Chapter IV of *Naturalistic Photography* was on the studio and its furnishings (although it is a remarkably short chapter, consisting of only four pages, reflecting his near total lack of experience with the subject). For Emerson, art photography exclusively meant the landscape or the figure in the landscape.

His entire photo career spanned a relatively brief period: from the 1886 *Life and Landscape on the Norfolk Broads* to the 1895 *Marsh Leaves*. As if embracing deliberate obscurity, he never allowed a photo to be exhibited or reproduced after 1901. By contrast, Davison’s photographic period extended from 1888 until his final show in 1911 (London’s Newman Gallery), a decade longer than Emerson.

Emerson’s credibility was largely related to his published portfolios, rarified objects not accessible to the ordinary man; Davison, as already noted, was highly visible in the Salons, winning numerous medals. If his production had been overlooked up to that time, “The Onion Field” controversy surely brought his name into almost universal prominence amongst serious amateurs. Additionally, Davison’s participation in forming The Linked Ring almost required his peers to respect his views and images.

⁷³ George Clausen to PHE, 5th July 1891 in *Life and Landscape: P. H. Emerson, art and photography in East Anglia 1885-1900* (Norwich: Salisbury Centre for Visual Arts, 1986) p. 10.

⁷⁴ Letter from PHE to Alfred Stieglitz June 6, 1924, in Nancy Newhall 1975, p. 127

The renunciation by Emerson of his previous stand in 1890/1 was not important in the flow of Pictorialism's development as (1) it did not change *his* style and (2) the revolution had started and this peripheral issue could not derail it. It did, however, probably make photographers skeptical of his words if he did not follow them himself. Emerson had lost the argument to himself (a unique situation in photographic philosophy) and to Davison as well, both in a very public way. His vituperative letters isolated him from public opinion; Davison emerged as the 'common man' with an uncommon talent.

Ostensibly concerned with 'naturalism' many of Emerson's figures nonetheless appear posed and often wooden. His prints are dull and dreary compared to New English Art Club paintings which were his influences and model. He seems to have studiously avoided days with direct sunlight, so concerned as he was with 'atmosphere' as a ruling principle whereas the 'naturalist' English painters are quite concerned with the various aspects of light, although often diffuse light, it did not seem to create a low contrast, muddy painting.

Many of his prints have excellent depth of field and no principle of differential focusing is evident. The matte surface of the platinotype and the paper chosen for the gravures also lowers the resolution and tone across the image, similar in effect to the soft focus lens — an effect Emerson soundly disapproved of in his pronouncements.

English photohistorian Margaret Harker summarizes Emerson thusly: "Neither were his pronouncements on theories of photographic art always sound or commensurate with his practice of the medium. What was worse, he was egocentric and 'vain almost beyond

endurance.’’⁷⁵ The latter characteristics, which almost anyone would have applied to Emerson, are part of the constellation of attributes of Asperger’s syndrome.

First described by Austrian pediatrician Hans Asperger in 1944, Asperger’s Syndrome is sometimes described as high-functioning autism. Although the diagnosis of Asperger’s disorder is fraught with difficulty even with a living person, it would be even more so with one long deceased. However, I would be remiss in not raising the possibility that Emerson suffered from this autistic-like syndrome. Gillberg⁷⁶ lists a set of criteria for Asperger’s which includes:

1. lack of appreciation of social cues, socially and emotionally inappropriate behavior;
2. all-absorbing narrow interest, more rote than meaning;
3. imposition of routines and interests on self;
4. formal, pedantic language.

The person affected can “manifest extremely sophisticated reasoning, an almost obsessive focus, and a remarkably good memory for trivial facts,”⁷⁷ an accurate description of Emerson. Nancy Newhall characterizes his letters as “among the hardest-to-transcribe letters in English” because of his scrawl;⁷⁸ Another Asperger characteristic is illegibility in hand-writing. Obviously it cannot be stated with certainty, but circumstantial evidence points to the possibility that he was afflicted by Asperger’s Syndrome, which would serve to explain many of his behaviors.

⁷⁵ Harker 1979, p.66

⁷⁶ Gillberg, I.C. and Gillberg, C. “Asperger Syndrome- Some Epidemiological Considerations: a Research Note” *Journal of Child Psychology and Psychiatry* June 30, 1989 pp. 631-638.

⁷⁷ www.en.wikipedia.org/wiki/Asperger_syndrome

⁷⁸ Nancy Newhall 1975, p. 113.

Chapter Four: Development of the Soft Focus Lens

It is incontestable that within the last few years the current of feeling in the artistic world of photography has been steadily inclined towards the production of pictures in diffused rather than in concentrated and minute focus.¹

Alfred Maskell (1890)

Although much of the impetus towards a diffused image had been driven by the pinhole (substituted for a lens), its application was very quickly optimized and there was no further development possible in the pinhole itself. As time passed, the syntax of photography would change, especially the sensitivity of film, such that the pinhole would become more practical, but there were very few aesthetic avenues not already explored by the mid-1890s. Pinholes offered certain advantages including cost, some degree of control over the amount of diffusion and variety of focal lengths; the chief complaint, “excessive slowness”² simply could not be changed as extremely small apertures were the defining trait of a pinhole. The future of photographic diffusion would come from innovative lens designs, not pinholes.

There is a discrete number of benchmarks, or defining events, in the evolution of the diffused image aesthetic that includes: (1) commercial availability of platinum printing paper (Britain, 1879), (2) George Davison’s exhibition of a photograph made with a pinhole (Britain, 1889), (3) Hans Watzek’s use of the simple meniscus lens (Austria, 1891+), (4) perfection of the gum bichromate printing process (France, 1894+), (5) invention and marketing of the first modern soft focus lens, the Dallmeyer-Bergheim

¹ Alfred Maskell “Artistic Focus and the Suppression of the Lens” *Photographic Quarterly* Vol. II, No. 5, October 1890 p. 18.

² Alvin Langdon Coburn “The Question of Diffusion” *Semi-Achromatic Lenses* a brochure (Boston: Pinkham & Smith, undated c. 1912) unpaginated.

(Britain, 1893) and (6) the migration of the soft focus lens from England to America, via F. Holland Day and his cousin, Alvin Langdon Coburn (USA, 1901).

One of the earliest detailed discussions of a simple (i.e., one piece of glass) lens for serious photography was by J. Traill Taylor in 1864, as a second part to his earlier article on portrait lenses.³ Herein he explored in great detail the applications of a single lens. He concludes that the convex or flat surface should face the subject, and that the meniscus is the best general form. Importantly, he states that the spherical aberration is controlled by the diaphragm; by removing the aperture, “all is haze and confusion.”⁴ He expressed, unintentionally, how to construct a basic soft-focus lens.

Art teacher and amateur photographer Hans Watzek (Viennese, b. 20 December 1848 d. 12 May 1903)⁵ was inspired by Alfred Maskell’s (England, b. circa 1857 d. >1910)⁶ work to try the pinhole as a lens substitute⁷ perhaps combining it with a spectacle (meniscus) lens.⁸ Was Maskell aware of Taylor’s article less than thirty years earlier? Both Maskell and Watzek were early Linked Ring members, Maskell being one of the founding Links in 1892, Watzek being admitted in 1893.⁹ Maskell was co-author with Robert Demachy of *Photo-Aquatint or the Gum-Bichromate Process*,¹⁰ one of the key texts of pictorialism, filled as much with philosophy as technique.

³ Taylor April 15, 1864, pp. 134-135.

⁴ Taylor April 15, 1864, p. 134.

⁵ Heinrich Kühn *Zur Photographischen Technik* (Halle Saale: Wilhelm Knapp, 1926) translated by Charles Lewis, p. 45.

⁶ Harker 1979, p. 156. “His professional and private circumstances, his birthplace and death remain in the shadows.”

⁷ F. Matthies-Masuren translated by George Herbert Englehard “Hugo Henneberg-Heinrich Kühn-Hans Watzek” *Camera Work* No. 13, January 1906, p. 23.

⁸ Harker 1979, p. 82.

⁹ Harker 1979, pp. 185, 187.

¹⁰ Alfred Maskell and Robert Demachy *Photo-Aquatint or the Gum-Bichromate Process* (London: Hazell, Watson & Viney, 1890). It went through four editions by 1904.

Thus Watzek began his experiments in diffusion with a pinhole “but found the weak light passage and the perpetual incurable unsharpness far from his liking.”¹¹ As a compromise between pinholes and lenses, Watzek experimented with combining the two. Gradually he made the pinhole aperture larger and larger until only the lens was forming the image. In 1891 he “presented to the Viennese Camera Club, portraits of large heads, taken with the aid only of an ordinary spectacle lens,”¹² the climax of his search for an artistic lens. This was not an optimal solution, however. As Heinrich Kühn (German, 1866-1944) details the method:

Watzek used planoconvex lenses (common spectacle glasses for the far sighted)... and were of a focal length of 30 cm. to 70 and 80 cm. But of course these tiny monacles were of such low relative aperture that they were useless for portrait work, although Watzek managed one wonderful self-portrait in brightest sun, of which only a somewhat tonally poor platinum print survives. Later lenses of larger diameter were chosen, such as 10 cm. diameter, but also only of planoconvex or biconvex form; their field is relatively sharp at the centre but allows the use of only a small angle at $f/10$ to $f/20$. For large size portraits, focal lengths of 70 cm. to one meter and longer, came to be used.¹³

The relative aperture was his problem, admitting too little light for non-stationary subjects. The next step in Watzek’s experimentation then involved large (2 ½ inch diameter) plano-convex lenses of very long focal lengths, up to 39.4 inches. Very few cameras ever built could focus such a long lens at infinity, no less at a normal working distance in the studio. To solve that problem he built a paste-board camera with telescoping boxes.¹⁴ Since these lenses were used at apertures of $f/10$ or more, spherical aberration was fairly well controlled, rather the softening is from chromatic aberration, a

¹¹ Kühn 1926, p. 45.

¹² Kühn 1926, p.105.

¹³ Kühn 1926, p. 46.

¹⁴ F. Matthies-Masuren 1926, p. 26. Here she is quoting Alfred Buschbeck, the former president of the Vienna Camera Club.

concept soon to be utilized by John Bergheim as well. This gave a broad softness uniformly across the negative.

Watzek finally returned to the combination of pinhole and plano-convex lens, using the pinhole to stop the lens down to an effective aperture of $f/600$. He also was able to reduce the focal length to 30 cm. and therefore have many more options of cameras to mount the lens. A 30 cm. focal length would be ideal for portraiture on a 5x7 negative both in terms of plate coverage and proper perspective. Kühn describes the resulting image as “extraordinarily attractive”¹⁵ the drawback, however, being an exposure time in bright sunlight of five minutes or more.

Almost totally absent from modern histories, Watzek was credited, along with Hugo Henneberg and Heinrich Kühn as instrumental in introducing “modern pictorial photography... to Germany” in 1896.¹⁶ Kühn described him as “one of the greatest pioneers in creative photography,”¹⁷ and Steichen compared him to Monet in his obituary.¹⁸ Even after his demise his photographs were exhibited in major shows. The landmark Albright Art Gallery (Buffalo, New York) exhibition of 1910 included his photographs. His discovery of the artistic potential of the meniscus lens influences lens design up until the present day; some lens designs such as the Struss *Pictorial* were blatant unacknowledged uses of Watzek’s ideas.

There were other artistic photographers experimenting with non-standard lenses, especially for portraiture. Simultaneously others were pursuing lines of inquiry utilizing already available manufactured lenses, with modifications made by the photographer. In

¹⁵ Kühn 1926, p. 50.

¹⁶ Ernst Juhl “Eduard Steichen “ quoting Robert Demachy, *Die Photographische Rundschau* 16 (July 1902) reprinted in *Newhall Essays and Images* p.176.

¹⁷ Kühn *Technik der Lichtbildnerei* trans. Charles Lewis (Halle Saale: Wilhelm Knapp, 1926) p. 105.

¹⁸ Edward Steichen “Hans Watzek” *Camera Work* No. 4, October 1903 p. 54.

1894 the use of simply the rear element of rapid rectilinear or the front element of a *Euryscope* was recommended; based on the illustrations in the article, this expedient was eminently worthwhile.¹⁹ Although he is writing in 1910, Evans advocates using “the old Dallmeyer *Rapid Landscape* lens, if opened out to F/7 or F/8....”²⁰ It is highly unlikely that these were the only two photographers examining that line of thought.

Figure 4.1: Configuration of the Dallmeyer Rapid Landscape design of 1888 (C. B. Neblette and Allan E. Murray *Photographic Lenses* p.61)

As explained in Chapter One, the original Dallmeyer soft focus design of 1868 was essentially an aberration and inspired no subsequent designs either by John Dallmeyer or his competitors. After the beginning of the modern arguments for diffused focus (c.1890), the original design of Dallmeyer was marketed once again but was probably considered an outdated design being over two decades old. Thomas Dallmeyer, now the chief executive of the lens manufacturer, certainly perceived the renewed demand for soft focus lenses and was motivated to bring the concept up to date, both in

¹⁹ Ernst Lambert “On the Use of a Single Lens in Portraiture” *The Studio* Vol. III, No. 14, May, 1894, p. 57.

²⁰ Frederick H. Evans “The Soft-Focus Lens and Sun Effects” *The Amateur Photographer and Photographic News* Vol. LII No. 1354, September 13, 1910, p. 260

terms of the new glasses available and the precise nature of the diffused effect that was desired.

Thomas Dallmeyer marketed the first telephoto lens in 1891. He had read a paper before the Camera Club (London) on December 10th of that year, and demonstrated the lens to those assembled.²¹ A telephoto lens has a longer effective focal length than the actual distance from the lens to the film, hence allowing a camera with a limited bellows extension to use a considerably longer focal length lens. This was a tremendous technical advance and changed the syntax of photography immensely in some areas, especially mountain, wildlife and natural history photography.

Except for J. Traill Taylor, no one had made any concrete recommendations on how to design a telephoto lens and thus, Dallmeyer must receive full credit for this breakthrough (although Adolph Miethe²² (Germany, 1862-1927) came to the same solution almost simultaneously). The genesis of the idea in Dallmeyer's mind was the ever-modest Dr. P. H. Emerson who said: "I am in the proud position, as it were, of being the godfather of this modern invention," noting that he first asked Dallmeyer in 1887 "if such a lens could not be made."²³ Dallmeyer confirmed that Emerson was indeed the source but attaches no dates or situations to the event.²⁴ Because of the conflict between Dallmeyer and Meithe over who was the true inventor, neither pursued a patent. However, Dallmeyer patented an improved, more sophisticated version (British Patent 21,933/91) before 1891 had ended.

²¹ Paul N. Hasluck *The Book of Photography* (London: Cassell and Co. Ltd., 1905) p. 646.

²² Professor Miethe was also the co-discoverer with Dr. A. Taube of ethyl red, the first dye to be used for panchromatic plate sensitization and perfected the use of magnesium as 'flash powder' for artificial illumination (Eder 1978 pp. 473 and 532).

²³ Entry for "Telephotography" *The Encyclopaedic Dictionary of Photography* ed. Walter E. Woodbury (New York: The Scovill & Adams Company of New York, 1898) p.486.

²⁴ Thomas R. Dallmeyer *Telephotography* (London: William Heinemann, 1899) p. xiv.

Emerson immediately utilized the telephoto design, not for natural history photography but in portraiture; in 1893 he exhibited “Portrait of a Lady” made with the new telephoto lens.²⁵ Thomas Dallmeyer narrated the subsequent developments:

when Dr. Emerson exhibited a photograph taken by an ordinary telephotographic lens [the new Dallmeyer model], Mr. Bergheim was exhibiting some very large studies which were taken by a lens involving the principle of telephotographic construction. He was of the opinion that the definition given by the ordinary telephotographic lens from his point of view, and also in the opinion of his artist friends, was a great deal too critical. He had previously also made a few preliminary experiments with lenses of the single spectacle lens type, but the quality of the image was not such as to perfectly satisfy him. About a year ago [1894] he asked Mr. Dallmeyer to undertake an optical construction which should as far as possible be perfect in itself, maintaining a consistent type of definition all over the plate. The type or quality of the lens was to be one which he, after discussions with numerous friends who were artists, had decided was desirable, and as to the merits of which Mr. Bergheim's results would best speak.²⁶

Heretofore, the life of J. S. Bergheim (German, naturalized British c. 1844-1912) has resisted modern revelation almost to the extent of Alfred Maskell's life. Harker notes that he was affluent, primarily a painter, and had printed his already diffuse images with the gum-bichromate process on rough paper.²⁷ He died as the result of a car accident in 1912.²⁸ The author has discovered that he was born in Jerusalem in 1844 or 1845 and became a naturalized British subject. His career was ostensibly as a civil engineer;²⁹ he was instrumental in opening oil fields in Ontario, Canada, Poland, Bavaria, Romania and Nigeria.³⁰ His wife, Clara Constance Bergheim, whom he married in 1873,³¹ survived

²⁵ John A. Tennant “Soft-Focus Effects in Photography” *The Photo-Miniature* Vol. XVI No. 184 (Dec. 1921) p. 149.

²⁶ T. R. Dallmeyer, “Review” *The Photographic Journal* (Nov. 30, 1895), pp. 54-55.

²⁷ Harker 1979, p. 147.

²⁸ *The Times (London)* “Obituary Mr. J. S. Bergheim” Weds, Sept. 11, 1912, p. 9.

²⁹ *Census Returns of England and Wales, 1881* for the parish of Redbourn, Hertfordshire Kew, Surrey, England p. 25, www.ancestry.com

³⁰ Phia Steyn “Oil Exploration in Colonial Nigeria” XIV *International Economic History Congress, Helsinki, 2006* Session 11, pp. 1-5. www.ehelsinki.fi/ieh2006/papers1/Steyn.pdf

³¹ *England and Wales Civil Registration Indexes* London: General Register Office.

him. They probably had no issue. Stieglitz³² and Kühn³³ noted that Bergheim was Viennese but this is clearly in error; they may be referring to his family's origins rather than his own citizenship or place of birth. Kühn wrote that for pictures of groups, Bergheim used a Rodenstock *Bistigmat* lens because it had some amount of residual chromatic aberration which Bergheim found aesthetically pleasing. He was an early member of the Linked Ring, linking in 1892 with the pseudonym "Smudger," certainly an allusion to his gum prints.³⁴ Other than the listings of his photographs in exhibitions, almost nothing else is known of his artistic life.

The resulting *Dallmeyer-Bergheim* lens was to become the benchmark by which all subsequent British soft focus lenses would be compared for decades. First introduced to the marketplace in 1896,³⁵ it was still listed in the Dallmeyer catalogs as late as the 1930s. There were a total of three variants: the original form, a revised type with shorter focal lengths (Figure 4.2) and a fixed focal length type. The original form was a large, heavy and unwieldy lens, designed and marketed specifically for portraiture; the size limited it to the large, heavy and unwieldy cameras built especially for use exclusively inside the bounds of the studio. This original form was 4 ½ inches in diameter and produced any focal length from 36 to 60 inches. It was, however, slow for a studio lens, operating from f/9 at the shortest focal length to f/15 at the longest; by comparison, most lenses created for studio portraiture use operated at f/4.5, which required roughly one-quarter of the exposure of an f/9 lens). The architecture of the *Dallmeyer-Bergheim*

³² Alfred Stieglitz "The Progress of Pictorial Photography in the United States" *The American Annual of Photography and Photographic Times Almanac* ed. Walter E. Woodbury (New York: The Scovill & Adams Co., 1899) p. 158

³³ Kühn 1926, p. 26

³⁴ Harker 1979, pp. 147 and 180.

³⁵ Sir W. de W. Abney *Instruction in Photography* (London: Illiffe and Sons Ltd., 1905) 11th edition p. 130.

caused significant constraints in its use (which will be discussed in detail in the chapter “The Practice of Soft Focus”). It was supplied with three Waterhouse stops but the user had to consult a table to find the effective aperture at a given separation of the elements, another inconvenience, both for the field and studio.



Figure 4.2: *Dallmeyer-Bergheim* lens, final type design of fixed focal length, iris diaphragm and black finish, circa 1924 (undated Dallmeyer brochure)

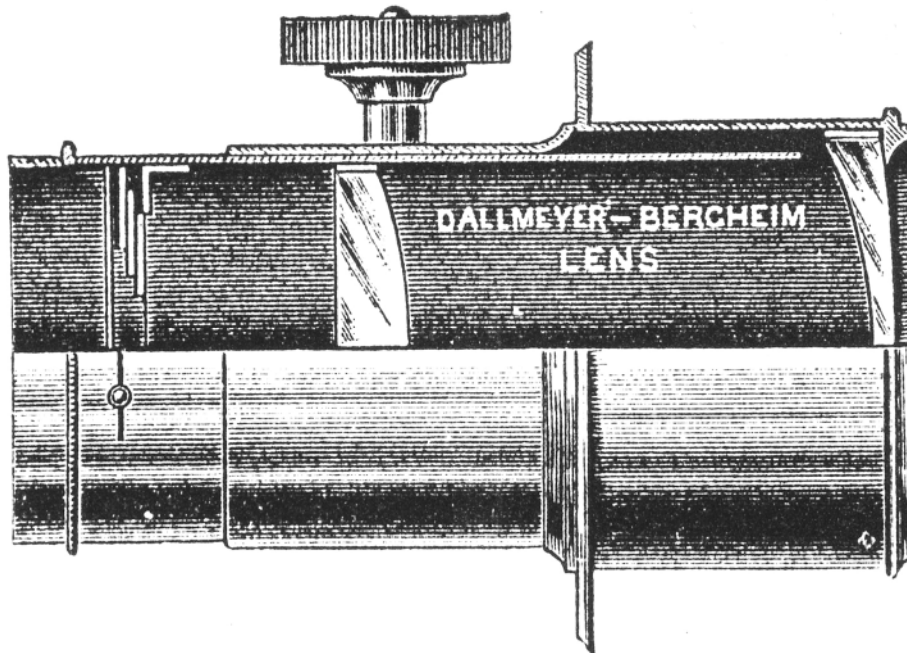

Figure 4.3: Cutaway diagram of the original *Dallmeyer-Bergheim* design (Camera House price list, W. Butcher & Sons, Ltd. 1914)

The lens itself was relatively simple in optical construction using only two glass elements but with a new dimension in lens design: variable separation between the elements. The front element was a single uncorrected positive element and the rear element was a single uncorrected negative element; by varying the distance between those elements, the focal length of the lens was altered significantly. This combination of uncorrected elements created a lens that was uncorrected both spherically and chromatically. The deliberate inclusion of these two aberrations would become the basis for all soft focus lenses which followed. Dallmeyer undoubtedly knew from his father that the spherical aberration in his 1866 design was a key concept for any future soft focus lens. As to the chromatic aberration, “Mr. Bergheim felt that the results given by the unachromatized lenses were such that the colour fringes seemed to produce what was in his eyes a more painter-like effect.”³⁶ This conclusion regarding chromatic aberration is in agreement with the thoughts of Hans Watzek at the same time period.

Bergheim immediately put the lens to use, exhibiting “Cinderella” in the 1894 RPS exhibit³⁷ and perhaps it was here that Frederick Evans was first exposed to its possibilities in portraiture; it is certain that Evans was a devotee prior to 1900. Although portrayed by Newhall as the archetype of the “straight photographer,” Evans was a widely respected portraitist and in this subject matter and his late French landscapes (as contrasted to the English cathedrals) made full use of the *Dallmeyer-Bergheim* lens. Harker considered him “in the forefront of the portrait photographers of the time.”³⁸

Evans spoke of his reliance on the *Dallmeyer-Bergheim* in 1900:

³⁶ Dallmeyer Nov. 30, 1895, p. 55.

³⁷ Dallmeyer 1899, p. 122.

³⁸ Harker 1979, p. 152.

“A word as to the portraits I have ventured to hang here: all are by the Dallmeyer-Bergheim lens, except four of the smaller ones, which were done by a single landscape lens of large aperture. The quality of the image given by the Dallmeyer-Bergheim lens, when at its best focus, pleases my eye extremely, for its beautiful sense of modelling. There are no sharp lines anywhere and yet no sense of fuzziness: at close vision the image is of course distinctly unsatisfactory as regards pure definition: but at a proper distance there comes a delightfully real, living sense of modelling that is quite surprising and most grateful and acceptable to the eye. It has a painty effect (if I may be allowed the expression), a modelled line that is not approached by the work of any other lens within my acquaintance... Its difficulty in use and its slowness of speed will, of course, always prohibit it for general commercial use, but for the artistic worker it is an all but indispensable instrument.”³⁹

It is intriguing to speculate whether Day and Coburn saw this exhibition of Evans’ soft focus portraits when they were in England; they certainly could have examined the prints at leisure even if the exhibition itself was no longer hanging. Although Evans wielded the *Dallmeyer-Bergheim* with aplomb, it was not the optimal design for him being difficult to use and slow (a small aperture). The variation between visual and chemical focus (explored further in the following chapter, “The Practice of Soft Focus”) caused his results to be “accidental”; “the lens we want is one that will give any desired or necessary softness of the image at will, visible, for our choice, on the focussing screen.... I am still hoping to own one, and some day produce easily and certainly, instead of accidentally, the type of portrait I prefer...”⁴⁰ Writing a few years afterward pictorialist author Arthur Hammond considered the *Dallmeyer-Bergheim* “out of the question for amateurs” because it rendered such a soft image and was designed for such a large plate size.⁴¹

³⁹ Frederick Evans *The Photographic Journal* (April 30, 1900) quoted in Newhall 1981, p. 184.

⁴⁰ Frederick Evans “An art Critic on Photography” in Anne Hammond, ed. *Frederick H. Evans, Selected Texts and Bibliography* (Oxford: Clio Press, 1992) p. 102 originally printed Feb. 1908.

⁴¹ Arthur Hammond “Portraits Without Retouching” *Photo-Era* June, 1911, XXVI, No. 6, p. 272.

On April 15th, 1900, F. Holland Day and his nineteen year old cousin, Alvin Langdon Coburn (chaperoned by his ever-present mother, Fanny) left America on a steamer for London.⁴² With them they took almost 400 of the finest specimens of American pictorial photography, destined for the “New School of American Photography.” When it opened on October 10, 1900, it quickly became the most important photographic exhibition mounted to that date; it was highly acclaimed by the French during its subsequent exhibition in Paris in 1901. During their long stay in England, Day and Coburn met many of that country’s leading lights of Pictorialism. When Day and Coburn walked down the *Devonian’s* gang-plank on the 5th of August, 1901,⁴³ they each brought a *Dallmeyer-Bergheim* lens, courtesy of Evans; the path of American pictorialism was altered for ever more. There are four accounts of the beginning of soft focus lenses in America; two by Day (1908 and 1921), one each by Coburn and Henry Smith.

There exists a hitherto unpublished Day letter, to Frederick Evans, written just seven years after the event which specifically details the history of the *Dallmeyer-Bergheim* to America and the subsequent invention of the Pinkham & Smith lens. It is so important that a full transcript is included below.

Norwood May the 6th ‘08
and yours from France is just here My dear
Bro Evans which sits me down while
the fire is hot.

1st The packet came two days after
mine left — you see our heathenish
customs office keeps every blessed thing
which comes over the ocean for days
before letting it out & then with a tax

⁴² Estelle Jussim *Slave to Beauty* (Boston: David R. Godine, 1981) p.142

⁴³ *Passenger Lists of Vessels Arriving at Boston, Massachusetts, 1891-1943*, The National Archives, Washington, D.C., microfilm roll 46, www.ancestry.com

of anywhere from twenty-five to eighty-five per cent to be paid by the eager recipient. But — Man Whew!! The Courtyard!!! & on top of this you say portraiture real portraiture is your forte! —& the Choir Aisle & Choir of Bourges is yet finer to my eye — perhaps the finest Evans' ever. Although the Height & Light is full of majesty. The Choir to Choir doesn't hit me so hard artistically. I fully believe these things done with the Smith lens would have an atmosphere of verity which your clever [closer?] and more definite camera-eye lacks, and to me a trifle to the subjects injury — Here to follows a

True and Faithful History
of the
Smith Lens
so called-

You will remember that when C [Coburn] & I left you in 1901 through your kindness we both carried Bergheims with us. My old friend Francis Watts Lee, whose name & work you may recall, had been

-----page 2-----

Practicing Dabbings [?] for years before that but had never been able to put hands on a real piece in the flesh-- the minute I got to town he seized upon such prints as I had with me made with it & begged unceasingly to have the lens put into his hand to show to a friend of his —a lens maker one Smith— Lee is a crack-brained enthusiast & I put him off (had to because my stuff was all stored in the cases in which it crossed the water awaiting my settling into quarters big enough to hold em) & finally gave him a letter to Coburn saying he had a duplicate of mine. I thought he would be willing to loan it. This he did & S. [Smith] took the thing all apart & said as how he could do it one better in speed, but in one or two other respects he could not compete. The #1 was given to Lee— who sold it to a Miss Austin. Mine (the one destroyed in my fire) was #2 I believe — just where C [Coburn] came in I don't know but he has had a half a dozen or so first & last different focal lengths &c & I have had including those destroyed, five — S. [Smith] is something

of a 'fake' to use a piece of American slang
& assumes to do wonderful things where he really
does nothing — There are some two hundred of
the things now in use here, there & everywhere &
I don't have remotest belief that any two of 'em
are exactly alike — At least I have never seen
the work of two which coincided even when
it was made of the same object at the same
time & this experiment has been tried by some
three or four of us at Little Good Harbor, Maine.

-----page 3-----

So when you get one you must not be
vastly surprised if its result is neither
Coburn or me, but if you wish to change
it for one with more Smith in it, or
less all you'll have to do is send it
back & he'll very gladly try again. The
question of double outline is one which
puzzles me beyond all things. The same
lens will do utterly opposite things in
different atmospheres & with different conditions
of light. Its depth of focus is nothing as
compared with the Bergheim— This too is
a quality I've pestered Smith over more
than cats ever pestered Saml Johnson. He
says he hopes to over come it one day
but I doubt. If you have the same
B. [Bergheim] you had when I was there (a four or
five pounder) the same as mine was (which my fire
took from me) I'll exchange one of
the Smith 18" for it if you wish & then
you could get the 9" as well and only have
that on your conscience — You don't have
duties to pay & we do so I'd ask you to
slip the B. [Bergheim] into some friends pack who was
coming this way — I've used nothing but Smith for
— well since the fire — & am so accustomed
to it that anything of more literalness
gives no pleasure for certain sorts of work
any more.⁴⁴

⁴⁴ F. H. D. to "My Dear Bro. Evans" eight pages handwritten on yellow paper; in the possession of the author.

Norwood May the 6th '08
and yours from France is just here My Dear
Bro Evans which sits me down while
the fire is hot.

^{1st} The packet came Tuesday after
mine left - you see our weatherish
Customs Office keeps every blessed thing
which comes over the Ocean for days
before letting it out & then with a tax
of anywhere from twenty-five to eighty-five
per cent to be paid by the eager recipients.
But - Hain! - adieu!! the Courtyard!!!
& at top of this tower a portrait - not
a portrait is seven feet! - & the Choir Arch
& Choir of Bourges is yet finer to my eye -
perhaps the finest Evans' ever. although the
Height & Light is full of majesty. The Choir to Choir
sculpt hid me so hard artistically. I fully believe
these things done with the Smith lens would have
an atmosphere of unity which you could not
upon definite camera-eye looks, and to me a
tribute to the subjects injury - Here to follow a

True and Faithful History
of the
Smith Lens.

So called -

You will remember that when C & I left you
in 1901 through your kindness we both carried
Benham with us. My old friend Francis Watts die,
whose name & work was away now, had been

Figure 4.4: direct scan of F. Holland Day's letter to Frederick Evans. Note Day's title near the bottom, "True and Faithful History of the Smith Lens, so called" (author's collection).

This letter gives a definitive history of the transplantation of soft focus lenses from Dallmeyer's exclusive domain to American optical manufacturers, a benchmark in the development of Pictorialism. The direction of American pictorialism would take a new, hitherto unforeseen direction which in turn would influence pictorialism elsewhere.

To summarize the major points of the letter: first, both Day and Coburn obtained the lens through Evans' "kindness." It is likely this implies that Evans arranged the purchase rather than gifting them; these were expensive lenses (a whole plate lens sold for £12.0.0 in 1904)⁴⁵ and Evans was notoriously tight with his money. Second, Coburn lent his lens for Francis Watts Lee to take to Henry Smith, partner in the Boston optical goods firm Pinkham & Smith. Thirdly, Day and Lee were Smith's earliest customers for the new lens. Fourth, in seven years Smith's output had been about two hundred lenses of this type. Fifth, Smith's quality control left a great deal to be desired. Sixth, apparently Evans was desirous of obtaining a nine inch version. Seventh, Day considered it inferior to the *Dallmeyer-Bergheim* in certain categories but has used it exclusively since his own *Dallmeyer-Bergheim* perished (the large building his studio was housed in burned to the ground November 11, 1904). Eighth, Day wished to obtain another *Dallmeyer-Bergheim*, whether to supplement or supplant the Smith is not clear. It is tantalizing to wonder if the proposed lens exchange between Day and Evans ever took place.

There is a second, later letter by Day written on July 8, 1921, regarding his use of the *Dallmeyer-Bergheim* and the metamorphosis into the first American soft focus lens, made by Bostonians Pinkham & Smith.⁴⁶ This letter was written to an unidentified recipient two decades after the events described and may not represent the most accurate

⁴⁵ Kodak Limited catalog, "Price List of General Photographic Apparatus and Materials" (London: Kodak Ltd., 1904) p. 114 reprinted (New York: Arno Press, Inc, 1979)

⁴⁶ partially quoted in Jussim 1981, p p.154-155.

account. However, it does agree well in most respects with Day's 1908 missive. It was written by Day in response to a query dated June 16th, 1921, apparently regarding Day's role in the inception of the Smith *Semi-Achromatic* lens. Although it is not possible to know with certainty the "legend" Day was attempting to correct, there is a likely candidate. Just five months earlier, well known Pictorial photographer and author, Arthur Hammond, had written an article in the February, 1921, issue of *American Photographer* on lenses for portraiture. In it, Hammond states that Smith "made a lens to meet the desires of F. Holland Day" who "wanted a lens that would give an image as near as possible to that obtained by a small pinhole, but with more speed. The result was the 'semi-achromatic' lens."⁴⁷ Where would Hammond have obtained such erroneous information? The answer is found in the promotional literature for the lens, written by Smith himself⁴⁸ which is quoted in later pages of this chapter.

Since this letter is solely about the origins of the Smith *Semi-Achromatic* lens, a complete transcription follows:

8 July 1921

My Dear Sir,

Your letter of the 16th inst. is to hand, in replying let me begin by saying that I am at the present moment far from all references, but that I believe unless any statement is qualified you may depend upon the accuracy of the following in which i am glad to have the opportunity of contradicting publicly a legend which has grown up around my

page two

connection with the early so-called soft focus lenses and their introduction into America.

The original honor lies at the door of Mr. Francis Watts Lee, of Boston-not mine. Some five and twenty years ago, we were both members of a small

⁴⁷ Arthur Hammond "Portraiture: the lens for portraiture, Chapter V" *American Photography* February 1921 Vol. XV No. 2 p. 74.

⁴⁸ Henry S. Smith "Foreword" *Semi-Achromatic Lenses* a brochure (Boston: Pinkham & Smith, undated c. 1912) unpaginated.

band of enthusiastic amateur photographers living in or near Boston. Mr. Lee was the only one of us who had any knowledge of optics, or much of any relating to technical photography. In the late nineties he became very enthusiastic

page three

over some work done with a British lens made by the Dahlmeyers [sic] (if that is the spelling correctly). He sent to England for literature upon the subject and in early on 1900 was in [sic] the eve of ordering a lens from London. Late that winter I determined upon exhibiting in Europe a collection of prints made by the then so-called American "New School" and Mr. Lee entrusted to me further investigations of the lens in London, one of which was purchased upon my arrival there. The work of this lens was a

page four

revelation to myself and some half-dozen American photographers who were in Europe at the time. While the lens was made purely for a portrait lens, I carried it the next spring to Algiers, and made there what English people told me were the first landscapes attempted with this lens, my experiments heretofore being entirely with portrait or figure work. Alvin Coburn procured another, and perhaps Edward Steichen a third. Mr. Lee had kept in close touch with our investigations and upon my return to this country in the summer of 1901, he

page five

was eager to see a greater number of prints and the lens itself. As I was shortly to go into a new studio in Boston I could not at the moment put my hands upon the lens, and induced Mr. Coburn to ease Mr. Lee's enthusiasm by loaning him his lens. After some conferences Mr. Lee loaned the lens to Mr. Smith, of Messrs. Pinkham and Smith who shared the now growing enthusiasm for a similar lens to be made in America. The result of which was in short the uncorrected Smith lens.

page six

The first example of this lens I would suppose was completed in the autumn or early winter following, and very naturally became the property of Mr. Lee and not myself. It is now, if my memory serves me, in the hands of Miss Alice Austin of Boston. The second example of the lens to be made by Pinkham and Smith came to me and was destroyed in my studio fire in 1904, by which time there I believe there were about a score of these lenses in use. While all examples

page seven

made up to this period were single lenses they scored somewhat over the British Dahlmeyers [sic] in rapidity and ease of manipulation. A story at that time gained some credence to the effect that Mr. Smith was buying up all the old single lenses of certain makes, which were to be had, and mounting them either with or without some slight changes or modifications, and that they became soft focus lenses. However this may be it is certain that that in the early days Pinkham and Smith never

page eight

turned out two of these lenses alike or two that would do the work in the same way and for a time it was quite possible for one interested in the matter to distinguish the author of one print from another providing the ownership of the various lenses put out were known. I may have had something to do with

spreading the interest in the lens in these early days, I am sure its work at its best never appealed to anyone more strongly than to me. Of late years the majority of people using the lens are apparently little acquainted

page nine

with its capability or are properly acquainted with its best work- But this is another story.

Perhaps before making up your statement in relation to the early lens, you will be good enough to ask Mr. Lee to corroborate what I have told you. He has been for many years connected with the Boston Public Library, where he shall be addressed.⁴⁹

One major omission in this second letter is any mention of Evan's role. It also emphasizes Lee's contribution to a much greater extent than the first letter, giving him full credit for beginning the investigation of soft focus in the Boston photographic circle. Steichen's ownership of a *Dallmeyer-Bergheim* is noted; Day had shown it to him while "The New School of American Photography" was exhibited in Paris, 1901 (there is some confusion in Steichen's memory here; he wrote that Day had a "Smith lens" with him when visiting Steichen in Paris, which is not possible as it had not been made yet.)⁵⁰ In all other substantive points, Day's two letters are in excellent agreement.

Francis Watts Lee is yet another key figure in the Pictorialist movement about which little is known. His wife, Agnes Rand Lee, was a children's book author, and their daughter, Peggy, were photographed by Day c. 1899.⁵¹ He and Day had been friends since 1892 when they both were part of the Visionist group which published the short lived magazine *The Knight's Errant*.⁵² Nine of Lee's photographs and eight of Alice Austin's were included in Day's "The New School of American Photography" exhibit in

⁴⁹ Letter to an unknown correspondent, F. Holland Day, in the collection of the Norwood Historical Society, Norwood, Mass., courtesy of archivist Dr. Patricia Fanning.

⁵⁰ Edward Steichen *A Life in Photography* (Garden City NJ: Doubleday & Co., 1963), unpaginated, second page of Chapter Two.

⁵¹ Verna Posever Curtis "From New Athens to Arcadia" *F. Holland Day, Selected Texts and Bibliography* eds Verna Posever Curtis and Jane Van Nimmen (Oxford: Clio Press, 1995) p. 18.

⁵² Patricia Fanning "Works Written or Published by F. Holland Day" *F. Holland Day, Selected Texts and Bibliography* eds Verna Posever Curtis and Jane Van Nimmen (Oxford: Clio Press, 1995) p. 109.

1901.⁵³ He had three photographs included in the 1899 Berlin exhibition.⁵⁴ His career was spent working at the Boston Public Library where in 1921 he curated an exhibit of Day's collection of Keatsiana.⁵⁵

Henry Smith is largely unknown as well. He was important enough in the photographic world that *Photo-Era* ran a brief obituary at his death in 1917:

“Mr. Smith was born in Webster on September 6, 1867, the son of Henry S. Smith and Sarah M. (Davis) Smith. He attended schools in Webster, and then went to Worcester Academy, after which he began to learn the optical business under H. N. Vinton and the American Optical Company, in Southbridge. He carefully mastered the details of the work, and thirty years ago came to Boston, and for some years was with Andrew J. Lloyd Company as foreman of the shop. Then, with William F. Pinkham, who was head of the sales-force at Lloyd's, Mr. Smith founded the firm of Pinkham & Smith, and when this was later became incorporated as a company, Mr. Smith became the vice-president.

He was widely recognized as an authority and expert in optical and photographic lenses. He originated the Smith soft-focus lens, used widely by photographers for pictorial work.”⁵⁶

This appears to be the most complete biography of Smith in the period.

Considering his role in bringing the technology of the soft focus lens to America and that his *Semi-Achromatic* lens was more widely used by major Pictorialists than any other lens, this is a paltry reminder of his place in history. It is also a reflection of the increasing polarization in American print media regarding soft focus; as an editorial position, some magazines deliberately ignored any news regarding soft focus.

⁵³ Helmut Gernsheim typescript copy from “The Photographic Journal” October, 1900, in the Gernsheim materials for the Coburn biography, The Humanities Research Center, University of Texas.

⁵⁴ *Ausstellung fur Kunstlerische Photographie* exhibition catalog (Berlin: unknown, 1899) unpaginated.

⁵⁵ Jussim 1981, p. 202.

⁵⁶ “Events of the Month- Henry S. Smith” *Photo-Era* August 1917, XXXIX, No. 2, p. 101.

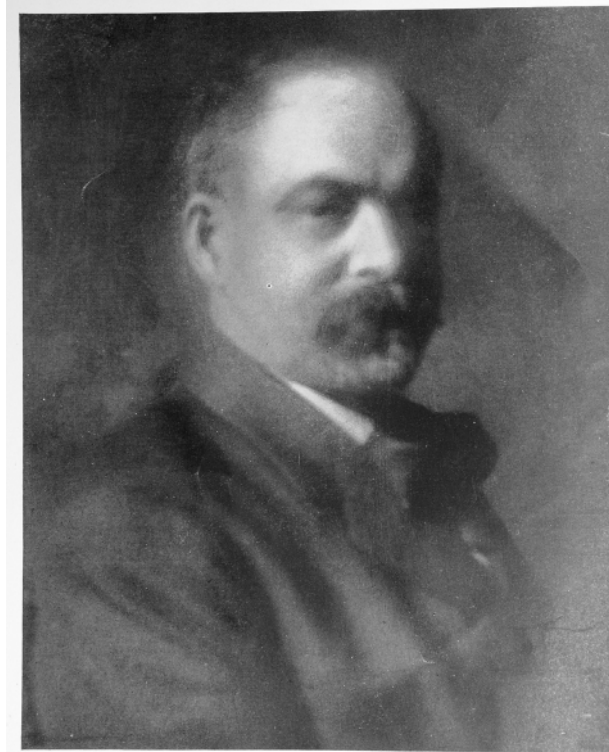

Figure 4.5: Alvin Langdon Coburn *Henry Smith* using a 15 inch focal length Semi-Achromatic at $f/6$ (*Photo-Era* June, 1911, XXVI, No. 6, p. 268).

Yet another source of information on the origins of the Smith lens exists, purportedly written by Coburn but almost certainly heavily edited and rephrased for commercial gain by Henry Smith. This is found in the brochure printed by Pinkham & Smith to promote the new lens, denominated the *Semi-Achromatic*. Given the brochure's extreme rarity, Coburn's contribution is reprinted in full herein; it will be referred to in future chapters as well:

When the history of Artistic Photography comes to be written, the question of diffusion will assume its real importance, and the Smith Lens (so called by Mr. Coburn and others because Mr. Smith of this firm was the first to put a lens of this type on the market) will receive the recognition it so fully deserves, for one of the things that makes photography worth while as a means of personal expression, is Lens Quality. Back in the dark ages, it seems to me I gave some considerable thought to this question of diffusion. I used a battery of various

size pinholes, which were excellent, but for their excessive slowness.⁵⁷ I enlarged through bolting silk, and printed from the reversed negative,⁵⁸ but all these were make-shift methods at best. I well remember hailing with joy the news imparted to me by F. Holland Day, that in Boston, Mass., U.S.A. (my home town), there was an optician by the name of Smith who had a theory, and was working on this very problem of diffusion, and was making lenses for photographic purposes only for the pleasure it gave him to produce something different than others made, and I am the proud possessor of one of the earliest he turned out. After making half a dozen exposures with this lens, I saw that it was exactly what I desired. It was a single combination lens,⁵⁹ fifteen inches in focus that gave a quality of image that I had dreamed of, but never believed that I would be able to get. To any one using a lens of this type for the first time, after using a fully corrected anastigmat, he will find much difficulty in deciding what is the exact focus. There will seem to be a belt of focus, more than an actual plane of definite sharpness, and such is really the case, for the Semi-Achromatic Lens has a great depth of apparent focus, but none actual. You have no more of what Bernard Shaw calls one of 'the infuriating academicisms of photography,' one plane of the picture sharp and all the others wooly and unnatural, a thing that no self-respecting human eye would ever see. The Semi-Achromatic here seems, in some extraordinary way, to break up this plane of focus and distribute it over the entire depth of the image. It gives the distance in landscapes the shimmering quality of sunlight seen through a summer mist.

I now have about a dozen P. & S. (Semi-Achromatic) lenses of various focal lengths, most of which have been made especially for me. When I am in Boston, I always make my way to 288 Boylston Street to enjoy a chat with a tall, kindly man who thinks in glass. I tell him my troubles and my needs, and not long afterward, I receive a package which after burrowing through the excelsior packing, gives up a small glistening object. This is the lens - nothing like it has been made before - nothing like it is apt to be made again, for Mr. Smith is a revolutionary in photographic optics, and he gets a lot of fun out of life. He batters down conventions and breaks all the rules of modern optics, but his 'chunks of glass' as he calls them, will give the most wonderful results. "It is difficult for me to imagine what modern photography would be without the Semi-Achromatic Lenses, when you consider that F. Holland Day, Baron de Meyer, Stieglitz, White, Steichen, Kuehn, Seeley, Mrs. Kasebier are only a few of the workers who use it, practically to the exclusion of other lenses.

If you compare the Semi-Achromatic Quality, with out of focus results, you will at once see the difference. With the S.A. Lens you get modeling, roundness, suggestive of sculpture, atmosphere and texture. With the out of focus objective,

⁵⁷ The author is unaware of any Coburn photographs which can be said with certainty to be created by use of a pin hole, creating a major gap in the study of Coburn's development as an artist.

⁵⁸ "reversed negative" alludes to making contact prints. Standard practice for obtaining optimal sharpness and tonality dictated the orientation of the emulsion side be in contact with the sensitized side of the printing paper. By placing the emulsion side of the negative upward instead, the image is spaced the thickness of the glass plate above the printing paper. The light source would then bleed around the negative image, creating a diffused image with decreased contrast.

⁵⁹ The lens was two pieces of glass, cemented together with Canadian balsam to form a single element.

you get- well, if you are a photographer, you are probably sadly aware of what you get, for even the best of us get the plate in the holder wrong-side out at times, or the camera gets a slight jar during exposure.

It seems to me that each of the S.A. Lenses has some charm of its own. They have Individuality. You may not and probably will not find out their full possibilities for some time. I had one lens in my possession for over two years before I discovered that it was the best one I owned.

Just a few words of practical advice in regard to the use of these lenses. Always fully expose, as you then get the best work out of your lens. Under-exposure (bad in any case) plays you queer pranks when the S. A. Lens is used. Never stop down to any great extent, as in so doing you lose much of the special quality of the lens. When you first get a P. & S. S.A. Lens, it is a good plan to take a nice, quiet, still-life subject, and practice focusing it as a large, light colored object that you can readily see. It might be interesting, also, to slip your ordinary lens on the camera, and make two comparative exposures. This kind of practice teaches you more than any amount of talk. I must warn you, however, of a danger if you make the comparative exposures that I have just referred to - you will probably throw the ordinary lens away. Don't do it. It is a salable commodity.⁶⁰

The most obvious deviation from Day's account is the total exclusion of Coburn's *Dallmeyer-Bergheim* as the prime model that Smith was to use as a model. It is interesting to speculate what became of Coburn's *Dallmeyer-Bergheim*; he apparently never mentions it in his correspondence (as preserved at the George Eastman House and the Harry Ransom Center, University of Texas) nor in published articles. Coburn left his lenses to the George Eastman House, including what is probably his first Pinkham & Smith lens, but there is no *Dallmeyer-Bergheim*. Perhaps this is indicative of his satisfaction with the new lens that he immediately divested himself of the model for it. The number of Pinkham & Smith lenses owned by Coburn by 1908 (half-dozen by Day's account, a dozen in Coburn's essay) would seem to manifest his preference; nonetheless, Day owned five, although perhaps not at one time, but sequentially. Given Day's

⁶⁰ Coburn c. 1912, unpaginated.

evaluation of their variation, perhaps he was simply seeking one which would be deemed satisfactory for his artistic needs.

Smith is certainly not described in Day's terms as a 'crack-brained' but as intelligent and focused, "had a theory, and was working on this very problem of diffusion." Written about four years after Day's letter, it does acknowledge that the *Semi-Achromatic* lenses "have Individuality," or as the less charitable Day stated, "I don't have remotest belief that any two of 'em are exactly alike." Coburn was undoubtedly too politic to point out Smith's deficiencies — and would have known that Smith would surely delete them anyway. Smith was willing to allow that the lenses had some differences.

Coburn noted that he owned one of the first *Semi-Achromatics*; Day was not certain which one (in rank order) that Coburn owned.⁶¹ This first lens of Coburn's is almost certainly in the George Eastman House's technology collection; it has a brass barrel unlike the others which are all aluminum barrels. It is instructive to examine all of Coburn's lenses at the George Eastman House. The group does not include his *Dallmeyer-Bergheim* but presumably includes all of the other soft focus view camera lenses of his lifetime. An inventory includes:

1. Dallmeyer *Patent Portrait* 2B #35109, aluminum barrel
2. Dallmeyer *Adon* #67409
3. Bodine's *Pictorial* #50 (with an adapter for a reflex camera)
4. Voigtlander *Dynar* 12 inch #68759
5. Dallmeyer 4 inch telephoto attachment #74425

⁶¹ Clarence White believed he owned the third *Semi-Achromatic* made by Smith and thus Coburn's must have been at least the fourth one made. Clarence White "Notes from Pictorialists" *The Photo Miniature* Vol. XVI No. 184 December 1921 p. 190.

6. Un-named meniscus mounted in Wollensak shutter
7. un-named lens (two)
8. Pinkham & Smith *Semi-Achromatic* 16 inch “Made expressly for Alvin Langdon Coburn” engraved on aluminum barrel
9. Pinkham & Smith *Semi-Achromatic* 17 inch, aluminum barrel
10. un-marked brass barrel lens slotted for Waterhouse stop
11. Pinkham & Smith *Semi-Achromatic* 8 inch with rotating occulting disk #979
12. Pinkham & Smith *Semi-Achromatic Doublet* No.1 9 inch f/4
13. un-marked f/6 brass barrel lens with front mounted diaphragm
14. a (front?) lens element marked “15 IN.” (threads into lens #8 above)

Number One, the Dallmeyer soft focus lens, is probably a post-1909 model when the company changed from brass to aluminum barrels. The designation “2B” indicates the series and focal length: f/3, 8¼ inch focal length designed for a 2½ x 3½ inch negative; it is unknown if Coburn ever owned a camera that small, however, he did own a quarter-plate (3¼ x 4¼ inch) reflex camera and may have mounted the lens on it.⁶² This was the fastest of the three series of Dallmeyer *Patent Portrait* series, the others being f/4 and f/6. Coburn is unlikely to have needed the extra speed but probably utilized the greater softness and different *bokeh* produced by the larger aperture.

Number Two, the Dallmeyer *Adon*, is a variable focal length telephoto lens. The telephoto lens inspired by Emerson’s comments is the antecedent to this lens, which is composed of two achromatic elements.⁶³

⁶² Letter from Alvin Langdon Coburn to Helmut Gernsheim dated January 19, 1965. Gernsheim manuscripts, Humanities Research Center, the University of Texas.

⁶³ Information for the Dallmeyer *Patent Portrait* and the *Adon* are from an undated Dallmeyer brochure. Because all prices included a “war tax” it must be during or immediately after World War I.

Number Three, the *Bodine Pictorial*, was a short-lived lens, sold only in 1911. That year the Wollensak Optical Company hired its designer, H. Oliver Bodine, and the Bodine became the most long-lived of all American soft focus lenses, the Wollensak *Verito* (still sold as the *Veritar* in the 1960s).

The Voigtlander *Dynar* is a 1902 modification of the *Tessar* design with five elements in three groups operating at f/6.⁶⁴ This should be a very sharp lens, especially by the standards of its day.

There are four lenses marked *Semi-Achromatic*. Additionally, number 14 is an interchangeable front element for number eight. Most interesting is the number 10 lens which contains a slip of paper stating “Smith Lens.” The fact that it is brass and slotted for Waterhouse stops rather than an iris leads one to speculate that this may be Coburn’s original Pinkham & Smith lens, manufactured more as a prototype and therefore bearing no markings whatever. Thus, assuming Coburn never parted with any of his Pinkham & Smith lenses, Day’s count of “half-dozen” is more accurate than the “dozen” in what is supposed to be Coburn’s own words; this might be construed as a proof that Smith had edited Coburn’s words for the profit of Pinkham & Smith.

Lens number thirteen is problematic. It is a heavy lens, much heavier than any of the Pinkham & Smiths of Coburn’s. The easily visible rear lens possesses a curve unlike the various *Semi-Achromatics*. It is possible that it is the prototype of the *Semi-Achromatic doublet*, a design proposed by Coburn; a Pinkham & Smith brochure dated 1920 credits him with suggesting the doublet design.

Henry Smith also added his own account in the same brochure:

⁶⁴ Rudolph Kingslake “The Development of the Photographic Objective” *Handbook of Photography*, eds Keith Henney and Beverly Dudley (New York: Whittlesey House, 1939) p. 46.

In 1897 the writer first constructed, along original lines, a Photographic Objective whose primary object was to give an image as near as possible to that obtained by a small pin-hole, as far as definition went, or the lack of it, as you may see fit to designate. This original Lens was made to meet the desires of the Leader of Pictorial Photography, at that time, - F. Holland Day. I can to this day see him as he stood before me, and said (after I had explained to him that I believed such a lens as he desired to be a comparatively simple matter, as all that to me seemed necessary, was to seek not to eliminate but control the chromatic and spherical aberration that existed in an uncorrected lens, and which were fully corrected in the Anastigmat Lenses, then as now, on the market). "Smith, make me one no matter what it costs. Make it, and make it quick." The result was the Semi-Achromatic lens.⁶⁵

Smith's account is at major variance from Day and Coburn. He has pushed the date back to 1897, from 1901, and has Day, a major player in the photographic art world, and not Lee, an amateur, as the impetus. Clearly some self-aggrandizement by Smith took place in this essay. Surely his memory cannot be so deficient a decade or so after such a major event.

The letterhead on the Pinkham & Smith corporate stationery states that the firm was founded in 1896⁶⁶ and thus had been in operation for only five years when Smith designed his lens. Where did Smith get his idea? Was it an independent invention? There are a number of likely candidates which served as his inspiration. One leading contender is the *Rapid View and Portrait* lens..

The Taylor, Taylor and Hobson lens, *Rapid View and Portrait* (later simply known as the *R.V.P.* as identified on the lens barrel itself) originated before 1885⁶⁷ and consisted of a simple combination meniscus set well behind the aperture blades. It "was merely a landscape lens normally working at f/16 opened up to f/8. This introduced or rather increased the spherical aberration and the curvature of field, and the definition was

⁶⁵ Henry S. Smith "Foreword" *Semi-Achromatic Lenses* a brochure (Boston: Pinkham & Smith, undated c. 1912) unpaginated.

⁶⁶ GEH, letter dated 1935.

⁶⁷ Wilkinson and Glanfield 2001, p. 280 for all of the TT&H information in this paragraph.

by no means even, being very much sharper in the center than around the edges.”⁶⁸ It was the first soft focus objective used by Clarence White;⁶⁹ it was also used by Alfred Stieglitz at some time in his career as well.⁷⁰ In 1913 it was rebranded as the Cooke *Achromatic Portrait Lens*.⁷¹ Except for the improved quality of the glass and the working aperture, the *R.V.P.* was nearly identical to Charles Chevalier’s achromatic French *Landscape Lens* f/15, of 1839, one of the earliest lenses designed specifically for photography.⁷² This general landscape lens design was in production for nearly a century and was in wide use in 1900 and Kühn believed it was the model for Smith’s lens.⁷³

A further refinement of the landscape design of Chevalier was Thomas Grubb’s (Ireland, 1800-1878) *Aplanat* design of 1857; this lens was produced for forty years. Kingslake noted that “a similar type of construction has been used in some recent soft-focus portrait lens,”⁷⁴ which is probably a reference to the post-War Kodak soft focus portrait lens but could easily be applied to a number of the circa 1910 designs as well.

⁶⁸ Hammond “Portraiture: the lens for portraiture, Chapter V” *American Photography* 15 No. 2 (Feb. 1921) p. 74.

⁶⁹ White “Notes from Pictorialists” p. 189.

⁷⁰ Stieglitz’ wife, Georgia O’Keefe, gifted the George Eastman House with two lenses he used. One is a Taylor, Taylor & Hobson, 19.2 inch focal length, R.V.P.

⁷¹ Barbara Lowry “English Made Cooke Lenses- Still in the Picture” *View Camera* May 2002 p. 22.

⁷² Kingslake 1989, p. 28.

⁷³ Kühn 1926, p.62.

⁷⁴ Kingslake 1989, p. 29.

Figure 4.6: Grubb Aplanat design of 1857 (Kingslake *A History of the Photographic Lens* p.29)

Figure 4.7: Kodak Soft Focus Lens design circa 1950 looked remarkably like the hundred year old Grubb design (Eastman Kodak Co. *Camera Techniques for Professional Photographers* p.16)

Frederick Evans wrote of the virtues of the landscape lens that “those who value true picture-making should never use the anastigmat in preference to the landscape lens.”⁷⁵ He noted that this humble and inexpensive lens possessed many attributes including “a roundness of image, a brilliancy, a separation of planes in the landscape lens that has no equal, especially when used at as large an aperture as possible.”⁷⁶ When so used, he considered that it “gives equally delightful images to the ‘Smith’.” Evans

⁷⁵ Evans September 13, 1910, p. 260.

⁷⁶ Evans September 13, 1910, p. 260.

summarizes by saying “Let me, in conclusion, urge my readers to go back to the old landscape lenses, get them opened out to F/8, and use them at that.”⁷⁷ Although Evans is writing in 1910, this type of lens had been in use for decades and likely he and others knew this information long before it was put into print. Is his statement about the Smith lens a ‘coded’ remark that many photographers would have understood, meaning that the Smith was essentially nothing more than a landscape lens that was opened to a faster aperture? Might he have imparted his twist on landscape lenses to Day and Coburn during their stay in 1900? A. Horsley Hinton also recommended the modified landscape lens for pictorialists.⁷⁸

It is virtually impossible that Smith had not seen landscape lenses and the *R.V.P.* as they were so common in 1900. He certainly should have known Grubb’s *Aplanat* (a term used to describe a lens corrected for both spherical and chromatic aberrations) design as well, as it was made until 1897.⁷⁹ The late versions of the *Aplanat* benefited from the new Jena glasses after 1886 and may have been re-branded by Grubb as the *New Achromat*.⁸⁰ Furthermore, Smith might have been aware of Hans Watzek’s use of the meniscus. If not Watzek’s trials, then more certainly Taylor’s paper of 1864 (previously cited) which was the definitive statement on landscape lenses. The *Semi-Achromatic* was at most a minor variation of these lenses and not by any means original to Smith. “Semi-achromatic” was defined as “correcting the chromatic aberration of the lens by one-half.”⁸¹

⁷⁷ Evans September 13, 1910, p. 262.

⁷⁸ A. Horsley Hinton *Practical Pictorial Photography* (London: Hazell, Watson & Viney, Ltd. 1910) p. 69.

⁷⁹ Kingslake 1989, p. 29.

⁸⁰ Wilkinson and Glanfield 2001, p. 179.

⁸¹ Tennant December, 1921, p. 166.

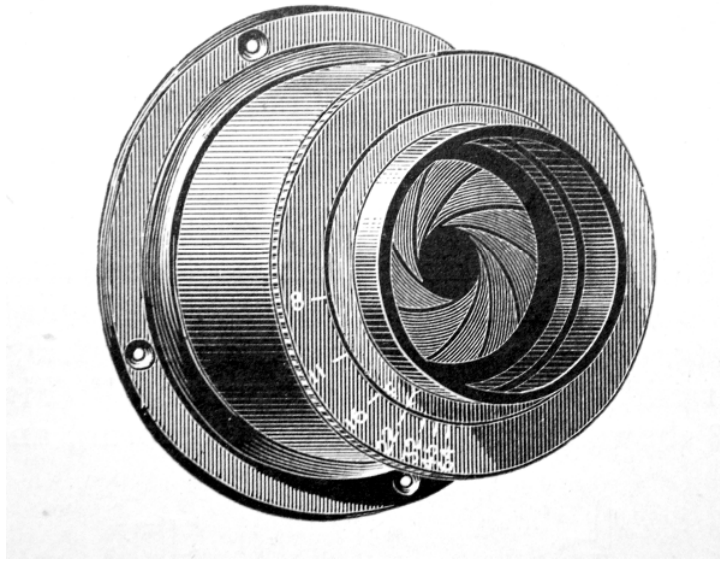

Figure 4.8: Circa 1900 Landscape Lens (Paul N. Hasluck, *Book of Photography* 1905 p. 31)



Figure 4.9: Pinkham & Smith *Semi-Achromatic* Series I No. 3 Serial №1462. The similarity is overwhelming, both in the design of the lenses and the barrel housing. (collection of the author)

A decade earlier, in 1890, George Davison had recognized that spherical aberration was the best method of inducing diffusion and had called for designers to produce a lens “with which spherical aberration can be regulated at will”⁸² and it should have been obvious to Smith, as well as many others, that any of the lenses just discussed with minor adjustments (primarily opening the aperture a stop or two) could produce that desired soft focus lens. Someone with Smith’s optical experience should have seen that merely an adaptation of current lenses would suffice for Lee, Day and Coburn’s artistic applications.

Heinrich Kühn owned and used the *Semi-Achromatic* for at least 16 years⁸³ and thus is an excellent source of informed and experienced information on that lens. He found that the halo which surrounded light and highlights could drown the main central core image.⁸⁴ This could be mitigated by a low contrast subject or by stopping the lens down — which changed the softness however. Smith was clearly aware of this handicap and states in the advertising literature for one of his later lenses, the Synthetic, that “even at its maximum [f/5] aperture it does not produce the halo or 'run-around' that was often found when the early 'semi-achromats' were used wide open.”⁸⁵ On the other hand, when used with great care, the *Semi-Achromatic* “at large apertures, especially the medium focal lengths, the flitting of the light, the spreading of luminance, is given most convincingly,”⁸⁶ a most desirable characteristic for Kühn. Further, “by introduction of very large spherical aberrations, Smith did not only changed the entire image character,

⁸² Reported in Maskell October 1890, p. 27.

⁸³ Kühn 1926, p. 67.

⁸⁴ Kühn 1921, pp. 112-113.

⁸⁵ Arthur Hammond “Smith Soft-Focus lenses” a sales brochure (Boston: Pinkham & Smith, no date, c. 1923) unpaginated.

⁸⁶ Kühn 1926, p. 62.

enlarging the usable angle of coverage and the useful aperture, but deepened in surprising measure the delineation of depth.”⁸⁷

By 1935, there were perhaps fifty different soft focus lenses for the British or American photographer to choose amongst, many derived from the early Pinkham and Smith lens designs or the other widely used soft focus lens, the Wollensak *Verito*. Relatively few found wide acceptance and even fewer were used by prominent Pictorialists.⁸⁸ The other soft focus lens which saw a long period of production, the Rodenstock *Imagon*, is discussed in detail in the following chapter.

Summary

To summarize the in-camera (as contrasted to darkroom manipulations) methods available to produce a diffused image by the winter of 1901:

1. The oldest method, the pinhole.
2. Dallmeyer's *Patent Portrait* lens (1866) which was a sharp lens with a moveable glass element which altered the correction but introducing spherical aberration.
3. Watzek's single meniscus (c. 1891) rife with both spherical and chromatic aberrations. When used at small apertures (for example, f/11 or more), the spherical aberration diminished but the chromatic aberration remained constant.
4. *Dallmeyer-Bergheim* (1896) which used two elements, neither corrected separately nor as a pair corrected, with variable separation which both changed the focal

⁸⁷ Kühn 1926, p. 63.

⁸⁸ For an in-depth account of a number of the other lenses, see Russ Young "A Brief History of Soft Focus Lenses" *The Photohistorian*, Summer, 2003, Nos. 141-142, pp. 24-36, and Young "A History of Soft Focus Lenses in Britain and America" *Photographica World*, 2003, No. 1, pp. 25-33.

length and the amount of aberrations. Unlike later soft focus lenses, it was largely dependent on chromatic aberration (rather than spherical aberration) for its effect.

5. Pinkham & Smith's *Semi-Achromatic* single combination lens (1901), dependent primarily on spherical aberration but also a limited degree of chromatic aberration for its look.

All of these methods possessed distinct disadvantages. The pinhole's image was too dim for anything but bright sunlight subjects and even then the exposure was a minute or more. It had no possibility of having application to portraiture. The 1866 Dallmeyer *Patent Portrait* certainly was a moderate lens in terms of size, weight (especially after changing to aluminum construction) and aperture (f/6) but since no major pictorialist other than Coburn was known to utilize it, there must have been difficulties that are now unknown or else its rendering of diffusion was simply considered undesirable. It is surprising that no photographer⁸⁹ (as contrasted to lens designer) in America is known to have used any of Watzek's various solutions, especially his final solution, a relatively fast meniscus lens; they were elegantly simple, inexpensive, light weight, and passed enough light to photograph live subjects.

The original version of the *Dallmeyer-Bergheim* was replete with disadvantages for the pictorialist. First was its massive size and commensurate weight which relegated it to large studio-type cameras (as Day noted, he was the very first person to use it out of the studio). It also was a relatively 'slow' lens, passing relatively light, operating at a maximum aperture of f/9 to f/15 depending on the focal length, making indoor studio

⁸⁹ The exception was Karl Struss. His Struss Pictorial lens was almost precisely Watzek's design. Struss read German and it is tantalizing to wonder if he read any of Watzek's experiments in the various German and Austrian photographic journals. Since Struss lived in New York at the time, might Struss have read copies in the possession of Alfred Stieglitz, who was fluent in German and likely subscribed to German and Austrian photo-club journals?

exposures uncomfortably long for the subjects. As the focal length was changed, the aperture also changed; the photographer needed a chart to determine the actual working aperture for a given focal length. Last, but certainly not least, the visual and chemical focus did not coincide, as Evans complained, causing his results to be uncertain.

The Pinkham and Smith *Semi-Achromatic* removed many of the impediments of these prior solutions. They were relatively small and light weight, being made of aluminum. Their maximum aperture of f/6 made them useful indoors⁹⁰ and outdoors as well. However, as Day noted, at least the early models were very inconsistent, to the degree that “for a time it was quite possible for one interested in the matter to distinguish the author of one print from another providing the ownership of the various lenses put out were known.”⁹¹

The *Semi-Achromatic* can be considered the first soft focus lens manufactured for the purpose of artistic photography, the 1866 Dallmeyer *Patent Portrait* having been designed for in-studio commercial portraiture. Especially in the United States, it became the bench mark to which all newer designs would be compared. The design was clearly the antecedent for the *Port-Land* soft focus lens, used by Ansel Adams, among others, and the last major American large format soft focus lens made by Kodak (in production until circa 1965). Smith may or may not have been a brilliant optical designer but he knew how to modify existing designs for the requirements of the revolutionary pictorialists.

⁹⁰ Witness Clarence White’s domestic images, all made with poor indoor light sourced from windows. Most, if not all, of this series were made with a *Semi-Achromatic* lens.

⁹¹ Day’s letter dated 8 July 1921 p. 8

L E N S E S
for
Artistic Workers

WE MAKE a special line of Semi-achromatic Photographic Objectives which, when properly used, produce the most artistic results. Our products are endorsed by the leading artistic workers in photography.

Two sizes kept in stock.
 Price, 6 1/2 x 8 1/2 or 8 x 10, \$20.
 Other sizes and special lenses made to order.

PINKHAM & SMITH
Opticians and Photographic Supplies
 288 Boylston St., Boston, Mass.

Figure 4.10: The first Pinkham & Smith advertisement to appear in *Camera Work*. Note the emphasis on ‘artistic’ which is mentioned three times. (*Camera Work* № 5 January 1904 unpaginated advertisement section)

Before the discussion of the further evolution or the application of soft focus lenses can be considered, a brief discussion of technical principles is needed. The following chapter will reveal the basics of optical theory and how it is applied to the soft focus lens.

Chapter Five: Principles of the Soft Focus Lens

Artists deserve the best science.¹
Mike Ware (2005)

Science tends to frighten students of the arts.²
Martin Kemp (1990)

At the dawn of the twentieth century, lens designers were still exploring the new horizons made possible by the broader selection of optical glasses produced in Germany for the previous fifteen years. Pre-computer mathematical computation capability was combined with empirical methodologies to produce some of the most important lenses in the history of photography. The new glasses from Germany allowed designers much more freedom and there was a definite revolution in the air. This proliferation not only included benchmark lens such as the *Cooke Triplet*, *Dagor*, *Protar* and *Tessar* but also the blooming of soft focus design. Although plastics are in wide use for lenses in the 21st century, at the turn of the twentieth century all lenses were made of glass.

Lenses are a mass of glass contained by two surfaces, either both spherical or a spherical and a planar (flat) surface, the spherical curve a result of the manner of grinding the glass.³ There are six types of lens elements, three are positive lenses and three are negative lenses. Positive lenses, also called converging lenses, form images on a surface; negative lenses, also called diverging lenses, do not form images but are used in

¹ Mike Ware “An Essay Book Review: Platinum & Palladium Printing, Second Edition” *Platinum Metals Review* Volume 49, Issue 4, October 2005, p.195.

² Martin Kemp, *The Science of Art* (London: Yale University Press), 1990, p. 2.

³ Some lenses made after circa 1975 are cast plastic and because they are molded rather than ground, they may easily possess aspherical rather than spherical surfaces.

conjunction with positive lenses. The three forms of positive lens include: double convex (also termed “biconvex”), plano-convex and positive meniscus.

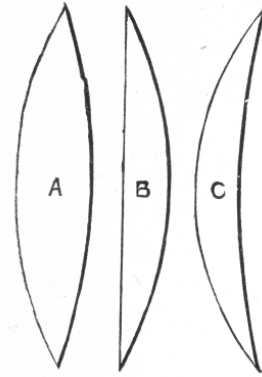

Figure 5.1: Positive lenses. (A) double convex (B) plano-convex (C) positive meniscus (Paul N. Hasluck *The Book of Photography* p. 31)

Aberrations

An image formed by a simple lens does not conform completely to the model of a perfect lens; these departures from theory are termed aberrations and can only be eliminated or minimized by a multiple lens system. Most types of lens aberrations reduce the definition of a lens; as a result, the history of optics is a search to develop methods to minimize them, unless, that is, the lens in question is a soft focus lens. In any time period, the design of soft focus lenses contravenes standard optical design principles which dictate the elimination (or minimization) of aberrations.

L. von Seidel (1821-1896) investigated image formation during the 1850s and identified seven so-called primary aberrations of lenses.⁴ These aberrations are: spherical aberration, coma, astigmatism, distortion, field curvature and chromatic aberration.

⁴ Rudolph Kingslake *A History of the Photographic Lens* (Boston: Academic Press, 1989) p.4.

Although his finding was a major aid to lens designers, even important twentieth century lens designers like H. Dennis Taylor (England, 1862-1943), inventor of the Cooke triplet,⁵ one of the benchmark lenses of photography, “made only partial use of theory, and he would often adjust a new lens in the workshop until the best image was obtained.”⁶ Thus, well into the modern era, the mathematics of optics was not rigorously applied by designers, and the execution of some lens designs was more a matter of experience by the designer rather than scientific computation.

Compared to a typical photographic lens, soft focus lenses have certain unique properties: 1) highlights glow, 2) the apparent depth-of-field is greatly expanded, 3) the details are reduced, 4) the diffusion is even across the useful field, 5) the out of focus areas are pleasingly rendered and possibly 6) high flare level. In addition, soft focus lenses should possess two characteristics shared with high quality normal lenses: good *bokeh* and smooth tonal transitions. Soft focus lenses depend on two particular optical aberrations for these characteristics: spherical and chromatic, and may also possess other aberrations such as coma and astigmatism which add nothing to the desired qualities of a soft focus lens except increasing the apparent depth of field.

Spherical aberration is caused by light rays passing through the edge of a lens (“marginal”) coming to a focus nearer the lens than the light rays passing through the center (“axial”) of the lens. Figure 6.1 illustrates the concept. Note that if a diaphragm is placed in front of the lens (or an existing aperture is closed down) so that the axial rays are cut off, the equivalent focal length of the lens increases, thereby moving the point of best focus. Denominated “traveling focus” or “focus shift,” it is a very irritating aspect of

⁵ British patent 22,607, 1893. This was the near the beginning of his career.

⁶ Rudolph Kingslake *A History of the Photographic Lens* (Boston: Academic Press, 1989) p.3.

any lens with spherical aberration, soft focus or not,⁷ and requires the photographer to focus at the precise aperture at which the exposure will be made. Spherical aberration increases with focal length and aperture. It also increases as a lens is focused closer, a consideration for portrait lenses.⁸

Figure 5.2: Spherical Aberration showing that light rays passing through the edge of the lens come to a different focal point than those passing through the center (Rudolph Kingslake, *Lenses in Photography*, p. 29).

In a simple one element lens, spherical aberration is reduced considerably as the aperture is reduced; thus a lens with severe aberration at f/4 will have it well controlled by f/16. The change is dramatic since the spherical aberration varies with the cube of the aperture diameter.⁹ This principle was known long before the invention of photography and was discovered by Dr. William Hyde Wollaston, FRS, by 1812 (see further below).¹⁰

⁷ Many lenses designed before World War I exhibit noticeable spherical aberration at their larger apertures, even if designed as sharp lenses (see Ronald B. J. Wisner, "Large-Format Lens Testing, Part III: Focus Shift/Spherical Aberration" *View Camera Magazine* Sep/Oct 1989 pp. 26-28, 53).

⁸ Sidney Ray *The Photographic Lens* 2nd ed. (Oxford: Focal Press, 1992) p. 48.

⁹ *L.P. Clerc's Photography: Theory and Practice* revised by L. A. Mannheim, D. A. Spencer ed. (London: Focal Press, 1970) p. 80.

¹⁰ Josef Maria Eder trans. Edward Epstean *History of Photography* (New York: Dover Editions, 1978) republication of 1945 text (New York: Columbia University) p. 757.

Wollaston's system operated at f/14, trading off the dimness of the image against the lack of spherical aberration and producing a relatively flat field.¹¹

Another way to control the spherical aberration is to change the radii of curvature of the lens; with a simple meniscus or biconvex lens, a 1:1.6 ratio of front curve to rear curve minimizes the spherical aberration.¹² Spherical aberration is at its maximum with a positive meniscus lens and minimized with a biconvex lens.¹³ However, the meniscus will exhibit far less coma, a defect which contributes nothing positive but only negative towards the image appearance.¹⁴

“A point affected by spherical aberration features a bright central spot surrounded by a less-intense halo. The halo diffuses the image, giving a kind of softness that is pleasantly attractive and flattering in portraiture. At the same time, the small central spot gives fairly good image resolution. The effect is that of having a detailed image overlaid with one of soft, ethereal quality.”¹⁵ This produces the “luminous brilliance”¹⁶ yielding softly glowing highlights which are the trademark of soft focus lenses. This principle is illustrated graphically by Figure 6.2. In reality, the effect is neither so pronounced nor so well defined for the halo is diffuse, overlaying the sharper core image. The extent of the halo depends on the amount of spherical aberration designed into the lens as well as the actual aperture (closing down the aperture progressively eliminates the marginal rays).

¹¹ Sidney Ray “The Era of the Anastigmatic Lens” *Technology and Art, the birth and early years of photography* (Bath: The Royal Photographic Society Historical Group, 1990) p. 70.

¹² Sidney Ray “The Era of the Anastigmatic Lens” *Technology and Art, the birth and early years of photography* (Bath: The Royal Photographic Society Historical Group, 1990) p. 70.

¹³ *L.P. Clerc's Photography: Theory and Practice* revised by L. A. Mannheim, D. A. Spencer ed. (London: Focal Press, 1970) p. 71.

¹⁴ *L.P. Clerc's Photography: Theory and Practice* revised by L. A. Mannheim, D. A. Spencer ed. (London: Focal Press, 1970) p. 74.

¹⁵ John B. Williams *Image Clarity: High Resolution Photography* (Boston: Focal Press, 1990) pp. 113-114.

¹⁶ Heinrich Kühn trans. Rudolf Wolf “Rodestock Imagon, Plastic Depth Lens Sees Like the Artist's Eye” a tri-fold brochure (Munich: Optical Works G. Rodestock, date unknown but probably circa 1940) p.3.

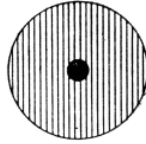

FIG. 23.—
Image of a
point source
when spher-
ical aberr-
ation is pres-
ent.

Figure 5.3: Image of a point source when spherical aberration is present showing the sharp core with the halo radiating outwards (Henney and Dudley, *Handbook of Photography* 1939, p.29).

The highlight ‘glow’ depends upon the placement along the acceptable band of focus and the exposure/development of the film. Technically, focus is achieved at any point between “A” and “C”. At “A” the marginal rays come to best focus; at “C” the axial rays come to best focus. Focusing at “C” gives the image with greatest resolution. “A” is very soft resolution and low contrast (the greatest halo spread). It was contended that “B” was the proper place to focus, where “the circle of confusion is at its smallest and the true soft-focus quality of image definition is secured.”¹⁷ This is the geometrically best position with the lens wide open but as it is closed to a smaller aperture, “C” becomes the best focus.¹⁸ However, there are valid reasons to not choose either “B” or “C” (as will be discussed in “The Practice of Soft Focus”).

¹⁷ John Tennant *The Photo Miniature* “Soft Focus Effects in Photography” Vol. XVI No. 184 December 1921 p. 162.

¹⁸ www.vanwalree.com entry for “spherical aberration”

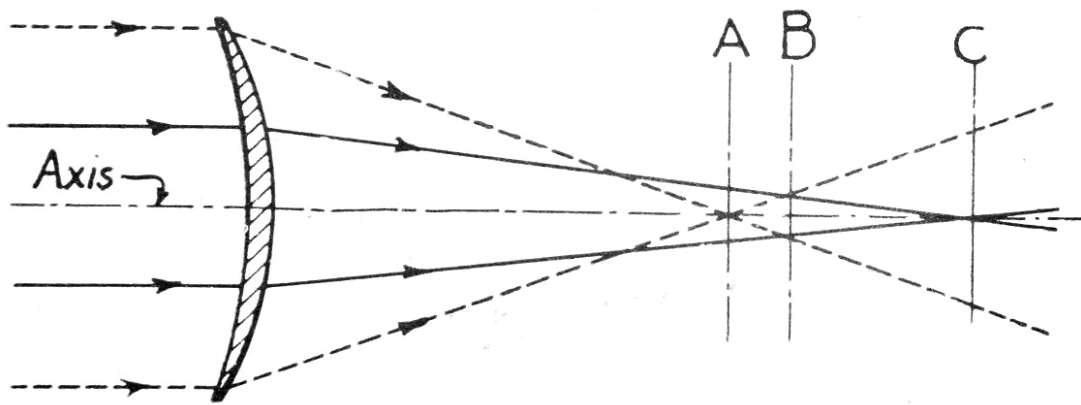

Figure 5.4: Illustration of spherical aberration showing the band of focus, A to C (*The Photo Miniature* “Soft Focus Effects in Photography” Vol. XVI No. 184 December, 1921 p. 160).

Another of Siedel’s aberrations is coma. This is related to spherical aberration as it is caused by light rays from different areas of the lens coming to focus at different distances from the axis, rather than being precisely superimposed. Coma is considered as spherical aberration of the oblique rays.¹⁹ The effect on the image is one where light is smeared into the tear-drop shape of a comet. Because it is manifested most visibly in the highlights and catch-lights, it is particularly obnoxious.²⁰ It becomes more severe as distance from the image center increases. Like spherical aberration, it is decreased by stopping down the aperture. There is also a design method to minimize coma in a simple lens (like many of the early soft focus lenses and their cousins, landscape lenses): place a stop in front of the lens so that it mechanically restricts the area of the lens that can be struck by oblique rays; once more the application of Wollaston’s discovery of 1812 proves useful.

¹⁹ C. B. Neblette *Photography, Its Principles and Practice* 4th ed. (Toronto: D. Van Nostrand Company, Inc. 1949) p. 79.

²⁰ Sidney Ray *The Photographic Lens* 2nd ed. (Oxford: Focal Press, 1992) p. 50.

Astigmatism is another aberration and is considered an “oblique aberration” like coma because it only affects the edges of the image. Before the introduction of the new Jena glasses in the 1880s, it was very troublesome to designers and photographers; it could be controlled but at the cost of producing a curved field. It is somewhat aperture dependent and although it could be very well corrected in normal lenses, soft focus lenses were usually several stops faster and therefore more subject to astigmatism. It can only be corrected by either three or more separated lenses or if the lenses are cemented, four or more lenses of different glass types.²¹ A lens which is corrected for astigmatism is termed an anastigmat.

Curvature of field means the place of best focus is not a flat plane parallel to the lens but instead a curved (actually spherical) surface, usually concave to the lens. This causes an image that is sharp in the center to be less and less sharp towards the margins. All simple lenses project a curved field. Stopping down the aperture increases the depth of focus and somewhat mitigates the issue although it does nothing to actually flatten the field. As Wollaston discovered in 1812, by turning the concave surface of the meniscus towards the subject and placing the aperture in the optimal position in front of the lens, even a meniscus can produce a reasonably flat field with controlled spherical aberration.²² There is also a severe compromise to limit curvilinear distortion: reduce the field to a small angle. Some very long lasting designs such as Dallmeyer’s Rapid

²¹ *L.P. Clerc’s Photography: Theory and Practice* revised by L. A. Mannheim, D. A. Spencer ed. (London: Focal Press, 1970) p. 74.

²² Sidney Ray “The Era of the Anastigmatic Lens” *Technology and Art, the birth and early years of photography* (Bath: The Royal Photographic Society Historical Group, 1990) p. 72.

Rectilinear (as used by Julia Margaret Cameron, for instance) have severe curvature.²³

Anastigmats have much less field curvature than a simple lens.²⁴

Curvilinear distortion is another aberration of simple lenses. The visual result is that a square will have the sides bowed inwards (barrel distortion) or outward (pincushion distortion). This aberration does not affect the sharpness of the lens nor is it controllable by stopping the lens down. However, the position of the stop controls whether it is barrel (the lens placed behind the aperture) or in pincushion (the lens placed in front of the aperture). Designing a lens with exactly symmetrical components with the aperture precisely centered in between will cancel this aberration; an early example of this is Dallmeyer's 1866 Rapid Rectilinear (rectilinear means the distortion is zero). While this distortion is a significant problem for those photographing anything with straight lines such as architecture, it is of relatively little concern to portrait photographers and those working in the landscape.

The final Seidel aberration, and one crucial to the proper design of the soft focus lens, is chromatic; there are two forms of chromatic aberration, axial (also termed longitudinal) and lateral (also termed transverse). With any lens the shortest wavelengths (violet-blue), being refracted to the greater degree, will focus closer to the lens than the longer (red) wavelengths; this is axial chromatic aberration. This was a particular focusing problem for "ordinary" (ultra-violet and blue sensitive) and "orthochromatic" (blue and green sensitive film) where the best focus to the human eye (in the yellow-green) did not coincide with the chemical focus (the sensitive portion, blue or blue-green

²³ Sidney Ray *The Photographic Lens* 2nd ed. (Oxford: Focal Press, 1992) p. 52.

²⁴ *L.P. Clerc's Photography: Theory and Practice* revised by L. A. Mannheim, D. A. Spencer ed. (London: Focal Press, 1970) p. 76. Another solution, often employed in inexpensive roll film cameras such as the Agfa Clack, is to curve the film plane to conform with the image plane.

as stated). Axial (longitudinal) chromatic aberration reduces the sharpness of the image and leads to a circle around a light point (see Fig. 6.6). It has been suggested that axial chromatic aberration in combination with spherical aberration controls the *bokeh* of a lens (see below).²⁵

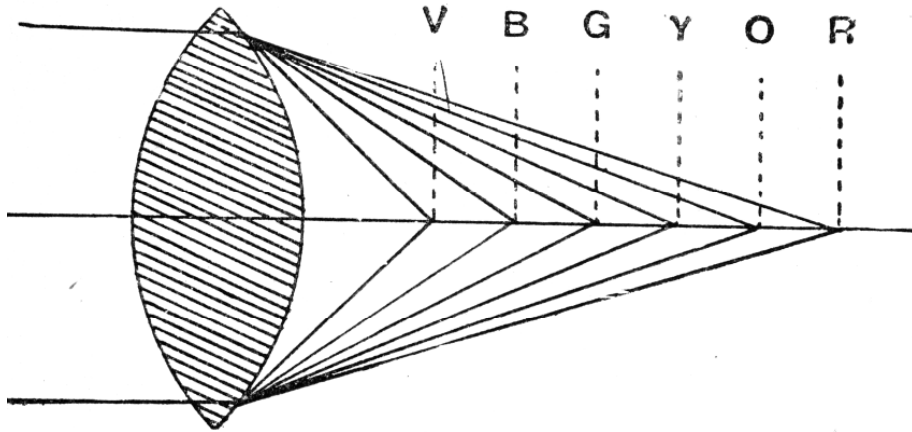

Figure 5:5: Chromatic aberration showing differing focus by color; this is exaggerated for sake of clarity. (Paul N. Hasluck, *The Handbook of Photography* 1905 p. 355)

As John Dolland (England, 1706-1761) discovered in 1757, a two-element, single group lens made of two different refractive indexes forms an achromatic doublet where the chromatic aberrations of each element cancel each other; then two given colors will come to a single focus, solving axial chromatic aberration. Lacking the mathematics (he was a silk weaver by trade), he corrected the lenses by empirical tests.²⁶ With early lenses intended for ordinary plates, the correction was for the F (blue, 486 nm.) and G¹ (violet, 434 nm.) or k (ultraviolet, 393 nm.) Fraunhofer lines; as orthochromatic plates came into common use, the correction had to be changed to the d (yellow, 466 nm.) and G¹ lines.

²⁵ www.vanwalree.com entry for “chromatic aberration” samples.

²⁶ Josef Maria Eder trans. Edward Epstean *History of Photography* (New York: Dover Editions, 1978) republication of 1945 text (New York: Columbia University) p. 251.

When panchromatic films were introduced in 1906²⁷, correction was made for the C (red, 656 nm.) and F lines,²⁸ the useful range of modern panchromatic emulsions.²⁹ Thus when a lens is encountered marked as “achromatic,” the period of design must be known to properly comprehend the corrections. Late period soft focus lenses such as the Kodak Portrait Lens claimed to be “highly corrected for chromatic aberration,”³⁰ although they do not specify whether this is axial, lateral or both. Axial aberration serves to increase the apparent depth of field.³¹

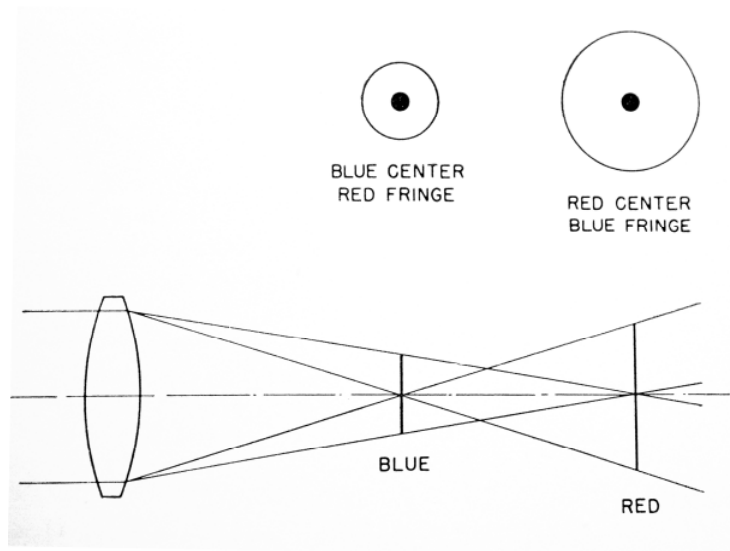

Figure 5:6: Longitudinal chromatic aberration (C. B. Neblette *Lens Manual* p. 49)

Lateral (transverse) chromatic aberration appears in an image as color fringes, often violet-blue, near the edges of the image. It is especially obvious with a white subject against a dark background. Axial (longitudinal) refers to the distance from the lens; lateral concerns the size of the image, blue forming a larger image than red. Of all

²⁷ Ralph E. Jacobson *The Manual of Photography* Seventh Edition (Boston: Focal Press, 1983) p. 240.

²⁸ Sidney Ray *The Photographic Lens* 2nd ed. (Oxford: Focal Press, 1992) p. 54.

²⁹ *L.P. Clerc's Photography: Theory and Practice* revised by L. A. Mannheim, D. A. Spencer ed. (London: Focal Press, 1970) p. 69.

³⁰ *Kodak Camera Technique for Professional Photographers* (Rochester: Eastman Kodak Company, 1952) p. 19.

³¹ Rudolph Kingslake *A History of the Photographic Lens* (San Diego: Academic Press, 1989) p. 187.

of the aberrations, it is the most difficult to reduce or correct, and is not reduced by closing the aperture of the lens. It also becomes worse with focal length, therefore becoming a major problem for large format photographers who require long focal lengths. Often manifested in cheap binoculars, it remains a persistent problem for modern digital point-and-shoot cameras.³²

Bergheim believed that chromatic aberration produced the proper soft focus image. The Dallmeyer-Bergheim lens, operating at a maximum aperture of f/9 displayed more lateral chromatic aberration than the later soft focus lenses working at f/4 or f/5.6; this is a basic weakness of all telephoto designs.³³ As the syntax of film moved from orthochromatic to panchromatic and then to color, lenses based on chromatic aberration became undesirable. Axial chromatic aberration also makes a lens difficult to use; in respect of this, it is appropriate to recall Evans' comments about the 'accidental' nature of his good photographs with this lens. Before panchromatic film, this aberration would cause the eye's choice of best focus to not coincide with the ordinary and orthochromatic films. Because the Bergheim was uncorrected for both spherical and chromatic aberrations, the image it yielded produced "extremely soft definition" even by the standards of the time,³⁴ but since Bergheim's design criterion was to produce a lens that created an image with the diffusion of a pinhole,³⁵ Dallmeyer's design performed admirably. Since chromatic aberration is not affected by closing down the aperture, the ratio of spherical-to-chromatic aberration changed at each aperture setting, with the chromatic aberration always being present. Thus the image will be soft at every aperture

³² www.vanwalree.com entry for "chromatic aberrations" purple fringing: lens or sensor?

³³ www.vanwalree.com entry for "chromatic aberrations."

³⁴ Sir W. de W. *Abney Instruction in Photography* 11th ed. (London: Illiffe & Sons, Ltd., 1905) p. 130.

³⁵ Heinrich Kühn *Zur Photographischen Technik* p. 53.

due to the chromatic aberration but the degree of 'sparkle' in the highlights, attributable to the spherical under-correction, will diminish as the aperture is reduced.

As early as 1908, Steichen had realized that “a lens slightly uncorrected for spherical aberration, but corrected for chromatic aberration like the 'Smith' Lens, gives the most satisfactory results.”³⁶ Chromatic aberration, if present, had to be severely curtailed in order to produce a pleasing visual result.

Heinrich Kühn also recognized this basic principle: “An objective uncorrected for spherical aberration alone produces a picture the impression of which is too soft and 'sweet.' Uncorrected chromatic aberration produced unclearness without softening down the contrasts. What is necessary is to adjust both 'defects' in order to obtain the desired effect.”³⁷ With rare exceptions of single element lenses such as the Struss Pictorial lens, this formed the basic principle for all soft focus lenses from the Pinkham & Smith Semi-Achromatic (1902) until the present time. The skill is in determining the correct amount of spherical under-correction and the balanced degree of chromatic aberration.

One of the characteristics of a soft focus lens, extended depth of field, is a function of aberrations in the lens. “Spherical aberration, chromatic aberration, field curvature, and astigmatism all cause a longitudinal displacement of the best image from the paraxial focal plane, and thus the depth of field may be aided for objects situated closer than the focused plane and reduced for objects lying beyond the focused plane, or vice versa.”³⁸ Chromatic aberration results in a distinct unsharpness causing the image to

³⁶ Edward Steichen “Color Photography” *Camera Work* No. 22 April, 1908, cited in “Semi-Achromatic Lenses” (a Pinkham & Smith sales brochure) (Boston: Pinkham & Smith Co., c. 1912) unpaginated.

³⁷ Heinrich Kühn “On Soft Focus Objectives” *The German Annual of Photography 1928/29* (Berlin: Robert & Bruno Schultz, 1928) unpaginated

³⁸ Rudolph Kingslake *Lenses in Photography* rev. ed. (New York: A. S. Barnes & Co., 1963) p. 94.

appear “soft, rounded, of a slight unsharpness, small details are subdued.”³⁹ Spherical aberration creates a sharp image core surrounded by a luminous halo, creating the other defining characteristic of the soft focus image, glowing highlights that preserve a sense of shimmering light.

The critical function of spherical aberration in producing pleasing diffusion results in the need for different lens curvatures for different focal lengths as “the degree of spherical aberration is not at all the same with different focal lengths.”⁴⁰ It must be assumed that smaller negatives will be enlarged and larger negatives contact printed; the diffusion of lenses for smaller negative formats must therefore be ‘sharper’ since the diffusion will be increased proportionately to the degree of enlargement.

Aberrations may be categorized as direct errors and oblique errors. Direct errors affect the entire field of the image; spherical and axial chromatic aberrations are the two direct errors and are the only two aberrations present in the center of the field. Oblique errors are never present in the center of the lens field but only toward the margins; lateral color, coma, astigmatism, distortion and curvature of field are all oblique errors. An evenly diffused field is a key requisite for soft focus lenses thus the oblique aberrations must either be well controlled or the usable image circle small enough to exclude them. In practice most soft focus lenses have fields limited to 40 degrees or less as the solution.

Coma and transverse (or lateral) chromatic aberrations are independent of aperture.⁴¹ Astigmatism and field curvature are reduced at smaller apertures. Spherical and axial (or longitudinal) chromatic aberrations are altered by the aperture although the

³⁹ Heinrich Kühn *Zur Photographischen Technik* p. 76.

⁴⁰ Heinrich Kühn *Zur Photographischen Technik* p. 63.

⁴¹ It can be very difficult to ascribe image degradation to specifically coma, field curvature or astigmatism. See www.vanwalree.com “astigmatism in practice.”

limited range of useful apertures of a soft focus lens are inadequate to visibly change the axial chromatic aberration. The photographer then has the ability to modify the extent of spherical and axial chromatic aberrations by choice of lens aperture; the other aberrations are fixed by the lens design and construction.

Flare

Lenses may possess generally undesirable characteristics other than aberrations, for instance, flare, which is a slight fog over the whole image caused by non-image-forming light striking the film. Although widely neglected, flare may degrade an image more than all of the other aberrations and therefore is an important variable.⁴² A proper lens hood on a modern, single coated lens can realize an increase in contrast of ½ to a full grade of contrast;⁴³ the gain would be markedly greater with a period uncoated lens.

Flare is light which has passed through the lens but been scattered within the camera system: within the lens (from the surfaces of the glass, the diaphragm, the rims of the lenses, the barrel interior), the bellows, off the film surface, etc. Sources from within the lens itself include reflections from each of the glass surfaces and the interior of the lens barrel. The more glass surfaces, the greater the internal reflections. If the barrel interior and the edges of the lenses are not a dead black, they will cause flare. This is a special problem for soft focus lenses given the large front element necessary to produce a fast lens. For instance, the Graf Variable lens that Edward Weston used first in his California studio and took to Mexico has a front glass element that is 85 mm. in diameter, a potential cause of substantial flare, especially where there are large areas of brightness

⁴² www.vanwalree.com entry for “flare.”

⁴³ Robert Zeichner “Can Better Shades Improve Lens Performance?” *Photo-Techniques* March-April 2007, p. 34.

such as white painted buildings and light dirt streets. Once the light has become scattered within the lens it then reflects from surfaces within the camera or directly on the film.



Figure 5.7: Two reflections of the same light source on an uncoated magnifying glass lens. One reflection is from the front surface, the other from the rear surface of the glass. This would produce substantial flare if the lens was used to project an image under these lighting conditions (photograph by the author).

Flare within a view camera is caused by the cone of light from the lens projecting a far greater planar area than the film covers even if it is just enough to cover the format. For instance, with an 8x10 inch negative, the negative is 80 square inches in surface. If the lens (regardless of focal length) just covers the 12.8 inch diagonal of that negative, the cone of light forms a circle of 128 square inches. Thus there are 48 square inches of light not striking the film but reflecting from the interior bellows surface. This is a best case scenario; if the lens creates a large enough cone of light to allow for the front standard to be raised two inches (the diagonal now becomes 19.8 inches) the projected cone must cover 310 square inches, more than three times the area of the negative.

Additionally, many view camera lenses produce a circle of illumination larger than the circle of good definition, the usable area; the 'excess' is not within the quality standards due to aberrations or light fall-off. The *Petzval* is an excellent example as it only has a usable field of 20-25 degrees but throws a very large cone of light, all of which becomes flare within the bellows and camera body. This is true of most vintage soft focus lens designs.

The bellows themselves can be a source of flare; both Edward Weston and Ansel Adams had this problem with their 8x10 cameras.⁴⁴ The only solution for this is to use a larger bellows, i.e., a 4x5 back on a 5x7 camera, a 5x7 back on an 8x10 camera, etc. This was easily achieved by a studio photographer who could afford to use a huge camera on a rolling camera stand but far more difficult to implement when on location with a field camera and light weight tripod.

Flare is also caused by high luminance range subjects⁴⁵ and this was a major source of Weston's flare problem in Mexico. For the landscape photographer examples would include snow scenes or large areas of white clouds. Portrait photographers in the studio, even with carefully controlled light, had to contend with high key portraits, white dresses and shirt fronts, etc., which were difficult to cope with using uncoated soft focus lenses.

Flare is also the result of dust or fingerprints on or in the lens, scratches on the lens surface (caused by improper cleaning). Especially for photographers working outdoors, bright areas not in the composition itself but off axis are a primary source of flare. Consider a specular reflection from a shop window just outside of the field of view,

⁴⁴ Ansel Adams *Camera and Lens* (Boston: New York Graphic Society, 1970) p. 52.

⁴⁵ Ralph E. Jacobson *The Manual of Photography* Seventh Edition (Boston: Focal Press, 1983) p. 101.

for instance, or the sun itself, where the light strikes the front surface of the lens but it is not in the compositional field. The only solution here is a lens hood.

The two remedies for flare are a proper lens hood and a coated lens. Flare was greatly diminished by coating lenses, J. Traill Taylor's 1892 idea, but it required years to properly execute; the practical application did not begin until 1935⁴⁶ and was not widespread until after World War II. Coating is achieved by depositing a very thin and carefully controlled film of magnesium fluoride on the lens surfaces. In practice, however, many lenses were still not coated until the late 1940s. These early coatings were soft and could be removed by zealous cleaning of the lens. Although a single date cannot be established, hard coatings appear to be a post World War II development.

A solution to flare that was readily available in the main pictorialist period was the lens hood (or shade as it is sometimes denominated). Nearly all early brass lenses were sold with a lens hood but this practice gradually vanished around the turn of the century, much to the detriment of photographers. Some of the early soft focus lenses (Semi-Achromatic, Port-Land, Struss Pictorial) required the aperture to be placed in front of the lens; this acted as a very efficient lens shade. Struss added the further refinement of a velvet lined barrel such that internal reflections were greatly diminished.⁴⁷ Because the early Pictorialists photographed against the light with such regularity,⁴⁸ the importance of this high quality lens shade is difficult to over emphasize.

⁴⁶ *L.P. Clerc's Photography: Theory and Practice* revised by L. A. Mannheim, D. A. Spencer ed. (London: Focal Press, 1970) p. 683.

⁴⁷ Karl Struss *SPL* (a brochure for the Struss Pictorial lens) (Morristown, NJ: Frederick W. Keasbey, no date, c. 1920) p. 16.

⁴⁸ Mr. Libby's endorsement of the Struss Pictorial Lens in Karl Struss *SPL* (a brochure for the Struss Pictorial lens) (Morristown, NJ: Frederick W. Keasbey, no date, c. 1920) p. 7.

There were simple solutions for the studio based practitioner which were too large, heavy or clumsy for the landscape photographer. To be optimally effective the hood had to not only be held mechanically on the front of the lens but it had to cut out all stray light and at the same time not cut into the field of view which would vignette the image. An undersized hood will help in any case but still admit non-image light. Thus for the optimal solution, a photographer needed to purchase a dedicated hood for each lens. Then as now, the use of a lens hood often marks the practice of the professional photographer, and is rarely utilized by the amateur.

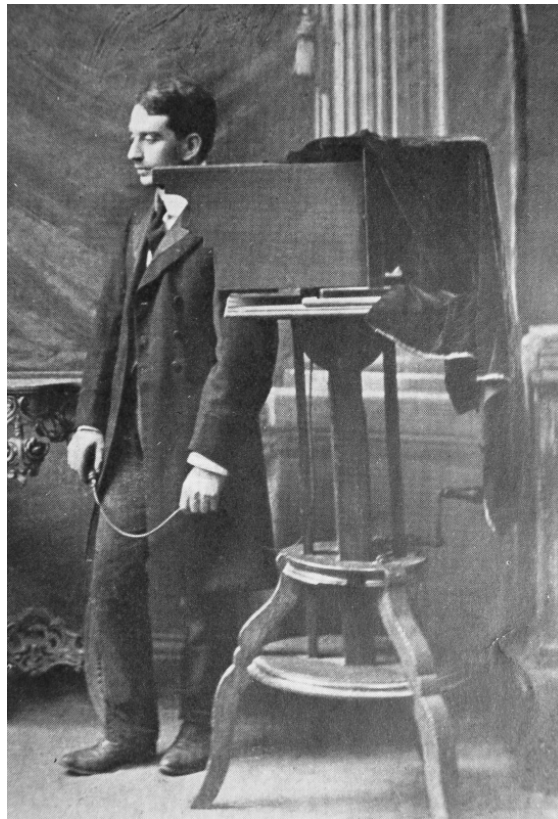

Figure 5.8: An elaborate and undoubtedly highly efficient rectangular form lens hood on a studio camera, detail from a larger image (Paul N. Hasluck *The Book of Photography* p.493).

There are flare sources which cannot be altered given a particular lens. “Another source of flare light is the spreading of light caused by inadequate correction of the lens for coma, spherical aberration, or astigmatism.”⁴⁹ Therefore the soft focus lens with its reliance on spherical aberration will inherently have flare and this is perhaps the single most basic visual attribute of soft focus- the glowing highlights.

Flare is not always a negative aspect of a lens and in fact much of the ‘look’ of older soft focus lenses depends on it. First, it “degrades image clarity by reducing contrast, which reduces the visibility of fine features and lowers resolving power.”⁵⁰ Second, it “lowers negative contrast, especially shadow contrast, and increase shadow density.”⁵¹ Third, it may enhance the tonal smoothness of the image.⁵² Recent (post 1970) lenses incorporating highly efficient coatings and other flare-reducing methodologies often lack some of the positive qualities seen in the earlier lenses; they possess similar qualities of diffusion but without the trade mark highlight glow.

⁴⁹ Allen R. Greenleaf *Photographic Optics* (New York: The MacMillan Company, 1950) p. 53.

⁵⁰ John B. Williams *Image Clarity: High Resolution Photography* (Boston: Focal Press, 1980) p. 118.

⁵¹ Phil Davis *Beyond the Zone System* 4th ed. (Boston: Focal Press, 1999) p. 47.

⁵² Ansel Adams *Camera and Lens* (Boston: New York Graphic Society, 1970) p.15.



Figure 5.9: Gundlach *Achromatic Meniscus 6 inch f/6* ca. 1920 on a 4x5 negative reproduced 100% size, a relatively high flare soft focus lens and a very agreeable softness. Photograph by the author.



Figure 5.10: Fujinon *SF* 250 mm *f*/5.6 ca. 1985, on a 5x7 negative reproduced 100% size. Compared to the Gundlach lens, it has much less flare and is somewhat firmer, both characteristics of post-1970 soft focus lenses. Like most post-1970 lenses, it lacks the ‘sparkle’ of the pre-1930 lenses. Photograph by the author.

Lens Coverage

The lens coverage (or field) is defined as the cone of illumination produced by a lens as per the manufacturer's specifications. The actual cone of light may be greater than the specification but because Siedel's aberrations are not well corrected outside of the cone, that area of illumination is unusable; thus the usable area is also termed the "circle of good definition" in contrast to the "circle of illumination." The size of the cone is controlled by the lens design itself and whether the mechanical elements of the lens assembly will vignette the cone; some modern lenses are constructed such that the specified cone is controlled by the mechanical vignetting thus preventing the lens from being used for a larger format than its design criteria specify. The use of too long a lens hood will also vignette the image; this was rarely an issue in the period under discussion as most soft focus lenses of that time were of longer than normal focal length and therefore required a long hood.

Figure 5.11: Graphic demonstration of the distinction between the circle of illumination and the circle of good definition, showing the excess area of light (Kodak *Large Format Photography* 1998 p. 37)

The coverage can be denominated in various manners: by the angle of the cone of light, the maximum image circle created (usually in millimeters), or the maximum film format for which it is designed (the latter two are calculated for a lens focused at infinity). As the lens is focused closer than infinity, it will cover a larger film format; this is particularly relevant at portrait distances in the studio. Modern lens specifications are normally stated for a lens closed down to f/22; lenses in the late nineteenth and early twentieth century were usually specified at their maximum aperture. The cone of coverage increases rather dramatically as the lens is stopped down, therefore a lens used wide open covers a smaller negative than the same lens used at a smaller aperture. Since soft focus lenses are typically used at wide apertures, this becomes an important issue.

There is no correlation between the angle of coverage (which is behind the lens) and the angle of view which describes the view seen by the lens (in front of the lens). The “normal lens” will produce an angle of view of about 53°; any larger angle is created by a “wide angle” lens, any angle smaller is created by a telephoto lens.⁵³ With only very rare exceptions, soft focus lenses have a small angle of coverage compared to standard lenses of the same focal length; this is because the oblique aberrations become too prominent as you move away from the central axis. The implication then, is that a soft focus lens, in order to cover a given format, must be of a longer focal length than a normal lens; this was particularly true of lens designs before 1970 or so when new high refractive index glasses were used in soft focus lenses.

⁵³ L. A. Mannheim, principle technical editor, “lens” entry written by Leo H. Narody, *The Focal Encyclopedia of Photography* (New York: McGraw-Hill Book Company) revised desk edition, 1969, p. 844.

Format and Normal Focal Length Lenses For Common American & English Camera Formats⁵⁴

	<i>Film Format</i> (inches)	<i>Diagonal Length</i> (mm)	<i>Focal Length</i> (mm)
quarter-plate	3¼ x 4¼	137	135-150
	4 x 5	162	150-180
half-plate	4¾ x 6½	204	200-210
	5 x 7	219	210-240
whole-plate	6½ x 8½	272	270-300
	8 x 10	325	300-360
	10 x 12	396	400
	11 x 14	450	450-500

The amount of light striking the film is controlled by the photographer via adjusting two variables: (1) the lens aperture and (2) the shutter speed. The lens aperture is generally denominated an f/stop and is varied by a diaphragm within the lens barrel. The earliest lenses, if they possessed any aperture at all, often used a washer-shaped diaphragm which was both inconvenient and slow to change. In 1858 John Waterhouse proposed a slit in the top side of the lens barrel which would admit a flat plate with a circular perforation; this became known as the Waterhouse stop and was still common as late as the 1920s.⁵⁵ The iris diaphragm universally used in hand cameras today has less certain origins. Eder claims that Charles Chevalier presented the design in 1856;⁵⁶ if this is true, the idea lay fallow for three decades. Conrad Beck claims that his firm (R. & J. Beck) and the English lens manufacturer Lancaster and Son invented it independently in

⁵⁴ Adapted from L. C. Clerc *Photography: Theory and Practice, Vol. 1, Fundamentals: Light, Image, Optics* revised by L. A. Mannheim, D. A. Spencer ed (London: Focal Press, 1970, completely revised Edition) p. 122.

⁵⁵ *Lens Collector's Vade Mecum* (CD) entry for John Waterhouse p. 319. The Waterhouse stop is still in use in copy and reprographic lenses where a square aperture is required and thus an iris will not suffice.

⁵⁶ Josef Maria Eder *History of Photography* trans Edward Epstean (New York: Dover Publications, 1978) p. 299.

1885;⁵⁷ this is supported by the *Vade Mecum*.⁵⁸ It is certain that there were no lenses fitted with an iris diaphragm before that date and that they did not become widespread until the 1890s. Although more convenient, the iris is mechanically more complex than the Waterhouse stops and therefore was more costly; many lens manufacturers offered their customers the choice with the Waterhouse being less expensive. The Waterhouse stop is a perfect circle whereas the iris approximates a circle; the quality of the approximation is dependent on the number of leaves forming the iris, more leaves creating an opening more approaching a circle. There is one further method, of an eccentric rotating disk which is perforated with a number of apertures and aligns them sequentially in the lens central axis; for the most part, this was used on lower quality lenses.

The lens aperture must be computed within fairly small bounds in order to be useful. As early as 1860 John Dallmeyer proposed and implemented a systematic method of determining apertures such that each successive aperture admitted half as much light as the previous aperture. Nonetheless the exact designation and standardization of apertures required some amount of time passage and their history is not entirely clear. This was still in flux in the 1890s with Lancaster using a system unique to their lenses, however, the three main systems accounted for the majority of all lenses: U.S. No., f/number (also named “International Scale”) and Stolze (Germany). “U.S.” was the abbreviation for “Uniform System” and was adopted by the Photographic Society of

⁵⁷ Conrad Beck and Andrew Herbert *Photographic Lenses, a simple treatise* (Cornhill: R. & J. Beck. Ltd., 1903) p. 104.

⁵⁸ p. 118.

Great Britain in 1881.⁵⁹ It was slowly phased out in preference to the f/number system which was most widely used in America and is now the sole surviving system worldwide. The f/number system within the ranges of the soft focus lenses under discussion would be:

2.8 4 5.6 8 11 16 22 32 45 64

Note that every other number doubles. Each aperture admits 50% less light than the number before it, as John Dallmeyer proposed; for instance, f/8 passes only half of the light passed by f/5.6. In the same manner, f/8 passes one-quarter of the amount of light that is passed by f/4. Unless otherwise specified, all f/numbers used in this text will refer to the modern system, f/number, which was used by American soft focus lens manufacturers from Pinkham & Smith forward.

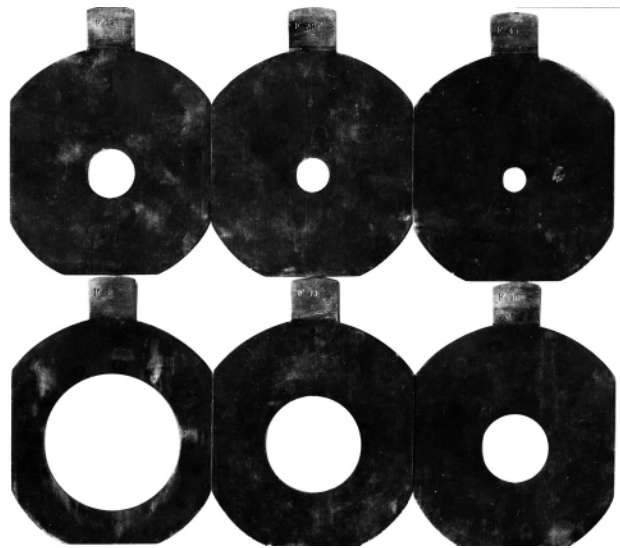

Figure 5.12: A set of Waterhouse stops (bottom row: f/8, 11, 16, top row: 22, 32, 45) for a Dallmeyer Patent Portrait 19 inch lens (collection of the author)

⁵⁹ E. J. Wall and F. J. Mortimer *The Dictionary of Photography* (Boston: American Photographic Publishing Company, 1938) p. 203. Some lens manufacturers, e.g., Zeiss, Goerz, Voigtlander, also had their own numbering system for apertures

Bokeh

To reiterate the distinctive characteristics of the soft focus lens: 1) highlights glow, 2) the apparent depth-of-field is greatly expanded, 3) the details are reduced, 4) the diffusion is even across the useful field and 5) the out of focus areas are pleasingly rendered. Through the examination of the effects of aberrations, it has been established that the first four characteristics are a function of aberrations, especially spherical and chromatic, and they serve to “soften” the image, to reduce the resolution. The fifth characteristic does not pertain to softness however, and is more elusive both to cause and effect. There is no specific English word for the phenomenon, ‘blur’ being perhaps the closest term, but is far too general. The Japanese language does contain a word which Japanese photographers have applied to the effect: *bokeh* (pronounced as ‘bouquet’). It is defined as the appearance of the out of focus regions of a photograph, anterior and posterior; this is a very subtle topic, filled with nuance and virtually unnoticed by most photographers since the 1920s. In the absence of any method of measuring or objectifying it, rather than using the descriptors “good/bad” the terms “pleasant/unpleasant” or “desirable/undesirable” are more applicable. Virtually all objective tests of lens quality measure the lens performance on a two-dimensional plane perpendicular to the lens axis whereas *bokeh* is a subjective description of lens performance in three dimensions. *Bokeh* also illustrates an important difference between optical designers and photographers. Optical mathematics would prefer that a disk of light have a sharp edged cut-off such that a tracing of the light distribution would produce

a rectangle. Photographers would prefer pleasant *bokeh* which is a Gaussian (bell curve) distribution.

It is, nonetheless, an undeniable aspect of all photographs except those made by pinhole and those created by the American 'West Coast School' widely known as 'F/64.'⁶⁰ Because a pinhole creates an image with the same degree of focus throughout, it cannot possess *bokeh*. The F/64 school utilizes small apertures and view camera movements to create adequate depth of field to encompass the entire composition, leaving no areas unsharp, sharpness and full tonality being their mantra. Hence their photographs do not possess *bokeh* either. The dominance of their *genre* in America since the 1950s has done much to exclude the practice or study of soft focus lenses. If a search is conducted on photographic discussion groups⁶¹ hosted on the internet, two world-wide discussion groups by serious, film-based photographers, threads will be found wherein the authors deny the entire concept of *bokeh* even though it is indisputable.

Author and experienced photographer Jason Schneider considers that "bokeh is all about the 'beauty of the image,' a vital concern to lens designers and photographers before computerized lens design. And it's important again today. Bokeh brings us back to the primacy of images and makes you look at pictures in a different and more discerning way."⁶² Schneider is nearly unique in recognizing *bokeh* as most American writers have ignored it entirely save for a *Photo Techniques* issue in 1997 which featured three articles on the subject, and remains the key publication in English. In Japan by contrast, "to spend time with Japanese photographers is to hear it constantly. They notice it, discuss it, and

⁶⁰ The name comes from the title of a small 1932 exhibition by a loosely knit group of dedicated central California photographers including Edward Weston, Ansel Adams, John Paul Edwards, Willard Van Dyke and others who were best described as hobbyists.

⁶¹ For example www.apug.org or www.largeformatphotography.info.

⁶² Jason Schneider "Bokeh- Splendor in the Glass" *Popular Photography* V. 69, No. 3, March 2005, p. 63.

use it as a basis to choose and use lenses. Magazine lens tests routinely include photos demonstrating it, and certain lenses become renowned for it. In Japan, in short, bokeh is often as important an element of lens evaluation as sharpness, contrast, and all other hard-edged criteria that we in the West apply to our lenses.”⁶³

The Japanese have categorized *bokeh* into a number of terms, including: two-line, ring circular (doughnut) or semi-circular, roundish, long and narrow, comet-shaped, sharp corners, point bokeh, hard or soft, complex or breaking-up losing shape, a tendency towards pretty or beautiful or clean, gentle and well-behaved, good, likeable, natural, gives a good feeling.⁶⁴ These are, for the most part, nebulous terms, especially the positive evaluations and the word therefore may be applied inconsistently among a body of photographers. They are not objectively measurable and therefore subjective description is all that is applicable. “Bokeh is essentially an aesthetic judgment, and even photographers who value it don't always agree on its finer points.”⁶⁵

There is general agreement in Japan as to whether a particular bokeh is desirable or not. The prime criteria are “smoothness and naturalness above all” whereas bad *bokeh* consists of “distracting blobs in the foreground, smeared or jumbled background shapes, choppy patterns of light and dark.”⁶⁶ It may be stated that good *bokeh* does not draw attention to itself because of its naturalness whereas bad *bokeh* is just the opposite and draws the eye to it and away from the main subject. An informed definition of good and bad *bokeh* comes from one of the most recent essays on the topic.

⁶³ John Kennerdell “What is ‘Bokeh’?” *Photo Techniques* May-June 1997 p. 29.

⁶⁴ Owen Grad “Notes on the Terminology of ‘Bokeh’” *Photo Techniques* May-June 1997 p. 34.

⁶⁵ Kennerdell “What is ‘Bokeh’?” p. 32.

⁶⁶ Kennerdell “What is ‘Bokeh’?” p. 30.

Generally, a lens with good bokeh delivers images with a smooth, natural-looking transition from in-focus to out-of-focus areas in both foreground and background, while maintaining the definitive shape of out-of-focus objects. Good bokeh draws the eye to the sharply focused subject, and separates it from the background in an aesthetically pleasing way. Especially in scenics, a lens with good bokeh gives the illusion of a more extended depth of field than actually exists.⁶⁷

Although they lacked a single, specific word for the effect, the early Pictorialists were familiar with the concept of *bokeh*. The term most frequently found to describe undesirable out of focus regions is “wooliness;” the positive descriptors involved “roundness” and “smoothness.” An advertisement for the *Verito* lens touted that it ‘shows no distortion, double lines or other optical imperfections;’⁶⁸ ‘double-line’ *bokeh*, termed *nissen-bokeh*, is specifically considered undesirable by the Japanese. It was as advanced a concept in 1900 as in 2000 and beyond the grasp of most photographers. The men and women who composed the elite ranks of Pictorialism, whether in America, Britain or on the Continent, were connoisseurs and masters of their chosen art who by dint of experimentation, reading, viewing original prints and fine reproductions (such as found in *Camera Work* and *The Studio* annual issues), and intercourse with others of the elite, conceived and practiced the art of photography at a level rarely seen in its entire history. Mastery was not only possible but social pressure required it (especially on the Continent, the camera clubs were the incubators of change and the arbiters of quality). Coburn, Day, Kühn, Stieglitz and other leading Pictorialists were born to wealth (as was Emerson) and had both the time and energy to pursue whatever caught their fancy. Their associates were poets, writers, painters, architects, decorative artists, persons who enhanced and

⁶⁷ Jason Schneider “Bokeh- Splendor in the Glass” p. 60.

⁶⁸ Wollensak, *Lenses for 1912-1913* (Rochester: Wollensak Optical Co., 1912) p. 12.

reinforced each others devotion to *arte*. Their lives were informed cosmopolitan existences, styles which were almost all terminated by World War I, never to recover.

Peter Henry Emerson warned the aspirant artistic photographer “never to focus so that it can be detected in the picture where the sharper focusing ends and the less sharp focusing begins- as can be brought about by diaphragms. The sharpness should be gradated gently “smooth, natural-looking transition from in-focus to out-of-focus areas in both foreground and background”⁶⁹ echoing Schneider’s criteria of “smooth, natural-looking transition from in-focus to out-of-focus areas in both foreground and background” very closely.

Writing in 1893, a Scottish photographer and art critic railed against photographs “made so much out of focus that the outlines are doubled, and spotty 'areas of confusion' are seen with an effect almost sickening.” This is an unequivocal description of poor *bokeh*.⁷⁰

About 1911 Coburn quoted George Bernard Shaw’s observation on *bokeh*: “You have no more of what Bernard Shaw calls one of 'the infuriating academicisms of photography,' one plane of the picture sharp and all the others wooly and unnatural, a thing that no self-respecting human eye would ever see.”⁷¹ Coburn clearly identifies the out of focus areas as “wooly and unnatural,” terms that would have meaning to almost any advanced photographer, and perfectly describes one form of bad *bokeh*. Also writing in 1911, Anderson vividly describes unpleasant bokeh as “when out-of-focus leaves and branches seem to assume unusual shapes, when the light which shines through the

⁶⁹ P. H. Emerson *Naturalistic Photography for Students of the Art*, p. 72.

⁷⁰ Andrew Pringle “The Naissance of Art in Photography” *The Studio* Vol. 1 No. 3 June, 1893 p. 92.

⁷¹ Alvin Langdon Coburn “The Question of Diffusion” *Semi-Achromatic Lenses* (Boston: Pinkham & Smith Co., circa 1911) unpaginated.

branches is converted into round bull's-eyes, the work becomes contrary to the spirit of impressionism.”⁷² The Japanese identify this as “doughnut” or “ring” *bokeh* and consider it one of the least desirable forms.

German photographers recognized one form as an “abrupt and unpleasant indistinctness of the background, the so-called wooly haze, which is caused by a reduced image of the diaphragm in the form of different sized dispersion rings on the focusing screen.”⁷³ Heinrich Kühn description of “a sort of ‘dumpling plastic’...unsharp parts of the image ending in hemispheres and shapes not far from eggs” accurately defines another type of undesirable *bokeh*.⁷⁴

The term “wooly” appears numerous times in English and German descriptions. It is an absolute certainty that pictorial photographers, beginning with Emerson, recognized *bokeh*, especially in its undesirable forms, and sought lenses which exhibited good forms. The other proof of their knowledge and application of *bokeh* is to examine their photographs; unpleasant *bokeh* is almost non-existent in Pictorial images during the 1900-1920 period.

The precise optical mechanism controlling *bokeh* has not been identified with certainty. The two contending theories involve lens aberrations and aperture shapes. One expert stated unequivocally that “an experienced telescope maker can 'read off' the aberrations of a lens (or mirror) from its bokeh,”⁷⁵ thus directly correlating *bokeh* with aberrations. Telescopes, of course, have fixed apertures which are perfectly round (as a

⁷² A. J. Anderson *The Artistic Side of Photography* (New York: Dodd, Mead and Company, 1911) pp. 234-235.

⁷³ Prof. Berthold Kihn “Interesting Facts About the Imagon” *German Annual of Photography* (Berlin: Bruno Schultz, 1936) p. 11. This is the English language edition of *Das Deutsche Lichtbild*.

⁷⁴ Heinrich Kühn *Zur Photographischen Technik* p. 64.

⁷⁵ Michael A. Covington “Letter to the Editor” *Photo Techniques* March/April 1998 p. 8. The author was then associate director of the Artificial Intelligence Center at the University of Georgia.

Waterhouse stop). An experienced photographer has observed that “lenses with more lens diaphragm blades (at least seven, but the more the better) provide a more nearly circular aperture, which yields good bokeh, particularly in out-of-focus highlights.”⁷⁶ Most of the iris-based lenses prior to World War I have a very large number of diaphragm blades, as many as 32. Why did the lens designers use such expensive diaphragms? Was it because they were aware of the correlation with good *bokeh*? There appears to be no documentation on the topic, which is not unusual as that information would have been in the category of trade secret. The author of this thesis has compared the *bokeh* from a modern lens with five blades to a period lens of almost the same focal length with 32 blades and found the difference in *bokeh* was striking, heavily favoring the larger number of blades (more approaching an exact circle). This cannot be considered definitive, however, as the lenses were of vastly different designs and glasses and perhaps that was the relevant variable. To answer the question with absolute certainty, the lenses would have to be exactly alike in every way, such that all variables are held constant changing only the iris, a very expensive proposition to implement. Further complicating any investigation is that the *bokeh* of a given lens varies with the aperture setting. Because of their more limited depth of field, longer focal length lenses demonstrate *bokeh* more evidently than shorter focal lengths. As mentioned earlier, Vanwalree believes it is the interplay of spherical and axial chromatic aberration as well as roundness of aperture. Nonetheless, if the approximation of a circle by the aperture is important, then the older lenses using Waterhouse stops with their perfectly round opening would be at an advantage over modern view camera shutters with their reduced number (compared to the first half of the twentieth century) of aperture leaves and less perfectly round opening.

⁷⁶ Jason Schneider “Bokeh- Splendor in the Glass” p. 60.

It has been recently posited that *Bokeh* can be tested in an objective manner in the studio or laboratory by examining the image of a pinpoint light source.⁷⁷ The procedure is to find the best focus then slowly move the lens such that the image is out of focus, both too close and too far. The shape of the out of focus pinpoint is directly related to the *bokeh*. Since an out of focus foreground is rarely encountered, it is the background which is examined and evaluated. If the form produced by the lens (sharp or soft) resembles a pearl,⁷⁸ with a bright core fading off slowly to the edges, and possessing a decidedly three dimensional quality, the lens possesses desirable *bokeh*. If, instead, the shape resembles a doughnut, the *bokeh* will be poor. Merklinger believes this to be a new discovery but Clerc was fully aware of the concept before 1937.⁷⁹ Albert Starkweather (America 1915-), an experienced Pictorialist photographer since the 1930s, relates the *in-focus* shape to the aperture setting and accuracy of focus, the former being an indirect measure of the spherical aberration.⁸⁰⁸¹

⁷⁷ Harold M. Merklinger "A Technical View of Bokeh" *Photo Techniques* May-June 1997.

⁷⁸ Kodak described their 12 inch and 16 inch portrait lenses made from circa 1948-1965 as creating a "pearly highlight." *Kodak Portrait Lens 305 mm f/4.8* (Rochester: Eastman Kodak Company, circa 1952) unpaginated.

⁷⁹ L. P. Clerc *Photography: Theory and Practice* George E. Brown ed. 2nd ed. (New York: Pittman Publishing Corp., 1937) p. 206, Fig. 165. This is an addition to the First Edition of 1930.

⁸⁰ Albert Starkweather "Notes on the Verito Lens" *The New Pictorialist* Vol. 4 No. 2 April 1972 pp.6-7.

⁸¹ www.vanwalree.com entry for "spherical aberration" out-of-focus character.

Figure 5.13: pinpoint light sources photographed slightly out of focus with (left) a single plano-convex lens, flat surface toward film and (right) a complex floating element soft focus lens. The left image demonstrates poor 'doughnut' *bokeh*, the right image evinces 'pearly' configuration considered very desirable. A lens with neutral bokeh would have an even light distribution across the entire disk; mathematically this would be a 'perfect' lens. Compare to Figure 6.3 (Norman Goldberg "Through a Lens Softly" *Popular Photography* March 1987 pp. 40 and 43).

Figure 5.14: Excellent bokeh: the out of focus distant background has substance and has not been destroyed in form. Its nature is clearly visible and possesses a definite firmness. The lens used was almost certainly a Pinkham & Smith *Semi-Achromatic*. Alvin Langdon Coburn *Notre Dame* 1908 (Pam Roberts *Camera Work, The Complete Illustrations 1903-1917* p. 391)

Figure 5.15: An example of excellent bokeh even though well out of focus. The background becomes an abstract pattern used to fill space and create background similar to diapering used by medieval illuminators. The eye is untroubled by the lack of specific information and it does not draw the eye to itself thereby distracting from the central topic. This was probably made with a Pinkham & Smith *Semi-Achromatic* lens. This is a detail from a larger image known variously as *The Lesson* or *The Picture Book* by Gertrude Kasebier 1903 (Pam Roberts *Photogenic* pp. 124-125).

Figure 5.16: An example of undesirable bokeh. Note how the two horizon lines (light and dark) are both marked by a fringe or double-lines. The trees to the right of center are a classic example of the “wooliness” discussed often by Pictorialists. Photographer: Alfred Stieglitz *Hedwig Stieglitz* circa 1920 (John Szarkowski *Alfred Stieglitz at Lake George* p. 38)

Figure 5.17: An example of very unpleasant bokeh. Note the shape of the head of the woman in the background and the trees near her; their essential nature has been destroyed. Photographer: Edouard Boubat circa 1954, camera was a twin lens reflex Rolleiflex, lens unknown, aperture $f/5.6$. Since the photographer looks through a different lens than the taking lens with a twin lens reflex, the photographer was unaware of the *bokeh* at the moment of exposure (*Jahrbuch der Fotografie* Frankfurt: Umschau, 1955 p. 170).

Illustration 5.18: An autochrome by Heinrich Kühn.⁸² The checked table cloth rendition is a striking demonstration of two aspects of *bokeh*: smooth transition from best focus to out of focus and preservation of the inherent shape as it becomes totally out of focus. Kühn owned a Pinkham & Smith lens at this time but also was experimenting with his own designs circa 1909 (Ulrich Knapp *Heinrich Kühn Photographien* Salzburg: Residenz Verlag, 1988 plate 38); a minor variant of the same composition but reversed right-to-left is found in John Wood *The Art of the Autochrome* plate 4.

⁸² For a detailed account of his work with autochromes, see Sally Stein “Autochromes without apologies, Heinrich Kühn’s experiments with the mechanical palette” *History of Photography* 18, 1994, pp. 129-133.

Summary

Soft focus lenses differ from ordinary photographic lenses because images created with them have the following qualities: 1) highlights glow, 2) apparent depth-of-field is greatly expanded, 3) details are reduced, 4) diffusion is even across the useful field, 5) often a high flare level and, 6) a pleasing rendition of out of focus areas. The first four of these characteristics are caused by aberrations which would be suppressed to the greatest extent possible in a sharp lens. The highlight glow can be attributed almost exclusively to the presence of undercorrected spherical aberration. The suppression of detail is largely the effect of chromatic aberration. Apparent depth of field is a function of nearly all of the aberrations. Flare is caused both by the aberrations and the lack of coating on the lens surfaces. The cause of the sixth, known in Japanese as *bokeh*, is not absolutely certain but appears to be caused by an interaction of spherical aberration and aperture shape. It is the least acknowledged and understood aspect of lens performance. *Bokeh* is a key aspect of soft focus lenses (and sharp lenses as well) which cannot be duplicated by diffusers and other devices in front of the lens which merely smear or degrade the entire image.

Because of the aberrations and the physical architecture of soft focus lenses, their use is more complicated and ambiguous than the sharp lenses. Focusing, lighting, camera choice and darkroom practice all were at variance from standard anastigmatic technique. The next chapter will detail the specialized problems faced by photographers, both professionals and amateurs in using soft focus lenses, and how those challenges were met.

Chapter Six: Soft Focus Lens Practice

The Imagon is not a lens for beginners; it is also no lens for people whose guiding principles are speed and convenience... Anyone who thinks he can simply go into a store, buy an Imagon and start taking good pictures is sadly mistaken. An Imagon is an instrument possessing fine technical qualities and unless one is willing to study it patiently and quietly he had better stick to the next best anastigmat.¹

Prof. Berthold Kihn (1936)

Soft focus lenses were never ubiquitous either amongst amateur art photographers or studio portrait professionals. Especially in the longer focal lengths their physical size required cameras with large lens boards and rigid front standards that could support their weight without tilting downward. These lenses required significant changes in technique when compared to standard practice and many amateurs lacked the time to experiment adequately to master the special soft focus techniques or simply lacked the patience; then as now, many probably failed to read the instructions which accompanied the lens and treated it as an anastigmat, a method guaranteed to produce low quality results and frustration. These were never the lenses for the masses. The very aberrations which imbued the images with such distinct character also complicated and constrained their use.

Unlike anastigmats, soft focus lenses demanded “extra caution and skill and indeed is the dealing with spherical aberration an issue of skillful delicacy - focusing, stopping down, exposure, development... Each new motif, each act of mood or of lighting has its own laws to be met with. Quite rightly so, and it does no harm that good and soft

¹ Prof. Berthold Kihn, “Interesting Facts about the Imagon” *The German Annual of Photography, 1937* (Berlin: Bruno Schultz, 1936) p. 17.

imagery have the delight of rarity.”² These lenses were difficult to use precisely because there were no absolutes as with sharp lenses.

John Paul Edwards (American 1883-1958) was an enthusiastic user of the *Verito* soft focus lens for two decades before he became a member of the “Group f.64.” Along with Edward Weston, another “Group f.64” founder, both endorsed the *Verito* lens in Wollensak promotional material.³ Edwards was arguably the most talented soft focus California photographer and wrote intelligently about their use:

Whichever make is purchased, learn it, stay by it, live with it, get acquainted with it. One's work should improve quite materially as he masters the capabilities of this artistic objective, and as acquaintanceship increases one will marvel at its versatility. Several workers could photograph the same object at the same time and from the same identical position and each get negatives quite different from the others through different focusing and lens apertures.⁴

There was universal agreement amongst experienced soft focus artists that “all lenses of this type want living with for a time and carefully and continually working until a result pleasing to the artist is obtained.”⁵ There simply are too many nuances to soft focus that could only be gleaned by actual experience; no amount of reading or imagining would substitute. Moreover, since “every soft-focus lens is, so to speak, a law unto itself, and the proper handling of any particular lens for this or that purpose or branch of work must be learned” by experience with that exact lens;⁶ Coburn owned a lens for two years

² Kühn 1926, p. 66.

³ Endorsement statement in *Verito, the Lens that Improves on Acquaintance* (Rochester: Wollensak Optical Company, ca. 1913) unpaginated.

⁴ John Paul Edwards “The Soft-Focus Lens” *Camera Craft* Vol. XXI, No. 7, July, 1914, p. 315. This is perhaps the finest article on soft focus ever written, pp. 313-322

⁵ Edgar Clifton “The Lens in the Studio” *BJP* June 9, 1911, p. 437.

⁶ Tennant, December, 1921, p. 171. This should be considered a companion piece to Edwards’ essay in *Camera Craft*. Between them they have all of the important information on soft focus in the time period but realize that reading them is not a substitute for experience.

before he “discovered that it was the best one.”⁷ Certain lenses were much more difficult to use well than others, “some of these soft-focus lenses are only suited to the most advanced workers, as they are inclined to give entirely too much diffusion and a great amount of flare unless the subjects and lighting are very carefully selected and handled.”⁸

The syntax of photography consists of a system approach, considering the creation of an image as an additive system: lens, camera, film, darkroom and photographer. To demonstrate why this is an additive or perhaps even geometric system, consider this situation: a poor quality lens, not well focused, hand-held at too long an exposure by a non-too stable photographer and the negative overdeveloped and printed too lightly. Each lack of optimization is amplified by subsequent error to produce an unusable negative. A decision at any point effects all subsequent actions. Each of the components also contains subsystems, not limited to:

Lens: hood, cleaning system, cable release, filters, shutter, aperture type, design

Camera: tripod, viewing system, focus (may also possess a shutter built into the chassis), format

Film: grain size, light sensitivity, spectral sensitivity, inherent contrast, halation coating, sizes available

Darkroom: processing including developer, agitation, temperature, development method (time & temperature, inspection), printing method and paper type. As the final step, to some extent errors earlier in the system can be partly or totally corrected in the darkroom but this is sub-optimal technique.

⁷ Alvin Langdon Coburn “The Question of Diffusion” *Semi-Achromatic Lenses* (Boston: Pinkham & Smith Company, ca. 1911) unpaginated.

⁸ Edwards July, 1914, p. 315.

Photographer: physical size and strength, eye sight, experience, knowledge of conceivable choices, training of the eye, choice of subject, lighting, etc.

It must be remembered that the syntax of film changes greatly during the peak period of soft focus (1890-1920) and thus the performance of a lens is affected. The most important change was the common use of orthochromatic film (sensitive to green and blue), beginning in the 1890s, and the slow but eventual shift to adopt panchromatic films (sensitive to all colors but not necessarily equally so) mostly post-1910.⁹ In addition, serious photographers, both amateur and professional, used glass plate negatives eschewing flexible film until well after 1910 in most cases; they rightly believed that glass plates were capable of producing a higher quality image. Anti-halation coatings made tremendous changes in how images with brilliant highlights were rendered, such as many Pictorial photographers often used as compositional devices in their photographs. The import is that advice on lens use is strongly dependent on the film to be exposed; advice that is applicable for a lens in 1905 may no longer be valid in 1920 and must be examined in detail if using modern color film.

The aesthetic ‘rules’ of diffusion change significantly from 1890 through the 1930s. Almost without exception, there is a desire for greater ‘firmness,’ especially at the largest aperture, as time passes and as a result the lens designs became increasingly complex.¹⁰ The resulting images from later lenses “are very different from those obtained with the earlier semi-achromatic and anachromatic forms,”¹¹ although in the late 1940s

⁹ As late as 1930, *Das Deutsche Lichtbild Jahresschau 1931* published an article on “The Practice of Adopting Panchromatic Film,” clearly indicating the transition was far from complete.

¹⁰ Two major soft focus lenses of the 1940s-1960s, the Wollensak *Veritar* and the Kodak *Portrait*, harken back to the softer images of before World War I. The former is the *Verito* bought up to date with a coated lens and better glass; the Kodak is a coated modification of the Pinkham & Smith *Semi-Achromatic*.

¹¹ Tennant, December 1921, p. 166.

and early 1950s, the trend reverses with the introduction of the Kodak *Portrait Lens* and the Wollensak *Veritar*. It is worth noting that these two lenses were both designed for professional studio use and not for amateurs (who did not take part in the soft focus lens revival); both were also designed for use with color film (i.e., they depended on spherical aberration without chromatic aberration for their softness) which had only recently been adopted by portrait photographers in America.

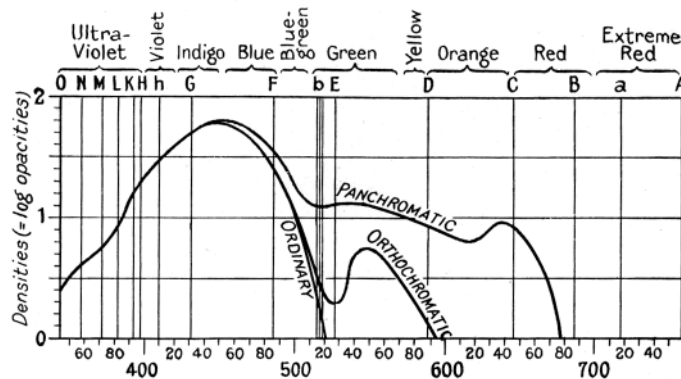

Figure 6.1: Spectral sensitivity comparisons of ordinary, orthochromatic and panchromatic films in 1930 (Clerc, *Photography: Theory and Practice* 1930 p. 141)

Lenses

As the fashion for soft focus grew, the number of lenses and designs produced grew commensurately. Soft focus lenses before World War II can be placed in one of the following categories: 1) Single element, 2) Combination, 3) Doublet, 4) Variable separation of elements, 5) Internal floating element, 6) Symmetrical, and 7) Perforated diaphragm.

The single element lenses were premised on both Wollaston and Watzek's researches and nearly always took a meniscus form, plano-convex and bi-convex having crucial shortcomings. Cheap to manufacture, they were difficult to use, "such a lens possessing all possible errors, and giving, as a result of its optical defects, a very soft quality of definition."¹² The chemical and visual focus did not coincide thus an adjustment had to be made after the visual focus. Because a simple meniscus has significant chromatic aberration, the "soft quality" was exaggerated after panchromatic emulsions came into common use, unless, however, "a ray filter {yellow equivalent to a modern K-2} and color sensitive plates are used, the lens is rendered for all practical purposes completely achromatic and no correction need be made after focusing."¹³ Regardless of the film's spectral sensitivity, "lenses of the single series have from 50 to 60 per cent correction, and therefore show more halo around the lights than doublets of 75 per cent correction, so that they must be stopped down more to get rid of the flare or used in a duller light."¹⁴ The Struss *Pictorial* is the only significant lens of this type.¹⁵

Combination lenses with the configuration of two elements cemented together often took the form of an achromatic meniscus beginning with the French landscape lenses (ca. 1880) that influenced Henry Smith's design of the *Semi-Achromatic* (1902) and continue through the Kodak *Portrait Lens* (discontinued in 1966). Others in this highly successful category include the Spencer *Port-Land*, Gundlach *Achromatic Meniscus*, Dallmeyer *Soft-Focus* and Cooke *Rapid View and Portrait*. Lightweight,

¹² Paul L. Anderson *Pictorial Photography, its principles and practice* (Philadelphia: J. B. Lippincott & Company, 1917) p. 37.

¹³ Frank R. Fraperie 4th ed. *How to Choose and Use a Lens* (Boston: American Photographic Publishing Co., 1925) p. 25. This advice holds true for all lenses with a high degree of chromatic aberration.

¹⁴ Fraperie 1925, p. 22.

¹⁵ Anderson 1917, p. 37.

compact and less expensive, these lenses were a solid choice for photographers working in the field. Furthermore, “the single lenses give more brilliant images, and are a practical necessity if night scenes are to be made which include bright lights in the field of view. On account of the smaller amount of glass through which light must pass to reach the plate, the single lenses are appreciably faster than the doublets at the same nominal aperture. In addition, with some makes additional glasses of different focal lengths may be obtained very reasonably, which interchange with the regular lens in the same barrel, affording all the advantages which a battery of lenses offers to the user.”¹⁶

Figure 6.2: Kodak *Portrait Lens* cemented achromat manufactured from the late 1940s until the early 1960s (Eastman Kodak Company *Camera Technique for Professional Photographers* p. 16)

Doublet designs are normally convertible lenses, that is, the rear element may be used separately at approximately 50% longer focal length (the front element is unscrewed from the barrel and removed). The Wollensak *Verito* manufactured from 1911 until the 1960s (as the *Veritar* after World War II) falls into this group. Measured by sheer

¹⁶ Tennant, December, 1921 pp. 167-168.

numbers, it was undoubtedly the most popular soft focus lens ever produced. The *Bodine* was the first soft focus convertible lens and its design became the *Verito*. The Gundlach *Hyperion Diffusion* (originally named *Equal Diffusion Portrait*, 1921) had two cemented two-element groups each of which could be used alone, thereby creating a triple convertible lens (one with three focal lengths).¹⁷

Doublets had significant advantages over the other lens forms. Possessing such a lens, the photographer had a choice of two focal lengths and a sharp or soft lens (depending on the aperture chosen), a very versatile lens indeed. The three glass elements allowed for a reasonable correction for chromatic aberrations, allowing most of the diffusion to be attributable to spherical aberration, controllable by the photographer. “The doublets have an advantage over the single lenses in freedom from distortion, larger aperture, and greater covering power [large negative format for a given focal length]”¹⁸ all important gains, especially for architectural subjects. There were compromises, however: “they are much bulkier and heavier than single lenses of equivalent focal length, thus requiring a large lens board and a rigid camera front, especially in the larger sizes.”¹⁹ Most, but not all doublets could be separated; some such as the Pinkham & Smith *Visual Quality* did not have adequate corrections to use the cells individually.

¹⁷ Neblette 1927, p. 107.

¹⁸ Tennant, December, 1921 p.167.

¹⁹ Tennant, December, 1921, p. 167. Nonetheless, they were lighter and more compact than the Petzval-type portrait lenses in common studio use at the time.

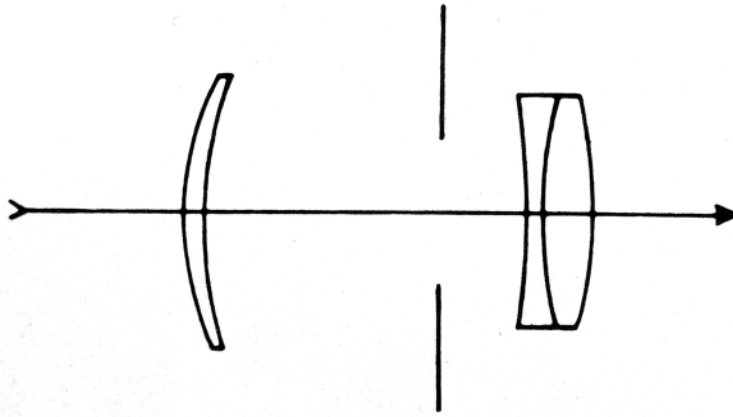

Figure 6.3: *Veritar* (and *Verito*) diagram, typical doublet design with a thin meniscus in front and an achromatic meniscus at rear which could be used alone (*Portrait Veritar Lens* a Wollensak instructional brochure circa 1955)

Variable separation lenses began with the 1866 Dallmeyer *Patent Portrait* where the entire lens barrel was rotated moving the front two elements away from the rear element. The “knuckle duster” on the Cooke *Portrellic Series IIb* performed a similar function by shifting the front elements away from the rear element; the Beck *Isostigmat* *Variable Portrait* and the Graf *Variable* lenses also shifted the front element forward.. The *Isostigmat* (1906) was a very complex soft focus lens with five elements in five groups. Moving the front element gradually increases the aberrations, progressively softening the image in a manner that is less aperture dependent than other soft focus designs, which is a major advantage. It does, however, alter the effective focal length somewhat, making it necessary to re-compose the image. The degree of diffusion at $f/5.6$ when the lens was set to ‘sharp’ was significantly different in nature from the same aperture at the ‘soft’ setting. The Graf *Variable* (ca. 1915) was composed of four elements and was based on the Steinheil *Unofocal* but unlike it, the Graf was not

symmetrical The *Variable* lens was large, heavy and complex²⁰ but nonetheless rendered excellent soft focus. It was Edward Weston's second soft focus lens, after the Verito, having been introduced to it by his mistress, Margrethe Mather.

Figure 6.4: A dapper Edward Weston with a 14-16 inch Graf *Variable* lens on his 8x10 *Korona* "View" camera, photograph by Tina Modotti, ca. 1926 (camera and lens identifications by the author). Note that the lens just barely fits on that lens board. It is rather curious that he is holding the ground glass back for the camera (Sarah M. Lowe *Tina Modotti and Edward Weston the Mexican Years* plate 14).

²⁰ The Graf Optical Company instructional booklet ("How to be Happy with the Graf Variable Anastigmat") for the *Variable* ran 22 pages in length.

A second form of variable lens was based on Dallmeyer's telephoto design and incorporated a single front element and a single rear element. Moving the relative positions of the lenses not only changed the degree of diffusion but also the equivalent focal length of the lens, thus requiring either moving the camera or recomposing the image. This design inherently has a high degree of chromatic aberration and became less desirable as panchromatic films were adopted by photographers. Two representatives of this group include the Dallmeyer *Bergheim* and some forms of the French *Objectif d'Artiste Formule Anachromatique* designed by Constant Puyo and Leclerc de Pulligny circa 1897. "The Bergheim lens gives a soft focus, not by confusing the rays of light like defective human eyesight, but by bringing the different colors of the spectrum to focus at different distances from the lens. Thus, when the blues and violets are clearly focussed, the reds and yellows are much out of focus. Take the case of a blond with freckles; the eyes would be clearly defined {blue}, and the hair massed together, and the freckles softened; the red lips would be thrown out of focus, and the tiny cracks and wrinkles on the lips, which are so troublesome, softened."²¹

²¹ A. J. Anderson *The Artistic Side of Photography* (New York: Dodd, Mead & Company, 1911) p. 308.

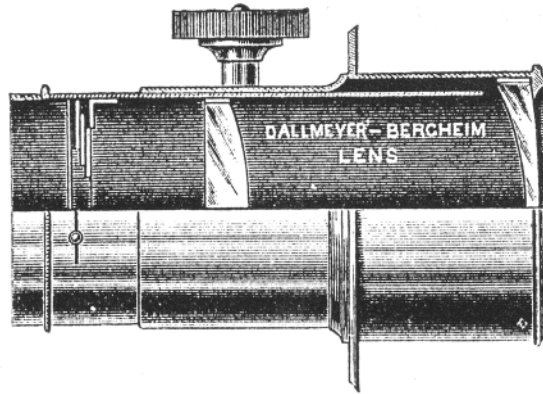

Figure 6.5: Diagram of the earliest version of the Dallmeyer-Bergheim lens. Note that the knob does not change the focus but varies the separation between the lens elements (W. Butcher & Sons Ltd. *Camera House Price List 1914* p.329)

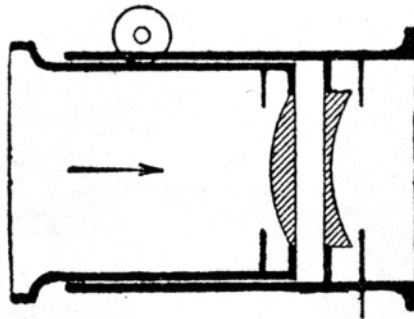

Figure 6.6: Cutaway diagram of the Adjustable Landscape lens of Pulligny & Puyo; the knob varies the lens separation and changes the focal length (L. de Pulligny and C. Puyo *Objectifs d'Artiste 1924* page 95).

The lenses of Puyo and Pulligny, because the visual and chemical focus did not coincide, could be difficult to focus reliably. Frederick Evans complained that “when that has to be guessed at by a final blind correction of focus to make up for lack of actinic correction, and the effect of which is not visible on the focussing screen - and that is the

real drawback to such otherwise fine instruments as the Bergheim and Pulligny lenses.”²²

This was incorrect regarding the Puyo and Pulligny lenses, however, as they had devised an ingenious method of making the focus correction. The instructions for use are in their book of 1924²³ as well as described by Robert Demachy in 1907: “a carefully calculated scale will be engraved on the mount and the position of the stop after focussing will indicate automatically the number of millimetres that the lens has to be racked back.”²⁴

See the photograph below for an example.

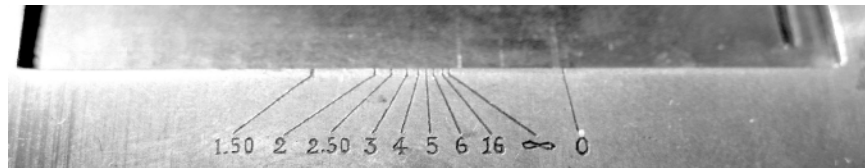

Figure 6.7: Engraved scale of focus correction on an *Objectif Anachromatique* of Puyo and Pulligny, 400mm f/5 lens made by Hermagis, Paris (Collection of the author)

Very few lens utilized a floating internal element (until 35mm format lenses in 1970s). The *Universal Heliar*²⁵ represents one of the few lenses in this category. This design was inherently more complicated mechanically and like the variable separation system, the focal length changed as the elements were moved from one position to another. Most lenses with variable separation or a floating element allowed the lens to be sharp at the maximum aperture, impossible with the other types of soft focus lenses.

²² Frederick Evans “Art in Monochrome” *The Amateur Photographer* Feb. 11, 1908, reprinted in Hammond, 1992, p. 102.

²³ L. de Pulligny and C. Puyo *Objectifs d’Artiste*, New Edition (Paris:Paul Montel, 1924) pp. 56-57.

²⁴ Robert Demachy “The Pictorial Side in France” *Photograms of the Year 1907* (London: Dawbourn & Ward, 1906) p. 62.

²⁵ Arne Croell “Voigtlander Large Format Lenses from 1949-1972” *View Camera* May/June 2005 p. 36.

Any symmetrical lens drastically minimizes coma, lateral color and distortion.²⁶ Symmetrical refers to a system possessing the same lenses front and rear with a centrally placed aperture. It was an old design, with the Steinheil *Periskop* (1865) and the Dallmeyer *Rapid Rectilinear* (1866) being two representatives of the original type (both sharp). Field curvature was a problem but with the introduction of new glasses in 1888, a symmetrical anastigmat was possible.²⁷ It was an uncommon design for soft focus with the Busch *Nicola Perscheid* (1920) being one of the few examples produced.

Figure 6.8: Busch *Perscheid* symmetric soft focus lens design (Rudolph Kingslake *A History of the Photographic Lens* p. 59)

The final major contribution in the evolution of the soft focus lens was the introduction of the perforated diaphragm. Photographer Heinrich Kühn and optical engineer Dr. Franz Staebble (German, 1876-1950) developed this unique solution during the late 1920s. Instead of the standard iris diaphragm (Waterhouse stops had been supplanted by that time), an interchangeable diaphragm with a central aperture surrounded by smaller holes was substituted. The ratio of the central opening to the smaller holes controlled the spherical aberration; the sharp central rays passing through

²⁶ Kingslake 1963, p. 138.

²⁷ Sidney F. Ray *The Photographic Lens* 2nd ed. (Boston: Focal Press, 1992) p. 146.

the central opening created the sharp core image and the amount of smaller holes admitted or rejected the marginal rays. Three diaphragms were supplied with varying ratios of central to marginal rays and represented different f/numbers. One the achievements of this system was to allow a lens passing the equivalent light of an f/9 lens to still exhibit some softness, an impossibility with a standard aperture which would have eliminated the marginal rays at f/9. The resulting design was first marketed as *Kühn's Anachromat* (1928) but was renamed the *Imagon* when Rodenstock bought the design from Staebler in 1930.²⁸ This lens remained in production until 2000 or 2002.²⁹ The glass itself was described as a “cemented two element lens of the achromat type, and is greatly under-corrected.”³⁰

Changes in the syntax of film nearly required the invention of the Imagon, because firstly, the sensitivity of film to light had increased by more than five-fold since 1900 and secondly, nearly all photographers used panchromatic film. The former change required either higher shutter speeds or smaller apertures to produce a properly exposed negative; this was a particular difficulty when photographing in direct sunlight. Closing the lens aperture to a smaller opening altered the aberrations thus when using a soft focus lens, any adjustment of exposure *must* come from increasing the shutter speed. Large format leaf shutters³¹ have distinct limitations regarding how fast the shutter leaves can move. As a result, a #3 shutter made during the Twentieth century will have a top shutter speed of 1/125th of a second. Assuming a film speed of ASA 25, a correct exposure in direct sunlight would be f/5.6 at 1/200th of a second, or a full stop faster than the shutter

²⁸ Dr. Alfons Scholz *Das Imagon Buch* trans. Anonymous (Munich: Rodenstock 1979) p. 45.

²⁹ Email from Bob Salomon, marketing director, H. P. Marketing Inc., the U.S. importer of Rodenstock lenses, dated 27 June 2006.

³⁰ *Camera Lenses* a 24 page brochure (Munich: Rodenstock 1985) unpaginated.

³¹ Focal plane shutters will be discussed subsequently in this chapter.

can produce. Most soft focus lenses longer than 250 mm focal length would only fit in a #5 shutter and the fastest #5 shutter (the German “Compound” brand) was only capable of 1/50th of a second, not fast enough to use a lens at f/5.6 in sunlight. Kühn’s impetus to create a lens that retains some softness at f/9 is, therefore, was at least partly driven by the ever increasing film sensitivity.³² As panchromatic film came into nearly universal application, the older soft focus lenses with copious quantities of chromatic aberration become unacceptably soft. Kühn considered these problems for some years, constantly experimenting.

About 1927 he partnered with Munich optical designer Franz Staebler (1876-1950) in developing the final innovation in the soft focus lens: the perforated diaphragm.³³ The perforations controlled the ratio of the sharp axial rays to the softening marginal rays, that is, it varied the degree of spherical aberration without using an iris. Staebler was the co-owner of a substantial optical firm and was familiar with the necessary mathematics and production limitations; Kühn completely understood the requirements but not how to fulfill them.³⁴ Theirs was an ideal partnership and the result came to market in 1928 as *Kühn’s Anachromat*.³⁵ The world-wide depression that followed 1929 reduced Kühn’s personal wealth considerably and it caused the collapse of Staebler’s company.

Rodenstock bought the design, hired Staebler and rebranded the lens the *Imagon*. The lens enabled photographers to shoot in bright light and still retain soft focus, a major

³² Post-war *Imagons* came with a factory supplied yellow-green filter which was not only useful for proper tonal rendering but also cut about 50% of the light passage, allowing the lens to be used with higher speed films. At some undetermined date circa 1960 a one stop neutral density filter began to accompany the lens in order to compensate for new, faster films.

³³ Fujinon made three focal lengths of soft focus view camera lenses in the 1970s and 1980s which were premised on a perforated diaphragm of the *Imagon*. It is a design much like the *Verito* with the perforated diaphragm affixed by the photographer to the rear of the front lens element, a very cumbersome method.

³⁴ Scholz 1979, p. 43+.

³⁵ Scholz 1979, p.44.

achievement. The perforated diaphragm has one minor disadvantage, however, called the “Kühn bug,” where brilliant spectral highlights duplicate on the negative the central hole surrounded by the smaller perforations of the diaphragm.³⁶ The only solution is to not include such highlights in the composition. Besides the perforated diaphragm, Kühn is remembered for inventing multiple color gum bichromate printing and the modern monorail view camera.



Figure 6.9: Perforated diaphragm from an *Imagon* lens, 420 mm focal length, manufactured circa 1934. In 1935 the circles of perforations were reduced from three as seen here to two which undoubtedly changed the degree of diffusion by reducing the amount of marginal rays³⁷ (collection of the author).

Figure 6.10: Illustration of function of the *Imagon* perforated diaphragm showing the distribution of marginal and axial rays (Sidney Ray *The Photographic Lens* p. 183)

³⁶ Scholz 1979, p. 83.

³⁷ advertisement for the *Imagon*, *Das Deutsche Lichtbild Jahresschau 1936* (Berlin: Bruno Schultz 1935) p. A137.

Figure 6.11: Cutaway diagram of the *Imagon* lens showing the perforated diaphragm positioned at left and the semi-achromatic meniscus at right. Light would enter from the left (Rodenstock brochure for the *Imagon*, 1980)

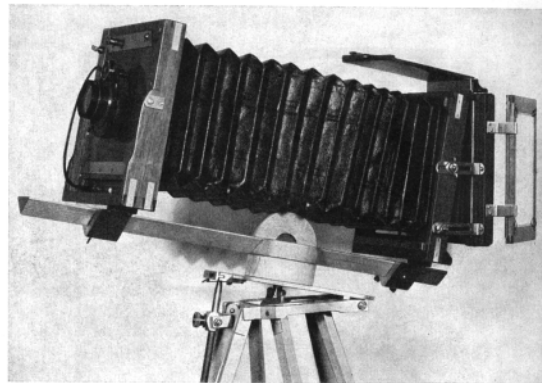

STUDIENKAMERA NACH HEINRICH KÜHN
Das Werkzeug der Defner, Goodwin, Kühn, Zielke

Mattscheibe allseitig gleichzeitig bis zu 30° verstellbar, daher erhöhte Tiefenschärfe ohne Abblendung!

Leichtigkeit, unvergleichliche Festigkeit, geringer Raumbedarf und genaues Einstellen durch Prismenführung.

Auswechselbares, verschiebbares Objektivbrett, auch für große Verschlüsse und Objektive.

Mattscheibenformat: 9 x 12 cm, Auszug bis zu 50 cm

Ausführliche Beschreibung und Preisangaben im Prospekt ST K

A. STEGEMANN

BERLIN S 14, DRESDENER STRASSE 50/51

Figure 6.12: An early advertisement for the monorail camera devised by Kühn (*Das Deutsche Lichtbild Jahresschau 1933*, page T140)

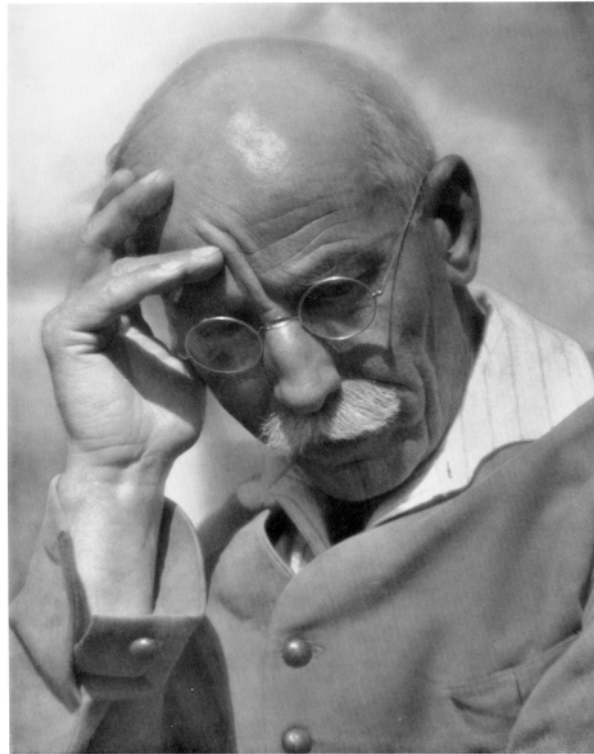

Figure 6.13: *Portrait of Heinrich Kühn* by Dr. Adalbert Defner using a 300 mm *Imagon* lens at H=6.3, 9x12 cm negative (Das Deutsche Lichtbild Jahresschau 1933, p. 1)

In general the evolution of the soft focus lens is from a very soft image to a firmer image, following the general aesthetic trend as well as making the lenses more ‘user-friendly.’ For instance, Pinkham & Smith sold four soft focus lens models (*Semi-Achromatic*, *Semi-Achromatic Doublet*, *Visual Quality*, *Synthetic*) within two decades, each one successively ‘firmer’ than its antecedent. Early lenses such as the *Dallmeyer-Bergheim*, *Struss Pictorial* and the various Pulligny & Puyo models incorporated a relatively high degree of chromatic aberration, which was perfectly acceptable in an era of ordinary and orthochromatic films but became a liability when panchromatic black & white film came into common use. It is worthwhile to note that the ‘great names’

(Coburn, Day, Kasebier, Steichen, Seeley, White et al) made their careers with the softest and most difficult to utilize lenses. Virtually no notables of the photographic arts used the later generations (post-1915) of firmer lenses.

Camera Selection, 1900

The large, heavy studio camera with its long bellows, large lens boards and interchangeable backs was the mainstay of the portrait trade from the early 1870s until well after World War II. It took a great deal of space, was slow to operate and inelegant in design but immensely functional with great versatility possible due to the many accessories available. Of particular interest is the large lens board, in order to accommodate typically large portrait lenses (Petzval type and soft focus). They were virtually always mounted on rolling stands rather than tripods.

The years following World War II were a period of prosperity and optimism in the United States and with that came a revival of the soft focus aesthetic in professional portraiture; this revival was primarily driven by the Hollywood glamour portraits of studios such as George Hurrell (American 1904-1992) who used both the *Verito* and the Kodak *Portrait Lens*.³⁸ The illustrations in one popular 1947 instructional book, *Professional Portrait Lightings*, are approximately 40% soft focus, made with *Vitax*, *Cook Portrait*, *Graf Variable*, *Velostigmat Series II*, *Verito*, *Pinkham & Smith*, *Dallmeyer Patent Portrait*, *Struss Pictorial*, *Beach Multi-Focal*, *Petzval*, *Varium*, and *Heliar* (the

³⁸ Mark A. Vieira *Hurrell's Hollywood Portraits* (New York: Harry N. Abrams, 1997) pp. 12 and 53. There are serious equipment identification errors in this book and the *Verito* in Plate 60 is actually one of the Cooke variable soft focus lenses.

latter is technically not a soft focus lens but has more spherical aberration than a standard lens, resulting in the legendary ‘roundness’ it imparted to the sitter).³⁹

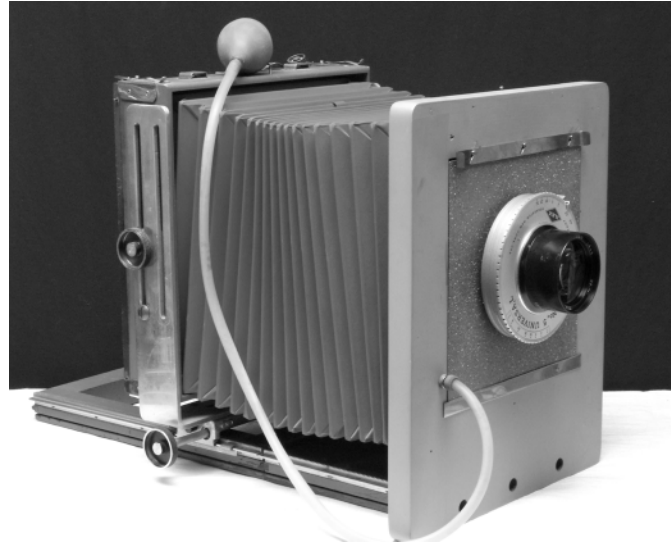

Figure 6.14: An 8x10 Burke & James *Rembrandt Master Pictorialist* portrait camera with a Burke & James *Rembrandt Super Portrait Lens* 10 inch focal length, for the 4x5 format reducing back, made in the 1950s-60s The front standard is lacking some of the original hardware (collection of the author)

This last flowering produced perhaps the most practical studio camera yet and two of the finest soft focus lenses. The final product of the evolution of the venerable studio portrait camera was the Burke & James *Rembrandt* which was sold from 1951 until at least 1967.⁴⁰ This model embodied all of the necessary attributes of a studio portrait camera to be used with a soft focus lens: (1) a large lens board, 9x9” for the 8x10 model, (2) rigid front standard that will maintain alignment even with a heavy lens mounted, (3) enough bellows to focus a 18” lens at studio distances, (4) reducing backs, 2¼x3¼, 4x5 and 5x7 for the 8x10 model, (5) a large, pre-mounted interior Packard shutter with

³⁹ Charles Abel *Professional Portrait Lightings* (New York: Greenberg Publisher, 4th printing 1951).

⁴⁰ All information in this paragraph sourced from a 1951 and a 1967 *Burke & James Photographic Equipment* catalog.

attendant fitting for a air bulb rubber hose. Burke & James also marketed a modified *Petzval* lens, the *Rembrandt Super Portrait Lens* in 10, 14 and 18 inch focal lengths specifically to accompany that camera. None of the three Burke & James lenses required nearly that large a lens board; it was designed with the large diameter soft focus lenses in mind, such as the newly marketed Kodak 16 inch *Portrait Lens* and the Wollensak 14 inch *Veritar*, both designed for the 8x10 format. Once Rodenstock put their Munich factory back into production after World War II, the *Imagon* was once again available in a wider variety of focal lengths (the 360 mm was designed for 8x10 negatives) for both European and American markets.⁴¹ Obviously a photographer could also source many used soft focus lenses from the previous decades on the used equipment market as well.

Studio cameras were largely immune to changes in other areas of photography's syntax until the 1960s when they began to be replaced by medium format roll film cameras, mostly twin lens reflexes (i.e., Rolleiflex) and single lens reflexes (i.e., Hassleblad), cameras that could be hand held and used much less expensive 120 format roll film. Furthermore, these newer cameras allowed the photographer to view the client until the very moment of exposure. These smaller cameras were possible because of the improved film technology which brought finer grain and higher speed films as well as a proliferation of color films. The syntax of photography had changed in a profound manner by the mid-1960s.

⁴¹ It is worth noting that the Kodak *Portrait Lens* f/4.5 and the *Imagon* H=5.8 were too large for any shutter (except a Packard) and were only available as barrel mounts. The *Veritar* f/6, however, was available in a #5 shutter.



Figure 6.15: Photographer Glen Aultman of Trinidad, Colorado, with the studio camera he used for portraiture virtually all of his 70 year career (photograph by the author, 1989). The camera and stand are now in the collection of the Colorado Historical Society.

Amateur cameras were an entirely different category than professional studio portrait models and here tremendous changes developed rapidly as the amateur market became exponentially larger with the blossoming of camera clubs and commercial processing and printing businesses. At the outset of the amateur photography fad circa 1885, the cameras used outside of the studio by the amateur were often the same as used in the lesser quality studio, such as the Scovill below.



Figure 6.16: Two large format cameras showing the rapid evolution of the field type camera. On the left a circa 1885 Scovill 5x7 *Elite* camera with original single element landscape lens. On the right a circa 1905 Sanderson quarter plate *Junior* camera with original Cooke 7.87 inch lens; Frederick Evans used a similar Sanderson camera (collection of the author).

Driven by the burgeoning amateur market, two new genres of large format camera came into existence: the field camera and the reflex camera. Field cameras, as the name implies, were engineered for use in the field. Since they traveled, they needed to be more compact, lighter, fold into a self-protective package, be fitted for tripod mounting, and may also have attributes for hand-holding when photographing. The Scovill model shown above has very few adjustments: focus, a very slight rear tilt, and a rise/fall front but with very little movement and a very basic single element lens without a shutter and cannot be hand-held. On the other hand, the Sanderson has a quality lens with a quality shutter, a finely geared focus, rise/fall and tilt front, vertical/horizontal back, focus scales for two focal length lenses, accessories viewfinder for both horizontal and vertical, bubble level, folds into its own protective box, and is exquisitely finished. English and American camera manufacturers produced significantly different cameras; English models almost always had more brass fittings and better finished wood and normally folded into a box

form for transport. The evolution of the amateur field camera is poorly documented, extremely complex, and for brevity, must only be lightly touched upon herein. Although compact, versatile and easy to transport, their lens boards were often too small to accommodate the diameter of a soft focus lens.⁴²

The American made *Speed Graphic* was a self-casing field camera with a focal plane shutter to 1/1000th of a second. Immensely popular, especially with photo-journalists, they were in continuous production from 1912-1968. Unlike the *Graflex* below, these were only available in three sizes, 2¼x3¼, 3¼x4¼, and 4x5. Although a few late pictorialists such as Foreman Hanna used them, the limited lens board (4x4 inches) and bellows (only 12 inches) did not recommend them to soft focus lens users. Nonetheless, the seven and nine inch *Verito* could be mounted although only the latter would be considered 'long enough' for good pictorial principles.

The reflex camera came into being about 1900, the best known and longest lasting form being the American made *Graflex*. First introduced to the market circa 1901 it boasted an excellent focal plane shutter capable of speeds (up to 1/1200th of a second) far above the leaf shutters then on the market, almost a necessity for soft focus users.⁴³ The *Graflex* was a reflex camera, meaning the photographer looked down directly through the taking lens right until the moment of exposure; the image was upright, unlike a view camera, but still reversed right-to-left. Specifically designed for the purpose of being hand-held, they were immensely popular and were in constant production for 62 years,

⁴² Edwards July, 1914, p. 314.

⁴³ Richard P. Paine *A Review of Graflex* (New York: A Photographers Place, 1985) p.10. The model name was the "RB Cycle Graphic" clearing indicating the willingness of photographic manufacturers to capitalize on the new bicycling craze.

the *Super D Graflex* ceasing production in 1963.⁴⁴ Many major pictorialists were enthusiastic users of reflex cameras, including W. B. Post (who taught Stieglitz their virtues), Stieglitz, Coburn, Annan, Weston, White, Johann Hagemeyer, Paul Anderson⁴⁵ and more. Stieglitz despite his diatribes against commercialism composed a ringing endorsement for the *Graflex*, noting that he owned three sizes. He wrote “it is beyond my understanding how any serious photographer can get along without at least one Graflex. If circumstances compel me to choose but one type of camera when off on a trip, it invariably means my taking a Graflex.”⁴⁶ A practiced user could move from carrying the camera under his arm to ready to shoot in less than fifteen seconds, an impossibility with any tripod mounted camera (and when traveling, saved the weight and space of transporting a tripod and dark-cloth). English makers such as Adams, Dallmeyer and Ensign made similar reflex cameras of high quality.

Reflex cameras came in nearly every sheet film size of the era, ranging from 2¼ x 3¼ to 8 x 10, the latter being for of the few cameras ever designed to be hand-held with such as large negative. Paul Anderson, Alvin Langdon Coburn, Paul Strand and Edward Weston all used the quarter-plate (3¼ x 4¼) size, Coburn in places where a tripod was impossible such as in the rigging of a ship, when traveling, and for portraiture,⁴⁷ Strand for his surreptitious street photographs in *Camera Work*, and Weston for most of his portraiture (although he later purchased a 4x5 model).⁴⁸ A syntactical element of reflex

⁴⁴ Paine 1985, p. 68. These cameras are still highly sought after by contemporary photographers.

⁴⁵ Paul L. Anderson wrote the definitive article, “The Graflex for Pictorial Work” *The American Annual of Photography, 1920* (New York: American Photographic Publishing Co., 1919) pp. 64-80.

⁴⁶ From a *Graflex* advertisement in *Camera Work* No. 16 (October, 1906) advertising section.

⁴⁷ Letter from Alvin Langdon Coburn to Helmet Gernsheim dated 19 January 1965, Gernsheim Collection, Humanities Research Center, University of Texas.

⁴⁸ Edward Weston “Thirty-Five Years of Portraiture” in *Edward Weston on Photography* Peter Bunnell ed. (Salt Lake City: Peregrine Books, 1983) p. 106 and 108, originally printed in *Camera Craft* issues for September and October, 1939.

camera use is the lowered viewpoint; in the case of a 4x5 Graflex, the lens is actually two feet below eye level; “the only drawback to the outfit is in seeing things from the waist level, which makes the foreground difficult.”⁴⁹ Height-challenged Edward Weston wrote that “when I do have to hold the camera [his RB Graflex 4x5] I often resort to standing on a box” in order to obtain a better viewpoint.⁵⁰

⁴⁹ B. S. Horne “As to Certain Soft Focus Lenses” *Pictorial Photography in America, 1921* (New York: Pictorial Photographers of America, 1921) p. 12.

⁵⁰ Weston 1939, in Bunnell, 1983, p. 111.

Figure 6.17: Alfred Stieglitz with one of his *Graflex* cameras, striking a pose for fellow photographer Heinrich Kühn in an undated photograph made at Lake George, Stieglitz's summer home. The author is certain that it is a model made only 1901 -ca. 1905 (John Szarkowski *Stieglitz at Lake George* p. 29). There is a 4x5 *Graflex* camera that belonged to Stieglitz in the George Eastman House collection. Whether a failure of research or a deliberate cleansing, Sue Davidson Lowe's *Stieglitz, a memoir/biography* section on 'Stieglitz Photo Equipment' (pp. 441-443) fails to mention either of the soft focus lenses he is known to have owned that Georgia O'Keeffe donated to the George Eastman House.

Figure 6.18: Silhouette of Alfred Stieglitz holding a *Graflex* camera on a poster designed by Edward Steichen used to promote the Photo-Secession movement and Stieglitz's gallery. This is essentially a free and very influential advertisement for the camera which would have reached many of the *cognoscenti* of American art photography (William Innes Homer *Alfred Stieglitz and the Photo-Secession* p. 32).

Many significant advantages were attributed to reflex cameras, especially the *Graflex* with its built-in high speed shutter (1/1000th second). With a camera shutter, the less expensive barrel mounted lenses could be used and the speeds were fast enough to use a soft focus lens at f/4 in direct sunlight. Because no dark cloth or tripod was

required, it was easier to carry and very fast to ready for an exposure. It was very mobile and ideal for non-static situations and the subject was visible until the very moment of exposure. Candid photographs such as Paul Strand's of people on the street in New York were only possible in sheet film or plates by using a reflex camera; compared to a camera mounted on a tripod with the photographer covered by a focusing cloth, it also drew relatively little attention. Fast to ready for use, and very easy to move to view different view points, it was the ideal camera for photographing active subjects.

The reflex camera, despite its many advantages, was not without drawbacks. First, they were expensive compared to a standard field camera or a view camera. Second, except for specialized models, the bellows draw was fairly limited, very much constraining both the minimum (approximately 180mm for the 4x5 Graflex, which was a moderate telephoto) and maximum focal lengths of potential lenses (the correct focal length was an important variable- see "Focal Length" section below).⁵¹ Third, except for specialized models, the lens boards were small, too small for many soft focus lenses. Some manufacturers, such as Wollensak (*Verito*)⁵² and Struss (*Pictorial*)⁵³ modified their lenses to be usable on reflex cameras; one crucial issue was whether the camera could close with the lens in place. A few lenses such as the Gundlach *Achromatic Meniscus* and some models of Pinkham & Smith were relatively thin lens mounts and therefore needed no modifications for reflex camera use. Lens makers were early to adopt aluminum, a

⁵¹ On his trip through the American West in 1911-12, Coburn used a quarter plate reflex camera which allowed him to focus a twenty-four inch lens at infinity. It is unclear what make and model this could be with such an extraordinarily long extension, however, a longer lens may be used if the subject matter will be at or near infinity. There is a very small, coarsely reproduced image of Coburn at the Grand Canyon by his mother and it appears to be an ordinary reflex camera ("Camera Pictures" exhibit catalog by the Goupil Gallery, London, 1913).

⁵² Wilfred French editor "Wollensak Verito for the Graflex" April 1919, Vol. XLII, No. 4, p. 220.

⁵³ Wilfred French editor "Struss Lenses for Reflecting Cameras" notice in *Photo Era* August 1916, Vol. XXXVII, No. 2, p. 100.

relatively new metal for commercial applications, for lens barrels in order to save weight. Early aluminum lenses were made by Pinkham and Smith (post-1911),⁵⁴ Dallmeyer *Patent Portrait* (1909 and later), the Struss *Pictorial* and others; in fact, all Struss lenses were housed in aluminum barrels. The metallurgy of aluminum was not well established at that time and some of these barrels have deformed, corroded or have become extremely brittle with the passage of ninety years.

Certainly not all, or perhaps not even many, pictorialists advocated their use. Will Cadby, a prominent English photographer and regular magazine columnist summed up his doubts: “For, after all, the most ambitious pictorialist cannot hope to make a dozen masterpieces in a morning. It is only by close and deliberate observation on the ground glass with the camera firmly fixed, that he can study the subject comfortably, and shift his view point, inch by inch, to perfect his composition.”⁵⁵ The real issue was not only time but magnification; a view camera photographer normally utilized a 4x (or thereabouts) loupe for focusing, an ideal method for studying the rendering of highlight details by the soft focus lens. Reflex cameras prevented any magnification of the image, however, and the fine elements went unseen. Because the soft focus lens requires such a careful examination of the focus, only a master such as Coburn could optimally utilize them on a reflex camera. The anastigmat, on the other hand, was ideal for a reflex camera.

Even the most enthusiastic reflex users did not depend upon them as their sole cameras. Stieglitz noted “a Pocket Kodak, a Graflex and a tripod 8 x 10 is a complete

⁵⁴ Wilfred French editor “Catalog of ‘Smith’ Lenses” *Photo-Era* April, 1911, Vol. XXVI, No. 4, p. 216.

⁵⁵ Will & Carine Cadby “London Letter” *Photo Era* August 1922, Vol. XLIX, No. 2, p 111.

outfit for any pictorialist.”⁵⁶ The “Pocket Kodak” is an exact product line, not a general reference to a small camera. It was introduced by Kodak in 1897 and grew in sophistication and quality as years passed and it is not possible to know with certainty whether his model was a simple or sophisticated version. All models relied on a fairly low quality view finder, regardless of the nature of the taking lens. Most serious pictorialists used a view camera on a tripod, as did Stieglitz. The view camera offered greater versatility: more movements (for controlling depth of field or perspective), longer bellows, larger lens boards and in the same format, cost less than a reflex or field camera. The view camera with its very stable and stationery position on the tripod allowed an unhurried and detailed inspection of the image on the ground glass, especially important in the focusing stage of shooting with a soft focus lens. Until it has actually been experienced, it is difficult to appreciate how distinct and unique the appearance of any image on an 8x10 ground glass is when compared to any other method of composing with a camera. Because both eyes are used when composing with a view camera, field camera or reflex camera, there may be stimulation of variant neural pathways in the aesthetic portions of the brain as compared to use of the single eye with most other camera systems. It is certainly less visually fatiguing whilst examining the image, which encourages slow, deliberate contemplation of the composition.

View cameras might also possess one of the most important attributes of a reflex camera, a focal plane shutter. Both Folmer & Schwing and the Graflex Company offered a focal plane shutter that could be fitted to the rear standard, between the body and the ground glass back, of 8x10 view cameras. The shutter speed range was from 1/10th to 1/1000th of a second; there was never any other shutter available which offered that top

⁵⁶ Alfred Stieglitz “Graflex advertisement” *Camera Work* 16 October 1906 advertising pages.

speed for an 8x10 camera; these high speeds allowed fast f/4 soft focus lenses to be used wide open in bright sunlight. These remarkable shutters were initially patented in 1902 with three subsequent patents by 1908.⁵⁷ Judging by their extreme rarity today, they were either uncommon or not durable.

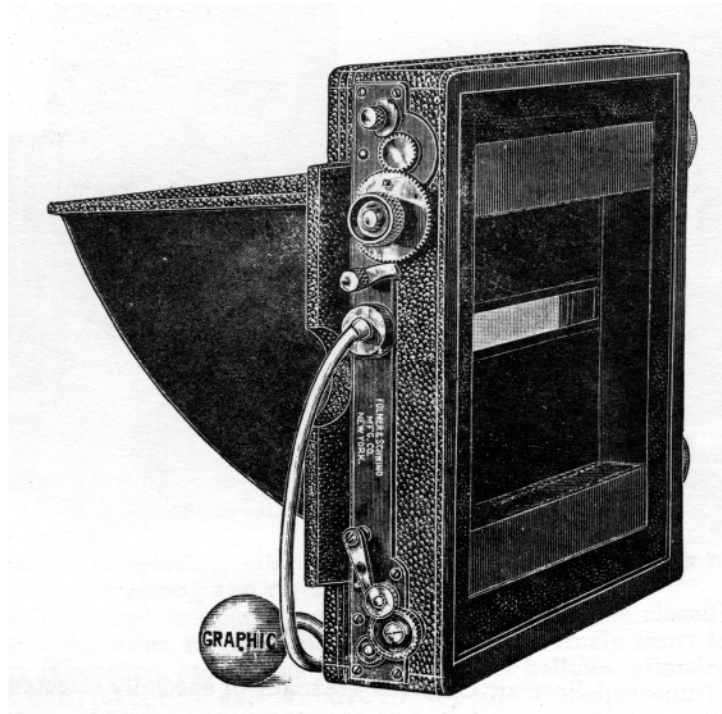

Figure 6.19: Folmer & Schwing focal plane shutter patented November 5th, 1901 (Folmer & Schwing *Catalog and Price List 1904 of Photographic Apparatus* p. 52)

View cameras were designed for a modicum of movements for perspective control and depth of field control (none having as much freedom of correction as the post 1930s versions). Perspective control was rarely, if ever, required by the soft focus worker. Depth of field control, however, could be used to place the plane of best focus in a position other than perpendicular to the camera's axis, and this was not uncommonly

⁵⁷ Information engraved on a Graflex 8x10 focal plane shutter in the possession of the author. Dates are: Dec. 16 '02, June 21 '04, Feb. 5 '07 and April 21 '08.

used in portraiture. For example, with a seated woman, her hands folded in her lap, where the aperture with the desired level of softness cannot place both her hands and face in focus, the required change of focus plane is possible by view camera standard movements.

Karl Struss wrote in 1915 that “the ideal camera for the Pictorialist should have a large front board, a long bellows extension, swing-back, side-swing and double lens-swing.”⁵⁸ John Paul Edwards was a bit more precise in his description: “I think that an ideal combination would be a strong 4x5 folding camera with a long draw, say about sixteen inches, and a front -board about three inches square, with a double soft-focus lens of seven to nine-inch focus, preferably the latter if the camera will accommodate its bulk.”⁵⁹ With such a camera and the nine inch lens, the minimum focus distance achievable was about a foot. Thus Edward’s ideal camera would be large enough to mount a nine inch focal length soft focus lens and allow a large range of focus distances with a lens with a focal length nearly twice the long side of the negative. It should be noted that although Struss often made 4x5 inch and smaller contact prints, most of Edward’s prints were approximately 11x14 inches. The 5x7 format was never as popular as 4x5 or 8x10 although it made a contact print nearly twice the area of a 4x5 contact. Enlargers (and the appropriate lenses) for the 5x7 format were much larger and more costly than those for 4x5, and therefore mitigated against amateur usage.

⁵⁸ Karl Struss “Pictured with the Struss Lens” a facsimile reprint of the original 1915 sales brochure in *The New Pictorialist* Journal of the New Pictorialist Society, Vol. 10, No. 1, Spring 1978. Courtesy of Al Starkweather, Sr.

⁵⁹ Edwards 1914, p. 315.



Figure 6.20: Agfa-Ansco 5x7 view camera circa 1925 with a contemporaneous *Portrait-Objectiv Kronar* f/4 350mm soft focus lens made by Simon, Dresden. Moderately compact when collapsed, possessing limited movements, 23 inch bellows and 5¼ inch square lens board, this type of camera was ideal for the pictorialist who required a versatile camera to also be portable (collection of the author).



Figure 6.21: John Paul Edwards matte silver print, approximately 11x14 inches, presumably from a 4x5 inch negative made with a *Verito* lens. The luminosity of the sunlit areas is superbly handled although evident in this size reproduction. It aptly demonstrates the instructions by Oliver Bodine, the inventor of the *Verito*, “aim to get those soft, mellow light effects which separate the planes or aerial perspective, for the *Verito* seems to have the facility of searching out the shadows, making them luminous and full of detail.”⁶⁰ (collection of the author).

⁶⁰ H. Oliver Bodine “How to Use the *Verito*” *Verito, The Lens That improves On Acquaintance* (Rochester: Wollensak Optical Company, ca. 1913) p. unpaginated. Bodine was the lens’ inventor.



Figure 6.22: Life size detail of 6.21, in correct color, which better demonstrates the luminous quality of Edwards' photograph imparted by the *Verito* lens (collection of the author).

One of the advantages discussed of the reflex camera was the lack of kit which had to accompany it, however, the view camera requires quite a battery of accoutrements to maximize its use. Besides the camera, the minimum equipment that the photographer had to have at hand would include: tripod, dark cloth, focusing loupe, level, filters to fit each lens, several lenses, cable or air bulb to release the shutter, and film holders. Most photographers also carried a note book for recording exposure data, brush and cloth for

cleaning the lenses, hoods for each lens. In addition there was the case in which all of this had to fit (excepting the tripod). It was the weight and bulk of this kit which led Weston's son, Brett, to quip that "there were no good landscapes more than 50 yards from the car."

The physical setting up and manipulation of the view camera requires an entire book to cover thoroughly; they are not easy to master and require diligence and experience to achieve a degree of optimal utilization. For more detailed information on wielding a view camera effectively see *The Large Format* by Koch, Marchesi and Marchesi (Feuerthalen, Switzerland: Sinar Ltd., 1982) or Stroebel *View Camera Technique* 7th ed. (Boston: Focal Press, 1999). It should be evident that the syntax of the view camera was ideal for static subjects and nearly impossible for those in motion; for subjects in motion, the reflex camera was ideal.

Figure 6.23: Edward Weston with his 8x10 view camera at work in New Mexico, photograph by Santa Fe photographer Ernest Knee, 1941, cropped to show Weston better. Weston rarely allowed photographs that indicated his small stature. Note the carrying case to the right which contained all the necessary accoutrements and camera except the tripod. Mobility with this large a view camera was limited (collection of the author).

FOCAL LENGTH

The choice of focal length was critical for the discerning pictorial photographer as “upon it depends the truthful rendering of the different portions of the sitter and much of the correctness of the modelling.”⁶¹ Unlike many other concepts associated with soft focus lenses, there was nearly unanimous agreement in determining the proper focal length for a given format: “This proportion should be as two to one, that is, the focal length of the lens should be as a rough working rule twice as long as the base of the picture.”⁶² This should not be confused with classical perspective issues in art, since all pinholes and lenses lacking significant barrel or pincushion distortion render ‘correct’ perspective from the artists’ viewpoint.⁶³

Pictorial photographers eschewed the use of wide angle lenses. Emerson had laid down the dictum “it is obvious that panoramic effects are not suitable for art, and the angle of view included in a picture should never be large.”⁶⁴ Although writing more than two decades after Emerson, Beck used the analogy to human vision to caution against wide angle lenses, explaining “the reason why the wide-angle lens produces such a curious distortion is because the human eye is in its real character a narrow-angle viewing

⁶¹ Conrad Beck and Herbert Andrews 7th ed. *Photographic Lenses, a Simple Treatise* (London: R. & J. Beck, Ltd, 1912) p.157.

⁶² Emerson 1889, p. 136.

⁶³ For an excellent elucidation of classical perspective, see Martin Kemp *The Science of Art: optical themes in western art from Brunelleschi to Seurat* (New Haven: Yale University Press, 1990)

⁶⁴ Emerson 1889, p. 120.

apparatus and is not accustomed to see the strong effects of perspective,"⁶⁵ that is, wide angle lens produce an unnatural view.

Normal and 'Proper' Focal Length Lenses
For Common American & English Camera Formats

	<i>Film Format</i> (inches)	<i>Normal Length</i> (mm)	<i>'Proper' Length</i> (mm)
quarter-plate	3¼ x 4¼	137	225
	4 x 5	162	250
half-plate	4¾ x 6½	204	330
	5 x 7	219	350
whole-plate	6½ x 8½	272	430
	8 x 10	325	500
	10 x 12	396	600
	11 x 14	450	700

where the 'normal' focal length is equal to the diagonal and 'proper' is equal to twice the longer side of the negative. The 'proper' focal length tends to be about 50% longer than the 'normal.'

Soft focus lenses, because they typically are limited by design to a narrow angle of coverage, are by necessity longer than a 'normal' focal length. Since there was no wide angle or normal angle soft focus lenses, the issue was essentially resolved in their use. The real question was "how long?" The answer revolves around the choice of subject. For portraiture, the answer is constrained, in part, by the size of the studio and the relative uniformity of scale of both the subject and the final print. Any distortion of perspective in the human face is immediately noticed and thus portrait photographers would never willingly use a wide angle or even normal lens for a tight head shot. Beck

⁶⁵ Beck and Andrews, 1912, p. 122.

believed “a lens should invariably be used with a focal length as long as the studio will permit.”⁶⁶

Figure 6.24: Portraits made with a ‘normal’ focal length lens on left and ‘short-focus’ lens on right. The rendering is clearly not natural in the right hand image. Although Adams labels an eight inch lens on 4x5 as normal, this is misleading as ‘normal’ would be a six and a half inch focal length. The eight inch focal length is halfway between ‘normal’ and twice the longer negative dimension criterion for good rendering (Ansel Adams *Camera and Lens* 1970 edition p. 191)

For landscape the issue is quite different, often revolving around the near-far relationship. The choice of a higher vantage point removes the immediate foreground as does a long focal length lens. Lens designer Thomas Dallmeyer succinctly summarized the dilemma of the landscape:

⁶⁶ Beck and Andrews, 1912, p. 162.

The problem which the photographer has to solve in every case where there is considerable depth in his subject is: how far from the foreground his standpoint should be in order to maintain the perspective rendering in a degree which is not overdone in either of the two directions possible. On the one hand, by loss of perspective by taking the subject from too distant a standpoint, and thus diminishing the due effect of distance; or, on the other, by choosing too near a standpoint, and so causing the receding planes of his picture to diminish too rapidly in scale, and thereby unduly extending the effect of distance.⁶⁷

Another English lens designer, Conrad Beck, recommended for landscape that “a lens of considerable focal length be chosen; as much as twice the longest side of the plate is a good average, including as it does only some 35 degrees.”⁶⁸ The longer lenses allow the foreground to be “omitted or diminished in size and the distance is magnified and brought nearer,”⁶⁹ aspects which most pictorialists found aesthetically appealing. On his trip through the American West in 1911, Coburn used lenses as long as twenty four inches on his 3¼x4¼ reflex camera (this must have been a lens of telephoto design because no reflex camera of that size had adequate bellows for a twenty four inch draw).⁷⁰

There were two other important issues in the pictorialist aesthetic which were mediated by the use of a long focal length lens. First was the characteristically shallow depth of field evident in most of their photographs which takes the eye directly to the key portion of the composition. Although soft focus lenses displayed an enhanced depth of field compared to an anastigmat, for any type of lens at a given aperture, the depth of field is less for the longer focal length lens. Also the longer lens also compresses the sense of space, a characteristic most pictorial photographers admired in Japanese woodblocks. “Japanese compositional designs played a role in the creation of more

⁶⁷ Dallmeyer 1899, p. 126.

⁶⁸ Beck and Andrews, 1912, p. 178. Thanks to Al Starkweather, Sr., for bringing my attention to this text.

⁶⁹ Beck and Andrews, 1912, p. 228.

⁷⁰ Alvin Langdon Coburn typescript “Largely Landscapes” Gernsheim Collection, HRHRC.

abstract arrangements in Pictorial images....Such devices as foreshortening, strong diagonals, planal cropping, exaggerated foregrounds, and silhouetted shapes juxtaposed with deep recessional spaces all became hallmarks of international Pictorialist works.”⁷¹

As a practical matter of proper utilization of soft focus lenses, it was believed that “using a longer than average focal length lens minimizes the double lines or halo”⁷² which made male portraiture difficult when the *de rigueur* starched white collars manifested these lines.

FOCUS

Soft focus lenses must be focused examining the actual image as formed on the ground glass, upside down and backwards right-to-left in the case of a view camera, or upright but reversed right-to-left in the case of a reflex camera. Hand cameras which utilized the common focusing scale were inadequate for soft focus as the appearance of the image changes throughout the band of acceptable focus; users of those cameras would mitigate any minor focus error by closing the anastigmat lens down to a small aperture, gaining depth of field, not a feasible solution for the aperture-dependent soft focus lens. Additionally, cameras which focused solely by using the scale were simply unsuitable for soft focus use, “such lenses naturally cannot be used successfully with any camera which is not provided with a ground-glass screen, for the image is so soft and harmonious that it needs the most careful focusing.”⁷³

⁷¹ Peter Bunnell “Towards New Photography: Renewals of Pictorialism” Michel Frizot ed. *A New History of Photography* (Köln: Konemann, 1998) p. 320.

⁷² M. C. Williamson “The Soft-Focus Lens in Modern Portraiture” *Concerning the Verito* (Rochester: Wollensak Optical Company, ca. 1930) p. 5.

⁷³ Fraperie 1925, pp. 21-22.

The ground glass (alternatively known as a *focusing screen*) is so termed because it is produced by grinding one surface of a glass sheet with a fine abrasive. Coarser abrasive produces a brighter image but the granularity makes fine focusing difficult. Finer abrasive produces a dimmer image that appears brighter in the center than near the margins but produces a more critical definition of the image⁷⁴. An extremely fine screen can be created by the use of hydrofluoric acid at the cost of diminished brilliance.⁷⁵ The concept of examining an image projected by a lens onto ground glass has precise antecedents in the 18th century camera obscura, a concept that has not been significantly improved in over 200 years. The naked eye does not provide adequate acuity for the critical focusing needs of the photographer; some type of eyepiece or magnifying lens has been used since the dawn of photography to allow for a detailed observation of the image.

An image on a ground glass inherently has the property of glow and diffusion as a function of the texture of its 'grind.' Even the sharpest lens casts a romantic appearance on the glass. This has been recognized since the early days of the medium but Peter Henry Emerson stated it most plainly: "The deceptive luminosity of the ground-glass picture must not be allowed to influence our normal mental analysis of the natural scene."⁷⁶ It is accepted as a particular pitfall of soft focus that "every one who begins to employ soft-focus overdoes its effect, because he is so charmed by the ground glass picture."⁷⁷ Because of the ground glass texture, it is essential to evaluate the "ground glass image produced by the marginal rays and learn to assess the effect of their hazy

⁷⁴ *The Focal Encyclopedia of Photography* revised desk edition (New York: McGraw-Hill, 1969) entry for "Focusing Screen" p. 667.

⁷⁵ Acid etched screens were certainly known in this period. See Walter E. Woodbury *The Encyclopaedic Dictionary of Photography* (New York: Scovill & Adams Company, 1898) p. 211.

⁷⁶ Emerson 1889, p. 72.

⁷⁷ Kühn 1928, unpaginated.

subimage in the finished picture. For this will not appear anywhere near as hazy.”⁷⁸ Thus, the soft focus practitioner requires significant prior soft focus experience before achieving any degree of mastery of the ‘simple’ process of focusing.

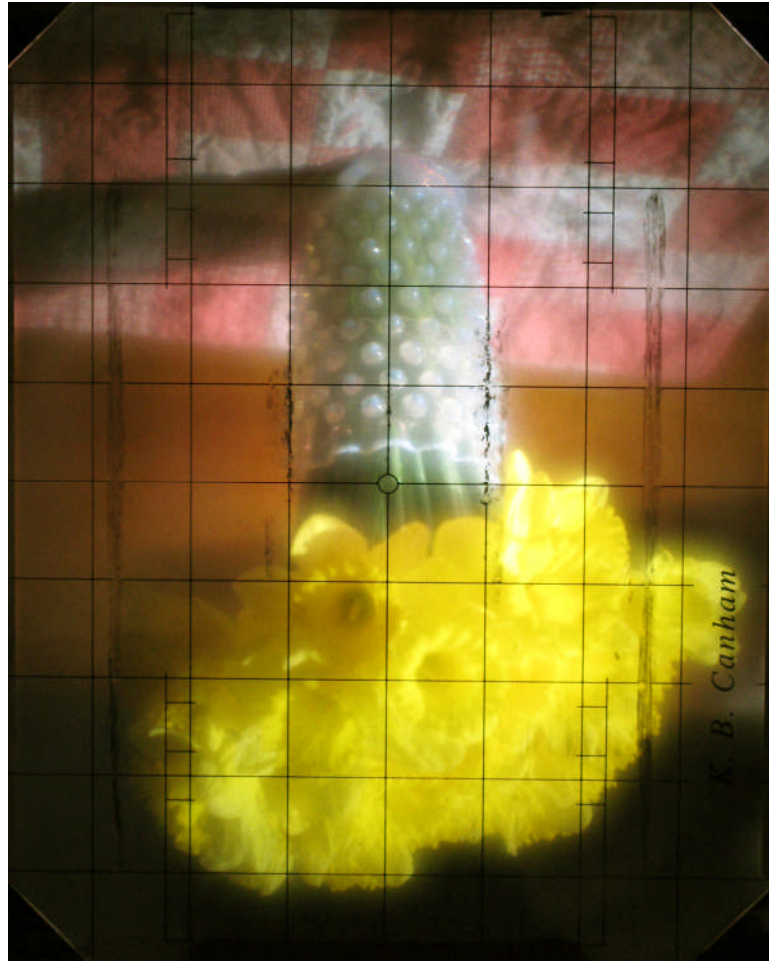

Figure 6.25: 4x5 ground glass image produced by a nine inch focal length Spencer *Port-Land* lens at f/4.5 reproduced 100%; the serial number (№ 318) indicates a manufacture date of circa 1914-1916. Note the softness of the image and slight halo around some areas of the flowers. An identical *Port-Land* was used by Ansel Adams in the 1920s.⁷⁹ (photograph by the author)

⁷⁸ *Rodenstock Imagon* (Munich: Optische Werke G. Rodenstock, 1978) p. 10

⁷⁹ Ansel Adams *Examples: the Making of Forty Photographs* (Boston: Little, Brown & Co., 1983) pp. 49-51. He wrote it was an ‘8 inch’ focal length but this lens was never made at that focal length; it was almost certainly a nine inch focal length lens.

Focusing the modern anastigmat mounted on a large format view camera or reflex camera is a straightforward procedure. As the lens is racked forward and backward, the plane of focus ‘snaps’ in and out of focus, especially with an aperture of $f/5.6$ or faster (minimizing the depth of field). The effect is clear and instantaneous with the point of best focus being immediately obvious. For the $f/64$ school photographer, stopping the lens down to a very small aperture will compensate for any minor focusing error by bringing most if not all of the composition into acceptable focus as “everything in the picture must be sharp.”⁸⁰ The standard procedure is to focus at a fairly wide open aperture to project the brightest (and easiest to view) image and then close down until all came into focus. The $f/64$ acolyte did not need to decide which element of a composition received the accent gained from sharpest focus, with the remainder sublimated through degrees of lesser sharpness, but performed whatever actions were required to bring all elements into an equal sharpness. Edward Weston had his Turner-Reich *Triple-Convertible* lens modified to close to $f/180$, so dim that “of course I can't see what happens on the ground glass when I get beyond $f/64$ or so”⁸¹ but merely assumed that everything would be sharp when in actuality, the images were unacceptably soft when examined in the darkroom.

Almost no lens of the 1890-1920 era was sharp at its widest aperture; then, as now, large format photographers habitually closed down two or three stops simply to gain resolution, especially in the corners of the field (as independent of depth of field). The soft focus lens, because the effect changes greatly with the aperture, must be composed at the taking aperture; furthermore, because the focus moves with the extent of spherical

⁸⁰ Beaumont Newhall *Focus: Memoirs of a Life in Photography* (Boston: Bullfinch Press, 1993) p. 46.

⁸¹ Edward Weston letter to Ansel Adams from late May or early June, 1937, in *Ansel Adams, Letters and Images* Mary Street Alinder and Andrea Gray Stillman eds. (Boston: Little, Brown and Co., 1988) p. 93.

aberration, focus must be made at the aperture to be used in the exposure. This was completely unlike the anastigmats with which all photographers were familiar.

Any soft focus lens requires experience and discernment, however, and there is no consensus regarding where on the band of focus should be considered ‘best focus.’ There are multiple decisions demanded of the artist which have no analog in the f/64 school. The first step is to decide where the plane of best focus should be placed. The next measure is to select the extent of focus falloff from the main subject through the subsidiary topics. Perhaps the extent of the highlight glow becomes the next point of decision. All of this must be performed at the actual taking aperture as any change in aperture will alter the aberrations present and change the image significantly; adjustments in exposure must take place by altering the shutter speed. After careful examination and consideration, the photographer might reach the conclusion that a different lens (possessing aberrations to another extent) would be required to achieve the precise goals.

Focusing is one of the greatest distinctions between the anastigmat and the soft focus lens. Whereas the anastigmat has a single point of best focus that can be universally agreed upon, the soft focus has “a region of focus rather than one plane, and it is possible to move the lens some little distance backwards and forwards without affecting the definition to a marked degree...”⁸² Optical science identifies three possible points of best focus for a lens with spherical aberration.⁸³ In practice, even experienced photographers had difficulty with the process of focus

When the Smith lens was first put on the market a well-known photographer was showing his new, long-focus Smith lens to some friends who were also photographers, and in order to get an idea as to its capabilities, each one in turn

⁸² Fraperie, 1925, p. 22.

⁸³ Rudolf Kingslake *Lens Design Fundamentals* New York: Academic Press, 1978) p.120, quoting a 1926 study by H. G. Conrady.

focused the same picture on the ground glass. When each had decided what he considered was the best effect, the base board of the camera was marked and when all were through it was found that there was a difference of about three inches between the nearest and the farthest mark.⁸⁴

All the while, the photographer must be cognizant of whether the final print will be a contact print (the same size as the negative) or an enlargement (and precisely how large). If it is to be enlarged, the photographer must be able to interpolate the degree of softness visible on the ground glass multiplied by the extent of enlargement, another task which requires significant experience. A hair line of ‘glow’ on the ground glass can easily become an objectionable band on an enlargement; an ideal image on the ground glass may enlarge four-fold to a textureless, ill-defined, undesirable print. In general, the smaller the negative, the less useful the largest aperture becomes.⁸⁵ Most pictorialists concurred that the optimal effects were only preserved through contact prints.

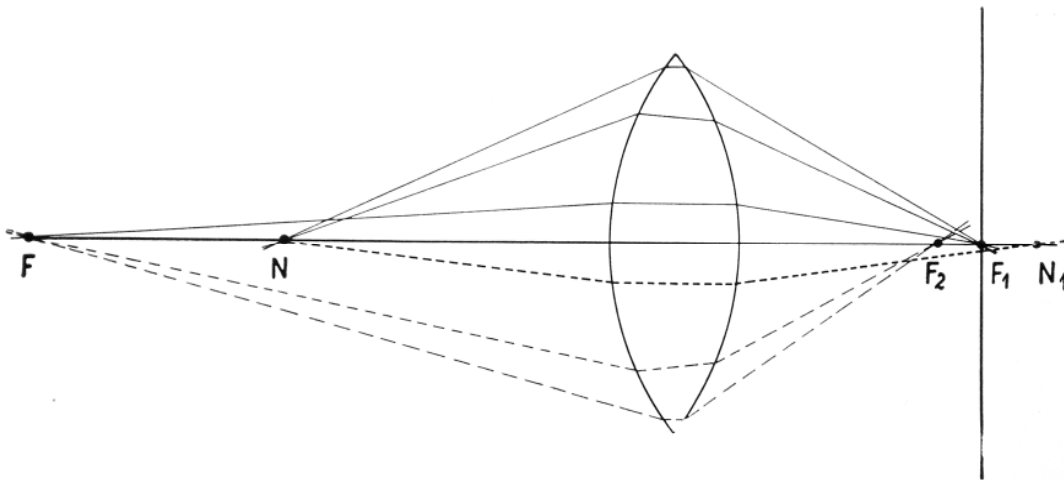

Figure 6.26: Diagrammatic explanation of focusing the *Imagon* (Heinrich Kühn *Imagon: Plastic Depth Lens sees like the artist's eye* a pre-World War II six page brochure by Optical Works G. Rodenstock, courtesy of Al Starkweather, Sr.)

⁸⁴ Arthur Hammond “Soft Focus Lenses” *American Photography* Vol. XV, No. 8, August 1921 p. 428. Brought to my attention by Al Starkweather, Sr.

⁸⁵ *Rodenstock IMAGON* 1978, p. 12.

Heinrich Kühn, co-designer of the *Imagon*, wrote explicit instructions on the question of focus. Unlike many early pictorial photographers, he was very conservative in terms of the extent of softness, advising “every one to endeavor to obtain extreme sharpness and low diffusion effects, that is to say employ medium or small diaphragms and always to focus as sharply as possible. In this manner the nucleus remains sharp in the middle of the faint halo.”⁸⁶ Referring to the diagram above, he suggests that for a subject at ‘F’ the best focus is at ‘F1’ where the axial rays focus, thus yielding a sharp central core overlain by the halo of the marginal rays which come to focus at ‘F2.’ It would be wrong “to focus where the diffusion area is the smallest [F2]. If done in this manner, whatever the exposure or development, the central image, that now in any case is not sharp, will be choked by the too bright, too closely surrounding irradiance AND AN UNCLEAR, UNSHARP, IMAGE survives [emphasis his].”⁸⁷

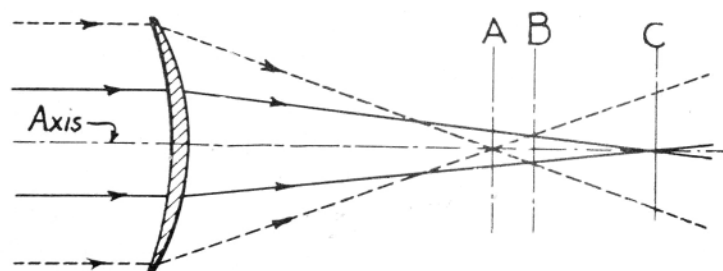

Figure 6.27: Diagrammatic explanation of the soft focus lens and focus (John Tennant “Soft Focus Effects in Photography” *The Photo Miniature* December 1921 p. 160).

⁸⁶ Kühn 1928?, unpaginated.

⁸⁷ Kühn 1926, p. 65.

Tennant's diagram illustrates the marginal rays coming to a focus at 'A' and the axial rays coming to focus at 'C.' If the lens was focused at 'C', the marginal rays form a huge halo, "the lights spread over the shadows and the result is a flattening of the picture-image. The texture is also destroyed and the objects photographed appear as though seen through a veil or mist."⁸⁸ He contends that the best point to place focus is 'B' "where the circle of confusion is at its smallest and the true soft-focus quality of image definition is secured." The photographer locates that point by

The camera is first racked out or extended until the principle object appears sharp to the eye, disregarding the halo which forms. The focusing-screen now occupies plane C. Now the lens and focusing-screen are gradually brought nearer each other until the halo first observed just disappears, the focusing-screen being brought into plane B. Or, as an alternative method, the camera can be extended slowly, the image on the focusing-screen being observed during this operation. At first, interlinked circles appear all over the field. These gradually disappear as the distance from the lens to ground glass increases, and finally disappear altogether. If the halo begins to appear at the same time, it is an indication that plane B has been reached and the focus established.⁸⁹

Tennant notes that placement should not "throw the focus too far forward [forward relative to the subject, towards 'C'], which is certain to result in an objectionable halo, often so noticeable as a luminous band about the white collar in portraits of men. It is therefore advisable to focus so that the image of the eyes falls into plane B, when the true soft-focus quality of definition will be obtained."⁹⁰ This is in conflict with Kühn's directions, who would focus at 'C' and suggests it was "absolutely wrong" to focus at 'B' "where the diffusion area is the smallest... if done in this manner... an unsharp soggy image survives."⁹¹

⁸⁸ Tennant Dec. 1921, p. 161.

⁸⁹ Tennant Dec. 1921, p. 162.

⁹⁰ Tennant Dec. 1921, p. 172.

⁹¹ Kühn 1926, p. 65.

Al Starkweather, Sr., an experienced soft focus photographer and one of the last of a generation of photographers who knew the original pictorialists, defines the question of focus with the basic premise that “the balance between the sharp core and the soft halo image that gives the beauty to a print from a soft focus negative.” To maintain that balance, examine the highlight in the sitter’s eye with a magnifier or loupe of 5x or less and focus until the central core is at its smallest and sharpest state, in agreement with Kühn. The size of the surrounding halo varies with the aperture even though the sharp core remains nearly constant, as illustrated below. A ‘bull’s eye’ pattern as shown to the right is from focusing on too distant a plane, yielding a disagreeable effect which should be avoided. Focusing too close produces a softer central core and although not especially adverse in appearance, is normally not as satisfactory as the best focus point.



Core image and halo of the *Verito*, greatly exaggerated (with kind permission, Albert Starkweather “Notes on the Verito Lens”)⁹²

The concept of examining the highlight to determine proper focus is to some degree dependent on the focal length of the lens. A shorter focal length produces a shorter band of focus, so short that the smallest adjustment may move all the way through the band. Because the image size is proportional to focal length, a short lens creates a very small highlight, often too small to examine adequately (if a higher magnification is used to examine it, then the image becomes lost in the texture of the ground glass).

⁹² Albert Starkweather “Notes on the Verito Lens” *The New Pictorialist* Vol. 4 No. 2, April 1972 p. 7.

There are scores of published articles detailing advice on focusing, some excellent, some ill-informed, some misleading, but few are as far from the mark and so complex as the instructions which accompanied the Kodak *Portrait Lens* (ca.1946-1965). They suggested two methods, catch light focusing and front focusing. In the former, the catch light in the eyes is focused on then the lens is racked out; although they give approximate distances for various head sizes, it is admitted that these are approximate. The suggestion is to tape a ruler to the camera bed as “an aid in making the measurements quickly and easily.”⁹³ The second method requires focusing with the aperture at f/8. It does not assume that the exposure will be made at f/8, but suggests opening up a full stop. Since the focus of a soft focus lens is dependent on aperture, this not only changes the depth of field but the actual plane of best focus will shift. Neither of these methods is correct, leading to an out of focus image which does not exploit the best character of the lens; this level of misinformation by major manufacturers is a cause of the demise of soft focus lens use.

In the early Pictorial period when isochromatic films were still in wide use, there was the issue of chemical versus visual focus on the ground glass. This was due to the difference in spectral sensitivity of the emulsion compared to the human eye. “This is a fault found in many of the so-called modern diffused focus lenses on the market as well as in the older type generally known as the semi-achromatic. This variance in the focus can only be overcome by an adjustment of the lens and plate or the use of a highly correcting filter with the consequent loss of speed.”⁹⁴ The amount of adjustment, although often cited as 1/40th of the focal length, was accurate only at infinity; focus at

⁹³ *Kodak Portrait Lens* (Rochester: Eastman Kodak Company, 1952) p. 3.

⁹⁴ H. Crowell Pepper “Notes on Selection” Pinkham & Smith brochure, undated but after 1919, pp. 1-2.

closer distances, such as in a studio portrait setting, required a greater compensation. The ‘highly correcting filter’ was a medium yellow filter, equivalent to the modern Wratten K-2 which blocked the shorter wavelength blue light. Tennant experimented with a Struss *Pictorial* comparing the results of using a yellow filter and moving the lens 1/40th of the focal length, deciding that the filter produced the sharper image.⁹⁵

The light source had to be considered as well. “If the mercury arc is used for illumination, correction after focusing is no longer necessary, the image being even a little sharper than that obtained by applying the correction in daylight.”⁹⁶ Conversely, tungsten illumination, poor in blue and UV light, required more compensation than in daylight.

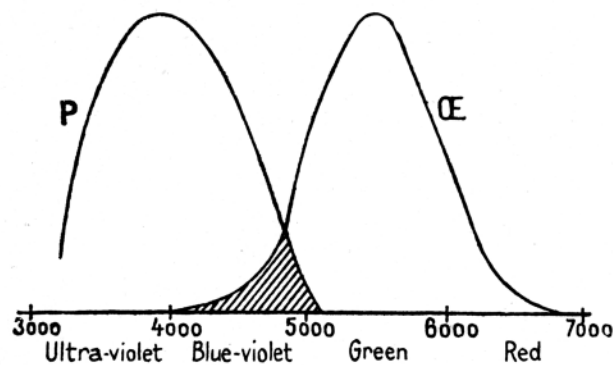

Figure 6.28: The spectral sensitivity of ordinary film (“P”) and the human eye (“OE”) with the shaded area indicating the only part of the spectrum where there is an overlap (Clerc *Photography Theory and Practice* 1930)

Lastly, there were those who believed it was impossible to give detailed instructions on focus, “To attempt to give to the purchaser of a Struss Pictorial Lens directions or precise rules to enable him to duplicate the pictures made by these workers

⁹⁵ Tennant 1921, p. 164.

⁹⁶ L. P. Clerc, George Brown editor 2nd ed. *Photography: Theory and Practice* (New York: Pittman Publishing Co., 1937) p. 207.

and unfailingly obtain the various effects that they obtain, would be like trying to instruct a purchaser of a paint brush how to produce a Rembrandt or Inness.”⁹⁷ Hammond saw this individual variability as “one of the greatest arguments in favor of such lenses for pictorial work, for when using them there is some scope for individuality; the result is therefore far more personal, less automatic and less mechanical.”⁹⁸

Regardless of the focusing placement chosen, the close and very deliberate examination of the image on the ground glass as it is racked in and out of focus meant long delays when photographing a live subject. Although speed was rarely an issue for landscapes, the lack of highlights in the prime focal plane made focusing more subjective than for portraits. California landscape photographer John Paul Edwards advised: “There is, however, one point where the image seems at its best. The right way to focus is to start at full aperture at the point where the image seems clearest and most free from flare, and then stop down until the amount of diffusion is in accord with one's ideas. One should alternately open up and then stop down a few times in order to study the different effects offered.”⁹⁹

There were many focusing styles in period, some providing superior visual aesthetic over others but all viable for their users.

APERTURES

The control of the amount of diffusion is achieved through the aperture setting. “The difference in degree of diffusion obtained with several stops of a soft-focus lens is very pronounced. This unique feature is one of the strongest factors in making the lens a

⁹⁷ Karl Struss *SPL* (Morristown, NY: Frederick W. Keasbey, ca. 1920) p. 4.

⁹⁸ Hammond November 1911, p. 237.

⁹⁹ Edwards 1914, p. 321.

power in the pictorialist's hands. It offers him the widest latitude in the amount of diffusion secured and it offers him a big chance to work his ideas, his personality and individuality into his pictures.”¹⁰⁰ In all cases, the greatest diffusion is achieved at the maximum aperture and the least diffusion at the smallest aperture. Except for variable designs (Graf, Bergheim, etc.), most soft focus lenses were as sharp as anastigmats by f/11. Karl Struss advised “at all times use the largest possible aperture, as this will give the best modelling, mass objects and simplify the composition, rendering planes and distance much better than with smaller apertures,”¹⁰¹ a statement that not all pictorialists would agree with, especially those desiring a firmer image such as Kühn. Flare and halo would be at a maximum, which would be less than desirable with many subjects and lighting conditions. It appears that in his pre-California soft focus images, Struss made only contact prints thus the halo, already large, would not be made grossly evident by a four or six times enlargement.

¹⁰⁰ Edwards 1914, p. 321

¹⁰¹ Karl Struss “Pictured with the Struss Pictorial Lens” quoting from his 1915 catalog in *The New Pictorialist* Vol. 10, No. 1, Spring 1978, p. 2.

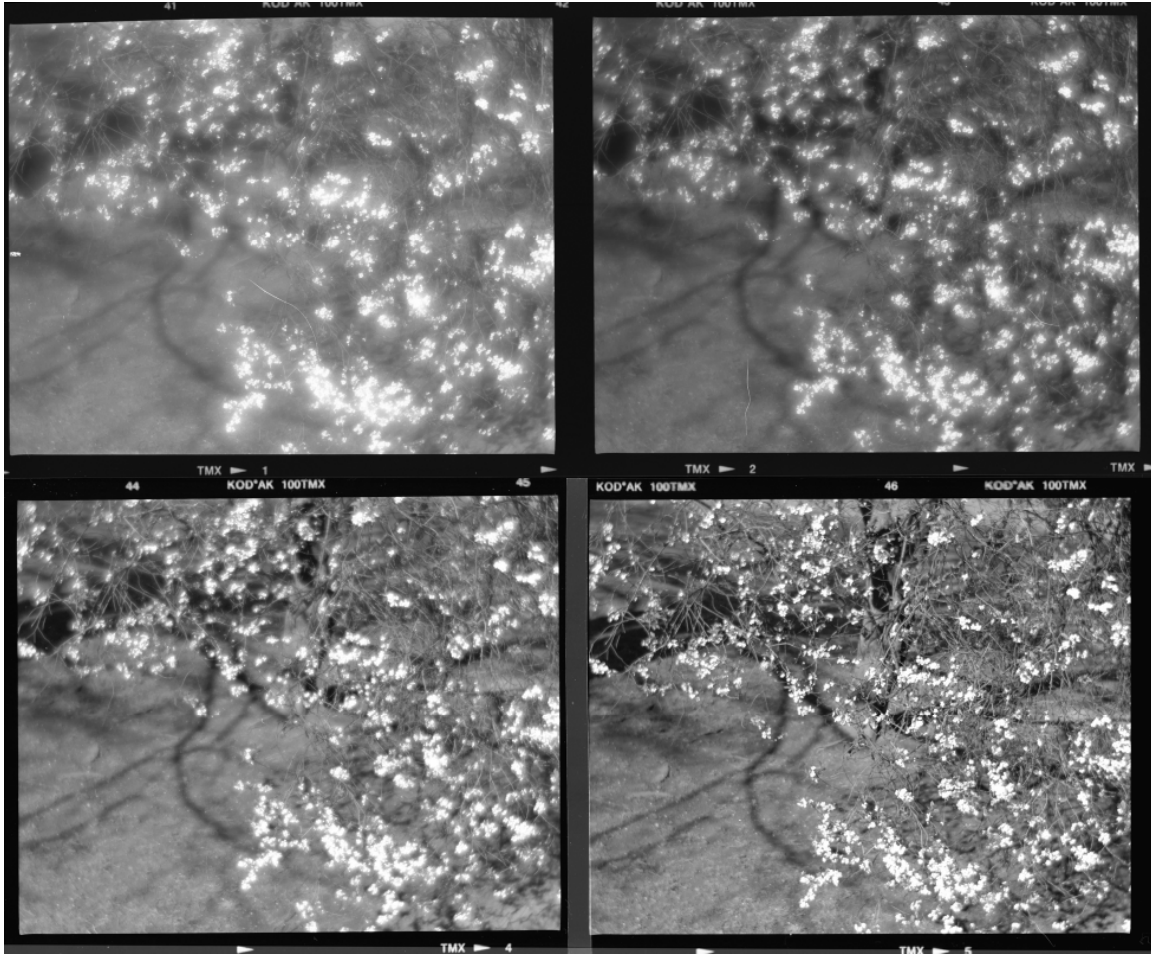

Figure 6.29: Dallmeyer *Soft Focus* 6 inch lens (an achromatic meniscus design), first sold in 1923, mounted on a Pentax 6x7 camera demonstrating the correlation between diffusion and aperture setting. Beginning at top row, left-right: f/4.5, 5.6, bottom row left-right 8, 11. It is very nearly as sharp as a normal lens at f/11. Note the large change in flare and diffusion between f/4.5 and f/5.6, only one-half stop change (photographs by the author).

Al Starkweather, Sr., characterized the appearance of a highlight with an 8 ¾ inch

Verito at different apertures as follows:

- f/16 - critically sharp
- f/11- sharp
- f/8 - too sharp for good portraits; will show skin blemishes
- f/6.3 - conservatively soft; gives a pronounced soft focus effect, most people accept without question

f/5.6 - definitely soft; gives a pronounced soft focus effect. Probably the best aperture for top quality portraits without retouching.

f/4 - very soft; should be used sparingly and only when creating a definite mood.¹⁰²

The *Verito*'s inventor, H. Oliver Bodine (American 18??-19??), noted circa 1913 that "a majority of workers in portraiture using the *Verito* for this work say that an aperture between F:5 and F:6.3 is ideal, whereas an aperture of about F:5 or F:6 gives a delightful effect for the average view."¹⁰³ Bodine and Starkweather are in close agreement 60 years apart, indicating that the changing syntax of photography in that period did not alter the use of the lens. Although Bodine's and Starkweather's comments are given relative to the *Verito*, they can be generalized to the majority of period soft focus lenses. In most cases, if they are faster than f/5.6, they are difficult to use well wide open. Nearly all achieve peak performance between f/5.6 and f/8.

John Paul Edwards, a *Verito* enthusiast, agrees that "in portraiture, with the *Verito* lens, for instance, a stop close to f-5.6 seems to give the most pleasing and rational negative." As a landscape photographer, he makes specific recommendation for "landscape work with a mellow morning or soft evening lighting, an aperture of f-4 to f-5.6 gives most pleasing results. In the more brilliant light of midday an opening of f-5.6 to f-6.3 will probably be more satisfactory."¹⁰⁴ The accuracy of such advice was not limited to the *Verito*; instructions with the Pinkham & Smith *Semi-Achromatic* lens recommended that "lighting conditions will, to some extent, govern the stop that should be used. With a flat, even lighting where there is no violent contrast between the lights and shadows, a comparatively large opening can be used. Such a lighting would be

¹⁰² Starkweather April 1972 p. 7.

¹⁰³ H. Oliver Bodine "How to Use the *Verito*" *Verito, The Lens That Improves On Acquaintance* (Rochester: Wollensak Optical Company, ca. 1913) p. unpaginated.

¹⁰⁴ Edwards 1914, p. 321.

encountered on a dull grey day or in the early morning and late afternoon in the summer. At such times, the full opening [f/4.5] of the lens might well be used with excellent success. On a sunny day, when the picture includes bright highlights and very deep shadows, a little stopping down will be found to be necessary or there will be too much halation around the high lights.”¹⁰⁵ These suggestions are equally applicable to all soft focus lenses and remain independent of the changes of syntax in film and printing media.

EXPOSURE

Correct exposure is more crucial to soft focus than normal photographic practice. Under- or over-exposure with an anastigmat, within bounds, can be compensated adequately in the printing process whereas with soft focus lenses, exposure fixes characteristics which cannot be offset later. It must be noted that the effects of over- and under-exposure are intimately tied to the film technology, especially with innovations in anti-halation backing.

Before modern light meters, judging exposure, especially in interiors or illuminated by artificial light, was often more a matter of experience than believing the available meters. Not only were metering systems primitive but precise determination of the film’s sensitivity was still in its infancy. The exposure as a variable in the entire soft focus system is often under-rated or entirely ignored and yet it can change the quality of the softness in the image to a great extent and determine whether the print is lovely, with creamy tones and delicacy or unappealing and chalky.

Although Kühn was writing specifically of the *Imagon*, his advice is fully applicable to all other soft focus lenses. He premises his analysis somewhat differently

¹⁰⁵ “An Ideal Lens for Pictorialists” a brochure (Boston: Pinkham & Smith, ca. 1916) unpaginated.

than other authors, framing it in terms of the ratio of the sharp core image to the diffuse glow around it. Because the core is brighter than the halo, “a very short [under-]exposure would only show the sharp core, the completely sharp image is then in evidence” and not the signature glow of soft focus.¹⁰⁶ Conversely, “it is clear that with too long an exposure the sharp nucleus is overexposed and halation affects the result so that the picture is deprived of its sharpness. This is a very important point, for in this case the brilliant points have become too large and have lost all appearance of reality.”¹⁰⁷ It is important to understand that the limitations of over- or under-exposure are dependent upon individual lens models as well as their general design type and the placement of focus within the acceptable band.

Under-exposure was universally warned against. Writing of using the *Semi-Achromatic*, Alvin Langdon Coburn warned that “Under-exposure (bad in any case) plays you queer pranks when the S. A. Lens is used.”¹⁰⁸ Frederick Evans was more specific: “Underexposure will not give boldness without undue opacity and loss of stuff in shadows.”¹⁰⁹ Frank Fraperie believed it exaggerated the flare,¹¹⁰ an opinion shared by Pinkham & Smith¹¹¹ and John Paul Edwards.¹¹²

Over-exposure also was undesirable although to some extent this was an issue of syntax which changed as anti-halation backing became standard for film and the move was made from glass plates to flexible film. “Softness is not to be gained by

¹⁰⁶ Kühn 1926, p. 64.

¹⁰⁷ Kühn 1928?, unpaginated.

¹⁰⁸ Alvin Langdon Coburn “Foreword” *Semi-Achromatic Lenses* brochure for Pinkham & Smith, unpaginated.

¹⁰⁹ Frederick Evans “Letter” *American Photography* (16:5, May 1922, pp 330-331, excerpted in Bunnell 1983, p. 24.

¹¹⁰ Fraperie 1925, p. 24.

¹¹¹ *An Ideal Lens for Pictorialists* (Boston: Pinkham & Smith ca. 1912) p. 3.

¹¹² Edwards 1914, p. 320.

overexposure without a loss in gradation, the planes run together and will not print in true value” according to Frederick Evans.¹¹³ Kühn believed that most problems are from overexposure, which causing “the otherwise typical luminosity, together with the sharp definition is now obviously lost.”¹¹⁴ In the 1950s, the *Veritar* manual continued the admonition against overexposure destroying the subtle sparkle of highlight gradations.¹¹⁵ A soft focus lens performs as it does because “each object in the scene is imaged sharply by one zone of the lens or by light of one wavelength, while all the other zones and wavelengths produce superimposed images, which are to some degree out of focus and therefore less likely to be exposed on the film.”¹¹⁶ However, overexposure causes the halo to merge with the central core image, resulting in an image without the underlying sharp image that sets a soft focus image aside from an image made with a diffusion filter placed in front of a sharp lens. Underexposure, if enough, will fail to register the halo at all, showing only the sharp central core on the negative.

Proper exposure is created by the correct relationship between aperture and shutter speed. The shutter therefore is critical to obtaining a good negative. The history of shutters in the 1890-1920 era is poorly defined and worth a major exposition in itself. There were dozens of shutters in the period and the development of new types of shutters had been spurred by the increasing sensitivity of films. In the studio, where light was carefully controlled both in quality and quantity by the photographer, the practice remained of simply using the lens cap or the simple form of a shutter such as the air-bulb operated *Packard* or *Studio* (which did not have calibrated speeds; the top speed was

¹¹³ Frederick Evans “Letter” *American Photography* (16:5, May 1922, pp 330-331, excerpted in Bunnell 1983, p. 24.

¹¹⁴ Heinrich Kühn *Imagon Tiefenbildner* (Munich: Optische Werke G. Rodenstock ca. 1938) p. 4.

¹¹⁵ *Portrait Veritar Lens* (Rochester: Wollensak Optical Company, ca. 1955) p. 11.

¹¹⁶ Kingslake 1989, p. 187.

approximately 1/25 second). Almost any interior image, such as Clarence White's domestic interiors or Baron DeMeyer's fashions, was unlikely to require a shutter any more sophisticated than a *Packard*-type.

Outdoor compositions, especially if in direct, bright sunlight, required a high speed shutter when shot with a soft focus lens which was only soft when used at apertures of f/8 or less. Even with as slow a film as ISO 10, the exposure required would be f/5.6 at 1/80th of a second in sunlit landscapes. Although easily possible with the focal plane shutters discussed above, there were relatively few other shutters able to realize 1/80th of a second. The *Thorton-Pickard* curtain shutter, ubiquitous in Britain, had a maximum speed of 1/90th of a second, just barely fast enough for a correct exposure. However, if the aperture was faster than f/5.6, or the film was more sensitive, the negative would be overexposed. Because of the large diameter of soft focus lenses, very few leaf shutters were large enough to accommodate them at all; large leaf shutters must move relatively slowly and the largest ones, Alphax #5 and Compound #5 only achieve 1/30th and 1/50th of a second respectively (Alphax shutters are marked at 1/50th but in reality do not reach that speed).

Inadequate shutter speeds may have been the reason so very few pictorialist images were made in direct sunlight. Clarence White and George Seeley seem to have photographed on overcast days almost exclusively; another strategy used by Seeley on occasion and Ansel Adams as well, was to use dappled light. These decisions may have been less influenced by aesthetics than by the technical consideration of correct exposure. This was a particular conundrum for the landscape photographer, where the "the most potent charm of these soft-focus lenses is when dealing with sunlit subjects; the soft

roundness of the sun-flecked tree trunks is extremely enjoyable, and is quite a revelation when compared with the comparatively hard, cut-out aspect, the edginess given to the same subject by the ordinary anastigmat.”¹¹⁷

Figure 6.30: George H. Seeley *The Burning of Rome* a masterful application of dappled light, both to lengthen the exposure time (for standard shutter speeds) and to exploit the soft focus treatment of highlights. The exposure is ‘full’ as there is detail throughout the deepest shadows but because of ‘soft’ development, the highlights also maintain detail. Photogravure from *Camera Work* № 20, 1907, reproduced 100% (collection of the author).

¹¹⁷ Evans Sept. 13, 1910, p. 261.

Figure 6.31: Ansel Adams *Lodgepole Pines* made with a nine inch Spencer *Portland* lens on 3¼x4¼ film, printed to 8x10 inches. The dappled sunlight is captured in a shimmering manner with this lens. The image loses much when reduced to this size (Ansel Adams *Examples, the Making of 40 Photographs* p. 50). Adams, despite his invectives against soft focus after 1932, continued to carry a soft focus lens in his camera case until he was no longer able to work in the field.¹¹⁸

Edward Weston's sale of his monetarily valuable Graf *Variable* lens in Mexico and subsequent purchase of an antiquated and outdated *Rapid Rectilinear*¹¹⁹ may be directly related to the fact he had only possessed a *Packard* shutter¹²⁰ and therefore could not affect an exposure faster than 1/25th of a second; the *Variable* if to be used as a 'soft'

¹¹⁸ John Sexton, letter to the author, July 5, 2002, stating that "I certainly saw a soft focus lens that Ansel had in his 4x5 case until the time he passed away... It was certainly the one that he used during his early years of photography, and suspect that it was the same lens [Portland]." Sexton was Adams' last field assistant and for many years his darkroom assistant, and is a major photographer in his own right.

¹¹⁹ His son, Brett Weston, donated this lens to the George Eastman House where the author examined it. The lens is such a cheap version that there is no manufacturer's name on it.

¹²⁰ Beaumont Newhall "Edward Weston's Technique" in Beaumont Newhall and Amy Conger eds. *Edward Weston Omnibus: A Critical Anthology* (Salt Lake City: Peregrine Smith Books, 1984) p. 109.

lens needed to be used at f/8 or faster whereas the *Rapid Rectilinear* stopped all the way down to f/256.¹²¹ Weston's previous use of soft focus lenses was limited to the reduced light of the studio and a few outdoor exposures before removing to the clear air and brilliant high altitude light of Mexico. In the Mexican sunlight, a correct exposure assuming a film speed of ASA 25 would be f/8 at 1/100th of a second or faster, thus his negatives made with any of his soft focus lenses at f/8 were at least two stops overexposed (or three stops at f/5.6, a more typical aperture for soft focus). He was unprepared for this new harsh light, unaccustomed to the brilliance and contrast, and was unable to adapt his soft focus technique to the new conditions. Furthermore, his change from long tonal range platinotype paper to a chloro-bromide paper reduced the tonal range that could be maintained in the print, diminishing the attributes of a soft focus image; this major change of syntax was not based on any new radical aesthetic revelation for Weston, but comes from his conditions: "I was broke, unsettled, and Palladiotype was expensive, did not keep well, and took five or six weeks to get since it had to be imported from England."¹²² His wife, Flora, supported him and Modotti in Mexico although at times when their boys were ill or other financially adverse events occurred, the money supply diminished. The Graf *Variable* lens they mutually used sold new for \$264.00 at the time,¹²³ a princely sum. Weston replaced it with the *Rapid-Rectilinear* for 25 pesos.¹²⁴ An alternative theory for the selling the Graf might be that the difference in the prices of the lenses was enough to support them for some time in Mexico.

¹²¹ Edward Weston, Nancy Newhall editor 2nd ed. *The Daybooks of Edward Weston* (New York: Aperture, 1990) Volume I p. 80. He notes he owned "several diffused lenses" at the time, one other being his *Verito*.

¹²² Edward Weston "Thirty-Five Years of Portraiture" 1939, in Bunnell 1983, p. 106.

¹²³ From a brochure *Graf Lenses* undated but circa 1925-1926 (Southbend, Ind.: Graf Optical Co.)

¹²⁴ Edward Weston, Nancy Newhall ed. 1990, entry for June 21st, p. 80.

Figure 6.32: Edward Weston in his Tropic studio with a 11x14 Century studio camera mounted with a Graf *Variable*, probably the same one he is photographed with in Mexico except then on a much more portable view camera. Although Newhall gives the photographer as “unknown” it is by Margethe Mather and is so credited in an undated but very early Graf *Variable* brochure (Beaumont Newhall and Amy Conger *Edward Weston Omnibus, a Critical Anthology* figure 7).



Figure 6.33: Sepia platinotype (?) portrait reproduced 100%, embossment on mount reads “E. H. WESTON TROPICO, CAL” Not a soft focus portrait but masterly use of very shallow depth of field, made perhaps before 1911 when he acquired his first soft focus lens. He owned a short focal length *Rapid Rectilinear* and this may be taken with that lens¹²⁵ mounted on his 5x7 Eastman Home Portrait Camera.¹²⁶ Probably typical of Weston’s pre-Mexico studio portrait images with low contrast, broad single-source lighting, probably a skylight (collection of the author).

¹²⁵ E. H. Weston “View from Mt. Wilson” *Photo-Era* Vol. XXIX, No.5, Nov. 1912, p. 254.

¹²⁶ Edward H. Weston “The Story-Hour” *Photo-Era* Vol. XXX, No. 5, May, 1913, p. 248



Figure 6.34: Edward Henry Weston *Toxophilus, A Decorative Study* from a poorly reproduced original, very derivative of F. Holland Day's *The Storm Good*, 1905 (*The American Annual of Photography*, 1917 follows p. 78).

Figure 6.35: F. Holland Day *The Storm God* 1905, platinum print once owned by Frederick Evans. Typical of Day's soft focus photographs which rarely contain highlights (Pam Roberts et al *F. Holland Day* p. 90)

Film, Developer and the Darkroom

The darkroom has always been the place of final aesthetic decisions. This was no less true for the pictorialists, many of whom were total masters of the darkroom environment. Film cannot be discussed without developer as the two must work in a

salutary manner. As the technology of film changed, some developers became far from optimal.

When developing isochromatic or orthochromatic films, a red or orange safe light could be used and the progress of development could be visually monitored. Until Alfred Watkins suggested 'factorial development' in 1893,¹²⁷ all development was 'by inspection,' that is, the photographer examined the plate during development by the illumination of the safe light and ceased development when the image appeared to possess the correct appearance. Watkins proposed that the total time could be determined by noting the time required for the appearance of the first trace of an image on the plate and then multiplying by a factor to determine the total time of development. This system was considered very reliable once a modicum of experience had been gathered and did not risk safelight fogging since the safelight only illuminated the plate until the first trace appeared and could take into account the variations in film emulsion manufacture.

After the researches of Ferdinand Hurter (Swiss 1844-1898) and Vero Charles Driffield (1848-1915) were published and the foundation for photographic sensitometry was established,¹²⁸ the 'time and temperature' system was introduced whereby a chart could be consulted to determine the development time at a given temperature and the density that would result. This required no inspection by safelight and was therefore nearly a necessity for panchromatic plates for which there was no color of safelight which would not expose the film; rising film sensitivity also mitigated against any but the

¹²⁷ Bernard Jones, ed. *Encyclopedia of Photography* 1911 (reprinted New York: Arno Press, 1974) entry for "Development, factorial" pp. 174-175. See also *The Photo Miniature*_Vol. VI, No. 66, Sept. 1904 for practical applications.

¹²⁸ Ferdinand Hurter and Vero C. Driffield *Photochemical Investigations and a New Method of Determination of the Sensitiveness of Photographic Plates*_published May 7, 1890. This publication was directly responsible for P. H. Emerson renouncing his stand that photography was an art.

briefest forms of development by inspection. Due to the lack of accurate exposure meters, many photographers compensated during the development process but once development by inspection was no longer viable, the problem of less than optimal negatives probably soared. Kühn still recommended development by inspection in the late 1930s and considered the ‘time and temperature’ method “useless.”¹²⁹

Virtually all sources agree that “anti-halation negative material is... an absolute necessity”;¹³⁰ the high flare level would exacerbate the tendency of regular plates to halate severely around brilliant highlights. There was less than unanimous agreement on the use of panchromatic negative material, however. Panchromatic film could not be developed by inspection, had to be handled in total darkness and was often far slower than orthochromatic films (not always a disadvantage with a soft focus lens outdoors). None of the period films were truly panchromatic and the extent to which they approached that goal varied by manufacturer and time period. Especially for landscapes, there was no compelling spectral reason to choose them as long as a yellow color screen was utilized.¹³¹ As late as 1937, Kühn saw reason to still use orthochromatic films: “The pan [panchromatic] layer, as well as that which is slightly sensitive to red and which is in general much to be preferred, brings more brightness into the pictures, because it is sensitized for all color tones: it often brings, however, the middle tones very close to one another, thereby rendering the differentiation of the gradations of brightness more

¹²⁹ Heinrich Kühn *IMAGON Plastic Depth lens sees like the artist's eye* (Munich: Optical Works G. Rodenstock, no date) unpaginated.

¹³⁰ Kühn *IMAGON Plastic Depth lens sees like the artist's eye*, unpaginated.

¹³¹ Edwards July, 1914, p. 317.

difficult. In such cases, the ortho layer retains the advantage of better dispersing power.”¹³²

Prints were made by contact or enlargement. A contact print allows the use of emulsions too insensitive for enlargements, which in the 1890-1920 period would include platinum and palladium prints, gum-bichromate, oil, carbon, kallitype, cyanotype, albumen, printing-out paper and silver chloride papers. “Platinum was used because it was by far the finest printing medium in this respect; its dull surface, its magnificent reproduction of the gradation of the negative, its delicacy of highlights, its depth of shadow - these qualities are not rivaled by any other printing medium,”¹³³ especially the enlarging papers which were much more light sensitive and inherently possessed tonalities less than the contact papers. In 1930 the ratio of tonal gradations possible for various papers included: bromide (enlarging) paper 1:40-1:60, printing-out paper 1:60, carbon 1:80 and platinum 1:100.¹³⁴ Not only is there a direct correlation between sensitivity and tonal range but some of the processes were ‘self masking’ which preserves a longer tonal range. Within the selection of enlarging papers, gelatino-chloride (gas light) papers inherently have the capacity for a longer tonal range than silver-bromide paper.¹³⁵ The higher sensitivity of enlarging papers required a safe light in the darkroom whereas most of the contact papers could be handled in moderate room light; enlarging papers could easily be exposed by artificial light sources, including gas lights, a boon to the amateur who could then work at night. Most amateurs in the era used enlarging paper

¹³² Heinrich Kühn “Clearness” *The German Annual of Photography 1937* (Berlin: Bruno Schultz, 1936) p. 8.

¹³³ Paul L. Anderson “Some Pictorial History” *American Photography*, Vol. XXIX, No. 4 April, 1935 p. 202.

¹³⁴ Clerc 1930, p. 317.

¹³⁵ Clerc 1930, p. 339.

to make contact prints by gas light. Enlarging was largely limited to professional use (the Viennese pictorialists of the 1890s were an exception and made unusually large gum prints) and enlargers were not a mature technology until the advent of miniature cameras in the 1930s forced the photographic industry to re-think and re-engineer both the enlarger and enlarging lenses. Regardless of whether made by contact or enlargement, preservation of the shimmering nature of the soft focus highlight demanded a delicate timing in the printing; too much exposure would take the life out of the “vibrating quality of light”¹³⁶ and too little produced a flat, dead, pale print. Printing required introspection and careful study, “the final stage, the print, requires quiet contemplation time, in fact, for its fullest expression.”¹³⁷

¹³⁶ Paul L. Anderson *The Technique of Pictorial Photography* (Philadelphia: J. B. Lippincott Company, 1939) p. 65.

¹³⁷ Alvin Langdon Coburn “The Relation of Time to Art” *Camera Work* 36, 1911 reprinted in Roberts 1997, p. 599.

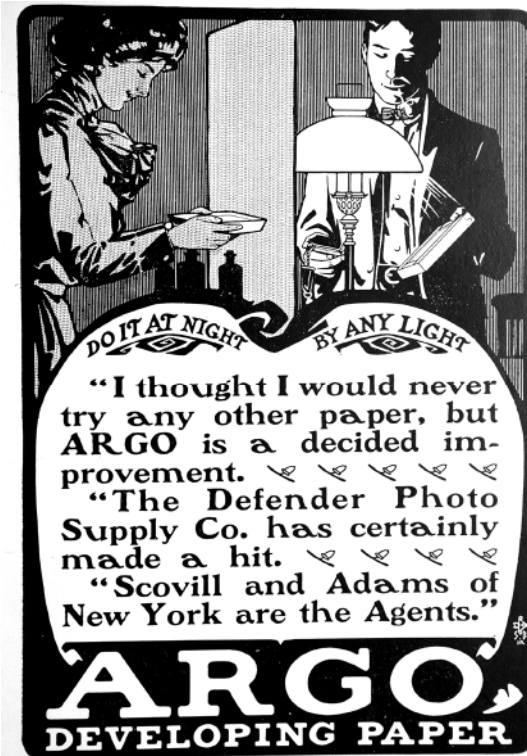

Figure 6.36: A 1902 risquély worded advertisement for printing paper sensitive enough to be contact printed by gas light, clearly designed to appeal to the genteel amateur photographers who practiced their hobby at home (*The American Annual of Photography and Photographic Times Almanac for 1902* advertising section)

The contact print has no intervening optics between the negative and the printing paper, insuring the highest level of transfer of information, including preservation of tonality. The scale of the print was related to its intended display method, large prints intended for the wall and contact prints which “were created for the collector's portfolio, to be held in the hand while looking at them.”¹³⁸ W. B. Post created platinum prints as small as 1³/₈x 7⁷/₈ inches, probably influenced by J. M. Whistler’s philosophy of print size. Frederick Evans, Alfred Stieglitz, Edward Weston, Clarence White and many others

¹³⁸ Ernst Juhl “Edward Steichen” *Die Photographische Rundschau* 16 (July 1902) pp. 127-129, quoted in Newhall 1981, p. 176.

produced most of their images as contact prints,¹³⁹ nonetheless John Paul Edwards counseled “do not expect to get the full charm of diffused-focus work in a small contact print.” He recommended 8x10 for viewing in the hand and 10x12 or 11x14 as “ideal sizes for exhibition work or for home walls.”¹⁴⁰ Steichen, informed by contemporary painting, frequently made prints as large as 19x13 inches (*The Little Round Mirror*, 1905, gum over platinum) and the Hoffmeister brothers, Theodore and Oskar, printed extraordinary multi-colored gum prints as large as one meter in length.¹⁴¹ There was no clear pictorialist aesthetic regarding print size although it would appear there was a direct correlation between large prints and darkroom virtuosity.

Obviously, large negatives were likely to be contact printed whereas smaller negatives were more likely to be enlarged, either directly or by the creation of an inter-negative¹⁴² which could then be contact printed. One of the most dramatic changes in photographic syntax between 1900 and 1930 was the dramatic rise in the use of smaller formats, such as 2¼ x 3¼ among amateur photographers (at the expense of larger formats, especially 5 x 7 and 8 x 10); contact printing utilizing long tonal range processes such as carbon and platinotypes virtually vanished from the photographic scene. It must be noted that most pre-World War I development instructions are probably oriented towards a negative that will contact print well on platinum, a quite contrasty negative compared to one which would produce a quality silver enlargement.

¹³⁹ Ansel Adams *The Print, Contact Printing and Enlarging* (Boston: New York Graphic Society, 1950) p. 5.

¹⁴⁰ Edwards July, 1914, p. 322.

¹⁴¹ Patrick Daum, Francis Ribemont, Phillip Proger eds. *Impressionist Camera, Pictorial Photography in Europe 1888-1918* (London: Merrell, 2006) p. 298

¹⁴² Paul Strand's photographs reproduced in the last issues of *Camera Work* were originally 3¼x4¼ negatives enlarged on to 11x14 glass plates. Even in the reduced size reproduced in *Camera Work*, they are unsharp. Many of Stieglitz's finest images before World War I (such as “Winter, Fifth Avenue”) were originally taken as lantern slides and later made into prints via enlarged negatives

Regardless of the decision to contact print or to enlarge, photographers were unanimous in recommending ‘soft’ development, that is, slow with a minimally active developer; the maxim was “the softness given by the lens should be supplemented by the development, to give a harmonious, well-graded negative.”¹⁴³ Two popular developers of the 1880s were so universal in application that they continue to be used today: an Agfa developer, *Rodinal*® (para-amido-phenol), and pyrogallic acid (1,2-3 trihydroxybenzene). *Rodinal*® was invented by an Agfa chemist, Dr. Momme Andresen, in 1891.¹⁴⁴ A popular developer known for its high edge acutance, superb tonal gradation, low fog level and long shelf life, it was sold continually until Agfa discontinued it in 2006, making it the longest-lived trade-marked developer in history. When used at dilutions of 1:100 or 1:200, it is a compensating developer with few equals. *Rodinal*® was used by John Paul Edwards,¹⁴⁵ Heinrich Kühn,¹⁴⁶ Clarence White¹⁴⁷ and many others, remaining a popular developer among large format photographers into the twenty-first century.

Nearly every English or American darkroom handbook of the pictorial era will contain several “pyro” formulas; it was first used as a developer in 1851¹⁴⁸ and it is once again in vogue amongst advanced large format workers in the 21st century; Frederick Evans¹⁴⁹ and Edward Weston¹⁵⁰ used it exclusively through their careers. Tennant suggested use of either pyro or *Rodinal*® in the pictorialist’s darkroom.¹⁵¹ The pyrogallic

¹⁴³ Tennant 1921 p. 169.

¹⁴⁴ Eder 1978, p. 434.

¹⁴⁵ John Paul Edwards “Soft Focus Portraits” *BJP* Sept. 18, 1914 p. 707.

¹⁴⁶ Kühn *IMAGON Plastic Depth lens sees like the artist’s eye*, unpaginated.

¹⁴⁷ Anderson April, 1935, p. 208.

¹⁴⁸ Eder 1978, p. 330.

¹⁴⁹ Frederick Evans in a speech to the RPS, April 25th, 1900, reprinted in Newhall 1981, p. 179.

¹⁵⁰ Newhall 1993, p. 63.

¹⁵¹ Tennant December 1921, p. 169.

acid based developers are “quite hard to control and not always predictable when applying time-temperature development.”¹⁵² It was best utilized when developed by inspection such that the progress could be constantly monitored. It has particular strengths not shared by other developers; “early morning, late evening, bright lights, strong back lights, very detailed highlights and all atmospheric effects will be enhanced by pyro.”¹⁵³ This reads like a catalog of the pictorialists’ preferred lighting conditions were it not written in 1992. It also produces a negative that results a superior print in platinum or palladium, the chief printing media of the early pictorial photographers and “have an uncanny ability to adapt to differences in contrast in the original scene.”¹⁵⁴

Either the highly compensating *Rodinal*® or the long-gradation pyro developers preserve in a negative that prime characteristic of soft focus lens images: the dual-nature highlight composed of the sharp central image overlain by the diffuse halo. Since these are at the far white end of the tonal range, it requires development which can maintain that dual nature. Unless superior highlight separation can be provided by the developer, one of the prime attributes of the soft focus lens is lost. These two developers are especially well qualified for that key task.

¹⁵² Ansel Adams *The Negative* (Boston: Little, Brown and Company, 1981) p. 233. Despite his reservations, it is the first developer listed in his “Appendix” in his first book *Making A Photograph* published in 1935 and maintains that position in the 1948 revision. As far as can be discovered, Adams never comments on the use of *Rodinal*, an odd omission.

¹⁵³ Gordon Hutchings *The Book of Pyro* (Granite Bay, CA: the author, 1992?) p. 8.

¹⁵⁴ Richard Sullivan and Carl Weese *The New Platinum Print* (Santa Fe: Working Pictures Press, 1998) p. 20.

SUMMARY

The soft focus lens appears beguilingly simple, the same as any other lens, yet if they were treated as an ordinary lens, frustration and poor results were certain results. Amateurs and professionals alike expected to take a lens out of the box and use it immediately whereas working with the soft focus lens would require substantial adjustments of techniques which could only be gained by experimentation and experience. The *Verito* lens motto was “the lens that improves on acquaintance” and this could be equally applied to all soft focus lenses, then and now. Some were considerably more difficult to master than others, such as the Pinkham & Smith *Semi-Achromatic* but if they are to be judged by results, the more complex lenses yielded superior prints.

Because of their diameter, weight and longer than normal focal length (to cover a given format), these lenses would not fit many camera in use by amateurs. The image needed to be viewed directly; thus many otherwise excellent hand cameras were unsuitable. Especially with larger formats, the lenses were too large to fit into any shutter or the shutters they fit were too slow to yield a correct exposure in daylight.

Composition was radically different as well. Even though there is a sense of enhanced depth of field, one plane needs to be selected as the sharpest focus and a thorough realization of the rendering of the degrees of out of focus was required, all requiring considerably more forethought and insight than the standard mode of stopping the lens down until nearly everything was in focus. The ‘best focus’ is actually a band and the photographer needed to be cognizant of the varying effects of focus placement along that band. All of this contravened regular practice.

Soft focus lenses demanded additional degrees of accuracy both at the time of exposure and in the development. If the exposure was either too great or too little, the quality of diffusion was adversely affected. In the darkroom, development by inspection was *de rigueur* to insure that the negative was neither under developed nor worse, over developed. In order to retain tonal separation in the delicate highlight values, soft acting developers were the sole alternative.

In short, if a photographer was not willing to experiment with methods variant to standard procedures, the results from the use of soft focus lenses was far from optimal.

Chapter Seven: The Demise of the Soft Focus Lens in Particular and Pictorialism more Generally

There were several other such [soft focus] lenses in use some years ago but they went almost entirely out of popular favor. The craze for soft focus lenses grew until it went to an absurd extreme. Then the pendulum swung over the other way and went to almost as absurd an extreme in the direction of excessive sharpness and detail. Now there are signs that the soft focus lens is coming back into popular favor and therefore it is advisable that the reader should know something about the history of and the reasons for using such lenses.¹

Frank R. Fraprie (1940)

Pictorialism has always been an elusive term, even contemporaneously, “It is very difficult to get two people to agree as to what constitutes ‘Pictorial Photography.’”² With the benefit of nearly another fifteen years of thought, Gillies found it was still “a very difficult thing to define.”³ In general, the Pictorialists defined themselves not as a specific philosophy but as a counter-point to that which had preceded them, that which they had rebelled against, in the same way the f/64 Group would define itself as “An informal association founded in response to the prevailing Pictorialist school of the early twentieth century.”⁴ Considered at its broadest level, the movement included a diverse group of photographer-image makers diffused unevenly across most of Western civilization. At the time, a definition acceptable to most participants would have been the acceptance of photography as an individual art, with no specification as to media or method, as Stieglitz defined his Photo-Secession’s goal “to compel its recognition, not as the handmaiden of

¹ Fraprie 1940, pp. 32-33.

² Will A. Cadby “The Future of Pictorial Photography in Great Britain” *The Amateur Photographer & Photographic News* December 14 1909, p. 575.

³ John Wallace Gillies *Principles of Pictorial Photography* (New York: Falk Publishing Co., 1923) p. 50.

⁴ Ansel Adams *Examples: the making of 40 photographs* (Boston: Little Brown and Co., 1983) p. 175. This is the ‘Glossary’ definition of *Group f/64*.

art, but as a distinctive medium of individual expression.”⁵ There was a manner of treatment involved, too evident to the participants to bother to codify in text, that was derived from Emerson, “when the intention is merely and purely to produce a beautiful thing,”⁶ who in turn had paraphrased Whistler.

A survey of modern photohistorians reveals coherence in defining Pictorialism as incorporating the element of diffusion. Curator Christian Peterson defined it, in part, as “*de rigueur* for pictorial images to be carefully composed, softly focused, and low in tonality ... Soft-focus effects were universally used to suppress detail and to emphasize mass. Softly focused pictures did not seem of the real world and allowed pictorialists to escape into imagined dreamscapes.”⁷ William Crawford, the developer of the concept of syntax in photography defined it as “Expressive printmaking, matte surfaces, and the optically softened image.”⁸ Historian, professor and photographer S. Carl King produced a very encompassing definition, one element of which was a “Tendency toward the suppression of detail, resulting in an impressionistic rendering of the scene,”⁹ accurately pinpointing the early Pictorialists’ motivation for diffusion and qualifying the concept with “tendency.” King is correct, and almost alone, in not defining Pictorialism with the certainty of diffusion as some workers who were clearly Pictorialists, such as Guido Rey, created *only* sharply focused images, and some such as Alice Boughton created both sharp and gently diffused prints. Clarence White made sharp photographs such as *Lady in*

⁵ Alfred Stieglitz “Pictorial Photography” *Bausch and Lomb Lens Souvenir* 1903 reprinted in Sara Greenough and Juan Hamilton *Alfred Stieglitz, Photographs and Writings* (Washington: National Gallery of Art, 1983) p. 190.

⁶ Emerson 1899, p. 188.

⁷ Christian A. Peterson *After the Photo-Secession, American Pictorial Photography, 1910-1955* (Minneapolis: The Minneapolis Institute of Arts, 1997) p. 16. Peterson seems to be considering the later generation of pictorialists in the later portion of that definition.

⁸ Crawford 1979, p. 85.

⁹ S. Carl King *The Photographic Impressionists of Spain* (Lewiston, NY: The Edwin Mellen Press, 1989) p.

Black with Statuette, 1908, or *Boys Going to School*, 1908, as did Alvin Langdon Coburn *Road to Algeciras*, 1908. Kühn explained that soft focus lenses were slow to catch on in Germany and Austria because of the wide spread use of gum printing and “only one lens... [the] Eidoscope by Hermagis in Paris, received, in the hands of German photographers, lasting use”¹⁰ yet there were significant Austrian and German pictorialists. Curator and museum director Douglas Nickel’s definition “Pictorialism was therefore not a style, but a shared sensibility reflecting an ideological crisis within modernity; its Romantic reassertion of individual temperament, its antiempirical alignment with Symbolism, and its (typically) Whistlerian promotion of mood over intellect could find expression through any number of visual means”¹¹ is vague as was the movement itself, and yet this may constitute the most accurate definition of Pictorialism. It is crucial to comprehend that *all soft focus was encompassed within Pictorialism, but not all Pictorialism was soft focus.*

It is without reward to seek a useful definition in either Newhall or Gernsheim. Beaumont Newhall never used the term ‘pictorialism’ in either *Photography 1839-1937*¹² or *The History of Photography from 1839 to the present day* (1964 edition). *Proto-Modern Photography*,¹³ the final exhibit Newhall curated, contained soft focus photographs by Coburn (10 prints), Pierre Dubreuil (3), Steichen (2), Struss (3) and Weston, yet there was never the occurrence of the word ‘pictorialism’ in any of the labeling. Instead he invented the new term ‘proto-modern’ as a substitute. Newhall was

¹⁰ Kühn 1926, p. 61.

¹¹ Douglas Nickel *Photography at Princeton* (Princeton, NJ: The Art Museum, Princeton University, 1998) p. 68.

¹² It is interesting to read the list of contemporary (1937) photographers shown by Newhall and wonder who they were as so few are recognizable names today.

¹³ Steve Yates “Proto-Modern Photography” ex. cat. Museum of Fine Arts, Santa Fe, New Mexico, 1992.

simply unable to use the word ‘pictorialism’ although he used ‘Photo-Secession’ freely in his life of writing about photography; for the Newhalls, the art movement in photography was solely the provenance of Stieglitz’ Photo-Secession. As for Helmut Gernsheim, when the index in *The History of Photography 1685-1914* is consulted under ‘pictorial photography’ (he cannot use the word ‘pictorialism’ either), it notes “see ‘art’ photography,” which refers to Rejlander, Robinson and Cameron, not Pictorialism, which is categorized as ‘the aesthetic movement.’

The etymology of ‘pictorialism’ is not perfectly clear, as King noted “Although the term pictorial was first applied to photography by H. P. Robinson in the 1860s, his understanding of the word was more closely related to the picturesque than to pictorialism as it is used today.”¹⁴ Robinson’s ‘picturesque’ is antithetical to Pictorialism in that it was heavily dependent on ‘picturesque’ subject matter, whereas Pictorialism “is not dependent on the subject of the photograph for its value and power as art; indeed, the subject need not be recognizable for the pictorial photograph to be successful,”¹⁵ a statement in total congruence with Whistler’s philosophy. Prof. Peter Bunnell proposed that the term ‘pictorialism’ with its more usual connotations originated in Emerson’s 1886 paper, “Photography, A Pictorial Art,”¹⁶ an idea that withstands careful scrutiny.

The reasons for the decline of soft focus lenses and Pictorialism more generally are far more complex than the simplistic ‘triumph of modernism’ explanation. To some extent, it had simply run its course- no art movement lasts forever and its leading lights

¹⁴ King 1989, p. 5.

¹⁵ Katherine Thayer “Embracing Beauty; the Post-Postmodern Pictorialist Landscape Photograph” *Lens Work* No. 53 June-July 2004 p. 28. Thayer is a master gum printer and unrepentant pictorialist. This is the finest article in the last fifty years defining the goals and vision of Pictorialism.

¹⁶ Peter C. Bunnell *A Photographic Vision, Pictorial Photography, 1889-1923* (Salt Lake City: Peregrine Smith, Inc., 1980) p. 2.

died or became elderly. The deleterious effects of World War I reached nearly every photographer on earth (and Pictorialism was the first international photographic movement), creating material shortages (cameras, film, paper, chemicals) and restrictions on where photographs could be taken. The use of platinum in detonator fuses for artillery drove the price up until platinotype paper was unaffordable.¹⁷ Less often credited with assisting in the fading of soft focus lenses and Pictorialism was the progress in technology which led to ever smaller cameras and a general lowering of standards. The international nature of pictorialism made it difficult to generalize to all countries; whereas it may have been fading away on the East Coast of the United States and in Britain by 1910, it was still a healthy and vital movement in California, Belgium, Czechoslovakia, Spain, Japan and elsewhere well into the 1920s. The second and third generation pictorialists were not as refined in their use of soft focus lenses as the originators, often without any subtlety or technical command, and by the third generation, usually relied on darkroom techniques rather than lenses to produce diffusion. It is quite evident that the second and third generation failed to study (or at least learn from) the exemplars produced by their forebears.

The 1913 Armory Show introduced European Modern Art to America and is often cited as a cause for the change in American photography. It certainly did influence Stieglitz, always the aesthetic follower rather than a leader (in this case, being led by Steichen on modern art), who followed this new trend the same way he had followed the trends of forming a dissenting art organizations ('Photo-Secession'), platinum printing, soft focus, etc. As a very public sign of his disenchantment with his past, he renamed the

¹⁷ Mike Ware "The Eighth Metal: The Rise of the Platinotype Process" in *Photography 1900: The Edinburgh Symposium*, Julie Lawson, Ray McKenzie and A. D. Morrison-Low eds. pp. 106-109.

traditionally titled 'Little Galleries of the Photo-Secession' to an impersonal, non-descriptive but very modernist '291.'

The Albright Exhibition, 1910

The 'International Exhibition of Pictorial Photography,' held during November and December, 1910, at the Albright Art Gallery, Buffalo, New York, showcased 584 prints, 80% were by Stieglitz's Photo-Secession comprising 37 photographers.¹⁸ The exhibit was fleshed out by images from 28 "new" photographers in the other grouping.¹⁹ Painter Max Weber, an instructor at the Clarence White School, designed the exhibit such that in Linked Ring style, as devised by Frederick Evans, the photographs were hung on the line and grouped by photographer. Contrary to Stieglitz' stated aversion to commercialism, 77 of the photographs were sold, 65 to the public and 12 to the museum itself; perhaps it was deemed forgivable to sell a photograph as art, although not to be used for advertising.

Purportedly the show "gave all American photographers an opportunity of being represented" but as the editor of *Photo-Era* pointed out, there were many major American photographers absent from the show.²⁰ It had already been printed in an earlier issue, even before the show opened, "the attitude of the Photo-Secession towards those not of the fold. It is always a cause for mirth to see a group of workers arrogate themselves all title to excellence, but it is equally a cause for regret to see them carry arrogance to the

¹⁸ Bunnell 1998, p. 322.

¹⁹ Walter E. Bertling in a review of the show gave a sound reason for the general lack of foreign representation: 'the peculiarities of our custom-house system which made it impracticable officially to open the invitation-section to foreign exhibitors.' "The Albright Art Gallery Exhibition" *Photo-Era* Vol. XXVI No. 1, January 1911, p. 13. For an exhibition entitled 'International' this is certainly a major flaw.

²⁰ Editor Wilfred A. French at the end of the article cited above.

verge of insult.”²¹ Walter Zimmerman, a recognized and well exhibited ‘independent pictorialist’ wrote that the situation was such that “the independents, therefore, have pretty generally refused to exhibit.”²² As a result, not only was the ‘independent’ section lacking representation of major workers, but those who were shown included “many photographers whose names are now mysteries to all but the most specialized scholars.”²³ Stieglitz was so locked into the myth of Photo-Secession superiority that not even his old friend P. H. Emerson, one of the founders of the pictorial movement, was included. Modern photohistorian Ulrich Keller went so far as to propose that the Photo-Secession did not stand for anything in specific but rather existed in order to create a sense of exclusiveness.²⁴ The Albright exhibition drove a permanent wedge between Stieglitz and the rest of the American pictorial community, loosing the cohesion and purpose with which Stieglitz had imbued it.

The alienation of the broader pictorialist community was not the only permanent disaffection resulting from the show. More importantly, disagreements of various sorts caused highly visible Photo-Secessionists Clarence White, Alvin Langdon Coburn and Gertrude Kasebier to secede and in 1916, form another photographic movement, ‘Pictorial Photographers of America’ which produced credible annual year books through 1926. “True to its name, it initially promoted traditional, soft-focus work... however, the PPA began embracing other forms of photography”²⁵ thereby promoting the demise of the soft focus lens. Chief motive force Clarence White’s unexpected death in 1925

²¹ Wildred A. French “Editorial” *Photo-Era* Vol. 25 No. 3, September 1910 p. 135.

²² Walter Zimmerman “The Photo-Secessionists and the Independents” *Photo-Era*, Volume XXV, No. 3, Sept 1910 p. 135

²³ John Szarkowski *Alfred Stieglitz at Lake George* (New York: Museum of Modern Art, 1995) pp. 9-10.

²⁴ Ulrich Keller “The Myth of Art Photography” *History of Photography* Volume 8 No. 4 October-December 1984 p. 260.

²⁵ Peterson 1997, p. 91.

hastened the end of the organization and American pictorialism never found another credible leader again;²⁶ Nancy Newhall thought “the last of their former standards died with him.”²⁷ As a national movement Pictorialism had evaporated almost completely and settled in to the camera clubs and their salons that would remain its retro-grade home for decades.

After the Albright show Stieglitz increasingly turned his engagement to other art forms, maybe not so much because of any philosophical shift, but perhaps because he made himself so unwelcome in so many photographic circles. Photography may have temporarily become moribund for Stieglitz personally, and although he published sixteen of his own images in *Camera Work*²⁸ and hung a show of his old images in 1913, there was no new work shown until his next public exhibition a decade later in 1921 (of a total of 146 prints, 21 were dated before 1910 although most had not been heretofore shown, and most of the new work was composed of the detailed nudes of his new lover, Georgia O’Keeffe).²⁹

Nancy Newhall wrote of the 1910 Albright exhibition “The Strumpet in her Pictorial guise had a splendid funeral. Everyone knew this was the death of the Photo-Secession...”³⁰ and “Pictorial Photography in the States was dead if not worse.”³¹ This was predictable as the Newhalls were unable to distinguish between the ‘Photo-

²⁶ After White’s death, although his wife became director of his photographic school, the school lost its momentum and *raison d’être* with no ‘big name’ instructors on its faculty and very few students who would be recognized today.

²⁷ Nancy Newhall *P. H. Emerson the Fight for Photography as a Fine Art* (New York: Aperture, 1975) p. 121. In her inimitable way, she describes PPA founders as “the weak, lacking their great leaders [by which she means Stieglitz], forlornly huddled together and formed the Pictorial Photographers of America.”

²⁸ *Camera Work* No. 36, October, 1911, which showed the modernist tact he was taking in direct opposition to pictorialism. Most could be considered ‘snapshots,’ the diametric opposite of the carefully studied pictorialist images.

²⁹ Whelan 1995, p. 147.

³⁰ Newhall 1975, p. 117.

³¹ Nancy Newhall 1975, p. 121.

Secession' and the wider world of 'pictorialism.' Certainly not everyone, even in Stieglitz' own circle, believed that the Albright show was an ending to the two decade old movement. Stieglitz' resident art critic, Sadakichi Hartmann, wrote in his review "this spirit will not fade... the spirit will continue to remain an active force, and produce fresh impressions of light and tone, of form and grace."³² Stieglitz himself did not see this as the end as he published some of the most famous *Camera Work* images after 1910: Heinrich Kuehn (#33, 1911), Edward Steichen (#34/35, 1911), David Octavius Hill & Robert Adamson (#37, 1912), Anne Brigman (#38, 1912), Karl Struss, the final member of the Photo-Secession (#38, 1912), Paul Haviland (#39, 1912), Baron Adolph DeMeyer (#40, 1912), Julia Margaret Cameron (#41, 1913) and Edward Steichen (#42/43, 1913), all of which were decidedly soft focus. These Hill and Adamson and Cameron images were the only historic photographs ever reproduced in *Camera Work* and certainly *should* have reinforced the diffused image aesthetic; had Stieglitz been receptive when J. Craig Annan began the resurrection of their reputation in 1890 at the massive Hamburg exhibit, they would have been published at the outset of *Camera Work*, a much more appropriate position to inform the beginnings of the new movement rather than at the end of that journal's involvement with photography. If Stieglitz had really turned against the diffused image, when then would he publish these exemplars?

The Albright exhibition certainly did not mark the end of Pictorialism although it may be fair to propose that 1910 marked the high point of the movement. There are very few images that could be considered pictorial masterpieces made in America or Britain after 1910. Dudley Johnston, an astute observer of the time, thought Coburn's

³² Sadakichi Hartmann "What Remains" *Camera Work* 33, reprinted in Roberts 1997, p. 560.

masterpiece, *Weir's Close*, marked the culmination of Pictorialism in 1906, four years earlier.³³

Figure 7.1: Alvin Langdon Coburn *Weir's Close* from *Camera Work* 15, 1906, scanned from an original photogravure (collection of the author). Exposed during Coburn's 1905 visit to Edinburgh on 8x10 film with a soft focus lens "made specially for me,"³⁴ certainly a Pinkham & Smith modified *Semi-Achromatic*. It must rank as one of the great masterpieces of pictorial photography and was exhibited in the 1910 Albright exhibition.³⁵ It is not Weir's Close, which had been demolished before 1905, but may have been given the title by Coburn because of the association of Major Weir and supernatural tales of Edinburgh, creating an image "terrifying and spectral."³⁶ Stieglitz considered it "especially fine" as late as 1924, indicating he still found virtue in the diffused image a decade after he supposedly refuted that aesthetic.³⁷

³³ Johnston December 1923, p. 581.

³⁴ Alvin Langdon Coburn "Photography Through the Years" typescript, George Eastman House Coburn Box 13.

³⁵ Bertling January 1911, p. 16.

³⁶ Tom Normand "Alvin Langdon Coburn, Robert Louis Stevenson and Edinburgh" *History of Photography* Volume 29 No. 1, Spring 2005, p. 54.

³⁷ Mike Weaver *Alvin Langdon Coburn, Symbolist Photographer* (New York: Aperture Foundation, 1986) p. 57, quoting a letter from Stieglitz to J. Dudley Johnston, dated June 25, 1924 in the RPS archive.

Photography in Britain

In numbers of active pictorialists, Britain was second only to the United States. Home of the Linked Ring, it had led the charge of the photographic art movement at its inception in the 1890s, garnering the opprobrium “the home of the higher pictorial photography.”³⁸ It was stimulated further by F. Holland Day’s landmark London exhibition in 1900, ‘The New School of American Photography’ with 360 prints by cutting-edge American pictorialists which “had a tremendous influence upon British photography, with the result that during the next six years pictorial photography reached a high level that it has never quite touched again.”³⁹ After that, however, the direction and velocity of British pictorialism was altered irrevocably by the 1908 Linked Ring annual exhibition wherein a dominantly American selection committee rejected the vast majority of English contributions; 128 of these rejected British images were obtained by F. J. Mortimer (England 1874-1944), editor of *Amateur Photographer*, who then hung an impromptu ‘Photographic Salon des Refusés’ with them, also in London. In consequence, the main annual London 1910 exhibition was the ‘London Salon’ rather than the Linked Ring’s salon, and Francis. J. Mortimer was now firmly ensconced in English photographic politics and remained in a position of power until killed by a German flying bomb in 1944.⁴⁰ As a direct result of this internecine dispute, the Linked Ring dissolved

³⁸ Alfred Stieglitz “The Progress of Pictorial Photography in the United States” *The American Annual of Photography and Photographic Times Almanac for 1899* (New York: The Scovill & Adams Company, 1899) p 158.

³⁹ J. Dudley Johnston “Photography- Pictorial Photography” 14th ed. *The Encyclopaedia Britannica* (Cambridge: University Press, 1929) p. 832.

⁴⁰ For an excellent and balanced account of this see John Taylor *Pictorial Photography in Britain 1900-1920* (London: Arts Council of Great Britain, 1978) pp. 9-13.

and innovation in British photography was replaced by stolid conservatism. The Linked Ring had been the *de facto* lead in avant-garde photography, not only because it was so dynamic but because there was no other organization or person of similar position. When it unlinked, there was suddenly a power vacuum and Mortimer fell into position of leader, although it might be more accurate to term him an ‘arbiter’ of pictorial tastes who by virtue of his long tenure as editor was able to define pictorialism by what he included as well as what he excluded. He stated his philosophy unequivocally in commenting on criteria for the Salon des Refusés, “the progress of art will not be advanced by startling innovations or by the endeavor to gain ephemeral notoriety by means of the artist's high vocation, but by the gradual and keener perception and expression of nature and beauty, apart from mere temporary art crazes and artistic shibboleths.”⁴¹

Sensing “a feeling of unrest has possessed those photographers in England who may be entitled to the designation of ‘pictorial workers’”⁴² in 1909, *The Amateur Photographer & Photographic News* asked major photographers to express their opinions about the future of pictorial photography in Great Britain. J. H. Anderson wrote “I am pessimistic about the future of pictorial photography... A levelling up has taken place, but, judging by the shows of the last two seasons, pictorial photography in France and America, as well as here, is not advancing. No better work has been produced in those countries than we saw five or six years ago.”⁴³ George Davison enumerated specific reasons for the malaise,

⁴¹ John Taylor “The Salon des Refusés” *History of Photography* Volume 8 No. 4 October-December 1984 p. 284.

⁴² “The Future of Pictorial Photography in Great Britain” *The Amateur Photographer & Photographic News* December 14, 1909, pp 574-576.

⁴³ J. H. Anderson “The Future of Pictorial Photography in Great Britain” *The Amateur Photographer & Photographic News* December 14 1909, pp. 574-75.

We have allowed personality to govern our judgments and distort our real preferences. And the natural result to be expected is an apotheosis of mediocrity; exhibitions made up of large numbers of fairly good photographs, commonplace work... What we need to do is to stimulate the man who puts his life and all his work into photography. It is of no use pretending that the casual workers, the dabblers, deserve the same recognition as the real experts, the workers who bring both ability and devotion year in year out to doing fine things.⁴⁴

There is little doubt that Davison is referring to the camera club hobbyists when he said casual workers and dabblers who were rapidly becoming the locus of a decadent pictorial photography, the same persons addressed by Dudley Johnston “there is too great a tendency to judge pictorial work according to crystallized formula.”⁴⁵ Agnes Warburg believed that photographers should be better educated regarding “painting - the art most nearly allied to his own” but their knowledge base was “scanty, and it stops short at the twentieth century, supremely oblivious of the modern school,”⁴⁶ summarizing the retrograde aesthetic beginning to dominate British photography. Another respondent was part of that retrograde movement “The subordination of the picture to abstract line and mass is artificial “ and “Nature is the thing to study and follow; we must not be misled by mannerisms and decorative treatments that pose as art.”⁴⁷ It seems clear that progressive and inventive photography was already receding into oblivion by 1909 in Britain.

There certainly was no ‘triumph of modernism’ in Britain. The 1910 Grafton Gallery exhibition of ‘Manet and the Post-Impressionists’ was widely greeted by derision from much of the established art community. After nearly 40 years of Impressionist exhibitions in Europe, and long after the 8th and final Impressionist Exhibition of 1886, it

⁴⁴ George Davison “The Future of Pictorial Photography in Great Britain” *The Amateur Photographer & Photographic News* December 14 1909, p. 574.

⁴⁵ J. Dudley Johnston “The Future of Pictorial Photography in Great Britain” *The Amateur Photographer & Photographic News* December 14 1909, p. 575.

⁴⁶ Agnes B. Warburg “The Future of Pictorial Photography in Great Britain” *The Amateur Photographer & Photographic News* December 14 1909, p. 575.

⁴⁷ W. R. Bland “The Future of Pictorial Photography in Great Britain” *The Amateur Photographer & Photographic News* December 14 1909, p. 575.

would be tempting to consider that the issue was resolved but the ghost of the John Ruskin - James Whistler libel suit of 1878 hung over British art and to a great extent, what occurred instead was a re-entrenchment of traditional aesthetic values rather than an adoption of the new. When considering British Impressionism, it should be remembered that two key figures, John Goffe Rand (who in 1841 invented the collapsible paint tube)⁴⁸ and J. M. Whistler, were Americans living abroad. The man who began the photographic revolution, P. H. Emerson, was also an American, as was the man who would try in 1916 to bring the British photographers into the modern fold, Alvin Langdon Coburn. Perhaps the British were lacking the requisite revolutionary zeal in art.

Coburn's American landscapes hung in four exhibits in London, Goupil Gallery (1913), the RPS (1914),⁴⁹ at one man show at Hampshire House (1916) and at the Camera Club (1917). Resident critic for the *Amateur Photographer*, Anthony Guest, reviewed the latter three and found him distinctively un-British. "It follows that she [Nature] must determine the character of British art, which, whether in painting or photography, *must*⁵⁰ be deeply concerned with her subtleties of light and atmosphere. These are matters with which American boldness and invention, however enlivening their example, have nothing to do."⁵¹ Perhaps irritated that Coburn did not follow his heed, in 1916 Guest describes him as a 'wild revolutionary person' for his soft focus photographs of California and Arizona. The Camera Club exhibit encompassed both Coburn's

⁴⁸ Robert Katz and Celestine Dars *The Impressionist* (Leicester: Abbeydale Press, 2002) p. 29. Renoir was quoted as saying "Without paints in tubes there would have been no Cézanne, no Monet, no Sisley or Pissarro, nothing of what the journalists were later to call Impressionism."

⁴⁹ Coburn was a member of the hanging committee as well and devised an 'American Section' showing images by Clarence White and eight of his students; he did the same again in the 1915 annual show. See Kathleen A. Erwin *Pictorialism into Modernism*, p. 146.

⁵⁰ Emphasis mine

⁵¹ Anthony Guest "Exhibition of the Royal Photographic Society" *Photo-Era* Vol. XXXIII, No. 5, November 1914, p. 221, reprinted from an undated issue of *The Amateur Photographer*.

‘vortograph’ photographs as well as a number of his paintings. Guest’s response to that show was that “Mr. Coburn’s inventive genius, however, is little influenced by criticism. He pursues his own path, and now it has led him to the wild region towards which those who have watched his advance might have guessed that he was tending.”⁵² Modern British author John Taylor summarizes the results “the monumental efforts of Coburn to establish in England another view of nature, and even to break with nature altogether for a while in order to assess the future of pictorial photography... met with virtually no response from the British.”⁵³

Figure 7.2: Alvin Langdon Coburn *Clouds in the Grand Canyon* 1911, gum over platinum, 12.5 x 16 inch enlargement from a 3¼ x 4¼ negative made with a reflex camera. Perhaps critic Anthony Guest was taken unaware that ‘sublime’ could have orders of magnitude (Karl Steinorth ed. *Coburn photographs 1900-1924* Zurich Edition Stemmler p. 86). Newhall showed a companion image, *The Great Temple, Grand Canyon* in his final exhibition, “Proto-Modern Photography.’ This image is a superb example of the effectiveness of an image on the soft-sharp cusp.

J. Dudley Johnston, in his ‘presidential address’ to the Royal Photographic Society praised Coburn, not Stieglitz, not Steichen, not Emerson or Davison, as having

⁵² Anthony Guest “A. L. Coburn’s Vortographs” *Photo-Era* Vol. XXXVIII No. 5 May 1917 p. 227.

⁵³ Taylor, 1978, p. 21.

made the greatest contribution to the artistic side of photography of all its practitioners that have hitherto arisen. He gave us an outlook and cleared our vision. From his example we learnt to see the essentials of beauty in simple and commonplace things, to realize especially the beauties of light, and the result was to place our pictorial items on a sounder basis than we could have reached by following the elaborations of the schools that preceded him.⁵⁴ Since that time the development of pictorialism has lain rather in experiments to find improved methods and processes than in any new outlook.⁵⁵

As a result of the events of 1908, British “pictorialism remained more or less where it had been around 1908, except that it lost the benefit of lively international debate and began to feed off itself.”⁵⁶ Much as in the United States, “stripped of its radicalism, and without a critical debate to sustain it, the final refuge of Pictorialism was the amateur camera clubs. It has flourished there ever since.”⁵⁷ The motive for camera club image makers was and remains to gain recognition and salon acceptances rather than personal expression underlain by aesthetic philosophy. They will completely change their imagery based on previous year’s winners and articles in *The Amateur Photographer*, blowing like aesthetic weeds in the winds of judges’ choices.

World War I

World War I had little effect on photography in California and not a major effect on the East Coast of the United States, in part because America had entered the war so late. Nearly all the rest of the world, however, suffered significant material shortages in

⁵⁴ Emphasis mine.

⁵⁵ J. Dudley Johnston “The Presidential Address” *The Photographic Journal* December 1923 p. 569.

⁵⁶ John Taylor “The Salon des Refusés” *History of Photography* Volume 8 No. 4 October-December 1984 p. 284.

⁵⁷ Ray McKenzie “Introduction: Pictorialism and its Malcontents” *Photography 1900* p. 16.

the form of film, paper and chemicals which were diverted to national security groups. Lens production went entirely to war effort; lens appeals by the respective governments robbed both amateurs and patriotic professionals of their equipment. The German based AGFA company was the world's source for many photographic chemicals, especially developers, and with the outbreak of war, Allied countries were cut off from a number of essential photographic supplies, including high quality optical glass; what supplies were in inventory were directed toward military applications.

British photography was severely impacted; "It is quite impossible to keep the war out of photographic notes these days. There is no phase of life all over the country that is not profoundly modified or in some way altered by the world contest."⁵⁸ There were stringent regulations regarding where a camera could be taken and what could be photographed, for instance, "the latest rule is that no camera may be kept within two miles of the coast" which not only prohibits photography but the mere possession of a camera."⁵⁹ "Speaking of permits, Mr. A. L. Coburn seems to be a traveling depository of them. He is now staying at the coast in Wales, and has made it his business to get every sort of permission for an alien to photograph that it is possible to obtain"⁶⁰ indicating that the act of photography must have required a permit, at least under some circumstances. Camera clubs were the social centers of British photography and their meetings and operations were nearly totally disrupted, The London Camera Club "studio had become deserted in the evenings, for with its arc-light and its big windows it would soon have caused a police raid now that our lighting-orders are so strict."⁶¹ The LCC "owing to war

⁵⁸ Will and Carine Cadby "London Letter" *Photo-Era*, Volume XXXVII, No. 1, June 1916 p. 49.

⁵⁹ Will and Carine Cadby June 1916 p. 49.

⁶⁰ Will and Carine Cadby "London Letter" *Photo-Era*, Volume XXXIX No. 4, October 1917, p. 216.

⁶¹ Will and Carine Cadby "London Letter" *Photo-Era*, Volume XXXVII, No. 6, December 1916, p.301.

conditions, decided that a mounted photograph would look very well on an exhibition wall without any frame but a glass cover,”⁶² a practice that would soon become almost universal at salons and exhibitions. The war and the resulting censorship disrupted the postal services and the international shipment of photographs for exhibitions and salon competitions,⁶³ bringing them essentially to a halt until the restrictions (Defense-of-the Realm Act) were lifted in August, 1919 (the Cadbys noted that they could not even receive issues of *Photo-Era* due to censorship).⁶⁴

Photographic magazines underwent massive changes due to war induced problems. Print shops often lost their skilled press operators to the draft with young, inexperienced boys taking their place on the shop floor, resulting in lower quality reproductions. Paper quality was reduced (limiting reproduction quality achievable) and the amount available was irregular and to some extent controlled by rationing. Photographic topics that had been perfectly acceptable subjects before the war might now risk revealing strategic information to the enemy and everything was subject to censure. It is probably safe to assume that the number of submissions to magazines plummeted as so many men were now soldiers away from home and darkroom.

Both in the United States and Britain, the war effort was hampered by the lack of camera lenses. The “government will soon have ready for service thousands of observation airplanes, and we confront the fact that the camera lenses needed for these airplanes cannot be bought in the usual way of business. They are not in the markets. We are unable at present even to manufacture the special kind of optical glass indispensable

⁶² Dr. J. L. Hankey and J. Dudley Johnston *Alexander Keighley, A Memorial* (London: Pictorial Group of the Royal Photographic Society, 1947) p. 16.

⁶³ Will and Carine Cadby “London Letter” *Photo-Era*, Volume XLII, No. 2, February 1919, p. 109.

⁶⁴ Will and Carine Cadby “London Letter” *Photo-Era*, Volume Vol. XLIII, No. 3, September 1919, p. 165.

to the making of lenses required for this work. This glass cannot be bought in America today”⁶⁵ because the world’s supply had been manufactured in Jena, Germany. As a result, “Every photographer who possesses an anastigmat of the sort described must realize that it is his privilege and patriotic duty to offer it to the government without delay.” In Britain the army commandeered essentially *any* anastigmat longer than eight inch focal length,⁶⁶ crippling large format photographers, many of whom would not be able to replace their lenses for years to come. Pinkham & Smith noted that 100% of their production went to the war and it was not until 1920 that “we are now able to meet the demands and to anticipate the needs of our customers, who shared the sacrifice. Many changes in production, material and design have required considerable time before it was possible to announce our preparedness to resume.”⁶⁷ There is no evidence on either side of the Atlantic that soft focus lenses were ever requisitioned from the public, thereby sparing pictorial photographers their coveted lenses.

Except for lifting the restrictions on taking photographs, little changed in terms of product availability when the war ended. The German photo-industry, supplier to the world, was in ruins, there were no new cameras or lenses or photographic chemicals unless they originated in the United States; the American industry, undamaged by the war, nonetheless required many months to re-tool and train new employees in skills that had previously been learned over the years in the apprentice system. The depressing results were summed up by the Cadbys, “With Peace has not come Plenty. Everything is

⁶⁵ Photographic Division, Signal Corps, U. S. Army “The Eyes of the Army” *The Photo-Miniature* 1917 p. 414.

⁶⁶ “Photographic Lenses Commandeered” *Photo-Era* Vol. XXXVIII, No. 3, March 1917 p. 154, citing an article in the *BJP* January 1917.

⁶⁷ ‘Foreword’ *Pinkham & Smith Soft-Focus Lenses* sales brochure (Boston: Pinkham & Smith, 1920) unpaginated.

scarce from a cabbage to a camera, and we are all longing for a good harvest, especially of cameras.”⁶⁸ In the U.S., there was a steep new tax of ten percent on cameras and five percent on film and plates to pay for the war.⁶⁹ The economy was in a shambles in Britain and Europe causing severe economic tightening on the part of most individuals. Frederick Evans, who had retired from his book business, “was compelled to part with very many of the things I have enjoyed for so long” and auctioned many of his dearest possessions, including his prize book collection, in 1919.⁷⁰ Dudley Johnston considered that a full recovery required a full decade⁷¹ and by then the Great Depression was about to strike.

Britain and Europe lost nearly an entire generation of men. Rampant inflation on the Continent, especially in the former Axis countries, made the purchase of foreign goods very expensive and of course, money was difficult to obtain in the first place. The Germans no longer participated significantly in foreign exhibitions⁷² and “the times are not yet ripe for a highly artistic development. For this, better economic conditions would be necessary, not only at home, but elsewhere.”⁷³

There is a prevalent theory among modern historians that the twentieth century truly begins with the Treaty of Versailles in 1919.⁷⁴ A new philosophy was upon the western world, especially Europe and with it many vestiges of the old were swept away and replaced by the new modernism, pictorialism amongst them. Pictorialism had originated as a “reaction to machines, mass-production, and any aspect of modernization

⁶⁸ Will and Carine Cadby “London Letter” *Photo-Era*, Volume XLIII, No. 3, September 1919, p. 165.

⁶⁹ “With the Trade” *Photo-Era* Volume XLII No. 4 April 1919 p. 220.

⁷⁰ Hammond 1992, p. 105.

⁷¹ Johnston 1929, p. 832.

⁷² Johnston 1929, p. 832.

⁷³ Kühn 1936, p. 3.

⁷⁴ For example, Ann Hagedorn *Savage Peace; Hope and Fear in America, 1919* (2007).

that was seen to be cheapening life;”⁷⁵ modernism praised the machine and the assembly line product: they were diametric extremes. For Britain and Europe, World War I and its consequences were the main cause for the demise of Pictorialism, recalling that especially in Germany, France and Italy there were never many pictorialists even before the War. Only in the United States did Pictorialism survive the War in good health.

In America the impact of the War was psychological more than physical and this was amply demonstrated by Alfred Stieglitz’s behavior. Nominally neutral, he harbored pro-German sentiments throughout the war years, separating permanently with Steichen, his last luminary from the Photo-Secession, over the issue, and perhaps with Karl Struss as well, who was a soldier and pro-American but severely abused by the Army as a possible traitor. Stieglitz’s characteristic intractable nature drove away the few remaining photographers from his fold.

Whereas the more experienced pictorial photographers often believed that the standards of work slipped progressively after World War I, this may not have been applicable in California. John Paul Edwards, who had been active since 1911 or earlier, evaluated the Eighth Pittsburgh Salon (1921) as “the general average of excellence is higher even if there are fewer outstanding peaks of pictorial greatness.”⁷⁶ Speaking of a California salon two years later, Edwards wrote

A large percentage of the pictures shown in the exhibitions of ten years ago would fail to pass a well-constituted jury today. There is a better print-making, greater consideration of tonal values, more discrimination in the use of soft-focus lenses and greater originality in the choice of subject-matter. There are three workers

⁷⁵ Terence R. Pitts “Paul Lewis Anderson: A Life in Photography” *The Archive* (Tucson, Center for Creative Photography) No. 18 May 1983 p. 13.

⁷⁶ John Paul Edwards “The Eighth Pittsburgh Salon” *Photo-Era*, Vol. XLVI, No. 5, May, 1921 p. 221.

who are sending prints to salons today where there was one ten years ago. This is significant.⁷⁷

It would be enlightening to understand whether he intended this as a generalization to all salons or if this opinion applied only to the California salons. This runs so counter to the modern view of this period that if it was a less astute and competent observer, a historian might be tempted to discount it. In reviewing another 1923 California salon, soft focus lens designer Karl Struss (who by then had relocated from New York to Los Angeles) considered soft focus to be *over-used*, “for the general impression seems to be that anything that looks blurry must, *per se*, be a work of art.”⁷⁸ The implication of these two observers was that the standard of Pictorialism was still rising, as was the use of soft focus lenses, and the latter seems confirmed nation-wide by Tennant, “More than 50 per cent of the work seen at to-day's photographic exhibitions is of the 'soft-focus' sort. Similarly, in professional portraiture everywhere, the hard and sharply cut definition of a few years ago has largely disappeared.”⁷⁹ Clarence White also believed “The soft focus lens seems more popular than ever and it apparently has come to stay”⁸⁰ in 1921. The utilization of soft focus lenses was in ascension in the early 1920s, beyond a doubt. Alfred Stieglitz’s rejection of Pictorialism had done nothing to halt the momentum he labored to develop.

PLATINUM SCARCITY

⁷⁷ John Paul Edwards “The San Francisco-Oakland Salon” *Photo-Era*, Vol. LI, No. 6, December 1923 p. 306.

⁷⁸ Karl Struss “The International Los Angeles Salon” *Photo-Era* Vol. L No. 4, April 1923 p. 189.

⁷⁹ Tennant December, 1921, pp. 149-150.

⁸⁰ Clarence White and Henry Hoyt Moore “The Year’s Progress” *Pictorial Photography in America 1921* (New York: Pictorial Photographers of America, 1921) p. 7.

World War I caused the price of platinum to soar and by 1916 “the price of platinum had gone up to \$130 an ounce with none to be had.”⁸¹ A few months later, Kodak ceased manufacture of platinum-based papers.⁸² Platinotype papers did disappear from the marketplace, although not immediately as Jussim⁸³ states, but two decades later when the Platinotype Company ceased operation in 1937.⁸⁴ The price of the available papers did soar, however, pricing many amateur photographers out of the market, such as Frederick Evans. To those of inherited wealth such as Emerson, Day and Demachy, it should have made little impact in their darkroom practices immediately after the War although all three claimed an impact; However, some economically challenged photographers like Edward Weston nonetheless used it well into the 1920s; Stieglitz, who perpetually complained of his pecuniary condition continued use of Palladiotype into the 1920s also.⁸⁵ The removal of platinum paper from the market was an “incalculable loss to pictorial photographers, since it must be conceded that no printing medium thus far introduced can approach platinum paper in pictorial possibilities.”⁸⁶

The cost of platinum sent photographers searching for alternatives such as carbon, gum and oil/bromoil.⁸⁷ There was an available analog to platinum, palladium, which produced a print very similar to platinum at a greatly reduced price. It was considered by

⁸¹ Editor? *Photo-Era* April 1916, XXXVI, No. 4, p. 203.

⁸² Luis Nadeau *History and Practice of Platinum Printing* (New Brunswick: Atelier Luis Nadeau, 1984) p. 21.

⁸³ Jussim 1981, p. 197.

⁸⁴ Mike Ware “The Eighth Metal: The Rise of the Platinotype Process” in *Photography 1900*, Julie Lawson, Ray McKenzie and A. D. Morrison-Low eds. p. 108.

⁸⁵ Sue Davison Lowe *Stieglitz, a Memoir/Biography* (New York: Farrar Straus Giroux, 1983) p. 443.

⁸⁶ John Tennant “Notes and Comments” *The Photo-Miniature*, Vol. XIII, No. 149, May, 1916, pp 229-230.

⁸⁷ Paul L. Anderson “Oil and Bromoil for Portraiture” *The American Annual of Photography, 1917* (New York: The American Photographic Publishing Company, 1916) p. 244.

Paul Anderson to be “equally desirable”⁸⁸ and was used by Edward Weston until 1924. In addition, it had always been possible to hand coat paper in the photographer’s own darkroom and despite the cost of the platinum or palladium, it was economical to use since “the cost of the developer is practically nil, the cost of the clearing baths very slight, and there is no reason whatsoever for failures.”⁸⁹ Using the expense of platinum metal as a reason for the decline of Pictorialism was more an excuse than a viable explanation.

Platinum and other non-silver processes were already in decline before the War. A letter from ‘Photographic Dealers’ attributes the decrease to the “greater simplicity of the newer processes, as is generally stated; but we think that the real explanation lies in the fact that they were not in the hands of some of the younger firms of the type we have mentioned.”⁹⁰ The retailers blamed poor marketing by the manufacturers although they may not have considered that the manufacturer made more profit on the sale of gas light papers. Paul Anderson ascribed it to an “increased speed of production, with a corresponding decline in quality;”⁹¹ newer photographers were more bent on entering numerous salons and camera club competitions to garner points and ribbons, which required numerous prints in circulation, than in creating a marvelous unique and precious art object as their predecessors had done. With the gas light papers, they could print after work every night rather than waiting for Sunday to make sun prints in platinum, palladium, kallitype, cyanotype, oil, etc. The emergence of these new motives for the existence of an amateur’s prints, rather than concentrating on personal expression, may

⁸⁸ Anderson 1920, p. 65.

⁸⁹ Paul L. Anderson “Special Printing Processes” Keith Henney and Beverly Dudley eds. *Handbook of Photography* (New York: Whittlesey House, 1939) p. 479. The author is indebted to Prof. Larry Schaaf for having recommended this book many years ago.

⁹⁰ “Letters” *Photo-Era* Vol. XLIII No. 1, January 1919 pp.49-50.

⁹¹ Anderson April, 1935 p.208.

have been the most important cause of the decline of the process which had been for over two decades the darling of Pictorialism.

California

California and the Far West were (and remain) exceptions to nearly any generalization regarding the United States. Rather than being one state in the (then) 48 states, it is more accurate to conceive of it as a country with its own customs and culture; within that country, there is a further subdivision between northern and southern California which have little in common. The shortages, rationing, fear of invasion and saboteurs that racked the entire eastern coast of the country during World War I were unknown in the West. It was in many ways an authentic Garden of Eden with abundance of local foods, clean air, temperate climate, beautiful vistas⁹² and free-thinking. San Francisco and Los Angeles also contained the majority of the Japanese population in the country, and this ethnic minority made disproportionate contributions to the pictorialist aesthetic in the form of the 'Japanese American Pictorialists of California' club and the "Japanese Pictorial Photographers of Southern California.'. Paul Anderson characterized the difference between the East Coast establishment and the West thusly "It is, however, unquestionably the case that the modern tendency in art is toward estheticism and away from imaginative work, a distinction which is emphasized by the difference in approach found on the two coasts of this country. In the highly sophisticated East the attitude is largely favorable to pure estheticism, whereas in the freer, less conventional West pictorial effect is more aimed at, though there are, of course, notable exceptions in both

⁹² Had Ansel Adams been born in Cleveland, Ohio, instead of San Francisco, California, would he have become a famous landscape photographer or even a photographer? Not likely.

areas, the rule being by no means invariable.”⁹³ Some of the photographic annuals contained separate assessments of the west coast, a contemporary acknowledgement of the differences brought about by geography.⁹⁴ One well informed British writer considered that “The finest use of the nude is to be found in the work of the Americans, especially those living in California where the conditions are exceptionally favourable.”⁹⁵

Primary California pictorialists would include Ansel Adams, Fred Archer, Anne Brigman, Francis Bruguiere, Will Connell, Imogen Cunningham, William Dasonville, John Paul Edwards, Louis Fleckenstein, Arnold Genthe, Johan Hagemeyer, Alma Levenson, Arthur Kales, Margrethe Mather, William Mortensen, Karl Struss, Edward Weston.⁹⁶

⁹³ Anderson 1920, pp. 65-66.

⁹⁴ Arthur Kales wrote a summary of ‘Western America’ photography for *Photograms of the Year* from 1922 through 1936, the year of his death.

⁹⁵ Johnston 1929, p. 830.

⁹⁶ For detailed assessments of California pictorialism the reader should consult Sichel and McCarroll, *California Dreamin’, Camera Clubs and the Pictorial Photography Tradition* (2004), Wilson and Reed, *Pictorialism in California, photographs 1900-1940* (1994) and Mann, *California Pictorialism* (1977).

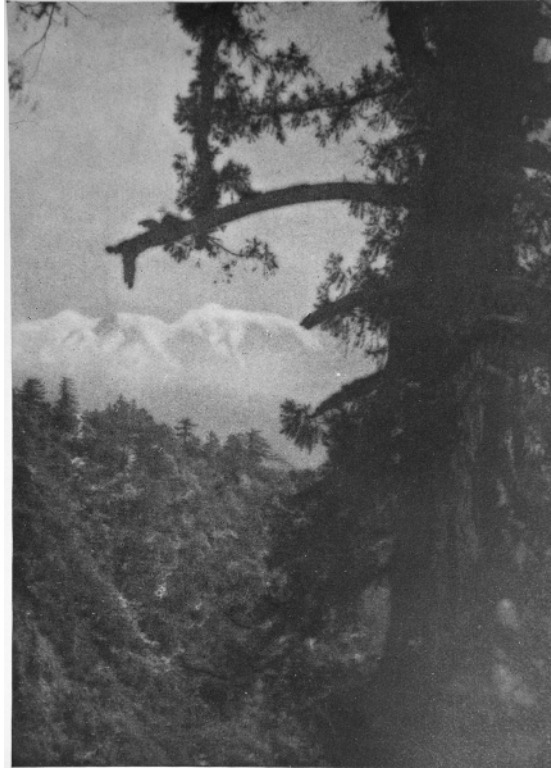

Figure 7.3: E. H. Weston *View from Mt. Wilson* made with a *Rapid Rectilinear* eight inch lens stopped to $f/256$ ($f/64$ in the modern system) for 15 seconds, enlarged with a *Verito* lens. Weston was awarded an honorable mention in the monthly competition (subject - tree studies) of *Photo-Era*. Typical of California landscape, it must have surely awed eastern readers. This may be the earliest documented image he made using a *Verito*, although as an enlarging lens rather than on the camera. The tell-tale bleed from the dark branch above center into the neutral gray sky is a certain sign of using soft focus in the darkroom. He is regularly mentioned in these monthly competitions-by-mail and must have avidly pursued these awards (*Photo-Era* Volume XXIX, No.5, Nov. 1912). When Weston bought his *Rapid Rectilinear* while in Mexico, June 24, 1924, he may have deliberately chosen that precise model because of his earlier familiarity with its operation. This image is reminiscent of Hokusai's woodblocks of Mt. Fuji; Weston had previously recommended reading Arthur Wesley Dow's *Composition*, indicating that he may have had some familiarity with Japanese art (*Photo-Era* Volume XXVII, No. 6, December 1911, pp. 298-300).



Figure 7.4: J. P. Edwards *Portrait of an Artist* made with a seven inch *Verito*, F/5.6, 3X filter, 1/30 second. The filter was probably a medium yellow. For this photograph, Edwards received ‘honorable mention - outdoor portraits’ from the editor of *Photo-Era* (Volume XXXIII, No. 5, Nov. 1914, p. 258). Made in dull light, this image does not exploit the best characteristics of a soft focus lens, the sense of shimmering sunlight.

California had a long engagement with photography and was either not far behind the East Coast in following trends or was the trend-setter itself. *Camera Craft*, the journal of the California Camera Club, printed its first issue in 1900 and was issued monthly until its final issue in 1942. Most American camera magazines of the Pictorialist period were firmly in either the ‘purist’ camp or the Pictorialist camp and *Camera Craft* was, for its entire life, pro-Pictorialist, while still presenting a balanced picture of Californian photography. Ansel Adams, John Paul Edwards, Roi Partridge and other ‘purist’ photographers were featured in its pages.

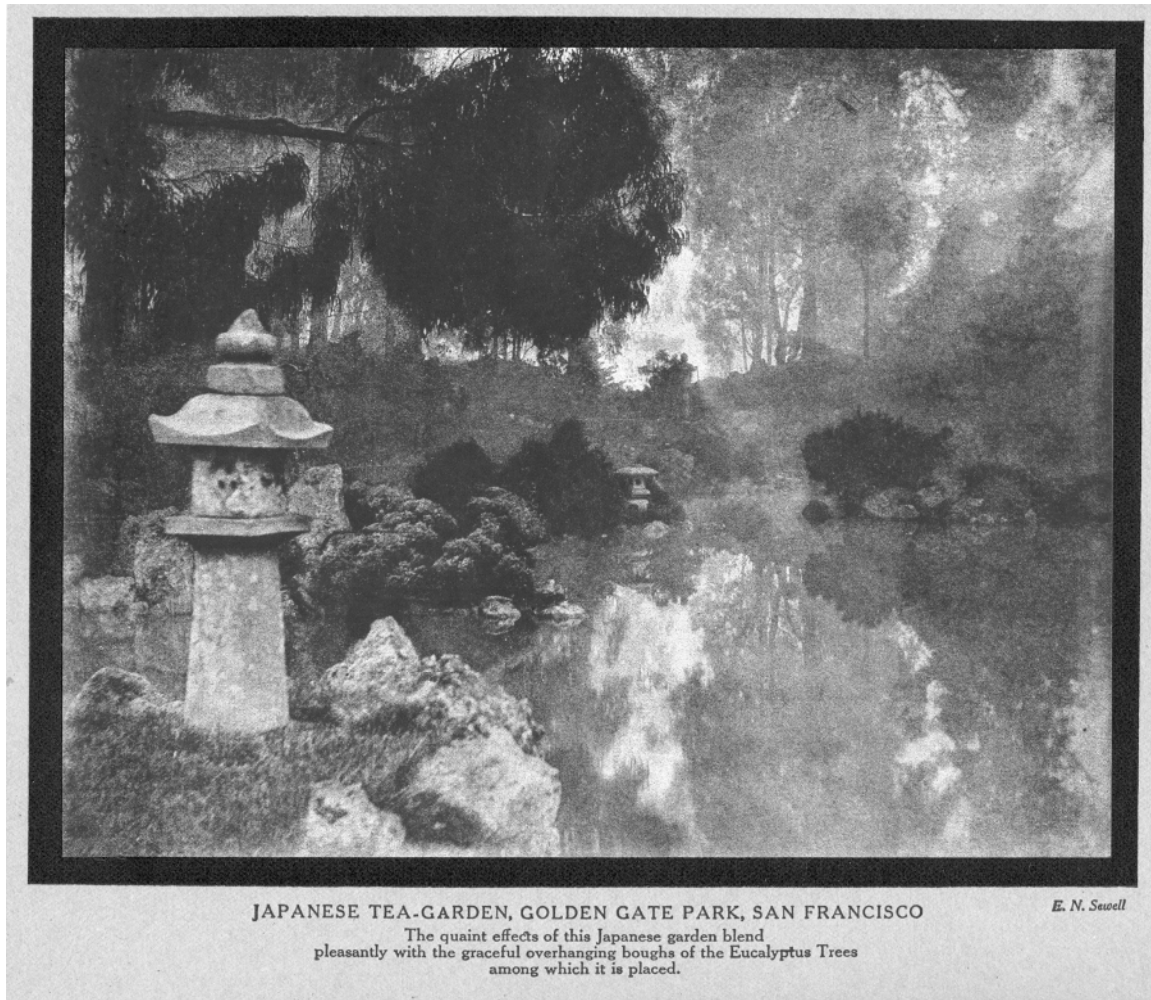

Figure 7.5: Illustration from *California the Beautiful* “by Western Artists and Authors” published in San Francisco, 1911, and is completely illustrated by tipped-in photogravures (Paul Elder & Company). The aesthetic of this book mirrors the Pictorialist aesthetic and virtually all photographs are strongly in the Pictorialist mode, even when not soft focus. Half-bound with burlap, this book shows Paul Elder and Company to be the West Coast equivalent of fine art publishers Copeland & Day on the East Coast (collection of the author).

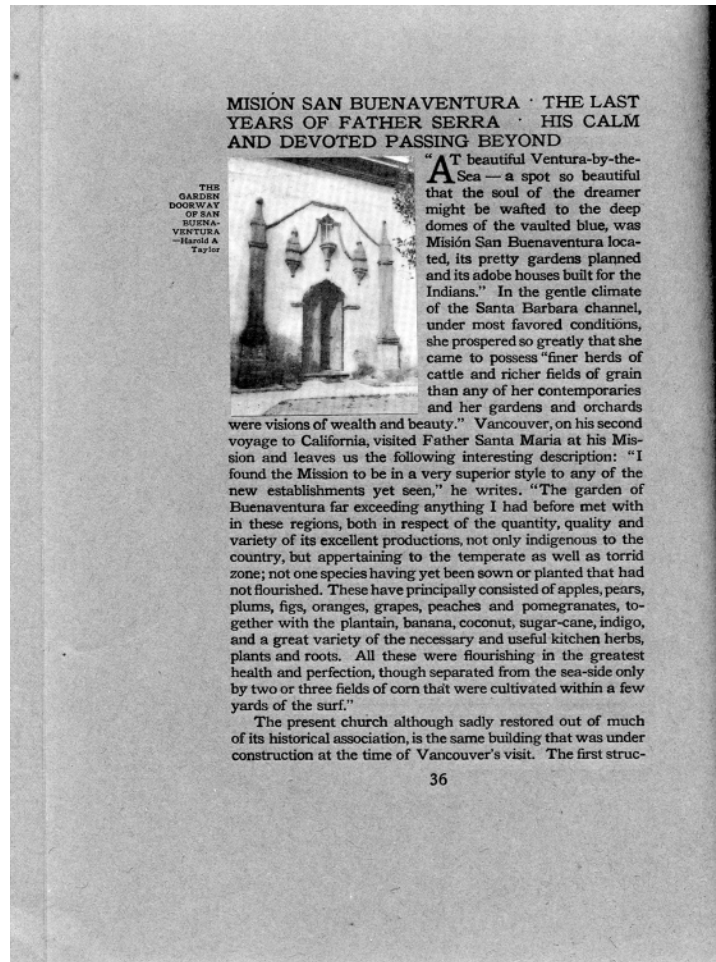

Figure 7.6: A page from *The Old Spanish Missions of California* fully illustrated by California photographers. Unlike *California the Beautiful* these are half-tone reproduction but are nonetheless tipped-in for a beautiful effect and all photographs reflect the rules of Pictorialism. The text is entirely letter press on a heavy weight (80 pound or greater) textured gray paper (Paul Elder and Company, San Francisco, 1913). The Arts & Crafts movement took deep root in California and was particularly manifested in the development of a regional vernacular style which came to be known as ‘Mission Style’ which remains popular in the twenty-first century (collection of the author).

In 1914 the ‘Camera Pictorialists of Los Angeles’ was formed by a “multitudinous small nuclei of pictorialists that would otherwise have been stifled by the bulk of bromidic conservatism inherent in their parent camera clubs,”⁹⁷ specifically

⁹⁷ “The Camera Pictorialists of Los Angeles” *The Pictorialist 1931* (Los Angeles: Camera Pictorialists of Los Angeles, 1931) p. 5.

eleven charter members including Fred Archer, Margrethe Mather, Louis Fleckenstein and budding pictorialist Edward Henry Weston⁹⁸. An active group, they sponsored their first international salon in January, 1918 (a further proof of the distance between California and The War) and sporadically published annuals through 1932 with the results of those salons. The 1931 edition reproduced images by such well known pictorialists as D. J. Ruzicka (New York), Laura Gilpin (Colorado), Floyd McKissack (Glasgow), Harold Symes (England), Leonard Misonne (Belgium), Imogen Cunningham (California), Will Connell (California), Edward Weston (California), Brett Weston (California), Fred Archer (California), Fred Peel (Pennsylvania), Fred Judge (England), Karl Struss (California),⁹⁹ Harry Shigeta (Chicago) and Franklin Jordan (Mass.), all recognizable to any well informed pictorialist of the time, and numerous international entries with Vienna especially well represented. The reproductions are large (the pages are 9x12 inches), well printed and include the process; only one is made from platinum or palladium, one gum, one carbonyl, two Fresson, 12 bromoil or oil, but the vast majority of prints, 84, are plain bromide or chloride prints. Many are diffused, many are very sharp, and it is clear that this year was on the cusp of modernism for California. The European selections are generally more pictorial than the American images and are more likely to be oil or bromoil prints than American images. The 'machine age' is the subject for a large percentage of photographers, both pictorial and purist. The old pictorialism is most certainly on the wane by 1931, even in California. The next year would see the radical

⁹⁸ Margery Mann *California Pictorialism* (San Francisco: San Francisco Museum of Modern Art, 1977) p. 26.

⁹⁹ Struss had moved to California in 1919 and immediately involved himself in the club. Another of the Photo-Secessionists, critic Sadakichi Hartmann, moved to Los Angeles in 1922.

‘Group f/64’ exhibition at the DeYoung Memorial Museum in San Francisco and with it, rhetoric denouncing Pictorialism in the strongest terms.

Mann wrote in *California Pictorialism* about the California Salons, “The first one, in 1918, was full of prints that were soft-focus and romantic, but by 1923, a number of writers were pointing out that the day of the soft-focus, fuzzy print seemed to be over, and that many of the new images on the West Coast were sharp and straightforward.” This does not seem congruent with other sources including the much later 1931 Salon cited above. Karl Struss thought soft focus was over-used in 1923¹⁰⁰ and John Tennant observed in 1921 that over half of the images in salons were soft focus.¹⁰¹ Perhaps the photographers were not reading the writers’ essays.

The utilization of soft focus lenses is in ascension in the early 1920s, beyond a doubt. Recall, too, that at this time in California, Edward Weston was working with his Wollensak *Verito* and Graf *Variable*, Johan Hagemeyer was active as a pictorialist and a writer defending Pictorialism,¹⁰² William Dasonville was manufacturing arguably the finest enlarging papers ever made, Arthur Kales was at the height of his career,¹⁰³ John Paul Edwards was shooting with his *Verito* and Ansel Adams was mastering his Spencer *Portland* at this time. For California, the early 1920s were probably the climax of Pictorialism in terms of activity and quality.

¹⁰⁰ Karl Struss “The International Los Angeles Salon” *Photo-Era* Vol. L No. 4, April 1923 p. 189.

¹⁰¹ Tennant December, 1921, pp. 149-150

¹⁰² Johan Hagemeyer “Pictorial Interpretation” *Camera Craft* Vol. 29 No. 8 August 1922 pp. 361-365.

¹⁰³ Kim Sichel and Stacey McCarroll *California Dreamin’* (Boston: Boston University Art Gallery, 2004) 104.

Figure 7.7: Imogen Cunningham *Margrethe Mather and Edward Weston* 1922 platinum/palladium print. Perhaps one of the finest portraits of a couple in American photography, this incomparably composed and lit soft focus image exemplifies the delicacy with which soft focus lenses could be applied by an experienced photographer (Beth Gates Warren *Margrethe Mather & Edward Weston, A Passionate Collaboration* plate 62).

Figure 7.8: William E. Dasonville *Boat Rail and Reflections* ca. 1925, printed on Dasonville's 'Charcoal Black' paper, taken from *Dasonville* (Nevada City, California: Carl Mautz Publishing, 1999), Plate 36. This image exemplifies the direction of much California pictorialism in the 1920s, which could be characterized as possessing traditional values of tonality and diffusion but with a new compositional sense utilizing non-traditional subjects, especially machinery and architecture. Platinum and palladium prints had been replaced by enlarging papers although in the case of Dasonville's product, the result was nearly equal with far less labor.

Figure 7.9: Ansel Adams *Eagle Dance, San Ildefonso Pueblo New Mexico* ca. 1928-29.. Almost certainly made with his *Spencer Portland* lens, this shows how Adams was applying the aesthetics of diffusion to ‘modern’ compositional styles near the end of his soft focus career. It is intriguing to note that when he adopted the f/64 methods, he turned away from modern composition and returned to traditional methods of filling space with the most traditional of all subjects, the landscape (John Szarkowski [Ansel Adams at 100](#) plate 8). This is congruent with his earlier statement of goals, “what I am trying to do in pictorial photography - suggestive and impressionistic you may call it – either - it is the representation of material things in the abstract or purely imaginative way.” (Letter to his father, June 8, 1920, in *Ansel Adams, Letters and Images* p. 7)



Figure 7.10: William Mortensen *Johan the Mad* in the 1934 revised and enlarged second edition of *Projection Control* p. 45, one of Mortensen's series on photography published by *Camera Craft* magazine, many of which went through three editions. They clearly form the model used by Ansel Adams for his 1948 series on photography (which was not completed until 1958). The lettering of the title within the image and great involvement of hand-work are reminiscent of the early Pictorialist photographs *before* soft focus lenses were widely available.

The critical debate over pictorialist or purist lingered in the camera magazines through the 1930s, the most famous example being the debate between William Mortensen (America 1897-1965) and Ansel Adams that was played out in issues of *Camera Craft* in 1934. John Paul Edwards's statement regarding the 1932 exhibition said the "Group f.64 is not militant. It has no controversy with the photographic pictorialist."¹⁰⁴ There is no reason to believe Edwards spoke for Adams on this issue for the latter attacked Mortensen "in what became one of the fiercest verbal battles in photographic history."¹⁰⁵ Adams' letter to Mortensen ended with "How soon photography achieves the position of a great social and aesthetic instrument of expression depends on how soon you and your co-workers of shallow vision negotiate oblivion."¹⁰⁶ Mortensen, for his part, wrote in the fifth and concluding article of the exchange with "such honest statements of personal doctrine and practice as Mr. Adams' recent articles in these pages are a step in the right direction."¹⁰⁷ Mortensen never sought to return Adams' vitriol. After that series of attacks from Adams, f/64 acolytes resumed the attacks against Mortensen in the person of Roi Partridge, the husband of f/64 member Imogen Cunningham, who rekindled the debate again in 1939-40 issues of *Camera Craft*. Ansel goes on the attack again in *The American Annual of Photography, 1944*¹⁰⁸ enthusiastically writing to Weston "My article, severely deprecating the Pictorial point of view and the Salon lads, etc. accepted by the *American Annual of Photography*!!

¹⁰⁴ John Paul Edwards "Group f.64" *Camera Craft* March 1935 reprinted in Beaumont Newhall ed. *Photography: Essays and Images* (New York: The Museum of Modern Art, 1980) p. 251.

¹⁰⁵ Ansel Adams *Ansel Adams, an autobiography* (Boston: Little, Brown and Company, 1985) p. 113.

¹⁰⁶ Adams 1985, p. 115.

¹⁰⁷ "Venus and Vulcan: An Essay on Creative Pictorialism, 5, A Manifesto and a Prophecy" *Camera Craft* Volume 41, No. 7, July 1934, quoted in Larry Lytle and Michael Dawson "William Mortensen: A Selected Chronological Bibliography" *William Mortensen, a Revival* (Tucson: Center for Creative Photography, 1998) p. 100.

¹⁰⁸ "Personal Credo" (Boston: American Photographic Publishing Company, 1943) pp. 7-16.

Whadayouknow!!”¹⁰⁹ Adams pursued Mortensen for the rest of his life, even after Mortensen was deceased, his “antipathy to Mortensen ran deep, with an extremely personal undercurrent. Briefly put, he wanted him dead, and said as much on several occasions.”¹¹⁰ Late in Adams’ life, his strategy turned from vehement written attacks to power plays in the museum and archive world. Coleman cites two embarrassing examples; first, Adams attempted to blackmail curator Therese Thau Heyman of the Oakland Museum (California), saying he would not have his photographs exhibited at the same time as Mortensen,¹¹¹ and secondly, Adams pressured James Enyeart, director of the Center for Creative Photography (Tucson, Arizona) to refuse the donation of the Mortensen archives.¹¹² Adams failed in both cases. If the Adams-Mortensen exchange in *Camera Craft* was “one of the fiercest verbal battles in photographic history,” then one of the greatest ironies of photographic history is that their archives now lay side by side for eternity.

When analyzing Californian Pictorialism, it *must* be kept in mind that this was beyond Alfred Stieglitz’s sphere of influence; it developed without his approval, control or leadership. Anne Brigman was nominally a member of the Photo-Secession and Johan Hagemeyer subscribed to *Camera Work* but this was only a weak link at best (Hagemeyer’s photographs do not show any particular influence from that publication, nor do Weston’s, who read Hagemeyer’s copy). Western pictorialism was proof that the movement could begin, develop and produce a mature, coherent style without any central

¹⁰⁹ Adams 1985, p. 7.

¹¹⁰ A. D. Coleman “Conspicuous by His Absence” *Depth of Field* (Albuquerque: University of New Mexico Press, 1998) p. 95.

¹¹¹ Coleman 1998, p. 95

¹¹² A. D. Coleman “Beyond Recall: in the William Mortensen Archive” *William Mortensen, a Revival* (Tucson: Center for Creative Photography, 1998) p. 95n28.

leadership. “The f/64 Group has been said to have brought an end to pictorialism in California, but it did not. Pictorialism has continued to flourish in the camera clubs, though certainly less imaginatively than it did fifty years ago,”¹¹³ or through the filter of Ansel Adams, “The ‘salonist’ continues the sham of the turn of the century.”¹¹⁴

Reproduction Quality (Syntax Violation)

The introduction of photogravure in the 1880s and the introduction of rotogravure in 1892 coincide well with the rise of amateur photography and camera clubs. Whereas photogravure is labor intensive and produces one print at a time, rotogravure can be used for huge print runs such as magazines and newspapers. Both are capable of imparting more ink to the paper than conventional half-tone methods, “the tonal scale of a gravure print can contain subtleties almost impossible to convey with a dot-half-tone image.”¹¹⁵ Luminaries such as Peter Henry Emerson, Craig Annan, Alvin Langdon Coburn, Paul Strand and Alfred Stieglitz considered a photogravure made directly from the original negative as an original piece of art.

The purpose of the new illustrated photographic journals was to disseminate local, regional and national information and they did so most effectively, taking the images and philosophies of the new movement across the United States, to every major city and unknown village. *The American Annual of Photography* “brought an elite international movement to Steichen, then a young lithographer's apprentice in Milwaukee, Wisconsin, and to future Photo-Secessionist Clarence H. White, a bookkeeper for a wholesale grocer

¹¹³ Mann 1977, p. 29.

¹¹⁴ Adams 1976, p. 13.

¹¹⁵ Crawford 1979, p. 248.

in still more provincial Newark, Ohio,”¹¹⁶ and a few years later, photographic magazines took the images of Steichen and White all over America and Europe. The influence of these magazines cannot be over-rated and as early as 1896 it was realized that “the amateur to-day is striving to make pictures, and not what may be termed pretty photographs, whose chief excellence was 'sharp definition' throughout the whole negative ...This change has been brought about, I believe I am warranted in saying, by the opportunities he has had in late years of seeing the work of distinguished photographers of Europe - men who have striven by work and work to elevate the artistic side of photography,” and what the author meant by ‘seeing’ was not the often unique print of that image but a reproduction in a monthly journal or annual year book, at that time, generally a fairly poor half-tone reproduction. These annuals, as well as special editions of art journals such as *The Studio* reviewed the international scene and reproduced images, often categorized by country or exhibition, that the reader would never be able to view ‘in the flesh.’ It might be considered that the chief reason Pictorialism became the first international photographic movement was the improvement in the printing technology which diffused the newest images throughout the Western world.

¹¹⁶ Peter Galassi *American Photography 1890-1965* (New York: Museum of Modern Art, 1995) p. 14.

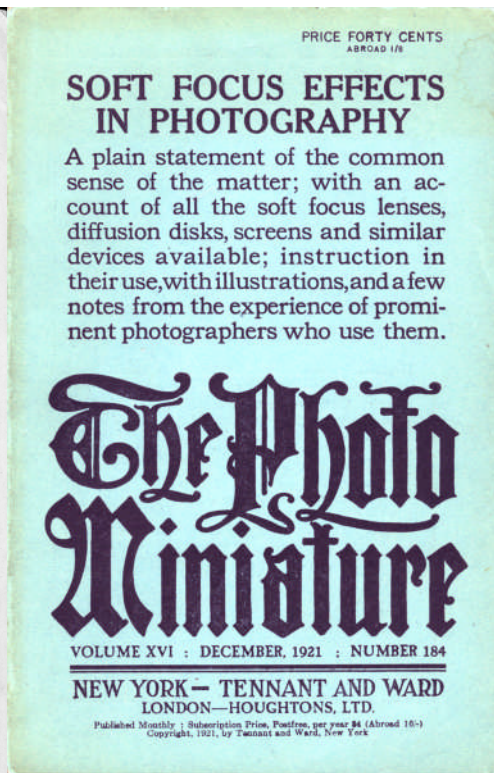
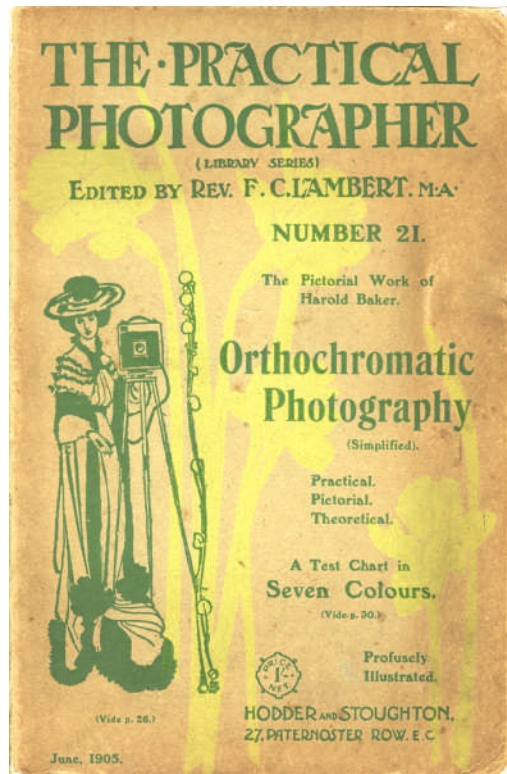
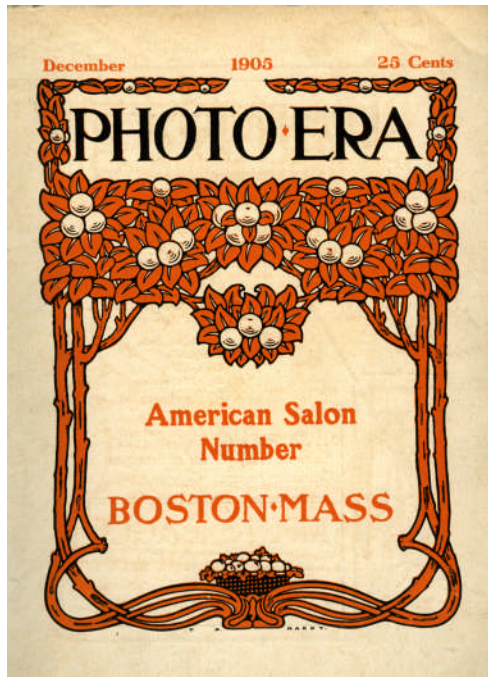

Figure 7.11: Four representatives of the numerous photographic magazines available to amateur photographers in the 1894-1925 period. There were also the assorted annual editions printed once a year with the 'new' work from around the world.

The crucial nature of syntax was recognized early in pictorialism even though there was not a single term applied to the concept. Misleading reproductions in the burgeoning camera magazines, published by camera clubs and independents, may have been the most important element in the demise of pictorialism and soft-focus. There are two categories of syntax failure involved, the first is technical the second is design. Technical failure addresses the inability to reproduce the image accurately whereas design failure physically misrepresents the image.

As early as 1893, Andrew Pringle, critic and photographer, recognized that “The hand-camera has given birth to a school of workers in small sizes, some of the productions being gems in their own way... but on an account of the minuteness of the detail, it is almost impossible to obtain suitable reproductions of the originals by any mechanical process such as required for illustrating a book or journal,”¹¹⁷ an example of technical failure where the printing process is unable to properly reproduce the original. *Camera Work* frequently failed in design syntax, “thus the huge, highly coloured gum bichromates of Theodor and Oskar Hofmeister and the tiny platinum prints by Stieglitz himself were reproduced at the same size, losing the scale and textures which made the originals so vastly different.”¹¹⁸

¹¹⁷ Andrew Pringle “The Naissance of Art in Photography” *The Studio* Vol. I, No. 3, June 1893, p. 95.

¹¹⁸ Roberts 1997, p. 15.

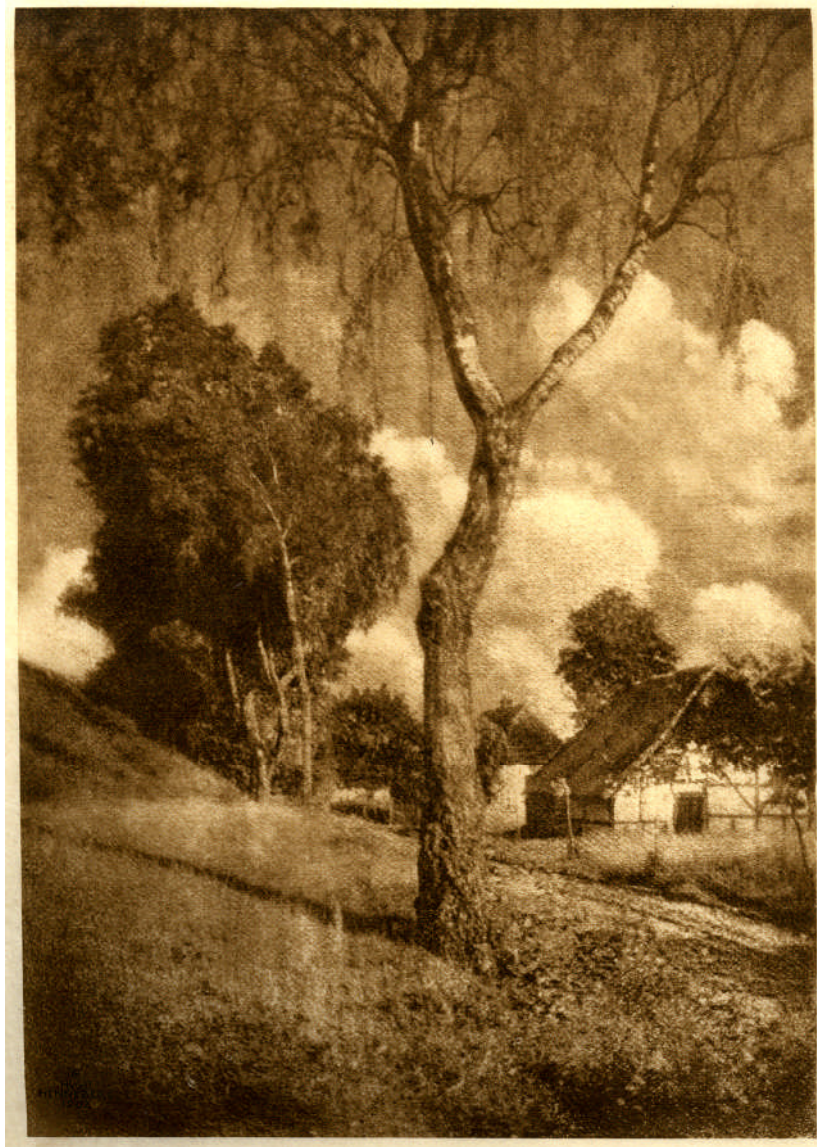

Figure 7.12: Hugo Henneberg *Pommeranian Motif* scanned directly from the *Camera Work* (January 1906) 6 $\frac{3}{4}$ x 9 $\frac{3}{4}$ inch photogravure. The original was a brown gum print 21 $\frac{7}{8}$ x 30 $\frac{5}{16}$ inches.¹¹⁹ The dramatic reduction in size robbed the original of its impact especially in an era when prints were rarely larger than 11 x 14 inches (collection of the author). In reviewing *The Solitary Horseman* by the Hoffmeister Brothers which was 27 x 38 $\frac{5}{8}$ inches, critic J. Nilson Laurik noted it “astonished everyone by its size.”¹²⁰ Until the adoption of wide-carriage ink jet printers, c.1998, prints of this size remained exceptional in the photographic world (collection of the author).

¹¹⁹ Weston J. Naef *The Collection of Alfred Stieglitz* (New York: The Viking Press, 1978) p. 371.

¹²⁰ J. Nilson Laurik “International Photography at the National Arts Club, N.Y.” *Camera Work* No. 26 April 1909 p. 41.

Figure 7.13: Hugo Henneberg *Row of Poplars* 1898 multiple color gum print, original size 12.6 x 17 inches. The lower image is identical except for loss of color, to impart a sense of the loss of information when a color print is reproduced in black and white. The gum print process was only six years old when this print was created and even well informed photographers would have been unaccustomed to anything other than monochrome prints, thus the vivid color and size, both lost in magazine reproduction of the time, would have been the defining visual syntax for the viewers (multiple authors *Impressionist Camera, Pictorial Photography in Europe, 1888-1918*, plate 151).

Camera Work was (and continues to be) lauded for the best quality of reproduction of any photographic tome until quad-tone printing became widely available in the 1990s. Many of the key images were printed as photogravures and the remainder in half-tone. The photogravures were printed by J. Craig Annan, or two other outstanding firms, and some under Coburn's direct supervision, these representing the pinnacle of the process. There were no better quality reproductions at the time but nonetheless this does not imply that the original photograph was correctly or adequately represented. Steichen observed that "The very best of reproductions are not apt to do a reasonable justice to a pigment print, and the half-tone process has a particular tendency to reverse a quality which is most pleasing in the original, and make it detract and annoying in the printed reproduction; this is especially true of the grain and both in pigment and paper."¹²¹ Stieglitz himself clearly recognized the problems, realizing that "excellent as our reproductions are, they can not adequately convey the subtlety of the texture to be found in the originals; the quality of Demachy gum prints being inherent in the medium and incapable of reproduction by any other process."¹²² Even in the Twenty-first century, if the colors are correct and the screen is fine, "you will rarely get the tactile qualities right, and yet the underlying tactility plays a large role in determining how color is

¹²¹ Eduard J. Steichen "Accompanying Reproductions of Recent Work by Robert Demachy" *The Photographic Art Journal* Vol. I, No. 6, 15 August 1901, p. 163.

¹²² Editors *Camera Work* No. 5, 1904, p. 51.

perceived.”¹²³ To establish a new term, the gum print is ‘syntax inviolate,’ that is, it cannot be represented in any manner other than the original print without losing some amount of the information which composes it. It is particularly sad that this, the defining printing process of the early pictorial movement, cannot be reproduced well on the printed page. Photogravures failed in a less dramatic manner with the ubiquitous pictorial process, the Platinotype. One of Clarence White’s early students, who was also one of the final keepers of the pictorialist flame, Paul Anderson (American 1880-1956)¹²⁴ observed

One thing which the 'Camera Work' gravures will not reveal to you, but which could not be missed by anyone seeing the original prints, was the feeling for pure esthetic print quality that was inhered [sic] in each picture. Platinum was used because it was by far the finest printing medium in this respect; its dull surface, its magnificent reproduction of the gradation of the negative, its delicacy of highlights, its depth of shadow - these qualities are not rivaled by any other printing medium. The photogravures have a characteristic quality of their own, and an extremely fine quality it is, but they lack something of the sheer esthetic delightfulness of platinum. And when one works in hand-sensitized platinum on fine hand-made paper, as W. E. Macnaughtan nearly always did, and Karl Struss often did, the effect of the print, irrespective of the subject or of its treatment, brings a choking feeling to the throat of anyone who has a sensitiveness to pure beauty; no one who can thrill to the color or texture or perfume of a rose can fail to thrill to such a print.¹²⁵

Photogravures were the best possible reproduction technology available at the time, and indeed, for decades to come. It must be remembered, however, that many of the *Camera Work* illustrations were halftones and none are particularly memorable. Other magazines were exclusively half tone, very coarse in some early examples, and by Clarence White’s judgment, “I would say that the reproductions that we see in the magazines do not in all

¹²³ Crawford 1979, p. 16.

¹²⁴ Anderson was an instructor of printing technique at the ‘Clarence White School’ and eminently qualified to make this observation.

¹²⁵ Anderson April, 1935, p. 202. In the same article Anderson notes that he saw nearly all of the photographic exhibits at the Little Galleries’ and therefore had a sound basis for this analysis.

cases represent lens work but, I fear, bad printing sometimes.”¹²⁶ This recalls Estelle Jussim’s major conclusion on visual communication that “*the medium can interfere so seriously with the message that the only message which is transmitted is that of the medium itself.*”¹²⁷ Consider the plight of the amateur living in St. Louis or Leeds in 1920, who desirous of winning accolades in the camera club salon circuits, copied those award winning images reproduced in magazines, or at least thought they had copied the photograph when in reality, they had copied a poor quality reproduction, of a size unrelated to the original, devoid of detail, color, tonal range and texture. Not living in one of the few cities to have a museum which showed original photographic exhibits, they were unaware of their error since they had no point of reference. If the local and regional judges had no better point of reference, then the poor photograph had a fair chance at garnering awards and this salon circuit, which is a closed loop feedback, fails to engender and reward quality images (which do not resemble the poor halftones). A similar effect was observed during 2000-2005 when Scottish camera clubs largely decommissioned their existing wet darkrooms and established digital-PhotoShop® based facilities. With new tools at hand, the ambitious competitors now produced prints that closely resembled those in *The Amateur Photographer, Black & White* and other photographic magazines; the black and whites were stark, with few middle tones and sudden tonal shifts, the color images were garish without any subtlety, perfect facsimiles of the halftone illustrations in the magazines.¹²⁸

¹²⁶ White and Hoyt 1921, p. 7.

¹²⁷ Estelle Jussim *Visual Communication and the Graphic Arts, Photographic Technologies in the Nineteenth Century*, reprint (New York: R. R. Bowker Company, 1983) p. 308. Italic in the original text.

¹²⁸ The author, once a chairman of a Scottish camera club, personally observed this transition across Scotland.

Photography always has been and always will be a victim of syntax violations when an image appears on a printed page. Consider the syntax violations in a 21st century book with a reproduction of a sixth-plate daguerreotype on one page and a richly colored multiple gum print on heavily textured paper on the facing page. In book reproduction they rather look the same except for the color; both are printed the same size, on the same paper stock, the defining reflective nature of the daguerreotype is unknowable, the riot of texture in the gum layers and paper of the gum print totally absent. Note as well the very significant perceptual difference between a small photograph held in the hand, the same image on the wall in a matte and frame, and then that image alone reproduced in a book; the context modifies the content in any situation with any image, but this is especially true of the Pictorialist photographs. As soon as a matte print such as platinum print is placed behind glass, it loses one important dimension of its syntax which was intended to be conveyed to the observer by the photographer — its tactile surface.

The illustrations in this thesis are no less subject to syntax failure, especially design syntax, than any other printed medium. Technical syntax unique to the soft-focus image fails even with excellent modern technologies. Experimentation by the author has confirmed that even when scanned from an original negative at 1200 dpi and printed at 300 dpi on a high quality Epson printer, the tonality of soft-focus edge glow, that delicate separation of the higher tones, cannot yet be achieved. There is also some indefinable characteristic of a middle tone diffuse edge which is not satisfactorily rendered and leaves the reproduction lacking in finesse and tonal smoothness.

Even the best quality magazine reproduction may have indirectly contributed to the demise of Pictorialism and the rise of the Modernist and f/64 movements in two

different vectors. First, “The increased use of photography in advertising has worked harm to pictorialism by its insistence on brilliant effects rather than delicacy, on the use of full scale rather than a compression of values,”¹²⁹ this advertising was intended to be delivered via the popular magazines then in ascendancy. Secondly, “Unlike Pictorialist views, whose narrow tonal range reproduced poorly, the fullness of photographic tones encouraged by the new aesthetic made pictures that reproduced well, with clearly defined highlights and shadows and clean lines at the interstices of light and dark.”¹³⁰ Most of the photographs would be printed small and always in halftone, thereby masking many of the deficiencies of the small format negatives used by journalists. It should be added that other syntax ‘markers’ of Modernist images such as the stark white mattes, glossy silver gelatin paper, neutral black and white tone, and inherent higher level of information transfer all allowed the ‘new photography’ to be disseminated widely and accurately simply because the syntax of the print closely paralleled the syntax of the printing process and presentation.

Smaller Cameras and New Attitudes – Changing Syntax

The single most pervasive cause of Pictorialism’s demise, regardless of geographic locale, was the amateur’s rapid adoption of new technology.¹³¹ In simplistic terms, flexible roll film, smaller cameras and more sensitive enlarging papers rapidly replaced the standbys of the earlier Pictorialists. As early as 1912, “The old reliable

¹²⁹ Anderson April, 1935, p. 209.

¹³⁰ John Pultz “Austerity and Clarity; New Photography in the United States 1920-40” Michel Frizot ed. *A New History of Photography* (Koln: Koneman, 1998) p. 481.

¹³¹ The same may be said of the 21st century where photographers have available the powerful digital processing tools and the widest variety of papers (ink jet) available in 50 years. They are manipulating images to a degree never dreamt of by the Pictorialists and drifting rapidly away from the f/64 School and ‘straight’ photography.

“eight by ten” has given place to the vest-pocket camera,”¹³² which seems to compare dissimilar groups as those who had formerly used a large view camera distinguished a more serious set of amateurs, and those who now used a vest pocket camera were almost certainly ‘hobbyists’ at best. The more serious workers did downsize and often moved from view cameras to the more flexible (and portable) reflex camera. By 1923 “The most popular camera used by the pictorial worker is the reflex, with perhaps a soft-focus lens, or one which has a device for diffusion. Of the three sizes, 2¼ x 3¼, 3¼ x 4¼, and 4 x 5, the 3¼ x 4¼ seems to be the favorite, fitted with a lens ranging from 7” to 10” in focus.”¹³³ Negatives in this size range were too small for advantageous contact prints and “are not of much use without enlargement except as mementos in albums,”¹³⁴ unless they were made as stereopticon slides and projected. It was argued that the smallest negative, the 2 ¼x 3 ¼, made as good an enlargement up to 9 x12 inches, as the 3 ¼ x 4¼, and produced the correct size for stereopticon slides without trimming, represented a cost savings on film of about 30% and, obviously, was less bulky and weighed less.¹³⁵ In order to suggest some relative measure of quality of the final image, consider the nominal area of the negative in square inches: 2¼ x 3¼ (7.3), 3¼ x 4¼ (13.8), 4 x 5 (20), 5 x 7 (35), whole plate (51.6), 8 x 10 (80). Therefore the popular new 3¼ x 4¼ negative was only one-sixth of the area of an 8 x 10 negative, and the 2¼ x 3¼ negative was less than one-tenth the size of an 8 x 10. These small negatives, unless enlarged negatives were produced, precluded platinotype or palladiotype prints (both Coburn and Strand made

¹³² A. E. Swoyer “Pinhole Enlarging” *The American Annual of Photography 1913* (New York: The American Annual of Photography, Inc., 1912) p. 25.

¹³³ Gillies 1923, p. 82. This was arguably the last worthwhile text on pictorialism, all that post-date it are lacking in both understanding and technique, written by relative unknowns who were more writer than photographer.

¹³⁴ Author uncredited “Photography with Reflex Cameras and Focal-Plane Shutters” *The Photo-Miniature* Volume XIII No. 151 June 1916 p. 297.

¹³⁵ Author uncredited June 1916 p. 297.

enlarged negatives for platinum printing); Paul Anderson believed the latter amateurs would not take the trouble to make enlarged negatives because they were too lazy.¹³⁶ The West Coast f/64 school *required* a view camera for photographic art, demanding a return to their earlier pictorialist roots; as far as can be determined, Weston, Edwards and Adams¹³⁷ had always continued using the cumbersome view camera while photographic technology passed them by. As John Paul Edwards wrote, “The modern purist movement in photography ... presents nothing essentially new, but is a definite renaissance.”¹³⁸ But a renaissance of what? Adams answered that question with “it bears a much closer relationship to the 1860s and the 1870s and what those decades produced in straight-forward photography,”¹³⁹ more specifically, “the old photographs of Hill, Cameron, Brady, O’Sullivan, Emerson, Atget, and others of earlier days...”¹⁴⁰ It seems rather incongruent that Adams would enumerate three of the Pictorialists’ Pantheon (Hill, Cameron, Emerson) for his role models and two (Brady and O’Sullivan) whose blank white skies are the diametric extreme from Adams’ own dark gray to black skies.

It is fair to say that the seventy year old f/64 school is still viable and growing in the United States; two of the most prominent large format dealers in the United States, Midwest Photographic Exchange (Columbus, Ohio) and The View Camera Store (Phoenix, Arizona) report that the demand for large format equipment continues unabated in the face of the digital onslaught.¹⁴¹ Britain and Europe were beyond the reach of the

¹³⁶ Anderson April, 1935, p. 209.

¹³⁷ Adams briefly experimented with 35 mm in the 1930s, however, but this was never intended to supplant his view cameras.

¹³⁸ Edwards March 1935.

¹³⁹ Ansel Adams “What is good photography?” *Camera Craft* Vol. 47 (1940) reprinted in Jean Tucker *Group f.64* (St. Louis: University of Missouri-St. Louis, 1978) p.12.

¹⁴⁰ Adams 1944, 120.

¹⁴¹ Telephone interviews with the owners, Jim Andrachi for Midwest Photographic Exchange (Columbus, Ohio) and Fred Newman for The View Camera Store (Phoenix, Arizona), January, 2007.

f/64 School and never revived the view camera, instead incorporating the contrasty, grainy effects of miniature format into their developing Modernist aesthetic, sending them on a divergent path from the United States in art photography.

Even these relatively small hand-held reflex cameras were soon superseded by even smaller roll film cameras, “Everything nowadays [1935] is Leica, Contax, or Vest-Pocket and the 8 by 10 view camera, the favorite instrument of the Secessionists, is an anachronism.”¹⁴² The Germans, and presumably all of Europe, saw similar reductions, “Around 1930, the usual size is 9 x 12 cm., some professional photographers were using 18 x 24 and a few amateurs 6 x 9 cm. Nothing else existed for the serious photographer. The last year's issue in 1938 shows completely different conditions. Here to most widespread size is 6 x 6 cm.”¹⁴³ These should not be compared to the results given by modern 35 mm cameras as the film in the 1930s had much coarser grain and the lens quality was mediocre, even the Leica was not equal to lens produced 50 years later. Only Leica manufactured a 35 mm format soft-focus lens until Minolta produced one in the 1970s, thus these small formats forced photographers to sharp lenses. The other two popular camera designs, rarely mentioned in texts but its popularity attested to by the volume of advertisements and surviving examples, were folding roll film cameras and twin-lens-reflexes,¹⁴⁴ both with a non-interchangeable lens; they were not candidates for soft-focus lens use either. Thus as the cameras shrank in size, the worker desiring a diffused image was left with two options, neither as desirable as a soft-focus lens: either a

¹⁴² Anderson April, 1935, p. 209.

¹⁴³ Scholtz 1979, p. 88. The 6x6 cm format cameras were largely twin lens reflexes such as Rolleiflexes.

¹⁴⁴ The twin-lens-reflex or TLR had another syntactical element - it lowered the taking lens to about the photographer's navel, dropping the view point from the eye level to perhaps 18 inches lower. Especially when photographing another standing person, the lens looks upward and creates an unnatural perspective of the face.

slip-on attachment such as the *Duto* or diffusion in the darkroom. There was, in essence, a trading of time spent in the field with a view camera for time spent in the darkroom making the enlargement. In lieu of careful exposure and development by inspection, one negative at a time, photographers now widely bracketed exposures and developed dozens of frames at a time in a closed tank by the assistance of a time and temperature chart. Kühn had warned that “Blind developing is and remains useless for the person who is aiming at certain goals as far as tonal values are concerned; and a collective treatment renders consistent attainments impossible [roll film].” “Personal, picture-creating aims cannot withstand mechanization. The fact of the matter is that aesthetic matters cannot be dispatched in mass production.”¹⁴⁵

The transition from cameras which can easily make use of a soft-focus lens to inappropriate cameras coincides well with marketing information for soft-focus lenses, wherein the peak of soft-focus models is clearly in the mid- to late-1920s.¹⁴⁶ It is admittedly difficult to determine from the reproductions which images are diffused ‘in-camera’ and which ones are created from sharp negatives in the darkroom unless technical data is provided.¹⁴⁷ However, by the 1930s, some annuals published full technical information, beginning with Das Deutsche Lichtbild in 1930 and U.S. Camera Annual in 1935.¹⁴⁸ In examining those annuals it is clear that the diffused images reproduced therein were created primarily by soft-focus attachments on the lens (the *Duto*

¹⁴⁵ Kühn 1936, p. 5.

¹⁴⁶ Author’s conclusion after examining hundreds of English-language photographic magazines dating from 1890 through 1930 and coarsely tabulating the advertisements.

¹⁴⁷ With an *original* print in hand, the difference is easily observed. Unless created in the darkroom by a relatively complicated methodology, a diffuse print created under the enlarger has the blacks bleeding into the whites, whereas an in-camera image has the whites bleeding into the blacks. This is another ramification of syntax.

¹⁴⁸ While under the editorship of F. J. Mortimer (until 1944), *Photograms of the Year* never provided technical data on the images.

in Germany) or in the darkroom, not by a soft-focus lens on the camera. Unless created in the darkroom by a relatively complicated methodology, a diffuse print created under the enlarger has the blacks bleeding into the whites, whereas an in-camera image has the whites bleeding into the blacks, a visual variant not a true analog of a soft-focus lens.

Alfred Buschbeck, at the Vienna Camera Club in 1894, initiated the concept of a net over the lens, thereby claiming precedence on the concept of an in-front of the lens attachment to alter the diffusion characteristics.¹⁴⁹ Hugo Henneberg commented favorably that Bushbeck's net "has given at least a surrogate for the monocle in landscape matters."¹⁵⁰ It is not clear whether the idea diffused through the club and into the larger amateur photographer population, however, it was adopted by the great Belgian pictorialist, Léonard Misonne (Belgium 1870-1943) at some time in his career and was successful enough he marketed them as "flou-net,"¹⁵¹ after patenting the idea in 1931.¹⁵² As a black net, it does not add flare to the diffused image as does nearly every other method, and the degree of diffusion is controlled by the density of the net, the finer the grid the greater the diffusion.

¹⁴⁹ Kühn 1926, p. 56.

¹⁵⁰ Kühn, 1926, p. 56

¹⁵¹ Marian Schwabik and Maurice Misonne *Léonard Misonne Ein Fotograf aus Belgien 1870-1943* (Seebruck: IM Herring, 1976) unpaginated. 'Flou' is the French word for hazy or soft.

¹⁵² Marc Vausort "Biographies" section in *The Impressionist Camera* (London: Merrell, 2006, p. 302.



Figure 7.14: Modern ‘flou-net’ manufactured by Bronica ca. 1980. It is essentially identical to the one original Misonne product the author examined in the collection of David Lewis (photograph by the author).

The first was the Goerz *Mollar* “attachment for this purpose introduced in Germany in 1920(US Pat 1,556,982, 1925). It consisted of a thick plane-parallel plate containing a buried surface” so constructed to induce chromatic aberration.¹⁵³ It was followed in rapid succession by the Pinkham & Smith *Wolfe Artistic* (1921), Eastman *Diffusion Disk* (1921),¹⁵⁴ and latterly by the Rollei *Duto* (1935).¹⁵⁵ These were all clear glass attachments with no focal length which fit in front of the lens; the first two are exceedingly rare and none could be located for examination but the latter two were carefully examined. Although they operate on a basically similar premise, they are, at the

¹⁵³ Kingslake 1989, p. 188.

¹⁵⁴ Both the *Wolfe Artistic* and the *Diffusion Disk* were first announced in the December 1921 edition of *The Photo-Miniature* advertising section.

¹⁵⁵ The earliest known advertisement is in *Das Deutsche Lichtbild Jahresschau 1935*. It was invented by Hungarians Jeno **D**ulovits and Miklos **T**oth, Du + To, in 1932. See the Hungarian Patent Office web site for further information.

same time, quite different. The *Diffusion Disk* has a series of straight interlinked lines, rather like a spider's web, raised on the surface and the glass must have been cast in that configuration. By comparison, the *Duto* is a series of "lines, or grooves, surrounding the clear circle in the center. The lines are alternatively thin and thick and equally spaced..."¹⁵⁶ Both of the attachments possessed a large percentage of surface area that was not interrupted and this passed the light without interference such that the image maintained a sharp core. The amount and type of surface disfigurement (from planar) controlled the character of the diffusion. This type of attachment is very dependent on the aperture of the lens and the *Duto* could not be used when the lens was closed beyond $f/5.6$ ¹⁵⁷ and the same was probably true of the *Diffusion Disk*. These two attachments form an image somewhat like a soft-focus lens in that there are rays passing through the filter which are undisturbed, analogous to the axial rays, and other rays which being interrupted do not form a sharp image, much like the marginal rays.

¹⁵⁶ Jacob Deschin *Rollei Photography, Handbook of the Rolleiflex and Rolleicord Cameras* (San Francisco: Camera Craft Publishing Company, 1952) p. 65.

¹⁵⁷ Deschin 1952, p. 65.

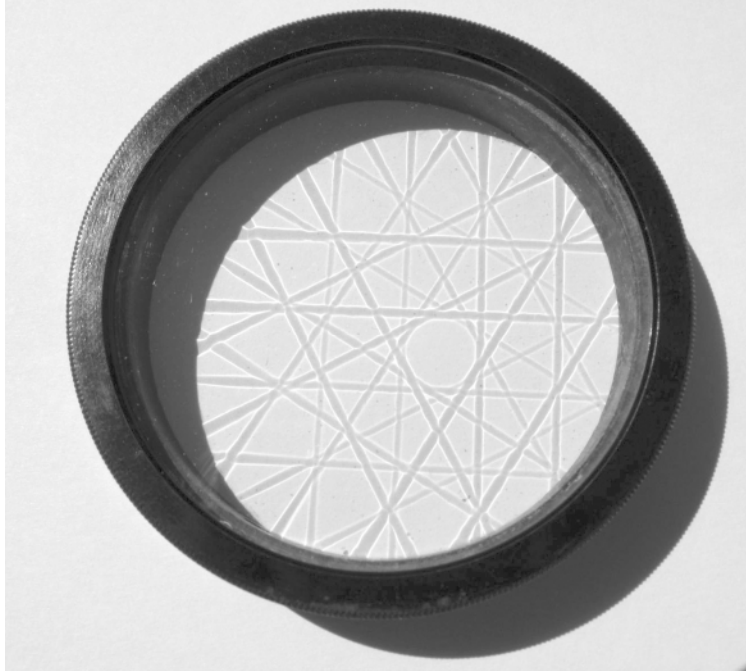

Figure 7.15: Shadows produced by the pattern of an Eastman *Diffusion Disk* (collection of the author).

The *Wolfe Artistic* operates on an entirely separate principle according to papers in the U. S. Patent Office archives. Louis Bell and Walter G. Wolfe filed for a patent on January 4, 1921, which was granted as Patent #1,446,634, February 27, 1923. Their device is an auxiliary lens consisting of two cemented elements but with no focal length which “introduces sufficient chromatic and spherical difference of focus to soften the contour of the resulting image...” Wolfe was an employee of Pinkham & Smith but Bell is unknown. He was granted about ten patents on a variety of optical and electrical devices in the first thirty years of the twentieth century according to U. S. Patent Office archives papers.

Several modern filter companies continue to produce a *Duto*-like attachment, Hoya’s being most true to the original model. These are substantially different in effect from the fog and diffusion filters which have a pattern throughout the filter surface and

degrade the entire image, leaving no portion sharp. Diffusion attachments are inexpensive compared to a soft-focus lens, since they do not change the focus a camera with distance-scale focus is feasible, and they can be used on an existing camera. Moreover, they require none of the difficult decisions of the soft-focus lens, including where to place the chief focus and which aperture will produce the desired type of diffusion; they can simply be slipped over the lens and all else is as per standard practice, no learning curve involved. Kühn's thoughts on these attachments were not complimentary, "all the auxiliary glasses and lenses, may they bend or refract, add the disadvantage of introducing further reflecting surfaces, reducing light transmission, I find them to be aids, not being solutions. And one might add the view that it is none too functional to first bring sophisticated computations to free a lens from aberrations and then re-introduce them."¹⁵⁸

All of these slip-on lens attachments were equally applicable in the darkroom, attached to the enlarger lens. The original Pinkham & Smith advertisement for the *Wolfe Artistic* closed with the admonition that the photographer could obtain "beautiful soft-focus enlargements from your vest pocket [Kodak camera] films,"¹⁵⁹ appealing to a less discerning class of amateur who were less willing to invest in quality equipment. A delicate effect is secured by the use the diffusing screen for 50% or less of the total printing time, thereby emulating the soft-focus lens appearance of a sharp image overlain by a diffuse image. As the use of soft-focus lenses steadily declined beginning in the late 1920s, the diffused image remained in the aesthetic mainstream although it was more often created by this kind of technique in the darkroom, and by more complicated and

¹⁵⁸ Kühn 1926, p. 59.

¹⁵⁹ Pinkham & Smith advertisement in "Soft Focus Effects in Photography" *The Photo-Miniature* Volume XVI No. 184 December 1921, unpaginated.

very time consuming practices such as paper negatives¹⁶⁰ and abrading the print.¹⁶¹ The emphasis had shifted from taking technique in the field to darkroom handwork. Thus Pictorialism had come full circle, back to diffusion produced by the hand-work printing process, just as in the 1890s with gum and oil prints before the invention of the *Semi-Achromat* and its descendents.

COMPACT ECONOMICAL **Leica** SPEEDY RELIABLE

POCKET ROLL FILM CAMERA

USING
CINEMA FILMS OF STANDARD SIZE

SMALL NEGATIVES BUT LARGE PICTURES



THE SMALLEST CAMERA WITH FOCAL PLANE SHUTTER
Camera can be loaded in broad daylight

Size: 5½ x 2¼ x 1¼ in. -

Weight, including cartridges and film, 1 lb.

Inexpensive Negatives through use of Standard Cinema Films.

Twelve "Leica" Exposures less expensive than one exposure, 3¼ x 4¼ in.

One Cartridge holds Film for 36 pictures.

Instantly Ready for use through automatic Filmtransport when winding Shutter — **Double-Exposure impossible.**

Focal Plane Shutter for time and instantaneous exposure to 1/500 seconds.

Leitz-Anastigmat "ELMAX," F:3.5 50mm., most highly corrected objective — results in sharpest negatives available for enlargements to 8 x 10 in., partly also due to fine grain of cinema-film.



Objective of short focus creates tremendous Depth-Effect.

Enlargements reveal surprising Perspective and natural proportions.

"Fedia" Near Range Finder permits focus to minute sharpness.

Telescope View Finder for rapid sighting in eye position.

New Enlarging Apparatus produces in simple and quick manner enlargements to 8 x 10 in. with lens F 3.5 —

Copied as Diapositive Film "Leica" Pictures are projected with "Leica" Film Projector.

The "Leica" Camera is the Camera of the Future

It represents a **Universal Camera**, equally well suited for Studio, Home, Landscapes, Sport, Industrial Purpose, etc. **Each modern Photographer** will utilize the "Leica" Camera to **great advantage and complete satisfaction.**

The "Leica" Camera is the most ideal Travelling Camera, permitting at smallest volume and weight the largest number of exposures with one load.

Ask your dealer about this "Leica" Camera, or write for Catalog No. 1098 (D)

E. LEITZ, INC.

Agents for California, Washington, Oregon, Idaho, Utah, Montana, Nevada and Arizona: **60 EAST 10th STREET,**
SPINDLER & SAUPPE. Offices at San Francisco and Los Angeles, Calif. **NEW YORK, N. Y.**

¹⁶⁰ Nowell Ward *Picture Making with Paper Negatives* (Boston: American Photographic Publishing Co., 1943).

¹⁶¹ William Mortensen *Print Finishing* (San Francisco: Camera Craft Publishing Company, 1938) and *Projection Control* (San Francisco: Camera Craft Publishing Company, 1934). Mortensen produced a seven book series on photography that was popular enough that some went through as many as three editions. Although venomously attacked in print by Ansel Adams, it is certain that Mortensen's series formed the template for Adams later series.

Figure 7.16: 1928 Leica advertisement for the ‘camera of the future’ (*American Annual of Photography, 1928* advertisement 25). In a passing nod to pictorialism, Leitz introduced the first 35mm format soft-focus lens, the *Thambar*, to their product line in 1935. It was a four element Hektor-type design with added spherical aberration and required a special attachment in front of the lens which occluded the axial (sharp) rays of the lens; about 3,000 were thought to be produced.¹⁶² Because it was slow to use and since the effect could not be viewed (this camera is a rangefinder), the sales were poor. Leitz did not remove it from their catalog until 1942,¹⁶³ when undoubtedly the war effort required their full production capacity. It is remarkable that these unessential items were not discontinued by 1939 or 1940.

For many early Pictorialists, the beginning of the end was evident by the termination of The Great War, although not necessarily caused by the war itself. Paul Anderson agreed that a “spiritual decadence” had set in since the war, engendering a need for “entertainment without effort... and pictures that are striking rather than beautiful... We demand pictures that leap forth from the walls of exhibitions, that hit us in the eye rather than sing to us... if they give us a shock they are great pictures.”¹⁶⁴

New Generation of Photographers

As early as 1910, Robert Demachy observed that “*Pictorial photography is at a standstill because it is becoming mechanical again, and for no other reason* [italics Demachy's].”¹⁶⁵ He spoke prophetically that “Very few men will follow this course [study the craft of photography and printing processes], and little by little, the number of serious pictorialists will diminish, and the average of pictorial work will descend lower and lower. Photography will go back to its previous level. It will be an amusement, an

¹⁶² Scholtz 1979, p. 35.

¹⁶³ Gianni Rogliatti *Leica, the First Seventy Years* (? : Hove Collector’s Books, ?) p. 161.

¹⁶⁴ Anderson April, 1935, p. 210.

¹⁶⁵ Robert Demachy “Mechanism and Pictorial Photography” *The Amateur Photographer & Photographic News* March 15, 1910 p. 271. This is part of an exchange between Evans and Demachy over the nature of pictorial printing.

agreeable pastime, but nobody but photographers will mistake it for 'Art.'"¹⁶⁶ His estimate that it will "go back to its previous level" accurately foreshadows Adams' and Edwards' statements regarding the philosophy of Group f/64.¹⁶⁷

The section, Appendix B, in "Photographers by Year of Birth," lists many major Pictorialist photographers by their year of birth, some born as early as the 1840s. With some notable exceptions such as Coburn and Steichen, most were born before 1875, and thus many were growing aged by World War I. A partial mortality schedule includes Robinson (1901), Watzek (1903), Hinton (1908), Bergheim (1912), Smith, lens designer (1917), Henneberg (1918) and Duhrkoop (1918). Davison had withdrawn from photography by 1912, Demachy withdrew in 1914, Evans slowly withdrew ca. 1917, Day retired to bed in 1917, and Coburn would greatly decrease his activities in photography, Stieglitz was now preoccupied by Georgia O'Keeffe and modernist painting. By the early 1930s, most of the old guard, the innovators and prime movers of the movement, had died or left the art. A new generation of photographers populated the amateur ranks and especially regarding soft-focus lenses, were lacking in vision, talent, craft or historical perspective.

Day, definitely one of the masters of the soft-focus lens, wrote in 1921 "Of late years the majority of people using the lens are apparently little acquainted with its capability or are properly acquainted with its best work."¹⁶⁸ The same year, another master, Clarence White, expressed a nearly identical observation "Today the trouble with

¹⁶⁶ Demachy March 15, 1910 p.271.

¹⁶⁷ See page 57.

¹⁶⁸ F. Holland Day, draft letter to an unnamed correspondent, written by an amanuensis, dated July 8, 1921, p. 8.

photographs, as I see it... is now a fuzziness and muddiness that is bad. There is need of definiteness and depth, detail and tone.”¹⁶⁹

There was a steady and relentless trend from about 1920 onward to produce soft-focus lenses with ‘greater firmness’; these new designs did not contribute anything new and useful but progressively reduced the spherical and chromatic aberrations until the trademark highlight glow was barely manifested and rather than a luscious softness, produced negatives similar to ones created by low-quality lenses lacking a sharp focus. “The tendency is toward the production of lenses with a minimum degree of diffusion at a large opening... For portraits this is an excellent arrangement, but the various planes of differing diffusion are very abrupt and the transition from one to the other is extremely sudden. With the older types, which had to be stopped down to F:8 or F:11 to secure usable diffusion, the quality of the image was much more under the worker's control.”¹⁷⁰ Thus much was lost of the quality of the early soft-focus lenses, and it should be noted that virtually no famous Pictorialist used these firmer lenses (see Appendix C: Photographers and Their Lenses).

For reasons not clearly elucidated, Pinkham & Smith found “It was necessary to make the soft-focus lens more 'fool-proof.' In these later lenses [*Visual Quality* and *Synthetic*] the diffusion is modified considerably so that the lens can be used at a large aperture without too much overlapping of light into an adjacent shadow.”¹⁷¹ In 1920, Wollensak redesigned the immensely successful *Verito* with similar effects.¹⁷² In all cases, the new designs, whether original or modification of extant lenses, were intended

¹⁶⁹ Clarence White responding to query from Tennant, December, 1921 p. 190.

¹⁷⁰ Tennant December, 1921, p. 158.

¹⁷¹ Arthur Hammond “Smith Soft-Focus Lenses” brochure (Boston: Pinkham & Smith, ca.1916) unpaginated.

¹⁷² Tennant December, 1921, p. 158.

to create a lens that “requires no more study than a high-grade anastigmat in order to obtain results,”¹⁷³ that is, they were vastly easier to use, without gaining experience in the manner of the early lenses. This reflects Demachy’s forecast that the newer amateurs would not spend adequate time to master a difficult method, no matter the potential benefit to be gained. Most amateurs eschewed soft-focus lenses entirely by the 1930s, using a diffusion attachment over the taking lens or creating the effect in the darkroom, neither of which produce the same effect. By 1935, the *U.S. Camera Annual* lists only three photographers in the volume who used a soft-focus lens (*Verito, Vitax, Visual Quality*) and the same publication in 1939 lists only one, a *Graf Variable*. By the onset of World War II, soft-focus lenses had been all but forgotten among amateur photographers.

Heinrich Kühn was in a retrospective mode in 1936, looking back to the state of photography at the turn of the century and comparing it quite unfavorably to its condition in 1936, noting the progress in the syntax of photography have not resulted in higher quality photographs:

It should be apparent to everyone who wishes to compare the cultivated achievements of the twenty years preceding the Great War with the present day mass production. One only needs compare picture examples of technical magazines of that time (and the articles accompanying them!), which stood at an imposing level, and what is being offered today, in order to come to the conclusion that a great deal has been lost as far as conception and thorough understanding as well as technical ability is concerned. In the meantime, industry has made such tremendous progress in the production of materials and supplies. This progress should have resulted in greater achievements! Once again, however, it becomes clear that the means available do not insure satisfactory results; will and the ability are paramount!¹⁷⁴

¹⁷³ A. H. Beardsley “The Beginner and the Soft-Focus Lens” *Photo-Era* Volume XLVI, No. 6, June 1921 pp 310-311.

¹⁷⁴ Kühn 1936, p. 3.

His last sentence is an indictment of the amateur photographers of 1936, equipped with the finest technology ever available but without the motivations and technical mastery necessary for artistic treatment. Kühn also notes the decline in the quality of published articles, a problem which had begun much earlier; Demachy complained in 1904 ““I have gone through most of these articles, and though I have been steadily working with, if not at, the process since 1894 [gum bichromate] some of them seemed exceedingly strange and new, others a little too familiar [i.e., plagiarized], very few honestly instructive. Some much so that I have often been haunted by a cruel doubt in regard to the practical experience of some authors.”¹⁷⁵ Demachy is describing the ‘read a book — write a book’ syndrome which was to plague later Pictorialism, and photography more generally, from perhaps World War I onward, wherein unknown writers composed articles on topics that they clearly had little grasp of, or else the articles were empty and vapid, lacking any critical information. This trend became most obvious in the photographic annuals, where in earlier years well regarded experts had composed lengthy elucidations on their topics but editors soon printed one and two page articles, far too brief to give a satisfactory treatment to most subjects.

Camera clubs degenerated, in part, because of the competition for salon awards had replaced philosophic underpinnings with the aesthetic becoming ever more decadent and further from the Pictorialist ideal until they became, just as Nancy Newhall said, when referring to the Pictorial Photographers of America, “They sank into unbelievable quagmires — trash worse than the Robinson period: babies, kittens and puppies of insufferable cuteness; bosoms brimming over gypsy costumes; the gray bearded old man with Bible or pipe, the old lady knitting. The greasy nude, often with Clarence White's

¹⁷⁵ Robert Demachy “The Gum Print” *Camera Work* No. 7 July 1904 p. 33.

celebrated bubble, not without pornographic overtones.” One subject in particular, the ‘fantasy still life,’ which had no antecedent in Pictorialism, had become part and parcel of the camera club’s competitions and remains so today. With the decay of Pictorialism in the camera clubs and salons, the old criticisms of Pictorialism had finally become true.

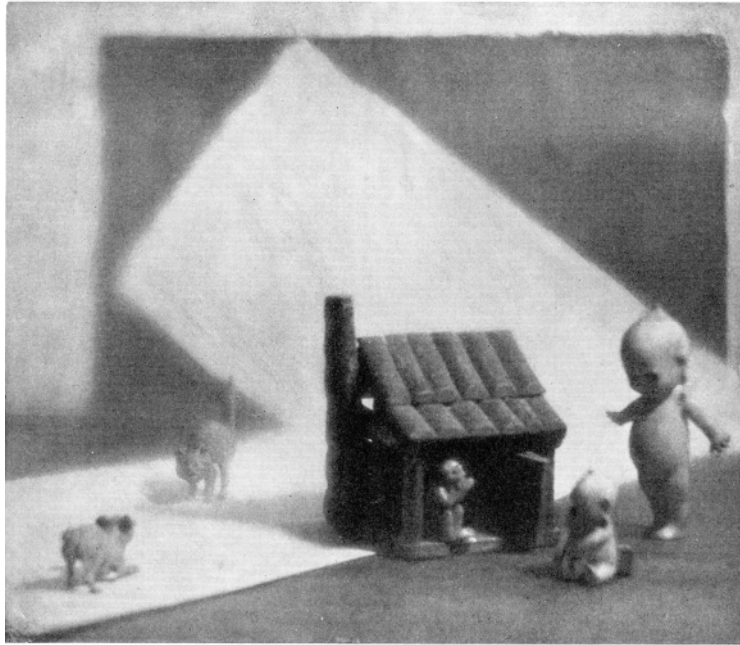

Figure 7.17: Frank R. Nivison, *A Concert in the Nursery*. On the facing page is *Grey Attic* by Edward Weston, an interesting juxtaposition. This sort of saccharine, cliché ridden table top still-life image creeps into pictorial vocabulary by 1920, and it is unfathomable why the PPA chose such images to publish in their annuals (*Pictorial Photographers of America Pictorial Photography in America 1922* p. 58).

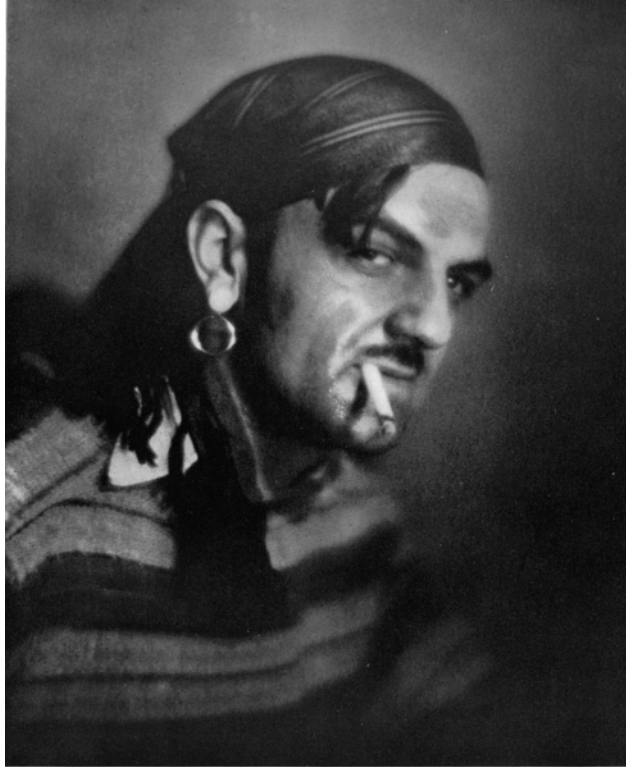

Figure 7.18: L. H. Longwell *The Cigarette* (*American Annual of Photography 1928* p. 52). Along with the ‘fantasy still life,’ the male ‘character’ became a standby of American and British photography after the early 1920s. Although the influence is unclear, it could be Hollywood portraits of famous actors in their role or the “famous silver-bearded, shiny-nosed tramps of the Munich school.”¹⁷⁶

Summary

The causes of the decline of the soft-focus aesthetic and Pictorialism more generally are more multitudinous and complex than generally acknowledged. It would require a thesis devoted to this one topic to discuss it thoroughly; however, certain elements are prominent in its demise although the intensity and timing varied greatly according to geographic location. The three most universal causes were World War I, syntax failure in the reproduction process and finally, the changing syntax of equipment. The latter two had world-wide effects that were more simultaneous in their occurrence.

¹⁷⁶ M. F. Agha *Pictorial Photography in America 1929* (New York: Pictorial Photographers of America, 1929) no pagination.

Events in Britain beginning in 1908 led to a stultification of the Pictorialist movement there. The 1908 Linked Ring annual exhibition controversy moved F. J. Mortimer to spontaneously produce a 'Photographic Salon des Refusés' with the entries rejected by the controversial hanging committee, thereby thrusting him into prominence and effectively conferring the *de facto* leadership of British Pictorialism. British pictorialists interviewed the following year expressed the belief that British photography had reached a plateau that, in hindsight, was its historical climax. It lost international leadership and migrated into the camera club scene where it languished for decades without achieving any progress.

World War I dealt a mortal blow to most European Pictorialism from multiple causes. Germany had been the world's great supplier of photographic chemicals, lenses and raw optical glass. Military forces everywhere requisitioned lenses from civilian photographers and the production of film and new equipment went entirely towards the war effort. Even after the Treaty of Versailles, there were equipment shortages for years as the Allied manufacturers re-tooled and the Axis facilities lay in ruin. As Europe finally began full recovery, the world was changed forever by the Great Depression. America was less changed by the war than Europe and particularly in California, Pictorialism flourished well into the 1920s before succumbing to the changes wrought by the 'Group f/64' school in the 1930s. Nonetheless, as in Britain, there was already an air of decay brought on by other causes even before the conservative stalwarts retreated into the camera clubs and salon circuits.

Perhaps the major reason for the demise of Pictorialism was the inevitable problem of syntax violation. In the camera magazines which proliferated after 1900, the

standard mode of reproduction was the halftone with a coarse screen and black ink, which did no favors to the qualities of the original image. Even the expensive and visually stunning photogravure process used by Stieglitz in *Camera Work* rarely reproduced an image full size and in correct hue. Moreover, colored prints such as multiple gums and autochromes simply could not be reproduced with accuracy. As a result, the aspiring pictorialist had inaccurate exemplars and with little opportunity to see an original print, would be unaware of his error. It is particularly unfortunate that the major positive processes utilized by the Pictorialists were deprived of many of their important qualities in even the finest reproductions; the delicate tones of a soft-focus image were almost impossible to accurately capture in mechanical reproduction. On the other hand, the new 'purist' school, exemplified by the Group f/64, saw their prints reproduced beautifully by the standard reprographic methods. Some degree of syntax failure is inherent in photographic imagery but is most marked in the non-silver processes so beloved by the Pictorialists.

The third major factor in the demise of Pictorialism and especially the application of soft-focus lenses, were the dual new syntaxes of equipment and film. There had been a steady trend in soft-focus lenses toward 'firmer' images and lenses that were as easy to use as an anastigmat; this change created new soft-focus lenses which lacked the subtle and elegant rendering of the earlier lenses. The soft-focus lens probably peaked in popularity during the mid-1920s in the United States and was rapidly replaced by diffusion in the darkroom, which produced a decidedly inferior effect. A large portion of this change from the taking instant to the darkroom session was caused by the changes in the cameras, moving inexorably toward ever smaller formats. More concerned with speed

and bulk (and perhaps a trendy appearance to the other club members), the amateur market rapidly abandoned sheet film format cameras for roll films and 35 mm cameras. These smaller sizes precluded the effective use of a soft-focus lens and forced the photographer to either use a diffusion screen over the camera lens or the diffusion was effected in the darkroom, by simple solutions such as a diffusing filter under the enlarger to laborious techniques like paper negatives. The new amateurs were driven not by an aesthetic philosophy so much as the desire for recognition in the monthly club competitions and salons; they were already ignorant of the techniques wielded so effectively by the early pictorialists and because they needed numbers of prints to enter into various competitions, sacrificed print quality by relying on bromide enlarging papers. Effectively the soft-focus lens was obsolete by the early 1930s, a fact corroborated by technical data in the annual publications.

Two reputed causes of demise, the scarcity of platinum and the 1910 Albright exhibition proved to not withstand careful scrutiny. Although Platinum prices did soar, it not only was it available for another two decades but the Palladiotype was a very close substitute and was widely available. Although Stieglitz became disenfranchised with pictorialism and photography more generally after 1910, the process was not rapid and certain. Moreover, his lack of interest did not serve to de-motivate the hundreds or even thousands of amateurs around the world who had made Pictorialism's revolution against traditionalism so successful. Pictorialism did not expire as a vital force until circa 1930, nor indeed, die at all, but faded away gradually with the occasional cyclical resurgences experienced by most art movements.

Chapter 8: Conclusion

When the history of Artistic Photography comes to be written, the question of diffusion will assume its real importance.¹

Alvin Langdon Coburn (1911)

The concept of syntax was first applied to printmaking by the curator of the Metropolitan Museum's print collection, William M. Ivins, in 1953. Ivins developed the idea that the appearance of a print was controlled by the mechanical specifics of the printmaking process, or syntax, such that a lithograph inherently possessed different visual appearance from, say, an etching. His familiarity with photography was limited and he stated that photography had no syntax. A quarter of a century afterward, photohistorian William Crawford, given his greater acquaintance with the medium, corrected Ivins' error and elucidated the concept of photography's syntax, which was *technology*. A photographer can only capture an image and present it within the limits of the contemporaneous technology. A corollary to Crawford's dictum is that photographic artists can only realize their vision when the technology has enabled it and when they have adequately mastered that new technology to manipulate it to their will.

Photographic syntax is composed of all elements requisite for capturing the image: film, camera, lens, etc., and ends with the printing of the final image; it is a system of many parts, with nearly infinite combinations and permutations, all of which create the complex syntax of photography. Whether creating a daguerreotype or a digital image, there are four elements necessary for the pictorial image: a device to organize the light rays into an optical image (usually a lens), a timing method (usually a shutter), a

¹ Alvin Langdon Coburn "The Question of Diffusion" *Semi-Achromatic Lenses* (Boston: Pinkham & Smith Company, ca. 1911) unpaginated

light proof container (the camera), a light sensitive media (film or charged couple device) to capture the formed image and usually (not in the case of direct positive processes) a fifth element, a printing method. In most pictorial applications, the lens creates the largest single variable in the combination of elements that forms photography's syntax.

Crawford summarized the condition of photographic art that "photography is a running battle between vision and technology. Genius is constantly frustrated — and tempered — by the machine."² With each new technological advance in equipment, new means of expression become available to the photographer; with each new vision, the search for a new technology which will enable it. The soft-focus lens enabled a significant departure from the aesthetics of traditional photography.

Prehistory

The history of diffusion in the photographic print medium exemplifies Crawford's thesis. The issue arises almost at the birth of the medium, cast in the form of an argument between supporters of the daguerreotype and supporters of the calotype. The exponents of the daguerreotype praised its nearly infinite resolution and 'truth to nature'; the exponents of the calotype believed its softness of definition and tonality were great assets. At the turn of the twentieth century, the daguerrian camp's arguments would become adopted by the 'straight' or 'purist' photographers and those of the calotype by the Pictorialists, amounting to a contest between topographic inventory versus expressiveness, an argument still raging in the digital age at the turn of the twenty-first century.

² William Crawford *The Keepers of Light* p. 6.

The invention of the wet collodion process in 1851 rapidly swept away both the calotype and the daguerreotype, replacing them with a high resolution wet plate negative printed on high resolution, high gloss, and long tonal range albumen paper. This process had the resolution of a daguerreotype and the exact replication syntax of the calotype and provided larger images than either. With the larger image and high resolution, the imperfections of the subject were immediately perceptible, a significant detriment to portrait trade. Retouching techniques begun on calotype negatives were transferred to the new glass plate negatives, refined and expanded; the syntax of photography had become too true to life which required an alteration of syntax in the form of retouching.

In this new era of ultra realistic depictions arose a call for diffusion, or the suppression of detail, to be injected into the photograph. The first clear statement was by Sir William J. Newton in 1853, suggesting “I do not consider it necessary that the whole of the subject should be what is called *in focus*; on the contrary, I have found many instances that the object is better obtained by the whole subject being a little *out of focus*, thereby giving greater breadth of effect, and consequently, more *suggestive* of the true character of nature.”³ At the Society’s next meeting, E. W. Dallas proposed making the world’s first soft-focus lens by constructing it with imperfect optical glass containing striae. Soon thereafter Lady Eastlake noted that detail is not necessary for an *artistic* photograph; two years later, renowned photographer Francis Frith went so far as to say “The fact is, that it is *too truthful*. It insists upon giving us ‘the truth, the whole truth, and nothing but the truth.’ Now, we want, in Art, the first and last of these conditions, but we

³ Sir William J. Newton, *Journal of the Photographic Society* 1, 1853, reprinted in *Photography: Essays and Images*, Beaumont Newhall, 1980, p. 79.

can dispense very well with the middle term.”⁴ There was amongst artistically inclined photographers a general dissatisfaction with the high level of detail that characterized photography.

Innovation

In 1863-64 lenses by two different inventors were shown or discussed before the Photographic Society of Scotland, one by G. Wharton Simpson and the other by J. Traill Taylor, which would reduce detail in the negative. There is little concrete information on Simpson’s lens, however, Taylor detailed his in a two-part article, a landscape lens which “gives a picture *generally sharp* all over the plate, but particularly sharp nowhere. In short, it has no real focus at all.”⁵ There seems to have been a cool reception to the idea. The beginning of a serious, engaged debate on soft-focus lenses was Antoine Claudet’s *BJP* paper in 1866 wherein his solution was changing the focus of the lens during exposure. Unlike suggestions from Dallas, Simpson and Taylor, this idea was very well received by those present; however a storm of controversy raged over whether the concept of moving the lens during exposure was an original idea of Claudet’s or had been used by Rejlander and others since the time of Newton’s speech, with the eventual consensus that it was not original to Claudet. An eminently more feasible solution was realized by the eminent lens designer John Dallmeyer, who invented the world’s first soft-focus lens, the *Patent Portrait* of 1866. The debates in London over methods of lens-

⁴ Francis Frith, “The Art of Photography”, *The Art Journal* 5 (1859), reprinted in Newhall *Photography: Essays and Images* (1980), p. 117

⁵ J. T. Taylor “Popular Notes on Photographic Lenses, Part II- Landscape Lenses” *BJP* April 15, 1864 p.135.

based diffusion coincided almost exactly with Julia Margaret Cameron's peak, yet the two never intersected. Cameron's use of diffusion was accidental and uncontrolled, and for the purpose of 'art'; her images were generally not well received at the time and with her withdrawal from photography, the issue of the diffused image essentially fell moribund for the next several decades.

Adoption

The changed syntax of photography in the form of dry plates in the 1880s allowed the blooming of the amateur movement by removing the chief impediments to its practice. Camera clubs became ubiquitous as did camera wielding amateurs. As the complexity and price of cameras fell, any middle class person could afford to participate in the trend. The amateur movement evolved very quickly into several major divisions: high amateurs, for whom photography was a very serious occupation, middle amateurs who committed far less time, money and effort to the medium and snap-shooters who were generally pleased with any image that resulted from their desultory excursions. To a great extent, the high amateur sought clearly visible manifestations which separated their images from the other amateurs and from the professionals as well.

By the mid-1890s, many high amateurs had adopted methods of diffusion which yielded prints radically different from other amateurs or indeed, professionals. In the darkroom, the syntax had shifted from the industry standard glossy monochrome albumen print to either the matt surfaced, extremely long tonal range platinum print or to the gum bichromate print which could be produced in virtually any color or palette of colors and could be either very diffuse or reasonably sharp, at the artist's will. Substitution of the

pinhole for the glass lens created uniformly diffused prints that came to the forefront of the new movement, Pictorialism. George Davison's iconic pinhole print, *The Onion Field* (also known as *The Old Farmstead*) served as a focus for the increasingly heated debate over diffusion and precipitated the formation of the Linked Ring, the first photographic association devoted to photography as art. Davison had become the manifestation of the artist-photographer and thus the philosophic leader of the movement, a situation causing grievous disquiet to Peter Henry Emerson, author of the widely read *Naturalistic Photography for Students of the Art* (1889). A heated series of exchanges between Davison and Emerson was printed in the photographic press that same year with Davison linking his aesthetic basis to the Impressionists and Emerson to the Naturalists. In both cases, the authors called for images not sharp across the entire image. Emerson promoted a complex set of rules which generally amounted to the center of the image being sharpest and a diminishment of resolution toward the edges of the frame whereas Davison argued for an even diffusion across the image. Emerson advocated using a specific new (1888) Dallmeyer lens, whereas Davison, although he primarily relied on the pinhole to achieve the desired effect noted "we are not concerned for the exclusive use of a pinhole, only for the effect obtained thereby. Let anything that will give it be used..."⁶ Davison also suggested that opticians should devise a soft-focus lens, this being the first call to create a soft-focus lens for *artistic* purposes; Emerson argued against what became the basic principle of all soft-focus lenses, spherical aberration, "throwing the principal object slightly out of focus, on some occasions, is to obtain a truer tonality. Spherical aberration of course affects the tone of the resulting image. It

⁶ G. D. (George Davison) "Pinhole Pictures" *Photography* April 4, 1889, p. 241.

lowers it throughout and indiscriminately, and is, therefore, inartistic.”⁷ Davison was more persuasive than Emerson and carried the field; except for the occasional tirade, Emerson withdrew from public view. This debate was framed differently than the mid-1860s interest in soft-focus lenses; the *fin-de siècle* question involved amateurs, not professionals, and sought to develop the artistic aspect of photography, not a simply a more saleable portrait.

The search for a practical soft-focus lens had begun and was first led by Prof. Hans Watzek, an art teacher in Vienna who was also a committed amateur photographer. In 1891 he showed his large portraits made with a simple planoconvex lens to the Vienna Camera Club and soon thereafter made “extraordinarily attractive”⁸ photographs by combining the pinhole and the plano-convex lens, the long exposures however being a serious detriment to widespread adoption. In between these two configurations, he also experimented with the simple meniscus lens which would see commercial production in two decades as the Struss *Pictorial* lens.

English lens maker Thomas Dallmeyer had invented the telephoto lens in 1891 which was quickly utilized by P. H. Emerson for portraits. Amateur photographer John S. Bergheim, who was working with the telephoto design, considered Dallmeyer’s design too sharp, and in 1894 approached the lens designer to inquire whether a lens with soft definition spread evenly across the plate might be created based on the telephoto design. The result was the *Dallmeyer-Bergheim* lens which first came on the marketplace in 1896, and must be considered the first production soft-focus lens intended for *artistic* photography. In 1900 F. Holland Day and Alvin Langdon Coburn were in England to

⁷ Emerson as 22, p. 53.

⁸ Heinrich Kühn, *Zur Photographischen Technik* p. 50.

bring Day's 'New School of American Photography' to London and visited with Evans. They must have been impressed with his *Dallmeyer-Bergheim* as they each returned to America with the lens. Upon their return to Boston in 1901, Coburn's lens was taken to a local optical firm, Pinkham & Smith to see if Smith might be able to design a lens which created a similar effect but more 'user friendly.' Henry Smith's resulting design was not original but based on modifications to well known designs, depending on spherical and chromatic aberration for the diffusion. Day's appraisal was that the Smith design, known as the *Semi-Achromatic*, "scored somewhat over the British Dahlmeyers [sic] in rapidity and ease of manipulation."⁹ Despite issues with quality control, the *Semi-Achromatic* was preferred by early Pictorialists by a wide margin over any other lens; it became the benchmark against which all other American lenses would be compared over the next two decades. The characteristics of the images produced by this lens became closely associated with the look of Pictorialism more generally. First generation Pictorialists now had a tool with which to express their aesthetic vision. They used soft-focus lenses to distill the image to its essential essence, creating a far more compelling final print than that which preceded them. The history of photography was changed forever.

Virtually all soft-focus lenses depend on spherical aberration and chromatic aberration, or spherical aberration alone, to produce the diffused image. John Dallmeyer had laid down that principle in designing his 1866 *Patent Portrait* lens and it still is valid in the twenty first century. The difficulty comes in the correct balance and degree of those aberrations and the control of other less desirable aberrations such as distortion, coma and astigmatism. When compared to a well corrected lens, these aberrations imbue

⁹ Letter to an unknown correspondent, dated 8 July 1921, F. Holland Day, in the collection of the Norwood Historical Society, Norwood, Mass.,

soft-focus lenses with certain unique properties: highlight radiance, apparent depth-of-field increase, details are reduced, diffusion is even across the useful field, out of focus areas are pleasingly rendered and possibly a high flare level.

As the fashion for soft-focus grew, the number of lenses and designs produced grew commensurately. Soft-focus lenses antedating World War II consisted of one of seven types: single element, combination, doublet, variable separation of elements, internal floating element, symmetrical, and perforated diaphragm, all of which performed differently and only direct experience would generate the limitations and strengths of each lens. Although there were many available lenses, very few enjoyed widespread appeal.

Focusing a soft-focus lens departs from the method applicable to sharp lenses in two ways: first, the lens must be re-focused at each aperture because of 'focus shift,' one of the characteristics of lenses possessing spherical aberration, and second, there is no one 'best' focus but a band of acceptable focus, with somewhat different effects resulting dependant on placement within that band. Focusing a soft-focus lens is quite unlike focusing an anastigmat and requires experience and judgment; it is likely that many amateurs abandoned soft-focus because their focusing habits were too inflexible and could not allow for the major departure from their established methods.

An important visual variable for many early Pictorialists was the rendering of the out-of-focus area behind the plane of best focus. Well-corrected lenses typically have a 'cutting' depth-of-field where the transition from *in* focus to *out* of focus is sudden and harsh. All soft-focus lenses, because of the enhanced apparent depth-of-field, had a smooth and gradual transformation from best focus to least focused. Although the early

Pictorialists were highly aware of this, they had no single word for it, using the term ‘wooly’ for an unfavorable assessment of the least focused regions; the Japanese who are also highly sensitive to this visual effect term it *bokeh*. There is no objective measure of *bokeh* and indeed many Western photographers deny the concept; even the Japanese disagree amongst themselves as to whether some types of *bokeh* are pleasing or not. Nonetheless, virtually any lens-formed image where the depth of field does not encompass the entire composition possesses *bokeh*; the f/64 school photographs have no *bokeh* because the photographers have deliberately stopped their lenses down to such small apertures as to bring the entire scene into focus, nor do pinhole images possess it since they manifest a perfectly even degree of focus. A mathematically perfect lens does not possess *bokeh* but for various reasons, even the best lens designs retain some aberrations and therefore produce images with *bokeh*. Most, if not all period soft-focus lenses demonstrate pleasing *bokeh*.¹⁰

The nature of the soft-focus image, a sharp core overlaid by a diffused halo demanded careful exposure and development if the delicacy of the effect was to be preserved. In a time before light meters, exposure was always a matter of experience and the narrow latitude for a soft-focus negative required excellent judgment of the lighting conditions, both intensity and contrast; too much or too little exposure would rob the image of the delicate tonal separations in the highlights. Likewise, development was crucial in maintaining enough detail in the highlights without them blending together, but the standard ‘development by inspection’ enabled the experienced darkroom technician to accurately develop the film. When panchromatic film eliminated development under a safelight, correct development became far more difficult. The average amateur turned to

¹⁰ Based on the author’s tests of more than thirty period designs of both common and rare soft-focus lenses.

‘time and temperature’ charts which although adequate for regular lenses were not accurate enough for soft-focus.

Whistler and Impressionist art had underlined the literal (and therefore non-artistic) nature of photography. Previous salon paintings and photography had been relatively similar in visual presentation in that everything was sharp and detailed. Following the cue from the new painting, Pictorialism moved the photograph from a document of the exterior to an exposition of the artist’s interior — like Impressionism the finest effects were in evoking the effect of sunlight in a manner never possible before.

Pictorialism realized its goal of the acceptance of photography as art partly because of soft-focus images; most photographers and at least some critics considered the use of soft-focus lenses as *not* mechanical because so many variables were involved that they could only be addressed by a human intellect, the psychological equivalent of handwork on the print. Only an artist could successfully utilize a soft-focus lens to create an artistic image. The look of Pictorialism was and remains closely identified with the soft-focus image and without the soft-focus lens, the movement might never have matured and survived to produce a definitive body of imagery that is so widely recognized today. Pictorialism, as it evolved, relied heavily on the soft-focus lens for many of its most important and striking prints, recalling however, that all soft-focus was encompassed within Pictorialism, but not all Pictorialism was soft-focus. The transition from literal photographs to suggestive and evocative images produced by soft-focus lenses was coterminous with beginnings of other two dimensional abstract art, and set the stage for Moholy-Nagy, Heartfield, Rodchenko and other photographers who followed in the Modernist movement.

Decline

Soft-focus lenses were never widely adopted and were largely wielded by a small coterie of innovators until post-World War I when a wider adoption by largely unskilled and differently motivated workers became one reason for the lens' decline and eventual disappearance from the photographic scene. Diffusion was not appropriate to all subjects or conditions, as known by the early Pictorialists, but the later amateurs, beginning circa the end of World War I, ignored or were ignorant of the guides developed by the earlier photographers and frequently applied the lens inappropriately, the more so the further they were removed from 1918. In Britain, a significant stagnation had set in even before the Great War and essentially froze pictorial photography for the next two decades.

World War I made photography difficult almost everywhere but especially the war ravaged Europe and Britain. There were shortages of all essential materials, the military requisitioned civilian lenses, severe restrictions were placed on taking photographs, platinum paper was unavailable, no new cameras were available, etc. Major problems followed the war including continue shortages of equipment and chemicals.

A photographer from 1850 would have understood and been able to operate most cameras of 1900. However, a revolution in camera design began shortly thereafter with radically new cameras constantly evolving in rapid succession. The hand-held large format Graflex debuted in 1900 and established a new mind-set that a tripod was no longer a necessary object in the art photographer's equipment. This new mind set prepared the way for the revolutionary changes that swept amateur photography during

which camera sizes steadily decreased in size and their negatives commensurately. The 35mm Leica was the evolutionary climax of this miniaturization; whilst small and mobile, these cameras were no longer suitable for soft-focus lenses; diffused images were either produced by slip-on lens attachments or in the darkroom, neither method was aesthetically equivalent to the use of a soft-focus lens. With the new small, highly mobile cameras, the snap-shooter aesthetic emerged and by the 1960s post-modernism elevated it to art status. What little remained of the diffused aesthetic was now thoroughly decadent.

The state of mechanical printing prevented an accurate replication of the original image when published in the flourishing photographic press. Among the *cognoscenti* this failure was clearly recognized but even the recognition did not provide for an accurate transmission of the original syntax. The rank and file amateur was probably unaware that the printed page had little resemblance to the original print and copied what appeared to be the best exemplar of well-received photographs, creating a grossly inferior image. Further adding to the downward spiral, it is likely that many club and salon judges were probably informed by that same misleading published material as the standard for critique, hence rewarding prints which resembled the published image rather than the original source photograph, thus becoming a self-perpetuating system.

Renaissance

During the last two decades of the twentieth century three Japanese manufacturers marketed sophisticated soft-focus lenses for their medium format cameras.¹¹ For large format cameras, Yamasaki Optical Co., Ltd., produced two lenses, Fujinon marketed

¹¹ Fujinon (190mm f/8), Mamiya (150mm f/4, 180mm f/4) and Pentax (120mm f/3.5). Fujinon and Mamiya soft-focus lenses use a perforated diaphragm much like the *Imagon* and are as complicated and slow to use as it. Additionally, Rodenstock produced a model of the *Imagon* designed for the Hassleblad camera.

three focal lengths and Cooke Optics, Ltd. (Leicester) marketed the large format Cooke *PS945* soft-focus lens modeled closely after the Pinkham & Smith *Visual Quality* lens of the 1920s (retail price, 2006, \$3,500). Camera makers Canon, Minolta, Pentax, and independent lens makers Sima and Tamron all marketed soft-focus lenses for 35mm cameras. For the first time, high quality soft-focus lenses were available in all normal camera formats. Most recently, a new 35 mm lens came on the market in 2005 and has been highly successful, the *Lensbaby 2.0*© a coated doublet using Waterhouse stops mounted in a flexible barrel designed for 35mm cameras and digital SLR cameras.¹² One objective measure of the return of the diffused aesthetic is how prices have soared on eBay® in the last several years for period soft-focus lenses, more than doubling in the last three or four years. Positioned at the beginning of the twenty-first century, photographers have more models of soft-focus lenses available than at any time in history although only a few are in current production.

Nor did the digital revolution omit diffusion; the world-wide standard program for digital manipulation of photographs, PhotoShop©, recognized the demand for a digital utility to create pseudo-soft-focus via the *soften* menu which has been a part of the program since at least version 2.0. It is simplistic, effectively like a resolution reducing ‘fog’ or ‘diffusion’ filter mounted on a camera and but vaguely approximates a soft-focus lens. However, in a population which has only the vaguest acquaintance with original photographs by the masters of soft-focus, most modern photographers and their audiences have been satisfied with this inferior mode of diffusion.

¹² The *Lensbaby 1.0*© was a single uncoated glass element which produced an very soft image due to the extensive aberrations in such a lens. Like the Pinkham & Smith *Semi-Achromatic* it’s pronounced character was accompanied by severe limitations of lighting, contrast and subject.

A revival of pinhole photography began in the late 1970s and continues unabated, fed by the thrice-a-year *Pinhole Journal*.¹³ Pinholes are the simplest and least expensive entry to the aesthetic of the diffused photograph and are used by thousands of photographers world-wide. There are now a score or more commercially manufactured pinhole cameras, made from Hong Kong to Luxembourg; the *Tortuga 5* pinhole camera retails for £879, giving some indication of the seriousness of some pinhole photographers. Worldwide Pinhole Photography Day had nearly 2,300 participants in 2006¹⁴ and the organizers anticipate a 10-15% increase in 2007.¹⁵ Contemporary art photographers have found pinhole's unique visual syntax captivating; Bill Wittliff¹⁶ and Adam Fuss¹⁷ have both had successful books of their pinhole photographs. Some have gone even further into the aesthetic by devising their own soft-focus lenses such as Keith Carter who uses a specially made low quality lens with an extremely shallow depth of field on his Hassleblad.¹⁸ Robert Stivers has pushed the diffused image to the limit with his lens-based images made totally out of focus.¹⁹

During the past decade there has been a rapid growth in the 'crappy camera' aesthetic, utilizing cheap toy cameras with plastic bodies and plastic lenses such as the venerable *Diana* and the current production *Holga*. These crudely constructed cameras create images rich with aberrations and vignetting through the agency of inherently defective plastic lenses. These lenses are essentially a 'poor man's' soft-focus lens for

¹³ The journal published 66 issues between 1985 and 2006, when it ceased publication.

¹⁴ www.pinholeday.org

¹⁵ for a more detailed essay on the popularity of pinhole photography, see Russ Young "Historical Pinhole" *Studies in Photography 2005* (Glasgow: The Scottish Society for the History of Photography, 2005) pp. 42-47.

¹⁶ Bill Wittliff, *La Vida Brinca: A Book of Tragaluz Photographs* (Austin: University of Texas Press, 2006)

¹⁷ Adam Fuss *Pinhole Photographs* (Washington, DC: Smithsonian Institution Press, 1996)

¹⁸ Keith Carter *Holding Venus* (Santa Fe: Arena Editions, 2000). Carter's custom lens functions much like the Lensbaby© except in medium format rather than 35mm.

¹⁹ Robert Stivers *Robert Stivers: Photographs* (Santa Fe: Arena Editions, 1997).

those who cannot afford or do not wish to master true soft-focus but are desirous of a device with fewer operational limitations than the pinhole. *Diana* cameras which sold new for \$3.50 thirty years ago regularly realize prices in the \$75 range on eBay and have become true cult classics.

Just as the f/64 school and the modernists revolted against pictorialism, many creative modern photographers have found it necessary to sever ties with the severe aesthetic constraints of those seventy-year old outdated movements and have, with a new vision and utilizing both vintage lenses and new technologies, returned to the diffused image, through the traditional agency of soft-focus lenses and contemporary digital methods, to reveal their artistic philosophies. In respect of these changes detailed in this thesis, it is clear that Coburn's emphasis on the 'importance of diffusion' to artistic photography continues to resonate a century later.

Appendix A: Soft Focus Innovation Time Line

(entries marked * are from *A History of the Photographic Lens*, Kingslake, 1989)

1812 William Hyde Wollaston suggests the use of **meniscus** lenses for the camera obscura * p. 307

1839 first **commercial photographic objectives** manufactured by Charles Chevalier.¹

1851 Frederick Scott Archer publishes the details of the **wet-plate** or **collodion negative** process in *The Chemist*.

1858 John Waterhouse introduces the **Waterhouse stop** to vary lens aperture* p. 10.

1866 **Rapid Rectilinear** lens introduced by John Dallmeyer. Used by photographers for over 50 years, it was a benchmark design. Still manufactured in 1930. * p.7, 59

1866 John Dallmeyer patents the world's first soft focus lens, the **Dallmeyer Patent Portrait**, British Patent #1641/1866.

1871 Dr. Richard Leach Maddox publishes the method for practical **dry-plate negatives** in the *BJP*; he never patents it.

1873 William Willis patents (GB #2011) what will become the **Platinotype**. Commercial production begins in 1880 with his company, The Platinotype Company

1879 Sir Joseph Swan patents (GB #2986) and begins mass production of **silver bromide printing paper** which can be exposed by artificial light; enlargements become practical.

1882 Capt. Giuseppe Pizzighelli and Arthur, Baron von Hübl, perfect individual preparation methods for the **platinotype** of Willis.

1884 Dr. Otto Schott begins studies at Jena which will result in the establishment of the famous glass works there and the introduction of the first new types of optical glass since the late 1700s. These **new glasses** allow the design of the first anastigmatic lens in 1890.²

1890 Hans Watzek adapts the **spectacle lens**, for far sighted eyes, to photography, the first development in soft focus lenses since 1866.³

1890 George Davison exhibits his **pinhole image**, "The Old Farmstead," and unleashes a pent up penchant for diffuse images in the photographic world.

¹ *Photographic Lenses*, C. B. Neblette and Allen E. Murray (Dobbs Ferry, NY: Morgan & Morgan, revised edition, 1973), p. 72.

² *Photographic Lenses*, C. B. Neblette and Allen E. Murray (Dobbs Ferry, NY: Morgan & Morgan, revised edition, 1973), p. 63.

³ *Das Imagon Buch*, quoting Dr. Kuhn, p. 21.

1891 T. R. Dallmeyer applies for a British patent on his new telephoto lens design (*, p. 133). With some modification, this becomes the **Dallmeyer-Bergheim** soft focus lens.

1893 **Dallmeyer-Bergheim lens** first manufactured *, p. 136

1893 H. Dennis Taylor patents (GB 22,607/1893, 15107/1895) the three element Cooke Triplet lens (*, p. 103), one of the benchmark designs. With some modifications it later becomes the **Cooke Soft Focus lens**.

1894 Sépia-Photo et Saguine-Photo, the first book detailing **gum-bichromate printing** published in Paris. Authored by Rouillé-Ladevéze, the method was quickly elaborated on and modified by Demachy and Maskell who publish their tome in 1898.

1896 H. Dennis Taylor “noted that a tarnished lens transmits more light than a freshly polished one, thus laying the foundation for **antireflection coating**.” It was not realized in production until the 1930s.* p. 295

1901 Henry S. Smith of Pinkham & Smith, Boston, devises the first American soft focus lens, the **Semi-Achromatic**. Used by more important Pictorialists than any other single lens.

1902 Paul Rudolph designs the **Tessar** (German pat. #142,294, U.S. pat. #721,240), “this was the best corrected lens in the world for its aperture when it was introduced and was an immediate success.”⁴ A benchmark design of lens history.

1905 Puyo & Pulligny introduce the **Objectif d’Artiste Formule Anachromatique**⁵ an adjustable lens operating on similar principles to the Dallmeyer-Bergheim. There were at least four variations.⁶

1906 R. & J. Beck introduce the **Isostigmatar** (*, p. 120), a variation of which becomes their soft focus lens. Date confirmed by Neblette. A complex lens for the time composed of five elements in five groups.

1907 Gundlach-Manhattan introduced the **Achromatic Meniscus** “for amateurs.”⁷

1909 Dallmeyer patents further improvements on the 1866 **Patent Portrait** design.⁸

1910 **Bodine Pictorial Lens** introduced⁹

⁴ *Photographic Lenses*, C. B. Neblette and Allen E. Murray (Dobbs Ferry, NY: Morgan & Morgan, revised edition, 1973) p. 66.

⁵ Robert Demachy *Photograms of the Year, 1905* (London: Dawburn & Ward, Ltd, 1905) p. 10.

⁶ Vade Mecum entry for “Pulligny et Puyo” see also L. de Pulligny and C. Puyo *Ojectifs d’Artiste* new edition (Paris: Paul Montel, 1924)

⁷ *The Photo-Miniature* “The Choice and Use of Photographic Lenses” Vol. VII No. 79 March 1907 p. 340.

⁸ Engraved on the lens barrels of post-1909 Patent Portrait lenses.

⁹ *American Annual of Photography, 1911* (New York: American Annual of Photography, 1910) p. XLI

1911 **Verito** introduced¹⁰ (essentially the **Bodine** lens under another name), probably the most common soft focus lens encountered today (2007).

1911 Spencer **Port-Land** introduced¹¹

1911 Christopher Graf designs the Graf **Variable**.¹² (this date is perhaps a typographical error for '1921' as Graf did not file for a patent until 1922)¹³

1913 Goerz **Portrait Hypar** introduced¹⁴

1915 Struss **Pictorial** lens brought on to the market (he had been privately selling them "for some years")¹⁵

1917 **Enlarging Verito** available with novel shaped Waterhouse stops¹⁶

1917 Platinotype Company introduces **Palladiotype** paper¹⁷

1920 Pinkham & Smith introduces the **Synthetic** lens¹⁸

1920 Revised **Verito** with a faster aperture¹⁹

1921 Busch Nicola **Perscheid lens** first manufactured^{20*} p.59

1921 Gundlach-Manhattan Optical Company introduce the **Equal Diffusion Portrait Lens**²¹

1921 Graf Optical Company debuts the **Graf-Bishop** lens²²

1921 Pinkham & Smith announce the **Wolfe Artistic**, the first diffusion filter for use with an anastigmat.²³ Eastman Kodak quickly follows suit with their **Portrait Diffusion Disk**.

1921 The English manufacturer of Marion & Co. introduce the **Kershaw Soft-focus Lens**

1921 (circa) Bausch & Lomb markets the **Plastigmat Portrait Lens**²⁴

¹⁰ Dept. of Photography, *The Eighth American Photographic Salon* (Brooklyn: Brooklyn Institute of Arts and Sciences, 1911) unpaginated advertisement.

¹¹ "The Spencer Soft-Focus Lens" *Photo-Era* Vol. XXVI, No. 5 (May, 1911) p. 267

¹² C. B. Neblette 1st ed. *Photography its Principles and Practice* (New York: Van Nostrand Co., 1927) p. 124.

¹³ U. S. Patent #1,463,132, issued July 24, 1923, to Christopher Graf.

¹⁴ Goerz Catalog (Goerz: New York, 1913) p. 31

¹⁵ Karl Struss "Pictured with the Struss Pictorial Lens" *The New Pictorialist* Vol. 10. No. 1, Spring, 1918, p. 1.

¹⁶ Editor *Photo Era* April 1917, Vol. XXXVIII No. 4 p. 207.

¹⁷ Anne Hammond ed. *Frederick H. Evans Selected Texts and Bibliography* (Oxford: Clio Press, 1992) p. xvi.

¹⁸ Pinkham & Smith catalog (Boston: Pinkham & Smith, 1920) "Foreword" unpaginated.

¹⁹ John Tennant "Soft Focus Effects in Photography" *The Photo Miniature* Vol. XVI No. 184 December 1921 p. 158.

²⁰ Confirmed by *Das Imagon Buch*, p. 28, which notes it was patented in 1920.

²¹ John Tennant "Soft Focus Effects in Photography" *The Photo Miniature* Vol. XVI No. 184 December 1921 p. 201.

²² John Tennant "Soft Focus Effects in Photography" *The Photo Miniature* Vol. XVI No. 184 December 1921 p. 202.

²³ John Tennant "Soft Focus Effects in Photography" *The Photo Miniature* Vol. XVI No. 184 December 1921 advertisement section.

1923 Dallmeyer's **Soft Focus f/4.5**²⁵

1923 **Hyperion**²⁶

1924 Cooke "**Knuckle Duster**"²⁷

1925 **Mutac**²⁸

1925 Dallmeyer brings the **Banfield Portrait Lens** on the market, with focal lengths of 18 inches and longer, it is clearly intended for top-end professional use.²⁹ Named after London photographer A. C Banfield.

1928 "**Kuhn's Anachromat**" manufactured in Munich.³⁰ This is the immediate ancestor to the Imagon and the first lens to use a multiply perforated diaphragm; Knapp says it was "developed" in 1923 but was it marketed?³¹

1929 **Beach Multifocal** introduced³² (although Howard Beach did not apply for a patent until 1935).³³

1931 The **Imagon** by Kuhn & Staebble marketed by Rodenstock. It stays on the market until ca. 2000; along with the Rapid Rectilinear, Cooke Triplet and Tessar, one of the longest commercial production periods of any lens.³⁴

1932 **f/64 Exhibition** in California. Marks the beginnings of a militant campaign against soft-focus images by the very men (Weston, Adams, Edwards) who were achieved recognition and prominence by using them.

1935 First 35 mm format soft focus lens, the Leitz **Thambar**, is introduced.³⁵

1935 J. Strong puts Taylor's idea of lens coatings to practical application.³⁶ Since the end of World War II, virtually all photographic lenses have been coated.

²⁴ John Tennant "Soft Focus Effects in Photography" *The Photo Miniature* Vol. XVI No. 184 December 1921 advertisement section

²⁵ *The Camera* April, 1923, unpaginated advertising section

²⁶ *The Photographic Journal* ****, 1923, p. vi

²⁷ *The Photographic Journal*, Nov. 1924, p. XX. Specifically for portraits.

²⁸ *The Photo-Miniature*, 1925, p. 273

²⁹ Frank R. Fraperie 4th ed. *How to Choose and Use a Lens* (Boston: American Photographic Publishing Co., 1925) advertisement section at rear.

³⁰ *Das Imagon Buch*, p. 44.

³¹ Ulrich Knapp *Heinrich Kühn Photographien* (Salzburg: Residenz Verlag, 1988) "Biographie"

³² Anthony Bannon "Howard Beach" *The Photo-Pictorialists of Buffalo* (Buffalo: Media Study, 1984) biographical section at rear, unpaginated. Kingslake in *A History of the Photographic Lens* gives the date as 1928 (p. 187).

³³ U. S. Patent #2,101, 016 applied for August 8, 1935, and granted December 7, 1937.

³⁴ Knapp *Heinrich Kühn Photographien* "Biographie"

³⁵ *Das Imagon Buch*, p. 35.

³⁶ *L.P. Clerc's Photography: Theory and Practice* revised by L. A. Mannheim, D. A. Spencer ed. (London: Focal Press, 1970) p. 83.

1946 earliest known 12 inch **Kodak Portrait** lens.³⁷

1950 **Veritar**, a redesigned, coated version of the Verito marketed.³⁸

1966 latest known 12 inch **Kodak Portrait** lens.

1980s Mamiya produces an Imagon-type lens for their various 645 and 67 models.

Fuji produces 180, 250 and 420mm view camera lenses based on the Imagon principles. Minolta sells the finest 35 mm format soft focus lens yet made. Canon introduces a 35 mm format soft focus lens, as do Pentax, Sima and Tamron; the Pentax lens demonstrates a profound lack of understanding of soft focus.

³⁷ Based on a study by the author of serial numbers on approximately 50 lenses.

³⁸ *Wollensak Portrait Veritar*, (Rochester: Wollensak, 1950), p. 2.

Appendix B: Photographers by Year of Birth

* indicates the source is Pam Roberts *Camera Work* (Koln: Benedikt Taschen, 1997)

1798 Antoine François Jean Claudet³⁹
1802 David Octavius. Hill*
1815 Julia Margaret Cameron*
1817 Oscar G. Rejlander⁴⁰
1830 John H. Dallmeyer⁴¹
1830 Henry Peach Robinson⁴²
1844 John Simeon Bergheim (1881 English census)
1848 Hans Watzek*
1848 Rudolf Dührkoop⁴³

-----1850s-----

1852 Gertrude Stanton Käsebier⁴⁴
1853 Frederick H. Evans*
1853 Frank Meadow Sutcliffe⁴⁵
1854 George Davison*
1856 Peter Henry Emerson⁴⁶
1856 George Bernard Shaw⁴⁷
1857 W. B. Post⁴⁸
1857 Capt. Emile Joachim Constant Puyo⁴⁹
1857 Alfred Maskell⁵⁰
1857 Arthur Wesley Dow⁵¹
1859 Leon Robert Demachy*
1859 Thomas R. Dallmeyer⁵²

-----1860s-----

³⁹ Turner Browne and Elaine Partnow *Macmillan Encyclopedia of Photographic Artists and Innovators*, (NY: Macmillan Publishing Co., 1983), p.112.

⁴⁰ Browne & Partnow, 504.

⁴¹ Rudolph Kingslake *A History of the Photographic Lens*, (San Diego: Academic Press, 1989), p. 221.

⁴² Browne & Partnow, p. 515.

⁴³ Margaret F. Harker *The Linked Ring*, (Heinemann: London, 1979), p. 156.

⁴⁴ *The Linked Ring* p. 159.

⁴⁵ Michael J. Shaw *Every Now & Then* (Whitby: The Sutcliffe Gallery, 2002), "Introduction"

⁴⁶ Browne and Partnow , p. 176.

⁴⁷ *The Collection of Alfred Stieglitz* p. 434.

⁴⁸ Christian B. Peterson *The Quiet Landscapes of William B. Post* (Minneapolis: The Minneapolis Institute of Arts, 2005) p. 9.

⁴⁹ Sobiezek *Masterpieces of Photography at the George Eastman House Collections* p. 208

⁵⁰ *The Linked Ring* p. 156.

⁵¹ Nancy E. Green and Jessie Poesch *Arthur Wesley Dow and American Arts & Crafts* (New York: American Federation of Arts, 1999) p. 171.

⁵² Kingslake , p. 223.

1862 Rudolf Eickemeyer⁵³
 1863 A. Horsley Hinton*
 1863 Hugo Henneberg⁵⁴
 1864 Fred H. Day⁵⁵
 1864 James Craig Annan*
 1864 Alfred Stieglitz*
 1864 Nicola Perscheid⁵⁶
 1865 Frank Eugene*
 1866 Will H. Cadby*
 1866 Carl Christian Heinrich Kühn*
 1867 Eva Watson-Schütze
 1867 Sadakichi Hartmann (Sidney Allen)⁵⁷
 1867 Henry Smith⁵⁸
 1868 Theodor Hofmeister⁵⁹ (other sources state 1865)
 1868 De Meyer, Baron Adolf*
 1868 Theodor Hofmeister*
 1868 John Dudley Johnston⁶⁰
 1869 Anne Wardrope Brigman⁶¹
 1869 Arnold Genthe⁶²
 1869 Oskar Hofmeister⁶³ (see conflict in 1871 which is probably more accurate)
 1869 Henri Matisse*
 1869 Josph T. Keiley*

-----1870s-----

1870 Auguste Rodin*
 1870 Leonard Missone⁶⁴
 1870 Drahomir Joseph Ruzicka⁶⁵
 1871 Oskar Hofmeister⁶⁶
 1871 Clarence Hudson White*
 1872 Sigismund Blumann⁶⁷

⁵³ *The Collection of Alfred Stieglitz*, p. 342.

⁵⁴ *The Linked Ring* p. 162.

⁵⁵ *The Linked Ring* p. 150.

⁵⁶ Fritz Kempe *Dokumente der Photographie 1: Perscheid, Benda, Madame d'Ora* (Hamburg: Museum für Kunst und Gewerbe, 1980) p. 16.

⁵⁷ Browne and Partnow, p. 263.

⁵⁸ "Events of the Month- Henry S. Smith" *Photo-Era* August 1917, XXXIX, No. 2, p. 101.

⁵⁹ Karl Steinorth *Wanderungen Durch Deutschland, Die Gebruder Hofmeister* (Frankfurt: Deutsche Fotoage GmbH, 1993) p. 13.

⁶⁰ Bertram Cox *Pictorial Photography of J. Dudley Johnston* (London: The Pictorial Group of the Royal Photographic Society, 1952) unpaginated.

⁶¹ Drew Heath ed. *Capturing Light: Masterpieces of California Photography, 1850 to the Present* (New York: W. W. Norton & Company, 2001) p. 321.

⁶² *The Collection of Alfred Stieglitz*, p. 365.

⁶³ *The Collection of Alfred Stieglitz* p. 385

⁶⁴ Mariam Schwabik and Maurice Misonne *Léonard Misonne, Ein Fotograf aus Belgien 1870-1943* (Seebruck: I M Heering, 1976) unpaginated

⁶⁵ Christian Peterson *The Modern Pictorialism of D.J. Ruzicka* (Minneapolis: The Minneapolis Institute of Arts, 1990) p. 9.

⁶⁶ *Wanderungen Durch Deutschland, Die Gebruder Hofmeister*, p. 13.

1874 Francis J. Mortimer⁶⁸
1874 Malcolm Arbuthnot⁶⁹
1879 Edward {Eduard}Jean Steichen*
1879 William Edward Dasonville⁷⁰

-----1880s-----

1880 George Seeley*
1880 Paul Lewis Anderson⁷¹
1880 Paul Burty Haviland
1880 Max Thorek⁷²
1881 Pablo Picasso*
1882 Alvin Langdon Coburn*
1882 Forman Hanna⁷³
1883 Imogen Cunningham⁷⁴
1883 John Paul Edwards⁷⁵
1884 Johan Hagemeyer⁷⁶
1885 Margrethe Mather⁷⁷
1886 Clara E. Sipprell⁷⁸
1886 Karl Struss*
1886 Edward Henry Weston

-----1890s-----

1890 Paul Strand*
1891 Laura Gilpin⁷⁹
1897 William Mortenson⁸⁰

-----1900s-----

1902 Ansel Easton Adams
1906 Willard Van Dyke⁸¹
1908 Beaumont Newhall⁸²
1911 Brett Weston⁸³

⁶⁷ *Capturing Light: Masterpieces of California Photography, 1850 to the Present* p. 319.

⁶⁸ *The Linked Ring* p. 158.

⁶⁹ *The Collection of Alfred Stieglitz*, p. 271.

⁷⁰ *Capturing Light: Masterpieces of California Photography, 1850 to the Present* p.325.

⁷¹ Browne and Partnow .p. 15.

⁷² Christian A. Peterson *After the Photo-Secession* p. 205.

⁷³ Mark Sawyer *Forman Hanna, Pictorial Photographer of the Southwest*

⁷⁴ Browne & Partnow, p. 129.

⁷⁵ Jean Tucker *group f.64* p. 20

⁷⁶ *Johan Hagemeyer*, The Archive, University of Arizona, June 1982

⁷⁷ *Capturing Light: Masterpieces of California Photography, 1850 to the Present* p. 340.

⁷⁸ Christian A. Peterson *After the Photo-Secession* p. 204.

⁷⁹ Browne & Partnow, p. 231.

⁸⁰ Terence Pitts and others *William Mortensen, a Revival* (Tucson: Center for Creative Photography, 1998) p. 7.

⁸¹ *Capturing Light: Masterpieces of California Photography, 1850 to the Present* p. 353.

⁸² Beaumont Newhall *Focus, Memoirs of a Life in Photography* (Boston: Bullfinch Press, 1993)

⁸³ *Capturing Light: Masterpieces of California Photography, 1850 to the Present* p. 358.

Appendix C: Photographers and Their Lenses

Abbot, C. Yarnall	Semi-Achromatic
Adams, Ansel Easton	Spencer Port-Land
Anderson, Paul Lewis	Struss Pictorial
	Smith Visual Quality
	Semi-achromatic
	Verito
Beach, Howard	Verito
	Beach Multi-Focal inventor
Bergheim, J. S.	Dallmeyer-Bergheim
Bluman, Sigismund	Verito
Bodine, Oliver	Verito inventor
Bravo, Manuel Alvarez	Verito
Bruguierre, F. J.	Semi-Achromatic
Coburn, Alvin Langdon	Semi-Achromatic
	Pinkham & Smith 'bespoke'
	Patent Portrait
	Pinhole
Cunningham, Imogen	Semi-Achromatic
Day, Fred Holland	Semi-Achromatic
	Dallmeyer Patent Portrait
	Dallmeyer-Bergheim
De Meyer, Baron Adolf	Pinkham & Smith model uncertain
Dührkoop, Rudolph	Vitax
Edwards, John Paul	Verito
	Struss
Evans, Frederick	Dallmeyer Bergheim
Garo, John	Verito
	Port-Land
Gilpin, Laura	Semi-Achromatic
	Struss
	Pinhole
Hammond, Arthur	Port-Land
	Semi-Achromatic
Hanna, Forman	Semi-Achromatic
Hoppé, E. O.	Dallmeyer Patent Portrait
Kasebier, Gertrude	Rapid View & Portrait
	Semi-Achromatic
Kühn, Karl Christian Heinrich	Imagon co-inventor
	Semi-Achromatic
Mortimer, F. J.	Dallmeyer Patent Portrait
Outerbridge, Paul	Graf Variable,

Porterfield, W. H.
Puyo, Constant
Ruzika, Dr. D. J.

Seeley, George H.

Sipprell, Clara

Steichen, Edward J.

Stieglitz, Alfred

Strand, Paul

Struss, Karl

Thorek, Max

Van Dyke, Willard

Watzek, Hans

Weston, Edward Henry

White, Clarence H.

Port-Land

inventor, Objectif Artistique

Verito

Semi-Achromatic

Port-Land

Struss

Semi-Achromatic

Watkins Pinhole

Vitax

Semi-Achromatic and others

Rapid View & Portrait

Semi-Achromatic

Struss Pictorial inventor

Verito

Struss

long focal length plano-convex

Verito, enlarging Verito

Graf Variable

Rapid View & Portrait

Semi-Achromatic

Pinhole

Kühn noted the Eidoscope was the most common soft focus lens in Germany

This list does not comprise all major Pictorialists nor is it exhaustive in listing every soft focus lens they may have used.

Bibliography

Primary Sources

Manuscripts

Austin, Harry Ranson Humanities Research Center, The University of Texas
Correspondence from Alvin Langdon Coburn to Helmut Gernsheim

Norwood (Massachusetts) Historical Society

Draft letter from F. Holland Day to unknown recipient.

Santa Fe, W. R. Young Collection

Letter from F. H. D. (F. Holland Day) to Bro. Evans (Frederick Evans.)

John Sexton, letter to the author, July 5, 2002.

Interviews

Andrachi, Jim, co-owner Midwest Photographic Exchange, Columbus, Ohio

Telephone interview, January 23, 2007.

Lewis, Charles, perhaps the last living student of Heinrich Kühn, Yoxford, Suffolk

Two day taped interview, March 16-17, 2002, and 38 letters dated November 18, 2001-February 6, 2003.

Newman, Fred, proprietor, The View Camera Store, Scottsdale, Arizona

Telephone interview, January 24, 2007.

Secondary Sources

Books

Pre-1940

Abney, Sir W. de W., *Instruction in Photography*, 11th ed. (London: Illiffe and Sons Ltd., 1905).

Anderson, A. J., *The Artistic Side of Photography* (New York: Dodd, Mead & Company, 1911).

Anderson, Paul L., *Pictorial Photography, its principles and practice* (Philadelphia: J. B. Lippincott & Company, 1917).

——, “Special Printing Processes” in Keith Henney and Beverly Dudley, eds., *Handbook of Photography* (New York: Whittlesey House, 1939).

——, *The Technique of Pictorial Photography* (Philadelphia: J. B. Lippincott Company, 1939).

Bate, Francis, *The Naturalistic School of Painting* 2nd ed. (London: The Artist, 1887).

- Beck, Conrad and Herbert Andrews, *Photographic Lenses, a Simple Treatise* 7th ed. (London: R. & J. Beck, Ltd, 1912).
- California the Beautiful* (San Francisco, Paul Elder & Company, 1911).
- Clerc, L. P., *Photography: Theory and Practice* George Brown, ed., 2nd ed., (New York: Pittman Publishing Co., 1937).
- Dallmeyer, Thomas R., *Telephotography* (London: William Heinemann, 1899).
- Emerson, P. H., *Naturalistic Photography for Students of the Art* (New York: E. & F. Spon, 1889).
- , *Pictures of East Anglian Life* Portfolio, May 1890
- Encyclopaedia Britannica* 11th ed., s.v. “pictorial photography.”
- Encyclopaedia Britannica* 14th ed., s.v. “pictorial photography.”
- Encyclopaedia Britannica* 14th ed., s.v. “photography- pictorial photography.”
- Fraperie, Frank R., *How to Choose and Use a Lens* 4th ed., (Boston: American Photographic Publishing Co., 1925)
- Gillies, John Wallace, *Principles of Pictorial Photography* (New York: Falk Publishing Co., 1923).
- Hasluck, Paul N., *The Book of Photography* (London: Cassell and Co. Ltd., 1905).
- Hinton, A. Horsley, *Practical Pictorial Photography* (London: Hazell, Watson & Viney, Ltd. 1910).
- Kingslake, Rudolph, “The Development of the Photographic Objective” *Handbook of Photography* eds Keith Henney and Beverly Dudley (New York: Whittlesey House, 1939).
- Kühn, Heinrich, *Technik der Lichtbildnerei* trans. Charles Lewis (Halle Saale: Wilhelm Knapp, 1921).
- , *Zur Photographischen Technik* trans. Charles Lewis, (Halle Saale: Wilhelm Knapp, 1926).
- Maskell, Alfred and Robert Demachy, *Photo-Aquatint or the Gum-Bichromate Process* (London: Hazell, Watson & Viney, 1890).
- Mortensen, William *Projection Control* 2nd ed. (San Francisco: Camera Craft Publishing Company, 1934).
- , *Print Finishing* (San Francisco: Camera Craft Publishing Company, 1938).
- Neblette, C. B., *Photography its Principles and Practice* 1st ed., (New York: Van Nostrand Co., 1927).
- , *Photography, Its Principles and Practice*, 3rd ed. (New York: D. Van Nostrand Company, 1938).
- Newhall, Beaumont, *Photography 1839-1937* (New York: Museum of Modern Art, 1937).
- The Old Spanish Missions of California* (San Francisco, Paul Elder and Company, 1913).
- de Pulligny, L. and C. Puyo, *Ojectifs d’Artiste* New Edition, (Paris: Paul Montel, 1924).
- Woodbury, Walter E, ed., *The Encyclopaedic Dictionary of Photography* (New York: The Scovill & Adams Company of New York, 1898).

Books

Post-1940

- Abel, Charles, *Professional Portrait Lightings* (New York: Greenberg Publisher, 4th printing 1951).
- Adams, Ansel, *The Print, Contact Printing and Enlarging* (Boston: New York Graphic Society, 1950).
- , *Camera and Lens* (Boston: Little, Brown and Company, 1970).
- , *The Negative* (Boston: Little, Brown and Company, 1981).
- , *Examples: the Making of Forty Photographs* (Boston: Little, Brown and Co., 1983).
- , *Ansel Adams, an Autobiography* (Boston: Little, Brown and Company, 1985).
- Alinder, Mary Street and Andrea Gray Stillman, eds., *Ansel Adams, Letters and Images*. (Boston: Little, Brown and Co., 1988).
- Arentz, Dick, *Platinum & Palladium Printing* (Boston: Focal Press, 2000).
- Brewster, Sir David, *The Stereoscope, Its History, Theory, and Construction* reprint of the 1856 edition, (Hastings-on-Hudson, NY: Morgan & Morgan, Inc., 1971).
- Buchanan, William, “The Art of the Photographer: J. Craig Annan” *Photography 1900: The Edinburgh Symposium* Lawson, Julie, Ray McKenzie, and A. D. Morrison-Low, eds., (Edinburgh: National Museums of Scotland, 1992).
- Bunnell, Peter, ed., *Edward Weston on Photography* (Salt Lake City: Peregrine Books, 1983).
- , “Towards New Photography: Renewals of Pictorialism” Michel Frizot, ed., *A New History of Photography* (Köln: Konemann, 1998).
- , *A Photographic Vision, Pictorial Photography, 1889-1923* (Salt Lake City: Peregrine Smith, Inc., 1980).
- Coe, Brian, “George Davison: Impressionist-Anarchist” *British Photography in the Nineteenth Century*, Mike Weaver, ed., (Cambridge: Cambridge University Press, 1989).
- Coleman, A. D., *Depth of Field* (Albuquerque: University of New Mexico Press, 1998).
- Crawford, William, *Keepers of Light* (Dobbs Ferry, NY: Morgan & Morgan, 1979).
- Curtis, Verna Posever and Jane Van Nimmen, eds., *F. Holland Day, Selected Texts and Bibliography* (Oxford: Clio Press, 1995).
- Daum, Patrick and Francis Ribemont, Phillip Proger, eds., *Impressionist Camera, Pictorial Photography in Europe, 1888-1918* (London: Merrell, 2006).
- Deschin, Jacob, *Rollei Photography, Handbook of the Rolleiflex and Rolleicord Cameras* (San Francisco: Camera Craft Publishing Company, 1952).
- Eder, Josef Maria, *History of Photography* trans. Edward Epstean (New York: Dover Publications, 1978).
- Emerson, P. H., *Naturalistic Photography* 3rd ed. 1899, reprinted (New York: Arno Press, 1973).
- Evans, Frederick H., “Glass Versus Paper” *Camera Work*, No. 10, April, 1905, reprinted in Anne Hammond, ed., *Frederick H. Evans: Selected Texts and Bibliography* (Oxford: Clio Press, 1992).
- Fincham, W. H. A. and M. H. Freeman, *Optics*, 8th ed. (London: Butterworths, 1976).

- The Focal Encyclopedia of Photography* revised desk edition (New York: McGraw-Hill, 1969).
- Ford, Colin, *Julia Margaret Cameron, 19th Century Photographer of Genius* (London: National Portrait Gallery, 2003).
- Galassi, Peter, *American Photography, 1890-1965* (New York: Museum of Modern Art, 1995).
- Gernsheim, Helmut, *Creative Photography* (New York: Bonanza Books, 1962).
- , *Julia Margaret Cameron*, (Millerton, NY: Aperture, 1975).
- , *The Rise of Photography, 1850-1880* (London: Thames & Hudson, 1998).
- Gernsheim, Helmut, in collaboration with Alison Gernsheim, *The History of Photography from the camera obscura to the beginning of the modern era* (New York: McGraw-Hill Book Company, 1969)
- Greenough, Sara and Juan Hamilton, *Alfred Stieglitz, Photographs and Writings* (Washington: National Gallery of Art, 1983).
- Hacking, Juliet, *Princes of Bohemia* (London: National Portrait Gallery, 2000).
- Hagedorn, Ann, *Savage Peace; Hope and Fear in America, 1919* (New York: Simon and Schuster, 2007).
- Hammond, Anne, “Naturalistic Vision and Symbolist Image” Michael Frizot, ed., *The New History of Photography* (Köln: Könemann, 1998).
- Hankey, Dr. J. L. and J. Dudley Johnston, *Alexander Keighley, A Memorial* (London: Pictorial Group of the Royal Photographic Society, 1947).
- Harker, Margaret, *The Linked Ring* Heinemann: (London, 1979).
- Haworth-Booth, Mark *Photography: An Independent Art* (Princeton: Princeton University Press, 1997).
- Homer, William Innes, *Alfred Stieglitz and the Photo-Secession* (Boston: Little, Brown and Company, 1983).
- Hutchings, Gordon *The Book of Pyro* (Granite Bay, CA: the author, 1992).
- Ivins, William M, *Prints and Visual Communications* (London: Routledge and Kegan, Paul, Ltd., 1953).
- Jones, Bernard, ed., *Encyclopedia of Photography* 1911 reprint (New York: Arno Press, 1974).
- Jussim, Estelle, *Visual Communication and the Graphic Arts, Photographic Technologies in the Nineteenth Century* reprint (New York: R. R. Bowker Company, 1983).
- , *Slave to Beauty, The Eccentric Life and Controversial Career of F. Holland Day, Photographer, Publisher, Aesthete* (Boston: David R. Godine, 1981).
- Kahmen, Volker, *Photography as Art* trans. Brian Tubb (London: Studio Vista, 1974).
- Katz, Robert and Celestine Dars, *The Impressionists* (Leicester: Abbeydale Press, 2002).
- S. Carl King *The Photographic Impressionists of Spain* (Lewiston, NY: The Edwin Mellen Press, 1989).
- Kingslake, Rudolph, *A History of the Photographic Lens* (Boston: Academic Press, Inc, 1989).
- , *Lenses in Photography* (New York: A. S. Barnes and Company, Inc., 1963).
- , *Lens Design Fundamentals* (New York: Academic Press, 1978).
- Knapp, Ulrich, *Heinrich Kühn. Photographien* (Salzburg: Residenz Verlag, 1988)
- Kodak *Professional Portrait Techniques* (Rochester: Eastman Kodak, 1980)

- , *Large Format Photography* 2nd ed. Revised, (Rochester: Silver Pixel Press, 1998).
- Lowe, Sarah M., *Tina Modotti and Edward Weston the Mexican Years* (London: Merrell, 2004).
- Lowe, Sue Davison *Stieglitz, a Memoir/Biography* (New York: Farrar Straus Giroux, 1983).
- Lytle, Larry and Dawson, Michael, “William Mortensen: A Selected Chronological Bibliography” *William Mortensen, a Revival* (Tucson: Center for Creative Photography, 1998).
- Mann, Margery, *California Pictorialism* (San Francisco: San Francisco Museum of Modern Art, 1977).
- McConkey, Kenneth, *British Impressionism* (London: Phaidon Press Limited, 1989).
- , “Dr. Emerson and the Sentiment of Nature” *Life and Landscape: P. H. Emerson, art and photography in East Anglia 1885-1900* (Norwich: Salisbury Centre for Visual Arts, 1986).
- McKenzie, Ray, “Introduction: Pictorialism and its Malcontents” *Photography 1900: Lawson, Julie, Ray McKenzie, and A. D. Morrison-Low, eds.*, (Edinburgh: National Museums of Scotland, 1992)
- Nadeau, Luis, *History and Practice of Platinum Printing* (New Brunswick: Atelier Luis Nadeau, 1984).
- , *Encyclopedia of Printing, Photographic and Photomechanical Processes* (New Brunswick: Atelier Luis Nadeau, 1994).
- Naef, Weston J., *The Collection of Alfred Stieglitz* (New York: The Viking Press, 1978).
- Newhall, Beaumont, *The History of Photography from 1839 to the Present Day* (New York: Museum of Modern Art, 1964).
- , *Focus: Memoirs of a Life in Photography* (Boston: Bullfinch Press, 1993).
- , [ed.] *Photography: Essays & Images, Illustrated Readings in the History of Photography* (New York: The Museum of Modern Art, 1980)
- , and Amy Conger, eds., *Edward Weston Omnibus: A Critical Anthology* (Salt Lake City: Peregrine Smith Books, 1984).
- Newhall, Nancy, *P. H. Emerson* (Millerton, NY: Aperture, 1975).
- , *From Adams to Stieglitz* (New York: Aperture Foundation, Inc., 1999).
- Nickel, Douglas, *Photography at Princeton* (Princeton, NJ: The Art Museum, Princeton University, 1998).
- Peterson, Christian A., *After the Photo-Secession, American Pictorial Photography, 1910-1955* (Minneapolis: The Minneapolis Institute of Arts, 1997).
- Paine, Richard P., *A Review of Graflex* (New York: A Photographers Place, 1985).
- Palmquist, Peter *Dassonville* (Nevada City, California: Carl Mautz Publishing, 1999).
- Pearson, Fiona, “The Correspondence Between P. H. Emerson and J. Havard Thomas” in *British Photography in the Nineteenth Century*, Mike Weaver, ed., (Cambridge: Cambridge University Press, 1989).
- Professional Portrait Techniques* (Rochester: Eastman Kodak, 1980).
- Pultz, John, “Austerity and Clarity; New Photography in the United States 1920-40” Michel Frizot, ed., *A New History of Photography* (Cologne: Koneman, 1998).
- Ray, Sidney F., *The Photographic Lens* 2nd ed. (Boston: Focal Press, 1992).
- Reilly, James M., *The Albumen and Salted Paper Book* (Rochester, NY: Light Impressions, 1980).

- Renner, Eric, *Pinhole Photography, Rediscovering a Historic Technique*, 3rd ed. (Boston: Focal Press, 2004).
- Rice, Shelley, "Parallel Universes" *Pictorial Effect, Naturalistic Vision* Ellen Handy, ed., (Norfolk, VA: The Chrysler Museum, 1994).
- Roberts, Pam, *Camera Work, the Complete Illustrations, 1903-1917* (Cologne: Benedikt Taschen, 1997).
- Roberts, Pam et al, *F. Holland Day* (Amsterdam: Van Gogh Museum, 2000).
- Robinson, H. P., *The Studio and What to do in It*, London, 1891 reprint Arno Press, (New York, 1973).
- Rogliatti, Gianni *Leica, the First Seventy Years* (Henfield, W. Sussex:Hove Collector's Books, 1995).
- Rood, Ogden N., *Modern Chromatics: Students' Text Book of Color with Applications To Art and Industry*, 1879, reprinted (New York: Van Nostrand Reinhold, 1967).
- Rosenblum, Naomi, *A World History of Photography* (New York: Abbeville, 1984).
- Scholz, Dr. Alfons, *Das Imagon Buch* trans. Anonymous (Munich: Rodenstock 1979).
- Schwabik, Marian and Maurice Misonne, *Léonard Misonne Ein Fotograf aus Belgien, 1870-1943* (Seebruck: IM Herring, 1976).
- Shaw, Micheal J., *Every Now and Then* Whitby: The Sutcliffe Gallery, 2002).
- Sichel, Kim and Stacey McCarroll, *California Dreamin'* (Boston: Boston University Art Gallery, 2004).
- Smith, Lindsay, *The Politics of Focus: Women, Children, and Nineteenth Century Photography* (Manchester: Manchester University Press, 1998).
- Steichen, Edward, *A Life in Photography* (Garden City NJ: Doubleday & Co., 1963).
- Steinorth, Karl, ed., *Coburn Photographs, 1900-1924* (Zurich: Edition Stemmler, 1998).
- Sternberger, Paul Spencer, *Between Amateur and Aesthete* (Albuquerque: University of New Mexico Press, 2001).
- Stevenson, Sara, *Facing the Light* (Edinburgh: National Museum of Scotland, 2002).
- Stroebel, Leslie, *View Camera Technique* 4th ed. revised, (Boston: Focal Press, 1980).
- Sullivan, Richard and Weese, Carl *The New Platinum Print* (Santa Fe: Working Pictures Press, 1998).
- Szarkowski, John, *Alfred Stieglitz at Lake George* (New York: Museum of Modern Art, 1995).
- Taylor, John, *Pictorial Photography in Britain, 1900-1920* London: Arts Council of Great Britain, 1978).
- Tucker, Jean, *Group f.64* (St. Louis: University of Missouri-St. Louis, 1978).
- Vieira, Mark A., *Hurrell's Hollywood Portraits* (New York: Harry N. Abrams, 1997).
- Ward, Nowell, *Picture Making with Paper Negatives* (Boston: American Photographic Publishing Co., 1943).
- Ware, Mike, "The Eighth Metal: The Rise of the Platinotype Process" in *Photography 1900: The Edinburgh Symposium* Lawson, Julie, Ray McKenzie, and A. D. Morrison-Low, eds., (Edinburgh: National Museums of Scotland, 1992).
- Warren, Beth Gates, *Margrethe Mather & Edward Weston, A Passionate Collaboration* (New York: W. W. Norton & Co., 2001).
- Weaver, Mike, *Alvin Langdon Coburn, Symbolist Photographer* (New York: Aperture Foundation, 1986).

- Weston, Edward, *The Daybooks of Edward Weston* Nancy Newhall, ed., 2nd ed., (New York: Aperture, 1990).
- Whelan, Richard, *Alfred Stieglitz* (Boston: Little, Brown and Company, 1995).
- , *Stieglitz on Photography* (New York: Aperture, 2000).
- Wood, John, *The Art of the Autochrome, the Birth of Color Photography* (Iowa City: University of Iowa Press, 1993).
- Yochelson, Bonnie and Kathleen A. Erwin, *Pictorialism into Modernism, The Clarence White School of Photography* (New York: Rizzoli International Publications, 1996).

Annals and Exhibition Catalogs

Pre-1940

- Agha, M. F., *Pictorial Photography in America 1929* New York: Pictorial Photographers of America, 1929
- The American Annual of Photography, 1917* New York: The American Annual of Photography, Inc., 1916.
- The American Annual of Photography, 1928* Boston: American Photographic Publishing Company, 1927.
- The American Annual of Photography and Photographic Times Almanac for 1902*
- Anderson, Paul L., “Oil and Bromoil for Portraiture” *The American Annual of Photography, 1917* New York: The American Annual of Photography, Inc., 1916.
- , “The Graflex for Pictorial Work” *The American Annual of Photography, 1920* New York: American Photographic Publishing Co., 1919.
- Ausstellung für Kunstlerische Photographie, Berlin: unknown, 1899.
- “The Camera Pictorialists of Los Angeles” *The Pictorialist 1931* Los Angeles: Camera Pictorialists of Los Angeles, 1931.
- Das Deutsche Lichtbild Jahresschau 1931* Berlin: Bruno Schultz, 1930.
- Das Deutsche Lichtbild Jahresschau 1933* Berlin: Bruno Schultz, 1932.
- Das Deutsche Lichtbild Jahresschau 1936* Berlin: Bruno Schultz 1935.
- Demachy, Robert, “The Pictorial Side in France” *Photograms of the Year 1907* London: Dawburn & Ward, 1906.
- Emerson, P. H., “Bubbles” *Photograms of the Year 1900* London: Illiffe & Sons, 1900.
- , “What is a Naturalistic Photograph?” *The American Annual of Photography and Photographic Times Almanac* New York: Scovill & Adams Company, 1895.
- Horne, B. S., “As to Certain Soft Focus Lenses” *Pictorial Photography in America 1921* New York: Pictorial Photographers of America, 1921.
- Kales, Arthur, ‘Western America’ *Photograms of the Year 1922* through 1936.
- Kihn, Prof. Berthold, “Interesting Facts about the Imagon” *The German Annual of Photography, 1937* Berlin: Bruno Schultz, 1936.
- Kühn, Heinrich, “On Soft Focus Objectives” *The German Annual of Photography 1928-29* Berlin: Robert & Bruno Schultz, 1928?
- , “Clearness” *The German Annual of Photography 1937* Berlin: Bruno Schultz, 1936.

- Pictorial Photography in America 1922* New York: Pictorial Photographers of America, 1922.
- Stieglitz, Alfred, "The Progress of Pictorial Photography in the United States" *The American Annual of Photography and Photographic Times Almanac* Walter E. Woodbury, ed., New York: The Scovill & Adams Co., 1899.
- Swoyer, A. E., "Pinhole Enlarging" *The American Annual of Photography 1913* New York: The American Annual of Photography, Inc., 1912.
- White, Clarence and Moore, Henry Hoyt, "The Year's Progress" *Pictorial Photography in America 1921* New York: Pictorial Photographers of America, 1921.

Annals and Exhibition Catalogs

Post-1940

- Adams, Ansel, "Personal Credo" *The American Annual of Photography, 1944* Boston: American Photographic Publishing Company, 1943.
- Yates, Steve, *Proto-Modern Photography* Santa Fe: Museum of Fine Arts, 1992.
- Young, Russ, "Historical Pinhole" *Studies in Photography 2005* (Glasgow: The Scottish Society for the History of Photography, 2005) pp. 42-47

Periodicals

Pre-1940

- Anderson, Paul L, "Some Pictorial History," *American Photography* 29, no 4 (April 1935.)
- An Old Photographer [pseud.], "Letter to the Editors: Out of Focus," *BJP* 13, no. 331 (September 7, 1866.)
- , "Letter to the Editors: Priority of Discovery," *BJP* 13, no 333 (September 21, 1866.)
- Bayham, John, "Letter to the Editors: Altering the Focus of the Lens," *BJP* 13, no 336 (October 12, 1866)
- Beardsley, A. H., "The Beginner and the Soft-Focus Lens," *Photo-Era* 46, no. 6 (June 1921.)
- Bertling, Walter E., "The Albright Art Gallery Exhibition," *Photo-Era* 26 no. 1 (January 1911)
- Cadby, Will, "The Future of Pictorial Photography in Great Britain," *The Amateur Photographer & Photographic News* (December 14, 1909.)
- Cadby, Will, and Carine Cadby, "London Letter," *Photo-Era* 37, no. 1 (June 1916.)
- , "London Letter," *Photo-Era* 37, no. 6 (December 1916.)
- , "London Letter," *Photo-Era* 39, no. 4 (October 1917.)
- , "London Letter," *Photo-Era* 42, no. 2 (February 1919.)
- , "London Letter," *Photo-Era* 43, no. 3 (September 1919.)
- , "London Letter," *Photo Era* 49, no. 2 (August 1922.)
- Camera Work* 15, (1906.)
- Camera Work* 16, (1906.)
- Camera Work* 20, (1907.)

- Camera Work* 36, (1911.)
- Claudet, A., "Letter to the Editors: M. Claudet on Priority of Discovery," *BJP* 13, no. 332 (September 14, 1866.)
- , "On a Means of Introducing Harmony and Artistic Effect in Photographic Portraits by Equalising the Definition of the Various Planes of Focus," *BJP* 13, no. 341 (November 16, 1866.)
- , "On a New Process for Equalising the Definition of all Planes of a Solid Figure Represented in a Photographic Picture," *BJP* 12, no. 330 (August 31, 1866.)
- , "On a Self-Acting Focus-Equaliser, or the Means of Producing the Differential Movements of the Two Lenses of a Photographic Optical Combination, Which is Capable, During the Exposure, of Bringing Consecutively all the Planes of a Solid Figure in Focus, Without Altering the Size of the Various Images Superimposed," *BJP* 14, no. 367 (May 17, 1867.)
- Clifton, Edgar, "The Lens in the Studio," *BJP* 58 no. 2666 (June 9, 1911).
- Colson, R. Capt., "On the Determination of the Law Which Connects the Diameter of the Aperture With the Distance of Maximum Sharpness in Photographing Without a Lens" *BJP* 35, no. 1465 (June 1, 1888)
- Dallas, E. W., "Correspondence," *Journal of the Photographic Society* 3, (April 21, 1853.)
- Dallmeyer, J. H., "On a New Portrait Lens," *BJP* 13, no 346 (December 21, 1866.)
- Dallmeyer, T. R., "Review" *The Photographic Journal* (Nov. 30, 1895.)
- Hon. Secretary, "Proceedings," *The Photographic Journal*, (November 30, 1895)
- Davison, George, "Pinhole Pictures," *Photography* (April 4, 1889.)
- , "Softness in Photographs and Means of Obtaining It," *Photography* (October 17, 1889.)
- , "Softness in Photographs and Means of Obtaining It – II," *Photography* (December 12, 1889)
- , "Definition and Diffusion," *Photography* (Sept. 19, 1889)
- , "The Focus Question," *The Photographic News* (November 14, 1890)
- , "Impressionism in Photography," *BJP* 37, No. 1599 (December 26, 1890.)
- Debenham, W. E., "Is Blurring Desirable in a Photograph?" *The Photographic News* (November 14, 1890).
- Demachy, Robert, "The Gum Print," *Camera Work* 7 (July 1904.)
- , "Mechanism and Pictorial Photography," *The Amateur Photographer & Photographic News* (March 15, 1910.)
- Editor, "The Future of Pictorial Photography in Great Britain," *The Amateur Photographer & Photographic News* 50, no. 1315 (December 14, 1909).
- Editors, *Camera Work* 5 (1904.)
- Editors, "Editor's footnote to John Dallmeyer: On A New Portrait Lens," *BJP* 11 no. 212 (April 15, 1864.)
- , "A New Lens with Diffused Focus" *BJP* 13, no. 346 (December 21, 1866.)
- Edwards, John Paul, "The Eighth Pittsburgh Salon," *Photo-Era* 46, no. 5 (May 1921.)
- , "Portrait of An Artist" *Photo-Era* 33, no. 5 (November 1914.)
- , "The San Francisco-Oakland Salon," *Photo-Era* 51, no. 6 (December 1923.)
- , "The Soft-Focus Lens," *Camera Craft* 21, no. 7 (July 1914.)
- Emerson, P.H., "Julia Margaret Cameron," *Sun Artists* 5 (October 1890.)

- Evans, Frederick, "Exhibition of Photographs by Julia Margaret Cameron," *The Amateur Photographer* 40, no. 1033 (July 21, 1904).
- , "The Soft Focus Lens and Sun Effects," *The Amateur Photographer and Photographic News* 52, no. 1354 (September 13, 1910.)
- Forgan, W., "Pinhole Photography," *BJP* 34 no. 1438 (Nov. 25, 1887).
- French, Wilfred, [ed.] "Editorial," *Photo-Era* 25, no. 3 (September 1910.)
- , [ed.] "Catalog of 'Smith' Lenses," *Photo-Era* 26, no. 4 (April 1911.)
- , [ed.] "Notice: Struss for Reflecting Cameras," *Photo Era* 37, no. 2 (August, 1916.)
- , [ed.] "Events of the Month- Henry S. Smith" *Photo-Era* 39, no 2 (August 1917.)
- , [ed.] "Photographic Lenses Commandeered," *Photo-Era* 38, no. 3 (March 1917.)
- , [ed.] "With the Trade," *Photo-Era* 42, no. 4 (April 1919.)
- , [ed.] "Wollensak Verito for the Graflex," *Photo-Era* 42, no 4 (April 1919.)
- Guest, Anthony, "Exhibition of the Royal Photographic Society," *Photo-Era* 33, no. 5 (November 1914.)
- , "A. L. Coburn's Vortographs," *Photo-Era* 38, no. 5 (May 1917.)
- Hagemeyer, Johan, "Pictorial Interpretation," *Camera Craft* 29, no. 8 (August 1922).
- Hammond, Arthur, "Portraits Without Retouching," *Photo-Era* 26, no. 6 (June 1911).
- , "Soft Focus Lenses for Landscape Work *Photo-Era* 27, no. 5 (November 1911.)
- , "Portraiture: the lens for portraiture, Chapter V," *American Photography* 15, no. 2 (February 1921.)
- , "Soft Focus Lenses" *American Photography* 15, No. 8 (August 1921.)
- Johnston, J. Dudley, "Phases of Development in the Development of Pictorial Photography in Britain and America," *The Photographic Journal* (December 1923.)
- Lambert, Ernst, "On the Use of a Single Lens in Portraiture," *The Studio* III, no. 14 (May 1894.)
- Laurik, J. Nilson, "International Photography at the National Arts Club, N.Y.," *Camera Work* 26 (April 1909.)
- LX [pseud.], "Letter to the Editors: M. Claudet's Discovery," *BJP* 13, no. 335 (October 5, 1866.)
- Maskell, Alfred, "Artistic Focus and the Suppression of the Lens," *Photographic Quarterly* 2, no. 5 (October 1890.)
- , "Discussion," *BJP* 37, no. 1599 (26 December 1890.)
- Matthies-Masuren, F., "Hugo Henneberg- Heinrich Kühn-Hans Watzek," Translated by George Herbert Englehard in *Camera Work* 13 (January 1906.)
- Mayall, Mr. quoted in "London Photographic Society," *BJP* 13, no 341 (November 16, 1866.)
- Newton, Sir William J., untitled article, *Journal of the Photographic Society*, 2, (April 1, 1853.)
- "Obituary: Mr. J. S. Bergheim," *The Times (London)* 11 September 1912.)
- Photographic Dealers, "Letters," *Photo-Era* 43, no. 1 (January 1919.)
- Pickering, William H., "The Pinhole Camera," *The Photographic News* (March 2, 1888.)
- Pringle, Andrew, "The Naissance of Art in Photography," *The Studio* 1, no. 3 (June 1893.)
- Proctor, Barnard S., "Lessons Derived from Pin-Hole Photographs," part 1, *BJP* 32, no. 1299 (March 27, 1885).

- , “Lessons Derived from Pin-Hole Photographs,” part 2. *BJP* 32, no.1300 (April 3, 1885)
- Rejlander, O. J., “O. J. Rejlander on ‘Out of Focus,’” *BJP* 13, no. 338 (October 26, 1866).
- Steichen, Edward, “Accompanying Reproductions of Recent Work by Robert Demachy,” *The Photographic Art Journal* 1, no. 6 (August, 15, 1901)
- , “Hans Watzek,” *Camera Work* 4 (October 1903.)
- Struss, Karl, “The International Los Angeles Salon,” *Photo-Era* 50 no. 4 (April 1923.)
- (Strutt, John William) Lord Rayleigh, “On Pin-hole Photography,” *Philosophical Magazine and Journal of Science* 23 (February 1891).
- , “Pinhole Photography,” *The Photographic News* (September 20, 1889.)
- Taylor, J. T., “Popular Notes on Photographic Lenses, Part I- on Portrait Lenses,” *BJP* 11, no. 211 (April 1, 1863).
- , “Popular Notes on Photographic Lenses, Part II- Landscape Lenses,” *BJP* 11, no. 212 (April 15, 1864.)
- Tennant, John, “Modern Lenses,” *The Photo-Miniature* 1, no. 1 (April 1899.)
- , “Notes and Comments,” *The Photo-Miniature* 13, no. 149 (May, 1916.)
- , “Photography with Reflex Cameras and Focal-Plane Shutters,” *The Photo-Miniature*, 13, no. 151 (June 1916)
- , “Soft-Focus Effects in Photography,” *The Photo-Miniature* 16, no. 184 (December 1921.)
- Ward, H. Snowden, and Catherine Weed Ward, “Current Topics,” *The Photogram* 6 no. 72 (April, 1899)
- Weston, Edward H., “Artistic Interiors,” *Photo-Era* 27, no. 6 (December 1911.)
- , “The Story-Hour,” *Photo-Era* 30, no. 5 (May 1913.)
- , “View from Mt. Wilson,” *Photo-Era* 29, no.5 (November 1912): 254.
- White, Clarence, “Notes from Pictorialists,” *The Photo Miniature* 16, no. 184 (December 1921.)
- Zimmerman, Walter, “The Photo-Secessionists and the Independents,” *Photo-Era* 25, no. 3 (Sept 1910).

Periodicals

Post-1940

- Croell, Arne, “Voigtlander Large Format Lenses from 1949-1972,” *View Camera* (May-June 2005.)
- Gillberg, I. C., and Gillberg, C., “Asperger Syndrome- Some Epidemiological Considerations: a Research Note,” *Journal of Child Psychology and Psychiatry* 30 (June 30, 1989.)
- Keller, Ulrich, “The Myth of Art Photography,” *History of Photography* 8, no. 4 (October-December 1984)
- Lowry, Barbara, “English Made Cooke Lenses- Still in the Picture,” *View Camera* (May 2002.)
- Marien, Mary Warner, “Peter Henry Emerson: The Taxonomy of a Crow’s Nest,” *History of Photography* 21, no. 2 (Summer 1997.)
-

- Normand, Tom, "Alvin Langdon Coburn, Robert Louis Stevenson and Edinburgh" *History of Photography* 29, no. 1 (Spring 2005.)
- Pitts, Terence R., "Paul Lewis Anderson: A Life in Photography," *The Archive* 18 (May 1983.)
- Starkweather, Albert, "Notes on the Verito Lens," *The New Pictorialist* 4, no. 2 (April, 1972.)
- Stein, Sally, "Autochromes without apologies, Heinrich Kühn's experiments with the mechanical palette," *History of Photography* 18 (1994.)
- Taylor, John, "The Salon des Refusés," *History of Photography* 8, no. 4 (October-December 1984.)
- Thayer, Katherine, "Embracing Beauty; the Post-Postmodern Pictorialist Landscape Photograph," *Lens Work* 53 (June-July 2004.)
- [White, Gleeson], in "Photographic Portraiture: An Interview with Mr. H. H. Hay Cameron" reprinted in *The Birth of the Studio, 1893-1895*, Simon Houfe, editor (Woodbridge, Suffolk: Antique Collectors' Club, 1976).
- Young, Russ "A Brief History of Soft Focus Lenses" *The Photohistorian*, Summer 2003, Nos. 141-142, pp. 24-36.
- , "A History of Soft Focus Lenses in Britain and America" *Photographica World*, February, 2003, No. 1, pp. 25-33.

Catalogues, Pamphlets, and Ephemera

Pre-1940

- An Ideal Lens for Pictorialists* (Boston: Pinkham & Smith, ca. 1916).
- Camera House price list* (W. Butcher & Sons, Ltd. 1914).
- Catalog and Price List 1904 of Photographic Apparatus* (New York: Folmer & Schwing Manufacturing Co., 1904)
- Concerning the Verito* Rochester: (Wollensak Optical Company, ca. 1930).
- How to be Happy with the Graf Variable Anastigmat* (South Bend, IN: Graf Optical Co., ca. 1923).
- Struss, Karl, *SPL*. (Morristown, NY: Frederick W. Keasbey, ca. 1920).
- Kodak Limited *Price List of General Photographic Apparatus and Materials* (London: Kodak Ltd., 1904).
- Kühn, Heinrich, *Imagon Tiefenbildner* Munich: Optische Werke (G. Rodenstock ca. 1938).
- , *Imagon Plastic Depth Lens Sees Like the Artist's Eye* (Munich: Optical Works G. Rodenstock, ca. 1938).
- Semi-Achromatic Lenses* (Boston: Pinkham & Smith, ca. 1912).
- Smith Soft Focus Lenses* (Boston: Pinkham & Smith, ca. 1923).
- Verito, the Lens that Improves on Acquaintance* (Rochester: Wollensak Optical Company, ca. 1913).
- Wollensak Lenses for 1912-1913* (Rochester: Wollensak Optical Co., 1912)

Catalogues, Pamphlets, and Ephemera Post-1940

Burke & James 54th Annual Catalog (Chicago: Burke & James, Inc., 1951).

Burke & James Photographic Equipment and Instrumentation (Chicago: Burke & James, Inc., 1967).

Camera Lenses Munich: Optische Werke (G. Rodenstock, 1985).

Struss, Karl, *SPL*, facsimile reprint of the original 1915 sales brochure as “Pictured with the Struss Lens,” in *The New Pictorialist*, 10, no. 1 (Spring 1978).

Kodak Portrait Lens (Rochester: Eastman Kodak Company, 1952).

Portrait Veritar Lens (Rochester: Wollensak Optical Company, ca. 1955)

Rodenstock Imagon (Munich: Optische Werke G. Rodenstock, 1978).

Compact Disc

Wilkinson, Matthew and Colin Galnfield, *A Lens Collector's Vade Mecum; In Memory of Two Lens Collectors and Their Achievements* Redruth, Cornwall: David Matthews Assoc., 2nd edition revised .

Internet Sites

www.ancestry.com

www.apug.org

www.dofmaster.com/dofjs.html

www.ehlsinki.fi/ieh2006/papers1/Steyn.pdf

www.en.wikipedia.org/wiki/Asperger_syndrome

www.largeformatphotography.info

www.vanwalree.com
