

On the identity of broad-shelled mussels (Mollusca, Bivalvia, *Mytilus*) from the Dutch delta region

Dick S.J. Groenenberg^{1,6}, Frank P. Wesselingh¹, Sanjeevi Rajagopal², Jeroen M. Jansen³, Merijn M. Bos⁴, Gerard van der Velde^{1,2}, Edmund Gittenberger¹, Bert W. Hoeksema¹, Harry Raad¹, Herman Hummel⁵

¹ Netherlands Centre for Biodiversity Naturalis (NCB), PO Box 9517, NL 2300 RA Leiden, The Netherlands

² Radboud University Nijmegen, Institute for Water and Wetland Research, Department of Animal Ecology and Ecophysiology, Heyendaalseweg 135, NL 6525 AJ Nijmegen, The Netherlands

³ Institute for Marine Resources & Ecosystem Studies (IMARES), PO Box 57, NL 1785 AJ, Den Helder, The Netherlands

⁴ Louis Bolk Instituut, Hoofdstraat 24, NL 3972 LA, Driebergen, The Netherlands

⁵ Netherlands Institute of Ecology (NIOO), PO Box 140, NL 4400 AC, Yerseke, The Netherlands

⁶ E-mail: dick.groenenberg@ncbnaturalis.nl

Key words: AFLP, COIII, Me 15/16, *Mytilus*, shell morphology, The Netherlands

Abstract

Late Quaternary (Eemian) deposits of the Netherlands contain shells that resemble those of living *Mytilus galloprovincialis*. Similar broad-shelled mytilids also occur in estuaries of the southwestern Netherlands together with slender individuals typical of *M. edulis*. We sampled living mussels along a depth gradient in the Oosterschelde to a) investigate whether a relation exists between shell shape and depth, b) test if the broad-shelled specimens might represent *M. galloprovincialis* (or a hybrid with *M. edulis*) and c) assess by inference if the Quaternary specimens might be attributed to *M. galloprovincialis* as well. In order to do so, we compared genetic (length polymorphism of *Me 15/16*, *COIII* sequences and AFLPs) and shell-morphological characteristics (juvenile L/W ratios and so-called Verduin parameters) of the same specimens. The obtained dataset indicates that all studied mussels from the Oosterschelde should be attributed to *M. edulis*, including those with broad shell outlines. No correlation of shell-morphology and depth-distribution was found. The worn and generally damaged state of the Eemian specimens precluded measurement of the Verduin parameters, while juvenile L/W ratios turned out not to be diagnostic. Therefore the shell characters examined in this study are insufficient to demonstrate the possible presence of *M. galloprovincialis* shells in Quaternary deposits of the Netherlands.

Contents

Introduction	95
<i>Distribution of modern European mussel species</i>	97
<i>Identification</i>	97
Material and methods	97
<i>Sample collection</i>	97
<i>Morphometrics</i>	98
<i>Sample treatment and DNA extraction</i>	98

<i>Adhesive protein gene</i>	99
<i>Cytochrome c oxidase subunit III (COIII)</i>	99
<i>Amplified Fragment Length Polymorphism (AFLP)</i>	99
<i>Statistical analysis</i>	101
Results	101
<i>Shell morphology</i>	101
<i>Adhesive protein gene</i>	101
<i>COIII</i>	101
<i>AFLP</i>	103
Discussion	103
Conclusion	104
Acknowledgements	105
References	105

Introduction

The taxonomy of common European *Mytilus* species is complex. The wide variety of shell shapes as well as the common occurrence of genetic interchange between populations shows that the discrimination between species is not straightforward (Filipowicz *et al.*, 2008; Śmietanka *et al.*, 2009). Conventionally, three *Mytilus* species are distinguished within the European seas, *viz.* *Mytilus edulis* Linné, 1758, *M. galloprovincialis* Lamarck, 1819 and *M. trossulus* Gould, 1850.

Mussels living along the coast of the southwestern Netherlands show a wide variety of shell shapes. On exposed North Sea localities, populations are entirely dominated by slender shells typically identified as *Mytilus edulis*. Broad specimens with a relatively sharp dorsal ridge and a pointed umbo are very rare on these exposed shores, although flat and broad specimens with a characteristic light brown periostracum

do occur on floating material (Entrop, 1965) and are also known from wrecks on the North Sea floor (pers. obs. FW). The identity of these light brown mussels with a flat and broad shell shape remains to be established. Bluish broad-shelled *Mytilus* specimens are not uncommon in harbour basins and estuaries. Intermediate forms between broad and slender-shelled bluish mussels also occur (Fig. 1). Some of the broad forms resemble shells of *Mytilus galloprovincialis*, a species well known from the Mediterranean but also occurring in southwestern Europe (SanJuan *et al.*, 1994, 1997). Similar broad-shelled mussels with a pointed umbo are also known from Eemian interglacial faunas of the Netherlands (Fig. 1). The closest populations of *M. galloprovincialis*, as confirmed by genetic analyses, are found in the western Channel region (Hilbish *et al.*, 2002). In Dutch *Mytilus* populations, *M. galloprovincialis*-type alleles have been found at very low frequencies (Luttikhuisen *et al.*, 2002; Kijewski *et al.*, 2009). The centre of the modern distribution of *M. galloprovincialis* is to the south of The Netherlands. Since

the Eemian interglacial fauna contains various taxa with a more southerly centre of distribution than the present Dutch fauna (*e.g.* *Nucula nucleus* (Linné, 1758), *Lucinella divaricata* (Linné, 1758), *Solen marginatus* Pulteney, 1799, *Pholas dactylus* Linné, 1758, *Gibbula magus* (Linné, 1758)) it would be realistic to assume that the Eemian broad-shelled mussels might belong to *M. galloprovincialis*. However, the exact identity of the Eemian as well as the modern broad-shelled mussels in The Netherlands remains to be investigated. The generally damaged or worn preservation state of Eemian mussels precludes assessment of shell morphological characters including relative adductor scar lengths, as shells are incomplete (suppleted material) or adductor scars are worn (fossils washed ashore). Their identification can only be based on indirect comparison with living broad-shelled mussels.

In this paper we investigate the identity of extant broad-shelled specimens of *Mytilus* from the southwestern Netherlands by comparing their shell morphological and genetic data and we indirectly evaluate

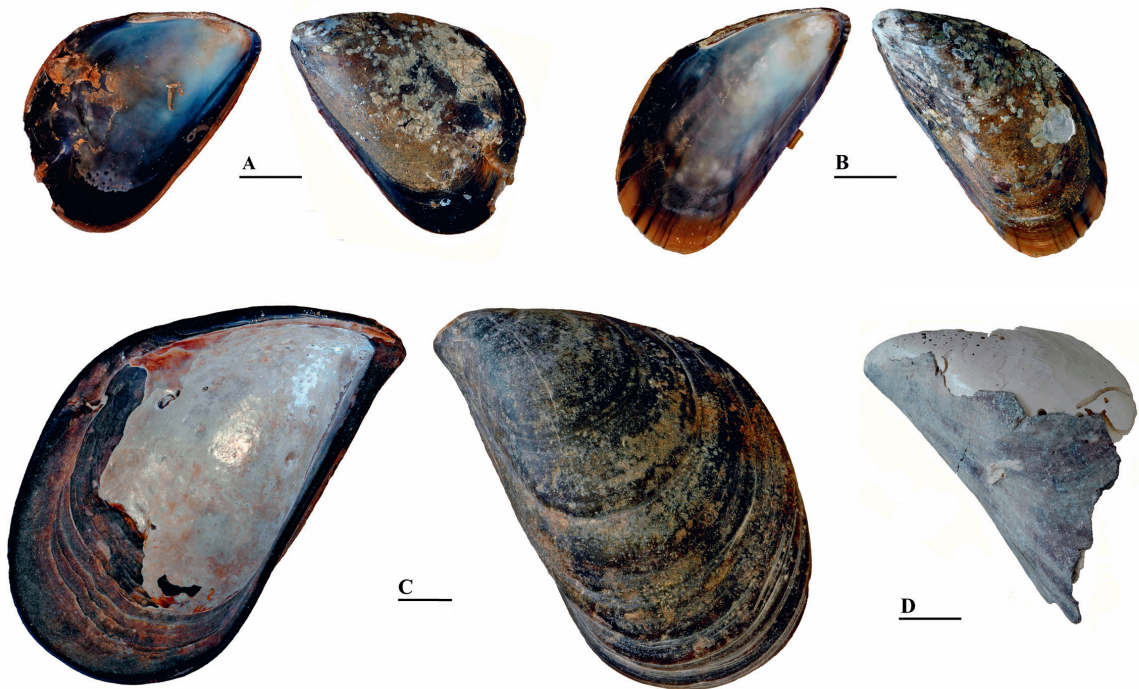

Fig. 1. *Mytilus* specimens. A) RMNH.MOL.122086 *Mytilus edulis*. Oosterschelde (Zeeland, The Netherlands). Broad subadult specimen nr.140. B) RMNH.MOL.122087 *Mytilus edulis*. Same locality, slender subadult specimen nr.47. C) RGM 466.689 *Mytilus* sp., adult broad-shelled form washed ashore at the beach of Domburg (Zeeland, The Netherlands). The preservation state (lack of translucent margins, the crudely worn shell's exterior and the worn and stained nacre) is indicative of a likely Eemian (Late Pleistocene) age. D) RGM 607.080 *Mytilus* sp., adult broad-shelled form showing the typical defect preservation state of Eemian mussels precluding assessment of Verduin characters. Slotervaartse Plas, Amsterdam, The Netherlands, Eemian (Late Pleistocene). Scale bar 1 cm.

whether broad-shelled Eemian mussels could be attributed to *M. galloprovincialis*.

Distribution of modern European mussel species

The three European *Mytilus* species have different, partially overlapping distribution ranges. *Mytilus trossulus* has a subarctic high-boreal distribution (also outside Europe). It is well adapted to cool temperatures and wide salinity variations. *Mytilus edulis* is recorded to be common along the entire European Atlantic coasts, southwards to Morocco (Jaziri *et al.*, 2003), and also occurs in the western part of the Mediterranean (Quesada *et al.*, 1995). *Mytilus galloprovincialis* is regarded as the dominating mussel species in the Mediterranean, but also lives along the Atlantic coast of Europe, as far north as northwestern Ireland (*e.g.* Gardner, 1992). The species appears the least adapted to salinity variations, and in general thrives in higher temperature settings than the other two species.

Hybridization occurs in virtually every known case where *Mytilus* taxa occur sympatrically, or where they are in geographic contact (Koehn, 1991). This resulted in *M. edulis-galloprovincialis* and *M. edulis-trossulus* hybrids in Europe (Hilbish *et al.*, 2002; Rawson and Hilbish, 1998; Riginos *et al.*, 2002; Kijewski *et al.*, 2009) and *M. trossulus-galloprovincialis* hybrids outside Europe (*e.g.* Inoue *et al.*, 1997; Rawson *et al.*, 1999). The common occurrence of hybrids questions the validity of the taxonomic status of *Mytilus* species. In convention with common terminology, we use the before mentioned names, as if they were well-established species, despite these taxonomic uncertainties (see discussion).

Identification

The discrimination of *Mytilus* species based on shell characters is problematic. Historically, identification was based on the combination of geographic provenance and the overall shape of the shell. Not a single shell-character (Koehn, 1991; Gosling, 1992) nor a combination of shell characters (McDonald *et al.*, 1991) discriminates completely between *M. edulis* and *M. galloprovincialis*. Transplantation experiments as well as field surveys have shown that shell outlines in *Mytilus* species are strongly influenced by environmental settings, such as the degree of exposure to waves (Seed, 1968; Akester and Martel, 2000), or population density and type of predators (Innes and Bates, 1999 and references therein). Multivariate approaches

based on large character data sets, independently verified by molecular data, have yielded incomplete species discrimination (McDonald *et al.*, 1991; Innes and Bates, 1999). However, a set of complex shell characters (including shapes and sizes of various adductor and retractor muscle scars) proposed by Verduin (1979) might discriminate between *M. edulis* and *M. galloprovincialis*, although this is in need of confirmation by molecular data. Furthermore, the Verduin study used few populations located far apart, and lacked areas in between from where we now know that hybrid populations exist.

The identity of broad-shelled mussels found in Late Quaternary deposits of the Netherlands and extant ones living in the southwestern Dutch coastal region still needs to be established. In this paper, we examine shell-characters (L/W ratios and parameters after Verduin, 1979) and genetic markers (*Me15/16*, *COIII* and AFLP) of slender- and broad-shelled specimens of *Mytilus*, from the Oosterschelde estuary in the southwestern Netherlands, in order to establish whether the broad-shelled mussels may include *M. galloprovincialis* or hybrids.

Material and methods

Sample collection

In total 229 specimens of *Mytilus* sp. were collected by SCUBA diving at nine different depths at the second northernmost pillar at the north side of the Zeeland Bridge (Oosterschelde, the Netherlands, 51°37'42"N, 3°54'49"E, Table 1). We sampled at different depths in order to establish the distribution of morphological variation or potential distribution of species. Using

Table 1. Sample details. All samples were taken from the second pillar on the northern side of the Zeeland Bridge (Prov. Zeeland, The Netherlands: 51°37'42"N, 3°54'49"E).

Specimen numbers	Sampling depth
0-25	at low tide mark
31-55	1.5 m below low tide mark
61-85	3 m below low tide mark
91-115	4.5 m below low tide mark
121-145	6 m below low tide mark
151-175	9 m below low tide mark
181-210	12 m below low tide mark
211-235	15 m below low tide mark
241-265	20 m below low tide mark

regular scissors, individual animals were removed from the hard substrate by cutting their byssus threads. Under water, the mussels were collected in separate, labelled bags. Subsequently, the mussels were transported to the Netherlands Institute of Ecology (NIOO, Yerseke) for registration and dissection. Using a scalpel and pincers, mantle and anterior muscle tissue were separated from the rest of the animal. Half of each animal was stored in absolute ethanol (from here on denoted by suffix A) and the other half (denoted by suffix B) was stored in a saturated CTAB – 20% DMSO solution. The corresponding shells were labelled, cleaned and stored for shape analysis. Tissue samples were numbered as to enable recognition of the various parts of each individual. Shells and tissue samples in ethanol (A) were transported to the Netherlands Centre for Biodiversity, Naturalis, The Netherlands, for the study of shell morphometrics (shells were kept as voucher specimens) as well as for genetic analysis of markers *Me 15/16* and *COIII*. Tissues of the same specimens stored in CTAB (B) were sent to the Radboud University Nijmegen for AFLP analysis.

Morphometrics

Two sets of shell parameters were measured, a length/width (L/W) set and a ‘Verduin’ parameter set. Juvenile shell outlines (shell L circa 15 mm) were drawn along growth lines preserved in adult mussel shells using a stereomicroscope equipped with a drawing attachment. From these outlines the maximum length and width (the latter perpendicular to length axis) were measured (Fig. 2A). These subadult outlines were used

in order to minimise eco-phenotypic effects occurring in later growth stages (Seed, 1968). Based on the total distribution of L/W ratios, twenty-one specimens that represented slender and broad morphologies were selected for molecular analyses (described below). For these specimens, the length of the anterior adductor muscle scar and of the internal radius of the hinge plate (parameters utilized by Verduin, 1979, illustrated in Fig. 2B) were measured and standardized for the height (H) of the shell (in this case of the subadult outline).

Sample treatment and DNA extraction

Total genomic DNA from tissue stored in ethanol (A) was extracted with a general CTAB protocol, using prolonged incubation and precipitation times. Approximately 3 mm³ of tissue was digested with 20 µl proteinase K (20 mg/ml) overnight at 60°C in 500 µl CTAB-buffer. Extractions were done with 500 µl of chloroform : isoamylalcohol (24:1) and DNA was precipitated overnight at -20°C in 350 µl of isopropanol. The precipitate was washed with 500 µl ethanol/ammonium acetate, air-dried and resuspended in 50 µl MQ. DNA extractions on tissues stored in CTAB (B) were done with a DNeasy Tissue Kit (Qiagen), following the manufacturer’s protocol. Different extraction protocols were used (CTAB in Leiden, DNeasy Tissue Kit in Nijmegen), according to the expertise within the institutes at that time (2003). If the extraction method used would in any way affect the laboratory outcome, this would be equal for all the specimens analysed. Therefore, we deduce that the data from the separate

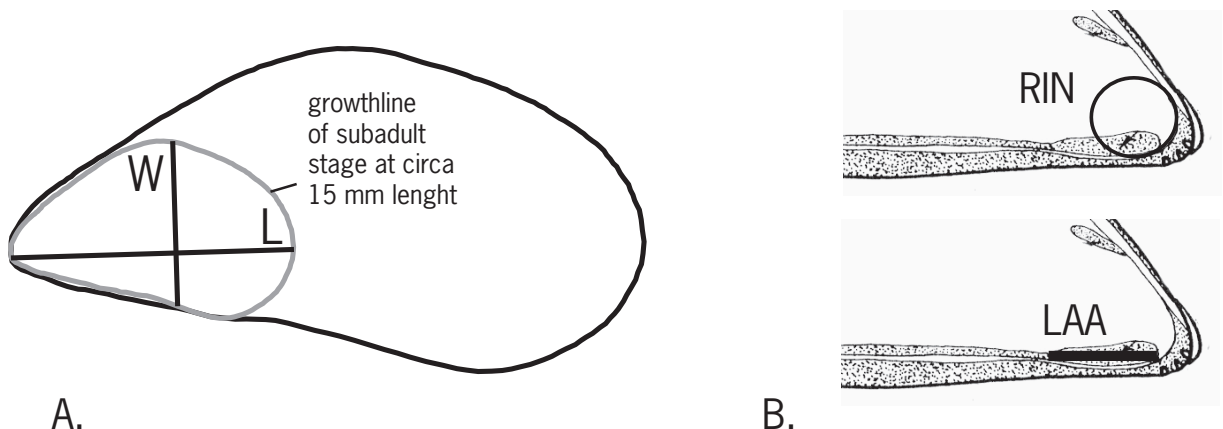

Fig. 2. A) Establishment of L/W ratios on subadult shell stages. Such stages are recognizable through the growth lines on the shell. B) The two Verduin parameters used are the length of the anterior adductor scar (LAA) and the radius of the circle (RIN) that fits the shell’s interior below the apex.

analyses trajectories are compatible and that a comparison is legitimate.

Adhesive protein gene (also referred to as Me15/16, nuclear marker)

Inoue *et al.* (1995) have shown that species in the *Mytilus* complex can be identified by a length polymorphism in the nucleotide sequence of the adhesive protein gene. Fragments amplified with sense primer Me15 CCAGTATACAAACCTGTGAAGA and anti-sense primer Me16 TGTTGTCTTAATAGGTTTGTAAAGA have a length of 180, 168 and 126 bp for *M. edulis*, *M. trossulus* and *M. galloprovincialis*, respectively (Inoue *et al.*, 1995). Polymerase chain reactions were carried out in 25 μ l volumes using 1 μ l (approx. 150 ng) of DNA extract (A). Reaction conditions were 2.5 mM MgCl₂, 0.2 mM dNTPs, 0.4 μ M of each primer and 5 units (0.25 μ l) of Taq Polymerase (Qiagen). PCR thermoprofile was: 3 min. initial denaturation at 94°C, followed by 40 amplification cycles (denature at 94°C (30 sec.), annealing at 56°C (30 sec.) and extension at 72°C (90 sec.)) with a final extension of 5 min. at 72°C. Amplification products were separated on a 4.5% agarose gel.

Cytochrome c oxidase subunit III (COIII: mitochondrial marker)

In order to assess the recent history within species or populations of *Mytilus*, we sequenced a 416 bp fragment of *Cytochrome c oxidase subunit III (COIII)*, a mitochondrial gene that shows high substitution rates. *Mytilus*, like other members of the Mytilidae and Unionidae (Curole and Kocher, 2002) transmits its mitochondria by means of doubly uniparental inheritance (DUI: Zouros *et al.*, 1994a,b, also known as gender associated inheritance: Skibinski *et al.*, 1994a,b). This results in two independently evolving mitochondrial lineages (termed F and M). Males possess both lineages, whereas females only possess the F-lineage. Our shell morphometric and molecular analyses were carried out without prior anatomical gender assessment. Although all the DNA extracts had to contain F-lineage mitochondria, M-lineage mitochondria were potentially present as well. At the time the lab work for this study was carried out (2003) this was a technical difficulty, because only generic or M-specific COIII primers (*M. edulis*) were available (nowadays both F- and M-specific primers are available; Śmietanka *et al.*, 2009).

To remove potentially present M-lineage COIII products, we slightly modified the nested-PCR procedure described by Stewart *et al.* (1995). Initial amplification was done with primer For1 5'-TATGTACCAGGTCCAAGTCCGTG-3' and Rev1 5'-ATGCTCTCTCTGAATATAAGCGTACC-3' using the same reaction conditions as described for *Me15/Me16*, but with an annealing temp. of 54°C and a final extension at 70°C. Amplification products were split and half of each product was digested with Mbo I, while the other half was digested with Ssp I (New England Biolabs, following manufacturer's protocol). Recognition sites for these restriction enzymes are located on the M-lineage COIII sequences of *M. edulis* and *M. trossulus*, respectively. In 2003, it was not known if M-mitotype COIII sequences of *M. galloprovincialis* possessed a recognition site for these enzymes. Digestion products were separated on a 1% agarose gel and the largest fragment of the MboI digest was extracted from the gel and purified with a Qiaquick Gel Extraction Kit (Qiagen), following manufacturer's protocol. A 1:100 dilution (MQ) of the purified product was used as a template (1 μ l) for a half nested PCR with primers For2 5'-GTAAGTCAAGCCCATAGAG-3' and Rev1. Products of this second PCR were cleaned with a Qiaquick PCR purification kit (Qiagen) and sequenced (BigDye Terminator, Applied Biosystems) in both directions, using the same primers. Sequence products were purified using AutoSeq G-50 columns (Amersham) and run on an ABI 377 sequencer (Applied Biosystems). Forward and reverse sequences were assembled and edited with Sequencher version 4.2 (Gene Codes corp.) and the resulting contig sequences were aligned manually in MacClade version 4.08 (Maddison and Maddison, 2005). A minimum spanning network was created using SplitsTree4 (Huson and Bryant, 2006).

Amplified Fragment Length Polymorphism (AFLP)

An AFLP analysis was performed after Vos *et al.* (1995) with modifications as described by De Roos (2003). Restriction-ligation reactions were performed in a single reaction at 37°C for 2 hours, in a total volume of 10 μ l containing 100 ng DNA, 1 \times T4 Ligase Buffer (Life Technology, Invitrogen), 0.05 M NaCl, 5 U EcoRI - Enzyme (New England BioLabs), 5 U MseI - Enzyme (New England BioLabs), 0.045 M bovine serum albumine (BSA, New England BioLabs), 0.2 μ M EcoRI - adapter (5'-CTCGTAGACTGCGTACC, CATCTGACGCATGGTTAA-5'), 2.0 μ M MseI -

adapter (5'-GACGATGAGTCCTGAG, TACTCAG-GACTCAT-5') and 1 U T4 - Ligase (Life Technology, Invitrogen). PCR amplifications were performed on a T-gradient thermocycler (Biometra) in two separate amplification steps. Pre-amplification PCR reactions were conducted in a 20 µl volume containing 4 µl 20 x diluted Restriction-Ligation mix, 0.5 µM EcoRI / +A primer, 0.5 µM MseI / +C primer and 15 µl AFLP Amplification Core Mix (all from Applied Biosystems), with the following temperature profile: an initial denaturation step of 2 min. at 94°C; 20 cycles with 20 sec. at 94°C, 30 sec. at 56°C, 2 min. at 72°C; followed by 2 min. at 72°C and 30 min. at 60°C. Selective amplifications were performed in a 10 µl volume (containing 1.5 µl 10x diluted Pre-amplification product, 0.05 µM Dye labelled EcoRI / +3 primer, 0.25 µM MseI / +3 primer and 7.5 µl AFLP Amplification Core Mix (all from Applied Biosystems), with the following temperature profile: an initial denaturation step of 2 min. at 94°C; 10 cycles with 20 sec. at 94°C, 30 sec. at 66°C decreasing with 1°C per cycle, 2 min. at 72°C; 25 cycles with 20

sec. at 94°C, 30 sec. at 56°C, 2 min. at 72°C; followed by 30 min. at 60°C. Selective amplifications were performed using two primer pairs EcoRI / +ACC-MseI / +CTA and EcoRI / +AAC - MseI / +CAG. Amplified fragments were analysed on a CEQ™ 8000 Genetic Analysis System (Beckman Coulter Inc. 2002). Loci with a band frequency below 5% (Beckman Coulter, 2002) were considered as potential artefacts and omitted from further analysis. Based on unpublished data on *Mytilus s.l.* from a larger area (pers. com. SR, GV), 248 fragments between 50 and 400 bp were scored as present (1) or absent (0) using the Fragment Analysis Software Module of the CEQ™ 8000 (AFLP settings: bin width = 1.0 nt; Ythreshold = 400 RFU). Gene loci that were putatively informative (non-monomorphic fragments) were assembled in a binary data matrix.

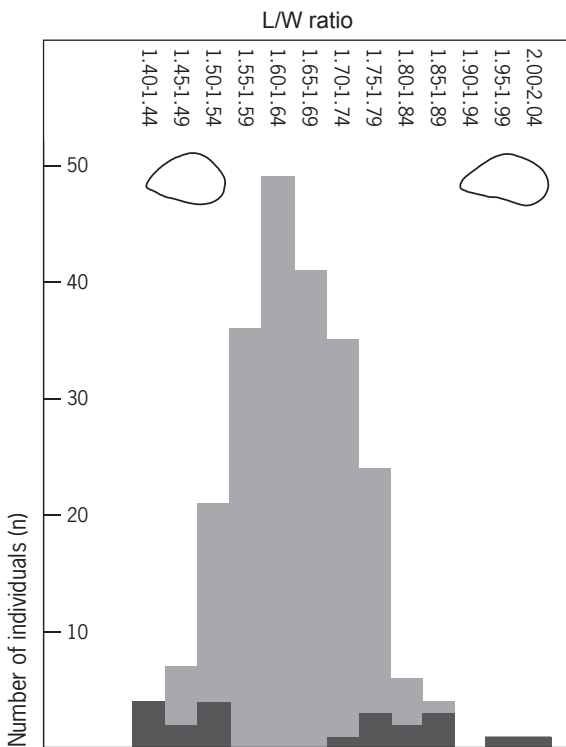

Fig. 3. L/W ratios of subadult stages in *Mytilus* shells collected from different depths along a pillar of the Zeeland Bridge. In dark are the specimens used for further analyses. The L/W ratios show a normal distribution with two outliers representing slender shells.

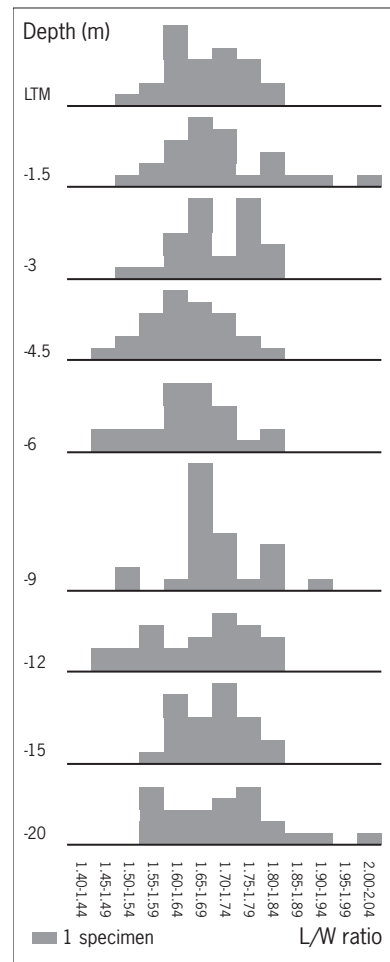

Fig. 4. L/W ratios of *Mytilus* shells from the various depths. LTM refers to lower tide mark. No trends in L/W ratios are discernible.

Statistical analysis

In order to see if the L/W ratios were distributed normally a Shapiro-Wilk test was done. To test the association between L/W ratios and depth, a univariate ANOVA (sum of squares type III) was performed in GLM (General Linear Model), in which the L/W ratios (continuous) were used as the dependent variable and depth as a covariate. A Fisher exact test was used to test for an association between L/W ratios (categorized as either slender, < 1.65 or broad, > 1.65) and COIII groups (this covariate was categorized as group A or B; see the results section). These statistical tests were performed in SPSS release 11.0.4 (SPSS, 2005).

To test for a relation between AFLP-data and L/W-ratios a Principal Component Analysis (PCA) and Correspondence Analysis (CA, Nenadic and Greenacre, 2007) were performed in R (R foundation for statistical computing, Ihaka and Gentleman, 1996). Using scatter plots, we inspected whether the two L/W-ratio categories had very different combinations of scores of the new independent variables obtained in either PCA or CA. Using logistic regression, we tested whether the scores of new variables significantly explained the probability of being either broad or not.

Results

Shell morphology

The L/W ratios of the 229 measured specimens (Fig. 3) range between 1.42 and 2.00 (mean 1.65, standard deviation 0.10). The L/W ratios are continuous with the exception of two specimens that have a slender subadult shell outline. Slender- and broad-shelled forms are connected through intermediates and the entire L/W ratio range describes an almost a perfect normal distribution (Fig. 3). After exclusion of the two just mentioned outliers, the Shapiro-Wilk test statistic becomes 0.994 and $p = 0.430$. No correlation between L/W ratios and sampling depth was observed (GLM univariate ANOVA, $F = 1.026$, $p = 0.324$); distribution of L/W ratios over different depths is illustrated by Fig. 4. The combined Verduin parameters of the studied Oosterschelde samples fall within the range of *Mytilus edulis* (Fig. 5, Table 2). The range of morphological variation of the 21 Oosterschelde shells covers a large part of the total morphological variation found by Verduin (1979) for various Western European *Mytilus edulis* populations. *Mytilus* shells from the

Zeeland Bridge show considerable morphological variation in L/W ratios as well as Verduin parameters. The latter fall within the range of *M. edulis* (Fig. 5). Hence the Verduin parameters imply that the broad morphs should be attributed to *Mytilus edulis*.

Adhesive protein gene

The *Me15/16*-PCR products for the 21 selected specimens all had a length of 180 bp and belong to *M. edulis*, following Inoue *et al.* (1997).

COIII

Digestion of the initial PCR product (primers For1 and Rev1) with MboI resulted in one fragment if only product from the F-lineage was present (or if the MboI recognition site would have been lost in the M-lineage). If next to F-lineage product, M-lineage product was present as well, three fragments were observed. Digestion of initial PCR product with SspI resulted in

Table 2. Verduin parameters. Rin denotes internal radius of hinge area. Laa denotes length of anterior adductor muscle scar (illustrated in Fig. 2B; after Verduin, 1979).

Specimen number	H (mm)	Rin (mm)	Laa (mm)	Laa/H	Rin/H	Laa/H + 1.5 Rin/H	L/H
8A	17	2	4	0.24	0.12	0.42	1.5
22A	17	1.6	4	0.24	0.09	0.38	1.78
38A	21	2	3	0.14	0.1	0.28	1.88
47A	19	1.5	5	0.26	0.08	0.38	2
52A	13	1	2	0.15	0.08	0.27	1.5
61A	21	1.75	3	0.14	0.08	0.26	1.48
81A	18	1.5	5	0.28	0.08	0.4	1.77
95A	15	1.6	4	0.27	0.11	0.43	1.73
106A	17	1.25	4	0.24	0.07	0.35	1.42
124A	20	1.75	4	0.2	0.09	0.33	1.42
128A	18	2	3	0.17	0.11	0.34	1.8
140A	21	2.25	4	0.19	0.11	0.35	1.44
162A	20	1.75	5	0.25	0.09	0.38	1.47
172A	21	2	5	0.24	0.1	0.38	1.87
196A	17	1.5	4	0.24	0.09	0.37	1.44
203A	20	2.25	5	0.25	0.11	0.42	1.78
222A	20	2.25	5	0.25	0.11	0.42	1.8
225A	20	2.4	4	0.2	0.12	0.38	1.53
247A	18	2.25	4	0.22	0.13	0.41	1.51
248A	18	1.6	5	0.28	0.09	0.41	1.98
254A	20	2	4	0.2	0.1	0.35	1.88

two fragments if *COIII* was amplified from the F-lineage, and in four fragments if it was amplified from the M-lineage. Hence products from both lineages possess an *SspI* recognition site, whereas only the M-lineage possesses a restriction site for *MboI*. Subsequent nested PCR on the largest fragment of the *MboI*-digest with primers For2 and Rev1 resulted

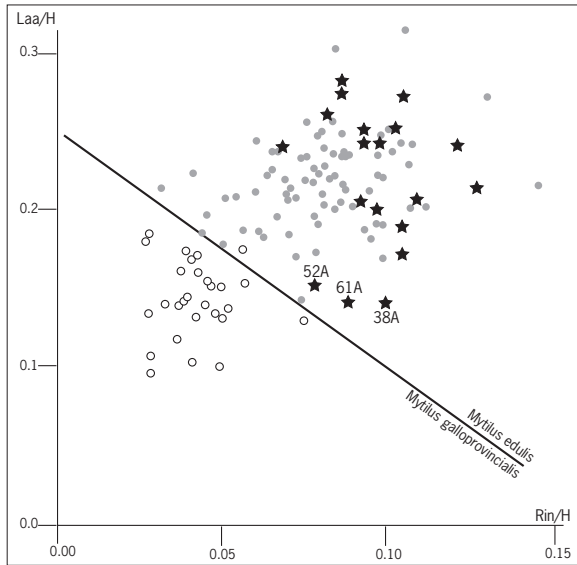

Fig. 5. Verduin characters of *Mytilus* individuals from the Zeeland Bridge (this study, stars) versus European shells (dots) analysed by Verduin (1982). Line depicts the boundary between *Mytilus galloprovincialis* (open dots) and *M. edulis* (filled grey dots): $((Laa/H) + 1.5(Rin/H) = 0.25)$. Stars denote Zeeland Bridge samples. Three specimens that are close to the *M. edulis* – *M. galloprovincialis* – boundary are tagged.

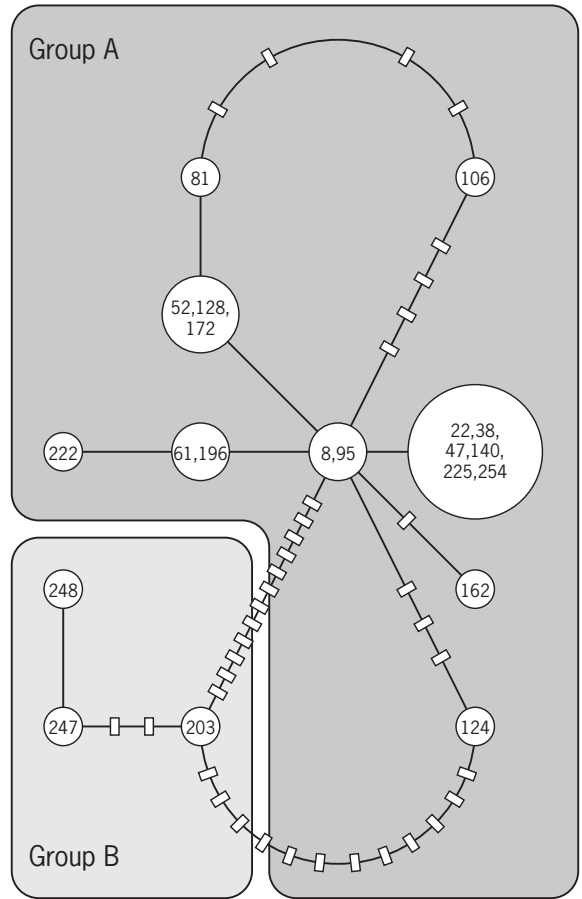

Fig. 6. Minimum Spanning Network based on *COIII* sequences. Haplotype sizes are proportional to the number of sequences. Lines between haplotypes represent one mutational step. Boxes on these lines represent additional mutational steps.

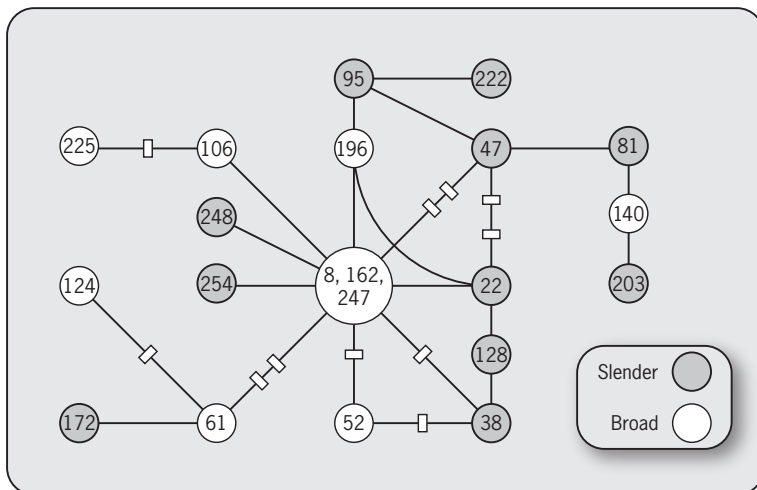

Fig. 7. Minimum Spanning Network based on AFLP-data. Haplotype sizes are proportional to the number of sequences. Lines between haplotypes represent the number of steps under the parsimony criterion. Boxes on these lines represent additional steps. The colour of the circles corresponds to the relative shell shapes (see inset).

in a 462 bp product for all specimens. A minimum spanning haplotype network (Fig. 6) was created based on the nucleotide sequences from this product (primer sites were excluded, length: 416 bp). The average uncorrected P-distance between the obtained sequences was 0.012 (standard deviation 0.011). This relatively high average can mostly be ascribed to the large distances added by the specimens 203, 247 and 248 (indicated as group B). These three specimens were separated from the most common haplotype (largest circle, Fig. 6) by 14 mutational steps or more, whereas all other specimens (group A) were separated from this haplotype by 6 mutational steps or less. If the sequences from group B are excluded, the average uncorrected P-distance decreases to 0.007 (standard deviation 0.006). All substitutions were synonymous and the largest uncorrected P-distance was 0.036 (between 203 and 81, 162 and 222). No association between L/W ratio and COIII groups A and B could be shown (Fisher's exact test, p (2-sided) = 1.000). Sequences were deposited in GenBank (accession numbers DQ353870–DQ353890).

AFLP

Of the 248 putative gene loci that were scored, only 13 were non-monomorphic, indicative of a homogeneous population. Only the first four principal components each explained more than 10% of the total variation in the AFLP sample. Cumulatively these four principal components explained 72% of the total variance. In the correspondence analysis, only the first two principal inertias explain more than 10% of the summed inertias, cumulatively they contribute 61%. Both the PCA and CA scatter plots (results not shown) suggested some separation in L/W groups based on the AFLP-data, but always with an intricate dependence on the scores. Backward model selection using likelihood ratio tests, showed that none of the principal components or none of the coordinates of the principal inertias significantly explained the variation in L/W ratios. Therefore we decided to depict the AFLP results by means of a minimal spanning network (Fig. 7, SplitsTree4, Huson and Bryant, 2006), which more clearly illustrates the lack of separation of L/W groups. Also Fig. 7 shows a single population in which slender-shelled specimens (L/W ratio > 1.65; represented by grey circles) and broad-shelled specimens (L/W ratio < 1.65; represented by white circles) are connected repeatedly by only a single step.

Discussion

The combined Verduin parameters and molecular data (Table 3) show that the analysed *Mytilus* specimens from the Zeeland Bridge should be attributed to *Mytilus edulis*. Three specimens (38, 52 and 61) have Verduin parameter values that lie within the *M. edulis* range, but are close to the *M. edulis* - *M. galloprovincialis* border (Fig. 5). None of the other datasets (*Me15/16* and the minimum spanning networks based on *COIII* sequences and AFLP-data) indicate that these specimens are any different from the remainder eighteen.

As for the molecular datasets, *Me15/16* unanimously shows the presence of *M. edulis* and does not indicate potential *M. edulis* - *M. galloprovincialis* hybrids, let alone 'pure' *M. galloprovincialis*. The AFLP data show a random distribution of morphotypes over the network (Fig. 7). Only the network based on *COI*-

Table 3. Morphometric and molecular data of fully analysed mussels. Depth below low tide mark. VI denotes identity as inferred from Verduin parameters. E denotes *Mytilus edulis*. 'A' and 'B' refer to two groups of haplotypes (see text) based on *COIII*. The columns for MboI and SspI denote the number of fragments after digestion of the PCR product obtained with primers For1 and Rev1.

Specimen number	Depth	L/W	VI	Me 15-16	MboI	SspI	AFLP	COIII
106A	4.5 m	1.42	E	180 bp 3	4	E	A	
124A	6 m	1.42	E	180 bp 1	2	E	A	
140A	6 m	1.44	E	180 bp 3	4	E	A	
196A	12 m	1.44	E	180 bp 1	2	E	A	
162A	9 m	1.47	E	180 bp 1	2	E	A	
61A	3 m	1.48	E	180 bp 3	4	E	A	
8A	0 m	1.5	E	180 bp 1	2	E	A	
52A	1.5 m	1.5	E	180 bp 3	4	E	A	
247A	20 m	1.51	E	180 bp 1	2	E	B	
225A	15 m	1.53	E	180 bp 1	2	E	A	
95A	3 m	1.73	E	180 bp 1	2	E	A	
81A	3 m	1.77	E	180 bp 3	4	E	A	
22A	0 m	1.78	E	180 bp 1	2	E	A	
203A	12 m	1.78	E	180 bp 1	2	E	B	
128A	6 m	1.8	E	180 bp 3	4	E	A	
222A	15 m	1.8	E	180 bp 3	4	E	A	
172A	9 m	1.87	E	180 bp 3	4	E	A	
38A	1.5 m	1.88	E	180 bp 3	4	E	A	
254A	20 m	1.88	E	180 bp 3	2	E	A	
248A	20 m	1.98	E	180 bp 1	2	E	B	
47A	1.5 m	2	E	180 bp 3	4	E	A	

II sequences (Fig. 6) points to the presence of more than a single group; group B contains the haplotypes obtained from specimens 203, 247 and 248 and group A contains nine other haplotypes. All haplotypes in group A are within six mutational steps from the main haplotype (Fig. 6). At least fourteen steps separate the haplotypes of group B from the main haplotype. A BLAST-search (<http://blast.ncbi.nlm.nih.gov/Blast.cgi>) showed that sequence DQ353885 (specimen 203, group B) was most similar to F-lineage *COIII* sequences of specimens identified as either *M. galloprovincialis* (from Greece and the Black Sea: accession numbers DQ403170, AY130171, AY130172, AY130174, DQ445474 and DQ445468) or *M. edulis* (from Ireland and France, accession numbers AY130154 and AY130161). Śmietanka *et al.* (2009) also obtained partial *COIII* sequences for *Mytilus* sp. with a reasonable coverage of the entire European coast, including the Westerschelde. Hence we expected that sequences from this study would be most similar to those of Śmietanka *et al.* This was not the case, due to the fact that the forward primer used by Śmietanka *et al.* (5'-TCTTGGTACAACACTGCGGGAA-3', Skibinski *et al.*, 1994b) is located ca. 115 bp downstream from For2. A BLAST-search with only the overlapping part (301 bp) of sequences from this study and that of Śmietanka *et al.* (2009), indeed shows that sequence DQ353885 (specimen 203) is most similar to sequence FJ549913 from the Westerschelde. A minimum spanning network based on the 21 *COIII* sequences obtained with this study and the additional 26 *COIII* sequences of Śmietanka *et al.* (network not depicted) reveals seven additional haplotypes. Nevertheless, all of these haplotypes are within six mutational steps from either the main haplotype of group A or B. Based on these results we have no indication for the presence of more than two groups of haplotypes in the Dutch delta region. Since in our Oosterschelde material *Me15/16* shows no indication for hybridisation and the AFLP-results do not indicate more than a single population, we assume incomplete lineage sorting (ancestral polymorphism) is a more plausible explanation for these *COIII* results, than introgression.

Despite the presence of two distinct groups (A and B, Fig. 6) of *COIII* haplotypes in our material, all molecular results indicate that the Oosterschelde mussels belong to a single population of *Mytilus edulis*. This also corresponds to our identifications based on the Verduin parameters. The existence of broad-shelled *M. edulis* and the lack of *M. galloprovincialis* in the Oosterschelde, makes it for now impossible to estab-

lish the identity of similar broad-shelled *Mytilus* shells from Eemian (Late Quaternary) deposits of the North Sea Basin. Moreover it shows that merely the relative width (L/W ratio) of broad-shelled mytilids, is not sufficient to discriminate between *M. edulis* and *M. galloprovincialis*. We call for further studies using molecular analyses to investigate the ability of Verduin parameters to discriminate between *M. edulis* and *M. galloprovincialis* shells.

Whether the taxonomic units, jointly known as the *Mytilus* species complex, are distinct enough to merit full specific status has been a matter of debate since the 1860s (Gosling, 1992). The choice of species concept is of importance in such discussions. Nowadays it becomes common practice to refer to 'pure' *M. edulis* and 'pure' *M. galloprovincialis* solely based on genetic characters (Kijewski *et al.*, 2009) and species are 'taxonomically identified' by the length of PCR products (Śmietanka *et al.*, 2009), regardless of the morphology (shell shape, colouration of periostracum and mantle, etc.) that was classically used to distinguish *Mytilus* species.

In the fossil shells, the Verduin parameters could not be established due to wear of critical characters (adductor scars). Furthermore, the attribution of extant mussels to *M. galloprovincialis* as proposed by Verduin (1979) still needs to be validated in populations by molecular data. All of the specimens from the Oosterschelde (this study), including broad-shelled ones (low L/W ratio), were attributed to *M. edulis* based on the Verduin parameters.

Conclusion

Based on an assessment and comparison between shell-morphological and molecular characteristics from single mussel specimens (*Mytilus* sp.) collected along a depth profile in the Oosterschelde we conclude that:

- (1) broad-shelled specimens from this location (identified by low L/W ratios) do not belong to *Mytilus galloprovincialis*, but instead all of the analysed Oosterschelde specimens (both slender and broad-shelled) must be attributed to *M. edulis*.
- (2) based on *COIII* sequence data, two groups of haplotypes can be discerned, whereas *Me15/16* and AFLP data do not show any structure within this mussel population.
- (3) there is no association between L/W ratio (broad- or slender-shelled specimens) and the depth at which specimens were collected.

- (4) there is no association between the two *COIII* haplotype groups and shell morphological variation (*COIII* haplotype groups and L/W ratios are independent variables, whereas the Verduin parameters indicate only a single group: *M. edulis*).
- (5) due to the existence of broad-shelled *M. edulis* (low L/W ratio), we cannot use the L/W ratio to classify similar broad-shelled specimens from Late Quaternary (Eemian) deposits of the North Sea Basin as either *M. edulis* or *M. galloprovincialis*.

Acknowledgements

We want to thank Dr. T. van Dooren, Prof. Dr. G. Vermeij and an anonymous reviewer for their suggestions to improve this manuscript. We are especially grateful to Dr. T. van Dooren for his help with the analyses in R. Furthermore we thank Dr. K. Vrieling for comments on an earlier version of this manuscript. Part of this study was supported by the European Committee (Research Directorate General, Environmental Program Marine Ecosystems) through BIOCOSME project (contract EVK3-2001-00146).

References

- Akester RJ, Martel AL. 2000. Shell shape, dysodont tooth morphology, and hinge-ligament thickness in the bay mussel *Mytilus trossulus* correlate with wave exposure. *Canadian Journal of Zoology* 78: 240-253.
- Beckman Coulter. 2002. *CEQ 8000 Genetic Analysis System User's Guide*. Fullerton, California (USA): Beckman Coulter Inc.
- Curole JP, Kocher TD. 2002. Ancient sex-specific extension of the Cytochrome c Oxidase II gene in bivalves and the fidelity of doubly uniparental inheritance. *Molecular Biology and Evolution* 19: 1323-1328.
- De Roos K. 2003. *CEQ™ 8000 AFLP Protocol*. Mijdrecht: Beckman Coulter Netherlands BV.
- Entrop B. 1965. *Schelpen vinden en herkennen*. Zutphen: Thieme.
- Filipowicz M, Burzyjski A, Śmietanka B, Wenne R. 2008. Recombination in Mitochondrial DNA of European Mussels *Mytilus*. *Journal of Molecular Evolution* 67: 377-388. doi: 10.1007/s00239-008-9157-6
- Gardner JPA. 1992. *Mytilus galloprovincialis* (Lmk) (Bivalvia, Mollusca): the taxonomic status of the Mediterranean mussel. *Ophelia* 35: 219-243.
- Gosling EM. 1992. Systematics and geographic distribution of *Mytilus*. Pp. 1-20 in Gosling EM, ed., *The mussel Mytilus: ecology, physiology, genetics and culture*. Amsterdam: Elsevier.
- Gould AA. 1851. The following shells from the United States Exploring Expedition were described by Dr Gould. *Proceedings of the Boston Society of Natural History* 3: 343-348.
- Hilbish TJ, Carson EW, Plante JR, Weaver LA, Gilg MR. 2002. Distribution of *Mytilus edulis*, *M. galloprovincialis*, and their hybrids in open-coast populations of mussels in southwestern England. *Marine Biology* 140:137-142.
- Huson DH, Bryant D. 2006. Application of Phylogenetic Networks in Evolutionary Studies. *Molecular Biology and Evolution* 23: 254-267.
- Ihaka R, Gentleman R. 1996. R: A language for data analysis and graphics. *Journal of Computational and Graphical Statistics* 5: 299-314.
- Innes DJ, Bates JA. 1999. Morphological variation of *Mytilus edulis* and *Mytilus trossulus* in eastern Newfoundland. *Marine Biology* 133: 691-699.
- Inoue K, Waite JH, Matsuoka M, Odo S, Harayama S. 1995. Interspecific variations in adhesive protein sequences of *Mytilus edulis*, *M. galloprovincialis*, and *M. trossulus*. *The Biological Bulletin* 189: 370-375.
- Inoue K, Odo S, Noda T, Nakao S, Takeyama S, Yamaha E, Yamazaki S, Harayama, S. 1997. A possible hybrid zone in the *Mytilus edulis* complex in Japan revealed by PCR markers. *Marine Biology* 128: 91-95.
- Jaziri H, Sbabou L. 2003. Variabilité morphologique et systématique de la moule méditerranéenne *Mytilus galloprovincialis* Lmk. (Bivalvia, Mytilidae) au Maroc. *Halietis* 32: 61-72.
- Kijewski T, Wijsman JWM, Hummel H, Wenne R. 2009. Genetic composition of cultured and wild mussels *Mytilus* from The Netherlands and transfers from Ireland and Great Britain. *Aquaculture* 287: 292-296.
- Koehn RK. 1991. The genetics and taxonomy of species in the genus *Mytilus*. *Aquaculture* 94: 125-145.
- Lamarck JBPA de Monet de. 1819. *Histoire Naturelle des Animaux sans Vertèbres*, VI (1). Chez l'auteur, Paris.
- Linné C. 1758. *Systema Naturae per Regna Tria Naturae, Secundum Classes, Ordines, Genera, Species, cum Characteribus, Differentiis, Synonymis, Locis*. Tomus I. Editio Decima, Reformata. Laurentii Salvii, Holmiae, Stockholm.
- Luttikhuisen PC, Koolhaas A, Bol A, Piersma T. 2002. *Mytilus galloprovincialis*-type foot-protein-1 alleles occur at low frequency among mussels in the Dutch Wadden Sea. *Journal of Sea Research* 48: 241-245.
- Maddison DR, Maddison, WP. 2005. *MacClade 4.08*. Sunderland, Massachusetts: Sinauer Associates.
- McDonald JH, Seed R, Koehn RK. 1991. Allozymes and morphometric characters of three species of *Mytilus* in the Northern and Southern Hemispheres. *Marine Biology* 111: 323-333.
- Nenadic O, Greenacre M. 2007. Correspondence analysis in R, with two- and three-dimensional graphics: The ca package. *Journal of Statistical Software* 20 (3).
- Pulteney R. 1799. *Catalogue of the birds, shells, and some of the more rare plants of Dorsetshire*. London: Nichols.
- Quesada H, Beynon CM, Skibinski DOF. 1995. A mitochondrial DNA discontinuity in the mussel *Mytilus galloprovincialis* Lmk: Pleistocene vicariance biogeography and secondary intergradation. *Molecular Biology and Evolution* 12: 521-524.
- Rawson PD, Hilbish TJ. 1998. Asymmetric introgression of mitochondrial DNA among European populations of blue mussels (*Mytilus* spp.). *Evolution* 52: 100-108.

- Rawson PD, Agrawal V, Hilbish TJ. 1999. Hybridization between the blue mussels *Mytilus galloprovincialis* and *M. trossulus* along the Pacific coast of North America evidence for limited introgression. *Marine Biology* 134: 201-211.
- Riginos C, Sukhdeo K, Cunningham CW. 2002. Evidence for selection at multiple allozyme loci across a mussel hybrid zone. *Molecular Biology and Evolution* 19: 347-351.
- SanJuan A, Zapata C, Alvarez G. 1994. *Mytilus galloprovincialis* and *M. edulis* on the coasts of the Iberian peninsula. *Marine Ecology Progress Series* 113: 131-146.
- SanJuan A, Zapata C, Alvarez G. 1997. Genetic differentiation in *Mytilus galloprovincialis* Lmk. throughout the world. *Ophelia* 47: 13-31.
- Seed R. 1968. Factors influencing shell shape in the mussel *Mytilus edulis*. *Journal of the Marine Biology Association of the United Kingdom* 48: 561-584.
- Skibinski DOF, Gallagher C, Beynon M. 1994a. Mitochondrial DNA inheritance. *Nature* 368: 817-818.
- Skibinski DOF, Gallagher C, Beynon M. 1994b. Sex-limited mitochondrial DNA transmission in the marine mussel *Mytilus edulis*. *Genetics* 138: 801-809.
- Śmietanka B, Burzynski A, Wenne R. 2009. Molecular population genetics of male and female mitochondrial genomes in European mussels *Mytilus*. *Marine Biology* 156: 913-925. doi: [10.1007/s00227-009-1137-x](https://doi.org/10.1007/s00227-009-1137-x)
- SPSS. 2005. SPSS for Mac OS X. Release 11.0.4. Chicago: SPSS Inc.
- Stewart DT, Saavedra C, Stanwood RR, Ball AO, Zouros E. 1995. Male and female mitochondrial DNA lineages in the Blue Mussel (*Mytilus edulis*) species group. *Molecular Biology and Evolution* 12: 735-747.
- Verduin A. 1979. Conchological evidence for the separate specific identity of *Mytilus edulis* L. and *M. galloprovincialis* Lmk. *Basteria* 43: 61-80.
- Vos P, Hogers R, Bleeker M, Reijans M, van de Lee T, Hornes M, Frijsters A, Pot J, Peleman J, Kuiper M, Zabeau M. 1995. AFLP: a new technique for DNA fingerprinting. *Nucleic Acids Research* 23: 4407-4414.
- Zouros E, Ball AO, Saavedra C, Freeman KR. 1994a. Mitochondrial DNA inheritance. *Nature* 368: 818.
- Zouros E, Ball AO, Saavedra C, Freeman KR. 1994b. An unusual type of mitochondrial DNA inheritance in the blue mussel *Mytilus*. *Proceedings of the National Academy of Sciences of the United States of America* 91: 7463-7467.

Received: 2 April 2010

Revised and accepted: 15 November 2010

Published online: 18 March 2011

Editor: M. Schilthuisen