

JOINING OF SILICON CARBIDE THROUGH THE DIFFUSION BONDING APPROACH

Michael C. Halbig
Army Research Laboratory, NASA Glenn Research Center
Cleveland, OH, USA

Mrityunjay Singh
Ohio Aerospace Institute, NASA Glenn Research Center
Cleveland, OH, USA

ABSTRACT

In order for ceramics to be fully utilized as components for high-temperature and structural applications, joining and integration methods are needed. Such methods will allow for the fabrication the complex shapes and also allow for insertion of the ceramic component into a system that may have different adjacent materials. Monolithic silicon carbide (SiC) is a ceramic material of focus due to its high temperature strength and stability. Titanium foils were used as an interlayer to form diffusion bonds between chemical vapor deposited (CVD) SiC ceramics with the aid of hot pressing. The influence of such variables as interlayer thickness and processing time were investigated to see which conditions contributed to bonds that were well adhered and crack free. Optical microscopy, scanning electron microscopy, and electron microprobe analysis were used to characterize the bonds and to identify the reaction formed phases.



JOINING OF SILICON CARBIDE THROUGH THE DIFFUSION BONDING APPROACH

Michael C. Halbig¹ and Mrityunjay Singh²

1 - U.S. Army Research Laboratory, Vehicle Technology Directorate, Cleveland, Ohio

2 - Ohio Aerospace Institute, Cleveland, OH



VEHICLE TECHNOLOGY DIRECTORATE



33rd International Conference and Exposition on Advanced Ceramics and Composites
Daytona Beach, FL, Dec. 18-23, 2009.



Outline

- **Motivation and Application** – Micro-Electro-Mechanical Systems Lean Direct Injector (MEMS LDI) for Advanced Aircraft Gas Turbines
- **Joint Processing** - Diffusion Bonding With a Titanium Interlayer
- **Characterization** – Optical Microscopy, SEM, Microprobe
- **Near Term Plans** – Subcomponent Fabrication Issues and Further Diffusion Bond Optimization
- **Summary and Conclusions**



Motivation

Improve Ceramic to Ceramic and Ceramic to Metal Joining Methods

- allow for the fabrication of complex shapes and structures.
- allow for easier integration of ceramics components into engine systems.

(Ceramics can be either monolithics or fiber reinforced composites).

Examples of Component Applications Benefiting from Joining Technology

– components for aeronautic and ground based engine applications (i.e. ceramic turbine vanes, blades, injectors, rotors, combustor liners, valves, and heat shields) and fusion reactor components, optical space components, and bi-layer armor.

Benefits – simplified component fabrication, enabling technology, increased operating temperatures, improved efficiency, and reduced cooling requirements.

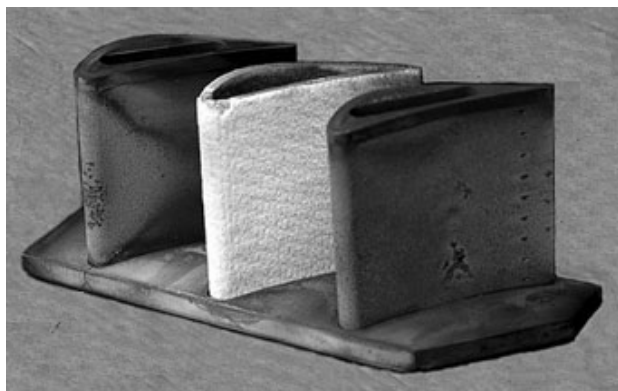

Fabrication of Lean Direct Injector Components by Diffusion Bonding of SiC Laminates

SiC laminates can be used to create intricate and interlaced passages to speed up fuel-air mixing to allow lean-burning, ultra-low emissions

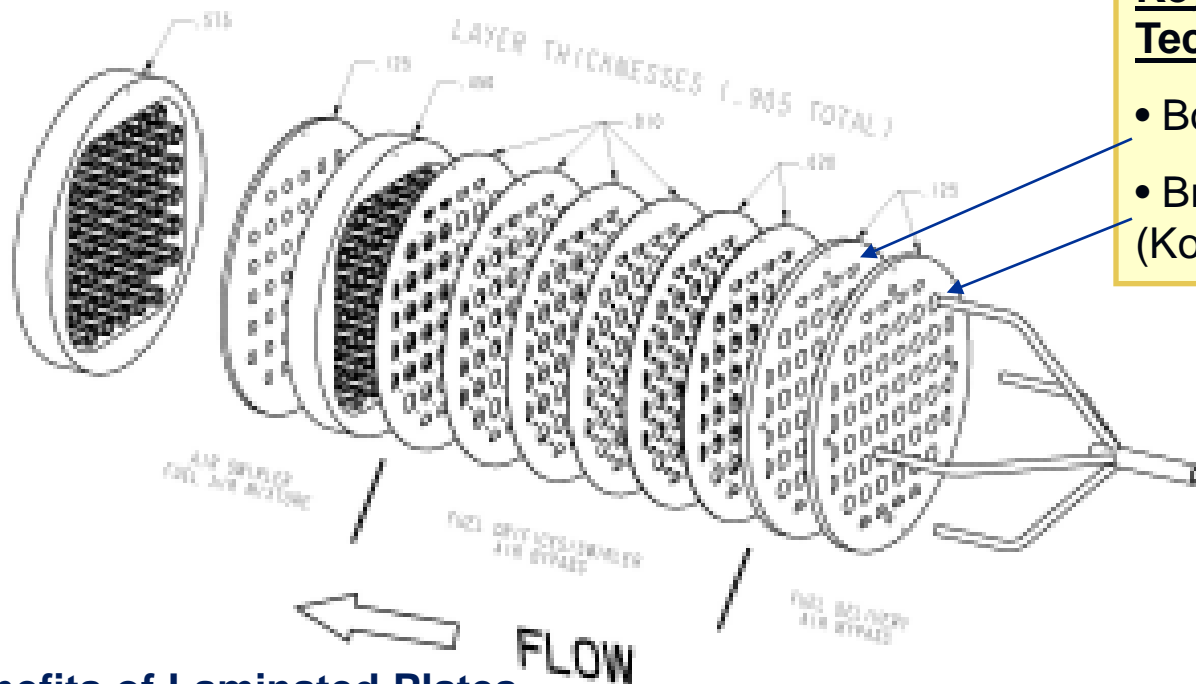

Key Enabling Technologies:

- Bonding of SiC to SiC
- Brazing of SiC to Metallic (Kovar) Fuel Tubes

Benefits of Laminated Plates

- Passages of any shape can be created to allow for multiple fuel circuits
- Provides thermal protection of the fuel to prevent choking
- Low cost fabrication of modules with complicated internal geometries through chemical etching



Current Approach of Joining SiC With a Ti Layer

Advantages of Diffusion Bonding Using a Ti Layer

- Uniform Ti layers can be applied
- Ti can be applied by different methods (foil, PVD and other coating approaches)
- High strength and leak-free bonds
- Good high temperature stability

The objective is to develop joining technology that has the following capabilities necessary for the injector application:

- Joining of relatively large geometries (i.e. 4" diameter discs)
- Leak-free at an internal pressure of 200 psi (1.38 MPa)
- Stability and strength retention at 800°F (427°C)

Polished Cross-Section of Alloyed Ti Foil (as-received)

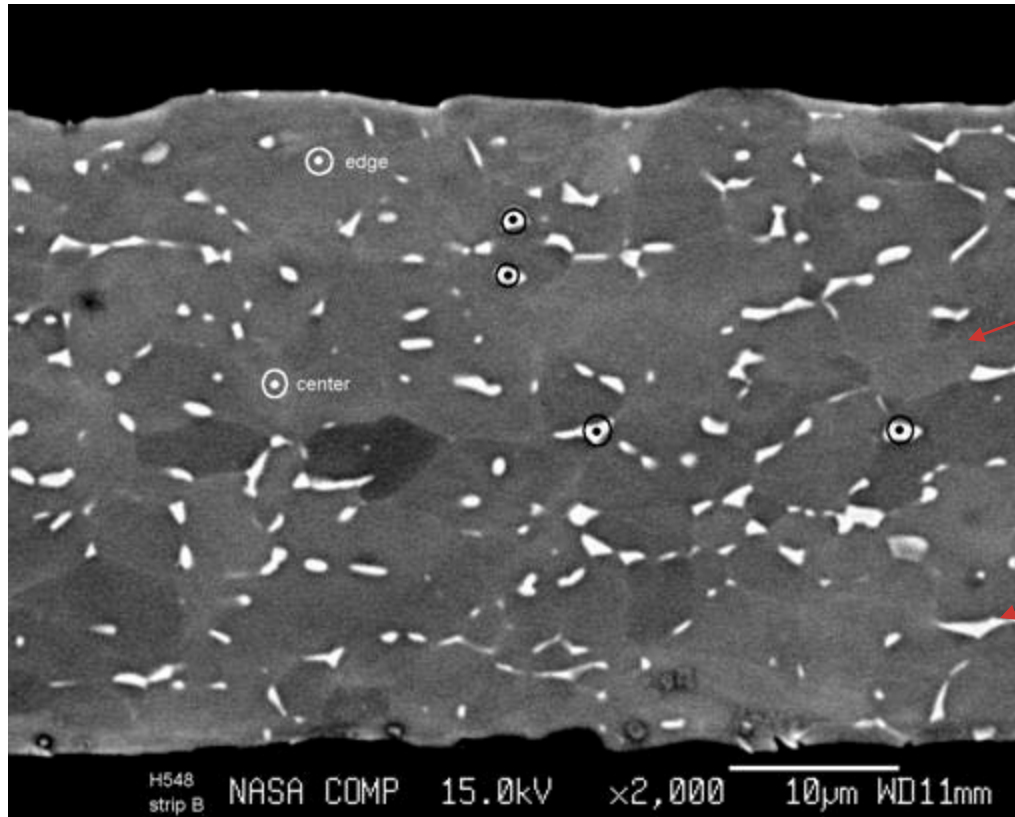

Ti-6Al-4V (weight %)

Grey phase – Alpha alloy

White phase – Beta alloy

Microprobe from the cross-section of alloyed Ti foil (averages taken from several points near the edge and at the center of the foil)

	Phase	Al	Fe	Ti	V	Total
Atomic Ratio	Grey Phase	10.196	0.042	86.774	2.988	100.000
Weight (%)	Grey Phase	5.999	0.051	90.632	3.318	100.000
Atomic Ratio	White Phase	4.841	1.850	76.507	16.803	100.000
Weight (%)	White Phase	2.748	2.172	77.084	17.997	100.000

Bonding with the Alloyed Ti Foil Between Different SiC Substrates

TREX CVD SiC

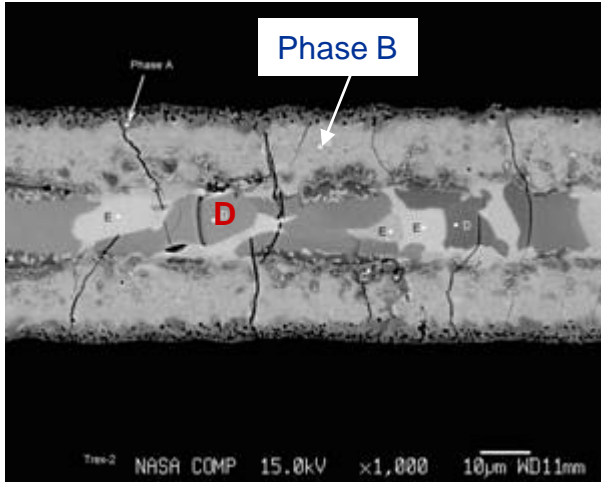

CRYSTAR α -SiC

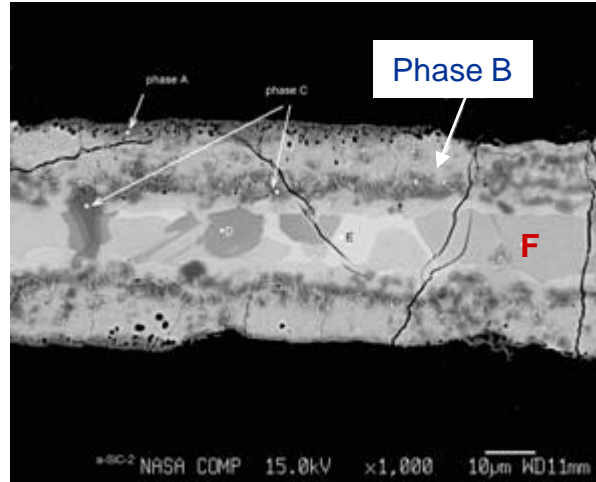

Rohm & Haas CVD SiC

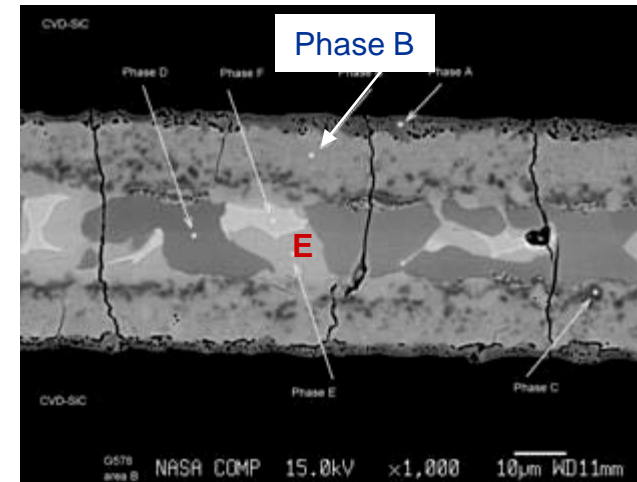

Microcracks formed regardless of the substrate and variations in the processing: higher temperatures, higher pressures, slower cooling rate.

Microcracking may be due to thermal stresses during cooling down from processing:

- Phase B (same in all three micrographs) - $Ti_5Si_3C_x$ (Ti_5Si_3) is highly anisotropic in its thermal expansion where $CTE(c)/CTE(a) = 2.72$ (Schneibel et al).
- Central core of diffusion bond has concentrated alpha and beta Ti alloy phases. The alpha phase has an anisotropic thermal expansion which is 20 % greater along the c-axis (Boyer, Welsch, and Colling). Also, the beta phase has a thermal expansion that is 6 x higher in the temperature range of 600-1000°C ($5.8 \times 10^{-5}/^\circ C$) compared the thermal expansion below 600°C ($9.2 \times 10^{-6}/^\circ C$) (Elmer et al).

Diffusion Bonds from Using PVD Ti as the Interlayer

20 Micron Ti Interlayer

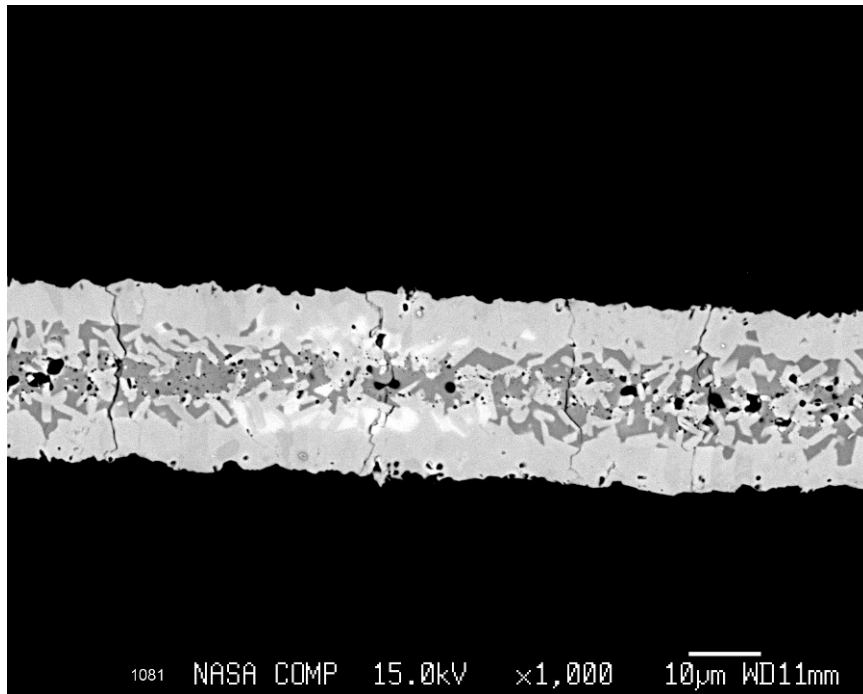

10 Micron Ti Interlayer

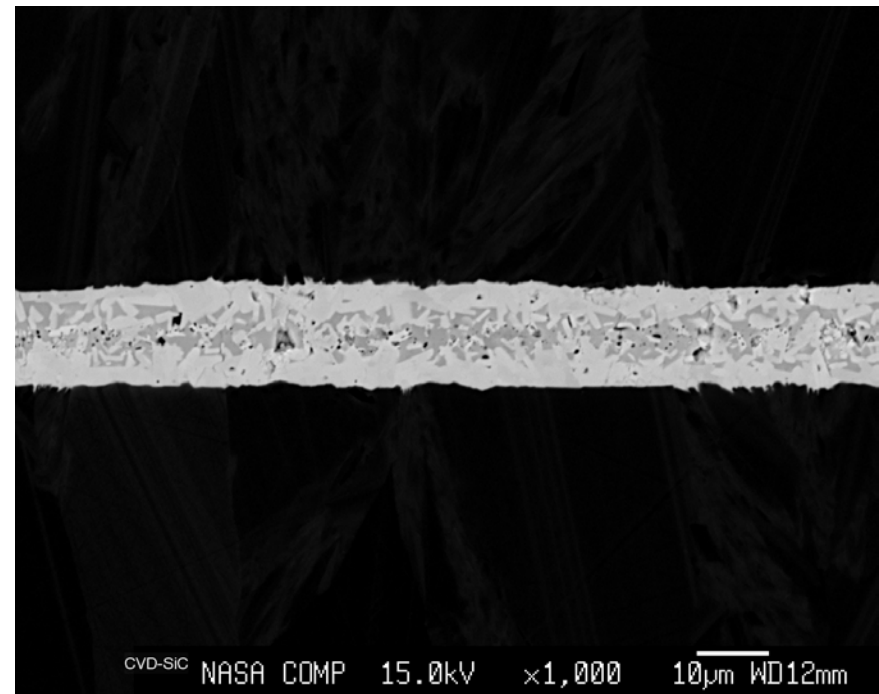

Diffusion Bonds from Using PVD Ti as the Interlayer

20 Micron Ti Interlayer

Microcracking is still present due to the presence of $Ti_5Si_3C_x$.

Naka et al suggest that this is an intermediate phase.

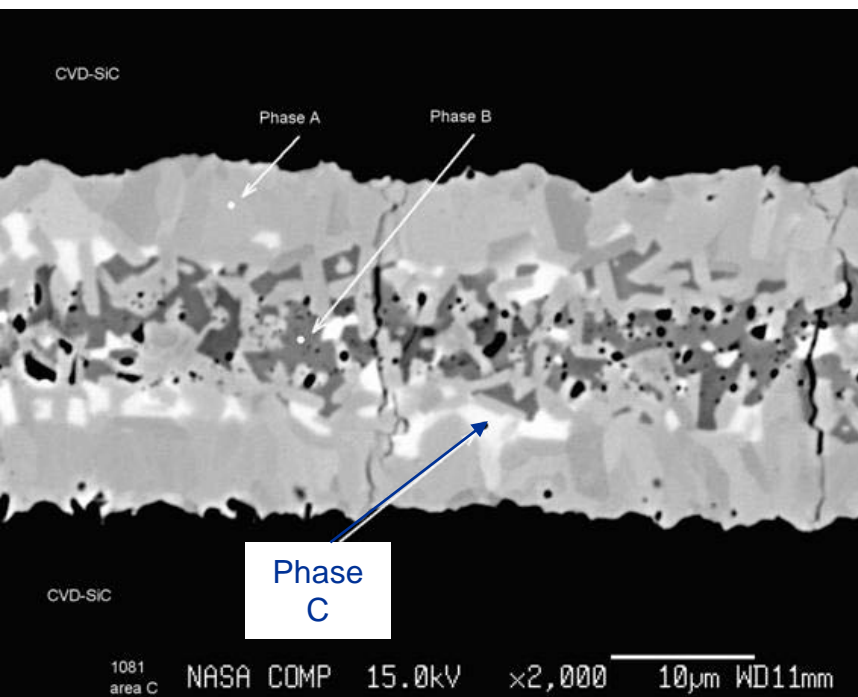

Phases in bond with the 20 μ Ti Interlayer – Atomic Ratios

Phase	Ti	Si	C
Phase A	56.426	17.792	25.757
Phase B	35.794	62.621	1.570
Phase C	58.767	33.891	7.140

10 Micron Ti Interlayer

No microcracking or phase of $Ti_5Si_3C_x$ is present.

Thin interlayers of pure Ti down-selected as the preferred interlayer.

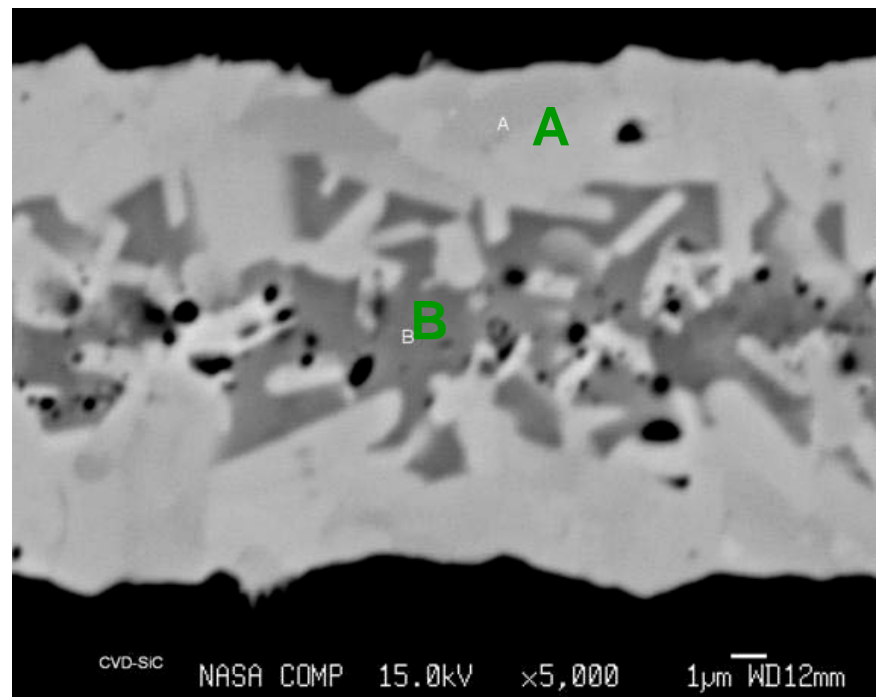

Phases in bond with the 10 μ Ti Interlayer – Atomic Ratios

Phase	Ti	Si	C
SiC	0.011	54.096	45.890
Phase A	56.621	18.690	24.686
Phase B	35.752	61.217	3.028

The Phases of Ti-Si-C and the Intermediate Phase of Ti_5Si_3

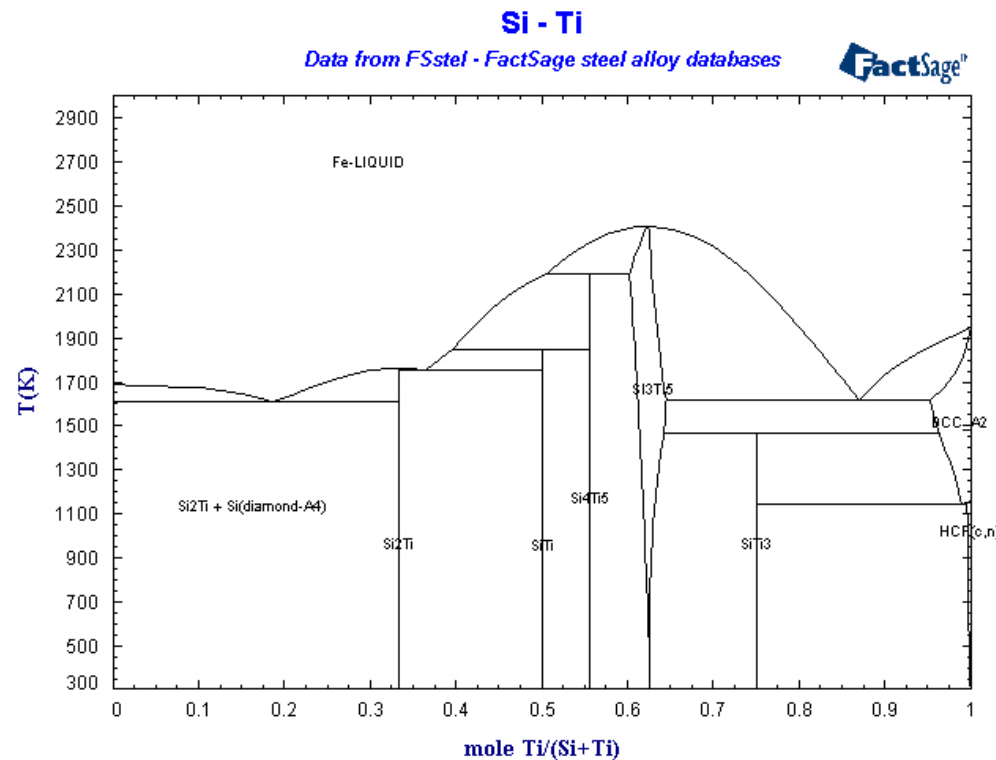
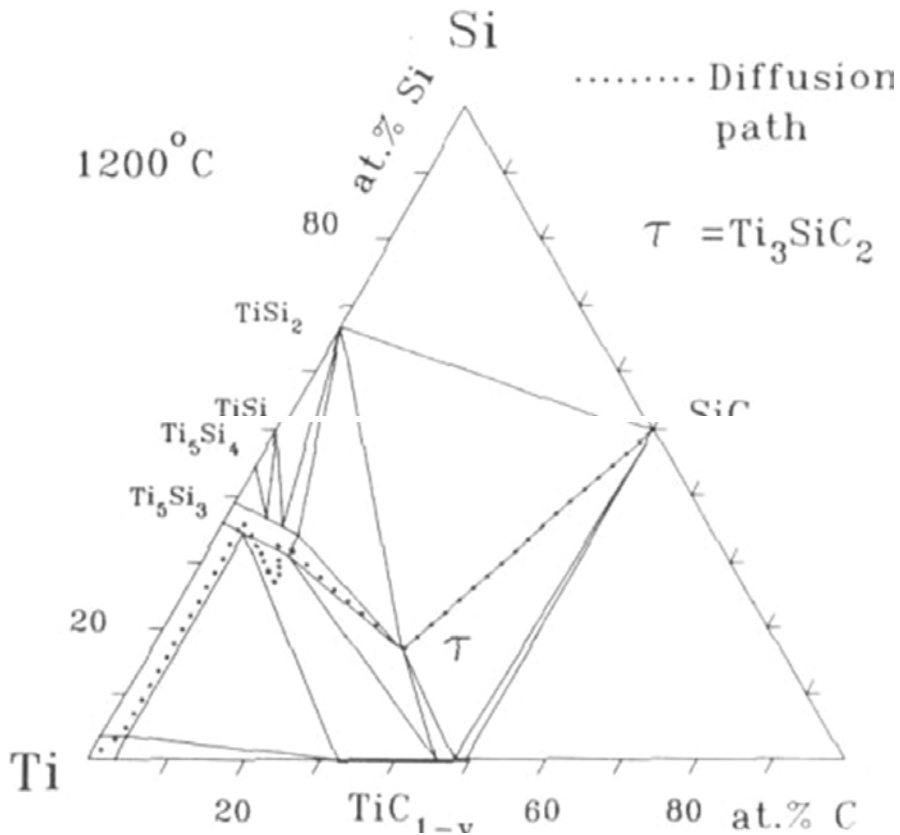

An isothermal section of the Ti-Si-C phase diagram at 1200°C. The diffusion path is denoted by the dotted line. SiC/Ti₃SiC₂/Ti₅Si₃/two-phase Ti₅Si₃ plus TiC_{1-y}/Ti₅Si₃/Ti

F. Goesmann and R. Schmid-Fetzer, Semicond. **Sd. Technol.** 10 (1995) 1652-1658.



Effect of Ti Foil Thickness and Processing Time on the Resulting Diffusion Bonds - second processing matrix investigated

The following conditions were investigated:

- 10 micron foil at 2 hr
- 20 micron foil at 1, 2, and 4 hr
- 50 micron foil at 1, 2, 4, 8 and 16 hr

* all other conditions are the same as before: 1250 °C, 30 MPa applied pressure, vacuum, 2 °C /min cool down

However, the processing temperature may have actually been as high as 1400 °C for all bonds.



SiC Substrates Joined with a 10 μm Ti Foil Interlayer for 2 hr

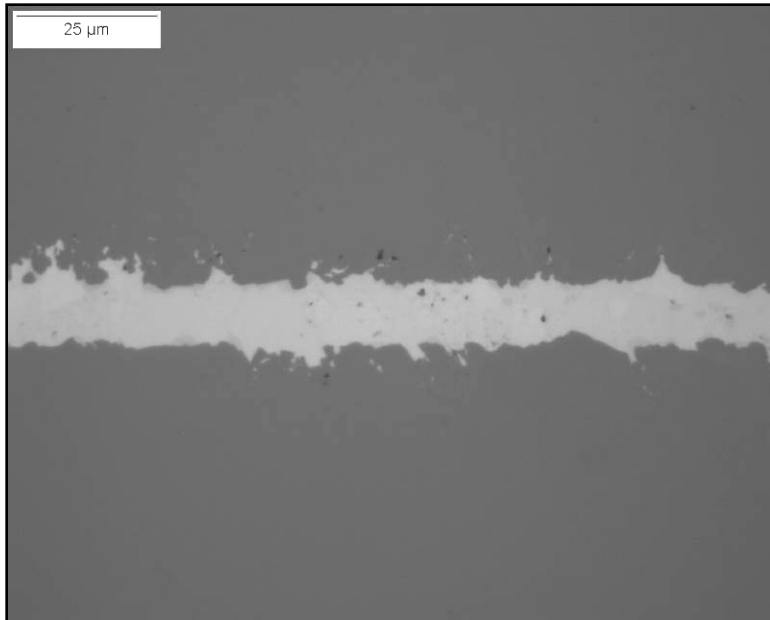

Similar results to the diffusion bond formed with a 10 micron thick PVD Ti coating

- no microcracks

SEM of SiC Substrates Joined with a 10 μm Ti Foil Interlayer for 2 hr

Center of the Bond Line

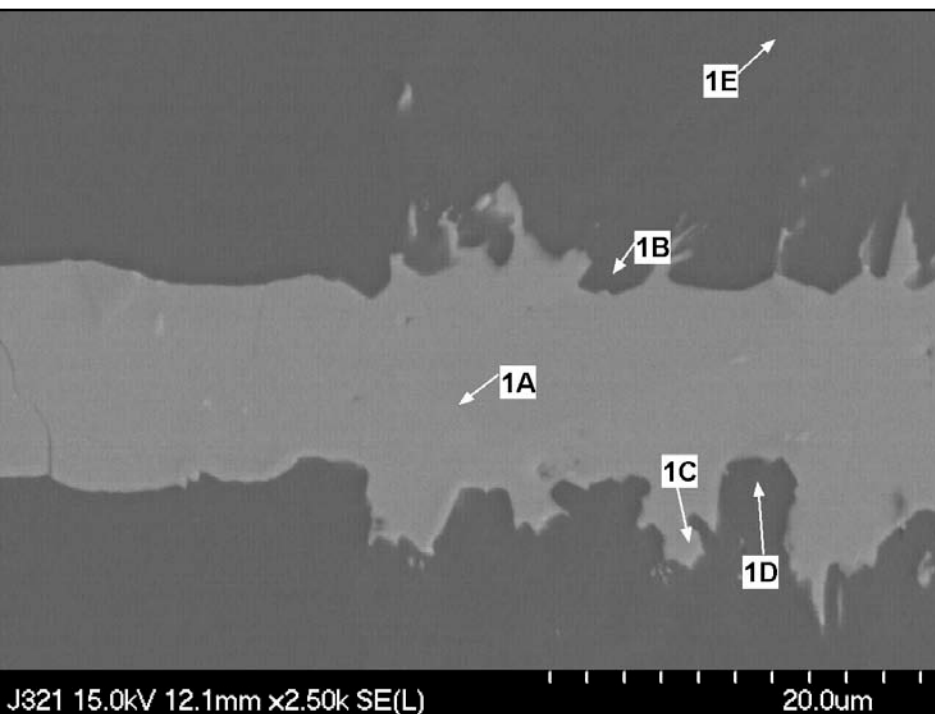

Near and at the Edge

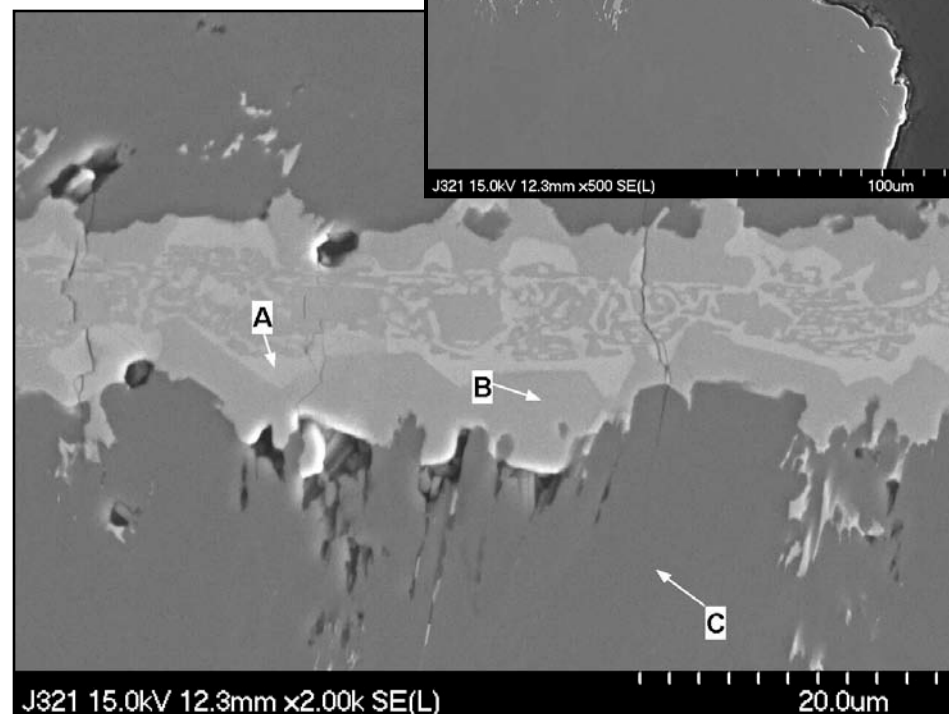

Phases in atomic %

1A and 1C – C 49.7, Si 13.5, Ti 36.8

1B, 1D and 1E – C 56.8, Si 43.2

Phases in atomic %

A – C 50.2, Si 11.9, Ti 35.3, Fe 2.6

B – C 56.3, Ti 43.7

C – C 54.5, Si 45.5

SiC Substrates Joined with a 20 μm Ti Foil Interlayer

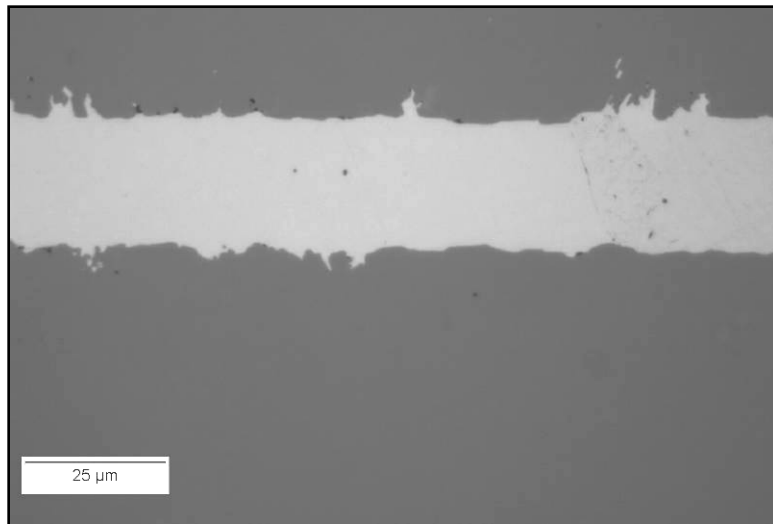

1 hr.

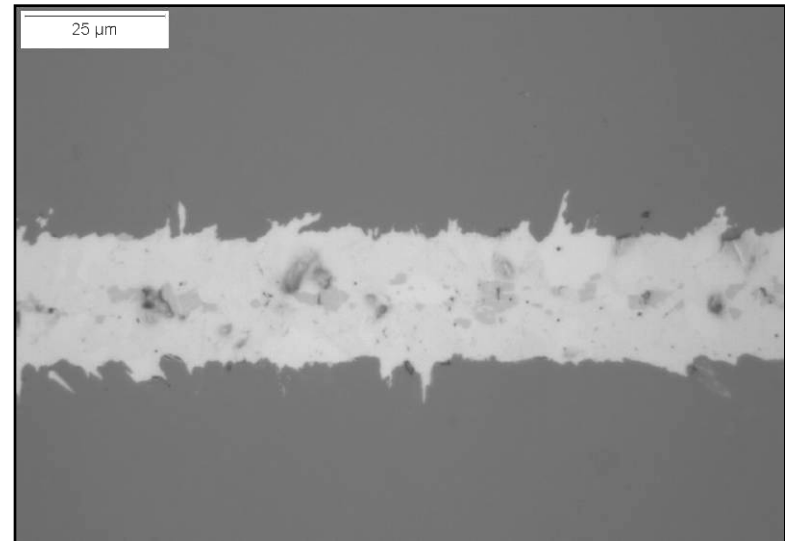

2 hr.

An intermediate phase is observed after 2 hr but not after 4 hr.

- minimal microcracking

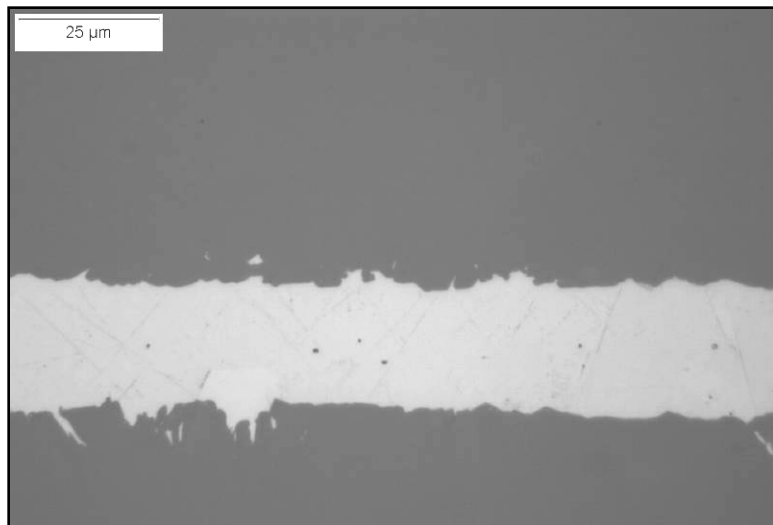

4 hr.

SEM - SiC Substrates Joined with a 25 μm Ti Foil Interlayer For 4 hr

Center of the Bond Line

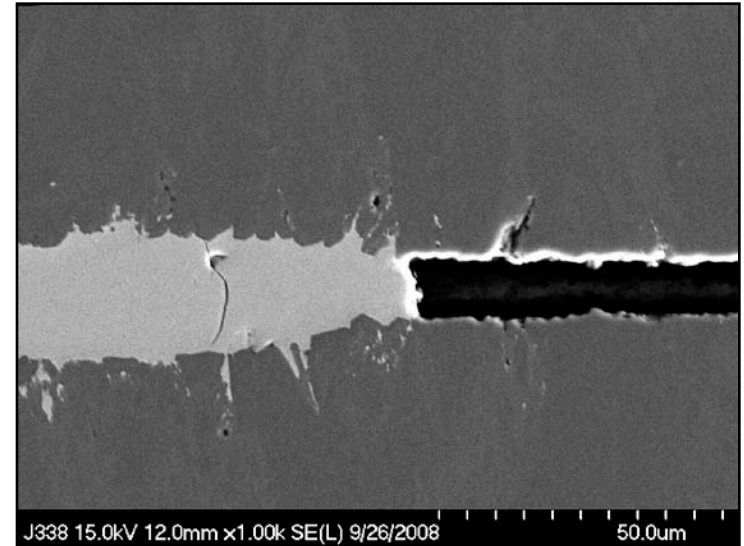
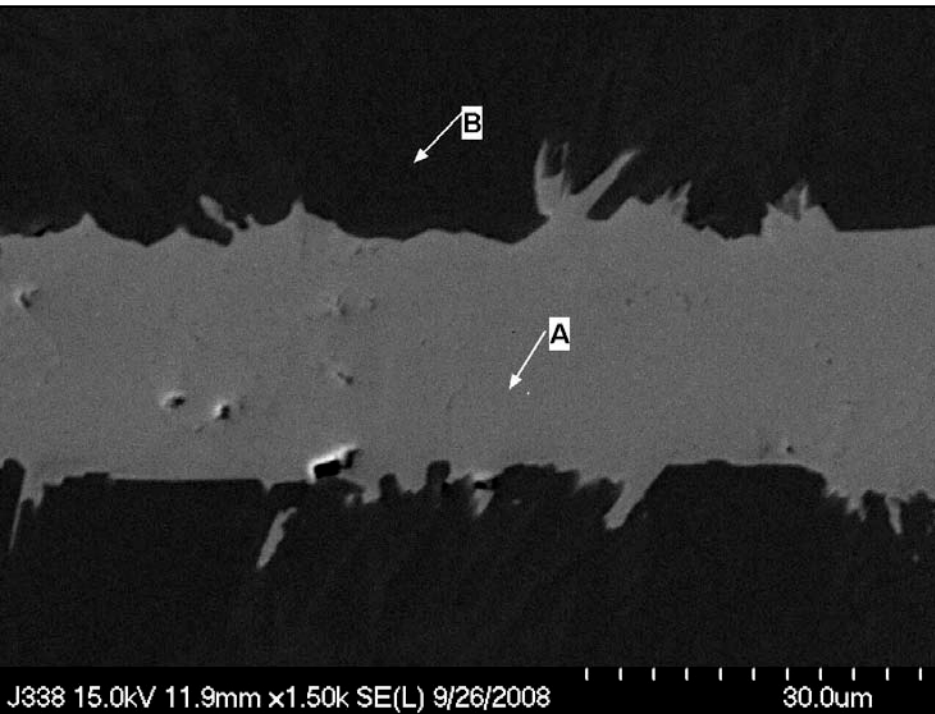

Near and at the Edge

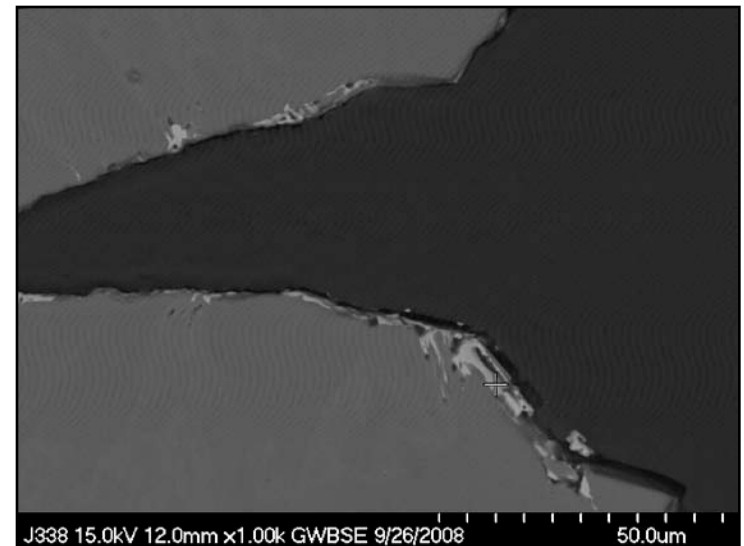

Phases in atomic %

A – C 49.9, Si 13.4, Ti 36.7

B – C 57.6, Si 42.4

SiC Substrates Joined with a 50 μm Ti Foil Interlayer

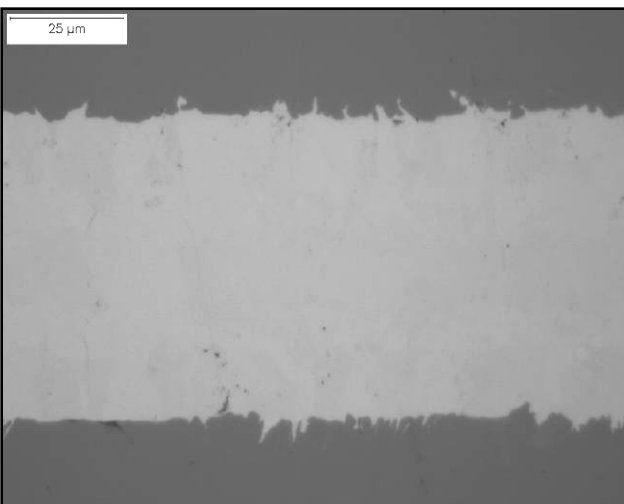

1 hr.

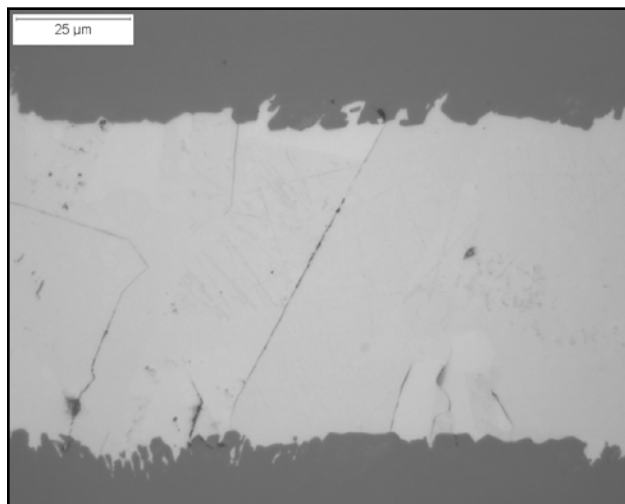

2 hr.

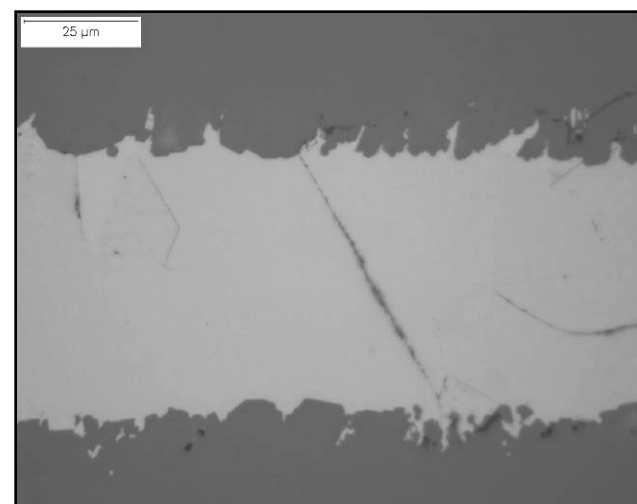

4 hr.

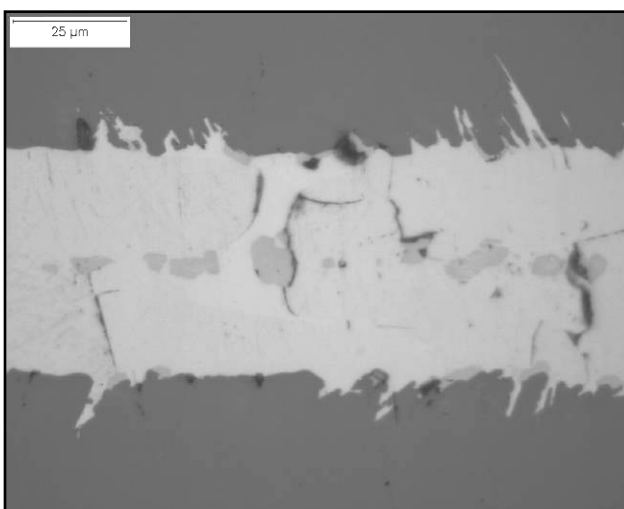

8 hr.

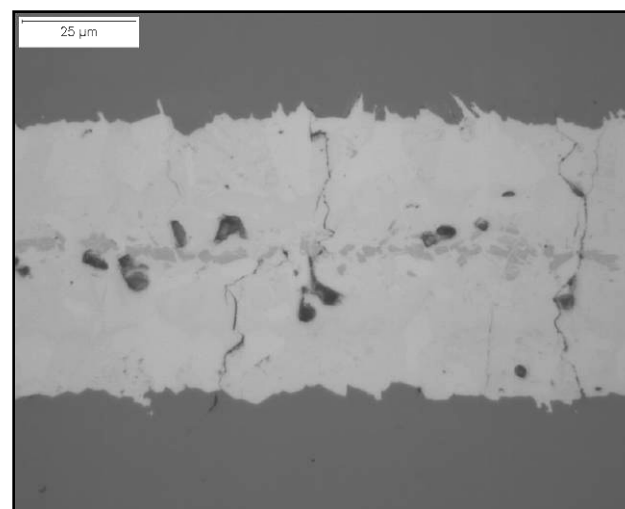

16 hr.

Over time, the formation of microcracks and an intermediate phase are observed followed by void formation and a lessening of the intermediate phase.

SEM - SiC Substrates Joined with a 50 μm Ti Foil Interlayer For 8 hr

Center of the Bond Line

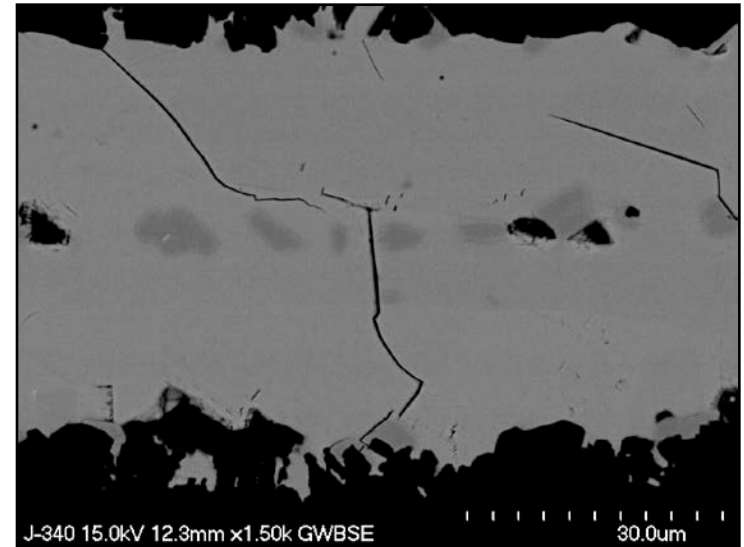
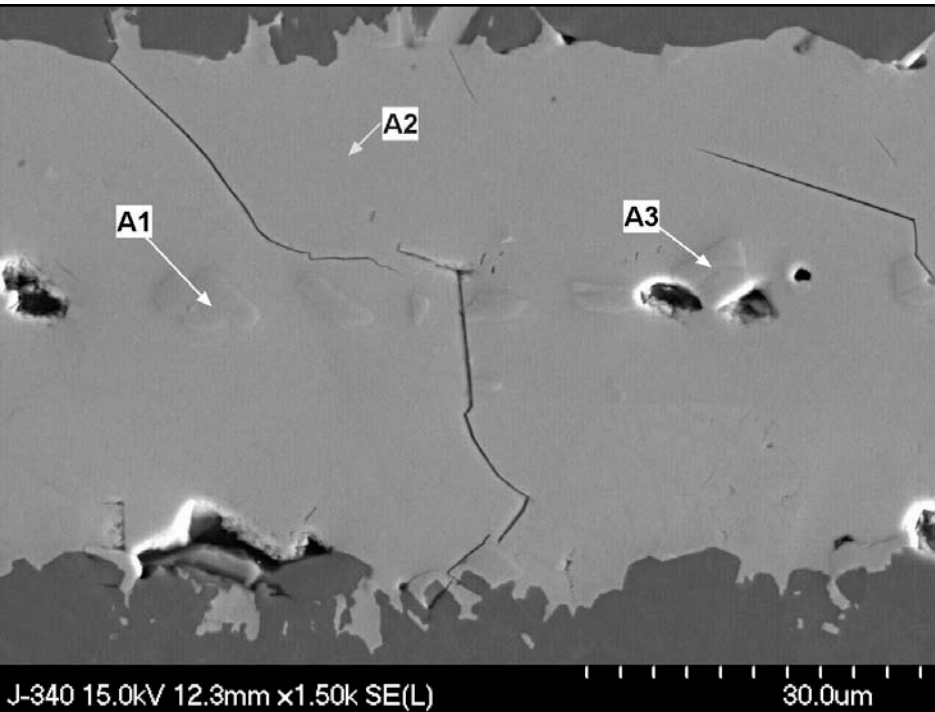

Backscattered Image and Flow at an End

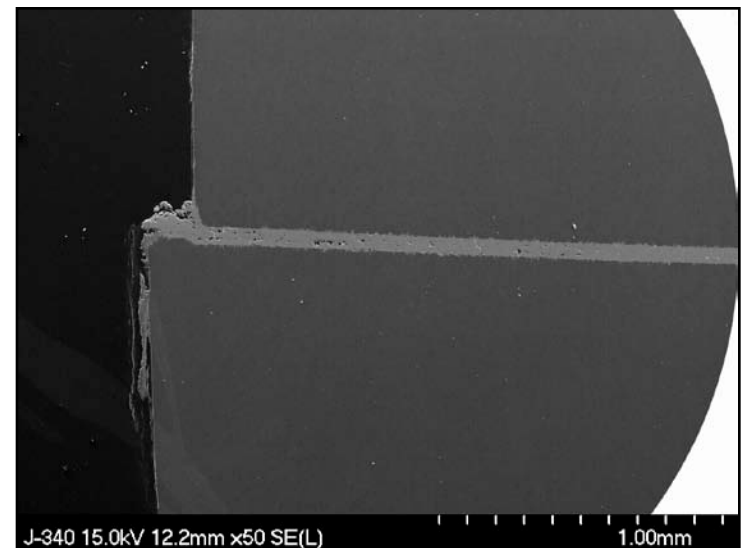

Phases in atomic %

A1 – C 58.3, Si 1.2, Ti 40.5

A2 – C 54.0, Si 12.4, Ti 33.6

A3 – C 57.0, Si 3.3, Ti 39.7



Three Part 10 cm (4") Diameter SiC Injector

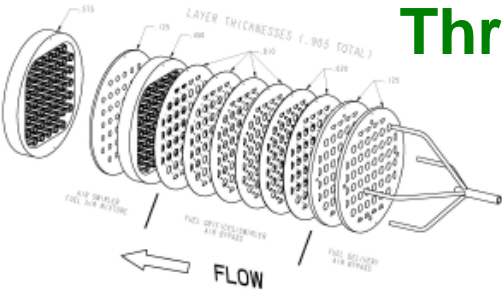

Stacking Sequence
Top to Bottom



Top
Surfaces

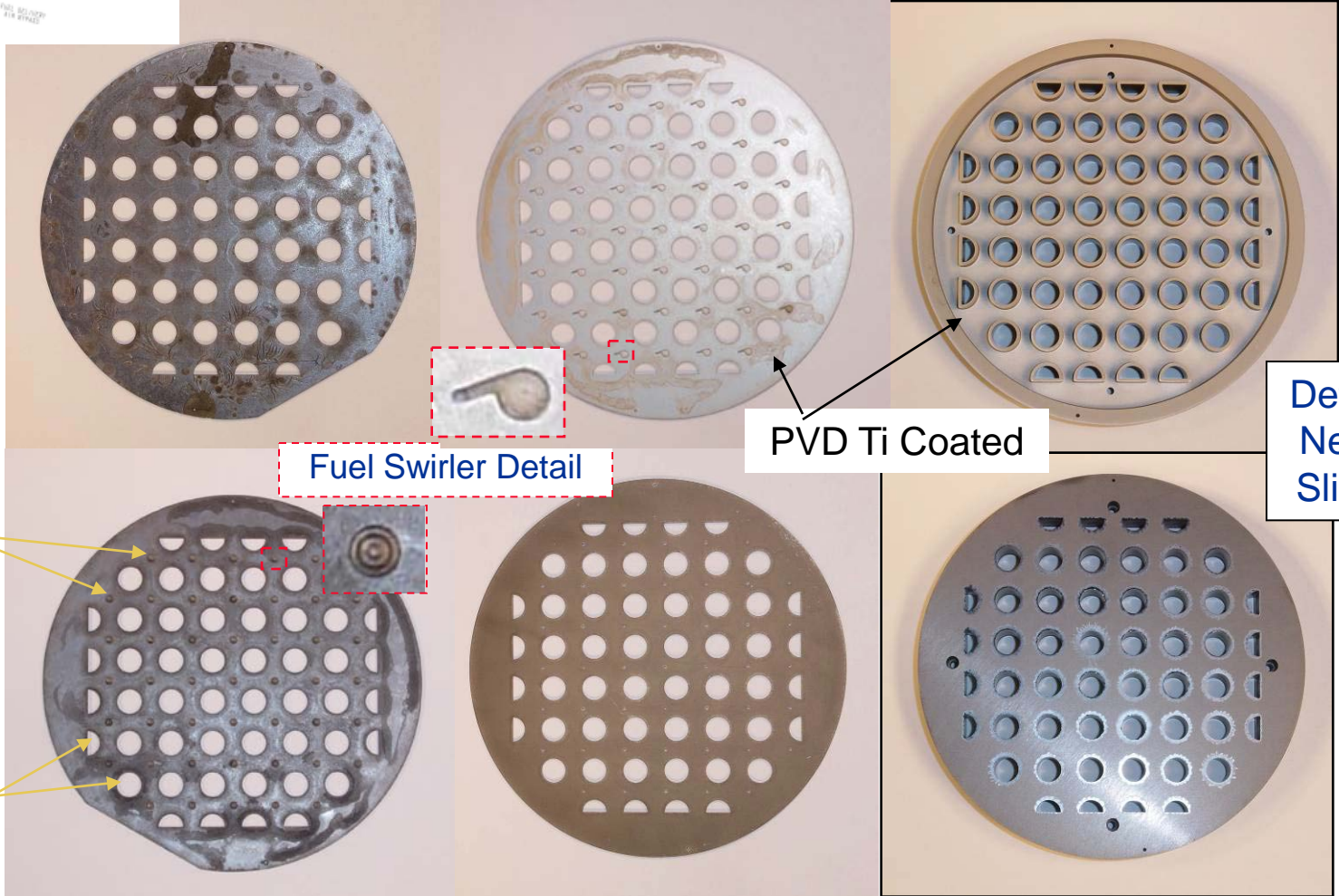

Fuel Swirler Detail

PVD Ti Coated

Detail
Next
Slide

Small Fuel
Holes

Bottom
Surfaces

Large Air
Holes





Summary and Conclusions

- Diffusion bonds fabricated with the alloyed Ti foil as the interlayer formed five to seven phases in the bond.
 - Microcracks due to the formation of thermally anisotropic phases.
- Diffusion bonds fabricated with the 10 micron PVD Ti coating gave better diffusion bonds than the alloyed Ti foil.
 - Fewer and preferred phases were formed which resulted in bonds without microcracks.
- Processing with thinner interlayers and/or for longer durations gave better diffusion bonds.
- Further optimization is needed to identify lower temperature processing conditions so that phase flow is avoided.



Future Work

- Develop lower temperature (less than 1250°C) diffusion bonding conditions with no intermediate phases, no flow, and no micro-cracking.
- Further characterize the diffusion bonds, i.e. mechanical tests.
- Apply diffusion bonding approach to multi-laminate SiC injector.
- Develop SiC to Kovar brazing.

Acknowledgements

- This effort was supported by the NASA Glenn Research Center under the Subsonic Fixed Wing Project.
- The authors would like to thank the following:
 - Dr. Dan L. Bulzan and Robert R. Tacina at NASA GRC for their support and for providing the injector design and requirements.
 - Dr. Robert Okojie of NASA GRC for providing PVD Ti Coated CVD SiC.



Back-up Slides

Multi-Point Lean Direct Injector

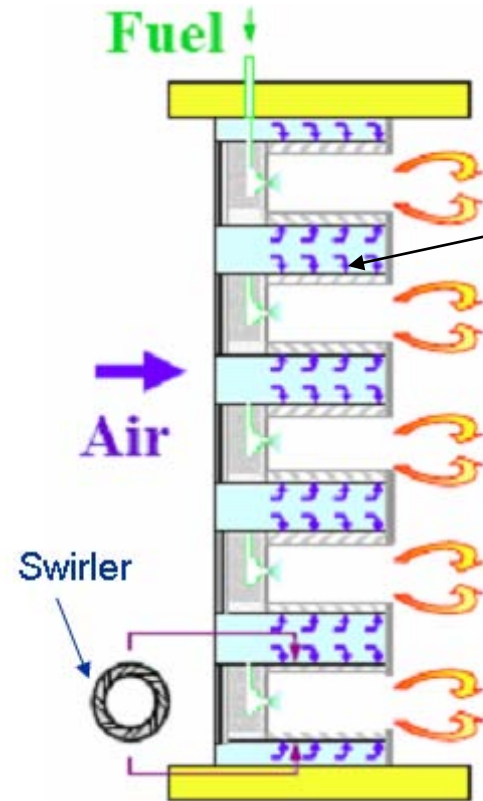
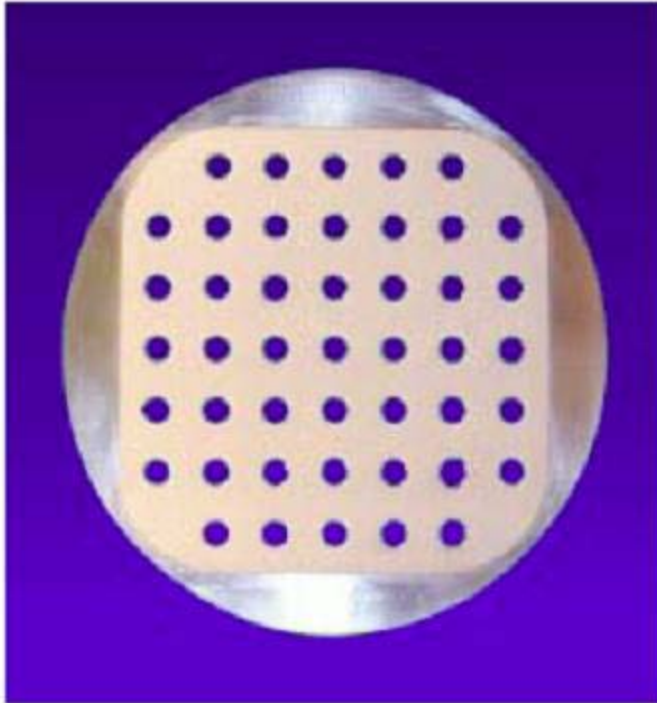

Air channels and the swirler exits on the side are built up from laminates.

The complex channels can only be fabricated by stacking and joining laminates with different hole patterns.

(Left) 3-inch square metal MP-LDI with 45 injectors.

(Right) Multi-Point Lean Direct Injector accelerates fuel-air mixing and has small recirculation zones with short residence time that reduces NO_x emission.

From Robert Tacina, et al., "A Low Lean Direct Injection, Multi-Point Integrated Module Combustor Concept for Advanced Aircraft Gas Turbines," NASA/TM-2002-211347, April 2002.



Leak Test of SiC Laminates Joined with Silicate Glass

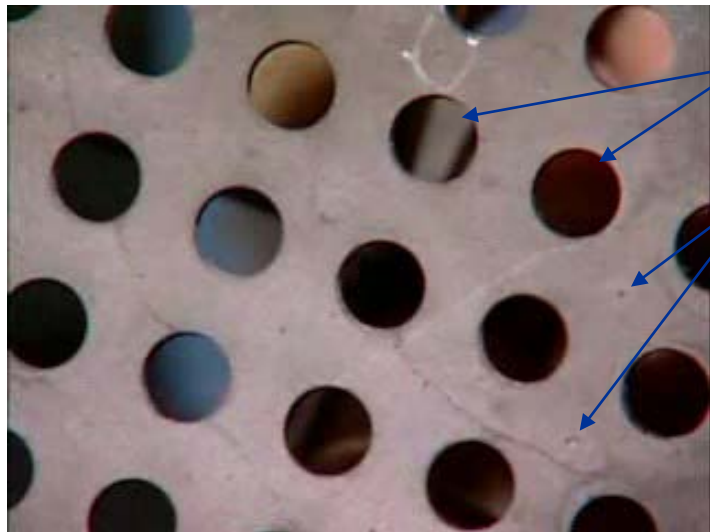

Combustion air channels

Fuel holes

Leaks at the edge between joined laminates



Air should only flow through the fuel holes



Undesired leaks in the combustion air channels

Plugged fuel hole

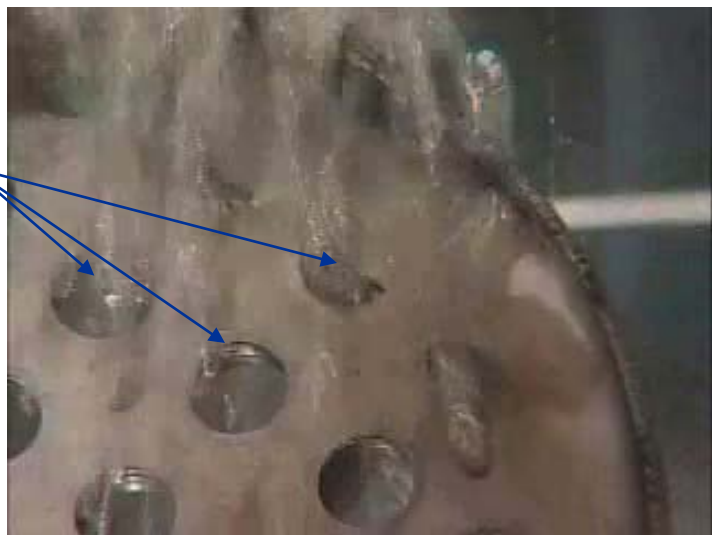

Thermal Expansion Issues for the Alpha and Beta Ti Alloy Phases

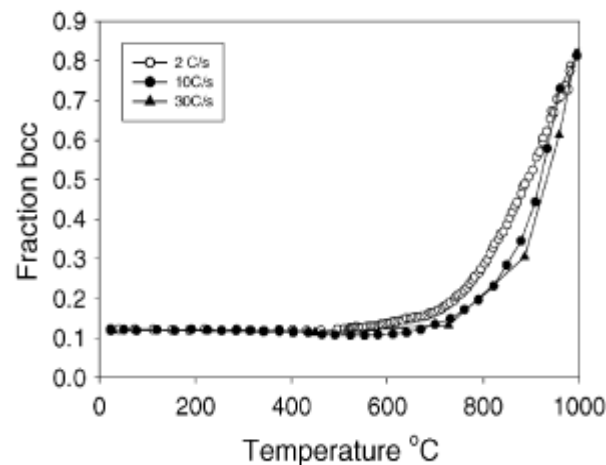

From Elmer et al, Materials Science and Engineering A 391 (2005) 104-113.

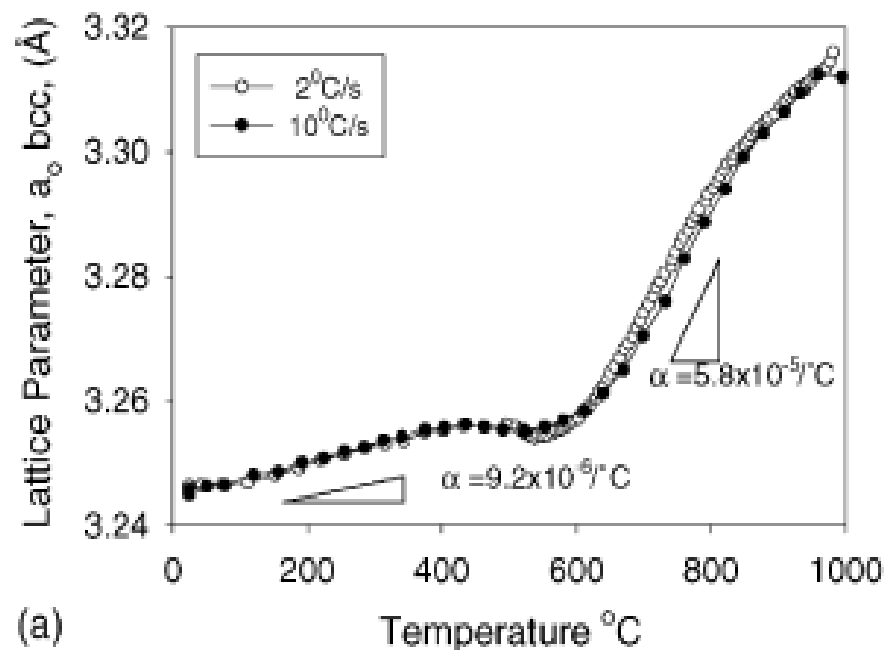
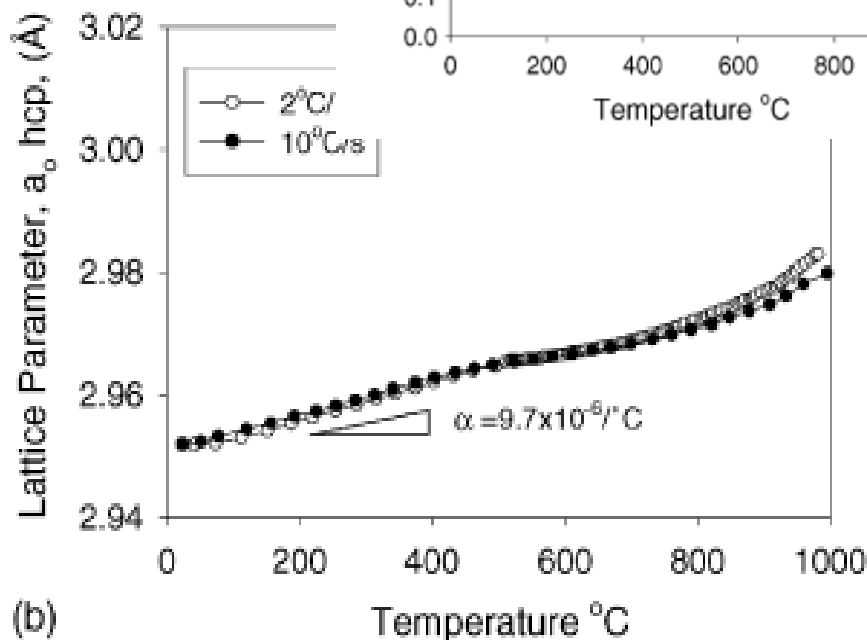

- Central core of diffusion bond has concentrated alpha and beta Ti alloy phases. The alpha phase has an anisotropic thermal expansion which is 20 % greater along the c-axis (Boyer, Welsch, and Colling). Also, the beta phase has a thermal expansion that is 6 x higher in the temperature range of 600-1000 °C ($5.8 \times 10^{-5} / ^\circ\text{C}$) compared the thermal expansion below 600 °C ($9.2 \times 10^{-6} / ^\circ\text{C}$) (Elmer et al).

Non-Destructive Evaluation (NDE) Method of Ultrasonic Immersion Shows Very Good Bonding of 1" Discs

Less Polished SiC

Highly Polished SiC

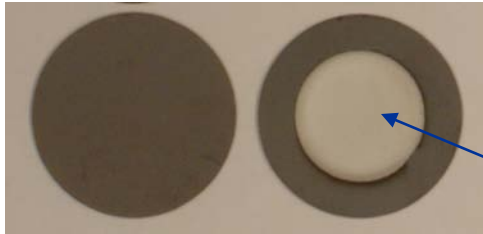

← Discs Before Bonding →

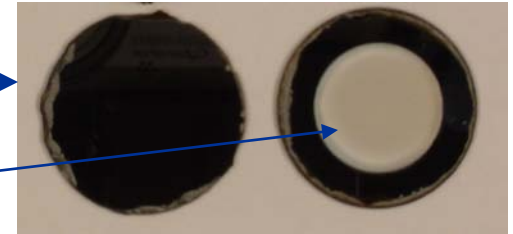

0.65" Diameter PVD Ti Coating

Ultrasonic C-scan Image of Bonded Discs

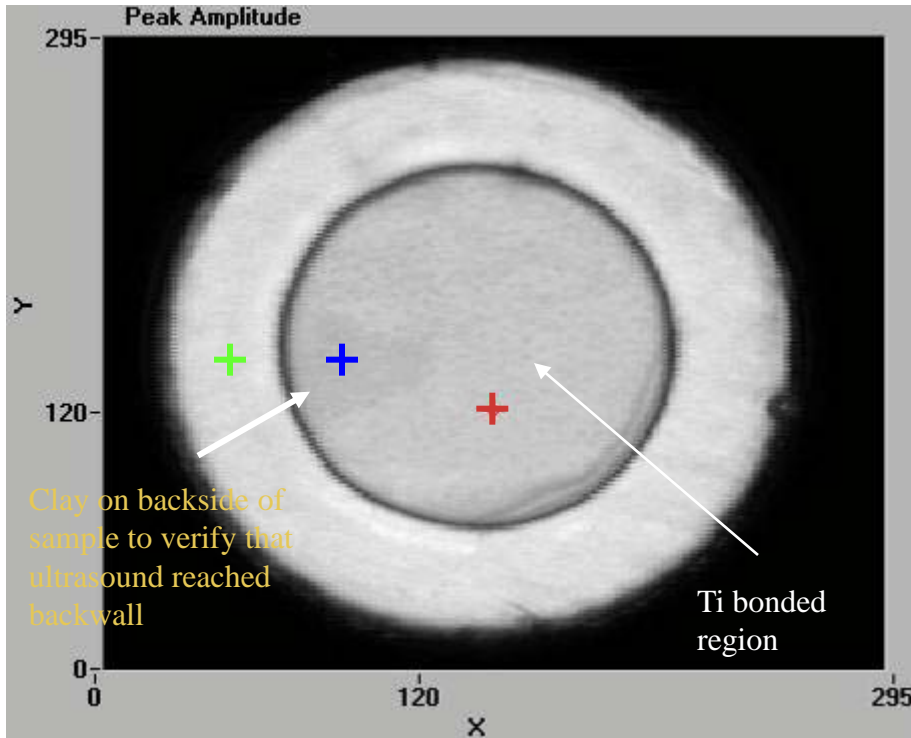

Ultrasonic C-scan Image of Bonded Discs

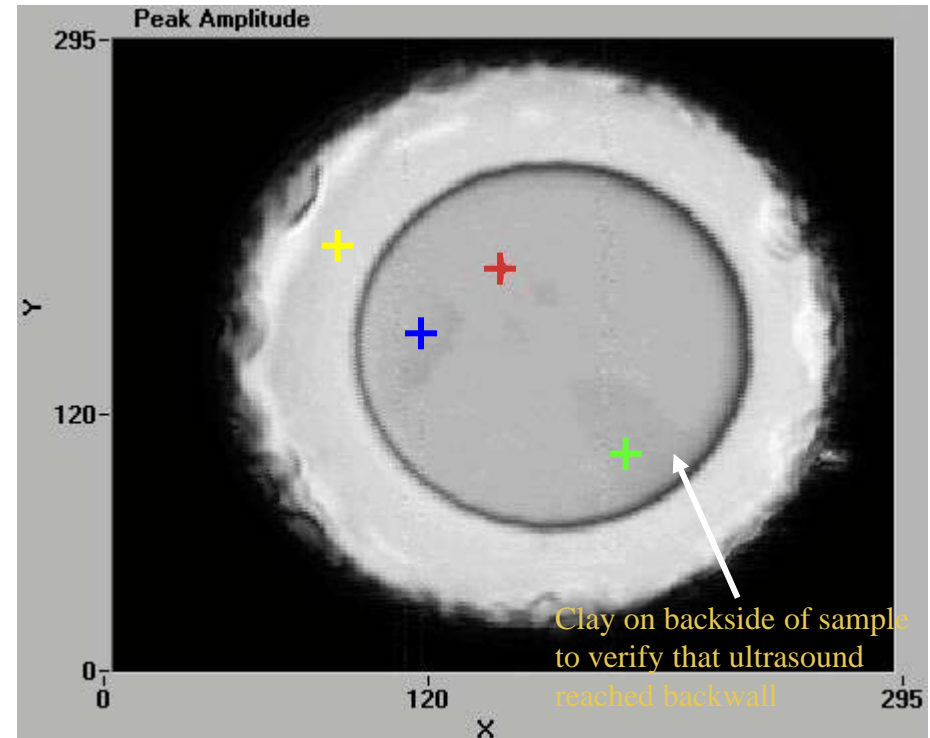

High Strength of Bonds Greatly Exceed the Application Requirements

1" Diameter Discs with a
0.65" Diameter Bond Area

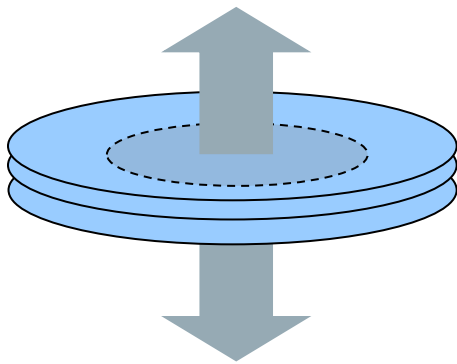

Pull test tensile strengths:

13.4 MPa (1.9 ksi)

15.0 MPa (2.2 ksi)

Slightly higher strength from the highly polished SiC suggest that a smoother surface contributes to stronger bonds or less flawed SiC.

Failures are primarily in the SiC substrate rather than in the bond area.

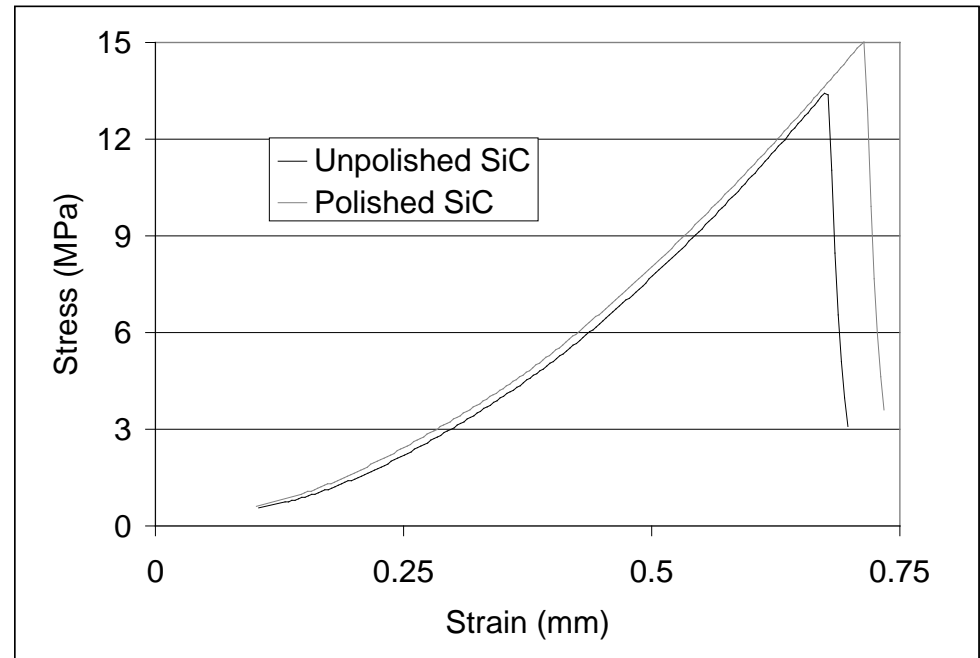

The injector application requires a strength of about 3.45-6.89 MPa (0.5 - 1.0 ksi).

Fracture Surfaces from the Pull Tests of the 1.0" Joined Discs with 0.65" Diameter Bond Region

Less Polished SiC

Highly Polished SiC

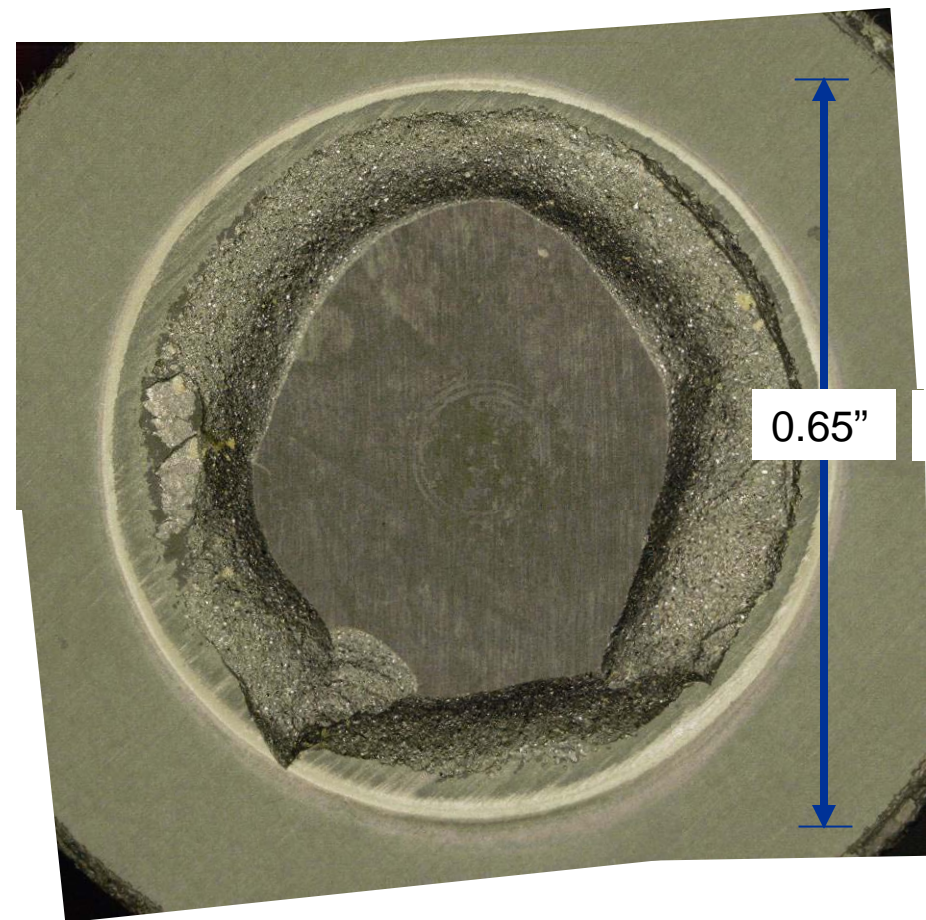

Failure was in the SiC substrate rather than the bond. The bond was pulled out intact from the failing SiC substrate.

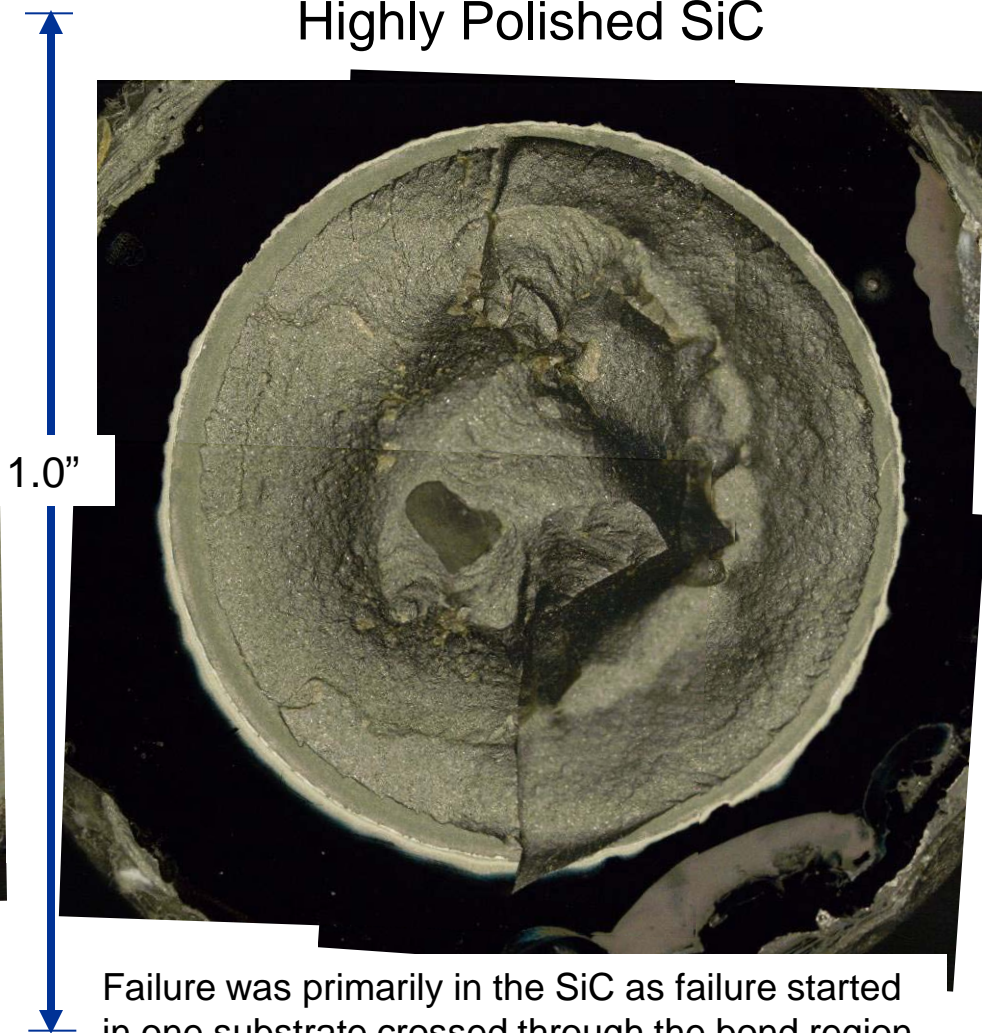

Failure was primarily in the SiC as failure started in one substrate crossed through the bond region and continued in the other SiC substrate.