

General Disclaimer

One or more of the Following Statements may affect this Document

- This document has been reproduced from the best copy furnished by the organizational source. It is being released in the interest of making available as much information as possible.
- This document may contain data, which exceeds the sheet parameters. It was furnished in this condition by the organizational source and is the best copy available.
- This document may contain tone-on-tone or color graphs, charts and/or pictures, which have been reproduced in black and white.
- This document is paginated as submitted by the original source.
- Portions of this document are not fully legible due to the historical nature of some of the material. However, it is the best reproduction available from the original submission.

Automated Ground Umbilical Systems (AGUS) Project

Armand M. Gosselin
United Space Alliance
Armand.M.Gosselin@usa-spaceops.ksc.nasa.gov

Abstract

All space vehicles require ground umbilical systems for servicing. Servicing requirements can include, but are not limited to, electrical power and control, propellant loading and venting, pneumatic system supply, hazard gas detection and purging as well as systems checkout capabilities.

Of the various types of umbilicals, all require several common subsystems. These typically include an alignment system, mating and locking system, fluid connectors, electrical connectors and control/checkout systems. These systems have been designed to various levels of detail based on the needs for manual and/or automation requirements.

The Automated Ground Umbilical Systems (AGUS) project is a multi-phase initiative to develop design performance requirements and concepts for launch system umbilicals. The automation aspect minimizes operational time and labor in ground umbilical processing while maintaining reliability. This current phase of the project reviews the design, development, testing and operations of ground umbilicals built for the Saturn, Shuttle, X-33 and Atlas V programs. Based on the design and operations lessons learned from these systems, umbilicals can be optimized for specific applications. The product of this study is a document containing details of existing systems and requirements for future automated umbilical systems with emphasis on design-for-operations (DFO).

1. Introduction

There are generally two types of ground umbilicals that can be required for servicing space vehicles. These typically are ground-to-vehicle umbilicals and ground-to-ground umbilicals. Figure 1 shows the general types of ground umbilicals.

Ground-to-vehicle umbilicals (GVUs) mate directly to the vehicle and may be of two sub-types based on operational requirements. The first can be for pre-launch servicing only, where mating and demating is done (from hours to days) prior to launch. Specific examples of GVU's that are used only for pre-

launch servicing include the space shuttle fuel cells mid-body umbilical and the aft and forward hypergolic control systems. These systems require manual connection for mating to the vehicle for servicing of the vehicle's commodities and manual disconnect after servicing.

A second type of GVU is also used for pre-launch but is required to provide service through launch where commodities and power may be required up to and including lift-off (T-0). Examples of these types of GVUs are the shuttle orbiter liquid oxygen (LOX) and liquid hydrogen (LH2) Tail Service Masts (TSM) and the external tank (ET) hydrogen vent umbilical. These systems are also manually mated to the vehicle for pre-launch operation and automatically retract at liftoff.

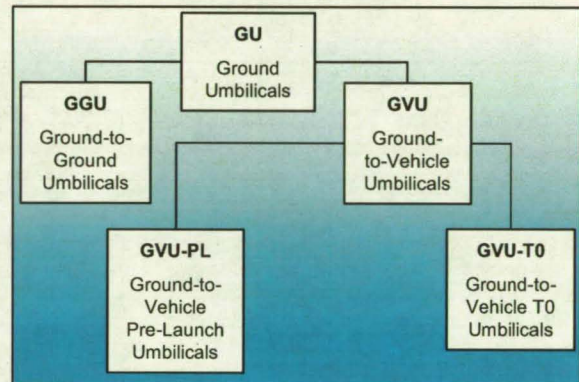

Figure 1. Umbilical System General Classification

Ground-to-ground umbilicals (GGUs) are required for launch systems requiring mobile facilities such as a mobile launch platform (MLP) where mating to launch pad facilities is required. These can range from a manual mated system, such as the shuttles MLP-to-pad cryogenic disconnect towers, to the automated Atlas V Autocoupler.

Of the various types of umbilicals, all require several common subsystems. They typically include an alignment system, mating and locking system, fluid connectors, electrical connectors and control/checkout systems as shown in Figure 2. These systems have been designed to various levels of detail based on the

need for manual and/or automation requirements.

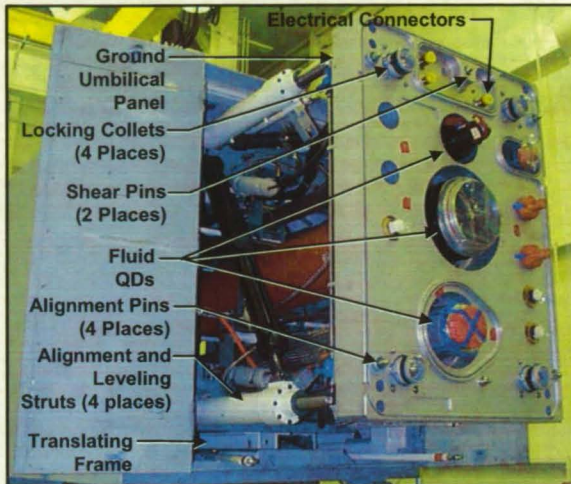

Figure 2. Subassembly / Component Overview

The Automated Ground Umbilical System (AGUS) project is an initiative to develop design performance requirements for launch system umbilicals. The automation aspect is to minimize operational time and labor in ground umbilical processing while still maintaining reliability. This effort addresses specific optimization, inherent problems and issues associated with the following:

1. Mechanical systems setup, alignment and mating, vehicle/system tracking and re-mating
2. Control systems development and integration to existing systems
3. Fluid system quick disconnect leakage and cryogenic thermal issues which includes frost/ice issues
4. Electrical system and specific conductivity issues
5. System maintainability and reliability

This effort will also review system's design, development and testing, along with lessons learned and operational issues.

2. Umbilical Systems

Various umbilical systems have been reviewed from the Saturn, Shuttle, X-33 and Atlas V programs. This effort has included documenting specific references to design, operational and performance characteristics.

2.1. Saturn Program

The Saturn V program incorporated design

experience and lessons learned from previous umbilical projects, in particular the Saturn I systems. An extensive effort was done to capture umbilical systems design and development for application to the Saturn V program [2]. These studies included the design, development and testing of various mating and retract GUV mechanisms along with incorporation of umbilicals into the service arm designs. As depicted in Figure 3, there were effectively three Tail Service Masts (TSM) and nine service arms (SA) for the Saturn V.

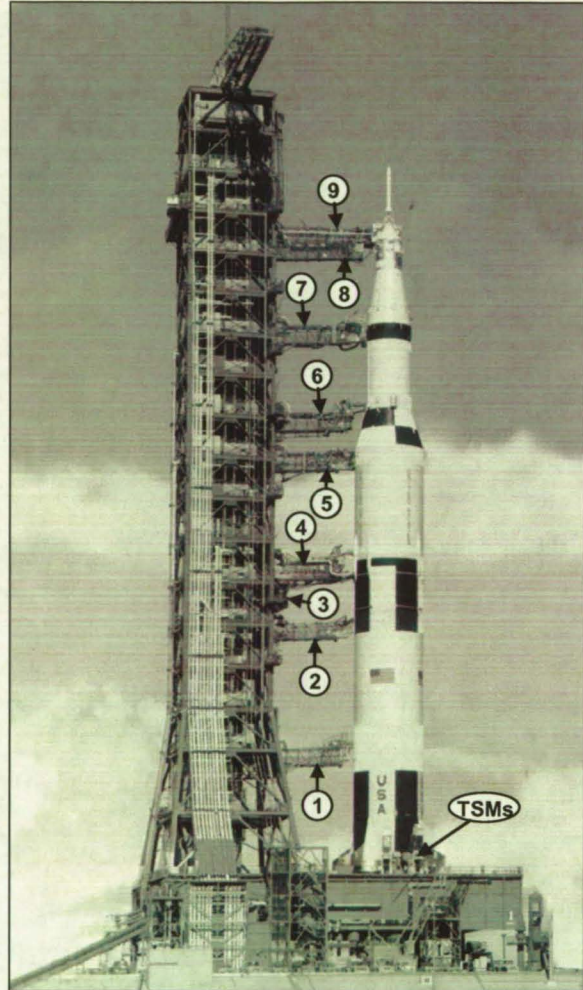

Figure 3. Saturn V TSM's and Service Arms (SA) 1-9 (SA-3 shown retracted)

The three TSM assemblies supported service lines to the S-IC stage and provided a means for rapid retraction at vehicle liftoff. Located on level '0' of the Mobile Launcher, each TSM was a counterbalanced structure that was hydraulically operated and pneumatically/electrically controlled. Retraction of the umbilical carrier and vertical rotation of the mast was

accomplished simultaneously to ensure no contact between the vehicle and umbilical. A blast hood was closed by a separate hydraulic system after rotation. The Tail Service Masts provided service for RP-1 fuel; LOX fill and drain, pneumatic, electrical, hydraulic, conditioned air and cryogenic connections.

The nine service arm types and functions are listed in Table 1. With the exception of the Command Module Arm and S-II Aft Service Arm, all provided a combination of cryogenic fluids (hydrogen and oxygen), pneumatics, conditioned air and electrical service to the vehicle. There were four preflight (or pre-launch) and five inflight (T-0) umbilicals.

The S-IC Intertank (SA-1) was a ground-to-vehicle preflight service umbilical. A pneumatically driven compound parallel linkage device withdrew the umbilical. The arm retracted in 8 seconds. A unique feature of this arm was that it could be reconnected in 5 minutes from the Launch Control Complex (LCC).

The S-IC Forward (SA-2) was also a ground-to-vehicle preflight service umbilical. The umbilical was withdrawn by a pneumatic disconnect in conjunction with a pneumatically driven block and tackle/lanyard device. A secondary mechanical system was also available. At T-19 seconds the arm retracted in 8 sec.

The S-II Intermediate (SA-4) provided LH2 and LOX transfer, venting, electrical, pneumatic, instrument cooling and air-conditioning interfaces. The umbilical was withdrawn by a pneumatic disconnect in conjunction with a pneumatic/hydraulic redundant dual cylinder system. If the primary withdrawal system were to fail, a pneumatic cylinder actuated lanyard system provided backup. The T-0 arm retracted in 6.4 seconds.

For SA-5, S-II Forward (T-0), service was provided for GH2 vent, electrical, air-conditioning and pneumatic interfaces. The umbilical was withdrawn by a pneumatic disconnect in conjunction with pneumatic/hydraulic redundant dual cylinder system. Arm retract time was 7.4 seconds.

The T-0 umbilical for S-IVB Aft SA-6 provided LH2 and LOX transfer, electrical, pneumatic and air-conditioning interfaces. A pneumatic disconnect in conjunction with a pneumatic/hydraulic redundant dual cylinder system provided retract. This arm retracted in 7.7 seconds.

SA-7, S-IVB Forward (T-0), provided fuel tank venting, electrical, pneumatic, air-conditioning and pre-flight conditioning interfaces. Retract time was 8.4 seconds. The umbilical was withdrawn by a pneumatic disconnect in conjunction with pneumatic/hydraulic redundant dual cylinder system and a secondary

mechanical system.

Service Module (SA-8) provided air-conditioning, venting, coolant, electrical service, cryogenics and pneumatic interfaces. The umbilical was withdrawn by a similar system as SA 7 with a retract time of 9.0 sec.

Table 1. Saturn V Service Arms Summary [5]

Service Arm	Type	Function Service	Retract Time
① S-IC Intertank	Preflight	LOX Fill and Drain	8 sec. (Reconnect ~ 5 min.)
② S-IC Forward	Preflight	Pneumatic, Electrical and Air Conditioning	8 sec (@ T-19 sec.)
③ S-II AFT	Preflight	Access to Vehicle	Prior to Liftoff as Req'd
④ S-II Intermediate	Inflight	LH2, LOX, Vent Line, Pneumatic, Instrumentation Cooling, Electrical and A/C	6.4 sec. (Max.)
⑤ S-II Forward	Inflight	GH2 Vent, Electrical and Pneumatics	7.4 sec. (Max.)
⑥ S-IVB Aft	Inflight	LH2, LOX, A/C, Pneumatic, and Electrical	7.7 sec. (Max.)
⑦ S-IVB Forward	Inflight	Fuel Venting, Electrical, Pneumatic and A/C	8.4 sec. (Max.)
⑧ Service Module	Inflight	A/C, Venting, Coolant, Electrical and Pneumatic	9 sec. (Max.)
⑨ Command Module	Preflight	Spacecraft Access	Retracted 12° until T-4 min. Extend Back from this point in 12 sec

For all of the inflight (T-0) service arms, the umbilical disconnect from the vehicle required a separation of 1 second or less for vehicle clearance and arm rotation. One of the most critical features of all T-0 systems was the ability to disconnect safely, under all conditions. This required several backup systems. As an example, the S-IVB Aft Service Arm System, shown in Figure 4, had several backup umbilical disconnect features to the primary disconnect.

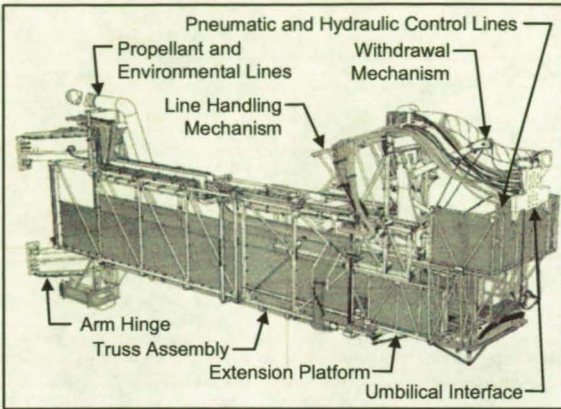

Figure 4. S-IVB Aft Service Arm (SA-6)

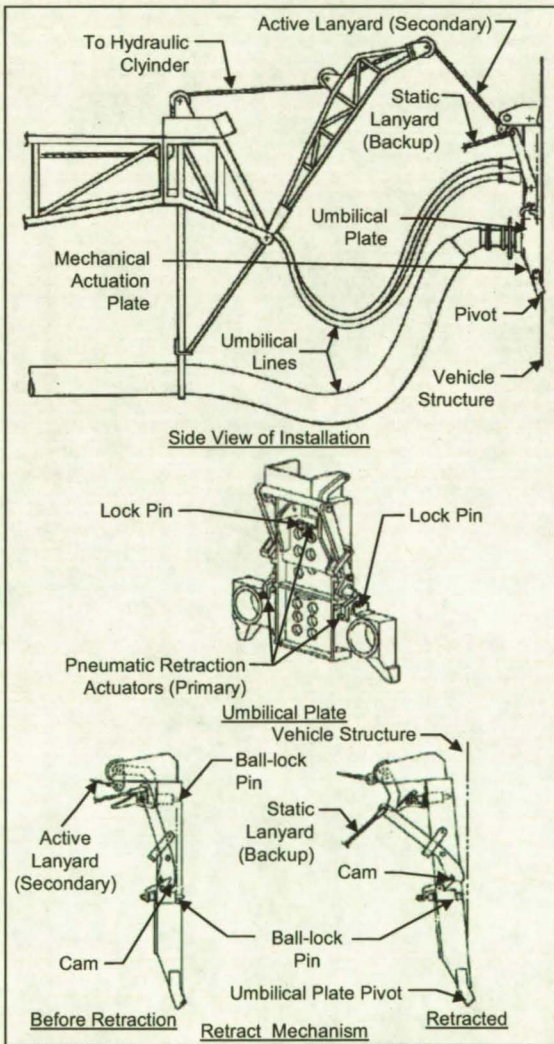

Figure 5. Redundant Retract Mechanism

Figure 5 shows typical backup systems incorporated on these types of umbilical mechanisms [12]. This system featured pneumatically activated ball-lock pins as a primary, a secondary mechanism activated by a lanyard (controlled by a hydraulic cylinder) and a tertiary disconnect activated by a static lanyard through vehicle motion. Also, in this design the ball-locks would shear from the vehicle if the device jammed.

2.2. Shuttle Systems

The shuttle program utilizes several pre-launch and T-0 type umbilical systems for servicing the Solid Rocket Boosters (SRB), External Tank (ET) and Orbiter. Examples of pre-launch servicing are the orbiter's hypergolic system and cryogenic fuel cell systems. Umbilicals for these systems, some with self-aligning features, are mated and de-mated manually.

There are three main ground-to-vehicle T-0 systems as shown in Figure 6. These include the LH2

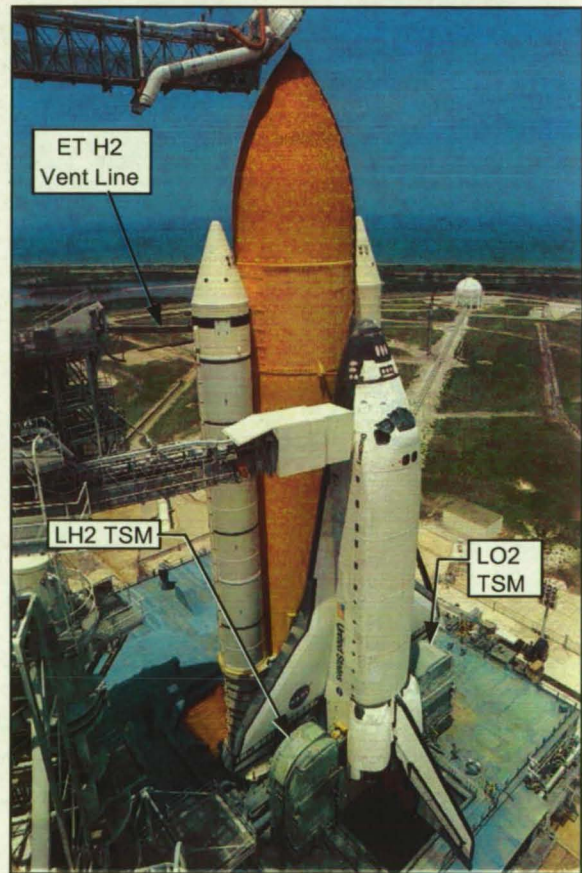

Figure 6. Shuttle Major T-0 Umbilicals

and LOX Tail Service Masts (TSM) and the External Tank (ET) vent.

The TSMs are the main fluid and electrical connections between the Space Shuttle's Orbiter and the ground launch facility (LH2 TSM shown in Figure 7 and 8). At T-0, the time of ignition of the SRB, an electrical signal is sent from the Orbiter to a pyrotechnic bolt in each TSM for disconnect.



Figure 7. LH2 TSM (Top View)



Figure 8. LH2 TSM (View Looking Up)

The ET umbilical system, shown in Figure 9, provides for the capability to vent the Space Shuttle ET during and after LH2 loading. It also provides the vehicle-to-ground system connections of various required fluid and electrical service lines. The umbilical arm extends out from the tower where it connects the Ground Umbilical Carrier Plate (GUCP) to the Flight Umbilical Plate on the ET (Figure 10). At the other end of the umbilical is a 24-foot long flex hose that transfers the vented gas to the facility piping and to the pad's flare stack.

This system is designed to disconnect at the SRB ignition command (T-0). Following disconnect, the umbilical interface panel retracts, the vent arm drops down, and is secured inside the facility structure. The different components of this umbilical system are the

Vent Line Assembly, Haunch Pivot Fixture, Deceleration Unit, Static Lanyard & T-0 Lock Assembly and Withdrawal Weight Mechanism.

All of the T-0 umbilicals discussed are mated manually and can take up to a full shift or more to mate to the vehicle. Retract time from the vehicle is on the order of 1 second.

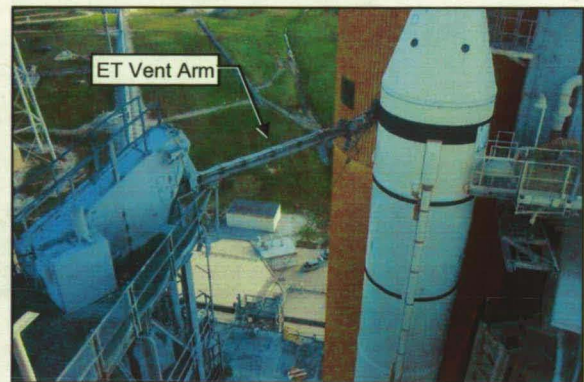

Figure 9. ET H2 Vent Arm

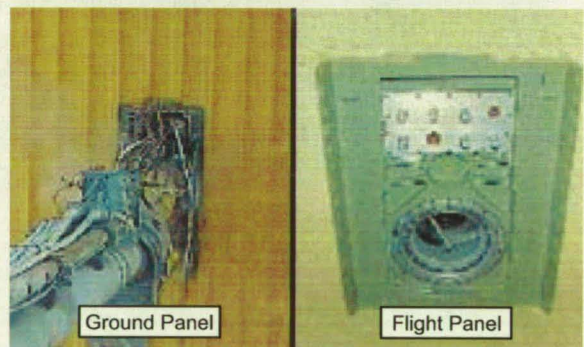

Figure 10. ET H2 Ground and Flight Panels

2.3. X-33 Systems

The X-33 vehicle was a half scale design of the proposed single stage to orbit (SSTO) VentureStar. The ground umbilicals were designed, built and tested prior to the program's cancellation. The umbilicals were T-0 rise-off type umbilical systems. They consisted of two independent assemblies, one for oxygen and the other for hydrogen (Figures 11 and 12). Other services such as environmentally controlled air; electrical service, helium, nitrogen, and coolants were supplied through these umbilicals.

The X-33 used a rotating launch mount, where the vehicle was connected to the launch structure and hold down posts in the horizontal position, then rotated to the vertical launch configuration. It also had the capability of mating in the vertical position. This

umbilical system used two gang-mated umbilical panels. A compliant strut mechanism connecting the umbilical panel to the carriage provided passive self-aligning capability [9].

At launch the vehicle would rise from the hold down posts with the umbilical panels connected. Lanyards, connected to each of the locking devices would pull collet pins, releasing the panels. If any of the pins failed to pull, or the collet failed to release from the receptacle, a secondary cam mechanism, pulled by the same lanyard, would provide additional force to break a shear pin on the flight panel receptacle. After release, the ground panel, strut, and carriage assembly would retract into the steel blast tunnel. Double doors, actuated by the retracting carriage, would close the top of the blast tunnel. Shock absorbers cushioned the retracted assembly.

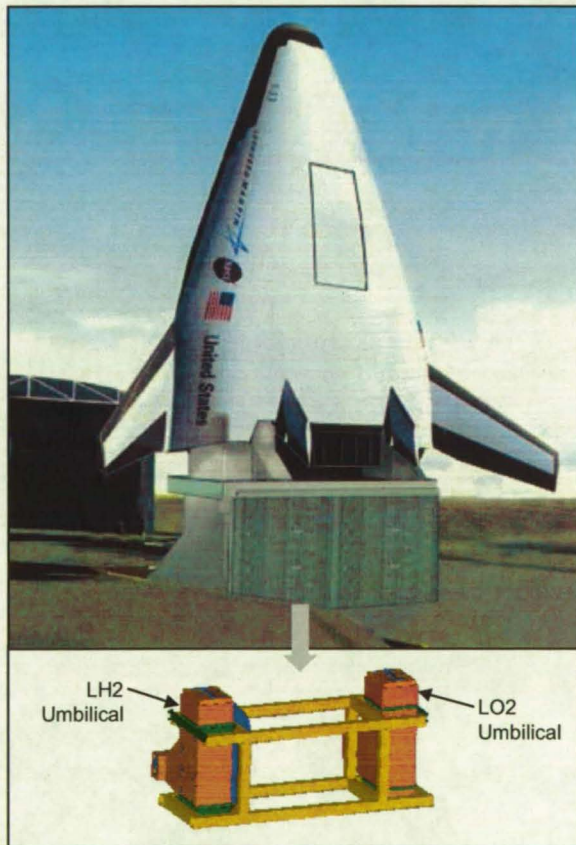

Figure 11. X-33 Vehicle and Umbilical Systems

Each flight umbilical panel was protected at liftoff by a composite sliding door. The door was held open by the ground panel and was actuated by constant force flat springs with small shock absorbers decelerating the door before engaging two spring-loaded latches. Most flight panel components were

constructed of aluminum and titanium.

The X-33 umbilical was manually controlled and took approximately 4 hours for mating operations but had the potential for conversion to a fully automated system. The passive self-aligning strut mechanism was the key, making this a simple to operate system.

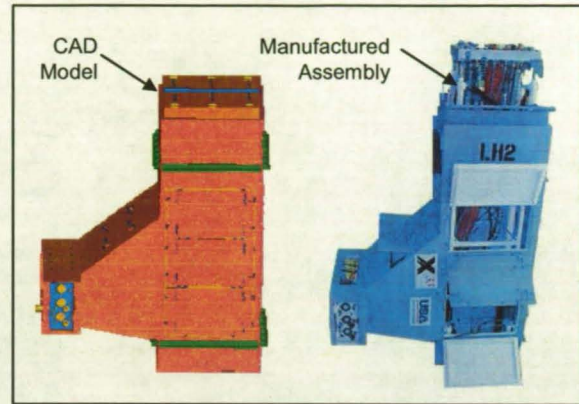

Figure 12. X-33 LH2 Umbilical Assembly CAD Model and Manufactured Assembly

2.4. Atlas V

The Lockheed Martin Atlas V Autocouplers are a group of four, automated, ground-to-ground umbilical systems that connect the facility to the mobile launch platform (MLP) [13, 14]. The most prominent feature of the Autocoupler is the automated control system and leak detection system. The Autocouplers can be controlled remotely, or at each unit with manual override capability.

A key feature of the Autocoupler is the flexhose management system, called an "energy chain". Three of the four Autocouplers use a stainless steel energy chain. These chains are similar to cable trays, and have a simple rotation limiting design at each link connection. A composite energy chain was used on the pneumatic Autocoupler.

Each Autocoupler uses four collet-locking devices to hold the umbilical panels together. The devices are mounted on the facility panels. The remotely controlled locking device uses a pneumatic cylinder, from a commercial off the shelf (COTS) supplier, with an optional sensor, to confirm position of the collet. This design provides high linear load carrying capability, reliable operation and a compact design minimizing moving parts. All four Autocouplers can be mated within approximately 1 hour.

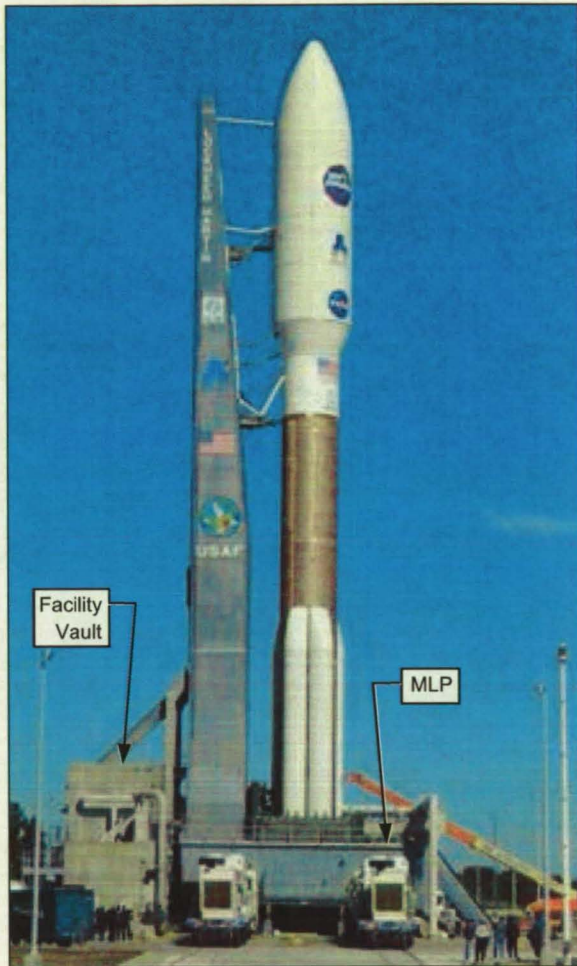

Figure 13. Atlas V, MLP and Facility Vault



Figure 14. Atlas V Autocoupler at KSC Test Site

3. Umbilical Subassemblies / Components

The following is an overview of subassemblies/components reviewed during the initial part of this study.

3.1. Alignment, Mating and Locking Systems

Accurate mating of critical components such as fluid quick disconnects and electrical connectors require accurate alignment systems. Components can require tight tolerance such as quick disconnects (QD) where slight misalignment can damage sealing services.

During design of alignment systems, significant effort is placed on the development of mechanisms to minimize loads imposed on the vehicle. Figure 15 shows a pneumatically actuated linkage assembly used on the Saturn V S-IC Intertank umbilical [2]. This system self aligns by means of the groundside spherical locking mechanism and vehicle cone shape receptacle.

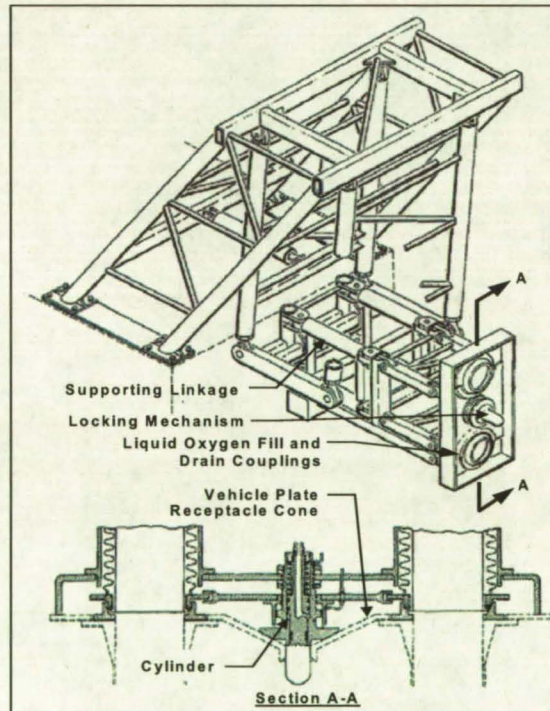

Figure 15. Self-aligning Umbilical (Saturn V – SIC Intertank)

The type of locking mechanism used in this application is shown in Figure 16. This system is a simple ball and socket type of locking device where a sleeve captures multiple balls around the ball

connection. This system, used in the Saturn program, can be remotely disengaged by pneumatic actuation as well as a mechanical device.

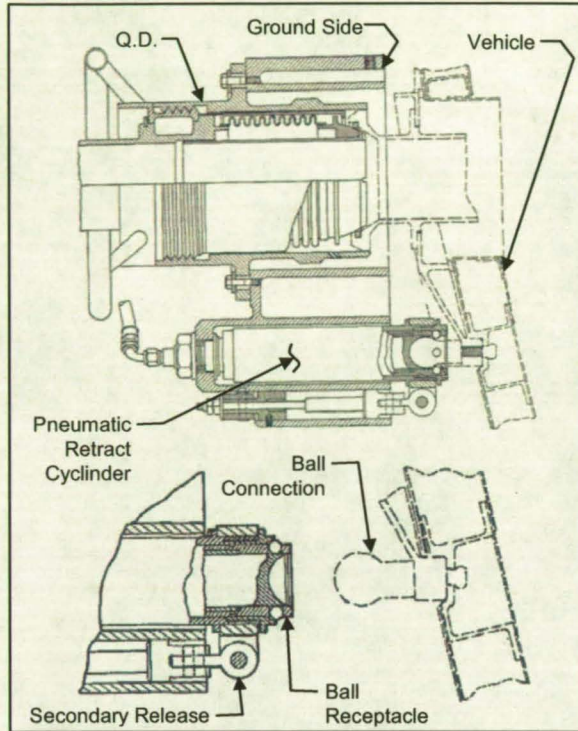

Figure 16. Ball-Locking Type Mechanism

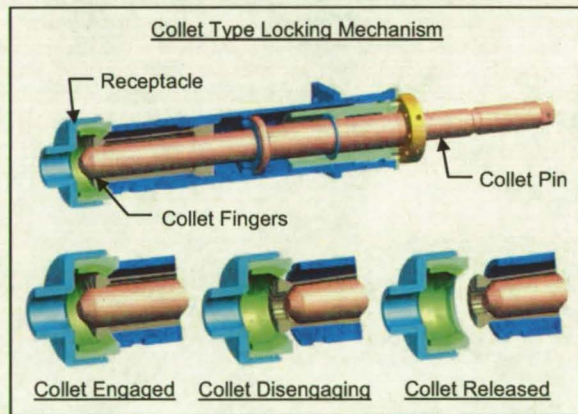

Figure 17. Collet Type Locking Mechanism

A second type of locking mechanism used for locking/release is the collet. This type of device uses a pin to radially expand fingers that are captured by the flight side receptacle (Figure 17). During disengagement, the pin is pulled, releasing the fingers from the receptacle. For conditions where the pin is jammed, a secondary system provides additional force for release. As a third option the vehicle receptacle can have a shear pin designed to fail at a given load. This

design has been used extensively on current vehicles. During the early development of release mechanisms, detailed studies were done on the ball-lock and collet locking mechanisms [11].

3.2. Fluid Quick Disconnects

Quick disconnects (QD) provide fluid servicing either directly to the vehicle or to a mobile facility. Considerable effort has been made in developing QDs for various types of applications [15]. They can range from sizes of 1/4 in. to 8 in. and can be of the latching or non-latching type. Generally non-latching QDs are used for application where separate locking mechanisms are used for mating umbilical plates together. Figure 18 shows a bellows type QD that uses the bellows preload and pressure for sealing a spherical mating surface. The bellows is a special formed section that acts as a spring. These types of QDs are typically used for T-0 umbilicals to minimize alignment issues during disconnect. Additionally, they may have poppets spring loaded on the groundside and/or flight side to isolate systems after separation. A single ground side poppet is shown.

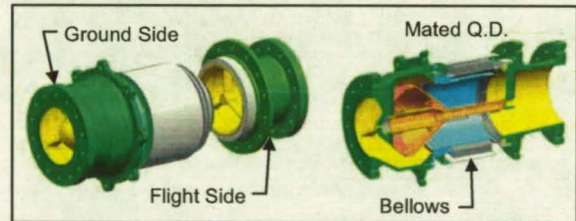

Figure 18. Bellows Type Quick Disconnect

A second type of QD uses a slip on design where seals are used between the circumferential surfaces (Figure 19). This type of design minimizes QD interface loads from pressure and preloads but requires a longer engagement.

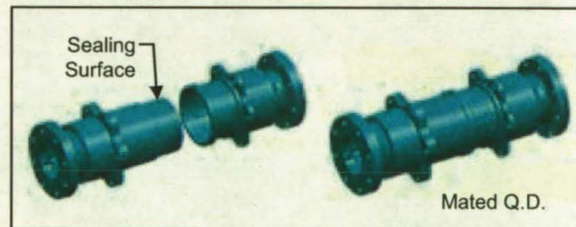

Figure 19. Slip on Type Quick Disconnect

4. Design Criteria

Government and international design criteria and standards provide design requirements for individual

components as well as quality assurance provisions for safe designs [1, 3, 4, 6]. For specific requirements, a unique design specification for each umbilical system is required. These requirements typically include functional and dimensional interface documents defining commodity requirements, operational timelines, interface loads and excursion limitations.

One of the most important aspects of umbilical designs is the certification of the systems to environmental and operational conditions. Table 2 summarizes general design and environmental loading conditions.

Based on the type of umbilical systems, GGU or GVU-T0, there can be a significant loading combination. For an example, wind loads may be insignificant for one design but they can be a major factor for another. For each design these conditions need to be evaluated.

Table 2. Ground Umbilical Design Load Matrix

Umbilical Systems Operational Conditions and Structural/Interface Load Design Matrix (Reference Only)								
Structural and Interface Load Conditions		Operational Conditions						
		Mate/Demate Oper.	Liftoff-Normal Release	Liftoff-Secondary Release	Liftoff-Tertiary Release	Flight Readiness Firing (FRF)	Shut - Down	Launch (After Release)
Design and Environmental Applied Loads	Load (Dynamic) Factors	GVU-T0 / GGU	GVU-T0	GVU-T0	GVU-T0	GVU-T0	GVU-T0	GVU-T0
	Wind Loads	GVU-T0 / GGU	GVU-T0 / GGU	GVU-T0 / GGU	GVU-T0 / GGU	GVU-T0 / GGU	GVU-T0 / GGU	GVU-T0 / GGU
	Ignition Over-pressure	---	---	---	---	GVU-T0 / GGU	GVU-T0 / GGU	GVU-T0 / GGU
	Acoustical Loads	---	---	---	---	GVU-T0 / GGU	GVU-T0 / GGU	GVU-T0 / GGU
	Vibrational Loads	---	---	---	---	GVU-T0 / GGU	GVU-T0 / GGU	GVU-T0 / GGU
	Shock Loads	---	GVU-T0	GVU-T0	GVU-T0	GVU-T0 / GGU	GVU-T0 / GGU	GVU-T0 / GGU
	Thermal Loads	---	GVU-T0	GVU-T0	GVU-T0	GVU-T0 / GGU	GVU-T0 / GGU	GVU-T0 / GGU
	Seismic Loads	GVU-T0 / GGU (A)	---	---	---	---	---	---
Umb. Interface Loads	Alignment System Loads	GVU-T0 / GGU	---	---	---	---	---	---
	Q.D. Preloads	GVU-T0 / GGU	GVU-T0	GVU-T0	GVU-T0	GVU-T0	GVU-T0	---
	Q.D. Fluid Loads	GVU-T0 / GGU	GVU-T0	GVU-T0	GVU-T0	GVU-T0	GVU-T0	---
	Q.D. Allowable Separation	---	GVU-T0	GVU-T0	GVU-T0	---	---	---
	Shear Pin Loads	GVU-T0 / GGU	GVU-T0	GVU-T0	GVU-T0	GVU-T0 / GGU	GVU-T0 / GGU	---
	Locking Mechanism Loads	GVU-T0 / GGU	GVU-T0	GVU-T0	GVU-T0	GVU-T0 / GGU	GVU-T0 / GGU	---

(A) - Non Operating Conditions (Survivability)

5. Project Milestones

For this phase of the AGUS project, primary design consideration was given to GGU and GVU-T0 required locking mechanisms, strut assemblies, quick disconnects and release mechanisms.

The top level initiatives of the AGUS project have been to 1) improve the efficiencies of GGU systems based on lessons learned from previous designs and operations and 2) to optimize operations for GVU, in

particular T-0s.

The GGU systems (Figure 20) efforts have included: improvement of the strut mechanism and connections, improved thermal isolation of QDs with particular development of a self-aligning vacuum jacketed QD for application with cryogenic systems (Figure 21), improved flex hose management and an on-going development of an integral alignment/locking mechanism.

For the GVU-T0 umbilical, a strut system with six degrees of freedom (DOF) is being studied to automate mating operations (Figure 22). This effort requires significant consideration in developing primary, secondary and tertiary disconnect mechanisms integral to the mating systems.

The product of this study phase is technical documentation of existing systems (Volume I), and design concepts and improvements for future systems (Volume II). To date, specific documentation of umbilical systems, classification and documentation of quick disconnects, concepts of self-aligning locking mechanisms and strut configuration have been done.

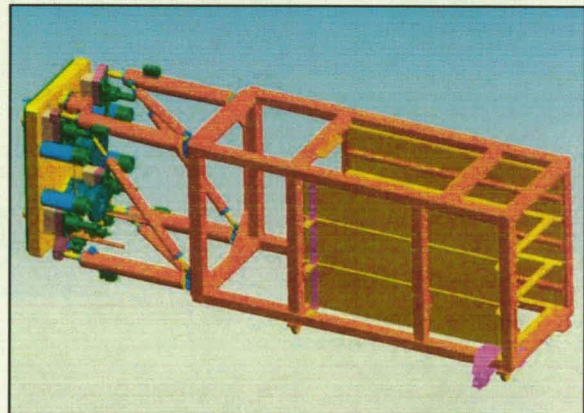

Figure 20 GGU System Concept

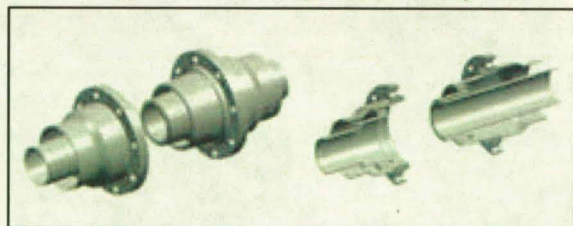

Figure 21 Vacuum-Jacketed Self Aligning QD

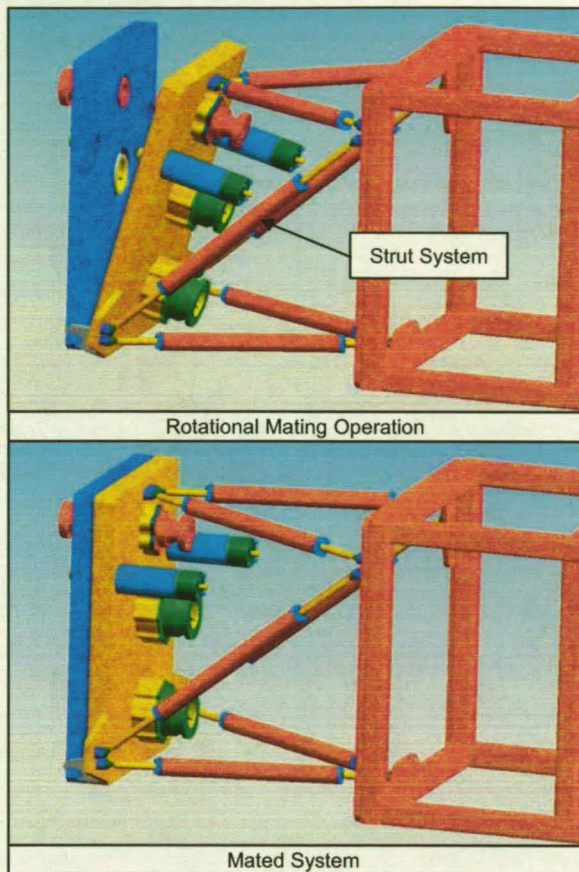

Figure 22 GVV-T0 System Concept

6. References

- [1] National Aeronautics and Space Administration. (1993, May). *Design Criteria for Reusable Space Vehicle Umbilical Systems*, GP-986, Rev. A, by Eng. Development Directorate.
- [2] National Aeronautics and Space Administration (1963, October 1). *Umbilical Systems V-2 to Saturn V*, M-P & VE-M-7-63. by Ground Support Equipment Branch Vehicle Systems Division Propulsion and Vehicle Eng. Laboratory.
- [3] International Standard (ISO 2001) *Space Systems – Flight-to-ground umbilicals*, ISO 15389, by Technical Committee ISO/TC20, Aircraft and space vehicles, Subcommittee SC 14, Space systems and operations.
- [4] International Standard (ISO 2005). *Space Systems – Flight-to-ground umbilicals*, ISO 15389, Amendment 1. by Technical Committee ISO/TC20, Aircraft and space vehicles, Subcommittee SC 14, Space systems and operations.
- [5] World Spaceflight News. Special Report. Copyright 2000. *Saturn V America's Apollo Moon Rocket*. by Progressive Management.

- [6] National Aeronautics and Space Administration. (2006, June 13). *Design and Development Requirements for Mechanisms*, NASA-STD-5017. NASA Technical Standard.
- [7] Chrysler Corporation Space Division. (1964, April). *SA-9 Vehicle and Launch Complex Functional Description Launch Pad Accessories*, HEC-D042, Volume VII, by Engineering Communications Department.
- [8] National Aeronautics and Space Administration (1972, June 2). *Umbilical Connect Techniques Improvement Technology Study*, NAS 10-7702 by: General Dynamics Convair Aerospace Division.
- [9] Littlefield, A. and Melton G., 2000. *Design, Development, and Testing of Umbilical System Mechanisms for the X-33 Advanced Technology Demonstrator*. Proceedings of the 34th Aerospace Mechanisms Symposium, 10-12 May 2000 Goddard Space Flight Center.
- [10] National Aeronautics and Space Administration (1962, August 15). *Concept Study Report Launch Complex 39 Umbilical Arms*, LTIR-2-DE-62-2, by: Launch Equipment Branch Launch Support Equipment Office.
- [11] National Aeronautics and Space Administration. *Design Handbook Umbilical Locking Mechanism Development Program*, NASA CR-1021 by: Cusick, D., Chrysler Corporation.
- [12] National Aeronautics and Space Administration (1970, August). *Interaction with Umbilicals and Launch Stand*, NASA Space Vehicle Design Criteria (Structures), NASA SP-8061.
- [13] Ray J., 2002, August 13. Atlas 5 changes the way rockets are prepared to fly. *Spaceflight Now*.
- [14] USA Update, 2003, USA's Innovative Autocoupler Utilized on Atlas V Functions as Planned, January/February, Issue 39, p. 5.
- [15] National Aeronautics and Space Administration, (1977, May). *Liquid Rocket Disconnects, Couplings, Fittings, Fixed Joints, and Seals*, NASA Space Vehicle Design Criteria (Chemical Propulsion), NASA SP-8119.

Automated Ground Umbilical Systems (AGUS) Project

Armand Gosselin

**LSDE Technical Analysis
USA GO Engineering**

Introduction

- All space vehicles require ground-to-vehicle umbilicals (GVU) and can include ground-to-ground umbilical (GGU) systems for servicing
 - Ground-to-Ground Umbilicals (GGU) require mating/de-mating of ground service equipment (GSE) to mobile facilities
 - Ground-to-Vehicle Umbilicals (GVU) can be of two subtypes:
 - Ground-to-Vehicle Pre-Launch (GVU-PL)
 - Servicing is completed prior to launch with umbilical de-mated for launch
 - Ground-to-Vehicle T-0 (GVU-T0)
 - Servicing is done up to and including launch with final disconnect at liftoff (T-0)

Atlas-V



Apollo

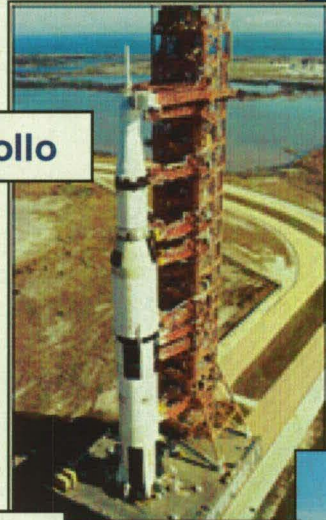

Shuttle



X-33

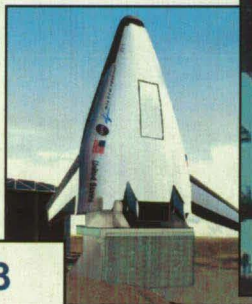

Constellation

Introduction (cont'd)

- **Servicing requirements can include, but are not limited to:**
 - **Electrical power, control and instrumentation**
 - **Propellant loading and venting**
 - **Pneumatic system supply**
 - **Hazard gas detection and purging**
 - **Environmental control and ground coolant systems**
 - **System checkout including leak checks & continuity verification**

Ground / Flight Panel Subassembly / Component Overview

- Of the various types of umbilicals, all require several common subsystems
 - These typically include:
 - Alignment, mating and locking systems, fluid connectors, electrical connectors and control/checkout systems. These systems have been designed to various levels of detail based on the needs for manual and/or automation requirements.

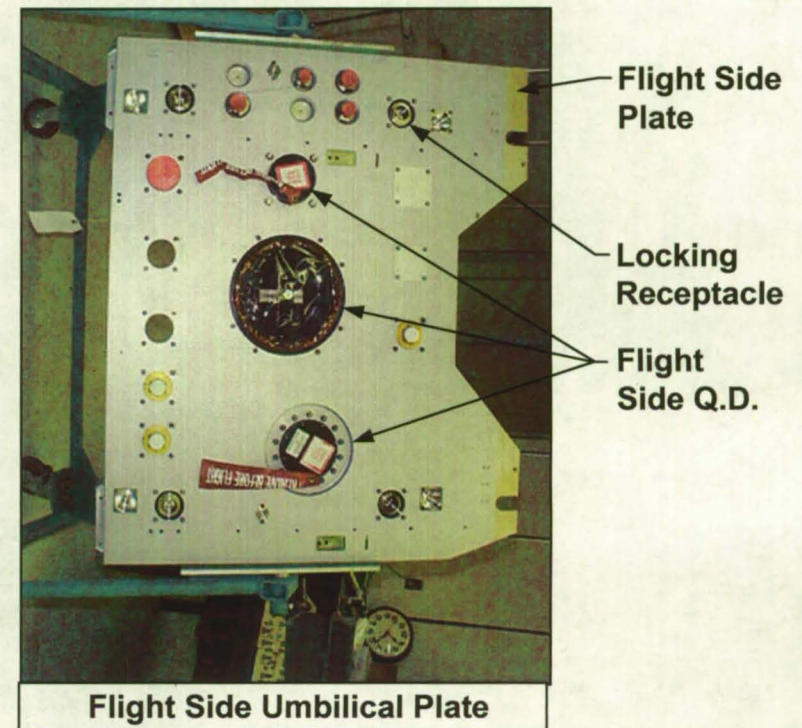
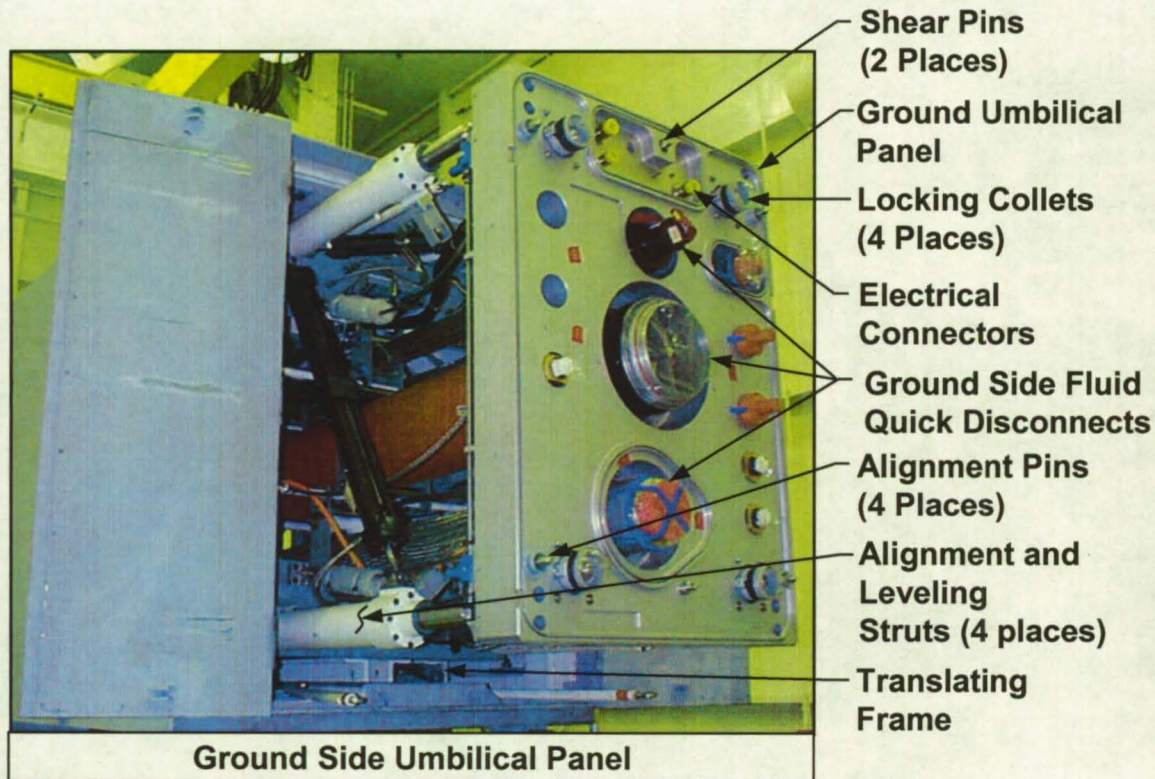

Typical Alignment, Mating and Locking Systems

- Pneumatically actuated linkage assembly used on the Saturn V S-IC Intertank umbilical
- Simple ball and socket type of locking device where a sleeve captures multiple balls around a ball connection
- Collet type of device uses a pin to radially expand fingers that are captured by a flight side receptacle

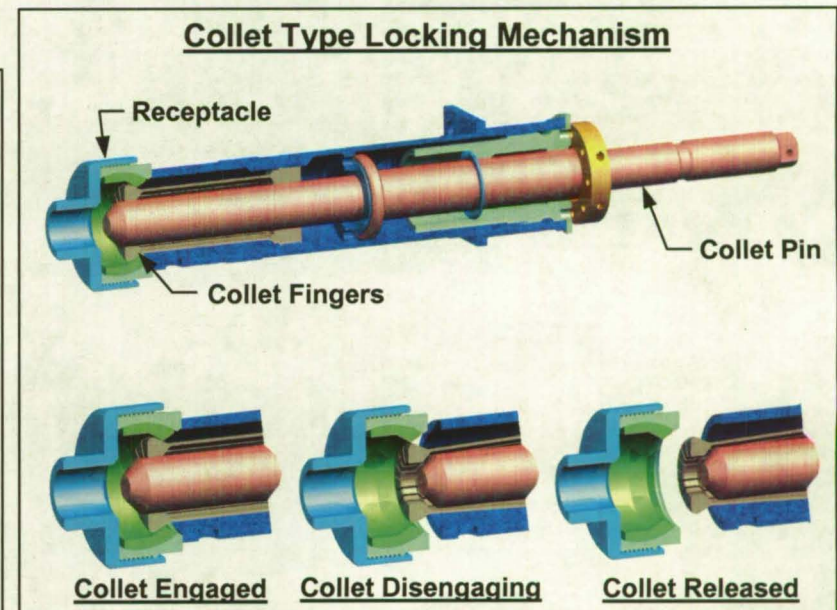
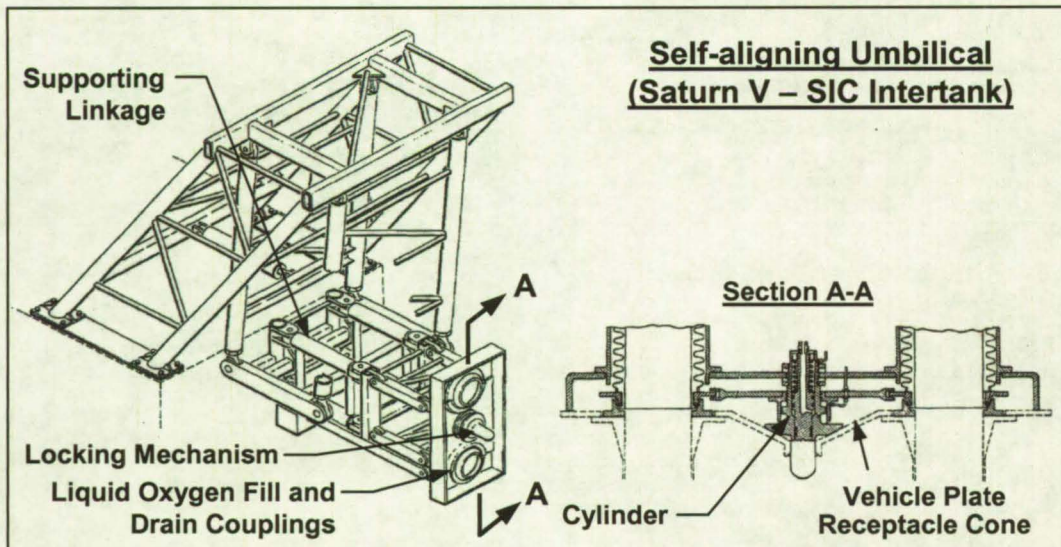
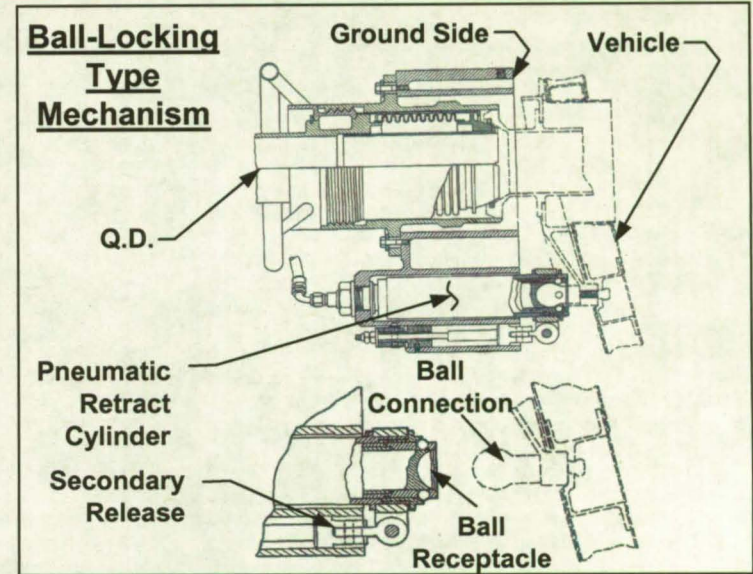

Fluid Quick Disconnects (QD) Types

- Quick disconnects (QD) provide fluid servicing either directly to the vehicle or to a mobile facility
- Bellows type QD uses the bellows preload and pressure for sealing spherical mating surfaces and to minimize alignment issues during disconnect
- A slip on design, where seals are used between the circumferential surfaces, minimizes QD interface loads from pressure and preloads but requires a longer engagement

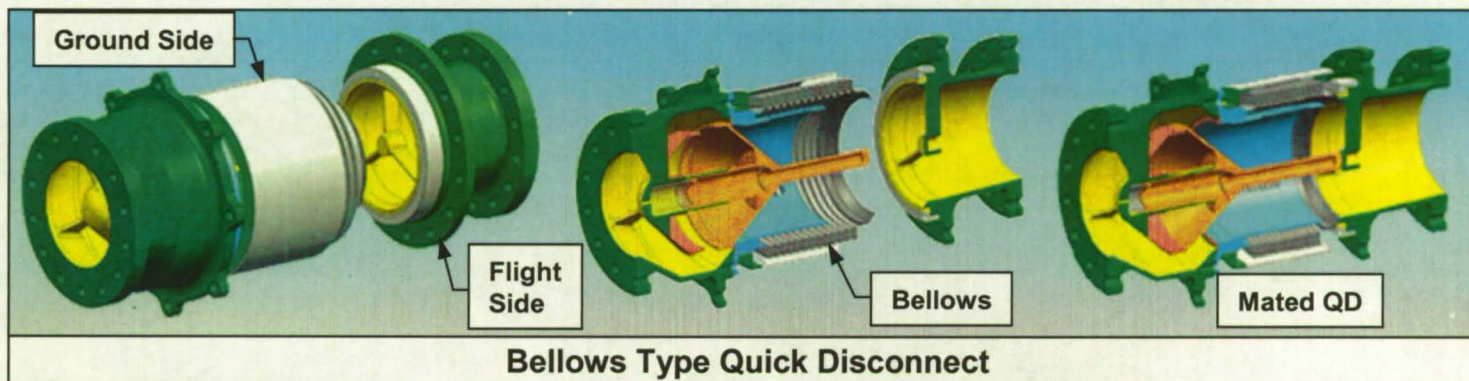
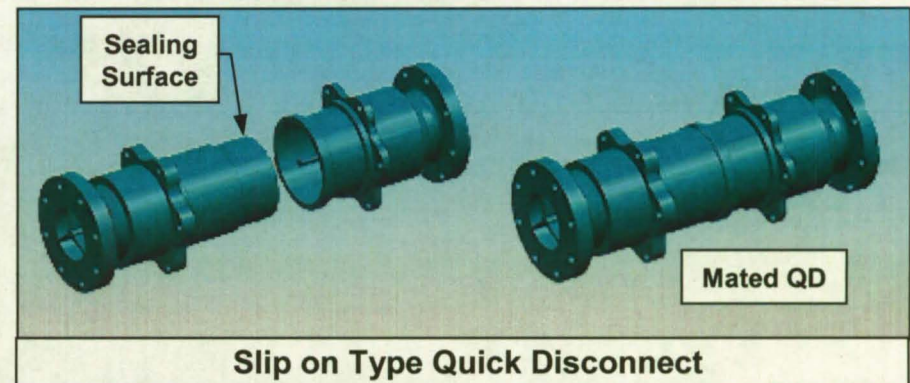
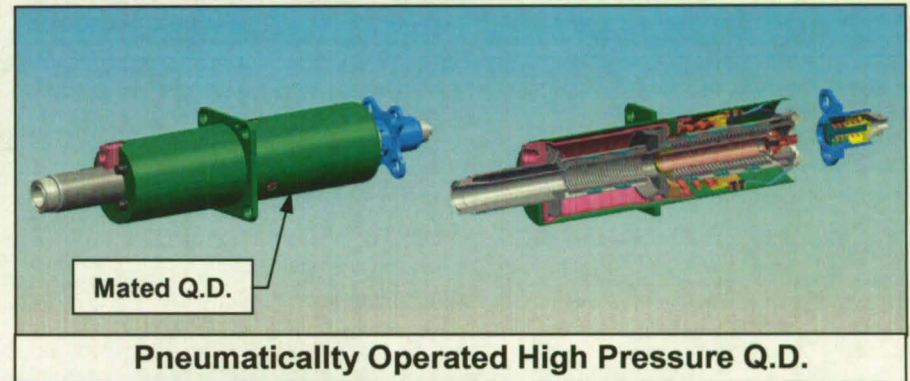

AGUS Project Goals

- **The Automated Ground Umbilical Systems (AGUS) project is a multi-phase initiative to develop design performance requirements and concepts for launch system umbilicals**
 - **The automation aspect minimizes operational time and labor in ground umbilical processing while maintaining reliability**
- **This current phase of the project reviews the design, development, testing and operations of ground umbilicals built for the Saturn, Shuttle, X-33 and Atlas V programs**
 - **Based on the design and operations lessons learned from these systems, umbilicals can be optimized for specific applications**
- **The products of this study are documents containing details of existing systems and requirements for future automated umbilical systems with emphasis on design-for-operations (DFO)**

The Saturn V Program Service Arms

- The Saturn V program incorporated lessons learned and design experience from previous umbilical projects, in particular the Saturn I systems
 - An extensive effort was done to capture umbilical systems design and development for application for the Saturn V program
 - These studies included the design, development and testing of various mating and retract umbilicals

Service Arm	① S-IC Intertank	② S-IC Fwd	③ S-II Aft	④ S-II IMD	⑤ S-II Fwd	⑥ S-IVB Aft	⑦ S-IVB Fwd	⑧ Service Module	⑨ Command Module
Type	Pre-Flight	Pre-Flight	Pre-Flight	In-Flight	In-Flight	In-Flight	In-Flight	In-Flight	Pre-Flight
Function Service	LOX Fill and Drain	Pneu., Elect. & A/C	Access to Vehicle	LH2, LOX, Vent Line, Pneu., Instr. Cooling, Elect. & A/C	GH2 Vent, Elect. & Pneu.	LH2, LOX, A/C, Pneu. & Elect.	Fuel Venting, Elect., Pneu. & A/C	A/C, Venting, Coolant, Elect. & Pneu.	Space Craft Access
Retract Time	8 sec. (Recnt.- 5 min.)	8 sec. (@ T-19 sec.)	Prior to Liftoff as Req'd	6.4 sec. (Max.)	7.4 sec. (Max.)	7.7 sec. (Max.)	8.4 sec. (Max.)	9 sec. (Max.)	Retract 12° until T-4 min. Extend Back from this point in 12 sec.

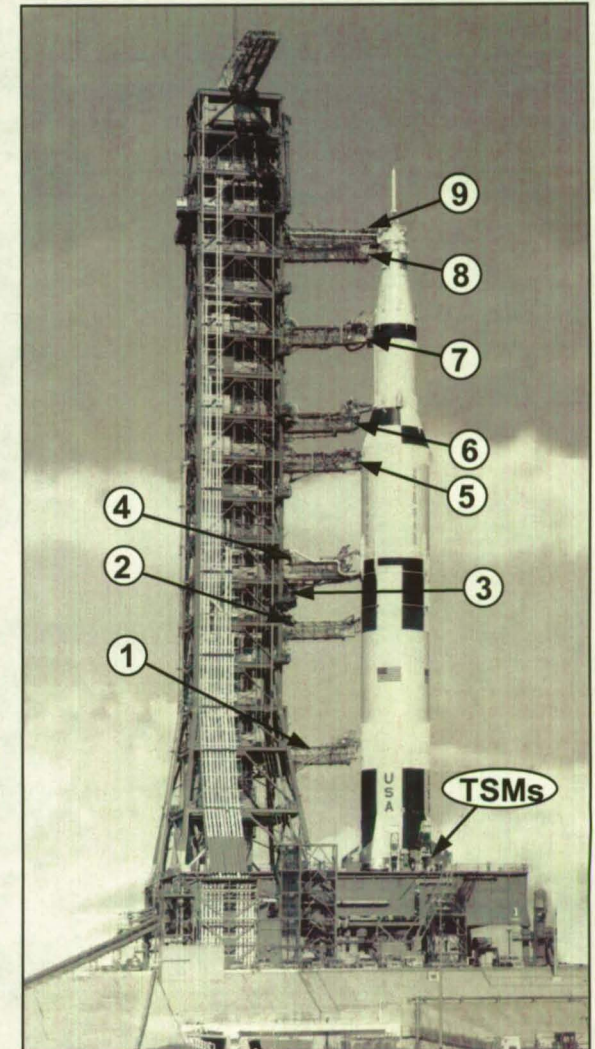

Saturn V Umbilical Disconnect Features

- Saturn inflight (T-0) service arms required umbilicals to disconnect in 1 second or less
- One of the most critical features of all T-0 systems was the ability to disconnect, under all conditions
 - The S-IVB Aft Service Arm (SA) ⑥, shown as an example, had a primary, secondary and a tertiary disconnect

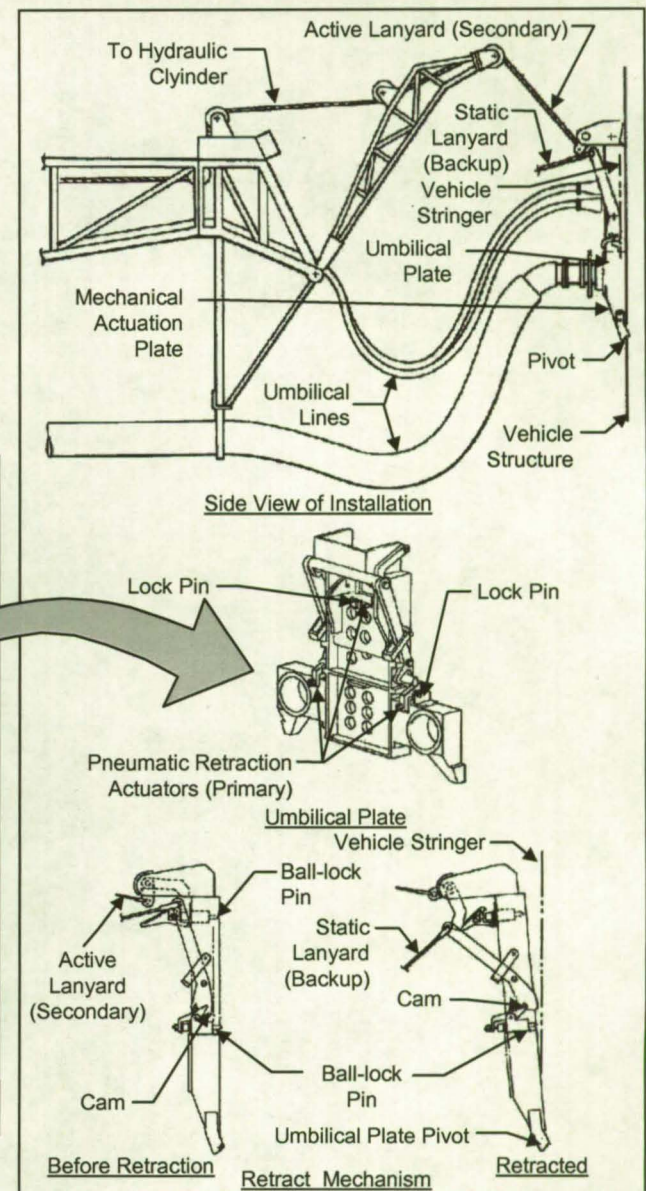
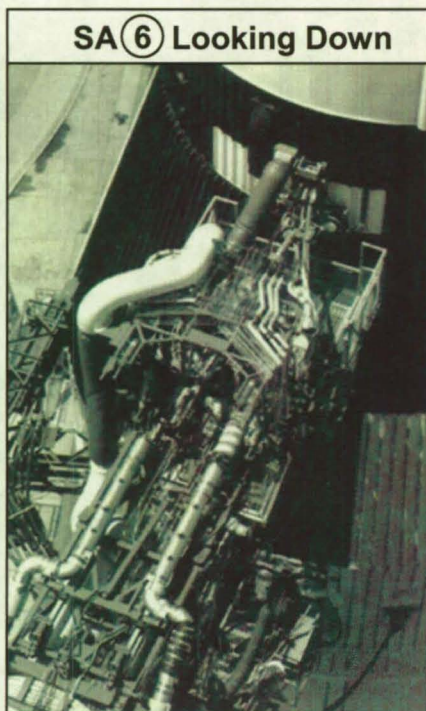
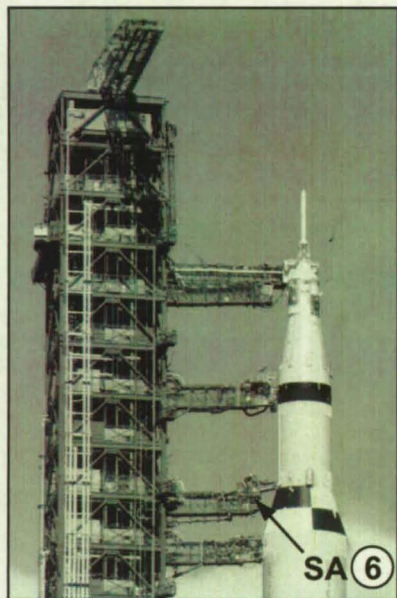

Saturn V Service Arm Retract Video

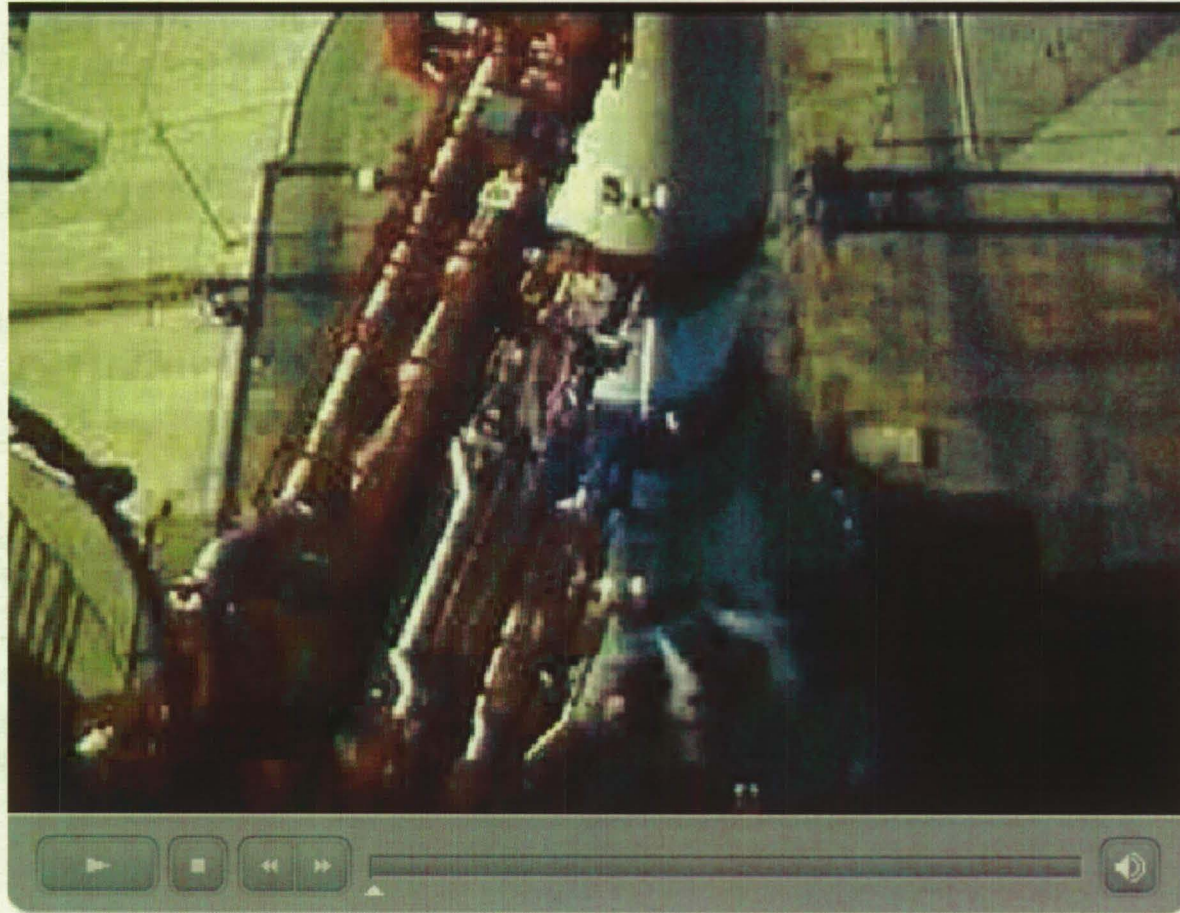

Shuttle Main Umbilical Systems

- The shuttle program utilizes several pre-launch and T-0 type umbilical systems for servicing the Solid Rocket Boosters (SRB), External Tank (ET) and Orbiter.
 - Pre-launch servicing of the Orbiter, as an example, was required for hypergolic systems as well as cryogenic fuel cell systems.
 - There are three main ground-to-vehicle T-0 systems, these include:
 - Liquid hydrogen (LH2) and liquid oxygen (LOX) Tail Service Masts (TSM)
 - External Tank Hydrogen Vent Umbilical System

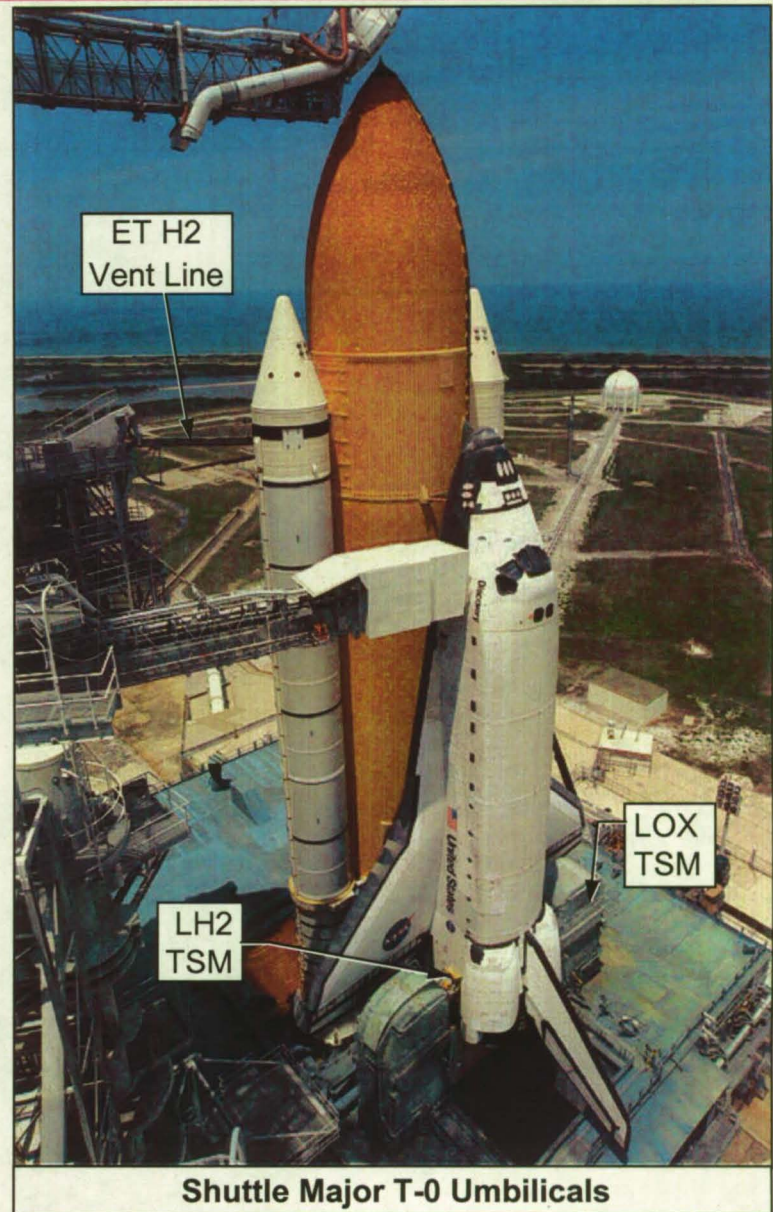

Shuttle LH2 Tail Service Mast (TSM)

- The Tail Service Masts (TSM) are the main fluid and electrical connections between the Space Shuttle's Orbiter and the ground launch facility
 - The TSMs are a launch lift-off umbilical or (T-0) umbilical that disconnect from the vehicle at ignition of the Solid Rocket Boosters (SRB).

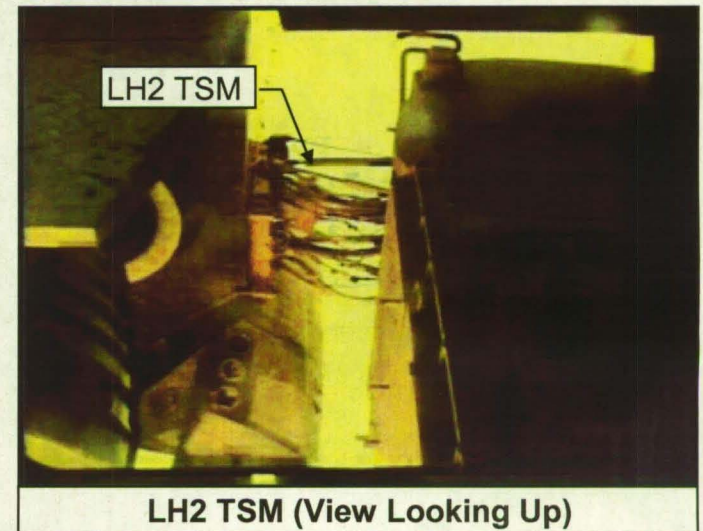
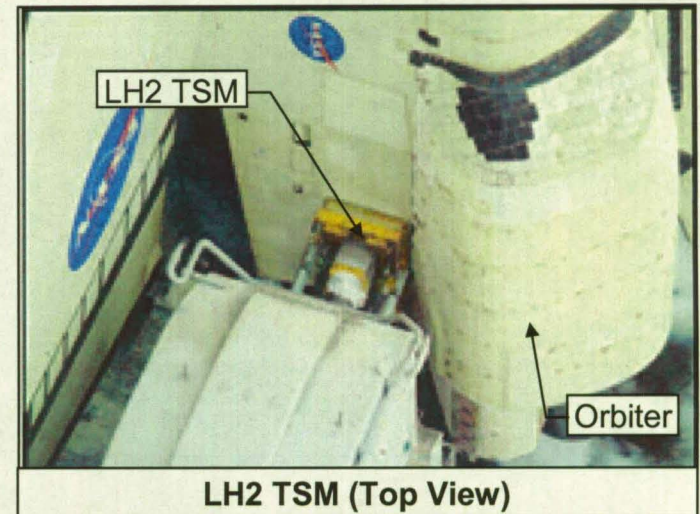

Shuttle Orbiter LH2 TSM Ground & Vehicle Side Umb. Plates

Collet Receptacle Flight Side QD

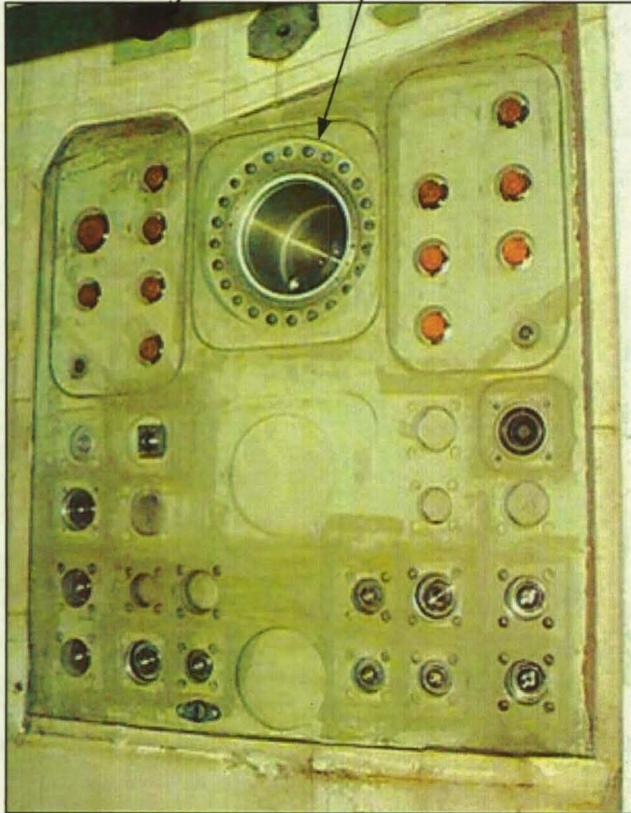

Shuttle LH2 Vehicle Side Plate

Ground Side QD Collet



Shuttle LH2 Ground Side Umbilical

LH2 TSM T-0 Umbilical Release Video

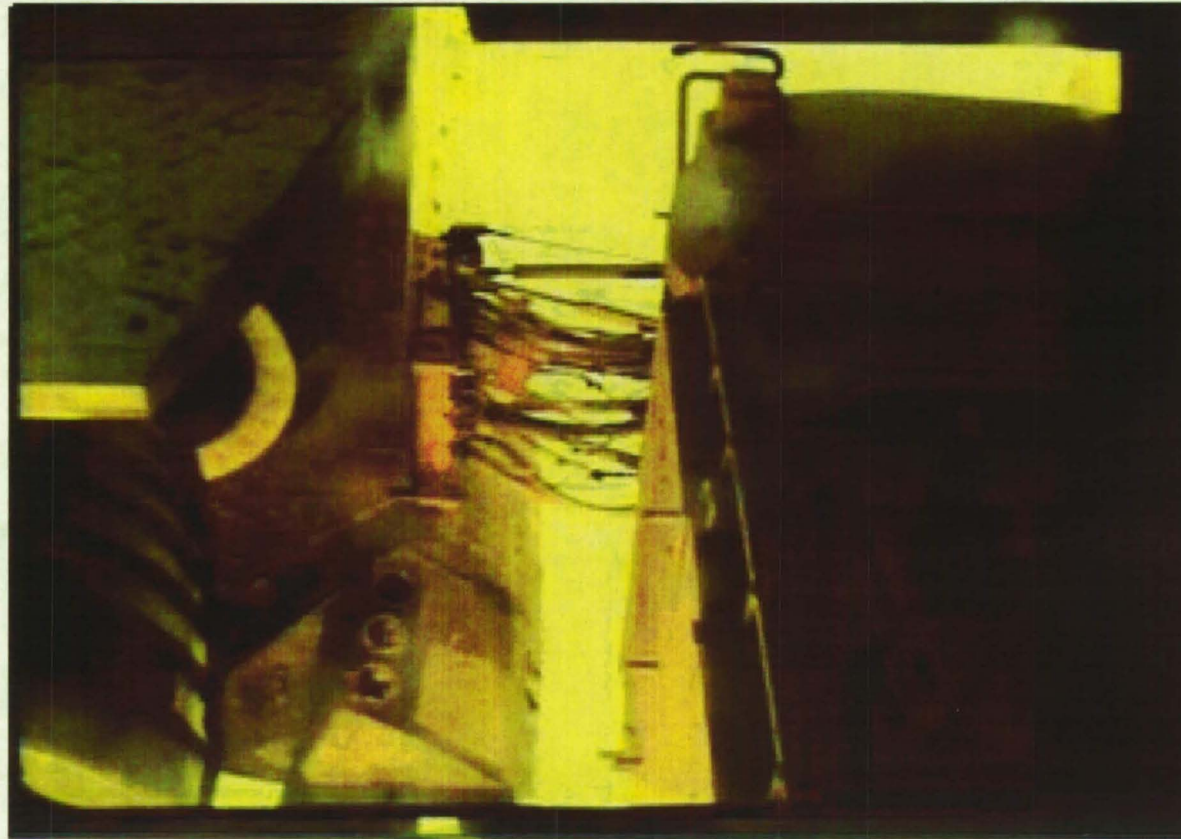

Shuttle ET Hydrogen Umbilical T-0 System

- The ET Hydrogen Vent Umbilical System provides the capability to vent the Space Shuttle ET during and after LH2 loading
 - It also provides the vehicle to ground systems connection of various required fluid and electrical service lines.
- The umbilical system is designed to disconnect at the SRB ignition command (T-0)
 - Following disconnect, the umbilical vent line retracts downward, and secures inside the facility structure

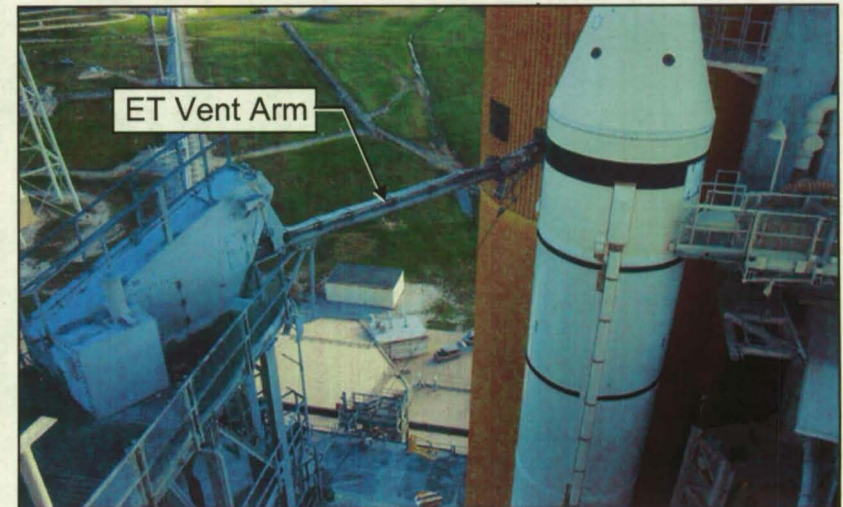

ET H2 Vent Arm

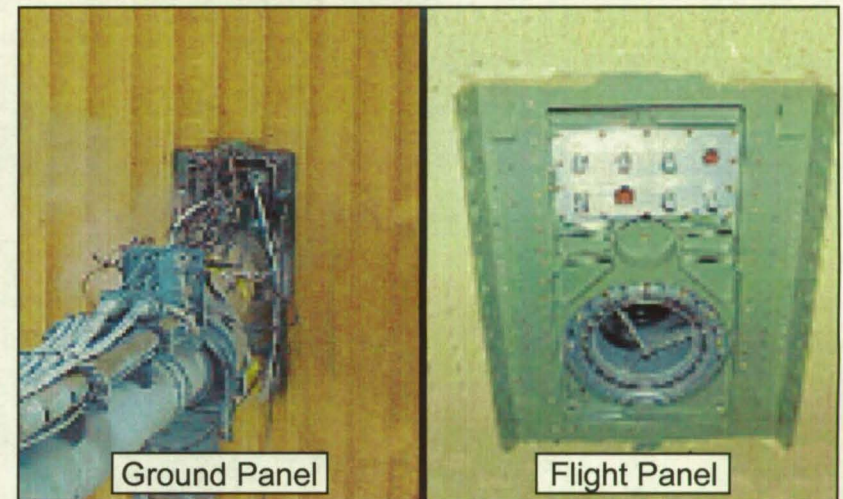

ET H2 Ground and Flight Panels

Shuttle ET Vent Umbilical Release Video

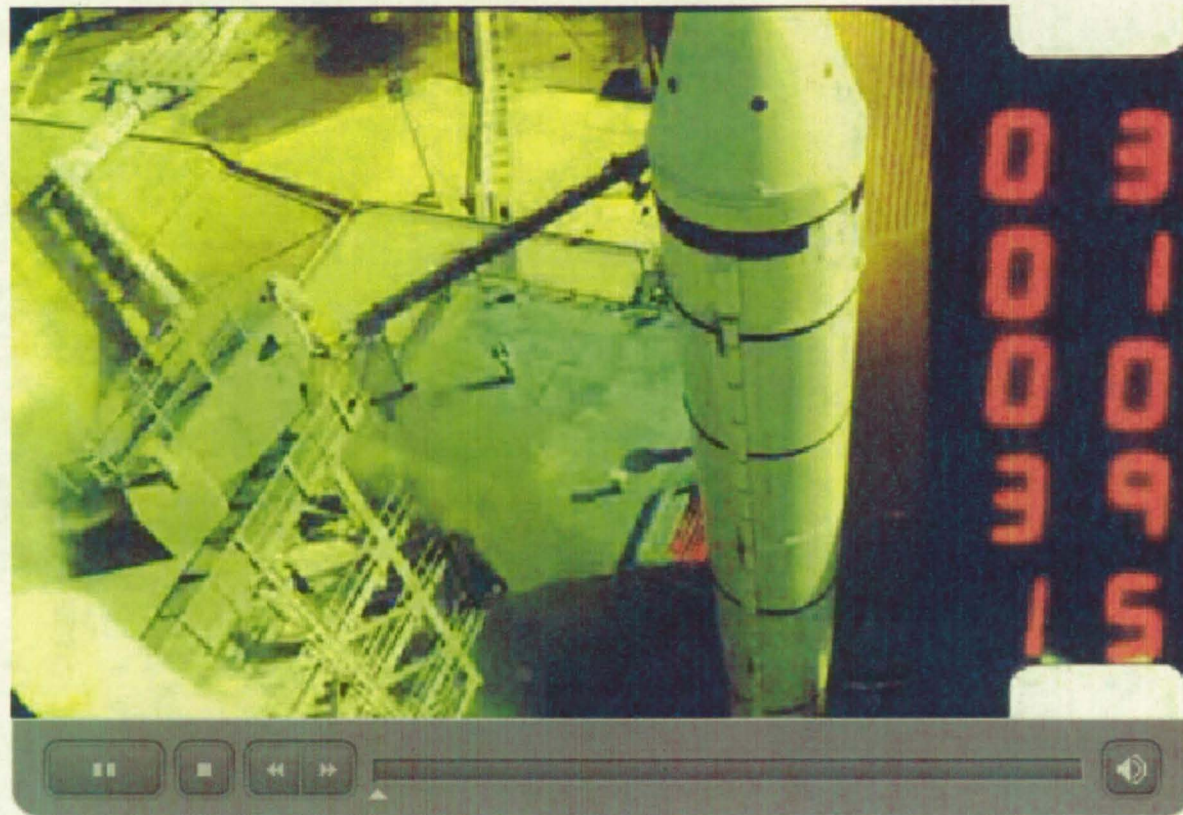

Shuttle Centaur Rolling Beam Umbilical System (RBUS)

- The Rolling Beam Umbilical System (RBUS) was developed to support DOD Shuttle payloads. The T-0 system was tested and installed but never used
- The RBUS connected two cryogenic oxygen and hydrogen lines to the Orbiter
 - A translating truss extended 36 –38 feet at an upward angle to meet the vehicle.
 - The RBUS used rigid commodity lines and a ground-side disconnect at the end of the translating truss
 - Plate separation was less than a second with RBUS complete retraction in less than 3 seconds.

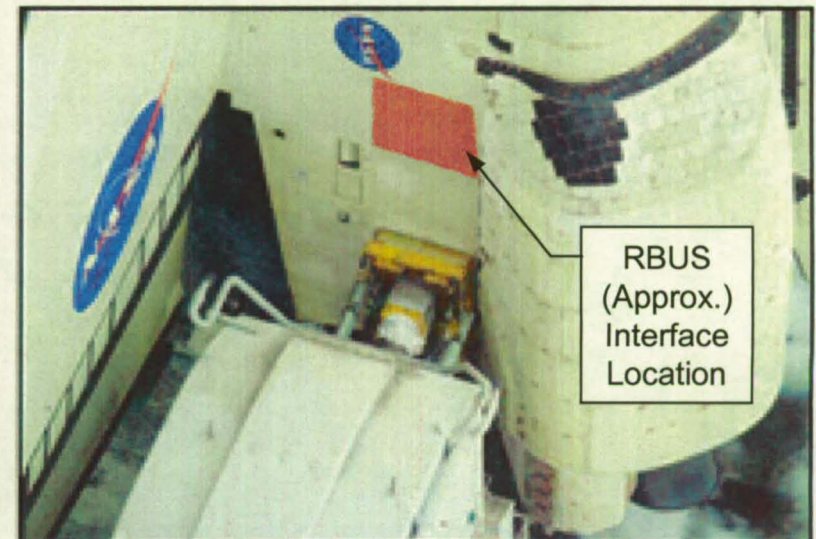
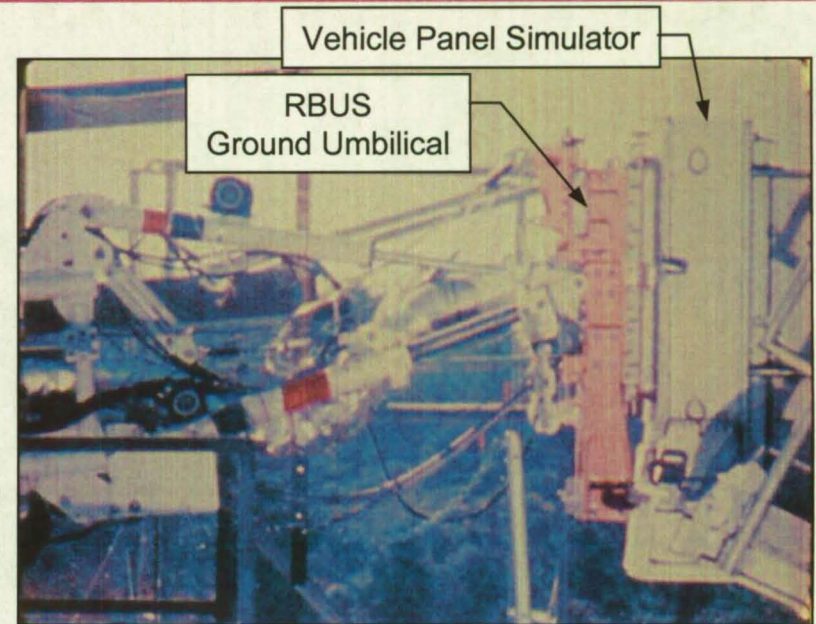

RBUS Retract Test Video

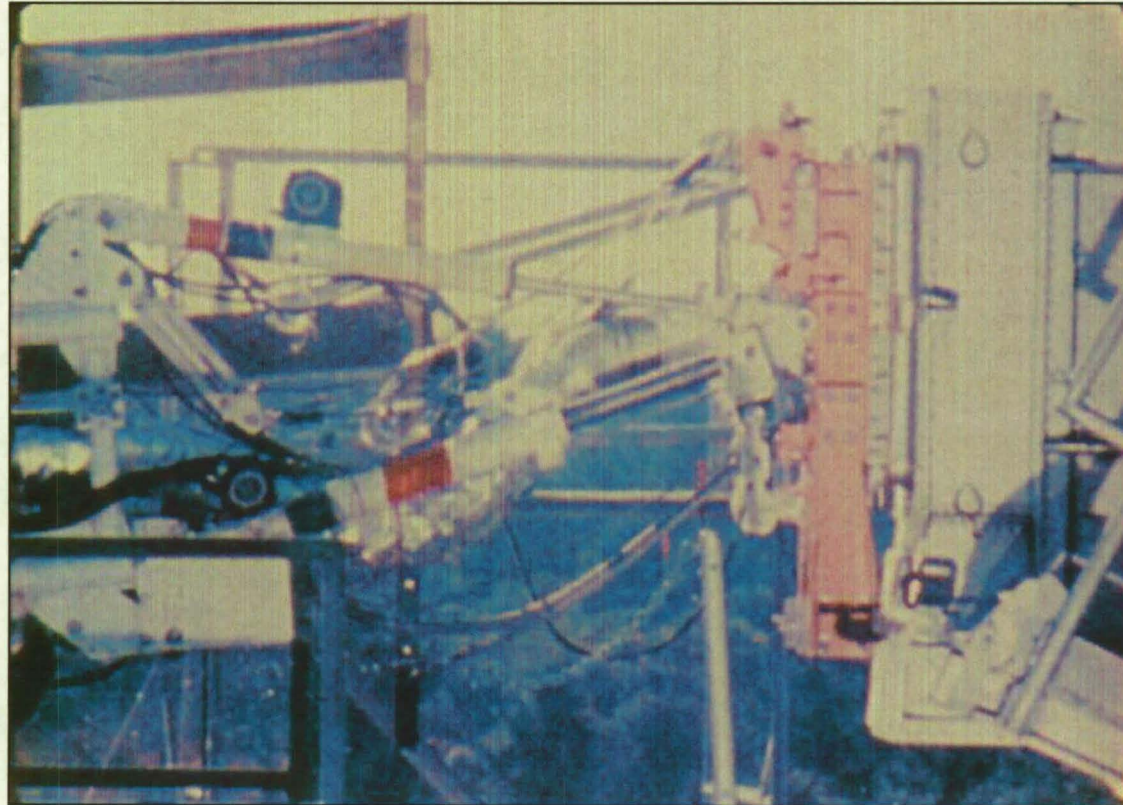

X-33 Advanced Technology Demonstrator

- The X-33 vehicle was a half scale design of the proposed single stage to orbit (SSTO) VentureStar
- Two independent oxygen and hydrogen T-0 rise-off umbilicals were required
 - The vehicle was connected to a rotating launch mount in the horizontal position, then rotated to the vertical launch position
 - At launch, lanyards connected to each of the locking devices would pull the collet pins, releasing the panels

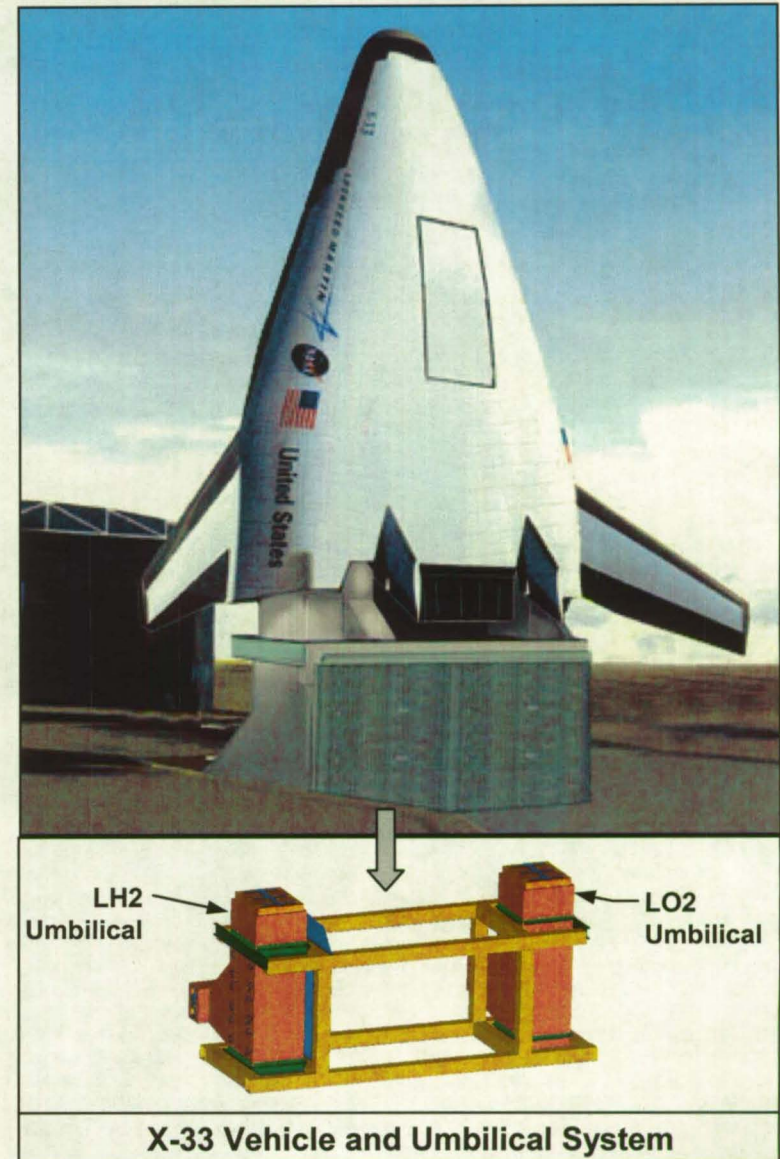
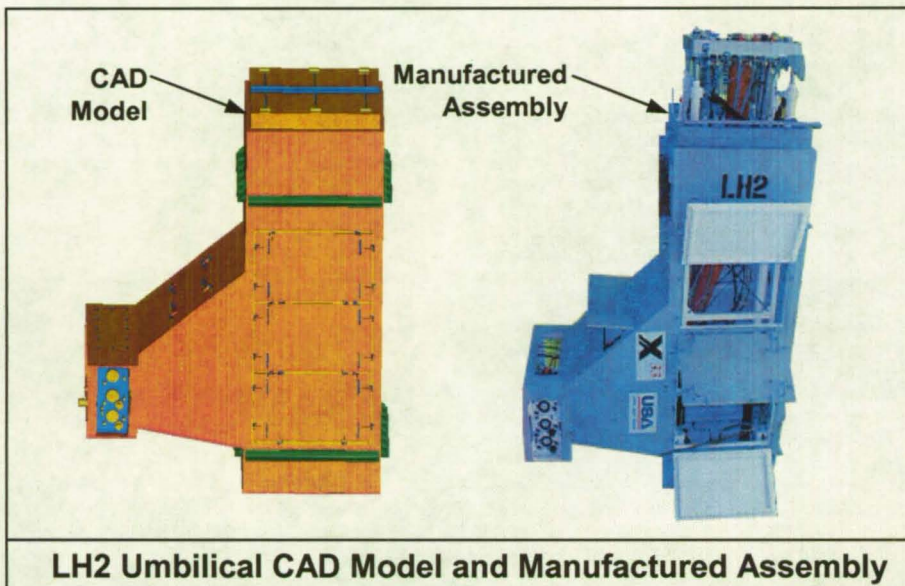

X-33 Umbilical Retract Test Video



Atlas V Autocoupler

- The Lockheed Martin Atlas V Autocouplers are a group of four, automated, ground-to-ground umbilical systems that connect the facility to the mobile launch platform (MLP)
 - The most prominent feature of the Autocoupler is the automated control system and leak detection system
 - The Autocouplers can be controlled remotely, or at each individual unit
 - Manual overrides can be performed



Atlas V Autocoupler Assembly
At KSC Test Site

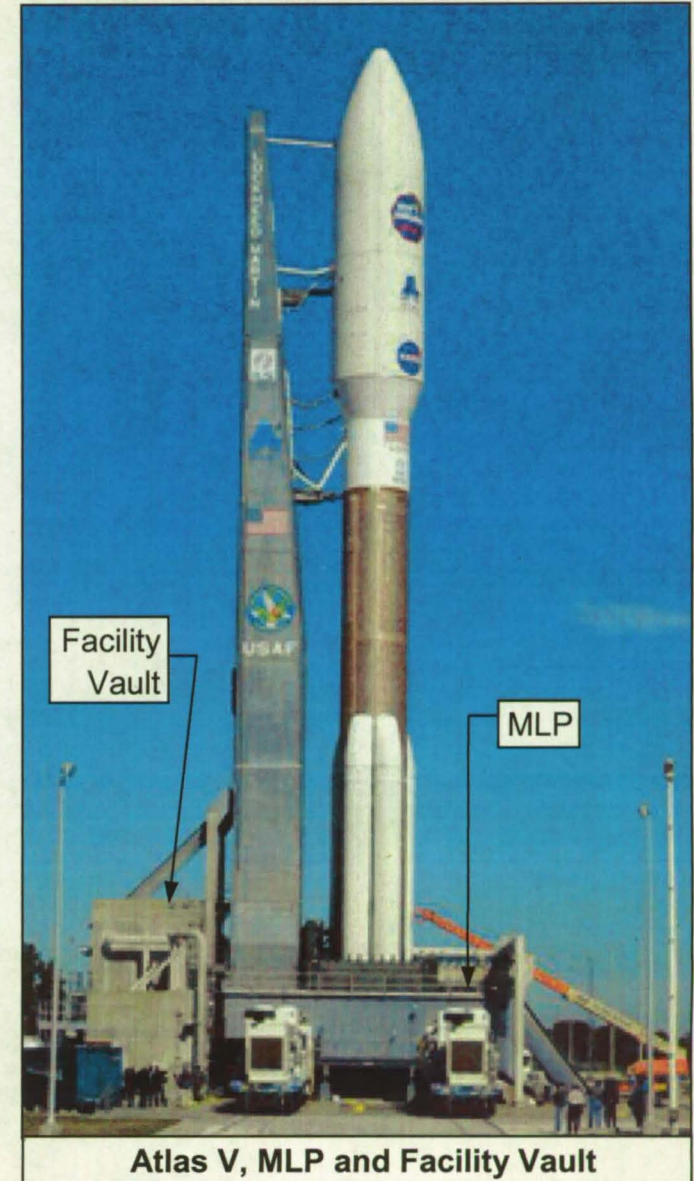

Atlas V, MLP and Facility Vault

Project Milestones

- **GVU-T0 umbilical efforts**

- Strut system with six degrees of freedom (DOF) for automating mating operations
- Significant consideration in developing primary, secondary and tertiary disconnect mechanisms integral to the mating systems

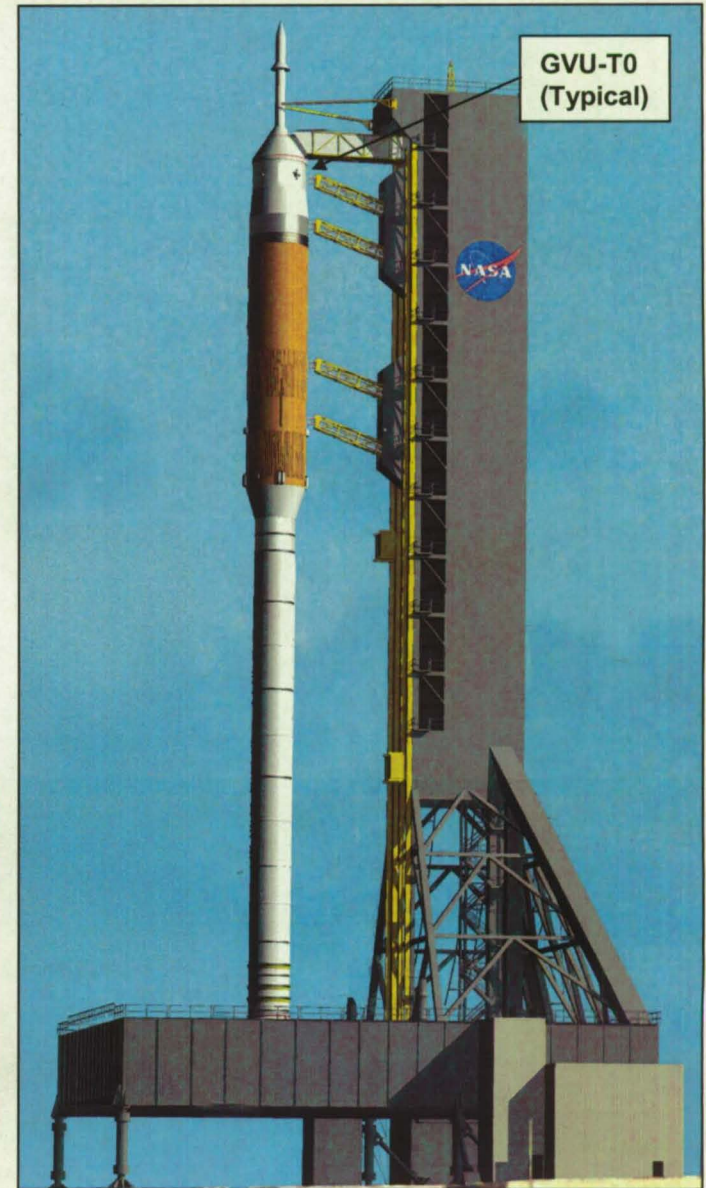
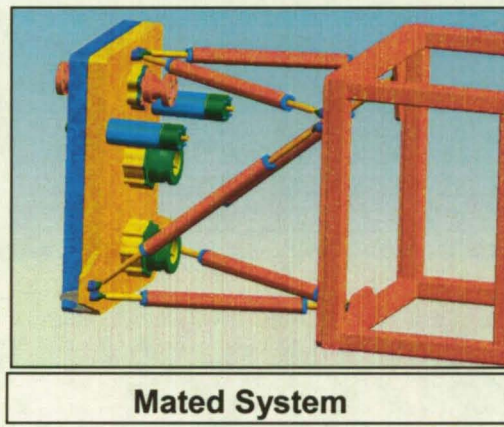
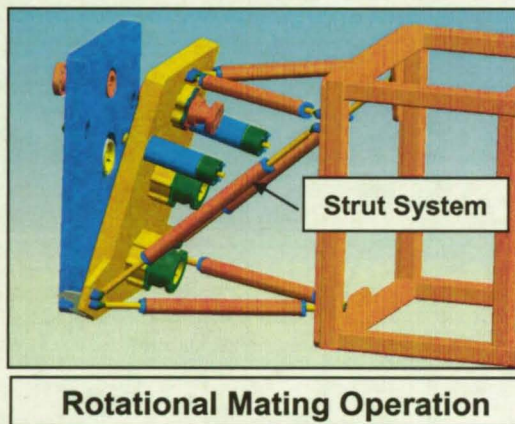

Project Milestones (cont'd)

- The GGU systems efforts have included:
 - Improvement of the strut mechanism and connections
 - Improved thermal isolation of QDs with particular development of a self-aligning vacuum jacketed QD
 - Improved flex hose management
 - On-going development of an integral alignment/locking mechanism.

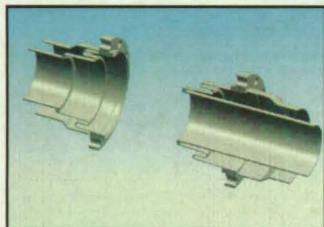

Vacuum Jacketed
Quick Disconnect

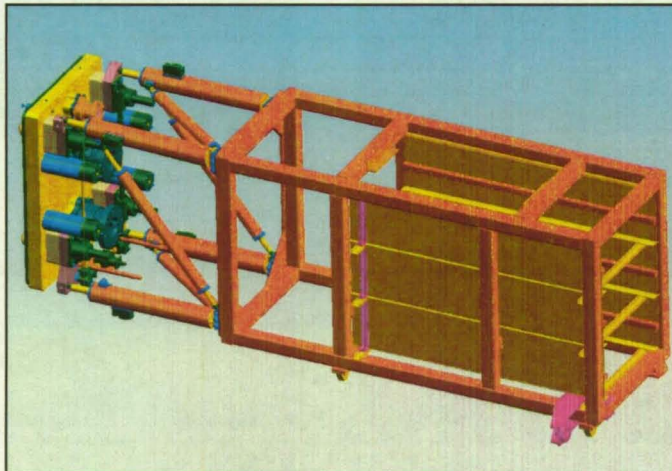

GGU Concept

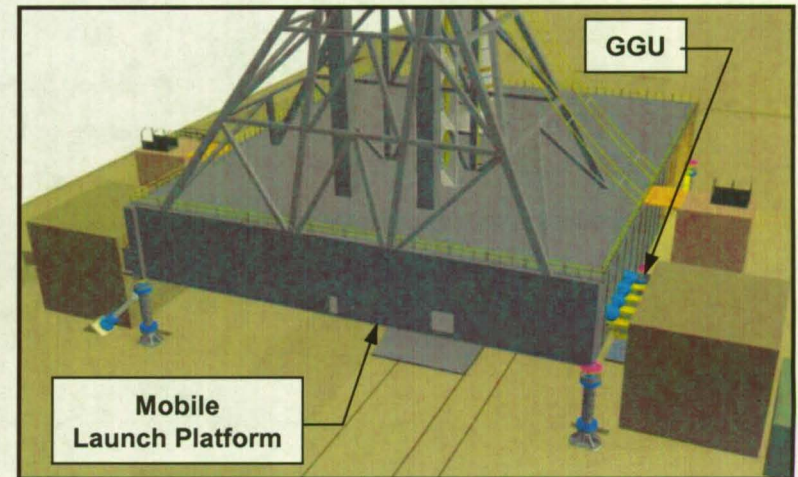

Summary

- **The product of this study phase is:**
 - **Technical documentation of existing systems (Volume I)**
 - **Design concepts/improvements for future systems (Volume II)**
 - **To date the following has been done:**
 - **Specific documentation of umbilical systems**
 - **Classification and documentation of quick disconnects**
 - **Concepts of self-aligning locking mechanisms and**
 - **Strut configuration**

REPORT DOCUMENTATION PAGE

Form Approved
OMB No. 0704-0188

The public reporting burden for this collection of information is estimated to average 1 hour per response, including the time for reviewing instructions, searching existing data sources, gathering and maintaining the data needed, and completing and reviewing the collection of information. Send comments regarding this burden estimate or any other aspect of this collection of information, including suggestions for reducing the burden, to Department of Defense, Washington Headquarters Services, Directorate for Information Operations and Reports (0704-0188), 1215 Jefferson Davis Highway, Suite 1204, Arlington, VA 22202-4302. Respondents should be aware that notwithstanding any other provision of law, no person shall be subject to any penalty for failing to comply with a collection of information if it does not display a currently valid OMB control number.

PLEASE DO NOT RETURN YOUR FORM TO THE ABOVE ADDRESS.

1. REPORT DATE (DD-MM-YYYY) 02-04-2007		2. REPORT TYPE Technical		3. DATES COVERED (From - To) Jan 2007 - April 2007	
4. TITLE AND SUBTITLE Automated Ground Umbilical Systems (AGUS) Project				5a. CONTRACT NUMBER NNJ06VA01C	
				5b. GRANT NUMBER	
				5c. PROGRAM ELEMENT NUMBER	
				5d. PROJECT NUMBER	
				5e. TASK NUMBER	
				5f. WORK UNIT NUMBER	
6. AUTHOR(S) Gosselin, Armand M.					
7. PERFORMING ORGANIZATION NAME(S) AND ADDRESS(ES) United Space Alliance - Launch Site Design Engineering USK-752 8550 Astronaut Blvd Cape Canaveral, Florida 32920-4304				8. PERFORMING ORGANIZATION REPORT NUMBER	
9. SPONSORING/MONITORING AGENCY NAME(S) AND ADDRESS(ES)				10. SPONSOR/MONITOR'S ACRONYM(S)	
				11. SPONSOR/MONITOR'S REPORT NUMBER(S)	
12. DISTRIBUTION/AVAILABILITY STATEMENT					
13. SUPPLEMENTARY NOTES					
14. ABSTRACT The Automated Ground Umbilical Systems (AGUS) project is a multi-phase initiative to develop design performance requirements and concepts for launch system umbilicals. The automation aspect minimizes operational time and labor in ground umbilical processing while maintaining reliability. This current phase of the project reviews the design, development, testing and operations of ground umbilicals built for the Saturn, Shuttle, X-33 and Atlas V programs.					
15. SUBJECT TERMS Ground Umbilicals					
16. SECURITY CLASSIFICATION OF:			17. LIMITATION OF ABSTRACT	18. NUMBER OF PAGES 10	19a. NAME OF RESPONSIBLE PERSON
a. REPORT	b. ABSTRACT	c. THIS PAGE			19b. TELEPHONE NUMBER (Include area code)