

GD SDR AUTOMATIC GAIN CONTROL CHARACTERIZATION TESTING

Jennifer M. Nappier (NASA Glenn Research Center, Cleveland, Ohio, United States, Jennifer.M.Nappier@nasa.gov); Janette C. Briones (NASA Glenn Research Center, Cleveland, Ohio, United States, Janette.C.Briones@nasa.gov)

ABSTRACT

The General Dynamics (GD) S-Band software defined radio (SDR) in the Space Communications and Navigation (SCAN) Testbed on the International Space Station (ISS) will provide experimenters an opportunity to develop and demonstrate experimental waveforms in space. The GD SDR platform and initial waveform were characterized on the ground before launch and the data will be compared to the data that will be collected during on-orbit operations. A desired function of the SDR is to estimate the received signal to noise ratio (SNR), which would enable experimenters to better determine on-orbit link conditions. The GD SDR does not have an SNR estimator, but it does have an analog and a digital automatic gain control (AGC). The AGCs can be used to estimate the SDR input power which can be converted into a SNR. Tests were conducted to characterize the AGC response to changes in SDR input power and temperature. This purpose of this paper is to describe the tests that were conducted, discuss the results showing how the AGCs relate to the SDR input power, and provide recommendations for AGC testing and characterization.

1. INTRODUCTION

The SCAN Testbed [1] was installed on the ISS in August 2012. The test bed consists of three software defined radios operating at S-Band, L-Band, and Ka-Band. It provides experimenters an opportunity to characterize the SDRs in space and to develop and test experimental waveforms. One of the radios operating at S-Band is the GD SDR.

In order to characterize the RF links from the Earth to the ISS, a SNR estimator is desired. A SNR estimator would provide experimenters with a more accurate estimation of link conditions. Unfortunately, due to time constraints, a SNR estimator was not delivered with the GD SDR. However, the GD radio has two automatic gain controls (AGCs) that can be used to estimate the SDR input power in order to calculate the SNR. The SNR can be calculated from the SDR input power, theoretical noise floor (-174 dBm/Hz), and receiver noise figure, and data rate:

$$E_b = P_{in} - 10\log_{10}(\text{Data Rate})$$

$$N_o = -\frac{174\text{dBm}}{\text{Hz}} + \text{NF}$$

$$\text{SNR} = E_b - N_o$$

$$E_b = \text{Energy per bit}$$

$$N_o = \text{Noise power spectral density}$$

$$P_{in} = \text{SDR calculated input power from AGCs}$$

$$-174\text{dBm/Hz} = \text{Theoretical noise floor}$$

$$\text{NF} = \text{Receiver noise figure}$$

$$\text{Data Rate} = 18000 \text{ or } 72000$$

2. GD SDR AND WAVEFORM OVERVIEW

The GD SDR is an S-Band Tracking Relay Data Satellite System (TDRSS) transponder. The SDR contains one reprogrammable 3 million gate Xilinx QPRO Virtex II FPGA and a microprocessor that runs the Space Telecommunications Radio System (STRS) Operating Environment (OE) [2]. The initial waveform loaded on the SDR can be reconfigured to operate in a number of different TDRSS modes [3] and the SDR has the capability in place that allows it to be reprogrammed with new waveforms in the future.

The tests described in this paper focus on the GD TDRSS forward link receive waveform, which has several reconfigurable functions. The SDR operates at two receive/transmit center frequency pairs, one for use with the single access (SA) TDRSS modes and one for use with the multiple access (MA) modes [3]. The receive waveform can be configured to operate at two data rates – 18 kbps and 72 kbps. The Viterbi decoder for forward error correction can be enabled and disabled. These three waveform parameters (center frequency, data rate, and error correction on/off) lead to the eight different possible receive waveform

Table 1: The GD SDR has three reconfigurable parameters that lead to eight different receive waveform combinations.

Waveform Number	Center Frequency	Data Rate (kbps)	Forward Error Correction
1	SA	18	Coded
2	SA	18	Uncoded
3	SA	72	Coded
4	SA	72	Uncoded
5	MA	18	Coded
6	MA	18	Uncoded
7	MA	72	Coded
8	MA <td 72	Uncoded	

configurations. A summary of the GD receive waveform configurations can be found in Table 1. The AGCs scale differently depending on the waveform configuration, so in order to fully characterize the AGCs it was necessary to collect AGC data in all eight waveform configurations.

The GD SDR has two AGCs – an analog AGC and a digital AGC. The AGCs adjust the received RF power to a constant level for receiver signal processing. The AGCs scale based on total RF power, so varying noise conditions or the presence of interferers will affect the AGC output. The analog AGC is located in the RF module and the digital AGC is located in the FPGA in the GD SDR. There is a 10 MHz wide filter located before the analog AGC and the digital AGC has a 6 MHz filter before it. A signal that falls outside the filter bandwidths will not be detected by the AGCs. When a forward link signal is initiated, the analog AGC adjusts the RF power it sees before waveform acquisition and then the digital AGC scales appropriately during the acquisition process. Since the digital AGC is downstream from the analog AGC, the digital AGC value is dependent on how the analog AGC scales. The analog AGC is a platform feature and the digital AGC is located in the waveform. The AGCs respond to changes in power or temperature quickly (<5 s) so hysteresis effects are not a factor.

3. AGC DATA COLLECTION

3.1 Test Objective

The objective for these tests was to determine the relationship between the SDR input power, SDR baseplate temperature, waveform configuration, and the digital and analog AGCs. The results will be used to create an algorithm to estimate the SDR input power from the digital AGC, analog AGC, SDR baseplate temperature, and waveform configuration. The algorithm could be

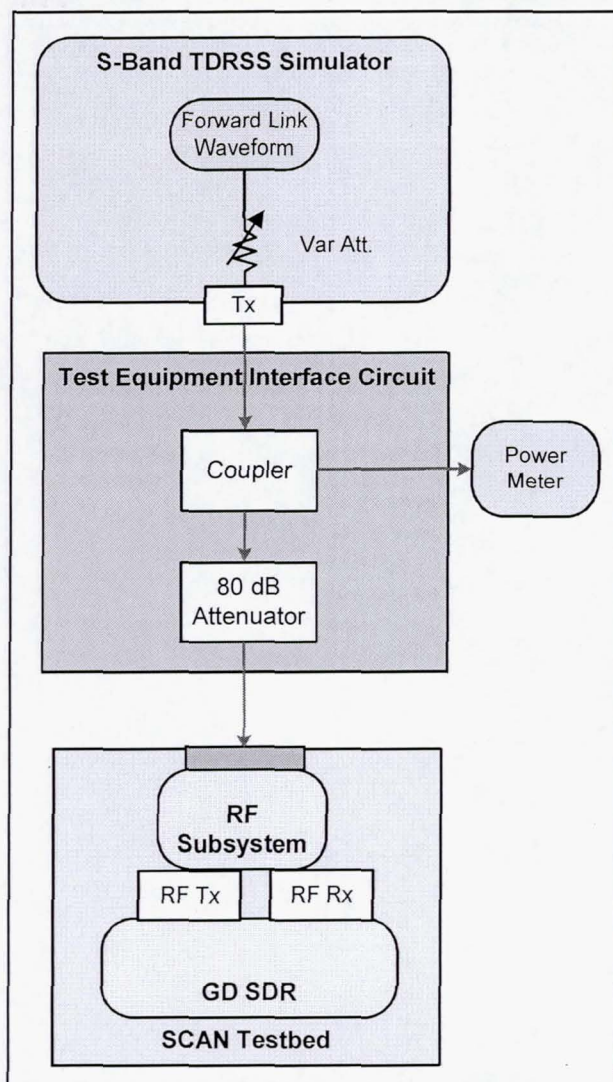

Figure 1: The GRC test setup consisted of a TDRSS simulator that was used to emulate the TDRS Satellites and a test equipment interface circuit to connect the TSIM to the GD SDR in the SCAN Testbed.

implemented in the SCAN Testbed ground software or on the GD SDR.

3.2 Test Plan

The test plan for this test covers the expected on-orbit operating conditions for the GD SDR. The desired temperature range for the tests was -15 °C to +45 °C. This is the maximum on orbit operating temperature range. The expected input power range on orbit from link budget calculations is -130 dBm to -104 dBm but the range for testing was expanded to -130 dBm to -90 dBm in order to characterize the AGCs response over a wider power range. The radio operates up to -50 dBm and so increasing the

Table 2: The AGC data collection configuration summary.

Waveform Number	Temperature Range	Testing Phases	SDR Input Power Range
1	Partial	GRC Ambient	Full
2	Full	GD Verification GRC TVAC GRC Ambient	Full
3	Partial	GRC Ambient	Full
4	Full	GRC TVAC GRC Ambient	Full
5	Partial	GRC Ambient	Full
6	Full	GD Verification GRC TVAC GRC Ambient	Full
7	Partial	GRC Ambient	Full
8	Full	GRC TVAC GRC Ambient	Full

power up to -90 dBm was well within the operating range of the radio. The waveform can be reconfigured to operate in eight different configurations so testing needed to be completed for all eight waveforms. The testing phases included verification testing at GD, Glenn Research Center (GRC) testing at ambient temperatures, and GRC thermal vacuum (TVAC) testing. The data that needed to be recorded included the GD SDR base plate temperature, calculated SDR input power, digital AGC, analog AGC, data rate, error correction status, and center frequency.

3.3 Test Setup

The test setup at GRC was designed to accommodate a number of waveform tests and consisted of ground support equipment as well as a customized test equipment interface (TEI) circuit. The typical test setup for testing at GRC is shown in Figure 1 and the test setup used by GD was very similar. A Tracking Relay Data Satellite (TDRS) Simulator (TSIM) was used to emulate the NASA Space Network. The power out of the TSIM was measured by a power meter at a coupled port in the TEI. The signal was then attenuated by approximately 80 dB before it reached the SDR input. The attenuation of the TEI and RF subsystem was measured using a network analyzer. The RF subsystem consists of switches, couplers, coax cables, and a diplexer. It allows the GD SDR to be connected to one of three different antennas located on the SCAN Testbed. The SDR input power calculation is based upon the power meter measurement at the coupled port and the known fixed loss

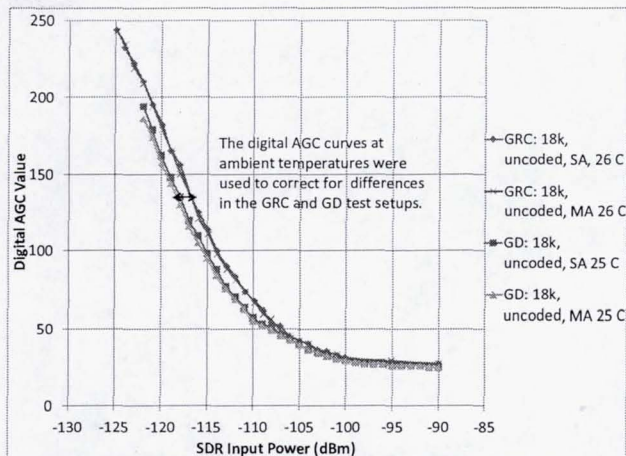

Figure 2: This graph illustrates the GD and GRC test setup alignment process. The GD data was -1.5 dB offset from the GRC data.

between it and the SDR input. The temperature sensor used in this test was located on the GD SDR base plate for both the data collected at GD and the data collected at GRC.

During GRC TVAC testing, the test setup was modified slightly because of the addition of extra cables between the TEI and the flight system. The losses of the cable located inside the TVAC chamber and the RF subsystem cable varied over temperature. A test cable was run in loopback alongside the actual cable in order to get measured cable loss data over temperature. This data was used to adjust the cable loss over temperature. The RF subsystem loss was measured at ambient temperature, but could not be measured at the different temperature extremes. Manufacturer data from the individual RF subsystem components was used to adjust the RF subsystem measured loss for variations in temperature. The coax cables are the dominant source of loss variation over temperature. From -20 °C to +50 °C, the RF subsystem loss was expected to vary .3 dB. A linear approximation was used to interpolate the loss in the -20 °C to +50 °C temperature range.

3.4 AGC Data Collection Summary

AGC data was collected for all eight GD receive waveforms over a two year period. Data was taken in different test setups and over different temperature ranges. A summary of the data collection status is located in Table 2.

As part of the GD internal verification testing that was completed before the SDR was shipped to GRC, data was collected over an SDR input power range between -130 dBm to -50 dBm for two (18 kbps, uncoded, SA & MA) of the receive waveforms at temperatures of -20 °C, +25 °C, and +60 °C.

Data was collected during the GRC TVAC testing, where the functionality and performance of the GD SDR

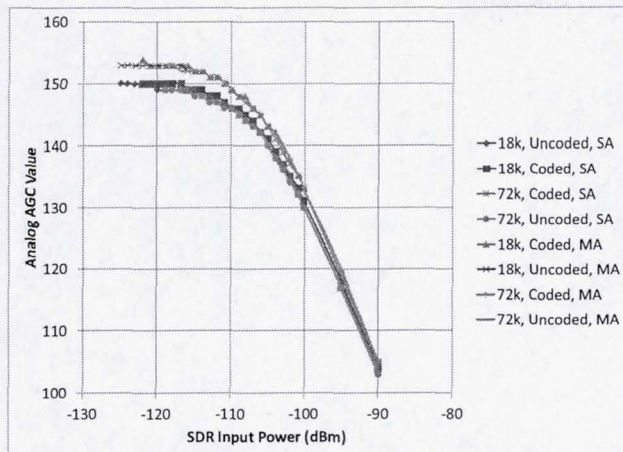

Figure 3: The analog AGC plots at 26 °C for all eight GD receive waveform combinations show two distinct trend lines. The analog AGC trend at a given temperature is dependent on the frequency – MA or SA.

was tested under the hot and cold temperature extremes in which it will operate on the ISS. During this test, data was collected for only four (18 kbps & 72 kbps, uncoded, SA & MA) of the receive waveforms at temperatures primarily at +47 °C and -12 °C and at SDR input power levels between -124 dBm to -116 dBm for the 18 kbps waveforms and -118 dBm to -110 dBm for the 72 kbps waveforms. Those power levels correspond to SNRs at which it is possible to take BER points in a reasonable amount of time (< 30 minutes). Data was also taken for the 18 kbps, uncoded, SA & MA waveforms at a power level of -118 dBm over a temperature ramp from -10 °C to +47 °C.

Finally, data was collected during GRC ambient testing. This data was collected while the payload was in a room at ambient temperature. The baseplate temperature was varied by adjusting the room temperature and turning on the SCAN Testbed heaters. Full AGC curves (SDR input power range of -124 dBm to -90 dBm) for all of the waveforms were collected at GRC at temperatures of +40 °C, +35 °C, +26 °C, and +20 °C.

3.5 GD and GRC Test Setup Alignment

In order to compensate for test setup calibration differences between the data collected at GD and at GRC, the ambient (GD: +25 °C, GRC: +26 °C) digital AGC curves were compared to each other as shown in Figure 2. The graph shows that both curves trend in the same way; they are parallel and separated by a constant offset. The GD data had a -1.5 dB SDR input power offset from the data collected at GRC. In order to compensate for differences in the test setup, the input power from the GD data was adjusted by an offset of +1.5 dB in order to make the curves overlap. The rest of the GD data that was collected at the

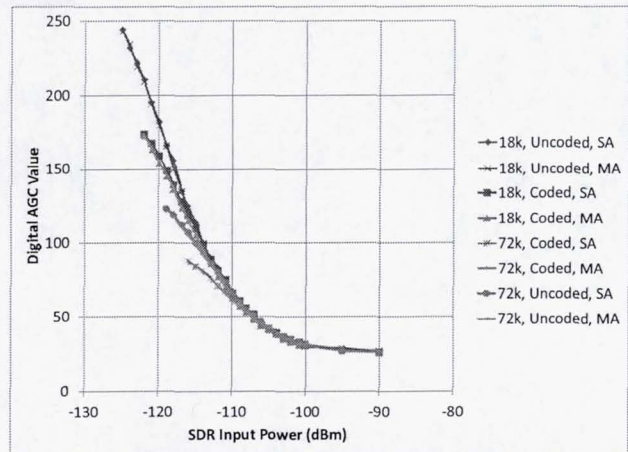

Figure 4: The digital AGC plots at 26 °C for the GD receive waveforms show four distinct trend lines. The trend at a given temperature shows that the digital AGC varies with the waveform symbol rate (data rate + coding).

other temperature extremes was also adjusted by the same offset.

3.6 Data Interpolation Process

There was no data collected during GRC TVAC for the coded waveforms, and very little data collected for the 72 kbps waveforms. This data is necessary in order to design and implement the SDR input power estimator algorithm. Therefore, the missing data was interpolated from existing data. The analog AGC trend over temperature is only dependent on the waveform center frequency configuration. There are two center frequencies and so the analog AGC data that was collected for the 18 kbps, uncoded, SA/MA waveforms was copied from other waveforms. The digital AGC trends high or low over temperature and so the missing data was made to trend in the same direction as known data.

3.7 Sources of Error from Data Collection

This section describes the sources of error in the data set collection. The sources of error include the following:

- Differences in the GD and GRC test setup (+/- .5 dB)
- Compensation method for the cable loss over temperature during thermal vacuum testing (+/- .5 dB)
- Data interpolated for waveforms with incomplete data sets (+/- 1 dB)
- System loss measurement error (+/- .3 dB)

3.7.1 Differences in the GD and GRC test setup (+/- .5 dB)

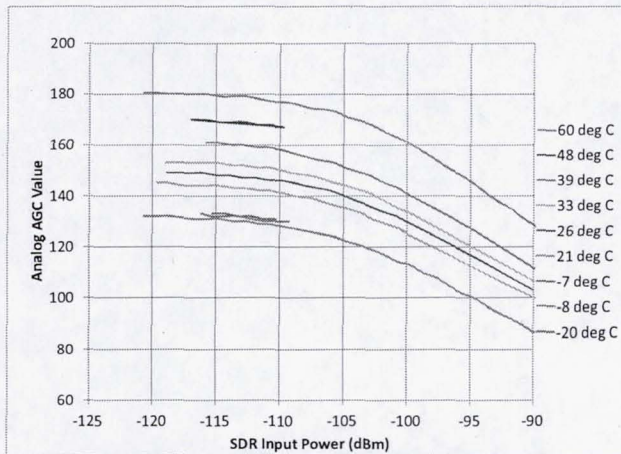

Figure 5: The analog AGC plots over temperature (72 kbps, uncoded, SA waveform) show that the analog AGC can vary 50 units at a constant power level.

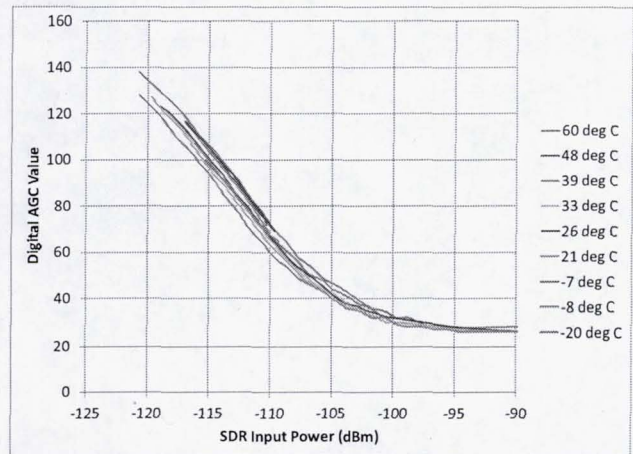

Figure 6: The digital AGC plots over temperature (72 kbps, uncoded, SA waveform) show that the digital AGC can vary 20 units at a constant power level.

The test setup calibration differences between the GRC and the GD test setup caused there to be a difference in the AGC curves collected at GD and GRC of 1.5 dB. The GD data was adjusted by +1.5 dB in order to correct for this difference and bring the two data sets closer together. However, there is probably a small margin of error that cannot be completely eliminated.

3.7.2 Compensation method for the cable loss over temperature during thermal vacuum testing (+/- .5 dB)

The GRC data was compensated to adjust for RF cable losses that change with temperature. The test cable was very close to the actual RF cable, but it was located in a slightly different place. The RF subsystem loss was not actually measured over temperature. The data that was taken at GD was not compensated for changing RF cable losses over temperature.

3.7.3 Data interpolated for waveforms with incomplete data sets (+/- 1 dB)

The data that was interpolated from existing data for the coded waveforms is the greatest source of error. The interpolation process was very straight forward, but could lead to +/- 1 dB of error.

3.7.4 System loss measurement error (+/- .3)

The system loss measurement error is the smallest source of error. The vector network analyzer measurement error is .2 dB. Also, connector savers and adapters were added to the test setup throughout the testing and were not accounted for during testing.

4. GD AGC TESTING RESULTS AND ANALYSIS

The analog and digital AGCs of the GD SCA_N Testbed flight SDR have been characterized. The AGC nonlinear dependence on SNR can be seen in Figures 3 and 4. The GD SDR AGC characterization results are presented in this section.

The analog AGC value vs. SDR input power at +26 °C is plotted for all eight waveforms in Figure 3. The graph clearly shows two distinct analog AGC trend lines – one for the SA frequency and one for the MA frequency. The analog AGC vs. SDR input power at a constant temperature varies only with the receive waveform center frequency configuration. It is located in the RF module of the radio and operates independently of the radio acquisition state. The digital AGC vs. SDR input power trend at a constant temperature varies with the received symbol rate as it is located in the FPGA. Plots of the digital AGCs at +26 °C are shown in Figure 4. The graph shows four distinct analog AGC trend lines. The combined analog and digital AGC results show that there are eight distinct analog and digital AGC pair combinations – one for each of the eight GD receive waveforms.

The AGCs vary nonlinearly with the SDR input power and this can be seen in Figures 3 and 4. The analog AGC is sensitive to power changes when the SDR input power is greater than -115 dBm and is fairly linear for SDR input power levels greater than -105 dBm. At power levels less than -115 dBm, the analog AGC levels off to a constant value and is not a good estimator of the input power. The digital AGC is responsive to power changes when the SDR input power level is less than -100 dBm. At power levels greater than -100 dBm, the digital AGC is constant and

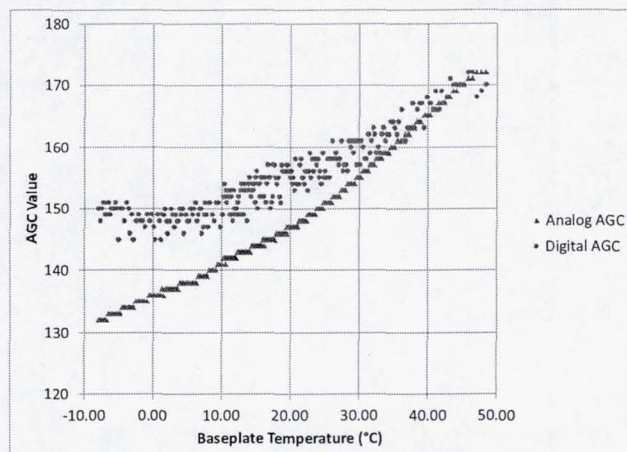

Figure 7: This graph shows the analog and digital AGCs over temperature at a constant power of -118 dBm (18 kbps, uncoded, SA waveform). The analog AGC is very constant and the digital AGC has more variation of +/- 3 units.

cannot be used to estimate the SDR input power. It is somewhat linear for SDR input powers less than -110 dBm.

The AGCs also vary nonlinearly with temperature. Plots of the AGCs at different temperatures for one of the waveforms (72k, uncoded, SA waveform) are shown Figures 5 and 6. The analog AGC varies 50 units between -20 °C and +60 °C and the digital AGC varies 20 units. This would correspond to a change in 30 dB based on the analog AGC reading or 4 dB based on the digital AGC if the temperature was not considered.

Both the digital and analog AGCs will read within a range of values for a given power level. This range is approximately +/- 3 units for the digital AGC and +/- 1 unit for the analog AGC at a SDR input power level of -118 dBm. Plots of the AGCs for the 18 kbps, uncoded, SA waveform over temperature at a SDR input power level of -118 dBm are shown in Figure 7. This figure shows that the analog AGC is very steady but there is more variability in the digital AGC. A +/- 3 unit variation in the digital AGC would correspond to variation in +/- 1 dB.

5. RECOMENDATIONS

The primary sources of complexity in this test were the many different testing phases and the reconfigurable options available on the SDR. Each testing phase had a slightly different test setup and this introduced error in the data collection. It was difficult to completely correct for the error. It is recommended that the test setup be thoroughly characterized and be kept constant for future testing. The eight different GD SDR waveform combinations expanded the length of the test. An SDR input power estimation algorithm that is not dependent on the waveform configuration would shorten the test time. SDRs can have a large number of reconfigurable parameters, but it is

important to remember that this can greatly increase the testing phase of a project.

6. FUTURE WORK

In the future, this characterization data will be used to create an algorithm to estimate the SDR input power and SNR from the AGCs and temperature. The algorithm will be implemented in the SCaN Testbed ground software at GRC or on the GD SDR. The algorithm will be evaluated during on-orbit operations after the SCAN Testbed is installed on the ISS. The engineering model SDR AGCs will also be characterized over SDR input power and the same algorithms will be used to develop an SDR input power estimator.

7. REFERENCES

- [1] SCAN Testbed: spaceflightssystemsgrc.nasa.gov/SOPO/SCO/SCaNTestbed/
- [2] Space Telecommunications Radio System (STRS) Architecture Standard, version 1.02.1, NASA Technical Memorandum 2010-216809, December 2010.
- [3] Space Network (SN) User's Guide, 450-SNUG (Revision 9, August 2007).