

Z-Pinch Magneto-Inertial Fusion Propulsion Engine Design Concept

Janie H. Miernik, Geoffrey Statham, ERC, Inc, Jacobs ESTS Group
Robert B. Adams, Tara Polsgrove, Sharon Fincher, NASA Marshall Space Flight Center
Leo Fabisinski, International Space Systems, Inc, Jacobs ESTS Group
C. Dauphne Maples, Qualis Corporation, Jacobs ESTS Group
Thomas K. Percy, SAIC
Ross J. Cortez, Jason Cassibry, Propulsion Research Center, University of Alabama Huntsville

George C. Marshall Space Flight Center (MSFC)
National Aeronautics and Space Administration (NASA)
Advanced Concepts Office (ACO) /ED04
Huntsville, AL 35812
Janie.h.miernik@nasa.gov
Jacobs ESTS Group

ABSTRACT

Fusion-based nuclear propulsion has the potential to enable fast interplanetary transportation. Due to the great distances between the planets of our solar system and the harmful radiation environment of interplanetary space, high specific impulse (I_{sp}) propulsion in vehicles with high payload mass fractions must be developed to provide practical and safe vehicles for human spaceflight missions.

Magneto-Inertial Fusion (MIF) is an approach which has been shown to potentially lead to a low cost, small fusion reactor/engine assembly (1). The Z-Pinch dense plasma focus method is an MIF concept in which a column of gas is compressed to thermonuclear conditions by an estimated axial current of approximately 100 MA. Recent advancements in experiments and the theoretical understanding of this concept suggest favorable scaling of fusion power output yield as I^4 (2). The magnetic field resulting from the large current compresses the plasma to fusion conditions, and this is repeated over short timescales (10^{-6} sec). This plasma formation is widely used in the field of Nuclear Weapons Effects (NWE) testing in the defense industry, as well as in fusion energy research.

There is a wealth of literature characterizing Z-Pinch physics and existing models (3-5). In order to be useful in engineering analysis, a simplified Z-Pinch fusion thermodynamic model was developed to determine the quantity of plasma, plasma temperature, rate of expansion, energy production, etc. to calculate the parameters that characterize a propulsion system. The amount of nuclear fuel per pulse, mixture ratio of the D-T and “nozzle liner” propellant, and assumptions about the efficiency of the engine, enabled the sizing of the propulsion system and resulted in an estimate of the thrust and I_{sp} of a Z-Pinch fusion propulsion system for the concept vehicle.

MIF requires a magnetic nozzle to contain and direct the nuclear pulses, as well as a robust structure and radiation shielding. The structure, configuration, and materials of the nozzle must meet many severe requirements. The configuration would focus, in a conical manner, the Deuterium-Tritium (D-T) fuel and Lithium-6/7 “liner” fluid to meet at a specific point that acts as a cathode so the Li-6 can serve as a current return path to complete the circuit. In addition to

serving as a current return path, the Li liner also serves as a radiation shield. The advantage to this configuration is the reaction between neutrons and Li-6 results in the production of additional Tritium, thus adding further fuel to the fusion reaction and boosting the energy output.

To understand the applicability of Z-Pinch propulsion to interplanetary travel, it is necessary to design a concept vehicle that uses it. The propulsion system significantly impacts the design of the electrical, thermal control, avionics, radiation shielding, and structural subsystems of a vehicle. The design reference mission is the transport of crew and cargo to Mars and back, with the intention that the vehicle be reused for other missions. Several aspects of this vehicle are based on a previous crewed fusion vehicle study called "Human Outer Planet Exploration" (HOPE), which employed a Magnetized Target Fusion (MTF) propulsion concept. Analysis of this propulsion system concludes that a 40-fold increase of I_{sp} over chemical propulsion is predicted. This along with a greater than 30% predicted payload mass fraction certainly warrants further development of enabling technologies. The vehicle is designed for multiple interplanetary missions and conceivably may be suited for an automated one-way interstellar voyage.

REFERENCES:

1. Lindemuth, I., and Siemon, R. (2009). The fundamental parameter space of controlled thermonuclear fusion. *American Journal of Physics* 77, no. 5: 407-416.
2. Velikovich, A. L., R. W. Clark, J. Davis, Y. K. Chong, C. Deeney, C. A. Coverdale, C. L. Ruiz, et al. 2007. Z-Pinch plasma neutron sources. *Physics of Plasmas* 14, no. 2: 022701. doi:10.1063/1.2435322.
3. Olson, C. e. (2005). Development Path for Z-Pinch IFE. *Fusion Science and Technology* , 47, 633-640.
4. Shumlak, U., Lilly, R. C., Adams, C. S., Golvingo, R. P., Jackson, S. L., Knecht, S. D., et al. (2006). Advanced Space Propulsion Based on the Flow-Stabilized Z-Pinch Fusion
5. Velikovich, A. L., R. W. Clark, J. Davis, Y. K. Chong, C. Deeney, C. A. Coverdale, C. L. Ruiz, et al. 2007. Z-Pinch plasma neutron sources. *Physics of Plasmas* 14, no. 2: 022701. doi:10.1063/1.2435322.



INTERNATIONAL ACADEMY OF ASTRONAUTICS

Missions to the outer solar system and beyond



SEVENTH IAA SYMPOSIUM ON REALISTIC NEAR-TERM
ADVANCED SCIENTIFIC SPACE MISSIONS
Aosta, Italy, July 11-14, 2011

Z-PINCH MAGNETO-INERTIAL FUSION PROPULSION ENGINE DESIGN CONCEPT

J. Miernik, G. Statham, ERC, Inc, **L. Fabisinski**, International Space Systems, Inc, **C. D. Maples**, Qualis Corporation, Jacobs ESTS Group
R. Adams, T. Polsgrove, S. Fincher, NASA Marshall Space Flight Center
T. Percy, SAIC, **R. Cortez, J. Cassibry**, Propulsion Research Center, University of Alabama Huntsville
janie.h.miernik@nasa.gov, ERC, Inc, Jacobs ESTS Group
Advanced Concepts Office, Marshall Space Flight Center, Huntsville, Alabama USA

ABSTRACT

Fusion-based nuclear propulsion has the potential to enable fast interplanetary transportation. Due to the great distances between the planets of our solar system and the harmful radiation environment of interplanetary space, high specific impulse (I_{sp}) propulsion in vehicles with high payload mass fractions must be developed to provide practical and safe vehicles for human spaceflight missions.

The Z-Pinch dense plasma focus method is a Magneto-Inertial Fusion (MIF) approach that may potentially lead to a small, low cost fusion reactor/engine assembly (1). The Z-Pinch dense reaction compresses a column of gas to thermonuclear conditions, requiring an estimated axial current of 100 MA. Recent advancements in experimental and theoretical understanding of this concept suggest favorable scaling of fusion power output yield as I^4 (2). The magnetic field resulting from the large current compresses the plasma to fusion conditions, and this process can be repeated over short timescales (10^{-6} sec). This type of plasma formation is widely used in the field of Nuclear Weapons Effects (NWE) testing in the defense industry, as well as in fusion energy research.

To understand the applicability of Z-Pinch propulsion to interplanetary travel, designing a concept vehicle that uses the technology is necessary. The design reference mission described herein is the transport of crew and cargo to Mars and back, with the intention that the vehicle be reused for other missions. Several aspects of this vehicle are based on a previous crewed fusion vehicle study called "Human Outer Planet Exploration" (HOPE), which used a Magnetized Target Fusion (MTF) propulsion concept (3) and utilized a magnetic nozzle.

Analysis of the Z-Pinch propulsion system concludes that a 40-fold increase of I_{sp} over chemical propulsion is predicted. An I_{sp} of 19,436 sec and thrust of 3812 N-sec/pulse, along with nearly doubling the predicted payload mass fraction, warrants further development of enabling technologies.

Keywords: Z-Pinch, Magneto-Inertial, fusion, propulsion, magnetic nozzle.

INTRODUCTION

This document presents selected results of a study conducted in 2010 (4) by members of the Advanced Concepts Office at MSFC to develop a conceptual design of a Z-Pinch MIF fusion propulsion system and a vehicle (see Figure 1) that included all necessary systems for an integrated interplanetary spacecraft for human exploration. The NASA study offered recommendations for Z-Pinch pulsed plasma propulsion technology development. Z-Pinch physics and existing models (5-7) were studied to develop a simplified Z-Pinch fusion thermodynamic model to determine the quantity of plasma, plasma temperature, rate of expansion, energy production, etc. to calculate the parameters that characterize a propulsion system. The amount of nuclear fuel per pulse, mixture ratio of the Deuterium-Tritium (D-T) and Lithium-6/7 (Li^6) "nozzle liner" propellant, and

assumptions about the efficiency of the engine enabled the sizing of the propulsion system and resulted in an estimate of the thrust and I_{sp} of a Z-Pinch fusion propulsion system for the concept vehicle.

MIF requires a magnetic nozzle to contain and direct the nuclear pulses, as well as a robust structure with radiation shielding. The configuration directs the D-T fuel and Li^6 liner fluid within the nozzle to complete an electrical circuit and allow some of the energy of the nuclear pulses to effect the rapid recharge of capacitors and the continuation of pulsed propulsion. The Li^6 serves as a neutron “getter,” and the reaction between neutrons and Li^6 produces additional Tritium, adding fuel to the fusion reaction and boosting the energy output.

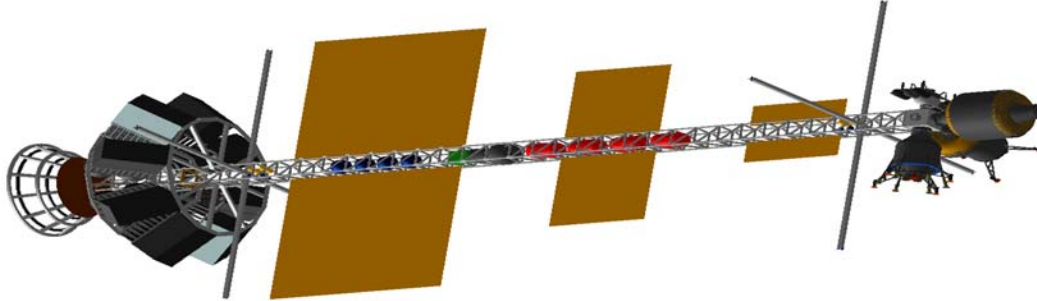

Figure 1 - Z-Pinch Vehicle Configuration ~125 meters in length

Trajectory analysis with the propulsion model was used to determine the duration of the propulsion burns, the amount of propellant expended, and the mixture ratio of the D-T and liner fuel to accomplish a particular mission. A number of missions, modeling variables, vehicle configurations, and design parameters were traded during the previously mentioned NASA studies; however, this paper concentrates on the conceptual Z-Pinch nuclear engine of the proposed vehicle. An outline of the mission and vehicle configuration is offered to provide a framework for the propulsion design.

1. Z-PINCH FUSION REACTION MODELING

The approach investigated in this study involves the use of a confinement scheme known as a Z-Pinch, which falls under the MIF regime. The premise of a Z-Pinch is to run very large currents (Megampere scale) through plasma over short timescales (10^{-6} sec). The magnetic field resulting from the large current then compresses the plasma to fusion conditions. For a fusion propulsion system, the Z-Pinch is formed using an annular nozzle with D-T fuel in the innermost nozzle and Lithium-6/7 (Li^6) in the outermost nozzle. The configuration would be focused in a conical manner so the D-T fuel and Li^6 mixture meet at a specific point that acts as a cathode, and the lithium mixture can serve as a current return path to complete the circuit, as shown in two different graphical representations in Figures 2 and 3.

In addition to serving as a current return path, the Li^6 liner also serves as a radiation shield. The advantage of this configuration is the reaction between neutrons and Li^6 resulting in the production of Tritium, thus adding further fuel to the fusion reaction and boosting the energy output. By utilizing this method of fusion for propulsion, one can produce very high specific impulse by means of rapid exit velocity.

Modeling and analysis of fusion plasmas and their dynamic magnetohydrodynamic (MHD) flows, as well as the fusion reactions themselves, necessitate the formulation of very simple models and approximations to facilitate our understanding. An approximation is made to develop a qualitative understanding of multiple fusion ignition processes similar to the air-standard analysis of an internal-combustion engine, also known as an Otto engine.

Several assumptions are made about the molecular reactions and parameters in the analysis. See Table I.

The lithium liner is assumed to act as an inert element in the process and not react with the D-T fuel; the lithium liner only adds mass to the exhaust without adding further energy. Although not expected, this makes the calculation a more conservative estimate. Thrust and I_{sp} as a function of fractional liner mass over D-T fuel were calculated with Table I values, yielding a recommended design point of 38 kN thrust and $I_{sp} = 19,436$ per pulse.

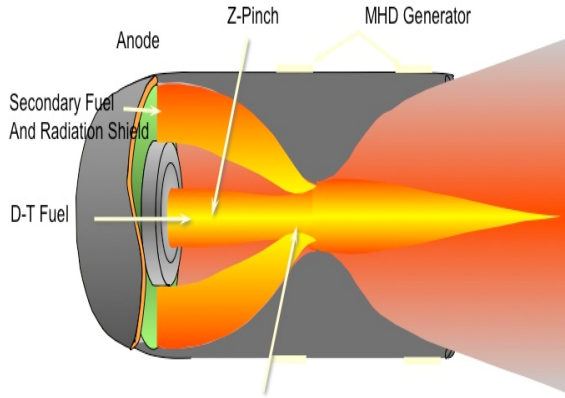

Figure 2 – Z-Pinch cathode runs axially down center

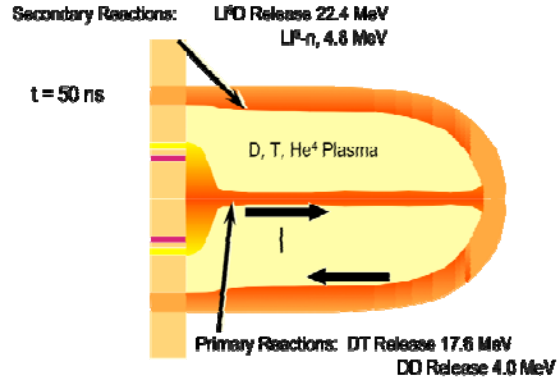
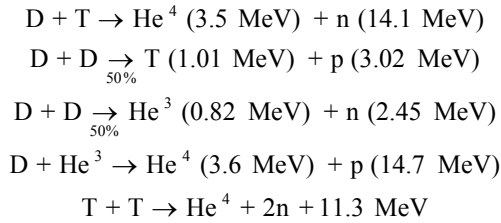

Figure 3 – Li⁶ liner provides anode return path

| | |
|-----------------------|----------|
| Pulse Frequency | 10 Hz |
| Driver Energy Density | 10 kJ/kg |
| Compression Ratio | 10 |
| Initial DT Fuel Mass | 100 mg |
| Ignition Temperature | 20 keV |

Table I – Parameter assumptions

2. MAIN ENGINE PROPULSION CONCEPT

The energy released during nuclear fusion is converted into useful vehicle impulse by means of a magnetic nozzle. The physical components of the nozzle are a series of 8 current-carrying rings assemblies structurally positioned to form a parabolic nozzle with its focus at the point of fusion. An electrical current is passed around each ring and results in a magnetic field as illustrated in Figure 4, which shows the entire nozzle in cross-section.

After each fusion event, the hot, rapidly expanding plasma shell compresses the magnetic flux into a smaller annular region between the plasma and the rings. As the magnetic flux is compressed, the field strength and the magnetic pressure on the expanding plasma shell increase, preventing the plasma from contacting the rings. An equal and opposite force, much of it axially upwards along the main axis of the nozzle and the

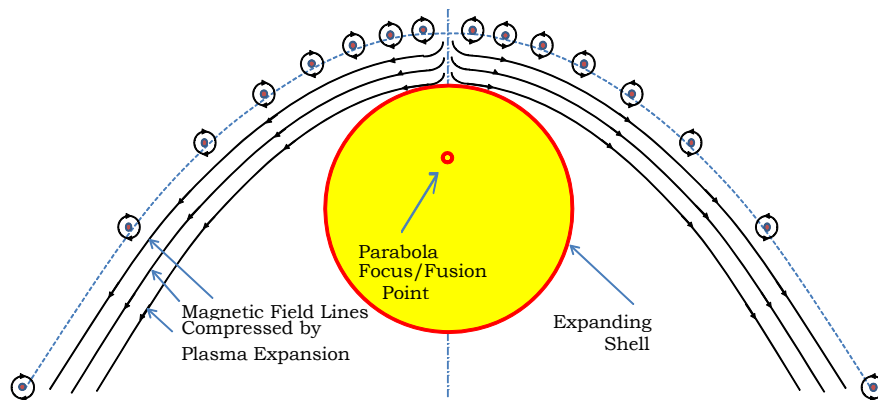

Figure 4 – Magnetic nozzle and expanding plasma

vehicle, transfers the kinetic energy of the expanding plasma pulse to propel the vehicle.

Each of the 8 ring assemblies that comprise the nozzle is actually composed of two separate conducting rings. There is a central superconducting ring that generates the initial seed magnetic field, which fills the volume of the nozzle before fusion takes place. This high-temperature superconducting mesh is immersed in liquid nitrogen coolant. A yttrium-based superconductor (YBa₂Cu₃O₇) is proposed that has a transition temperature of 92 K, which can be maintained by LN₂ at 77 K. The second conducting ring, the so called “thrust coil,” supports the electrical current that is induced during plasma expansion. Fluorine-Lithium-Beryllium (FLiBe) thermal coolant is

suggested for the dual purpose of heat removal and capturing gamma rays and neutrons, and the FLiBe doubles as a radiation shield for the thrust coils of the nozzle. The Li^6 fuel “liner” is designed to absorb some neutrons and will slow down many more. A metal composite of molybdenum in a matrix of titanium diboride with very low resistivity would offer good electrical conduction and strength properties at high temperature.

Because of its parabolic shape, the plasma radiating outwards from the focus of the parabolic nozzle will be directed out of the nozzle, parallel to the axis – no matter where it strikes, expelling the plasma allowing the magnetic field to return to its original configuration. During the entire process of plasma expansion and expulsion, the magnetic field acts in the manner of a spring. First the magnetic field is compressed, and then it expands back to its original configuration – with useful thrust being applied to the vehicle via the thrust coils. In addition to the ring assemblies, there are structural, cooling, radiation and neutron shielding components incorporated in the design of the magnetic nozzle.

For modeling purposes, the plasma shell is divided into 8 discrete segments, each moving radially away from the fusion point, which is by design at the focus of the nozzle. Figure 5 shows the actual trajectories modeled.

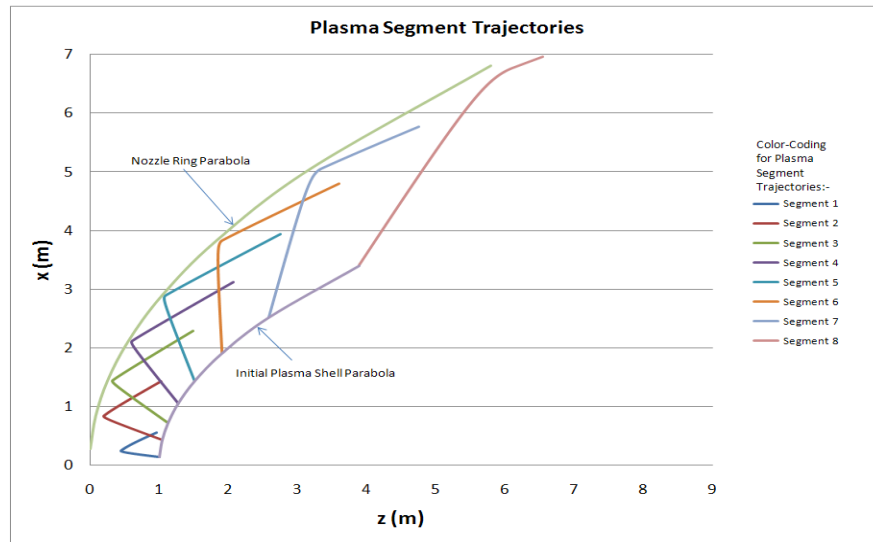

Figure 5 – Plasma trajectories exiting nozzle over 15 microseconds

In summary, the expanding plasma has a total mass of 0.02 kg, and its initial kinetic energy is assumed to be 1 GJ (1×10^9 Joules). Useful thrust to the vehicle per pulse = 3812 N-seconds and at 10 Hz (10 pulses/sec) $I_{sp} = 19,436$ seconds.

3. Z-PINCH ENERGY REGENERATION / DISCHARGE SYSTEM

In order to create the conditions necessary for fusion, a large amount of energy must be applied to the DT fuel bolus over a period of just around 100ns. In order to do this, capacitor banks with very low capacitance must be used so that the discharge will be very rapid, and the banks must be charged to a very high voltage to store enough energy. After discharging to create the Z-Pinch, these capacitor banks must be recharged for the next pulse. During each fusion pulse, the current induced in the thrust coils is used to recharge the capacitors. The Z-Pinch regeneration/discharge subsystem consists of the capacitors, cables, switches, and other circuitry required to charge and discharge the capacitors.

The thermodynamic model used to size the fusion portion of the propulsion system estimates the Z-Pinch gain at 3: meaning that the amount of energy released by the fusion reaction is 3 times the amount of energy required for ignition. Assuming each pulse generates 1GJ, 333 MJ must be discharged into the DT fuel pulse in 100ns to initiate fusion. The capacitor charge efficiency is assumed to be 80%, so 416×10^{-6} J must be available in the capacitor bank.

Although the capacitors must discharge over a 100ns period, they have a longer period to recharge, assuming a 10 Hz pulse frequency for the propulsion system. Capacitors may be charged in parallel and discharged in series, so a circuit may be devised that allows a large bank of capacitors to be charged over several microseconds and discharged much more quickly with very little loss. This circuit is known as a Marx Generator and, for this

application, individual capacitors are sized by traditional physics-based methods according to required voltage and capacitance. The plasma switches and diodes are not sufficiently well characterized to size with a mass estimating relation, so they are sized as 12% of the capacitor mass.

The diodes prevent ringing between the capacitive and inductive portions of the circuit, while the plasma switches complete the series discharge circuit as for a typical Marx Generator. There are 8 stages in the Marx generator arranged radially in a ring surrounding the Z-Pinch.

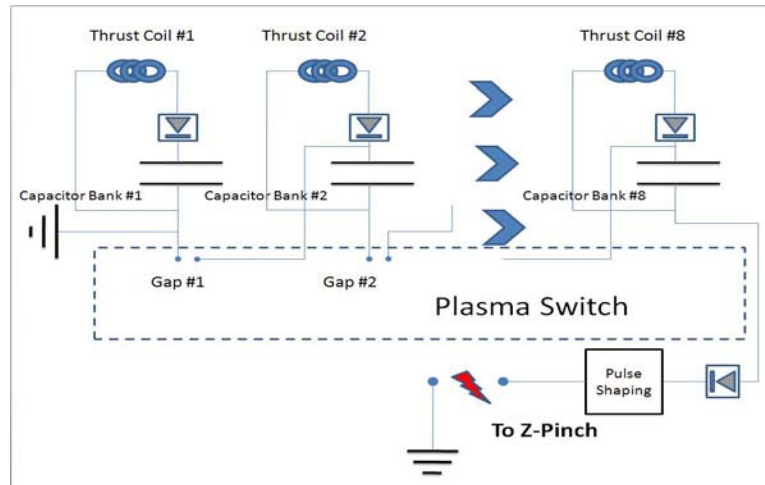

Figure 6 - Basic schematic of the charge/discharge system.

4. STRUCTURAL CONSIDERATIONS

The size of this vehicle dictates that it must be assembled in space, so components are designed for modular assembly and are small enough for launch on a conceivable heavy launch vehicle. A few components, such as the tanks, would be analyzed for launch loads, but nearly all components will be launched in a stowed configuration. This will lead to lower vehicle structural loads because the vehicle would not be required to withstand launch from Earth as an integrated structure. Most of the vehicle structure will consist of an aluminum truss. Figure 1 shows the 2010 Z-Pinch study configuration with a 125 meter long vehicle with the crew compartment and landing vehicles at the front end of a long square truss and the main nuclear propulsion system at the aft end. The engine nozzle is shown supporting the 8 thrust coils with 12 structural splines, but more recent analysis suggests an optimized 8 spline nozzle with variable spline cross sections.

The engine nozzle could be made of a Carbon Composite (C/C) material, such as a graphite epoxy composite IM7/8552, to provide stiffness and low mass. It would also benefit from the ability of carbon to withstand neutron radiation. The magnetic field generated in the nozzle will protect the nozzle structure from the high-temperature fusion plasma. A radiation shield cap will extend down from the top of the nozzle, protecting a radial half angle wide enough to shield the entire vehicle, particularly the capacitor banks. Because the capacitor banks must be kept in close proximity to the top of the magnetic nozzle – to provide high voltage pulses to the nuclear fuel, – they will be particularly susceptible to radiation damage.

The dimensions and stress requirements of the magnetic nozzle structure are based on the fusion engine performance. A simplified Finite Element Model Analysis and Post-processing (FEMAP) model was created to analyze the nozzle structure and optimize its design and mass. Material susceptibility and shielding capability against fast neutrons produced by the fusion process are important in nozzle and vehicle configuration, but a large Margin of Safety (MOS) must be assumed for the nozzle structure due to the frequent radiation flux it must endure. The force of a fusion propulsive pulse on the nozzle segment was applied against a fixed boundary that represented the base of the vehicle truss or a very large mass, as a conservative approximation. The model was meshed and a positive FEA result was obtained with existing C/C materials using known physical properties.

5. MISSION ANALYSIS

The thrust levels of a Z-Pinch fusion rocket are similar to traditional chemical propulsion systems; however, the mass of the propulsion system results in accelerations in the milli-g range. The outstanding specific impulse of the propulsion system enables high overall system performance. Traditional chemical propulsion systems

operate in the 1-g acceleration range, allowing for the assumption of impulsive burns for trajectory analyses because the burn time is relatively short compared to the overall trip time. The Z-Pinch propulsion system's milli-g accelerations place it in the category of "medium thrust" trajectory analysis, so the burns were numerically integrated and patched into a transfer conic trajectory.

Several simplifying assumptions were made for this analysis. No ephemeris data and simple circular orbits at the mean orbital radius were used to represent the departure and arrival planets. While the results are valid for required transfer energies, the epoch of the mission and stay time at the destination were not quantified in this analysis. The arrival conditions for each leg were set at a v infinity of 0 km/s. The planetary orbit component of the trajectories was not assessed and no parking orbit analysis was performed. Escape burns should account for approximately 10% of the propellant load, but they have not been assessed in this analysis.

For a 90 day trip to Mars, Z-Pinch offers a 50% reduction in the nominal one way trip compared to a chemical propulsion mission. The 90-day trajectory has a 1.5 day Earth departure burn. The total burn time is 5 days for a roundtrip Mars mission, equating to 27,500 m/s of ΔV and using 83.2 mT of propellant. The trajectory for a 30-day trip to Mars requires an 8.7 day Earth departure burn. For a roundtrip, this trajectory requires a total burned propellant load of 335.3 mT and has an equivalent ΔV of 93,100 m/s. While these numbers are significantly larger than the 90-day trajectories, this does show the feasibility of a 30-day trip to Mars.

A comparison of the payload mass fractions shows that only about 33% of the mass in a traditional, high-thrust chemical propulsion Mars cargo mission could be payload. A Z-Pinch propulsion system can deliver a higher payload mass fraction, estimated at 35-55% in half the time, (90 days vs. 180 days). Z-Pinch propulsion may also enable fast round-trip trajectories for human Mars missions with comparable payload mass fractions to current chemical propulsion vehicle estimates.

CONCLUSION

Fusion-based nuclear propulsion has the potential to enable fast interplanetary transportation. The large size of an interplanetary vehicle dictates that it will be assembled in space. Due to the great distances between the planets of our solar system and the harmful radiation environment of interplanetary space, high specific impulse (I_{sp}) propulsion vehicles with high payload mass fractions have a practical advantage of providing fast transit through a hazardous environment for human spaceflight missions.

Analysis of the Z-Pinch propulsion system concludes that a 40-fold increase of I_{sp} over chemical propulsion is predicted. 19,436 sec and useful thrust of 3812 N-sec/pulse, along with nearly doubling the predicted payload mass fraction, warrants further development of enabling technologies.

The vehicle can be designed for multiple interplanetary missions and conceivably may be suited for an automated one-way interstellar voyage.

REFERENCES

1. Lindemuth, I., and Siemon, R. (2009). The fundamental parameter space of controlled thermonuclear fusion. *American Journal of Physics* 77, no. 5: 407-416.
2. Velikovich, A. L., Ruiz, C.L., et al. (2007). Z-Pinch plasma neutron sources. *Physics of Plasmas* 14, no. 2: 022701. doi:10.1063/1.2435322.
3. Adams, R. B., Statham, G., Thio, Y. C. F., et al. (2003). Conceptual Design of In-Space Vehicles for Human Exploration of the Outer Planets. NASA/TP-2003-212691.
4. Polsgrove, T., Adams, R. B., Statham, G., Miernik, J. H., Cassibry, J., Santarius, J., et al. (2010). Z-Pinch Pulsed Plasma Propulsion Technology Development., MSFC M110145.
5. Olson, C. E. (2005). Development Path for Z-PinchIFE. *Fusion Science and Technology*, 47, 633-640.
6. Shumlak, U., Lilly, R. C., Adams, C. S., Golvingo, R. P., Jackson, S. L., Knecht, S. D., et al. (2006). Advanced Space Propulsion Based on the Flow-Stabilized Z-PinchFusion, *42nd AIAA/ASME/SAE/ASEE Joint Propulsion Conference* (pp. 1-14). Sacramento, CA: AIAA.
7. Santarius, J. F., (2003). Magnetized-Target Fusion for Space Propulsion. NASA Project NAG8-1719.