

NASA/CR-2012-215999



## **An Assessment of Civil Tiltrotor Concept of Operations in the Next Generation Air Transportation System**

*William W. Chung*  
*Science Applications International Corporation*  
*California, Maryland*

*Dan Salvano*  
*Science Applications International Corporation*  
*McLean, Virginia*

*David Rinehart and Ray Young*  
*Saab Sensis Corporation*  
*Reston, Virginia*

*Victor Cheng*  
*Optimal Synthesis Inc.*  
*Los Altos, California*

*Jim Lindsey*  
*Monterey Technologies, Inc.*  
*Monterey, California*

## The NASA STI Program Office . . . in Profile

Since its founding, NASA has been dedicated to the advancement of aeronautics and space science. The NASA Scientific and Technical Information (STI) Program Office plays a key part in helping NASA maintain this important role.

The NASA STI Program Office is operated by Langley Research Center, the Lead Center for NASA's scientific and technical information. The NASA STI Program Office provides access to the NASA STI Database, the largest collection of aeronautical and space science STI in the world. The Program Office is also NASA's institutional mechanism for disseminating the results of its research and development activities. These results are published by NASA in the NASA STI Report Series, which includes the following report types:

- **TECHNICAL PUBLICATION.** Reports of completed research or a major significant phase of research that present the results of NASA programs and include extensive data or theoretical analysis. Includes compilations of significant scientific and technical data and information deemed to be of continuing reference value. NASA's counterpart of peer-reviewed formal professional papers but has less stringent limitations on manuscript length and extent of graphic presentations.
- **TECHNICAL MEMORANDUM.** Scientific and technical findings that are preliminary or of specialized interest, e.g., quick release reports, working papers, and bibliographies that contain minimal annotation. Does not contain extensive analysis.
- **CONTRACTOR REPORT.** Scientific and technical findings by NASA-sponsored contractors and grantees.

- **CONFERENCE PUBLICATION.** Collected papers from scientific and technical conferences, symposia, seminars, or other meetings sponsored or cosponsored by NASA.
- **SPECIAL PUBLICATION.** Scientific, technical, or historical information from NASA programs, projects, and missions, often concerned with subjects having substantial public interest.
- **TECHNICAL TRANSLATION.** English-language translations of foreign scientific and technical material pertinent to NASA's mission.

Specialized services that complement the STI Program Office's diverse offerings include creating custom thesauri, building customized databases, organizing and publishing research results . . . even providing videos.

For more information about the NASA STI Program Office, see the following:

- Access the NASA STI Program Home Page at <http://www.sti.nasa.gov>
- E-mail your question via the Internet to [help@sti.nasa.gov](mailto:help@sti.nasa.gov)
- Fax your question to the NASA Access Help Desk at (301) 621-0134
- Telephone the NASA Access Help Desk at (301) 621-0390
- Write to:  
NASA Access Help Desk  
NASA Center for AeroSpace Information  
7115 Standard Drive  
Hanover, MD 21076-1320



## **An Assessment of Civil Tiltrotor Concept of Operations in the Next Generation Air Transportation System**

*William W. Chung  
Science Applications International Corporation  
California, Maryland*

*Dan Salvano  
Science Applications International Corporation  
McLean, Virginia*

*David Rinehart and Ray Young  
Saab Sensis Corporation  
Reston, Virginia*

*Victor Cheng  
Optimal Synthesis Inc.  
Los Altos, California*

*Jim Lindsey  
Monterey Technologies, Inc.  
Monterey, California*

National Aeronautics and  
Space Administration

Ames Research Center  
Moffett Field, California 94035-1000

## **Acknowledgments**

This work was funded by the Subsonic Rotary Wing project, NASA Fundamental Aeronautics Program, under Contract NNA09DA06T. The NASA Contracting Officer's Technical Representative for this 3-year contract was Mr. Larry Young of NASA Ames Research Center.

Available from:

NASA Center for AeroSpace Information  
7115 Standard Drive  
Hanover, MD 21076-1320  
(301) 621-0390

National Technical Information Service  
5285 Port Royal Road  
Springfield, VA 22161  
(703) 487-4650

## TABLE OF CONTENTS

LIST OF FIGURES .....	v
LIST OF TABLES .....	vi
ACRONYMS .....	vii
SUMMARY .....	1
1 INTRODUCTION .....	1
2 ASSESSMENT OF KEY ASSUMPTIONS FOR CTR CONOPS.....	2
2.1 Preliminary Analysis Based on a BOS–EWR CTR Route.....	2
2.1.1 General Flight Profile .....	3
2.1.2 Takeoff and Departure at EWR .....	3
2.1.3 NIO in En Route .....	6
2.1.4 Approach and Arrival at EWR.....	6
2.2 Summary of Further Research Topics in CTR ConOps .....	8
3 SAFETY ANALYSIS OF CTR OPERATIONS.....	9
3.1 Safety Terminologies and Methodology .....	9
3.1.1 Safety .....	9
3.1.2 Hazard and Risk.....	10
3.1.3 Safety Management System (SMS).....	10
3.1.4 SRM Process for Civil Tiltrotors (CTRs) in the NAS .....	12
3.2 Safety Analysis Approach .....	14
3.3 Development of the Three Safety Analysis Scenarios .....	14
3.3.1 Scenario 1—Interconnect Driveshaft System (ICDS) Failure During a VTOL Takeoff.....	15
3.3.2 Scenario 2—Inability of the Nacelles to Rotate (Nacelle Translation Failure) .....	23
3.3.3 Scenario 3—Failure of the ICDS During a VTOL Landing.....	25
3.4 Other Safety Considerations.....	26
3.5 Summary .....	26
4 PROPOSED CASE STUDIES FOR FURTHER RESEARCH OF NIO AND RIO .....	29
4.1 Case 1—CTR Connecting Congested Hubs (Far-Term) .....	30
4.1.1 Description.....	30
4.1.2 Alternative Cases .....	31
4.1.3 Key Issues for Further Research—Case 1 .....	31
4.2 Case 2—CTR Connecting Feeder and Hub (Near-Term) .....	31
4.2.1 Description.....	31
4.2.2 Alternative Cases .....	32
4.2.3 Key Issues for Further Research—Case 2 .....	32

## TABLE OF CONTENTS (cont.)

4.3	Case 3—CTR Transportation Services to Population Centers .....	32
4.3.1	Sub-Case 3a—Local Metroplex Interconnect.....	32
4.3.2	Sub-Case 3b—Population Center to Population Center Direct .....	34
4.4	Case 4—CTR Transportation Services to Remote Locations .....	35
4.4.1	Description.....	35
4.4.2	Alternative Cases.....	36
4.4.3	Key Issues for Further Research—Case 4 .....	36
4.5	Case 5—CTR Flexible Expedited Cargo Services .....	36
4.5.1	Description.....	36
4.5.2	Alternative Cases.....	37
4.5.3	Key Issues for Further Research—Case 5 .....	37
4.6	Case 6—Further Studies in CTR Disaster Relief .....	38
4.6.1	Description.....	38
4.6.2	Alternative Cases.....	38
4.6.3	Key Issues for Further Research—Case 6 .....	38
4.7	Summary .....	39
5	ASSESSMENT OF KEY CTR NAS PERFORMANCE ANALYSIS TOOLS.....	39
5.1	Issues and Tools .....	39
5.1.1	NAS Performance Analysis Tools and/or Enhancements for CTR Performance Evaluations .....	40
5.1.2	The Broad Context for Analysis of CTR Operations in the NAS.....	41
5.1.3	CTR Performance Modeling.....	46
5.1.4	En Route and Delay Modeling.....	46
5.1.5	Terminal Modeling .....	47
5.1.6	Environmental Modeling .....	48
5.2	Technical Challenges for Concept and Future Tool Developers.....	48
5.3	Summary .....	49
6	SUMMARY AND RECOMMENDATIONS.....	49
6.1	NIO and RIO Assumption Assessment .....	49
6.2	Safety Assessment .....	49
6.3	Assessment of CTR Case Studies.....	50
6.4	NAS Performance Analysis Tool Assessment .....	50
6.5	Recommendations .....	50
7	REFERENCES .....	53
	APPENDIX A. TERMINOLOGY USED IN SAFETY ANALYSIS.....	55

## LIST OF FIGURES

Figure 2-1. A 120-passenger CTR flight profile.....	3
Figure 2-2. Possible vertiport sites at EWR.....	4
Figure 2-3. EWR spiral departure.....	5
Figure 2-4. Notional departure traffic patterns at EWR.....	5
Figure 2-5. Notional CTR paths between EWR and BOS.....	6
Figure 2-6. Notional CTR arrival track at EWR.....	7
Figure 2-7. Notional arrival traffic patterns at EWR.....	7
Figure 2-8. A spiral descent profile of a 30-passenger CTR.....	8
Figure 3-1. A representative safety risk matrix.....	11
Figure 3-2. Process flow for Safety Risk Management.....	11
Figure 3-3. The Safety Management System flow diagram.....	12
Figure 3-4. Decision logic for safety analysis.....	13
Figure 3-5. Possible vertiport sites at EWR.....	15
Figure 3-6. 30-passenger takeoff time history, VTO.....	16
Figure 3-7. Risk matrix.....	21
Figure 3-8. A representative tiltrotor drive system illustration.....	23
Figure 3-9. A notional CTR gate area layout and potential wake effects (courtesy of Sukra Helitek, ref. 30).....	27
Figure 3-10. EWR Copter ILS Runway 4L.....	28
Figure 5-1. Prioritization criteria.....	42
Figure 6-1. An integrated systems tradeoff process for a CTR research and development cycle.....	51

## LIST OF TABLES

Table 3-1.	Examples of Existing Controls for Risk Mitigation.....	17
Table 3-2.	Severity Definitions for atc Services and Flight Crew.....	18
Table 3-3.	Severity Definitions for Flying Public.....	19
Table 3-4.	Likelihood of Occurrence.....	20
Table 4-1.	CTR Operations Matrix.....	29
Table 5-1.	Operational Needs Metrics.....	43
Table 5-2.	Benefits Metrics.....	43
Table 5-3.	Feasibility Metrics.....	44



## ACRONYMS

4DT	Four-Dimensional Trajectory
AC	FAA Advisory Circular
ACES	Airspace Concept Evaluation System
ACI	Airports Council International
ADS-B	Automatic Dependent Surveillance-Broadcast
AEDT	Aviation Environmental Design Tool
AFM	Aircraft Flight Manual
APWG	Airspace and Procedures Work Group
ATC	Air Traffic Control
ATL	Atlanta International Airport
ATM	Air Traffic Management
ATO	Air Traffic Organization
ATS	Air Traffic Services
BADA	Base of Aircraft Data
BCPMWG	Business Case and Performance Metrics Work Group
BOS	Boston Logan International Airport
CACR	Collaborative Airspace Constraint Resolution
CDM	Collaborative Decision Making
CDTI	Cockpit Display of Traffic Information
CESTOL	Cruise-Efficient Short Takeoff and Landing
CITL	Controller-in-the-Loop
CNS	Communication, Navigation, and Surveillance
ConOps	Concept of Operations
COS	Colorado Springs Airport
CTOP	Collaborative Trajectory Options Program
CTR	Civil Tiltrotor
DA/DH	Decision Altitude/Decision Height
EDMS	Emissions and Dispersion Modeling System

EWR	Newark Liberty International Airport
FAA	Federal Aviation Administration
FADEC	Full Authority Digital Engine Control
FAR	Federal Aviation Regulation
FCA	Flow Control Area
FMS	Flight Management System
GPS	Global Positioning System
GUC	Gunnison-Crested Butte Regional Airport
HDN	Yampa Valley Airport
HNL	Honolulu International Airport
ICAO	International Civil Aviation Organization
ICDS	Interconnect Drive Shaft
ICWG	Integrated Capabilities Work Group
IFR	Instrument Flight Rules
ILS	Instrument Landing System
INM	Integrated Noise Model
JFK	John F. Kennedy International Airport
JPDO	Joint Planning and Development Office
KIAS	Knots Indicated Airspeed
KJRA	West 30th Street Heliport
LCTR	Large Civil Tiltrotor
MAP	Missed Approach Point
MGM	Montgomery Regional Airport
MWGB	Mid-Wing Gearbox
$N_p$	Engine Speed
NAC	NextGen Advisory Committee
NACSC	NAC Subcommittee
NAS	National Airspace System
NextGen	Next Generation Air Transportation System

NIO	Noninterference Operations
NIRS	Noise Integrated Routing System
nm	nautical mile
NMAC	Near Mid-Air Collision
NYC	New York City
PITL	Pilot-in-the-Loop
PLA	Powered Lift Aircraft
PNIO	Partially Non-Interfering Operations
PRGB	Proprotor Gearbox
RIO	Runway Independent Operations
RNM	Rotorcraft Noise Model
ROL	Roll-on Landing
SMS	Safety Management System
SOP	Standard Operating Procedure
SRM	Safety Risk Management
STOL	Short Takeoff and Landing
SWIM	System-Wide Information Management
TBO	Trajectory-Based Operations
TCAS	Traffic Collision Avoidance System
TOGA	Takeoff and Go Around
TMI	Traffic Management Initiative
UAS	Unmanned Aircraft System
VTOL	Vertical Takeoff and Landing
WAAS	Wide Area Augmentation System



# AN ASSESSMENT OF CIVIL TILTROTOR CONCEPT OF OPERATIONS IN THE NEXT GENERATION AIR TRANSPORTATION SYSTEM

William W. Chung,<sup>1</sup> Dan Salvano,<sup>2</sup> David Rinehart,<sup>3</sup> Ray Young,<sup>3</sup> Victor Cheng,<sup>4</sup>  
and Jim Lindsey<sup>5</sup>

Ames Research Center

## SUMMARY

Based on a previous Civil Tiltrotor (CTR) National Airspace System (NAS) performance analysis study, CTR operations were evaluated over selected routes and terminal airspace configurations assuming noninterference operations (NIO) and runway-independent operations (RIO). This assessment aims to further identify issues associated with these concepts of operations (ConOps), and their dependency on the airspace configuration and interaction with conventional fixed-wing traffic. Safety analysis following a traditional Safety Management System (SMS) methodology was applied to CTR-unique departure and arrival failures in the selected airspace to identify any operational and certification issues. Additional CTR operational cases were then developed to get a broader understanding of issues and gaps that will need to be addressed in future CTR operational studies. Finally, needed enhancements to National Airspace System performance analysis tools were reviewed, and recommendations were made on improvements in these tools that are likely to be required to support future progress toward CTR fleet operations in the Next Generation Air Transportation System (NextGen).

## 1 INTRODUCTION

The unique capability of Civil Tiltrotor (CTR) aircraft to cruise like conventional fixed-wing aircraft and takeoff and land vertically (Vertical Takeoff and Landing (VTOL)) or in a short distance (Short Takeoff and Landing (STOL)) provides a potential to improve the National Airspace System (NAS) performance by increasing air traffic capacity and reducing delay. A recent CTR study (ref. 1) found that such performance improvement can be realized under the Next Generation Air Transportation System (NextGen) based on projected CTR airframe and propulsion system technology enhancements. Improved NAS capacity and delay performance were demonstrated through NAS performance analysis of three short-haul markets under 500 statute miles: Northeast Corridor, Atlanta, and Las Vegas. The analysis was based on a mixed fleet of CTRs comprised of 30-, 90-, and 120-passenger tiltrotors.

---

<sup>1</sup> Science Applications International Corporation (SAIC), 45310 Abell House Lane, California, MD 20619.

<sup>2</sup> Science Applications International Corporation (SAIC), 1710 SAIC Drive, McLean, VA 22102.

<sup>3</sup> Saab Sensis Corporation, 11111 Sunset Hills Road, Suite 130, Reston, VA 20190-5373.

<sup>4</sup> Optimal Synthesis, Inc., 95 First Street, Suite 240, Los Altos, CA 94022-2777.

<sup>5</sup> Monterey Technologies, Inc., 24600 Silver Cloud Ct., Suite 103, Monterey, CA 93940.

Improved performance in traffic capacity and delay were achieved by assuming that the CTR fleet can be operated under noninterference operations (NIO) and runway-independent operations (RIO) via its unique thrust vectoring capabilities for VTOL and STOL operations. The purpose of this study is to further identify the NIO and RIO dependency according to scenarios based on CTR flight performance, i.e., VTOL, STOL, and climb-, cruise-, and descent-derived flight trajectories, with known conventional traffic flow and runway configurations of a given airspace, as well as issues associated with environmental impact.

This study first examined the issues associated with NIO and RIO using a shuttle service between Boston Logan International Airport (BOS) and Newark Liberty International Airport (EWR) to investigate airspace-dependent issues. This was one of the routes identified in reference 1. A safety analysis was also performed, focusing on CTR thrust-vectoring failure modes, following traditional Safety Management System (SMS) and Safety Risk Management (SRM) methodology. Operational and safety issues associated with the CTR fleet in specific terminal configurations such as departure and arrival at the EWR were identified.

A range of case studies was developed through a systems analysis that identified where CTR operations are most likely to be feasible, in terms of performance and cost benefit according to passenger size and service range. Key issues for these selected CTR services were discussed and identified as a foundation for future research efforts.

Finally, based on studies regarding the NIO and RIO concept of operations, safety analysis, and case studies, the study concluded that advances in NAS performance analysis tools are required to develop and evaluate future CTR concepts of operations (ConOps) and procedures, and potential environmental impact. The main limitations of existing tools are inadequate CTR models (performance and environmental impact) and limited ability to model interactions between CTR and conventional operations in complex adaptive airspace.

## **2 ASSESSMENT OF KEY ASSUMPTIONS FOR CTR CONOPS**

One of the objectives of this study is to identify issues and assumptions to support future studies in addressing the integration of a CTR fleet into the NAS. Previous studies that have shown that civil tiltrotor aircraft will improve NAS performance in terms of capacity and delay were based on an integrated fleet ConOps, e.g., sharing conventional runways with CTR STOL capability (refs. 2–6), or a segregated ConOps with CTR VTOL and STOL capabilities such as NIO and RIO (ref. 1). In the latter case, significant improvements in throughput performance and delay were demonstrated in the Northeast Corridor, Atlanta region, and Las Vegas region through traditional NAS performance analysis tools, i.e., *Airspace Concept Evaluation System* (ACES) (ref. 7). A motivation for the current study was a desire to learn what tradeoffs would be required to realize the benefit gained through these segregated airspace approaches. A CTR shuttle service route between BOS and EWR was selected such that both CTR flight performance (takeoff, departure, cruise, descent, and approach and landing), and constraints from the airspace were investigated and analyzed.

### **2.1 Preliminary Analysis Based on a BOS–EWR CTR Route**

A CTR operation between BOS and EWR was evaluated to identify issues associated with NIO and RIO for future studies. Takeoff, en route, and arrival routes were discussed separately to account for operational characteristics at each flight phase of the CTR operations (vertical takeoff and climb, cruise, and approach and vertical landing).

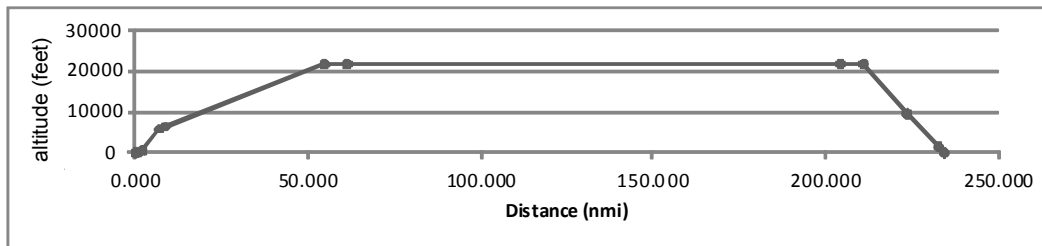

**Figure 2-1. A 120-passenger CTR flight profile.**

### 2.1.1 General Flight Profile

The flight profile of a 120-passenger CTR in figure 2-1 was developed to incorporate several CTR operating modes:

- Vertical takeoff and landing (VTOL)
- Steeper than conventional initial climb
- Completion of climb at normal rate for airplane-mode CTR
- Cruise at 22,000 feet (determined in reference 1 to be the most efficient altitude for this route)
- Steeper than conventional continuous descent to landing

(Note that the axes are not to scale in figure 2-1, therefore the climb and descent angles are exaggerated. The additional points between vertices indicate acceleration changes.)

The total profile distance is consistent with the distance between BOS and EWR, assuming some degree of indirect flight is needed (e.g., on climb and descent). This profile can be bent horizontally as needed, including spirals.

The “steeper than conventional” descent (9-degree glideslope) shown is the steepest descent modeled in the previous study (ref. 1). Carefully managed deceleration was found to be an important part of the descent, as the high angle leads to high closure rate with the ground if the speed is not reduced. Automated flight controls with high-resolution control of the nacelle angle during descent would be beneficial both to ensure safe, stable flight and to reduce pilot workload, which is substantial during a steep descent. Future CTR vehicles could very well do better in a steep, slow climb—for example, by incorporating flaps for that purpose and a few degrees of nacelle angle. The initial climb can be as long or short as necessary to establish vertical separation over conventional traffic.

The preceding profile provides a starting point for the exploration of non-interfering departure and arrival CTR operations.

### 2.1.2 Takeoff and Departure at EWR

As part of the evaluation of the EWR–BOS scenario, options for CTR takeoff and departure from EWR were considered. CTR takeoff and climb-out performance under RIO and NIO was a key issue. Site #5 shown in figure 2-2 was chosen as a possible CTR VTOL operational site in reference 1 under the RIO assumption. To achieve the RIO without interfering with conventional fixed-wing traffic from Runway 4L/4R, and without creating undesired environmental impact to the surrounding community, a possible spiral climb-out concept as suggested in reference 8 is shown in figure 2-3. Figure 2-3 illustrates a conceptual departure from EWR

that incorporates a partial spiral, based on CTR unique nacelle conversion characteristics, as an alternative to a direct departure to the northeast. The purpose of the spiral portion is to gain sufficient altitude to allow a CTR climb corridor to be procedurally separated above conventional traffic and missed approaches. Figure 2-3 also illustrates a CTR climb-out route that avoids high population concentrations by tracking over water.

Figure 2-4 shows an example of departure traffic patterns at EWR, with the circling CTR departure overlaid. This CTR departure profile aims at attaining sufficient altitude to pass above conventional arrival and departure operations. The radius of the spiral climb-out is dictated by CTR speed during the climb-out. A pilot-in-the-loop (PITL) simulation will be required to consider CTR climb performance and pilot workload in maintaining the separation from Runway 4L/4R while gaining the altitude and speed.

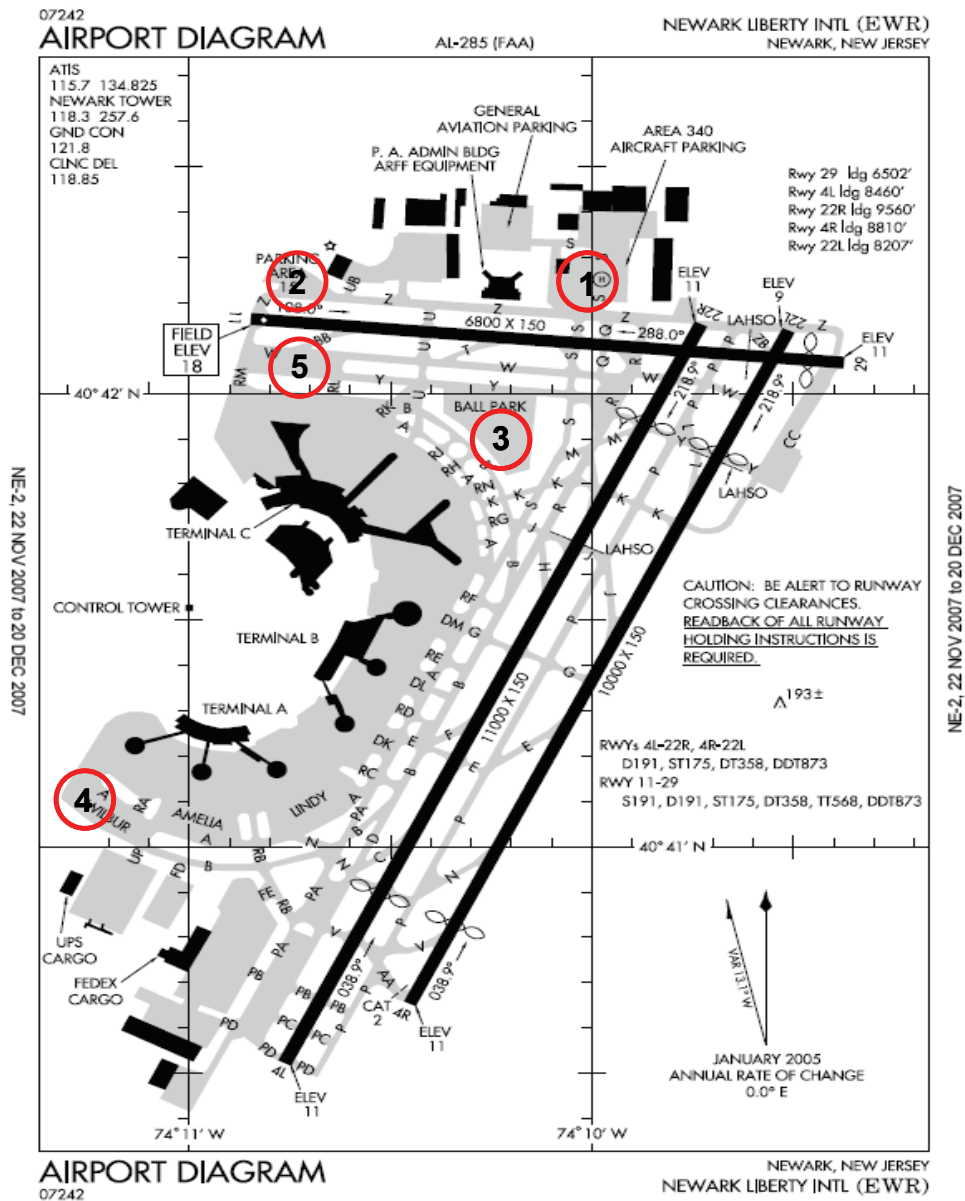

Figure 2-2. Possible vertiport sites at EWR.



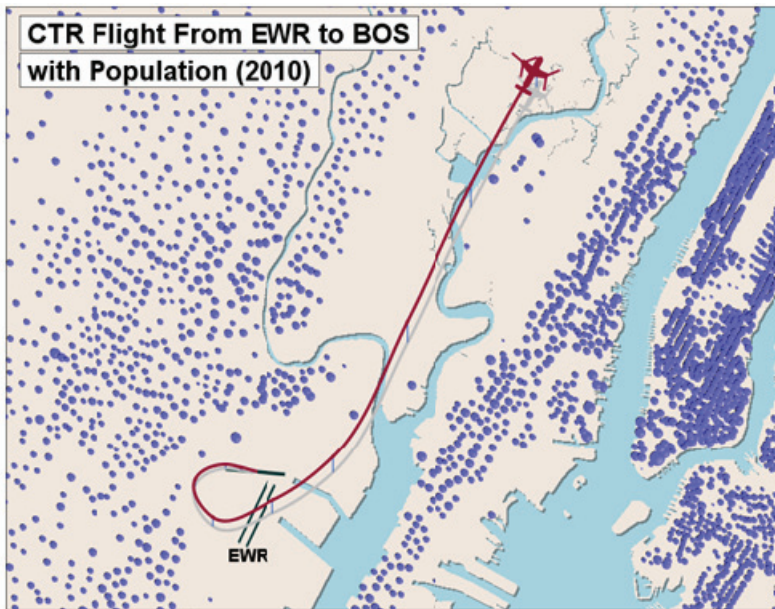

Figure 2-3. EWR spiral departure.

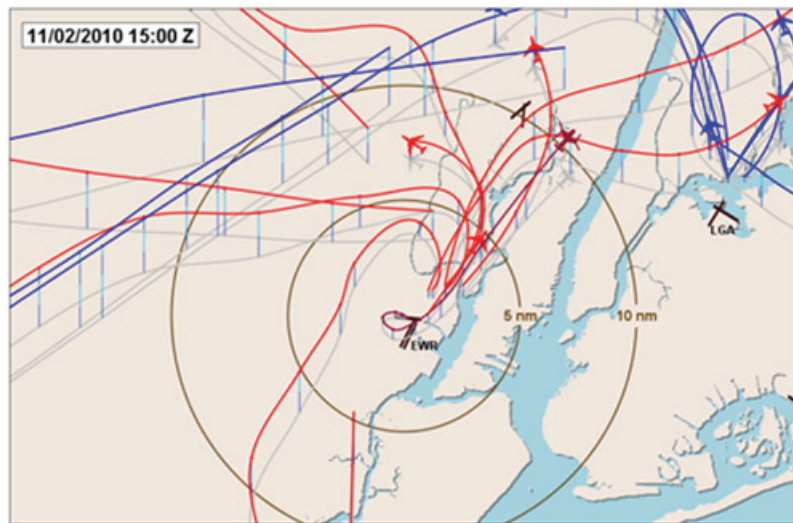

Figure 2-4. Notional departure traffic patterns at EWR.

To properly evaluate this type of unconventional departure profile(s) on overall NAS throughput performance and safe separation, a consolidated version of ACES, a NAS performance analysis tool (ref. 7) with both en route and terminal modeling capability, is required. The integrated tool allows the users to evaluate potential departure profiles, procedures, and airspace through terminal to an en route transition point to ensure that separation assurance for the CTR fleet is achieved. Ultimately, analysis tools such as the Aviation Environmental Design Tool (AEDT) will be needed to evaluate CTR noise and environmental impact. In total, improved CTR modeling requires accurate CTR performance, noise, and emissions models, as well as NAS and environmental modeling tools.

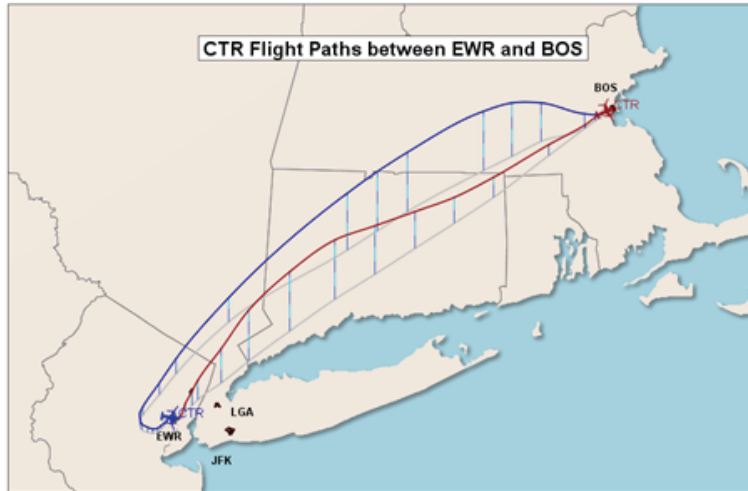

Figure 2-5. Notional CTR paths between EWR and BOS.

### 2.1.3 NIO in En Route

Notional flight paths showing cruise climb paths between EWR and Boston are shown in figure 2-5. The illustration is based on a combination of a direct routing from BOS to EWR, and a circling departure from EWR with a direct arrival into BOS.

A significant unknown is future implementation of 4-Dimensional Trajectory-Based Operations (TBO), or 4DT, for CTR operations and flow corridors. Although there is extensive ongoing research in TBO and flow corridor concepts, there is still much to be done before consensus can be reached on ConOps in these areas. In particular, for both conventional and CTR operations, research is currently not mature, especially in terms of the interaction between 4DT and flow corridors, in approaches for en route merging and spacing operations, and in terms of adaptive and collaborative air traffic management.

For the CTR fleet, en route airspace performance analysis is adequate because civil tiltrotor aircraft operate like a conventional fixed-wing aircraft in this phase of the flight, where, in the case of ACES airspace analysis, the CTR aerodynamic and propulsion model input entries are fully compatible with the Base of Aircraft Data (BADA) (ref. 9) format structure. The issue currently under investigation is how the CTR fleet transitions in and out of the direct-to routes into the terminal airspace where conventional fixed-wing traffic are merging from different cruising altitudes and climb or descent rates. Detailed terminal area ConOps need to be developed and evaluated so that safe separation can be achieved.

### 2.1.4 Approach and Arrival at EWR

As part of the evaluation of CTR flight phases, this section considers options for CTR arrival and landing operations at EWR. The issues involve CTR descent and landing performance. Figure 2-6 illustrates a circling CTR arrival at EWR, and figure 2-7 shows corresponding conventional arrival and departure patterns, together with a circling CTR arrival at EWR. For figures 2-6 and 2-7, the same comments apply as those made in reference to figures 2-3 and 2-4 during the climb-out. To maintain safe separation from the conventional fixed-wing traffic and minimize noise footprint, a steeper than usual descent profile, such as a spiral descent, needs to be considered. A spiral descent approach was investigated in a PITL simulation

(ref. 1) shown in figure 2-8. A 30-passenger CTR in the airplane mode at a speed of 225 knots indicated airspeed (KIAS) initiated a spiral descent starting at an altitude of 10,000 feet and ending at 5,000 feet with 30-degree bank angle, 3-degree/second turn rate, and a descent rate of 1,500 feet/minute, resulting in a turn radius of about 1 nautical mile (nm). The spiral descent offers a possibility to tailor CTR arrival and climb-out profiles, coupled with a vertical landing, to meet the NIO and RIO requirements in the terminal area. CTR flight performance and pilot-vehicle interface issues, however, must be addressed.



Figure 2-6. Notional CTR arrival track at EWR.

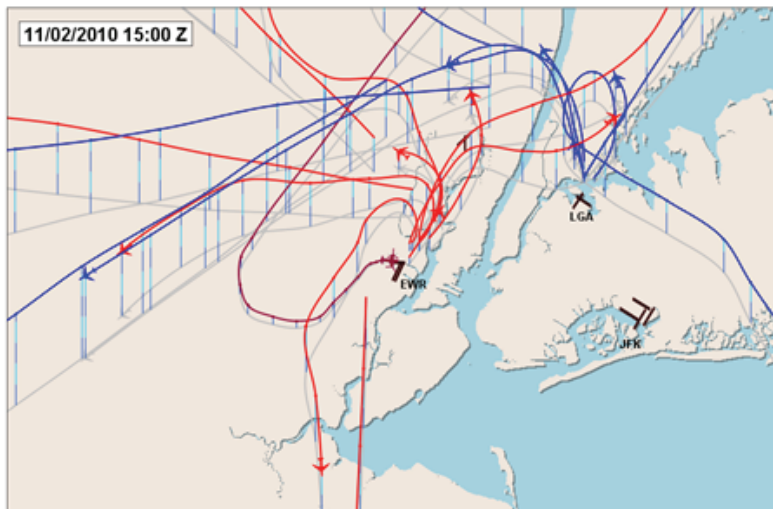

Figure 2-7. Notional arrival traffic patterns at EWR.

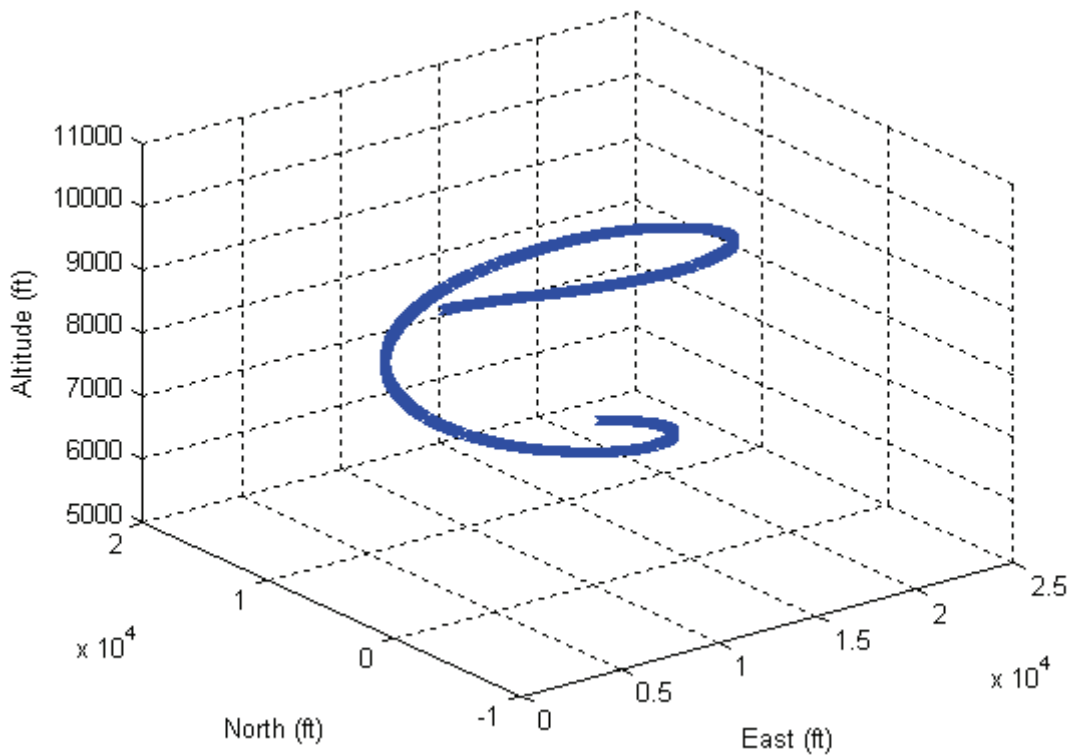

Figure 2-8. A spiral descent profile of a 30-passenger CTR.

Similar to the departure flight segment, assessment of CTR arrival operations also need integrated airspace performance analysis tools to properly evaluate the total effects with different arrival ConOps. Currently available tools do not have the capability to support an across-the-board analysis according to the unique airspace configurations of different airports.

## 2.2 Summary of Further Research Topics in CTR ConOps

The CTR ConOps assumptions of NIO and RIO were examined using CTR flight profiles between BOS and EWR. Departures and arrivals at EWR were also examined to identify considerations that need to be addressed in support of the NIO and RIO when conventional fixed-wing traffic is also present. A spiral climb-out and descent as suggested in reference 7 could be a possible candidate for tailoring CTR operational profiles to support separation constraints presented by NIO and RIO without inserting CTR departure and arrival into the already congested runway usage by the conventional fixed-wing traffic. Additional effort will be required to investigate if CTRs can meet the climb performance with a desired speed and passenger comfort, given a constrained airspace, while also maintaining safe separation from the fixed-wing traffic. The same situation will be true in the approach and landing. This suggests a PITL simulation will be required, with a given airspace and constraints imposed by fixed-wing traffic due to runway configurations, to address CTR performance as well as pilot-vehicle interface issues such as workload and passenger comfort.

Assuming a satisfactory ConOps can be developed (e.g., using the spiral climb-out and descent) to address the NIO and RIO in the terminal area, a question remains as to whether the overall CTR fleet will still be able to retain the time delay improvement benefit and competitive fuel burn performance. An integrated en route and terminal airspace performance analysis tool will be required to accurately model the flight performance including fuel burn of the CTR fleet, as well as the ability to model different departure and arrival concepts in different terminal areas to account for location-dependent airspace constraints.

This study considered only options for CTR arrival and departure operations at EWR. The issues involving CTR descent and landing performance will need to be expanded to other airports to consider other airspace and geographical unique factors. The above qualitative discussion as to CTR ConOps was instrumental in follow-on assessments related to CTR operational safety. This safety assessment will now be presented.

### **3 SAFETY ANALYSIS OF CTR OPERATIONS**

CTRs belong to a category of aircraft known as Powered Lift Aircraft (PLA). PLA are heavier-than-air aircraft that are capable of vertical takeoff and landing (VTOL) and low-speed flight. PLA depend on engine-driven lift devices or engine thrust for lift during VTOL/low-speed flight and on nonrotating wing(s)/airfoil(s) for lift during level flight. CTRs have the unique operating ability to takeoff and land like rotorcraft, and cruise like conventional fixed-wing turbo-propeller aircraft. CTRs are capable of performing both VTOL and short takeoff and landing (STOL) operations. These unique capabilities give CTRs the flexibility to operate under a different concept of operations (ConOps) from their fixed-wing counterparts, i.e., runway-independent operations (RIO), etc. One of the basic NextGen assumptions described in a recent NASA study (ref. 1) is that CTR operations using RIO, or underutilized runways, can directly increase the capacity, or reduce delays, in the National Airspace System (NAS).

The same unique operating characteristics that provide these benefits can also create new risks during nominal and non-nominal operations. This report describes a method to evaluate potential CTR NAS operational hazards, perform a risk assessment, and manage any identified risks. This study is not intended to provide an exhaustive risk assessment of CTR operations, but rather a description of the process using specific hazard examples to illustrate the operational characteristics that are unique to the CTR and to identify issues for future safety analysis.

#### **3.1 Safety Terminologies and Methodology**

Many common safety terminologies and methodology used by the Federal Aviation Administration (FAA) and airline operators are adopted in this study to establish commonly acceptable safety analysis criteria.

##### **3.1.1 Safety**

Depending on the perspective of the individual stakeholder, the concept of aviation safety may have different connotations:

- The traveling public could see it as zero accidents or incidents,
- Regulators could see it as 100-percent compliance with all airworthiness standards, and
- Air traffic service providers could view it as no loss of separation in the air or on the ground.

For the purpose of this study, safety is defined as “The state in which the possibility of harm to persons or of property damage is reduced to, and maintained at or below, an acceptable level through a continuing process of hazard identification and safety risk management” (ref. 10).

This definition brings several new concepts into the discussion of safety. First, safety assurance is a “continuing process” with a broad scope and includes the full set of activities necessary to meet safety objectives. Second, while the elimination of all accidents and incidents is desirable, a perfect safety record is unachievable. Failures and error will occur because no human-made system can be guaranteed to be absolutely safe. These safety objectives, sometimes called “acceptable levels of safety,” are relative in that what is “acceptable” is dependent on such things as the system design, procedures, and aircraft operation, and may change as these parameters are changed. Third, because safety is defined in terms of risk, any consideration of safety must involve the concept of risk (ref. 10).

### **3.1.2 Hazard and Risk**

While all the safety terms are defined in Appendix A, the definition and differences between “risk” and “hazard” need to be discussed separately because hazard identification and risk management are core processes involved in the management of safety.

A hazard is a condition or an object with the potential to cause injuries to personnel, damage to property (equipment or structures), or the degradation or loss in the ability to perform a specific operation. Wind is not generally thought of as a hazard, but it has the potential to cause injuries to personnel or damage to property.

Consider a 15-knot wind case. If the wind is blowing directly down the runway during takeoff, it is not a hazard but rather a benefit to airplane performance. Consider the potential consequences of that same 15-knot wind blowing at 90 degrees across the runway; it becomes a crosswind and a potential hazard as it can affect the pilot’s ability to complete a takeoff or landing.

Safety risk can be defined as the assessment, expressed in terms of predicted probability and severity, of the consequences of a hazard, using the worst-case scenario. Risk is usually expressed in an alphanumeric convention that allows for measurement. Using the 15-knot wind example, the linkage of safety risk with hazards and their consequences can be shown:

- The wind blowing directly across the runway is a hazard.
- The potential for an aircraft having a lateral excursion while it travels down the runway, because the pilot may not be able to control the aircraft, is one of the consequences of the hazard (risk); and
- The assessment of the consequences of a runway lateral excursion, expressed in terms of a probability and severity matrix, is the safety risk (ref. 11).

Figure 3-1 is a representation of a safety risk matrix. The terminology used in this safety risk matrix, and the associated analysis, are defined in Appendix A.

### **3.1.3 Safety Management System (SMS)**

The Safety Management System (SMS) is an integrated collection of processes, policies, and programs used to define, assess, and manage the safety risk in the provision of, and changes to, Air Traffic Control (ATC) and navigation services. From the discussion in the previous section, one can simply state that safety is freedom from “unacceptable” risk. The issue remains: how to determine “acceptable risk,” how to know when it has been achieved, and finally, how to ensure it is maintained when changes are made to the system?

Given the complexity of the NAS today, and the implementation of NextGen technology and capabilities, a fundamental change to the way civil aviation safety is managed is required.

An integral part of SMS is Safety Risk Management (SRM). Under the SRM process, the organization describes the system, identifies the hazards, analyzes and assesses the risks associated with those hazards, and then mitigates any unacceptable risks. The process flow for SRM is shown in figure 3-2. Putting all the key elements of the process together, a flow diagram of the SMS is shown in figure 3-3.

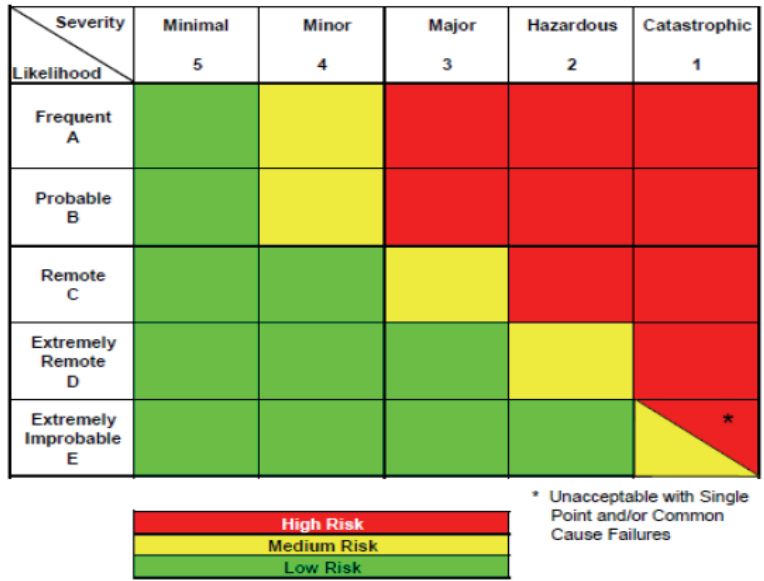

Figure 3-1. A representative safety risk matrix.

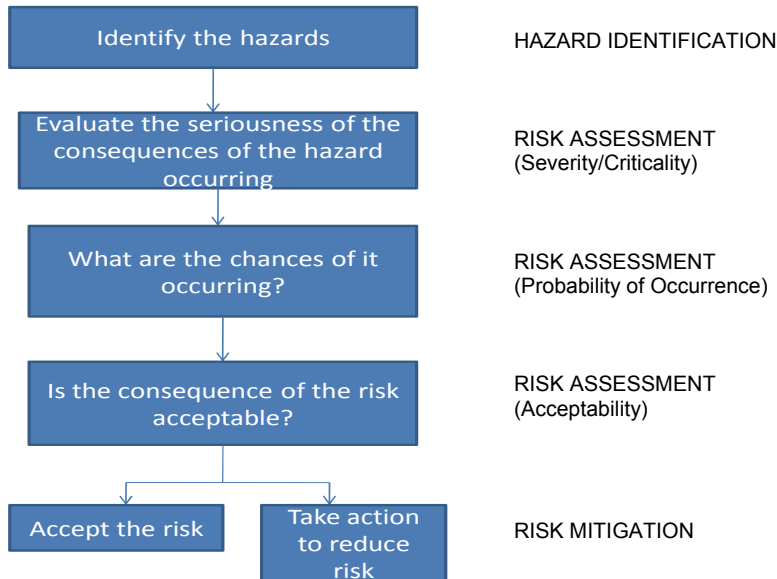

Figure 3-2. Process flow for Safety Risk Management.



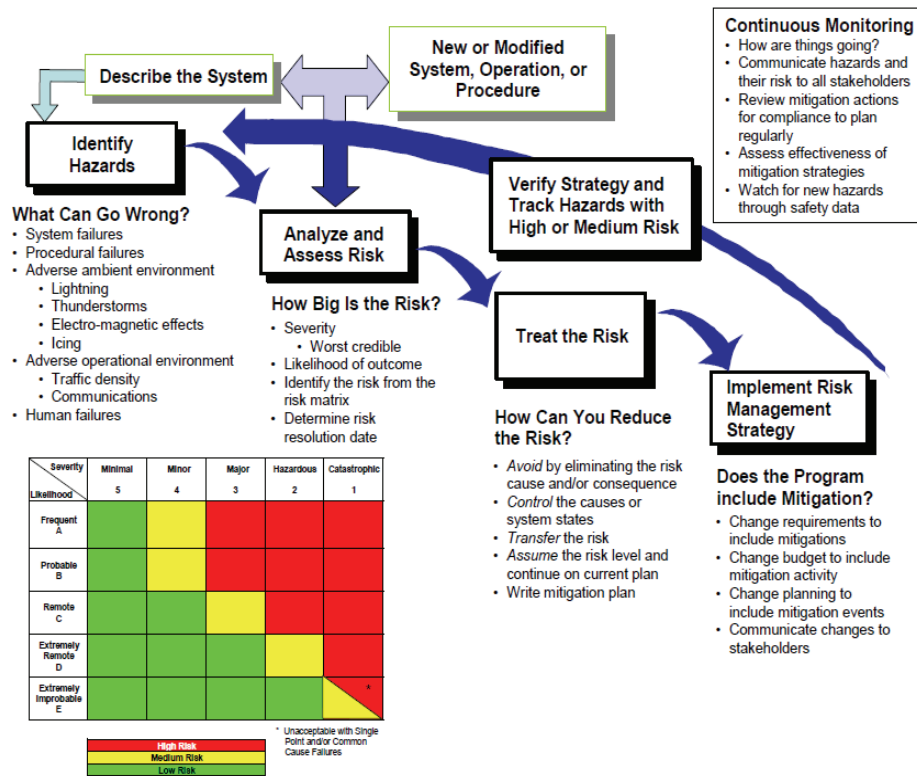

Figure 3-3. The Safety Management System flow diagram.

### 3.1.4 SRM Process for Civil Tiltrotors (CTRs) in the NAS

For the purpose of this safety assessment, the following assumptions are made:

1. The operation of a fleet of CTRs in the future NAS (2025), with full NextGen capabilities, i.e., 4DT, approach flow corridors, and shared situational awareness.
2. Approach/landing and taxi/takeoff RIO/NIO operations, both VTOL and STOL, in the terminal area (ref. 1) by the CTR. These phases of flight are of particular concern with CTR operations because the aircraft will either be transitioning from the airplane mode to helicopter mode on approach and landing, or from helicopter mode to airplane mode during the takeoff/climb-out phase of flight.
3. En route operation not included. Safety evaluation of CTR en route operations is not included because en route airspace CTR performance characteristics are similar to conventional turboprop aircraft.

Using the SMS risk management template shown in figure 3-3, the case study results from reference 11, and recommendations from SMEs, a “scenario-based” analysis was developed to identify “operational” hazards of CTRs. Using these operational scenarios, a structured approach was used to determine “what can go wrong.” However, this study did not evaluate potential design risks that would normally be analyzed during the type certification process.



To select representative operational scenarios, the following considerations were developed.

1. Airspace changes: Air Traffic Services (ATS) route structure, re-sectorization, new approach flow corridors, etc.
2. Changes to air traffic control procedures and standards: reduced separation minima, new operating procedures such as RIO/NIO, etc.
3. Changes to airport runway, taxiway operations
4. Non-nominal operations such as an engine failure during transition from aircraft to helicopter mode, etc.
5. Failure of aircraft system(s) during a critical portion of flight.

Once the hazards are identified, the seriousness of the risk associated with that hazard and the frequency of that hazard’s occurrence in accordance with figure 3-3 were evaluated. The risk is either a qualitative or quantitative measure.

After ranking risks according to severity and likelihood, safety risk control and mitigation plans need to be determined for those risks identified as unacceptable. This includes mitigations such as operational change, procedure change, or design change.

Based on the mitigations identified, the best balanced response was selected for development of a risk treatment plan. The selected mitigation was verified by running through the SMS process to verify that the overall risk was reduced to an acceptable level. The overall process is shown in a decision logic diagram in figure 3-4 (ref. 10).

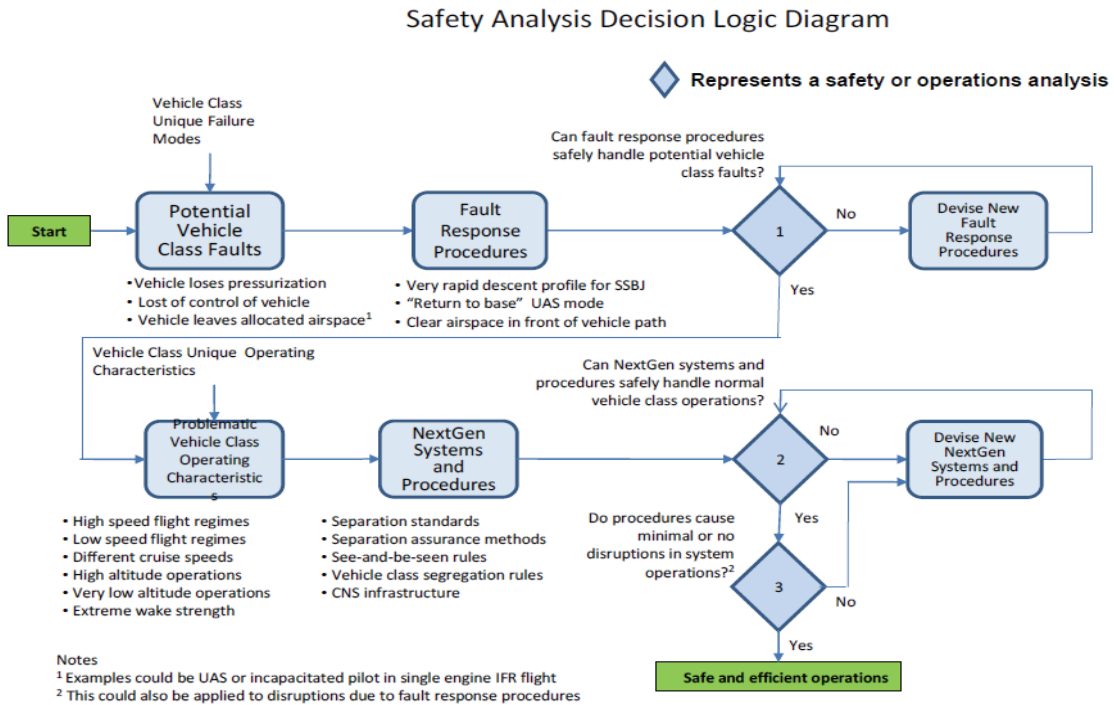

Figure 3-4. Decision logic for safety analysis.

## **3.2 Safety Analysis Approach**

A safety analysis approach was developed to follow the safety analysis and risk mitigation process developed in section 3.1 with selected scenarios to investigate if the unique operational characteristics of CTRs would lead to unsafe operations.

The New York City (NYC) airspace is extremely congested and contains some of the busiest airports in the country. One of the drivers for this congestion is the geographical closeness of John F. Kennedy, Newark Liberty, LaGuardia, and Teterboro airports. They fall within a circle with a diameter of about 20 miles. CTRs will be fully integrated into the NYC airspace with procedures specifically developed to take advantage of the unique CTR operating characteristics (NIO/RIO).

Because this study was not intended to be an exhaustive survey of potential CTR NAS operational safety concerns, generic failure scenarios unique to the CTR were studied. Three possible generic failure scenarios for CTR NextGen operations, using the data generated from reference 1, were developed to identify potential issues with operating the CTR in the NextGen. These scenarios may involve one or a combination of the following factors:

1. Inability of the nacelles to rotate to proper angle for flight conditions,
2. Failure of the Interconnect Drive Shaft (ICDS), and
3. Encounter with upset conditions (wind gust, wind shear, wake vortex, etc.) during a critical phase of flight.

Using the FAA's Safety Management System (SMS) and the International Civil Aviation Organization's (ICAO's) SMS, policies, processes, and procedures as previously described, the team looked at those scenarios with the goal of minimizing safety risk. The safety risk model used focused on the impact to NAS safety resulting from the operation of CTRs, with the basic premise being there is no unacceptable risk in the provision of air traffic control and navigation services during nominal and off-nominal CTR operations. The safety risk of the aircraft was not considered because this would have been examined during the aircraft certification and airworthiness approval process.

## **3.3 Development of the Three Safety Analysis Scenarios**

To further investigate safety issues associated with unique CTR operational characteristics—i.e., nacelle conversion, takeoff and departure, and approach and landing—particular detailed scenarios were developed. The three scenarios chosen for this detailed analysis were:

1. Failure of the ICDS during a VTOL takeoff,
2. Inability of the nacelles to rotate during a VTOL landing, and
3. Failure of the ICDS during a VTOL landing.

Each of these scenarios is discussed in detail below.

### 3.3.1 Scenario 1—Interconnect Driveshaft System (ICDS) Failure During a VTOL Takeoff

#### 3.3.1.1 Scenario

A CTR is performing a VTOL takeoff from the Newark Liberty (notional) vertiport (shown as site #5 in figure 3-5). After achieving a stabilized hover, the nacelles are translated to 75 degrees in order to begin climbing as shown in a representative takeoff and climb profile, figure 3-6 (ref. 1). Before reaching 400-foot altitude and 90-knot airspeed – flight conditions where nacelle rotation to 0 degrees would nominally begin – an ICDS failure indication occurs. The weather condition is moderate rain with winds gusts up to 20 knots from the north and Category I. Instrument Flight Rules (IFR) landing conditions are in effect. The airport is using both parallel runways for fixed-wing operations as shown in figure 3-5.

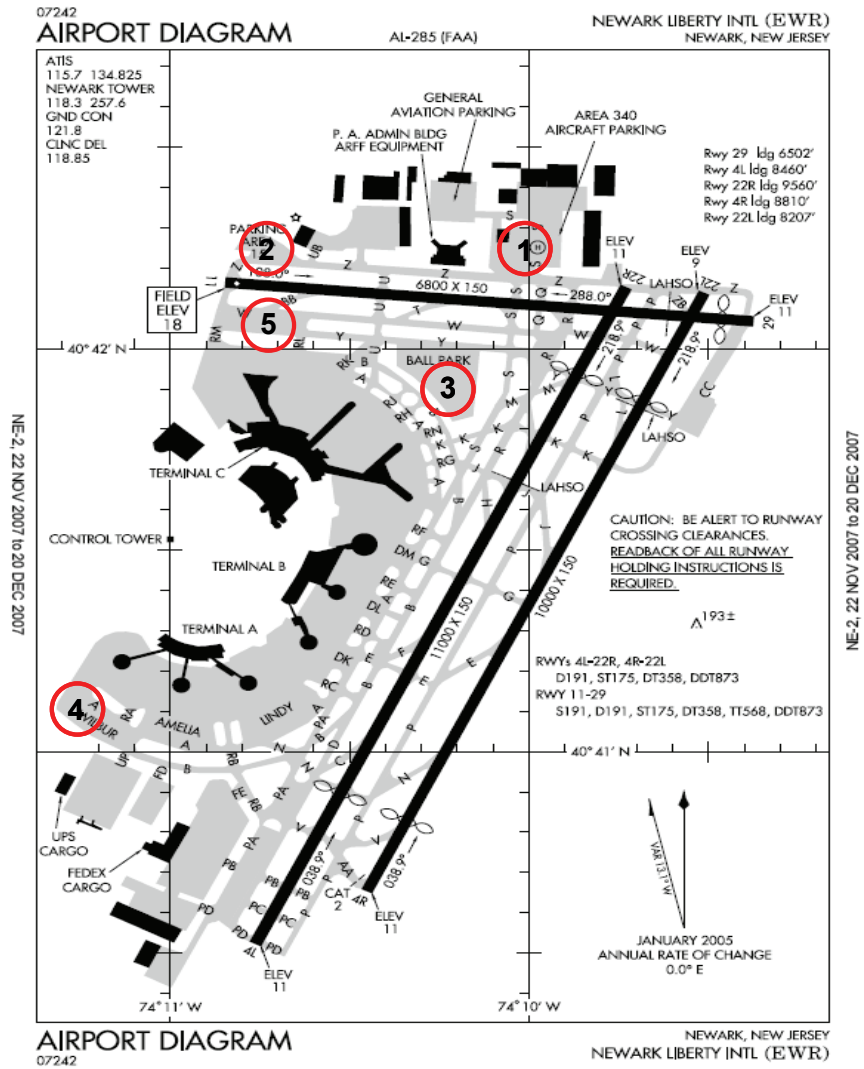

Figure 3-5. Possible vertiport sites at EWR.

### 3.3.1.2 Identify Hazard

The flight crew declares an emergency and prepares for a takeoff and go around (TOGA) to attempt a landing on the runway with minimum crosswind. Given the weather conditions, this would mean a STOL landing on runway 4L (see figure 3-5). Figure 3-5 shows the possible vertiport sites considered in reference 1, where site #5 was chosen to be optimal for CTR operations. The declaration of emergency with the subsequent TOGA presents potential hazards in the ability of the CTR to continue the takeoff and eventually land safely.

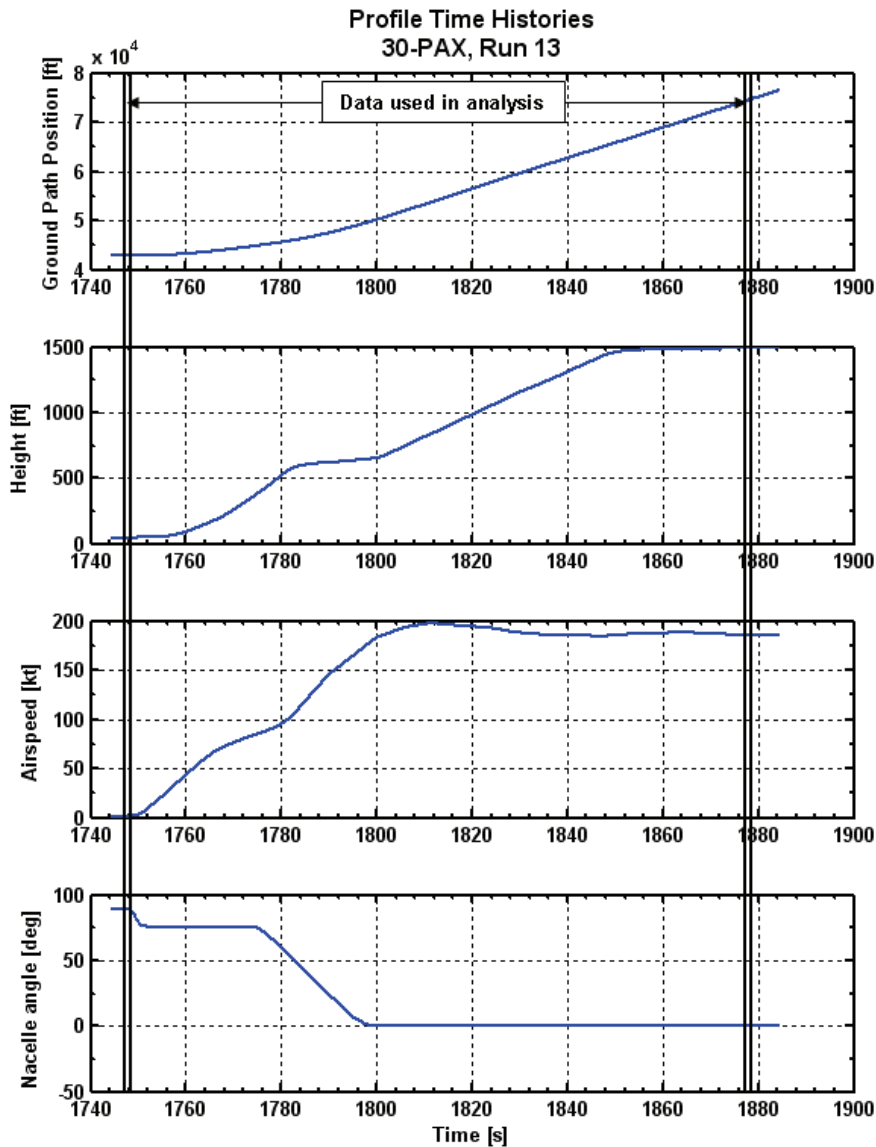

Figure 3-6. 30-passenger takeoff time history, VTO.

A 30-passenger CTR takeoff time history from a pilot-in-the-loop (PITL) flight simulation from reference 1 is shown in figure 3-6. It is assumed for the purposes of this analysis that a 120-passenger CTR will be flying a similar trajectory as the 30-passenger CTR.

The main purpose of the ICDS is to provide power to both rotors in the event of a single-engine failure, as well as to synchronize the rotor. In the event of an ICDS disconnect, the crew would default to a STOL roll-on landing (ROL) on the runway that minimizes crosswind. The ROL is preferred because it is easier and requires less power, and by minimizing crosswind there is less opportunity for an engine speed ( $N_p$ ) mismatch. While a VTOL landing is possible, it is more difficult to effect because, in hover mode, unmatched engine speeds can result in degraded lateral handling qualities.

### 3.3.1.3 Risk Assessment

Given the above, now that a potential hazard has been identified, the next step in the SMS process is to analyze the risk. Risk is a composite of the predicted severity and likelihood of the potential effect of that hazard in the worst credible system state. As the hazard is evaluated with respect to NAS operations from a systems perspective, any potential condition that currently exists that could prevent or reduce the hazards occurrence, or mitigate its effects, can be identified. These mitigations are called “existing controls” (ref. 12). Table 3-1 provides some examples of existing controls.

### Severity Analysis

The severity of the hazardous event is the determination of how bad the adverse results of an event are predicted to be. As previously stated, the worst credible outcome must be considered. The outcome of the severity analysis is completely independent of the determination of the likelihood of the event occurring. The severity definitions used in this study come from the Federal Aviation Administration/Air Traffic Organization (FAA/ATO) SMS Manual (ref. 12) and are shown in tables 3-2 and 3-3.

TABLE 3-1. EXAMPLES OF EXISTING CONTROLS FOR RISK MITIGATION

Controller	Pilot	Equipment/Technical Operations
<ul style="list-style-type: none"> <li>• Radar Surveillance               <ul style="list-style-type: none"> <li>- Ground and Airborne</li> </ul> </li> <li>• Controller Scanning               <ul style="list-style-type: none"> <li>- Radar</li> <li>- Visual (Out Window)</li> </ul> </li> <li>• CA, Minimum Safe Altitude Warning (MSAW), AMASS ASDE-X</li> <li>• Procedures               <ul style="list-style-type: none"> <li>- Specific SOP Reference</li> <li>- FAA Order Reference</li> </ul> </li> <li>• Triple Redundant Radio</li> <li>• Controller Intervention</li> <li>• Training               <ul style="list-style-type: none"> <li>- Implementation</li> <li>- Routine Periodic</li> </ul> </li> <li>• Management Oversight</li> </ul>	<ul style="list-style-type: none"> <li>• TCAS</li> <li>• Ground Proximity Warning System (GPWS)</li> <li>• Visual Scanning (Out Window)</li> <li>• Radar Surveillance               <ul style="list-style-type: none"> <li>- Airborne</li> </ul> </li> <li>• Checklists</li> <li>• Redundancies/Back-up Systems</li> </ul>	<ul style="list-style-type: none"> <li>• Preventative Maintenance</li> <li>• Failure Warnings/Maintenance Alerts</li> <li>• Redundancy Systems               <ul style="list-style-type: none"> <li>- Triple Redundant Radio</li> <li>- Software Redundancy</li> </ul> </li> <li>• Diverse Points of Delivery               <ul style="list-style-type: none"> <li>- Microwave and TELCO</li> </ul> </li> <li>• Fall Back Systems               <ul style="list-style-type: none"> <li>- Center RADAR Processing (CENRAP)</li> <li>- Direct Access RADAR Channel (DARC)</li> </ul> </li> <li>• Software/Hardware Design</li> </ul>

For this scenario existing controls (table 3-1) that may mitigate the severity would be:

1. Air traffic procedures. There are specific standard operating procedures (SOPs) for dealing with an aircraft that declares an emergency during takeoff. This includes flight to the missed approach fix and clearing other aircraft in the path of the impacted aircraft for an emergency landing.
2. Flight crew. Flight crews are trained in takeoff and go-around operations. While Traffic Collision Avoidance System (TCAS) is not operational below 1,000 feet (today's procedures), Automatic Dependent Surveillance-Broadcast (ADS-B) out and Cockpit Display of Traffic Information (CDTI) are functioning. This gives the crew situational awareness of local traffic.

TABLE 3-2. SEVERITY DEFINITIONS FOR ATC SERVICES AND FLIGHT CREW

Effect On: ↓	Hazard Severity Classification				
	Minimal 5	Minor 4	Major 3	Hazardous 2	Catastrophic 1
ATC Services	Conditions resulting in a minimal reduction in ATC services, or a loss of separation resulting in a Category D Runway Incursion (RI) <sup>1</sup> , Operational Deviation (OD) <sup>2</sup> , or Proximity Event (PE)	Conditions resulting in a slight reduction in ATC services, or a loss of separation resulting in a Category C RI <sup>1</sup> or Operational Error (OE) <sup>2</sup>	Conditions resulting in a partial loss of ATC services, or a loss of separation resulting in a Category B RI <sup>1</sup> or OE <sup>2</sup>	Conditions resulting in a total loss of ATC services, (ATC Zero) or a loss of separation resulting in a Category A RI <sup>1</sup> or OE <sup>2</sup>	Conditions resulting in a collision between aircraft, obstacles or terrain
Flight Crew	<ul style="list-style-type: none"> <li>- Flightcrew receives TCAS Traffic Advisory (TA) informing of nearby traffic, or,</li> <li>- PD where loss of airborne separation falls within the same parameters of a Category D OE<sup>2</sup> or PE</li> <li>- Minimal effect on operation of aircraft</li> </ul>	<ul style="list-style-type: none"> <li>- Potential for Pilot Deviation (PD) due to TCAS Preventive Resolution Advisory (PRA) advising crew not to deviate from present vertical profile or,</li> <li>- PD where loss of airborne separation falls within the same parameters of Category C (OE)<sup>2</sup></li> <li>or</li> <li>- Reduction of functional capability of aircraft but does not impact overall safety (e.g., normal procedures as per AFM)</li> </ul>	<ul style="list-style-type: none"> <li>- PD due to response to TCAS Corrective Resolution Advisory (CRA) issued advising crew to take vertical action to avoid developing conflict with traffic or,</li> <li>- PD where loss of airborne separation falls within the same parameters of a Category B OE<sup>2</sup> or,</li> <li>- Reduction in safety margin or functional capability of the aircraft, requiring crew to follow abnormal procedures as per AFM</li> </ul>	<ul style="list-style-type: none"> <li>- Near mid-air collision (NMAC) results due to proximity of less than 500 feet from another aircraft or a report is filed by pilot or flight crew member that a collision hazard existed between two or more aircraft</li> <li>- Reduction in safety margin and functional capability of the aircraft requiring crew to follow emergency procedures as per AFM</li> </ul>	<ul style="list-style-type: none"> <li>- Conditions resulting in a mid-air collision (MAC) or impact with obstacle or terrain resulting in hull loss, multiple fatalities, or fatal injury</li> </ul>

TABLE 3-3. SEVERITY DEFINITIONS FOR FLYING PUBLIC

Effect On: ↓	Hazard Severity Classification				
	Minimal 5	Minor 4	Major 3	Hazardous 2	Catastrophic 1
Flying Public	- Minimal injury or discomfort to passenger(s)	- Physical discomfort to passenger(s) (e.g., extreme braking action; clear air turbulence causing unexpected movement of aircraft causing injuries to one or two passengers out of their seats) - Minor <sup>3</sup> injury to greater than zero to less or equal to 10% of passengers	- Physical distress on passengers (e.g., abrupt evasive action; severe turbulence causing unexpected aircraft movements) - Minor <sup>3</sup> injury to greater than 10% of passengers	Serious <sup>2</sup> injury to passenger(s)	Fatalities, or fatal <sup>1</sup> injury to passenger(s)

1 – As defined in the 2005 Runway Safety Report

2 – As defined in FAA Order 7210.56, *Air Traffic Quality Assurance*, and Notice JO 7210.663, *Operational Error Reporting, Investigation, and Severity Policies*

3 – Minor Injury - Any injury that is neither fatal nor serious.

4 – Serious Injury - Any injury which: (1) requires hospitalization for more than 48 hours, commencing within 7 days from the date the injury was received; (2) results in a fracture of any bone (except simple fractures of fingers, toes, or nose); (3) causes severe hemorrhages, nerve, muscle, or tendon damage; (4) involves any internal organ; or (5) involves second- or third-degree burns, or any burns affecting more than 5 percent of the body surface.

5 – Fatal Injury - Any injury that results in death within 30 days of the accident.

Severity Analysis Result: Given the conditions of the scenario with respect to the severity definitions, this event is potentially “Major” or “Hazardous” considering the existing controls mentioned. Looking at the scenario from an ATC services perspective, the missed approach must be executed because the landing (ref. 13) was rejected. Any missed approach below the Missed Approach Point (MAP) involves additional risk because the Aircraft Flight Manual (AFM) contains performance information for climbing from, at, or before the MAP. Starting the missed approach after the MAP creates concerns about the aircraft and its climb performance with respect to obstacle clearance, as well as avoiding other traffic in the congested airspace, resulting in a category A or B operational error (OE) (ref. 14). Current helicopter instrument procedures limit the missed approach speed to 70 knots indicated airspeed (KIAS) (ref. 13). Exceeding the airspeed restriction increases the turning radius and could cause the aircraft to leave the missed-approach protected airspace. The result could be collision with an obstacle or potential aircraft collision.

### Likelihood Analysis

The likelihood of a hazardous event is the expression of how often a particular event will occur and is determined by how often one can expect the resulting event to occur at the worst credible severity. The likelihood definitions shown in table 3-4 were developed as part of the FAA/ATO SMS Manual (ref. 12).

Besides the definitions shown in table 3-4, there is the requirement of Federal Aviation Regulation (FAR) section 25.1309 (ref. 15) and FAA Advisory Circular (AC) 25.1309-1A (ref. 16) that would be applied to the certification of a commercial CTR. The regulation contains the terms “extremely improbable” and “improbable.” The AC defines extremely improbable as “so improbable they are not anticipated to occur during the entire operational life of all aircraft of that type.” Improbable is defined as “not anticipated to



occur during the entire operational life of a single random aircraft.” They may occur occasionally during the entire operational life of all aircraft of one type. Because the life of any type of aircraft is 20–30 years, the AC definition of improbable can be equated with “remote” or “extremely remote” as defined in table 3-4.

Likelihood Analysis Result: Looking at the existing conditions given in tables 3-2 and 3-3, there are none that would mitigate an ICDS failure. Also, in accordance with current safety thinking, if the failure in question has previously happened, its occurrence in the future cannot be considered extremely improbable (e.g., DC-10 Sioux City accident in July 1989). Therefore, the likelihood should be either “Remote” or “Extremely Remote.”

TABLE 3-4. LIKELIHOOD OF OCCURRENCE

	NAS Systems & ATC Operational	NAS Systems		ATC Operational		Flight Procedures
	Quantitative	Individual Item/System	ATC Service/ NAS Level System	Per Facility	NAS-wide	
<b>Frequent A</b>	Probability of occurrence per operation/operational hour is equal to or greater than $1 \times 10^{-3}$	Expected to occur about once every 3 months for an item	Continuously experienced in the system	Expected to occur more than once per week	Expected to occur more than every 1-2 days	Probability of occurrence per operation/operational hour is equal to or greater than $1 \times 10^{-5}$
<b>Probable B</b>	Probability of occurrence per operation/operational hour is less than $1 \times 10^{-3}$ , but equal to or greater than $1 \times 10^{-5}$	Expected to occur about once per year for an item	Expected to occur frequently in the system	Expected to occur about once every month	Expected to occur about several times per month	
<b>Remote C</b>	Probability of occurrence per operation/operational hour is less than or equal to $1 \times 10^{-5}$ but equal to or greater than $1 \times 10^{-7}$	Expected to occur several times in the life cycle of an item	Expected to occur numerous times in system life cycle	Expected to occur about once every year	Expected to occur about once every few months	Probability of occurrence per operation/operational hour is less than or equal to $1 \times 10^{-5}$ but equal to or greater than $1 \times 10^{-7}$
<b>Extremely Remote D</b>	Probability of occurrence per operation/operational hour is less than or equal to $1 \times 10^{-7}$ but equal to or greater than $1 \times 10^{-9}$	Unlikely to occur, but possible in an item's life cycle	Expected to occur several times in the system life cycle	Expected to occur about once every 10-100 years	Expected to occur about once every 3 years	Probability of occurrence per operation/operational hour is less than or equal to $1 \times 10^{-7}$ but equal to or greater than $1 \times 10^{-9}$
<b>Extremely Improbable E</b>	Probability of occurrence per operation/operational hour is less than $1 \times 10^{-9}$	So unlikely that it can be assumed that it will not occur in an item's life cycle	Unlikely to occur, but possible in system life cycle	Expected to occur less than once every 100 years	Expected to occur less than once every 30 years	Probability of occurrence per operation/operational hour is less than $1 \times 10^{-9}$



### Qualitative Risk Analysis

A risk matrix as shown in figure 3-7 is a graphical method used to determine risk levels. The columns in the matrix represent the severity categories, and the rows represent the likelihood categories. Three risk levels are used in the matrix:

1. High or unacceptable risk. Any risk determined to be high cannot be implemented unless the hazards associated with that risk are mitigated to a medium- or a low-risk level.
2. Medium or tolerable risk that meets the minimum acceptable safety requirements. The hazard may be accepted but with active management of operational tracking and monitoring. Management must buy-in to the decision.
3. Low or acceptable risk allows the design or operation to be used without any restriction or limitations.

NOTE: A catastrophic severity and corresponding improbable likelihood would normally be rated as a medium risk as long as the event is not the result of a single point or common-cause failure. If the hazard is the result of a single point or common-cause failure, the risk is categorized as a high risk and placed in the red part of the split cell at the bottom right corner of figure 3-7 (ref. 12). An example of a common-cause failure is simultaneous loss of all aircraft engine operation resulting in a loss of all electrical power due to fuel contamination, which represents a single common failure (ref. 12).

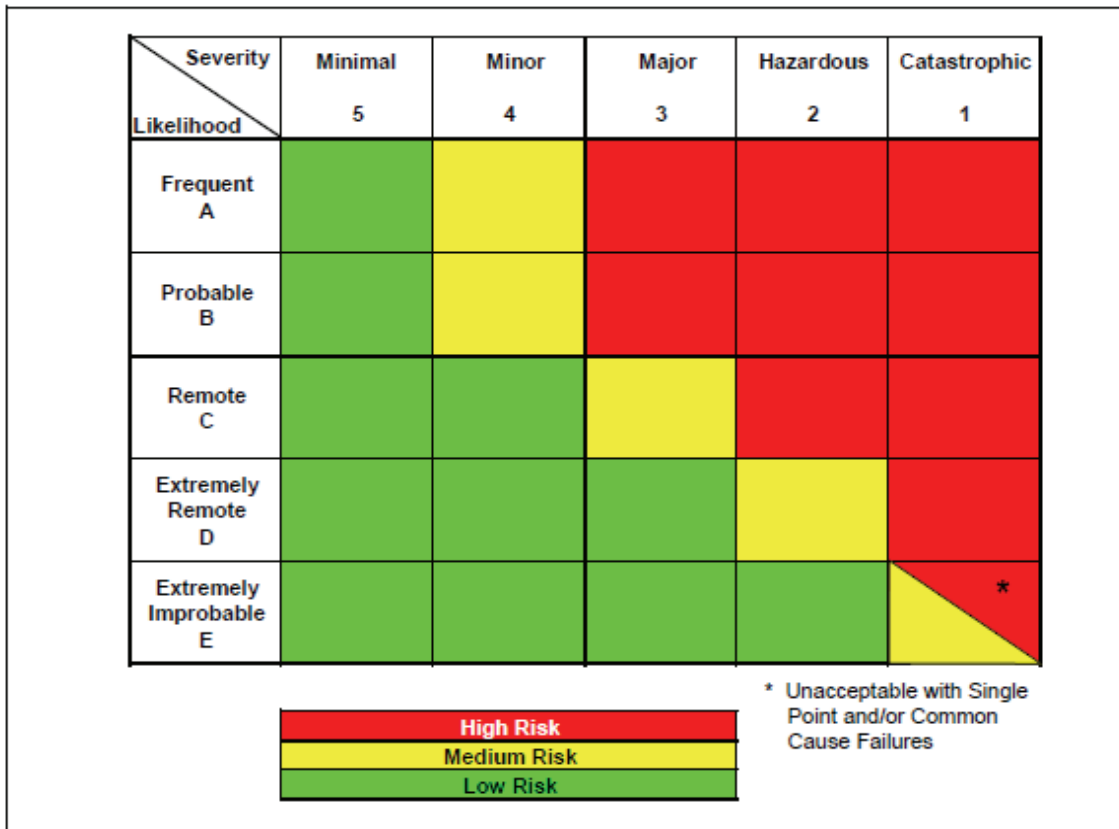

Figure 3-7. Risk matrix.

Qualitative Risk Analysis Result: As previously discussed, qualitative analysis of the severity of an ICDS failure places it as either major or hazardous. Also, analysis of the likelihood of the hazard places it at either remote or extremely remote. Given either of these conditions, the resulting risk is medium (tolerable) and, therefore, may be accepted if there is a management-approved plan for tracking and monitoring.

#### **3.3.1.4 Risk Mitigation**

Risk management is the assessment and mitigation of the risk resulting from a hazard and its resultant consequences that threaten to reduce safety below some target level that has been set by the organization responsible for risk management.

In mitigating risk, alternative strategies are developed for managing the risk associated with a particular hazard. These strategies are turned into potential actions that can be evaluated for their effectiveness at mitigating the unacceptable risk. These strategies fall into three basic categories:

1. Modify/change the system/component design,
2. Change operational procedures, and/or
3. Create contingency plans that include the occurrence of the hazard.

When looking at the design change strategy, there are two approaches to consider. They are changes to prevent or minimize the probability of the hazardous event and/or changes that minimize the consequence of the event. This study looks at both. When the CTR nacelle rotates from the airplane mode for a landing, the oil accumulated in the nacelle (when nacelle is at 0 degrees) could run into the engine and could be ignited by the hot engine components. The resulting corrective action is to provide drain holes in the nacelle, so oil will not accumulate. This mitigates the consequence of the potentially hazardous oil leak (ref. 17).

The interconnect drive system (ICDS) on the current military V-22 and future civilian AW609 functions to synchronize proprotor speed and to transfer power from the proprotor to all accessory equipment. The ICDS is identical on either side of the aircraft and consists of a series of drive shafts, couplings, and bearings that connect the mid-wing gearbox (MWGB) to the proprotor gearbox (PRGB). This is illustrated in figure 3-8 (ref. 18). One of the design challenges is to simplify and increase the robustness of the ICDS. This could be done by decreasing the number of drive shafts, decreasing the number of couplings, or changing the bearing design to make the entire ICDS more fault resistant. Perhaps a fault tolerant design with a redundant load path could be designed to eliminate a single-point-of-failure event.

Another strategy that can be considered to minimize the consequence of an ICDS failure would be to separate the flight control and power control paths using software. Software can link the advanced-technology flight management system (FMS) with the full authority digital engine control (FADEC). In the event of an ICDS failure, the pilot would input the proper flight commands into the aircraft systems through the flight controls to continue the climb-out. The FMS would take those control inputs and determine the necessary power of the individual engines, and link with the engines' FADEC to allow application of proper engine power. A properly designed feedback control system, with the FADEC in the inner loop and the FMS in the outer loop, would serve to minimize any  $N_p$  mismatches.

Another mitigation alternative would be to incorporate adaptive controls, which have been demonstrated in several studies (refs. 18–20) to show acceptable performance for handling degraded performance due to system failures, loss of control surfaces, or unpredictable external disturbances.

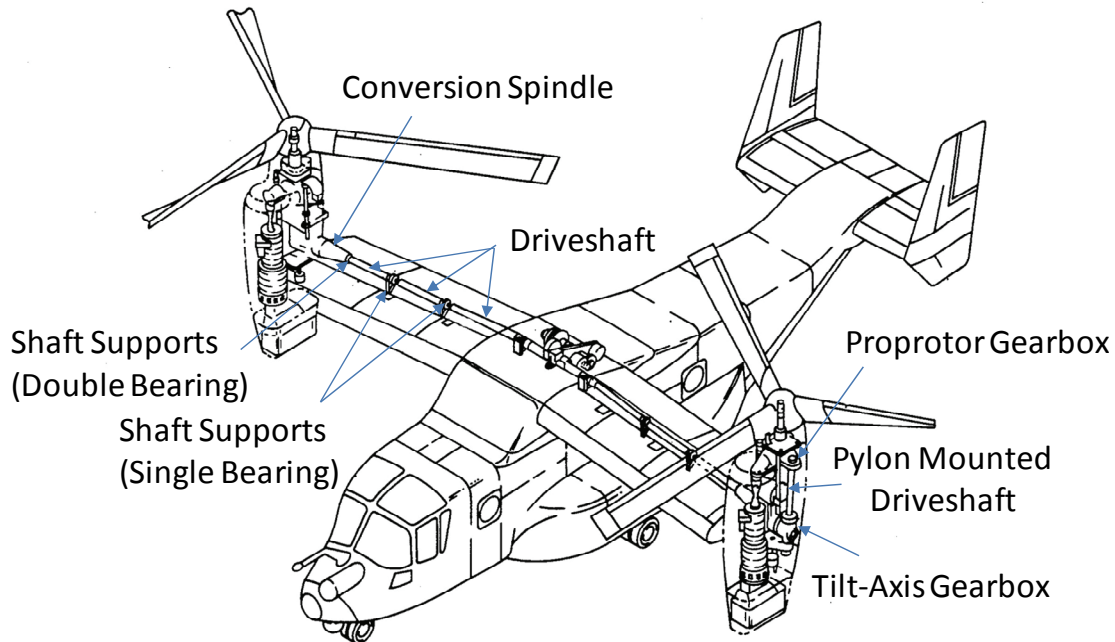

Figure 3-8. A representative tiltrotor drive system illustration.

These mitigations will need to be verified in an integrated pilot-in-the-loop (PITL) and controller-in-the-loop (CITL) simulation to verify that the safety procedures or methods developed under the given CTR ICDS failure can meet the safety requirements at given airspace constraints (e.g., interaction with the fixed-wing traffic, and pilot and controller’s interactions and workload).

### 3.3.2 Scenario 2—Inability of the Nacelles to Rotate (Nacelle Translation Failure)

The same safety analysis approach (i.e., identify the hazards, develop the risk assessment, and mitigate the risks) is followed in this failure scenario as well.

#### 3.3.2.1 Scenario

A CTR is performing a VTOL approach to the vertiport at Newark Liberty Airport (EWR) during peak traffic hours. The weather is Category I, IFR, with rain and wind gusts up to 20 knots from the north. The CTR is on approach passing through 200-foot altitude with nacelle angle at 75 degrees. The pilot has acquired the landing spot and begins to configure the aircraft for a VTOL landing. The number 2 engine experiences a non-contained failure that damages the tilt axis gearbox so that it fails fixed at an 80-degree angle. There appears to be no other aircraft damage. Because both nacelles move together (the pilot does not have the ability to move them independently), both nacelles have failed fixed at 80 degrees.

#### 3.3.2.2 Identify Hazard

The pilot declares an emergency and prepares to perform a missed approach. The potential hazards resulting from the scenario are inability to safely land the aircraft or potential loss of separation and near mid-air collision (NMAC).

With reference to table 3-2, the existing controls to mitigate the risk are pilot training in one-engine-out and missed approach conditions, as well as existing controller standard operating procedures (SOPs) on missed approach procedures; these could help mitigate the consequences of the hazard.

### **3.3.2.3 Risk Assessment**

#### **Severity Analysis**

With reference to the severity definitions given in tables 3-2 and 3-3, the severity would be at least “Major” or probably “Hazardous.” The reasons for this assessment are:

1. The aircraft has one engine out and the rotor nacelle angle is not at an efficient angle for climb-out. The CTR will still be able to climb, but the airspeed will be degraded to a maximum of 90 knots. The achievable speed will be a function of the conversion corridor.
2. The rotor nacelle angle is not optimum for a STOL landing (80 degrees will work for a STOL; V-22 is now cleared for roll-on landing at 75 degrees). With the nacelles fixed, they cannot be used to assist in slowing the CTR after touchdown.
3. The weather is Category I, IFR, with moderate rain and wind gust up to 20 knots.
4. There is high-density fixed-wing traffic operating on the two parallel EWR runways. This traffic will be a mix of NextGen-capable and conventional IFR-equipped airplanes.

Given the preceding conditions, from an ATC perspective there is a strong possibility of loss of separation, or potential NMAC, which puts the scenario in either the “Major” or “Hazardous” category. From a flight crew perspective, there is a reduction in safety margin and aircraft functional capability requiring the crew to follow AFM emergency procedures, which itself is classified as having a Major severity.

Severity Analysis Result: Given the above, the severity should be classified as “Hazardous.”

#### **Likelihood Analysis**

Event Likelihood: With reference to table 3-4, the probability of a non-contained engine failure is remote. Non-contained engine failures historically have occurred at a rate of  $4.4 \times 10^{-7}$  events/engine hour (ref. 21). Therefore, the probability of a non-contained engine failure damaging the tilt axis gearbox can be assumed to be extremely remote (ref. 12) (i.e., less than  $1 \times 10^{-7}$  but equal to or greater than  $1 \times 10^{-9}$ ).

#### **Qualitative Risk Analysis**

With reference to figure 3-7, given a Hazardous severity and an occurrence probability of Extremely Remote, the resulting risk would be medium (yellow) or tolerable. If the severity was considered Catastrophic (potential mid-air or landing accident), the risk would be high (red) or intolerable.

### **3.3.2.4 Risk Mitigation**

Shielding material can be used to protect the tilt axis gearbox from un-contained engine debris. To adequately determine the placement of this shielding, research may be required to determine whether the high-energy debris dispersal angle is affected by engine angular position. To date, debris data comes from fixed-wing aircraft where the engine centerline is parallel to the aircraft centerline. Note as an aside that the conceptual designs of 90- and 120-passenger CTR vehicles developed in ref. 1 have two-engines per nacelle/rotor; similar design approaches as this will help further mitigate other consequences of one-engine-inoperative safety scenarios.

### **3.3.3 Scenario 3—Failure of the ICDS During a VTOL Landing**

The same safety analysis approach from the previous two scenarios is followed.

#### **3.3.3.1 Scenario**

A CTR is performing a VTOL approach to the vertiport at Newark Airport (EWR) during peak traffic hours. The weather is Category I, IFR, with rain and wind gusts up to 20 knots from the north. Fixed-wing IFR operations are occurring on the main parallel runways. The CTR is on approach between the final approach fix and the missed approach point, approximately at 700-foot altitude, with nacelle angle at 75 degrees and 90-knots airspeed. An ICDS failure indication occurs, and the pilot declares an emergency and requests a missed approach (if the failure occurs at a lower altitude and the pilot has acquired the landing spot it would not be unreasonable for the crew to continue the VTOL landing as the safer alternative). After reaching the missed approach waypoint, the pilot would request a STOL roll-on landing at the runway with the minimum crosswind.

#### **3.3.3.2 Identify Hazards**

The pilot declares an emergency and prepares to perform a missed approach. The potential hazards resulting from the scenario are inability to safely land the aircraft and potential loss of separation/NMAC.

#### **3.3.3.3 Risk Assessment**

##### **Severity Analysis**

With reference to the severity definitions given in tables 3-2 and 3-3, one of the event possibilities is a pilot deviation due to loss of airborne separation. From both an ATC and a flight crew perspective, this would be classified as a Major severity if it resulted in a category B operational error. There could be a reduction in safety margin and functional capability of the aircraft requiring the crew to follow the emergency procedures in the AFM. This would be classified as a potentially Hazardous severity with respect to the flight crew and ATC if it resulted in a category A operational error. There is also potential concern with obstacle protection for the missed approach. Because the missed approach path is predicated on the missed approach being initiated at the decision altitude/decision height (DA/DH), or no lower than the MAP, failure to follow that path could result in obstacle clearance or loss of separation issues. For the CTR, a series of curves needs to be created that takes into account the point at which the missed approach is initiated and the various climb performance characteristics of the CTR that are dependent on aircraft weight, engine performance, nacelle angle, etc.

##### **Likelihood Analysis**

With reference to the likelihood definitions given in table 3-4, the probability of an ICDS failure occurring during a VTOL landing will be the same as the likelihood of an ICDS failure occurring as described in Scenario 1. An ICDS failure during a VTOL takeoff will be either remote or extremely remote.

##### **Qualitative Risk Analysis**

As in Scenario 1, given a severity of either Major or Hazardous with a corresponding likelihood probability of remote or extremely remote, the resultant qualitative risk would be medium (tolerable) as shown in the risk matrix, figure 3-7.

#### **3.3.3.4 Risk Mitigation**

A medium (tolerable) risk may be accepted if there is a management-approved plan for monitoring and tracking. In both Scenarios 1 and 3, the critical NAS operational risk occurs during TOGA and missed approach, respectively. This is reflected by the capability of the CTR to safely climb, clearing obstacles and

clearing other traffic, and then perform a safe STOL approach and landing. As with Scenario 1, there are the same two approaches to consider—either trying to minimize the hazardous event (likelihood) and/or make changes to minimize the consequences of the event (severity). This is discussed in section 3.3.1.4. Two criteria are evident when looking at the current operational procedures for TOGA and missed approach. The first is for fixed-wing aircraft, and the other is for helicopters (ref. 13). These procedures need to be revised to account for the performance characteristics of CTR aircraft.

### **3.4 Other Safety Considerations**

As previously stated, this study was not intended to be an exhaustive analysis of potential CTR NAS operational safety concerns but rather an analysis of generic failure scenarios that are otherwise unique to the CTR. Historically the majority of onboard fatalities, 79 percent, occur during takeoff and climb, or the descent, approach, and landing phases of flight (ref. 14). The remaining 21 percent occur during the cruise or en route phase. For these reasons the three failure scenarios discussed in section 3.3 were chosen.

There are failure scenarios such as smoke/fire in the cabin, a major structural failure, or fuel contamination with loss of all engines, etc., where an immediate landing could be necessary. Classical fixed-wing aircraft are limited to conventional runways and, therefore, limited in potential emergency landing sites. Evaluating how certain unique CTR operating characteristics, such as the ability to autorotate (ref. 29) and perform vertical landings, could become an existing safety control as described in section 3.3.1.4, would be an interesting study. The ability to autorotate or perform an emergency VTOL operation at non-aviation locations such as parking lots, parks, green belts, etc., or an existing helicopter landing pad (i.e., EMS helipad), could make a significant difference in mitigating safety risk.

Autorotation to a designated emergency landing spot would be accomplished by fully integrating the precise positioning of Global Positioning System/Wide Area Augmentation System (GPS/WAAS) avionics with a terrain database that would include possible emergency landing sites for that particular CTR along its filed flight path. When an emergency occurs, the pilot would have that information available to decide what action to take.

CTR operations near the gate area are another topic of safety concern. Estimates of taxi-out and taxi-in performance of the CTR to and from the vertiport were made in reference 1. However, the wake generated by the proprotor could have a significant impact on how the ground crew interfaces with the CTR arriving or leaving the gate area. Figure 3-9 (courtesy of Sukra Helitek, ref. 30) shows a notional gate area layout and potential wake due to the proprotor downwash effects. Moving rotor blades and wake at the start-up and shut-down of the engine could pose serious safety issues for the ground crew and other ground logistic support activities. These safety issues will need to be addressed in future studies.

### **3.5 Summary**

The first civil tiltrotor, the AW609, has yet to be certified, although there is a great deal of service experience with the military V-22 tiltrotor. While the design requirements and concept of operations (ConOps) are not identical, they do have similarities—i.e., STOL and VTOL operations, ICDS, etc.—that can be used to evaluate potential hazards and mitigations. Several examples are briefly discussed in this section. An analysis of V-22 data from a technical and operational perspective to support CTR certification regulation and policy development would be useful to the FAA, if feasible.

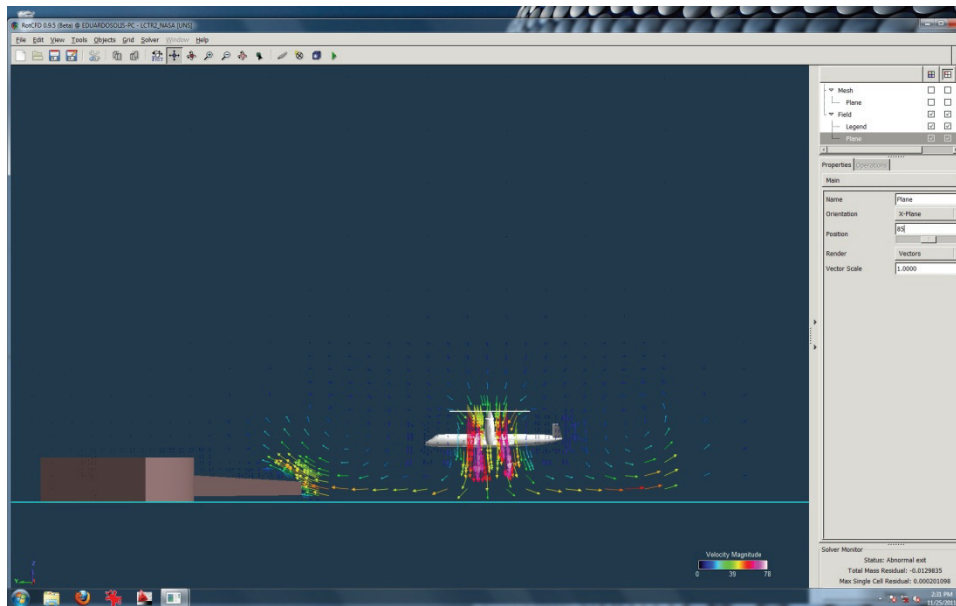
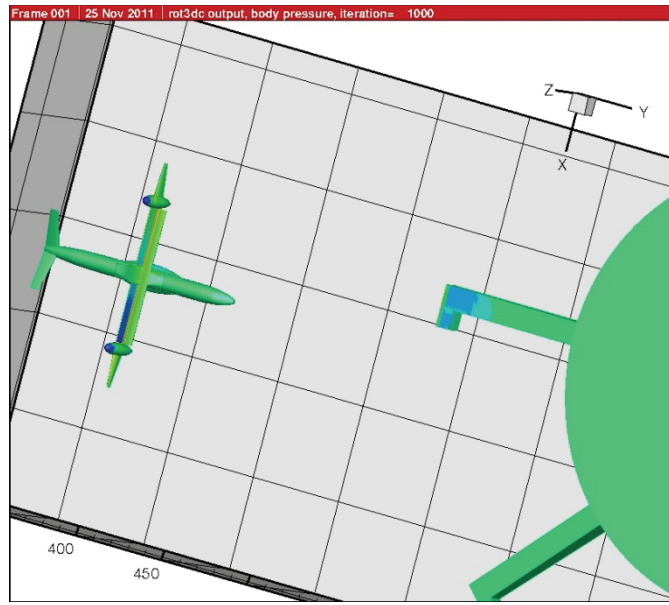

Figure 3-9. A notional CTR gate area layout and potential wake effects (courtesy of Sukra Helitek, ref. 30).

During the scenario design phase of this work, it became clear that one scenario element should be looked at further. Historically, airspace design has been predicated on the classical performance of fixed-wing aircraft. For example, helicopter instrument operations at major airports are modeled on fixed-wing aircraft operations. Figure 3-10 illustrates a helicopter Instrument Landing System (ILS) procedure with applicable minimums as prescribed in FAR section 97.35 for EWR runway 4L.

The NextGen ConOps states, “The overall philosophy driving delivery of ATM services is to achieve a flexible system that accommodates flight operation performance optimization when and where possible while minimizing imposed restrictions...” (ref. 22). The NASA-funded New Aircraft Concepts and Vehicle

studies (refs. 8 and 11) performed by Sensis and Raytheon identified the projected impact on the NAS of vehicles such as *Unmanned Aircraft System (UAS)*, *Cruise-Efficient Short Takeoff and Landing (CESTOL)*, Large Commercial Civil Tiltrotor (LCTR), etc., that would be entering the NAS, within the next 25 years, given their anticipated unique operational and performance characteristics. An interesting study would be to look at potential changes to airspace design practices to see if such changes may improve ATM flexibility to optimize these new classes of aircraft entering the NAS. Potential candidates for review include, but are not limited to:

1. ATC automation changes that identify those aircraft operating in the airspace that have unique operating characteristics;
2. Initiation of controller familiarization training on these characteristics; and
3. Utilizing these unique operating characteristics in the design of approach and landing procedures for both nominal and off-nominal conditions.

Integrated PITL and CITL simulations will be needed to verify some of the proposed safety mitigations using new procedures and advanced flight control applications. These simulations will need to investigate the safety effects of the airspace due to degraded CTR performance, interactions of the pilot and controller in handling CTR failure conditions, and interactions with the fixed-wing traffic.

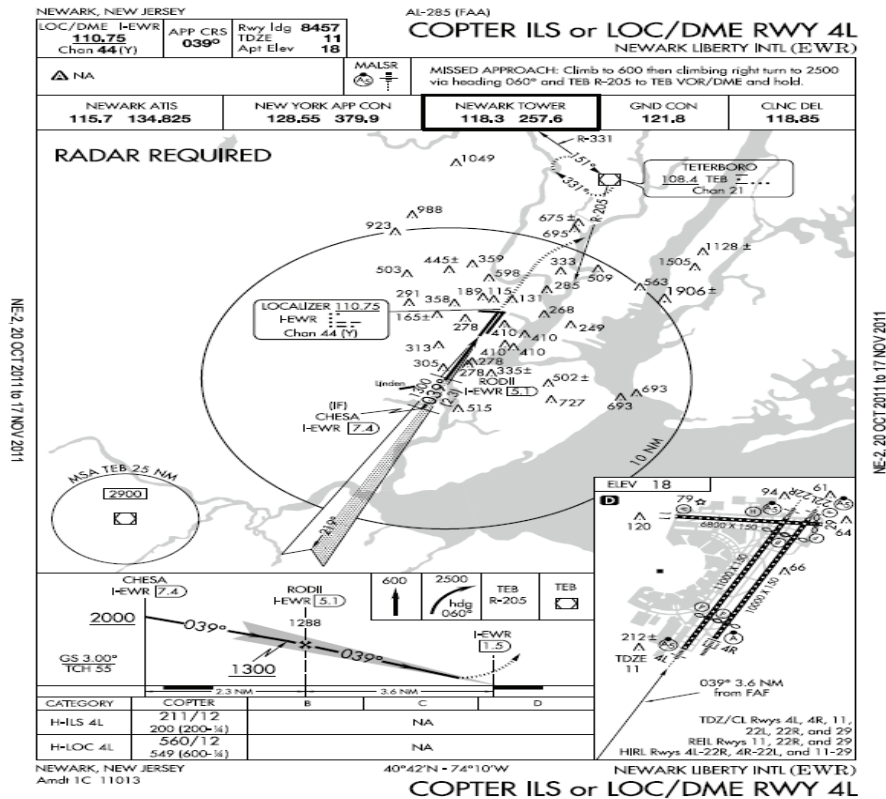

Figure 3-10. EWR Copter ILS Runway 4L.



## 4 PROPOSED CASE STUDIES FOR FURTHER RESEARCH OF NIO AND RIO













To better characterize the range of possible CTR operations and required NAS performance analysis capabilities, it is helpful to break down the domain according to origin type, destination type, and vehicle size such that a systems analysis can be developed. Some areas of the domain represent more promising or interesting CTR options than others. The matrix in table 4-1 characterizes the domain in this way and correlates it to the recommended case studies that follow. This matrix does not represent every possible CTR operation, but does cover the most significant general permutations.

Where “vertiport” is indicated, it is assumed that VTOL will be the normal mode of CTR operation. Note, however, that city center vertiports and remote locations could include amphibious operations, which are a special case of STOL or VTOL operations. In the case of feeder airports, the mode of operation is left unspecified as it may typically be a better use of resources to conduct STOL operations, but VTOL is also an option.

The matrix does not characterize operations by range, however range is an important consideration. CTR operations are expected to be most effective between 30 statute miles (the point at which they can outperform local ground modes of transportation in urban areas) and 500 statute miles (beyond this range, they are generally outperformed by faster aircraft).

Given this CTR analysis focused on the beneficial effects of CTR operations in reducing congestion, a consistent theme of the proposed case studies is a focus on CTR operations at congested hubs. Therefore, most of the case studies in this section involve a congested hub. (Those cases that do not are part of a multi-stop local route involving a hub and more than one other point of service, i.e., our treatment of population centers and remote locations.) As indicated in the matrix, there are other potential CTR operations that do not involve congested hubs. These may warrant further research, but they are outside the scope of the analysis in this effort.

TABLE 4-1. CTR OPERATIONS MATRIX

	Hub Airport Vertiport	Feeder Airport	Population Center Vertiport	Remote Location
Hub Airport Vertiport	 (120): Case 1  (30): Case 5	 (90): Case 2  (30): Case 2	 (30): Case 3a/b  (10): Case 3a/b	 (30): Case 4  (10): Case 4
Feeder Airport		<i>[no position]</i>	<i>[no position]</i>	<i>[no position]</i>
Population Center Vertiport			 (30): Case 3b  (10): Case 3b	 (30): Case 4  (10): Case 4
Remote Location				<i>[no position]</i>

Note that most of the origin-destination pairs suggest passenger transport, though expedited cargo operations are also a possibility for some. Disaster response is omitted, because many origin-destination-size combinations are possible, as dictated by the particular circumstances.

## **4.1 Case 1—CTR Connecting Congested Hubs (Far-Term)**

Congested hubs are the most concentrated and costly sources of NAS delay. Using CTRs for hub-to-hub connections rather than conventional aircraft reduces competition for limited available slots in the standard hub traffic patterns. This frees up resources for operations (such as large-capacity, long-haul operations) that are less well-suited to CTRs. Given sufficient development time, infrastructure can be built into hub airports to maximize the benefit of complementary CTR operations to offload regular hub-to-hub traffic.

### **4.1.1 Description**

This case study details CTR service direct between Boston (BOS) and Newark (EWR). Both of these hubs are congested, associated with extremely busy northeast corridor airspace, and have limited expansion options.

The round-trip business case should be explored in future development of this case study. Many details need to be investigated and filled in, including vertiport infrastructure development, CTR routes, terminal procedures, traffic demands, and operational economics.

The approximate timeframe is the year 2030, selected to provide adequate time for technology maturation and infrastructure deployment so that a “steady-state” snapshot of future CTR operations can be established. This time frame also presents the opportunity to make reasonable assumptions about CTR technology improvements.

CTR infrastructure has been built into BOS and EWR to optimize the following aspects:

- Vertiport locations, which may include conservative adjustments to airfield real estate utilization (note land reclamation as an option for vertiport construction)
- Short CTR runways developed if/where possible for STOL operations; otherwise, VTOL facilities developed (RIO)
- CTR approaches and departures that do not interfere with conventional operations, where such CTR procedures may include conservative adjustments to existing routes and patterns (NIO)
- Convenient passenger access between conventional concourses and vertiports

The number of vertiports should be guided by traffic estimates and assumed vertiport operational capacity. Though this case study only examines BOS to/from EWR, it can be assumed that the vertiports service other routes as well, so a reasonable approach might be to factor in enough vertiports to conduct three to five times the expected number of BOS–EWR city-pair operations projected to be conducted in 2030.

Connections between hubs regularly convey a large number of passengers. Current BOS–EWR operations suggest that the market is sized for 100-seat regional jet service, and conventional wisdom suggests that aircraft in roles like these will be trending larger in the future. Therefore, the recommended CTR size for this study is the 120-passenger model described in reference 1.

#### **4.1.2 Alternative Cases**

- BOS–IAD, DCA, or BWI
- ATL–IAD
- ATL–MIA
- DEN–DFW

#### **4.1.3 Key Issues for Further Research—Case 1**

1. Explore long-term vertiport facility development issues (RIO) at hub airports.
2. Explore long-term CTR routing options near congested hubs and airspace (NIO).
3. Assess benefits, costs, and viability of CTR utilization in this scenario for operators and the FAA.

### **4.2 Case 2—CTR Connecting Feeder and Hub (Near-Term)**

Flights from “feeder” airports (non-hubs, smaller, many more of them) to hubs generally feature a different type of operation than large-capacity, long-haul operations. Usually the routes are shorter and the aircraft smaller. The value per seat is sometimes very high, because these operations establish the final link to the most-preferred origin or destination of many travelers. Nonetheless, in current operations they usually must use the same runways, taxiways, approach routes, and departure routes as all the other operations.

Given their size, route length, and operational benefit characteristics, this segment of air transportation is operationally well-suited to CTRs, which can then significantly reduce the demand for standard approach, departure, and surface movement procedures at the hub-end of the operation. Non-interfering CTRs can also eliminate congestion as a limiting factor, opening the possibility of extending the hub’s services to additional communities (new feeder airports).

#### **4.2.1 Description**

The feeder airport in this case study is Montgomery Regional Airport (MGM), Alabama, connecting to the congested hub at Atlanta International Airport (ATL). Montgomery is somewhat typical for small airports with commercial passenger service, currently offering about 15 flights a day on regional jets. Atlanta is one of the largest, busiest, and most congested hubs in the NAS. Atlanta also has a relatively generous and systematically designed plot of real estate, providing many options for vertiport locations.

The case study timeframe is approximately the year 2018, which is about the soonest one could postulate the operation of civil tiltrotors for normal passenger traffic. Vertiports and other facilities may have to be somewhat “ad hoc” to match the timeframe. The case study is intended to represent one of the earliest deployments of CTRs for passengers in the NAS.

Other characteristics of the case study include:

- In line with earliest possible deployment, vertiports (STOL and/or VTOL) are established in airport areas that can be most easily acquired for the purpose in the near term, while also weighing other factors (noninterference, passenger access).
- Current traffic routes and patterns are not changed.

- Terminal facilities and passenger access are patched together as necessary (for example, surface shuttles deployed if necessary).

Operations at ATL are expected to be predominantly VTOL to minimize interference with conventional aircraft (RIO). At MGM, STOL can be used on standard runways, consequently requiring no special vertiports. Note that CTRs may require special tugs for surface movement.

The number of vertiports at ATL could follow the guideline postulation that CTR feeder-to-hub connections are initially deployed to three feeder airports (one of which is MGM). Vertiport facility needs are, therefore, probably quite modest in this case study.

Either the 30-passenger CTR, 90-passenger CTR, or both are recommended for inclusion into this case study. The 90-passenger CTR is more similar in capacity to the current regional jets that are used for these operations. However, the 30-passenger CTR may be more feasible from a development cost and timeline standpoint for initial CTR deployment.

The case study covers the round trip, as well as maintenance details, etc., to assess business model sustainability.

#### **4.2.2 Alternative Cases**

- Charleston to Atlanta
- Atlantic City to EWR, LGA, or BWI?

#### **4.2.3 Key Issues for Further Research—Case 2**

1. Explore issues associated with earliest, near-term deployment of CTRs in the NAS.
2. Test RIO and NIO concepts without the option of making changes to current routes and airfield facilities.
3. Assess benefits, costs, and viability of CTR utilization in this scenario to both operators and the FAA.

### **4.3 Case 3—CTR Transportation Services to Population Centers**

#### **4.3.1 Sub-Case 3a—Local Metroplex Interconnect**

Considering their operational flexibility and lift capability, CTRs present the possibility of filling the gap between conventional fixed-wing aircraft and rotorcraft, specifically as applied to local passenger transport. For example, in several areas in the NAS there are major airports located in close proximity to each other. However, they are not effectively connected to each other by a high-speed mode of transport. Often these metropolitan areas also feature other local points of high population density and high value as a transportation end point, e.g., downtown, harbor, and suburban housing areas.

#### 4.3.1.1 Description

This case study describes a scenario in the CTR deployment “midterm” (say, 2025). A local CTR transportation service is established connecting the following nodes in the greater San Francisco area:

- San Francisco airport (SFO)
- Oakland airport (OAK)
- San Jose airport (SJC)
- Santa Cruz
- Stockton
- Sacramento
- Santa Rosa

Note the recurrence of a key theme—the operation of CTRs in non-interfering ways (helping to reduce congestion) at busy airports (especially SFO, in this case). Also, by connecting several airports, this service would help to spread demand and enable more efficient travel. Servicing outlying communities creates a new option relative to other modes of transportation (roads, rails, etc.). These outlying service nodes were chosen to be somewhat inconvenient (lengthy transport) for other options such as car or train, but relatively convenient for CTRs (i.e., the distances are quickly traversed at normal CTR speeds with fairly direct routes, and the transport distance accomplished is worth the costs of loading, unloading, operating, etc.).

One of the details that must be worked out in the study is the best way to order and organize service to these nodes, given different levels of demand and tolerance for transit time. For example, a given CTR could make a full loop of the three airports (servicing any connecting passengers) and then do an outer loop of the non-airport destinations (serving endpoint travelers more tolerant of time in transit, as long as the time in transit is predictable).

In order to minimize interference with conventional operations at the major airports (and minimize the possibility of delay) and get as close as possible to convenient non-airport locations, VTOL is expected to be the predominant mode of operation. Fuel requirements should be minimal. Note that this case study features some service points that are not necessarily conventional airports. Options for special-purpose vertiports and amphibious operations should be explored.

Given the “shuttle-like” nature of the service described, service should be frequent (e.g., no longer than 15 to 20 minutes between departures at the major airport nodes). Demand should be considered in the study, but the frequent service may call for the application of the smaller size classes of CTRs (10- or 30-passenger). One of the important investigations of this case study will be streamlined, predictable operations and facilities to get passengers onto and off the CTRs as quickly as possible.

The case study should also address alternate modes of accomplishing similar services (for example, conventional rotorcraft or local rail).

Business sustainability should be assessed. This application of CTRs could be a scalable “early adopter” being essentially an air taxi service (not replacing conventional flights). The trips are added value, of short duration, and optional to the traveler.

#### **4.3.1.2 Alternative Cases**

- EWR/LGA/JFK/NY Harbor
- IAD/DCA/BWI/Northern D.C.
- Miami/Ft. Lauderdale/Beaches

#### **4.3.1.3 Key Issues for Further Research—Sub-Case 3a**

1. Investigate the viability of a new type of service enabled by CTR capabilities (local, high-speed, non-interfering transport, especially connecting multiple, high-volume airports).
2. Explore the establishment of vertiports in areas not serviced by airports.
3. Explore feasibility of fast-tempo CTR operations (rapid and predictable movement of passengers to and from flight operations, boarding, disembarking, etc.).
4. Assess benefits, safety, costs, and viability of CTR utilization in this scenario to both operators and the FAA.

#### **4.3.2 Sub-Case 3b—Population Center to Population Center Direct**

This case study considers CTR operations that do not use conventional airports at all, and rather connect two locations sharing one or both of the following characteristics:

- Dense population
- Consistent need for high-value, convenient transportation

The CTR “city center to city center” concept that has been previously detailed (ref. 2) fits this model. However, other cases also fit, such as regular transportation between dense, residential suburb areas and urban business areas (e.g., “regional commuters” who usually face hours of driving one to five days per week).

The capability to conduct VTOL operations while transporting significant passenger loads and the ability to fly medium-range conventional aircraft routes make CTRs uniquely qualified to fill this transportation need.

##### **4.3.2.1 Description**

The route examined in this case study is Manhattan (downtown New York City) to Capitol DC (downtown Washington, D.C.). At the Manhattan end, potential sites include the Downtown Manhattan/Wall Street heliport (KJRA). At the Capitol end, possible sites include the South Capitol Street Heliport (09W) and the Washington Convention Center (with appropriate facility development).

Timeframe is around 2025, with relatively frequent (hourly) service. Demand analysis may suggest medium-sized CTRs (30 to 90 passengers).

These operations do not directly involve hub operations, but they do contribute to reduced congestion by offloading traffic that would otherwise be using conventional air routes.

#### **4.3.2.2 Alternative Cases**

- Downtown Boston to Downtown New York
- San Bernardino to Downtown Los Angeles
- Galveston to Downtown Houston

#### **4.3.2.3 Key Issues for Further Research—Sub-Case 3b**

1. Investigate the viability of a new type of service enabled by CTR capabilities (connecting population centers entirely apart from conventional airport network).
2. Explore the establishment of vertiports in high-population areas.
3. Assess benefits, safety, costs, and viability of CTR use in this scenario to both operators and the FAA.

### **4.4 Case 4—CTR Transportation Services to Remote Locations**

CTRs can extend service to locations that are not conducive to airport development, either due to geographic or traffic volume factors. Examples could include mountainous areas, small islands, remote areas, etc. Some such areas are currently served to some extent by conventional rotorcraft, but could be better served by CTRs.

#### **4.4.1 Description**

CTRs in this case connect Denver, a major, congested hub, to destinations within about 100 miles that are underserved by airport options. The route may include two or more of the following:

- Denver International Airport (DEN)
- Winter Park Resort
- Rocky Mountain National Park
- Steamboat Springs Resort (note: somewhat served by Yampa Valley Airport (HDN))
- Vail/Beaver Creek Resorts
- Breckenridge Resort
- Crested Butte Resort (note: somewhat served by Gunnison-Crested Butte Regional Airport (GUC))
- Note: could add Colorado Springs Airport (COS) to expand connections to the resort areas and better connect the Denver and Colorado Springs communities, as well as air travel options.

Notes:

- Aspen/Snowmass is served by a small local airport located close to the resort areas; adding service there could enhance the business case but does not illustrate the concept of CTR operations to remote areas without existing airports.
- Denver area altitudes could impact CTR performance.

Given the specialized nature of the passenger traffic in this case (last-mile transport for vacationers) and the desirability of multiple operations per day (regular shuttle service), the smaller classes of CTRs (i.e., 10 and/or 30 passenger) may be more appropriate.

This case study is well-suited to exploring the potentially positive appeal of CTR transportation to a unique subset of passengers. Resort area vacationers are probably willing to pay significantly more per mile (saving transit time during vacation) than travelers in more routine contexts and may also be attracted to CTR service as a novel experience with sightseeing appeal. (In this respect, CTRs may be similar to gondolas, sailboat cruises, and helicopter rides.)

An interesting aspect of this case study, which is not unique but is prominent, is that the introduction and operation of CTRs could be significantly subsidized by local interests (in this case, resorts and other beneficiaries of recreational visitors).

#### **4.4.2 Alternative Cases**

- Honolulu International Airport (HNL), Oahu North Shore, Maui, Kauai
- Alaska coast
- Long-range medical evacuation services to large, sparsely populated areas (note: this could be included as a secondary capability in conjunction with regular CTR transportation services).

#### **4.4.3 Key Issues for Further Research—Case 4**

1. Explore the regular operation of CTRs in remote locations. This includes the establishment of new vertiports in relatively isolated locations, context-specific operational details, maintenance, and safety considerations.
2. Evaluate the business case for CTR services to remote and currently underserved locations.
3. Evaluate the desirability, from a human factors perspective, of CTR operations in remote areas (i.e., sightseeing and the novelty factor).
4. Explore some of the factors involved in CTR operations subsidized by income beyond direct ticket sales (i.e., ongoing investment by other interested parties).

### **4.5 Case 5—CTR Flexible Expedited Cargo Services**

Cargo operations occur largely independently of passenger operations, often during off-hours (especially at night) to avoid congestion. If some high-value expedited cargo operations could be run during daytime/peak hours, independent of normal airport and airspace congestion, this could provide potential benefits. CTRs could provide this capability.

#### **4.5.1 Description**

The following two major metropolitan areas and a major cargo hub location are suggested for evaluation of daytime expedited cargo transport:

- New York (John F. Kennedy International Airport (JFK), 6th busiest cargo airport in the U.S. according to Airports Council International (ACI) 2009 statistics)
- Washington (Washington Dulles International Airport (IAD))
- Louisville (Louisville International Airport (SDF), cargo hub and 3rd busiest cargo airport in the U.S. according to ACI 2009 statistics)



Cargo operations have the advantage of being conducive to operation from airport facilities that are physically separate from passenger traffic. Therefore, establishing vertiport facilities that do not interfere with (and operate independently of) passenger facilities and minimally compete for airport real estate should be easier. Establishing vertiports on new real estate off the existing airports, or conducting amphibious cargo CTR operations from nearby waterways (especially in the case of New York) is an extreme example.

An important part of the business proposition in this case study is the flexibility offered to cargo operators. A few CTRs could be maintained and operated as needed, depending on the level of high-value/high-speed cargo transport that is needed. CTRs could conceivably reach virtually any airport in the NAS (leveraging their STOL capabilities) and operate independently of passenger traffic congestion at any airport with a vertiport.

Cargo operators and expedited cargo operations may be a potential “early adopter” for low-risk, subsidized deployment of CTRs. Cargo operations are more tolerant of comfort and noise issues, which may need to be worked out in future generations of CTR aircraft. There may also be regulatory advantages to deploying CTR capabilities in the cargo-transport role for their early commercial aviation introduction.

The optimal CTR size depends entirely on the projected cargo load and schedule requirements determined by case study analysis, but from a qualitative perspective the 30-passenger size might offer a good balance between capacity and flexibility. In addition, the 30-passenger CTR is expected to be based on the V-22 Osprey, which may provide the basis for a more near-term case study that presents cargo operations as an early adopter of CTR technology.

#### **4.5.2 Alternative Cases**

- Miami (Miami International Airport (MIA), 4th busiest) to Memphis (Memphis International Airport (MEM), 1st busiest)
- Newark (Newark Liberty International Airport (EWR), 10th busiest) or Chicago (O’Hare International Airport (ORD), 8th busiest) to Indianapolis (Indianapolis International Airport (IND), cargo hub/9th busiest)

#### **4.5.3 Key Issues for Further Research—Case 5**

1. Evaluate expedited cargo operators as users of CTR technology in general, especially to avoid congestion limitations during daytime operations and as a CTR early adopter in particular.
2. Explore deployment advantages of CTRs for cargo relative to CTRs for passengers, including safety and regulations, independent facilities, and human factors.
3. Evaluate business case to operators (new capabilities, cost of equipment, facilities, operations, etc.) and FAA (cost of procedures, congestion reduction, etc.).

## **4.6 Case 6—Further Studies in CTR Disaster Relief**

This section covers the potential added benefits of CTRs deployed for non-disaster purposes (see other case studies) which can be called on for disaster relief, as well as the possibility of a minimal CTR fleet maintained specifically for disaster relief. The scenario may include commercial CTRs, amphibious CTRs, military CTRs, Coast Guard CTRs, etc.

### **4.6.1 Description**

Disaster operations are described in references 23 and 28 as operations from origination, intermediary, and destination sites as follows:

- Remote base
- Remote site
- Local base
- Local site
- Event site

Missions assigned for post-disaster operations are defined as follows:

- Evacuation (ambulatory)
- Medical evacuation (nonambulatory)
- Search and rescue
- Cargo transport

One common component of the analysis in references 23 and 28 is to deploy rotorcraft assets to the disaster area from remote bases. Asset deployment to the mission occurs once air traffic is allowed within the disaster area and post-disaster operations begin.

### **4.6.2 Alternative Cases**

There are clearly potential added benefits for civil CTRs to be mobilized and deployed for post-disaster support purposes, in addition to CTR aircraft maintained by public safety organizations specifically for disaster relief (these may include National Guard and Coast Guard CTRs). In addition, vertiports for civil CTR operations may be used to support CTR operations in the disaster area.

### **4.6.3 Key Issues for Further Research—Case 6**

A consideration is the approach to be taken to stage civil CTRs at remote sites outside the disaster area. For major weather events, this may require pre-disaster staging. For natural disasters such as earthquake and tsunami disasters, civil CTR support may need to be mobilized from non-affected areas.

## 4.7 Summary

The preceding case studies represent various commercial transport missions that future CTRs are likely to be able to perform, with performance and cost benefit according to passenger size and service range. The main technology requirements involve the ability to certify CTRs to operate in complex airspace on short- and medium-range routes (up to 500 statute miles per flight segment). Future CTR studies need to include accurate fuel burn models, noise models, and emission models that support evolved NAS and environmental analysis tools. Definition of these NAS performance analysis and environmental tools is, for the most part, not possible today. The main issues are that NAS performance analysis tools need to be developed around future NAS ConOps, and that CTR environmental performance has not yet been accurately modeled. A focus on accurate performance modeling that supports PCTL simulation is essential as a foundation for future research efforts.

## 5 ASSESSMENT OF KEY CTR NAS PERFORMANCE ANALYSIS TOOLS

NAS performance analysis requirements can be characterized in two main ways: NAS operations ConOps, and selection and application of more narrowly defined airspace and procedures operational performance analysis tools. Future studies need to be based on CTR NAS performance analysis tools that accommodate CTR-specific trajectory, flight time, fuel burn, and environmental impacts in en route and terminal area operations. These tools need to incorporate various options for CTR nacelle transition characteristics in the terminal area, accommodating the unique operating and design characteristics of the CTR to analyze both nominal and off-nominal conditions.

This section addresses CTR operations in the NAS in a broad sense and the need for analytical tools to study future detailed airspace design and procedures at individual locations. To perform such future studies requires extensive work in the design and simulation of airspace, procedures, weather impacts, and ConOps for both conventional fixed-wing and CTR operations at specifically identified airports.

### 5.1 Issues and Tools

The main technology-driven operational requirements are the ability of CTRs to operate in complex airspace on short- and medium-range routes (up to 500 statute miles per flight segment). A previous CTR study identified aircraft weight, engine efficiency, and life-cycle cost as key issues for CTR technology development (ref. 1). That CTR study reviewed the NextGen ConOps (ref. 24) and provided an understanding of CTR operations in NextGen. However, significant unknowns remain with respect to how the air traffic management system will evolve, including future implementation of CTR 4D TBO and flow corridors. Research in these areas is currently not mature, especially in terms of procedures, avionics, and data communications to support 4DT, collaborative trajectory negotiation, flow corridors, direct-to routings, airborne self separation, and en route merging and spacing operations.

The approach taken in this study is to identify key issues and technology that will likely need to be addressed in future CTR analyses. Building on the NIO and RIO ConOps, safety analysis, and case studies, additional NAS performance analysis tools will be required to support development and evaluation of future CTR ConOps and procedures, as well as environmental impact. The main limitations of existing tools are due to inadequate CTR models (performance and environmental impact) and to limited ability to model interactions between CTR and conventional operations in complex adaptive airspace.

Airspace Concept Evaluation System (ACES), a well-known NAS performance analysis tool (ref. 7), was used extensively to develop CTR in NextGen performance analysis in reference 1, and will likely remain a potential tool to support future CTR NAS performance analysis in integrated aircraft performance, as well as airspace ConOps and procedure evaluations. A significant gap from prior work in this study (ref. 1) is the lack of data relative to CTR climb and descent rates, and gradients under different nacelle and airspeed configurations in the terminal area. This prevents creating proper aerodynamic and fuel burn parameters for the BADA (ref. 25), which ACES depends on for extracting lift and drag, and fuel burn characteristics to determine the CTR flight performance at given flight profiles. A specific concern is the ability of large CTRs to execute spiral climb and descent procedures under all weather conditions in order to confine noise footprints within the airport boundary, as well as to perform initial climb-out to an altitude (and final descent from an altitude) that would facilitate NIO and RIO. Therefore, an area of both CTR research and technology development is relatively high-angle climb and descent capabilities that enable CTRs to limit noise footprints and operate separately from conventional traffic through at least the first several thousand feet of airspace over an airport region. These capabilities are likely to require advanced flight controls, flight envelope exploration, and possibly vehicle design changes.

In addition to the preceding CTR technology and operational requirements, this study identifies a need for high-fidelity and validated PITL simulation capability for the various CTR variants that will be under consideration at some future time, as well as accurate representations of CTR operational, noise, and emission characteristics that can be employed in NAS performance analysis tools.

Future CTR studies will also need to depend on high-fidelity flight simulation, and accurate fuel burn, noise, and emission models that support evolved NAS and environmental analysis tools.

### **5.1.1 NAS Performance Analysis Tools and/or Enhancements for CTR Performance Evaluations**

The reference 1 report applied existing NAS performance analysis tools to evaluate CTR performance in the NAS. These tools were found to have limitations. A significant limitation was the inability of ACES to model CTR thrust vectoring characteristics and operations in the terminal area.

Definition of the evolution of NAS performance analysis tools is not possible today, given that the NextGen ConOps is still evolving and will continue to evolve over the next 15 years. However, a focus on accurate performance modeling to support PITL simulation is essential. Future terminal and en route airspace design tools that have integral provisions for modeling the special characteristics of CTRs and other high-speed rotorcraft are also essential.

A focus in an earlier NASA study of new air vehicles (ref. 8) was avionics and equipage for advanced vehicles. Significant advances in avionics and data communications are expected by the time that CTRs operate in the NAS; these advances will apply equally to conventional operations and will be a fundamental enabler of NIO operations for both conventional fixed-wing and CTR categories, as well as for CTR RIO operations. Future NAS performance analysis tools should incorporate advanced vehicle avionics operational capabilities to support NextGen ConOps development and evaluations. The following list is from reference 7:

- Enhanced Low Altitude Operations
- Weather Avoidance
- Terrain, Airspace, and Obstacle Avoidance
- Airborne Collision Avoidance

- Surface Collision Avoidance (Aircraft based)
- Wake Avoidance & Mitigation (Aircraft based)
- 3D RNP Arrival and Departure Operations
- Altitude Change Maneuvers
- Trajectory Clearance with RTA and Downlink
- Aircraft Separation
- Merging and Spacing
- Delegated Separation in Flow Corridors
- Self-Separation and Self-Separation Airspace
- Data Link Clearance Delivery and Taxi Instructions
- Increase Access and Throughput at Uncontrolled Airports
- Low-Visibility Approach, Landing, Takeoff

If ACES continues to be developed as a primary NAS performance analysis tool, the functions in the preceding list should be considered to support analysis of RIO and NIO CTR operations.

### **5.1.2 The Broad Context for Analysis of CTR Operations in the NAS**

Prioritization criteria for operations in the NAS drive performance and capability analysis needs for both CTR and conventional air vehicles. The ultimate question is whether a CTR or other NIO/RIO rotorcraft operation is viable in a future NAS, and this requires awareness of the broad context in which NAS options must be considered. The reference 1 report, together with the scenario descriptions developed in the current phase of the study, are steps in considering the context for CTR operations in the NAS. Further consideration of both broad and narrow “CTR in the NAS” performance analysis will clearly be required, particularly when considering issues such as fleet mix optimization, and both NAS and business-case implications of different CTR operational and business models.

A contextual approach for analyzing the potential for CTR operations in the NAS can be derived from current studies performed for the FAA NextGen Advisory Committee (NAC) and its Integrated Capabilities Work Group (ICWG) (ref. 26). The NAC was set up by the FAA in 2010 as a high-level federal advisory committee tasked with providing recommendations to the FAA Administrator on NextGen equipage, metrics, and integrated capabilities. The NAC established a working subcommittee (NACSC) and several work groups—an Airspace and Procedures Work Group (APWG), a Business Case and Performance Metrics Work Group (BCPMWG), and the ICWG.

The NAC tasked the ICWG with the following assigned scope of work:

- Delivering benefits-yielding operational capabilities, including capabilities at each Metroplex, between Metroplex/city pairs, and in the en route airspace
- Applications for ADS-B, DataComm, System-Wide Information Management (SWIM), and other NextGen foundational elements as specified in the 2011 FAA NextGen Implementation Plan and Enterprise Architecture
- Integrated Communication, Navigation, and Surveillance (CNS)/ATM—surface, runway, metroplex, cruise, and preflight applications

- Interface with Metroplex Optimization of Airspace and Procedures work efforts, including how these operational changes integrate with other improvement efforts across all domains (e.g., surface and cruise).

This scope of work represents an overarching approach and framework applicable to future analyses of CTR operations in the NAS. The NAC ICWG defined prioritization criteria in the three categories (operational needs, benefits, and feasibility) shown in figure 5-1.

Tables 5-1 through 5-3 illustrate considerations developed by the NAC ICWG that are relevant as a context for future CTR operational, benefits, and feasibility analyses and evaluations. While the focus of ongoing NASA CTR research will be on specific performance analysis, simulation, and modeling, it may be useful to frame the potential CTR role in a broader NAS context.

Table 5-1 shows a representative set of operational needs metrics that can be applied to CTR operations in the NAS, with special application to CTR metroplex operations.

The ICWG focus on metroplex operations is clearly applicable to future evaluations of CTR operational needs. Note also that the approach taken by the ICWG was to start by capturing the state of the system before implementation of proposed integrated capabilities—an approach that can be translated to implementation of CTR operations relative to a future baseline NAS.

The list in table 5-2 shows benefits metrics applicable to both CTR and conventional operations in the NAS.

The benefits metrics extend beyond operational benefit and include community benefit and safety benefit, as well as operational cost and investment. Table 5-3 lists feasibility considerations applicable to both CTR and conventional operations in the NAS.

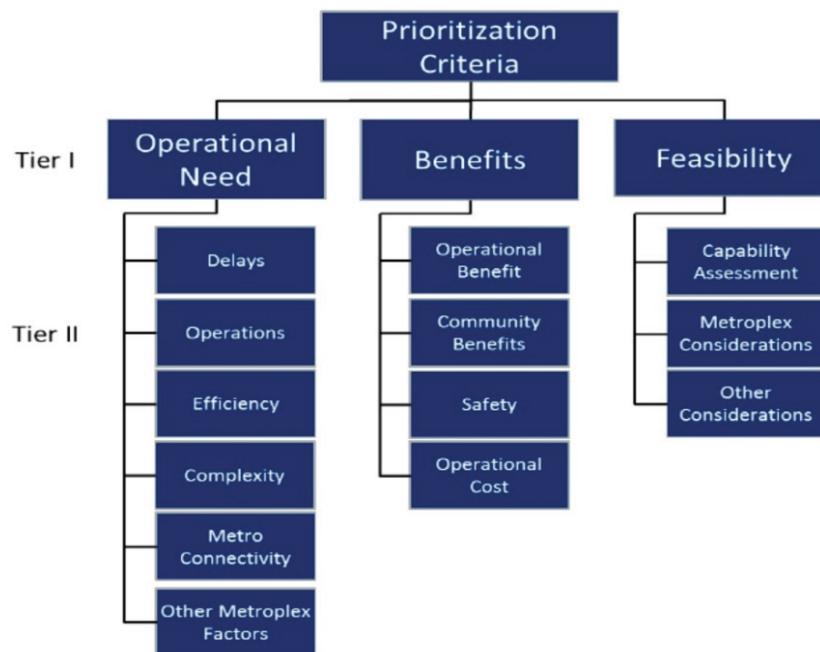

Figure 5-1. Prioritization criteria.

TABLE 5-1. OPERATIONAL NEEDS METRICS

Category	Definition (Note 1)	Metrics
Delays	Degree and type of delays that metroplexes currently experience	<ul style="list-style-type: none"> <li>• Average scheduled gate arrival delay</li> <li>• Average scheduled airport departure delay</li> <li>• Actual vs. flight plan times (by destination metroplex)</li> <li>• OPSNET delays as percent of operations</li> </ul>
Operations	Number of airport operations in a metroplex	<ul style="list-style-type: none"> <li>• Number of level-offs</li> <li>• Percent capacity used</li> <li>• Time below 10,000ft</li> <li>• Change in average taxi in time</li> <li>• Change in average taxi out time</li> </ul>
Efficiency	Degree of inefficiencies currently within a metroplex	<ul style="list-style-type: none"> <li>• Percent of arrival vectoring</li> <li>• Number of additional IFR operations</li> <li>• Number of transition sectors/center</li> <li>• Number of arrival transition sectors</li> <li>• Airport diversity - ratio of core to other airports</li> </ul>
Complexity	Degree of airspace or operational complexity currently within a metroplex	<ul style="list-style-type: none"> <li>• Percent of arrival vectoring</li> <li>• Number of additional IFR operations</li> <li>• Number of transition sectors/center</li> <li>• Number of arrival transition sectors</li> <li>• Airport diversity - ratio of core to other airports</li> </ul>
Metroplex Connectivity	Degree to which activity in one metroplex affects other major metroplexes	<ul style="list-style-type: none"> <li>• Connectivity index derived from the number of paired metroplexes</li> <li>• Average change in airborne time</li> </ul>
Other Metroplex Factors	Degree to which metroplex is impacted by aviation (i.e., importance of aviation to metroplex)	<ul style="list-style-type: none"> <li>• % metroplex GDP associated with aviation</li> <li>• % OD passengers per total metroplex population</li> <li>• % cargo tonnage shipped by aviation in/out of metroplex</li> </ul>
<b>Notes:</b>		
1. Operational Need metrics are intended to capture the state of the current system prior to implementation of proposed integrated capabilities.		

TABLE 5-2. BENEFITS METRICS

Category	Definition	Metrics (Notes 1 & 2)
Operational Benefit	Degree to which capability can increase capacity or reduce travel time	<ul style="list-style-type: none"> <li>• Metrics to be defined comparable to the Operational Benefits metrics proposed by the BCPMWG; current hierarchy includes capacity, efficiency, equity/access and flexibility metrics</li> </ul>
Community Benefit	Degree to which capability will impact passengers, communities, and environment	<ul style="list-style-type: none"> <li>• Potential reduction in passenger travel time</li> <li>• Potential noise impact, within 65dnl &amp; within 45dnl</li> <li>• Potential fuel savings (average per operation in metroplex)</li> </ul>
Safety	Potential to increase aviation safety	<ul style="list-style-type: none"> <li>• Potential reduction in operational errors</li> <li>• Potential reduction in runway incursions</li> <li>• Potential reduction in pilot deviations</li> </ul>
Operational Cost	Potential to reduce operating cost or avoid operational investment	<ul style="list-style-type: none"> <li>• Potential to positively impact an operational benefits metrics (e.g. capacity) without runway investment</li> <li>• Potential to reduce operating cost to operator (e.g. fuel efficiency)</li> <li>• Potential to reduce operating cost to service provider (e.g. decommissioning, staffing)</li> </ul>
<b>Notes:</b>		
1. Estimates of "potential" reductions or impacts may be subjective H/M/L assessments.		
2. Potential reductions will need to be evaluated relative to baseline values (i.e., without proposed NextGen capabilities).		



TABLE 5-3. FEASIBILITY METRICS

Category	Definition	Metrics
Capability Assessment	Overall readiness of an identified capability to achieve operational benefit	<ul style="list-style-type: none"> <li>• Technical readiness (Note 1)</li> <li>• Regulatory readiness (rulemaking process, operational specifications, separation standards)</li> <li>• Procedural process readiness</li> <li>• Operational readiness</li> </ul>
Metroplex Considerations	Readiness of a particular metroplex to implement an identified capability	<ul style="list-style-type: none"> <li>• Estimated time to achieve benefits at metroplex</li> <li>• Potential for extended environmental review</li> <li>• Percentage of operations within the metroplex for which aircraft are equipped (Note 2)</li> <li>• Ground/automation/surface systems availability</li> <li>• Receptivity of metroplex (Note 3)</li> </ul>
Other Considerations	A measure of availability of the resources required to implement the identified capability (Note 4)	<ul style="list-style-type: none"> <li>• FAA resources</li> <li>• Industry resources</li> </ul>
<p><b>Notes:</b></p> <ol style="list-style-type: none"> <li>1. Technical readiness includes that of all airborne and ground subsystems required to support the operational capability.</li> <li>2. Need to integrate "percentage of operations for which aircraft are equipped" with training and ops spec considerations.</li> <li>3. Airport ownership and political implications—harmony within metroplex.</li> <li>4. Budget was top "impediment" identified at 2011 RTCA Symposium. Second was FAA's ability to deliver operational benefits. The metrics in this category should be applied in the context of considering the feasibility of implementing a group of prioritized operational improvements at a number of metroplexes.</li> </ol>		

The NAC ICWG approach to feasibility includes technological, regulatory, procedural, and operational readiness, along with consideration of the readiness of individual metroplexes, and the availability of public- and private-sector resources required to implement a desired capability.

The tables in this section (derived from reference 26) are provided as a model for a broader future framework for CTR in the NAS performance analysis. They are not intended to drive recommendations. Rather they are intended to provide a context within which detailed future CTR performance analysis can be performed and evaluated.

Within this framework, analysis of CTR NAS performance must reflect NAS ConOps relevant to the analysis of CTR and conventional aircraft operations. While the earlier phase of this study (ref. 1) was based on a Joint Planning and Development Office (JPDO) future NAS ConOps (ref. 24), continued evolutionary adaptation of operations in the NAS provides illustrations that the NAS evolution cannot be predicted with any certainty. The conclusion is that the NAS performance tools needed two or three years from now will likely differ from those available today. For example, the FAA, working jointly with aircraft operators in the *Collaborative Decision Making* (CDM) program, is today in the process of developing support for electronic trajectory negotiation, which can be regarded as an early step toward trajectory-based operations. The decisions made within the past year in implementing Collaborative Airspace Constraint Resolution (CACR) will shape the way in which TBO evolves in a way that was not foreseeable two years ago.

Within CACR, there is a Collaborative Trajectory Options Program (CTOP). CTOP distributes the decision making between the FAA and the flight operators. The FAA defines constraints in the NAS (for example, a Flow Control Area (FCA) in the form of a band of convective weather extending across high-demand air routes). Flight operators have a choice of rerouting flights around the FCA or accepting delays for more direct routings. Operators decide on how important reroutes and delays are to them. The automation then matches up the constraints with the preferences to do the best job of assigning routes and delays, given the constraints that exist. (In this context, a constraint can be thought of as a situation that reduces capacity to the extent that not everyone is able to fly their most preferred route with no delay.)



Because of bad weather or other airspace constraints, sometimes it is not possible for every flight to fly its most preferred route at its most preferred time. This means that some flights, and perhaps many flights, must be given a reroute, a delay, or perhaps both. CTOP is being developed in 2012 as a way to assign these reroutes and delays based on expressed operator preferences, as part of the CACR approach, along with a new FAA Traffic Management Initiative (TMI) and data interface.

The main elements of CTOP are:

- The FAA decides what the airspace constraints are and how many flights can be allowed into selected areas.
- Flight operators send messages to the FAA that provide route options and state their ranked preferences over the possible routes and delays.
- For the routes that are feasible for each flight, given the constraint and the other traffic, the FAA selects the route and delay that the flight operator most prefers.
- The FAA informs the flight operator of the route and delay that it has been given.
- As conditions change, the FAA will, as necessary, change the route and delay that it has given to a flight and will inform the flight operator of this change.
- A flight operator can send a message to the FAA to change its preferences at any time.

Three points stand out as the essence of CTOP that most distinguishes it from current practices:

- Communication between the FAA and the flight operators is all electronic. There is no need for phone calls or for reading textual advisories. This is important because communication is precise and fast, and the system can be very dynamic.
- Flight operators are allowed to state their preferences in great detail, and in assigning routes these preferences are honored by the FAA insofar as the situation permits.
- Decisions on the routes and delays that are given to all of the affected flights are made by automation rather than by humans, thus allowing a finely tuned solution to the congestion problem that takes into account the special conditions of each flight.

The CACR/CTOP discussion is included here as an example of an innovation (consider this as version 1.0) being introduced today to meet a need that will affect the way in which the future NAS evolves. From a modeling and simulation perspective, CACR/CTOP represents an early form of independent agents (flight operators) attempting to adapt their aircraft trajectories to optimize their individual objective functions within a regulatory system. This regulatory system continually manages to avoid a conflict of trajectories and operates under rules that maintain safety and use available capacity efficiently. Caution is therefore necessary in making specific recommendations for future modeling and simulation tools for CTR NAS performance evaluation. However, for the purposes of the current study, the discussion includes a review of the shortcomings of currently available and accepted analytical tools used in the study.

With the above caveat, the discussion that follows addresses more specific NAS performance analysis, simulation, and modeling capability issues relative to future CTR studies.

### 5.1.3 CTR Performance Modeling

A lesson learned in an earlier phase of this study (ref. 1) was the limitation of CTR performance modeling using BADA. The earlier analysis evaluated a limited set of CTR variants. Future studies should extend the modeling capability to a wider range of CTR sizes. This will be important in conducting trade studies (performance and business case) to develop a more nearly optimal fleet mix, as well as to evaluate CTR performance in the business cases proposed in section 4 herein.

There is a need for better CTR modeling through BADA to include improved low-speed performance estimates, as well as a wider range of CTR sizes, and possibly designs optimized for STOL operations. The current study does not address ways in which a more optimal fleet mix could be evaluated. Earlier studies (including references 8 and 11) could be reviewed and updated to review the implications of differing design philosophies and technology levels on CTR effectiveness in reducing delay, fuel burn, and emissions.

Technical challenges for CTR performance modeling tool developers include:

- Development of a combined/coupled terminal and en route ACES capability
- Upgrade ACES to use all of BADA input (rather than a subset of coefficients)
- Upgrade the SAIC-developed Performance Deck tool (ref. 1) to accommodate hover, low-speed helicopter-mode, and transition flight
- Generating procedures and constraints to study additional airports using the combined/coupled terminal/en route ACES tool
- Devise a semi-automated tool for notional vertiport sites to be used in ACES, Integrated Noise Model (INM), and coupled terminal/en route ACES investigations
- Support means for directly importing BADA and Rotorcraft Noise Model (RNM) data into AEDT

### 5.1.4 En Route and Delay Modeling

Earlier work in the current study (ref. 1) relied on ACES to model CTR en route operations and NAS delays. ACES is a distributed, agent-based simulation of the NAS, consisting of NAS models together with simulation control and assessment tools. A limitation of ACES is that the flight trajectories generated within ACES are implemented only between arrival and departure fixes, based on the EUROCONTROL BADA model. ACES does not have an integrated en route and terminal area NAS performance analysis tool to address CTR operations in the terminal area. To be useful, future evolution of ACES (or other comparable NAS simulation tools) will need to accommodate CTRs and other rotorcraft.

ACES was used in the current study to model independent CTR and conventional operations separately. The approach assigned traffic and operations to the CTR fleet, and removed corresponding traffic and operations from conventional operations. This approach had the effect of reducing delays generated by the conventional fleet and, at the same time, allowed CTR operations to be modeled based on network-independent operations. This approach also supported modeling of different circuitry and routing assumptions, including fix-based routing and direct-to routing (ref. 1).

As ACES and similar NAS performance modeling tools evolve, a similar ACES-based approach could be considered for future CTR and conventional fleet delay estimation. Because delay reduction is critical to any evaluation of the business case for CTRs, the application of ACES and similar evolved NAS en route and delay analysis tools will be important to future CTR analyses. However, evolution in the NAS traffic management system during the next decade will likely involve collaborative and adaptive air traffic

management approaches that will present options and management decision criteria based on continuous evaluation of traffic, weather, and capacity constraints.

### **5.1.5 Terminal Modeling**

Ames Research Center is currently planning terminal enhancements to ACES that will include runway-to-runway trajectory modeling. This work is nominally to support NASA Langley merging and spacing research, refs. 26-27. It is not clear whether ACES will be the tool of choice for future terminal modeling, however, enhanced future terminal modeling capability is expected. Three issues need to be considered in future CTR analysis:

1. The availability of high-fidelity CTR dynamic flight models for use in simulations
2. The state of the art in integrated terminal and en route modeling and simulation
3. The concept of operations for future NAS terminal operations

The current state of the art is deficient with respect to all three of these issues. Due to current ACES limitations, terminal modeling as described in reference 1 relied on AvTerminal, a Saab Sensis software tool. Limitations in AvTerminal suggest that future CTR performance analysis will require tools that support detailed terminal airspace design and performance analysis. The main purpose for using AvTerminal was to validate the ability to accurately model CTR performance characteristics derived from PITL simulation. The lessons learned from coupling AvTerminal with ACES were related to the difficulty of modeling CTR performance characteristics in a simulation designed for fixed-wing aircraft. The same difficulty should be anticipated when CTR (and other vertical- and powered-lift aircraft) performance models are required to be incorporated in evolved terminal simulations.

Priority should be given first to development of high-fidelity CTR flight models for use in simulation, along with integration of these models into emerging mainstream terminal area simulations. Future NAS terminal area ConOps will necessarily evolve, and it is unlikely in the short- and medium-term that these will be driven by considerations of CTR operational capabilities.

The main lesson learned from prior research is a need to explore PITL test points over a wide range of CTR speeds, tracks, and climb and descent trajectories. A prior study (ref. 7) examined spiral approaches in the terminal area, as well as curved approaches and departures that served to deconflict the traffic in the vicinity of airports and runways.

Because CTR operations are likely to be conducted in congested airspace consistent with NextGen ConOps, any future requirement for modeling CTR performance in the terminal area will most likely be met through employment of simulations (including advanced agent-based simulations) that are extremely complex and computationally intensive. The difficulty experienced in today's metroplex airspace design, as well as the difficulties that are projected to exist when full 4D TBO becomes operational, suggest that the gap between simulation capability and simulation needs will not soon be filled.

Following the work performed in reference 1, a recommended focus for terminal modeling should be on airports in the three regional scenarios—Atlanta, Las Vegas, and a Northeast Corridor scenario based on service at nine major airports.

A recommended focus for future analysis of CTR operations in the terminal area should be on high-fidelity transport category CTR PITL simulation, along with exploration of a range of nacelle transition options and performance in the terminal area, including spiral climbs and descents. Detailed NextGen terminal airspace

design will be important to future CTR evaluations. Existing tools have serious limitations in their ability to redesign complex metroplex airspace in operationally and environmentally acceptable ways. Future separation standards and TBO procedures have yet to be developed. For these reasons, a focus for future CTR research should be on simulating CTR terminal area maneuvering performance.

### **5.1.6 Environmental Modeling**

Aviation Environmental Design Tool (AEDT) is a next-generation FAA aviation environmental analysis tool. AEDT will replace current public-use aviation air quality and noise analysis tools such as the Integrated Noise Model (INM—single airport noise analysis), the Emissions and Dispersion Modeling System (EDMS—single airport emissions analysis), and the Noise Integrated Routing System (NIRS—regional noise analysis). AEDT is currently under development, and a mature version does not yet exist. When AEDT is released for public use, the current legacy tools will be retired, and AEDT will become the standard U.S. aviation noise and emissions compliance tool. Published guidance from the AEDT development team in 2010 was that AEDT 2b would be released in 2013. However, given the difficulty in developing estimates of CTR noise and emissions in the early phase of this study, there is a concern that the next evolution of AEDT will not adequately accommodate CTRs and other rotorcraft.

Future use of AEDT for CTR analysis will require accurate CTR noise and emissions models to be developed in a form that AEDT can accept. This, in turn, will require detailed CTR performance and noise data to be developed, together with AEDT CTR model validation and acceptance testing.

## **5.2 Technical Challenges for Concept and Future Tool Developers**

A short list of challenges for future concept and tool developers to enable future CTR evaluations includes:

- Follow through on requirements identified in reference 1 for CTR aircraft to be competitive in efficiency, including improvements such as aerodynamic design to reduce drag, manufacturing technology to reduce weight, and engine technology to reduce fuel consumption and emissions.
- Pursue ability to evaluate additional CTR size variants in the 10- to 150-seat band.
- Consider how Partially Non-Interfering Operations (PNIO) might be modeled in accommodating CTR operations in the NAS.
- Upgrade ACES to use all available BADA input (rather than a subset of coefficients).
- Upgrade the CTR Performance Deck software tool developed in reference 1 to accommodate hover, low-speed helicopter-mode, and transition flight.
- Pursue ability to automatically generate airspace procedures and constraints in order to study individual airports using a combined en route and terminal airspace and NAS analysis tool.
- Pursue ability to employ a semi-automated tool for notional vertiport siting to use in ACES, AEDT, and coupled en route and terminal analysis tools.
- Pursue ability to employ a semi-automated means of directly importing BADA and RNM data into AEDT.
- Evolve AEDT to fully accommodate CTRs and other rotorcraft.

### **5.3 Summary**

The main technology requirements relating to analysis and simulation are to confirm the ability of civil transport category CTRs to be certified to operate under future ConOps in complex airspace on short- and medium-range routes (up to 500 statute miles per flight segment). The most advanced airspace performance tools that exist today are those used for FAA metroplex and terminal area airspace redesign studies and environmental impact statements. The time required and cost to use these tools means that they are likely to be beyond the reach of current or foreseeable-future CTR airspace studies.

Evolution in NAS operations suggests that NAS today is in an early transition stage to a system where flight operators will be able to continuously adapt their aircraft trajectories to optimize their individual objective functions, within an FAA-regulated system that continually manages the deconfliction of trajectories, maintains safety, and uses available capacity efficiently. What is clear, however, is that future CTR studies will depend on accurate flight performance characteristics, fuel burn, noise, and emission models that support evolved NAS and environmental analysis tools. The evolutionary path of these tools is not available, but as the tools evolve, detailed CTR performance data will be needed. A focus on developing accurate performance modeling using PITL will be essential.

## **6 SUMMARY AND RECOMMENDATIONS**

Integrating civil tiltrotor aircraft into the NAS is a complex issue. Expected NAS performance benefits gained by assuming NIO and RIO need to be verified according to operational procedures and airspace design to ensure the safety of the flying public, and minimize environmental impact to surrounding communities near and around CTR operations. Specific case studies were developed to give more thorough assessment of issues associated with NIO and RIO assumptions, and safety cases of CTR operations. This study is focused on identifying issues for future CTR studies. Based on these assessments, additional requirements for NAS performance tools were developed to support a fully integrated CTR NAS performance analysis.

### **6.1 NIO and RIO Assumption Assessment**

To assess NIO and RIO assumptions, specific operational scenarios (shuttle services between BOS and EWR) were selected according to takeoff and departure, en route, and arrival routes discussed in section 2. Conventional fixed-wing traffic, as well as CTR ConOps, will need to be further developed to support an integrated assessment. Extensive PITL and CITL will be needed to evaluate candidate ConOps in the terminal areas to operate the CTR fleet under NIO and RIO, and advanced NAS performance analysis tools, such as ACES and AEDT, will be needed to evaluate the airspace design and separation assurance issues.

### **6.2 Safety Assessment**

Based on an assessment of notional EWR operations and selected CTR-unique failures, an initial safety analysis was conducted to evaluate potential safety issues by applying SMS and SRM methodology. All three selected failures project “medium” risks and require risk mitigations. Mitigations include improving the flight control and power control software, applying adaptive control to maintain the safety of the flight control authority, and developing procedures to account for CTR flight performance under off-nominal conditions.

There needs to be continued investigation of the potential of modern digital flight/propulsion control integration concepts, e.g., adaptive controls, etc., to allow CTRs to perform curved, decelerating, and descending approaches in terminal areas that have very constrained airspace. CTRs will need to be fully capable of operating on 4-dimensional trajectories and NIO and RIO operations envisioned by NextGen.

There are no clear ATC procedures or policies that adequately describe NIO and RIO operations with respect to the unique performance capabilities in both normal and off-nominal conditions. PITL and CITL studies need to be performed to evaluate the current ATC procedures and evaluate new ones with respect to the safety, efficiency, and NAS capability of CTR operations.

A recent NASA report (ref. 11) made several recommendations concerning safety model shortcomings that needed to be resolved in order to meet NextGen safety goals. First was the need to define a mutually accepted and internationally harmonized set of safety metrics so that an acceptable level of safety can be determined. Second, while there were several potential safety models being discussed, none have matured sufficiently to provide quantitative safety data.

### **6.3 Assessment of CTR Case Studies**

A systems analysis was developed by examining different CTR operational models based on passenger sizes and range. CTR operational models will need to be developed and evaluated alongside their respective business cases to identify additional issues to help determine future research topics and NAS performance analysis tools. Findings suggest accurate fuel burn models, noise models, and emission models that support evolved NAS, and environmental analysis tools and PITL simulation will be essential in addressing identified key issues.

### **6.4 NAS Performance Analysis Tool Assessment**

A full assessment of NAS performance of the CTR fleet will require integrated NAS performance analysis tool sets (i.e., from gate-to-gate), because the primary virtues of the CTR fleet are in the terminal area where CTR VTOL and STOL capabilities give additive benefit to the NAS capacity and delay performance. More expanded PITL studies to evaluate various ConOps in support of NIO and RIO development in the terminal area, and additional CTR flight performance data based on these ConOps to support an integrated NAS performance study in airspace design and environmental impact are in order.

If there is support for continued development of ACES, a consolidated future version of ACES with both en route and terminal modeling capability would offer improved ability to model procedures and airspace from terminal to a transition point to direct en route trajectories, while ensuring separation assurance. An evolved AEDT capability with accurate CTR noise, emissions, and flight trajectory modeling capability will be required to evaluate CTR noise and environmental impact.

### **6.5 Recommendations**

An integrated systems tradeoff process is shown in figure 6.1, which includes iterations through the design, PITL and CITL, and NAS performance analysis, to arrive at a matured CTR ConOps with desired benefits. This suggests that a fully integrated NAS performance tool will be needed to assess the impact of a fleet of CTRs on the NAS. A recent study (ref. 1) provided a first-order quantitative assessment of what a CTR fleet could achieve under the assumptions of NIO and RIO. The next logical step is to develop a NAS simulation

environment with CTR attributes such that various CTR ConOps can be fully evaluated against NAS procedures, rules, traffic, routes, automation, and weather at airport, terminal, and en route airspace. Through discussions in previous sections, the following recommendations are summarized.

1. Develop NIO and RIO ConOps of the CTR fleet using PITL and CITL to investigate and identify required airspace configuration requirements in the terminal area with fixed-wing traffic and with off-nominal operational conditions to meet safety requirements.
2. Based on CTR ConOps, develop CTR flight performance data including fuel burn for the BADA, and VTOL and STOL to support NAS performance analysis tool sets (e.g., ACES and AEDT).
3. Extend existing NAS performance analysis tool sets (e.g., ACES) to include terminal area to evaluate CTR throughput performance, and configuration of CTR NIO and RIO routes.
4. Develop CTR noise data based on existing XV-15 and V-22 noise data, with the possibility of AW609 to support a wider range of noise and environmental impact analysis tool sets (e.g., AEDT).

Given that this CTR analysis focused on the beneficial effects of CTR operations in reducing congestion, a consistent theme of the proposed case studies is a focus on CTR operations at congested hubs. Therefore, most of the case studies in this section involve a congested hub. (Those that do not are part of a local route involving a hub and more than one other point of service, i.e., our treatment of population centers and remote locations.) As indicated in table 4-1, there are other potential CTR operations that do not involve congested hubs. These may warrant further research but are outside the scope of the analysis in this effort.

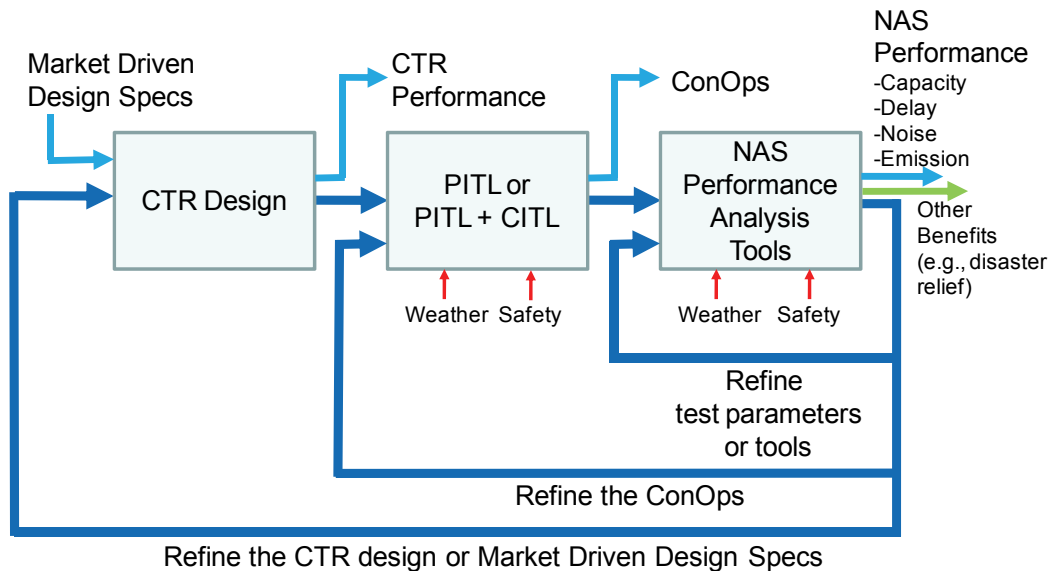

Figure 6-1. An integrated systems tradeoff process for a CTR research and development cycle.

Recommended issues for further research in this area are:

1. Explore issues associated with earliest, near-term deployment of CTRs in the NAS.
2. Investigate the viability of a new type of service enabled by CTR capabilities (local, high-speed, non-interfering transport, especially connecting multiple, high-volume airports).
3. Explore the establishment of vertiports in areas not serviced by airports.
4. Explore the safety analysis of CTR taxi-out and taxi-in procedures, and ground crew support procedures at the gate.
5. Explore feasibility of fast-tempo CTR operations (rapid and predictable movement of passengers to and from flight ops, boarding, disembarking, etc.).
6. Test RIO and NIO concepts without the option of making changes to current routes and airfield facilities.
7. Investigate the viability of a new type of service enabled by CTR capabilities (connecting population centers entirely apart from conventional airport networks).
8. Explore the establishment of vertiports in high-population areas.
9. Explore the regular operation of CTRs in remote locations. This includes the establishment of new vertiports in relatively isolated locations, context-specific operational details, maintenance, and safety considerations.
10. Evaluate the desirability, from a human factors perspective, of CTR operations in remote areas (i.e., sightseeing and the novelty factor).
11. Explore some of the factors involved in CTR operations subsidized by income beyond direct ticket sales (i.e., ongoing investment by other interested parties).
12. Explore deployment advantages of CTRs for cargo relative to CTRs for passengers, including safety and regulations, independent facilities, and human factors.
13. Evaluate expedited cargo operators as a user of CTR technology in general, especially to avoid congestion limitations during daytime operations, and as a CTR early adopter in particular, as well as safety and regulations, independent facilities, and human factors related to cargo operations.
14. Assess benefits, costs, and viability of CTR use in the proposed scenarios to both operators and the FAA.
15. Evaluate business case to operators (new capabilities, cost of equipment, facilities, operations, etc.) and FAA (cost of procedures, congestion reduction, etc.).
16. As special cases, evaluate the business case for CTR services to expedited cargo operators, and to remote and currently underserved locations.



## 7 REFERENCES

1. Chung, W., et al.: Modeling High-Speed Civil Tiltrotor Transports in the Next Generation Airspace. NASA CR-2011-215960, Oct. 2011.
2. Clay, W., et al: Civil Tiltrotor Missions and Applications: A Research Study. Boeing Commercial Airplane Co., Bell Textron, Inc., Boeing Vertol, NASA CR-177451, Nov. 1987.
3. Thompson, P., et al: Civil Tiltrotor Missions and Applications: Phase II—The Commercial Passenger Market, Summary Final Report. Boeing Commercial Airplane Co., Bell Helicopter Textron, Inc., Boeing Helicopters, NASA CR-177576, Feb. 1991.
4. Civil Tiltrotor Development Advisory Committee: Report to Congress in accordance with PL1-0-581, vol. 1, Final Report, Dec. 1995.
5. Johnson, J.; Stouffer, V.; Long, D.; and Gribko, J.: Evaluation of the National Throughput Benefits of the Civil Tiltrotor. NASA CR-2001-211055, Sept. 2001.
6. Stouffer, V.; Johnson, J.; and Gribko, J.: Civil Tiltrotor Feasibility Study for the New York and Washington Terminal Areas. NASA CR-2001-210659, Jan. 2001.
7. NASA Ames Research Center, ATM Research, Modeling and Simulation. <http://www.aviationsystemsdivision.arc.nasa.gov/research/modeling/aces.shtml>. Accessed Nov. 2011.
8. Blake, M., et al: Advanced Vehicle Concepts and Implications for NextGen. NASA CR-2010-216397, Jan. 2010.
9. European Organization for the Safety of Air Navigation, Brussels, Belgium: User Manual for the Base of Aircraft Data (BADA)—Revision 3.6. EUROCONTROL Experimental Center (EEC) Note no. 10/04, July 2004.
10. International Civil Aviation Organization (ICAO): Safety Management Model (SMM), document 9859/AN474, second ed., 2009.
11. Zellweger, A., et al: Introduction of Advanced Concepts and Vehicles into the Next Generation Air Transportation System. NASA/CR 2010-215961, Feb. 2010.
12. Federal Aviation Administration/Air Traffic Organization: FAA/ATO SMS Manual, version 2.1, April 2008.
13. Federal Aviation Administration: FAA Instrument Procedures Handbook, FAA-H-8261-A, Ch. 5, Approach, and Ch. 7, Helicopter Instrument Procedures, [http://www.faa.gov/library/manuals/aviation/instrument\\_procedures\\_handbook/](http://www.faa.gov/library/manuals/aviation/instrument_procedures_handbook/). Accessed Jan. 2012.
14. Federal Aviation Administration: FAA Order 7210.56C.CHG 2, section 5 and 6, July 20, 2009.
15. Anon.: Code of Federal Aviation Regulations, Title 14, Section 25.1309, Equipment, Systems, and Installations, [http://ecfr.gpoaccess.gov/cgi/t/text/text-idx?c=ecfr&tpl=/ecfrbrowse/Title14/14tab\\_02.tpl](http://ecfr.gpoaccess.gov/cgi/t/text/text-idx?c=ecfr&tpl=/ecfrbrowse/Title14/14tab_02.tpl). Accessed Jan. 2012.
16. Federal Aviation Administration: FAA Advisory Circular 25.1309-1A, System Design and Analysis, June 21, 1988.

17. Department of the Navy: Naval Air Systems Command, Results of a Court of Inquiry Investigation Into the Circumstances Surrounding the Crash of a V-22 Aircraft Bureau Number 163914 That Occurred in the Vicinity of Marine Corps Base, Quantico, VA, on 20 July 1992.
18. Anon. (Bell Helicopter Textron, Inc.): Drive System for Tiltrotor Aircraft, United States Patent No. 5,054,716, Oct. 8, 1991.
19. Acosta, D. M. et al.: Adaptive Control for ESTOL Design Abstractions—Performance Analysis. AIAA Paper no. 2008-879, 46th AIAA Aerospace Sciences Mtg. and Exhibit, Reno, NV, Jan. 7–10, 2009.
20. Stepanyan, V., et al.: Adaptive Control of a Transport Aircraft Using Differential Thrust. AIAA Paper no. 2009-5741, AIAA Guidance, Navigation, and Control Conference, Chicago, IL, Aug. 10–13, 2009.
21. Department of Transportation/Federal Aviation Administration: The Potential for Fuel Tank Fire and Hydrodynamic Ram Force From Uncontained Aircraft Engine Debris. DOT/FAA/AR-96/95, Jan. 1997.
22. Krishna Kumar, K. and Gundy-Burlet, K.: Intelligent Control Approaches for Aircraft Application. 2nd JANNAF Modeling and Simulation Subcommittee Mtg., April 1, 2002, pp. 189–197.
23. Gibson, T.; Jagielski, M.; and Barber, J.: Disaster Response Effectiveness of a Fleet of Civil Tiltrotor Aircraft Operating in the Next Generation Air Transportation System. NASA/CR–2012-216000, Jan. 2012.
24. Joint Planning and Development Office (JPDO): Section 2, Air Traffic Management Operations, NextGen Concept of Operations, Version 3.2. JPDO, Washington, D.C., Sept. 2010.
25. Anon.: NextGen Advisory Committee, Findings and Recommendations: Metroplex Prioritization and Integrated Capabilities Scoping and Requirements, Sept. 2011. [http://www.rtca.org/CMS\\_DOC/NAC%20Recommendations%20Sept%202011Atch4.pdf](http://www.rtca.org/CMS_DOC/NAC%20Recommendations%20Sept%202011Atch4.pdf). Accessed Nov. 2011.
26. Santos, M.; Feinberg, A.; Zhang, Y.; Teng, Y.; Chen, J.; Nigam, N.; and Smith, J.: Scheduling the Use of Airborne Merging and Spacing Along Multiple Converging Routes to an Airport. AIAA Modeling and Simulation Technologies Conference, Toronto, Canada, Aug. 2–5, 2010.
27. Glaab, P.: A Validation Study of Merging and Spacing Techniques in a NAS-wide Simulation. IEEE Integrated Communications, Navigation and Surveillance Conference, Herndon, VA, May 10–12, 2011.
28. Gibson, T.; Jagielski, M.; Barber, J.; Chung, W.; and Young, L.: Employment of Conceptual Civil Tiltrotor Aircraft in Disaster Response. 68th Annual Forum of the AHS, International, Fort Worth, TX, May 1–3, 2012.
29. Scheidler, P. F.; Hopkins, R.; and Fortenbaugh, R. L.: Autorotation, Windmill, and Power Off Reconversion Testing of the BA609 Tiltrotor. 40th International Society of Flight Test Engineers (SFTE) Symposium and 19th SFTE European Chapter Symposium, Linköping and Stockholm, Sweden, September 7–11, 2009.
30. Rajagopalan, R. G., et al: RotCFD a Tool for Aerodynamic Interference of Rotors: Validation and Capabilities. AHS Future Vertical Lift Aircraft Design Conference, San Francisco, CA, Jan. 18–20, 2012.

## APPENDIX A. TERMINOLOGY USED IN SAFETY ANALYSIS

**Acceptable Level of Safety**—can be expressed by two measures/metrics (safety performance indicators and safety performance targets) and implemented through various safety requirements.

1. Safety indicators are the measures/metrics used to determine if the acceptable level of safety has been achieved. One of the current safety indicators of the FAA is the commercial air carrier fatal accident rate, which, for FY 2007, was 8.88 fatalities/100 million passengers on board.
2. Safety targets are the quantified objectives pertinent to the acceptable level of safety. The FAA “Flight Plan” for 2009–2013 targets a 50-percent reduction in the commercial air carrier fatal accident rate by 2025.
3. Safety requirements are conditions or capabilities that must be met or surpassed by a system to satisfy a contract, standard, specification, or other formally imposed document. The FAA Flight Plan calls them “strategies” and “initiatives.” One of the strategies is to continue the evolution to a performance-based NAS; a corresponding initiative is to develop a plan for ADS-B high-altitude performance in specific regions of the NAS.

**Accident**—An unplanned event or series of events that result in death, injury, or damage to, or loss of equipment.

**Hazard**—Any existing or potential condition that can lead to injury, illness, or death of a person; damage or loss of a system, equipment, or property; or damage to the environment. A hazard is a condition that is a prerequisite to an accident or incident.

**Incident**—A near-miss episode, a malfunction or failure without accident-level consequences that has a significant chance of resulting in accident-level consequences.

**Qualitative Risk Assessment**—Relating to quality or kind; subjective approach to risk assessment.

**Quantitative Risk Assessment**—Expressed as a number or quantity; probabilistic or measured approach to risk assessment.

**Risk**—The assessed potential for adverse consequences resulting from a hazard. It can be expressed as a probability:

$$\text{Risk (relating to a hazard)} = (\text{probability of an event occurring}) \times (\text{impact of the event occurring})$$

**Risk Analysis**—The function of determining what hazards a system has.

**Risk Management**—The identification, analysis, and elimination, and/or mitigation to an acceptable level, of those hazards that threaten safety.

**Risk Mitigation**—Those actions taken to reduce risk to an acceptable level.

**Safety (ICAO)**—The state in which the risk to harm to persons or of property damage is reduced to, and maintained at or below; an acceptable level through a continuing process of hazard identification and risk management.

Risk Mitigation Process (Figure 2)

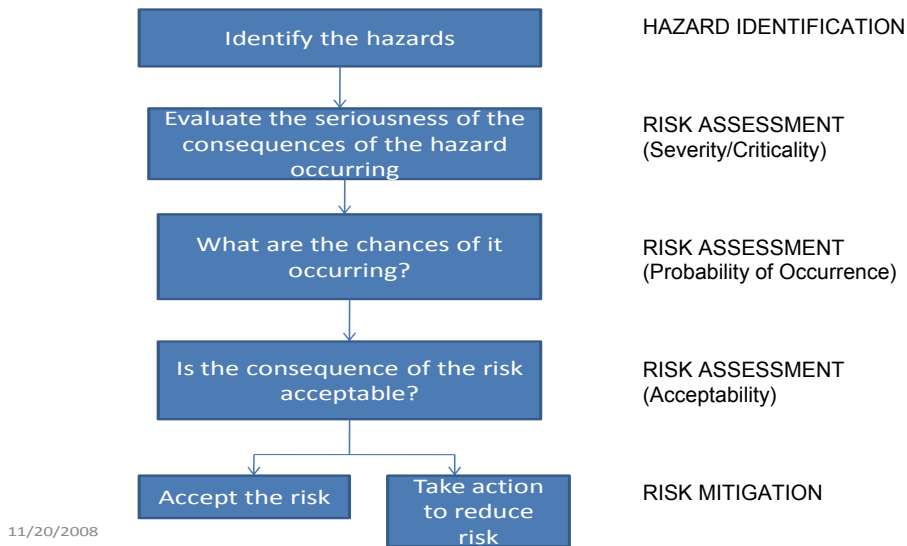

**Safety Management System (SMS)**—An organized approach to managing safety, including the necessary organizational structures, accountabilities, polices, and procedures.

**Safety Risk Control**—A characteristic of a system that reduces safety risk. Controls may include process design, equipment modification, work procedures, training, or protective devices.

**Safety Risk Management**—A five-step cyclic process that includes system description, hazard identification, risk analysis of hazards, risk assessment, and risk mitigation. (See Risk Management.)

**Serious Incident**—An incident involving circumstances indicating that an accident nearly occurred.<sup>5</sup>

**Severity**—The consequence or impact of a hazard in terms of degree of loss or harm.

**Substitute Risk** – Risk created as a consequence of safety risk control(s).

**System**—An integrated set of constituent elements that are combined to accomplish a defined objective. These elements include people, hardware, software, firmware, information, procedures, facilities, services, and other support facets.

**Target Level of Safety**—Same as Acceptable Level of Safety.

<sup>5</sup> In 1969, research into industrial accidents indicated that for every fatal accident there were 600 incidents with no reported injuries or damage, 30 incidents involving property damage, and 10 accidents involving serious injuries. This was termed the “1-600 Rule.”