



The Art of Metal Whisker Appreciation: A Practical Guide for Electronics Professionals

Lyudmyla Panashchenko
NASA Goddard Space Flight Center
lyudmyla.p@nasa.gov

April 17, 2012

www.nepp.nasa.gov/whisker

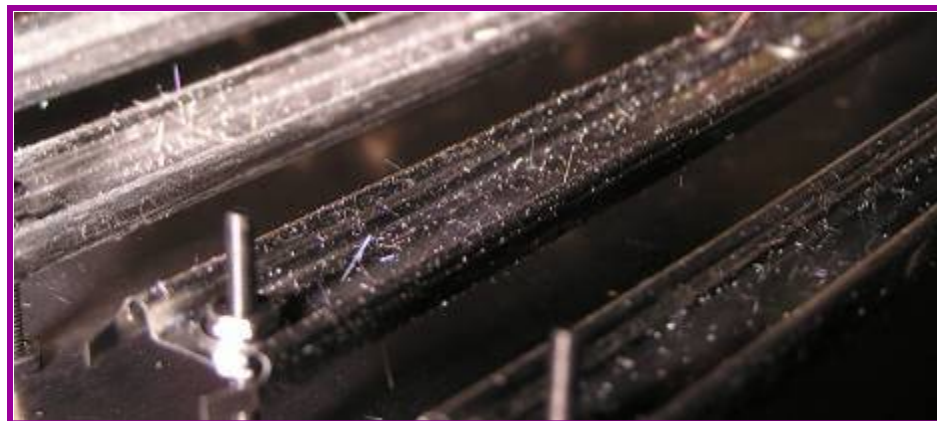

Outline

- What are metal whiskers?
 - Attributes
 - Failure modes
 - Similarities between tin, zinc and cadmium whiskers
 - Whisker initiation and growth
 - Things that are not whiskers
- Difficulties in observing metal whiskers
 - Optical
 - Electrical
- Statistics of whiskers
 - Length, thickness, density
- Environmental tests
- Metal Vapor Arcing



*Zinc Whiskers on
Hot Dip Galvanized Steel Pipe*



About Us

- Metal Whisker Investigation Team at NASA Goddard Space Flight Center
 - H. Leidecker, M. Sampson, L. Panashchenko, J. Brusse, J. Kim
- Widely recognized for our Metal Whisker WWW site
 - <http://nepp.nasa.gov/whisker>
- Published study of 11+ year evaluation of conformal coating for whisker mitigation
- Numerous other publications on metal whiskers (tin and zinc whiskers)
- >10 years experience with anomalies related to metal whiskers
 - Aerospace: Satellites and Space Shuttle
 - Military: Missile Systems, Ordinance Fuzes
 - Industrial: Nuclear and other Power Plants, Paper Mills, Non-interruptable Power Supplies
 - Automotive: Speedometers and other gauges, “DOA” cars
 - Others

What are Metal Whiskers?

- Hair-like metal structures that erupt outward from a grain or several grains on a metal surface
 - May be straight, kinked, or odd-shaped eruptions
- Coatings of Tin, Zinc and Cadmium are especially able to develop whiskers; but, whiskers have been seen on Indium, Gold, Silver, Lead, and other metals too

Source Material	→	atoms for the metal itself
Transport Mechanism	→	primarily grain boundary diffusion
Transformation	→	diffusing atoms aggregate at the root (NOT the tip) of the forming whisker

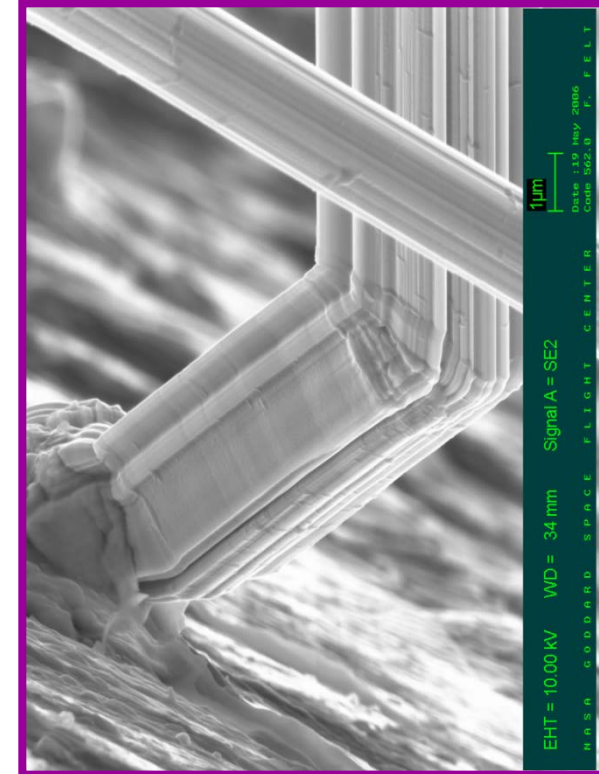

Tin Whiskers on Tin-Plated Electromagnetic Relay Terminals

Human Hair vs. Metal Whisker

Metal Whiskers are commonly
1/10 to <1/100 the thickness of a human hair

**Optical comparison of
Human Hair vs. Tin Whisker**



**SEM comparison of
Human Hair vs. Metal Whisker**

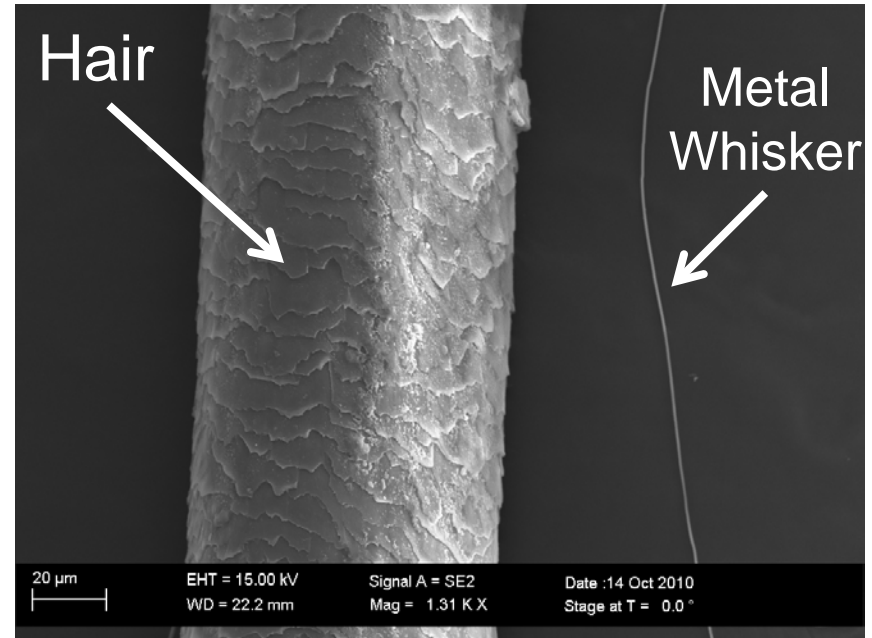

Failure Modes Caused By Metal Whiskers

Electrical Short Circuits

$$R = \frac{\rho \cdot L}{A}$$

Where
 R = resistance of whisker
 ρ = resistivity; L = length;
 A = cross sectional area

- Continuous short if current $I_{whisker} < I_{melt}$
 - Intermittent short if $I_{whisker} > I_{melt}$
 - **Metal Vapor Arc!!!**
 Up to HUNDREDS of AMPERES can be Sustained!!!
- See Discussion

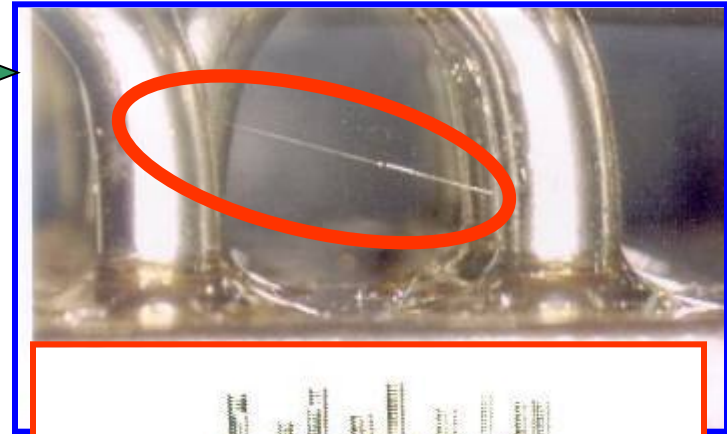

Debris/Contamination

- Dislodged whiskers become foreign object debris
 - Produce Shorts in Areas REMOTE From Whisker Origins
Example: zinc whiskers are often detached from zinc-coated raised floor tiles by physical handling. Once detached they are re-distributed by air currents into nearby electronic assemblies

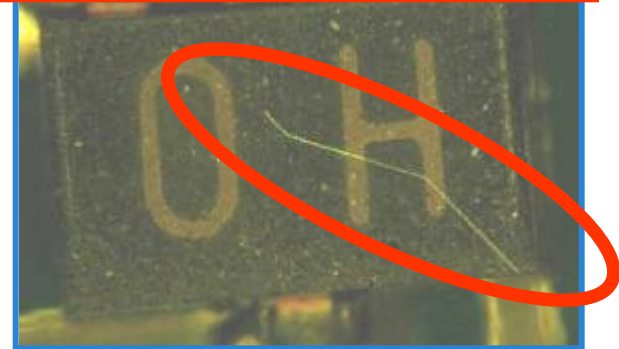

http://nepp.nasa.gov/whisker/reference/tech_papers/2004-Brusse-Zn-whisker-IT-Pro.pdf



The Good News:

Not All Tin, Zinc or Cadmium Surfaces
Will Grow Whiskers
(See Back Up Slide for Discussion)

The Bad News:

Current theories and test methods **DO NOT**
have predictive power of the time-dependence of
Whisker Density, Length or Thickness Distributions

A useful theory should identify what we must control to make
confident predictions.
Such a theory has remained elusive

Metal Whiskers on Components

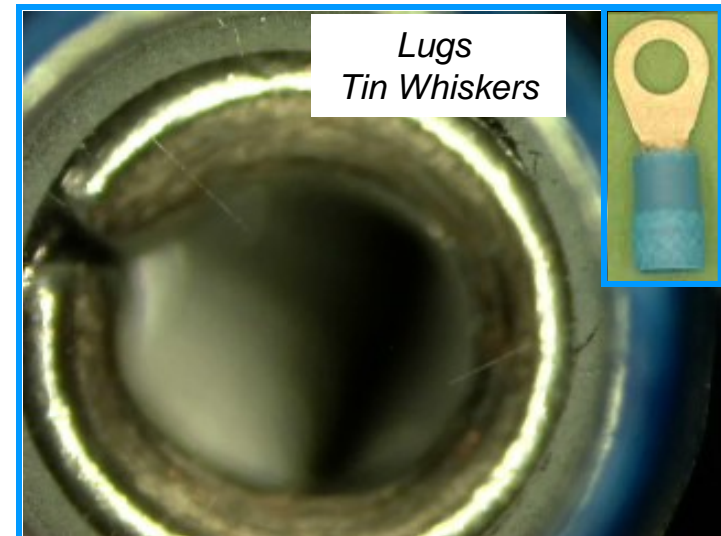
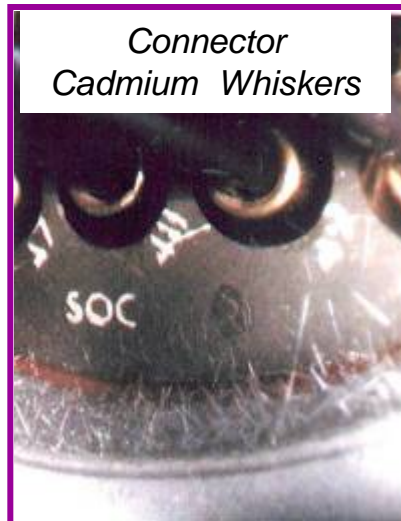
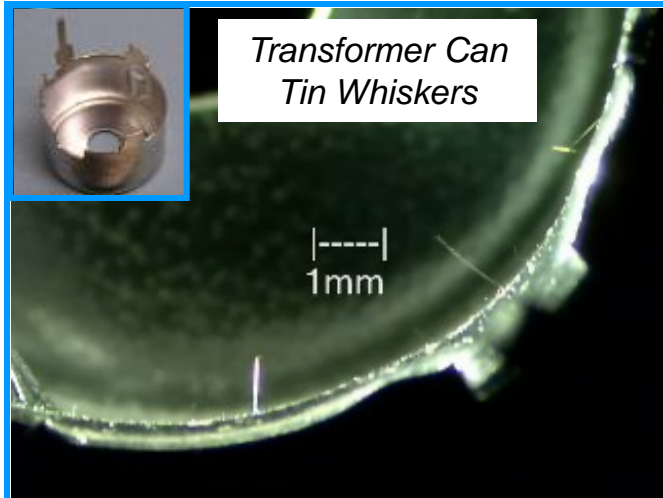
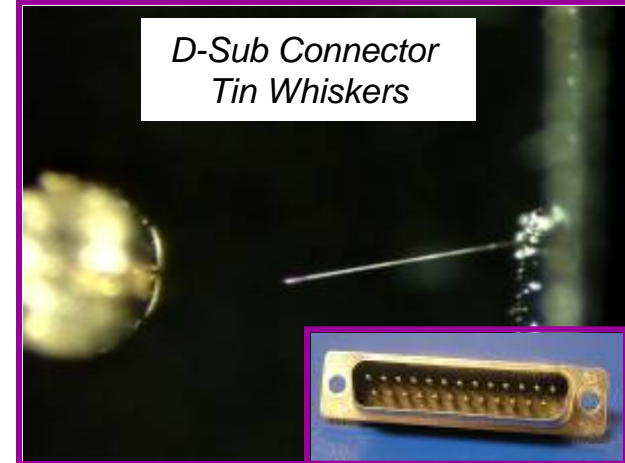
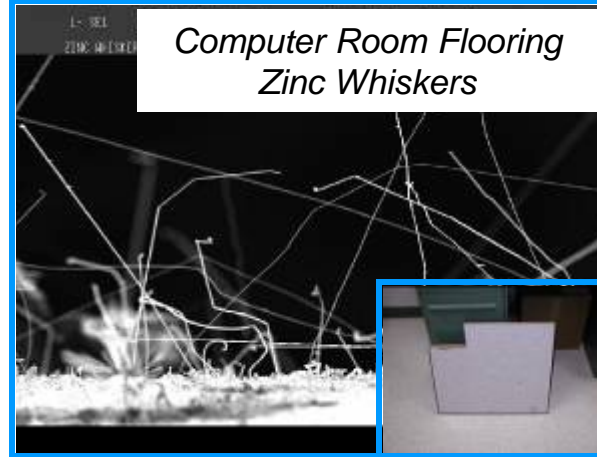
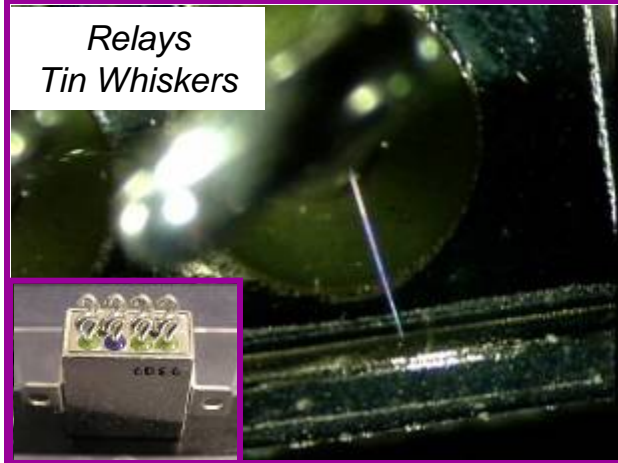

Guess What's Lurking Inside?



1960's Vintage
Transistor

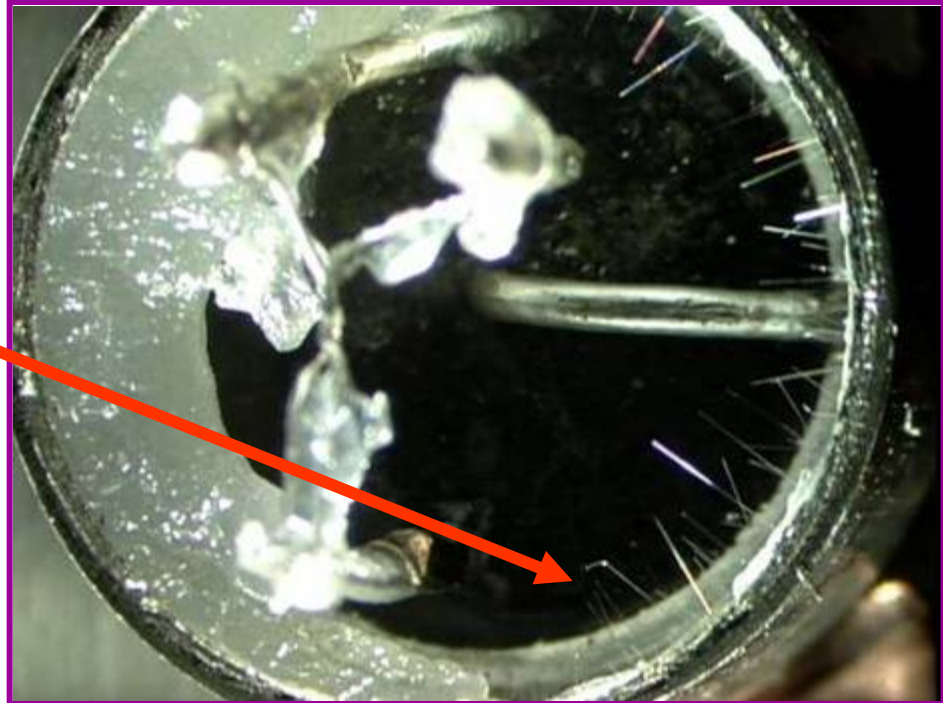

Transistor Package is Tin-Plated Inside.
Many Vintage Radio Malfunctions Have Been
Attributed to Whiskers Shunting Case to Terminals

<http://www.vintage-radio.net/forum/showthread.php?t=5058>



“There is a name for those who suppose that doing the same thing will produce different results.

*That name is ‘**Idiot**’.”*

- Albert Einstein

Metal Whiskers

“The Early Years”

- **1946:**
H. Cobb (Aircraft Radio Corp.) publishes earliest “known” account of CADMIUM whiskers inducing electrical shorting between plates of air capacitors used in military equipment. These events occurred during World War II (~1942 – 1943)
- **1952:**
Since Cadmium coatings resulted in shorting, Tin and Zinc were used instead. But then K.G. Compton, A. Mendizza, and S.M. Arnold (Bell Labs) reported shorting caused by whiskers from these coatings too!

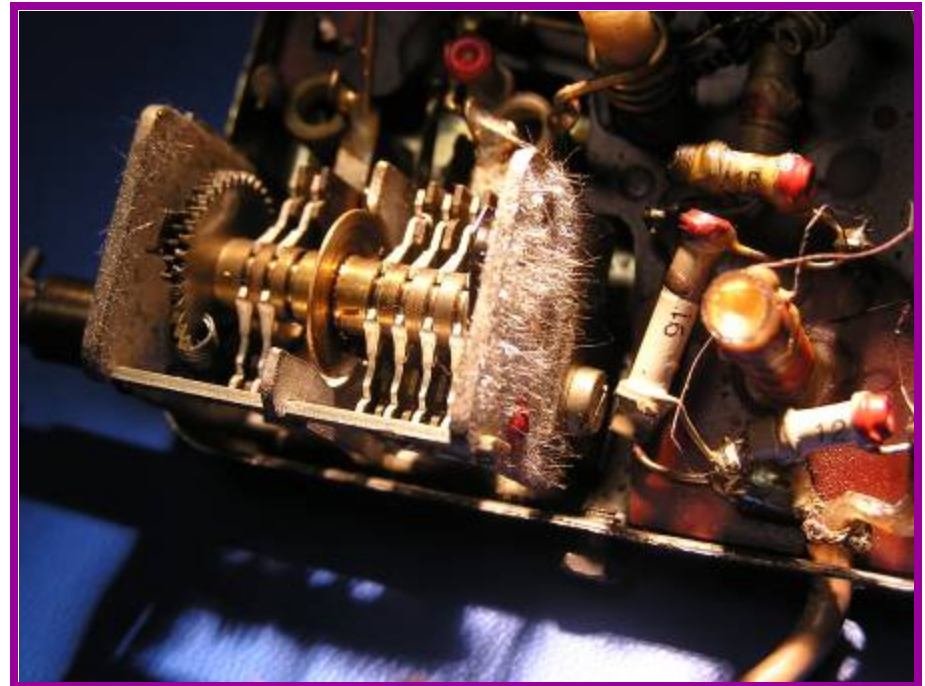

*Tin Whiskers on 1960's Era
Variable Air Capacitor*

Whisker Resistant Metal Coatings

“The Quest”

- **1950s and 60’s** ^[1] ^[2]:
Bell Labs worked through the periodic table to determine whether addition of some element to a Tin coating would “quench” whiskering
 - *Adding 0.5 - 1% (by weight) of lead (Pb) works*
 - *Some additives seem to enhance whiskering*
- **Since 1990s:**
Most US MIL specs require adding Pb to any tin coatings used around electronics.
 - Concentration is usually named as 2% to 3% Pb by weight for “margin”
- **What additives quench zinc and cadmium whiskers?**
 - We don’t know, but certainly NOT chromate conversion finishes!

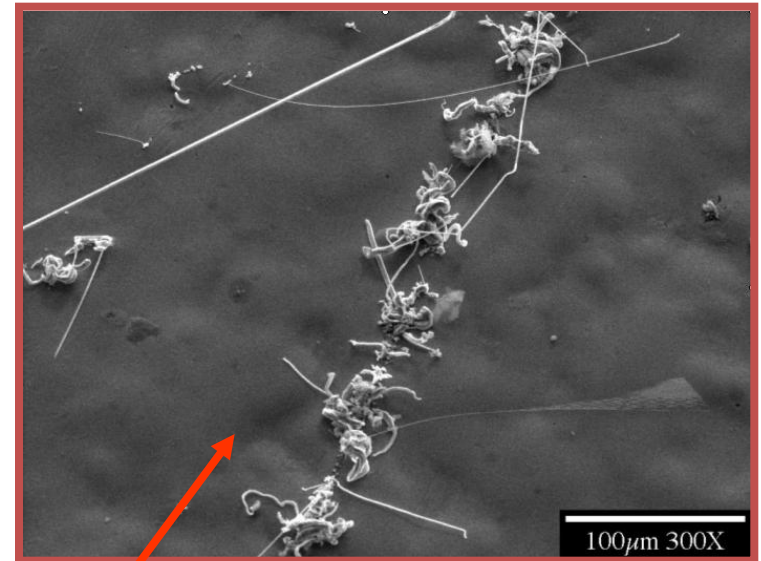

*Zinc Whiskers Growing from
Zinc-Plated Yellow Chromate Steel Bus Rail*

[1] S. Arnold, "Repressing the Growth of Tin Whiskers," *Plating*, vol. 53, pp. 96-99, 1966

[2] P. Key, "Surface Morphology of Whisker Crystals of Tin, Zinc and Cadmium," *IEEE Electronic Components Conference*, pp. 155-160, May, 1970

A Case for Whisker Mitigation Strategies?

Tin Whiskers on Tin-Plated Axial Leaded Diodes

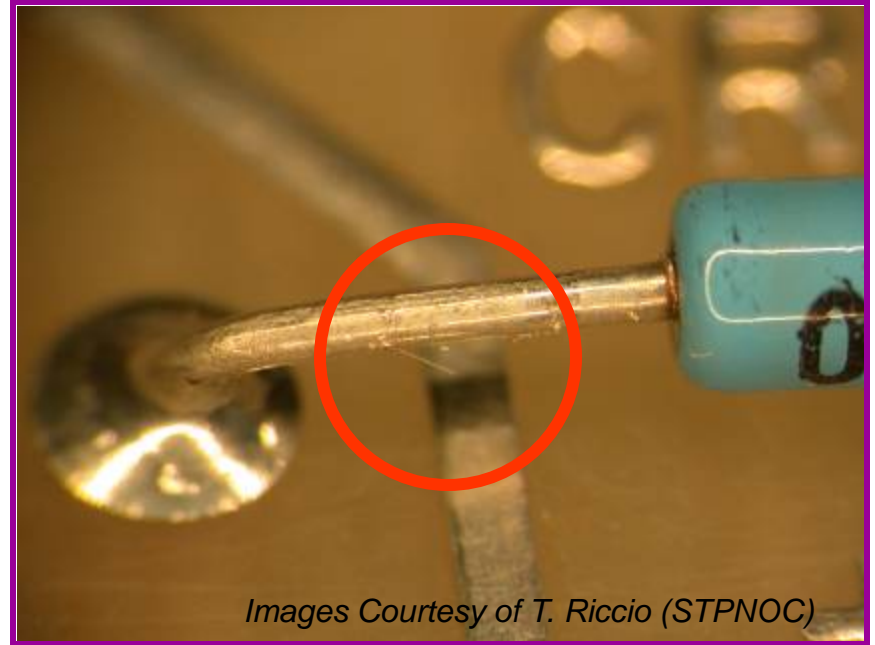
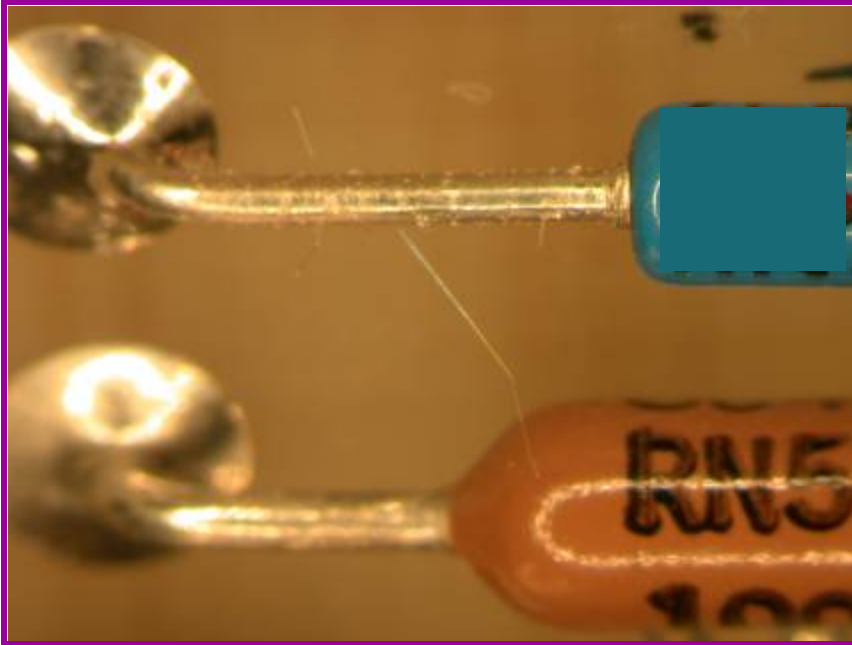

- PWB and components were NOT Conformal Coated
- Diode Leads were NOT Hot Solder Dipped



Three Whisker Mitigation Strategies

Mitigation – to make less severe or painful
Merriam-Webster Dictionary

Risk “Mitigation” \neq Risk “Elimination”

- Avoid Use of Whisker Prone Surface Finishes
 - Perform independent materials composition analysis
 - *“Trust, But VERIFY!”* using X-ray Fluorescence (XRF), Energy Dispersive X-ray Spectroscopy (EDS), et al
- Conformal Coat
 - Can slow whisker growth
 - Can block whiskers from electrically shunting distant conductors
- Remove/Replace Tin Finishes When Practical
 - Hot Solder Dip using lead-tin (Pb-Sn) solders
 - “First Do No Harm” Principle

Remarkable Similarity Between Tin, Zinc, and Cadmium Whisker Growth



Noted even back in 1970s during Bell Labs research [1], whiskers observed on tin, zinc, and cadmium had a lot of similarities:

- Either straight or with distinct kinks connecting straight segments
- Lengths vary widely over 4 orders of magnitude
- Grow over time
- Contain striations (although Key also noted smooth whisker shafts)
- No material depletion observed around the base of whisker
- No correlation between whisker length and thickness

[1] P.L. Key, "Surface Morphology of Whisker Crystals of Tin, Zinc and Cadmium," *IEEE Electronic Components Conference*, pp. 155-157, May, 1970 or 1977

Tin, Zinc, Cadmium – Whisker Family Album



Sn whisker



Cd whisker



Zn whisker

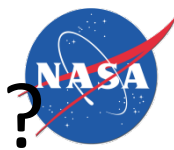

What we do know about whisker growth?

1. Long-range diffusion of atoms of the surface metal supplies material for whisker growth.
 - Normally, no depletion of material observed in vicinity of whisker growth.
 - Whiskers demonstrated to be made of atoms supplied from long distances [radioisotope experiments by Kethner and Kadereit in 1970 and Woodrow in 2006].
2. THEN A MIRACLE OCCURS to initiate whisker growth.
3. Whisker grows outwards from the surface.
 - Addition of material at the base.
 - Whisker growth varies from surface to surface and from whisker to whisker.

Diffusion of Tin

In a polycrystal, individual atoms may diffuse via

- Bulk diffusion – movement of atoms through the grains. Dominates at higher temperatures.
- Grain boundary diffusion – movement of atoms through the grain boundaries between the grains. Dominates at lower temperatures.

At room temperature, grain boundary diffusion dominates in tin

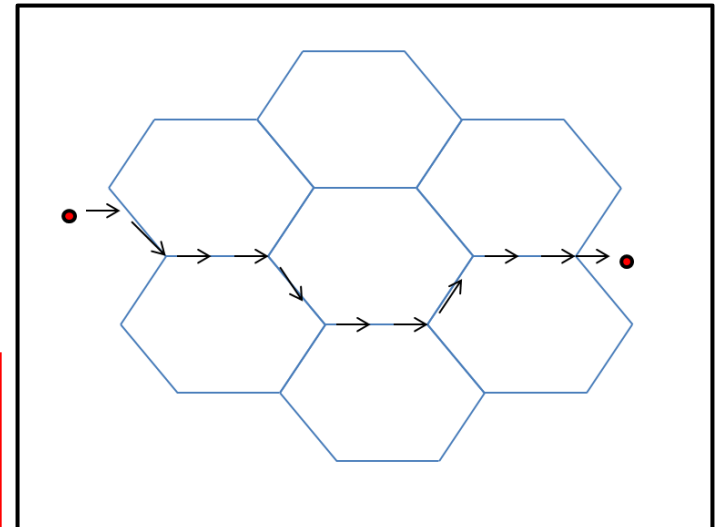
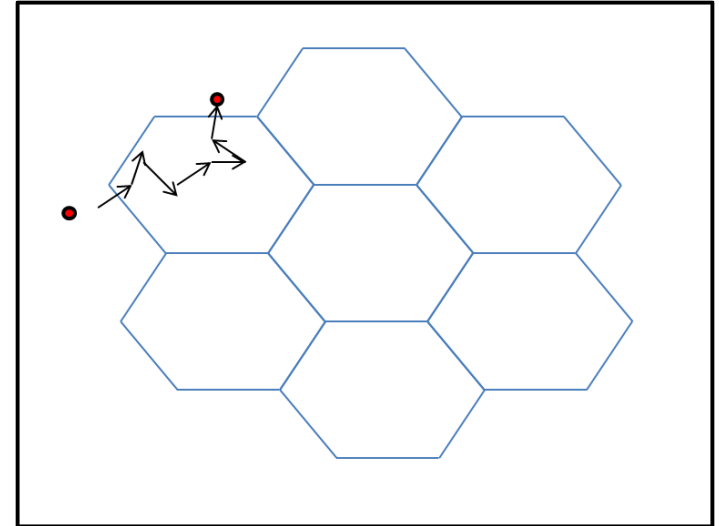

Grain Boundary Diffusion – Illustration via Ferrofluid in Soap Bubbles

Video Source: Kim Pimmel <http://vimeo.com/28304264>

COMPRESSED 02
ANALOG GENERATIVE EXPERIMENTS

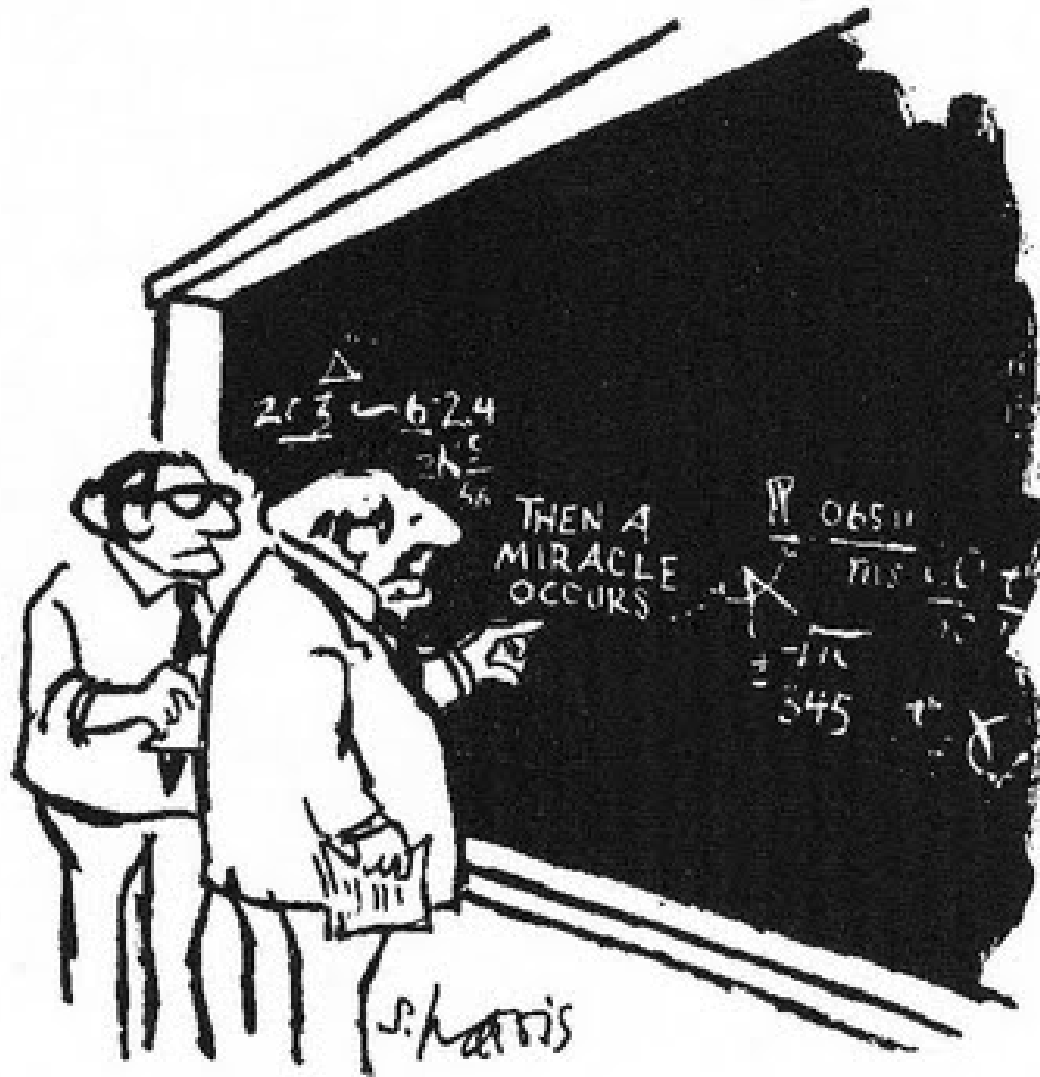

"I think you should be more explicit here in step two."



The Miracle of Whisker Initiation

All of these theories were proposed back in 1950s and 1960s.
No clear proof yet exists for any of them.

Stress?

Dislocations?

Entropy?

Recrystallization?

Impurities?

Inclusions?

Whiskers are making a mockery of 60 years of research.

Whisker Growth

- Variations in incubation (minutes to years)
- Variations in growth rate
 - Largely unstudied
 - As fast as 15nm/s observed [1]
 - Typically cited as 0.1Å/s [2]
- Whisker attributes:
 - Typically exhibit striations along the whisker length
 - Not uncommon to find circumferential rings around the whisker
 - Shapes vary from straight, kinked, curved, branched, and odd-shaped eruptions
- Each whisker is one out of a population
 - 1 in a million grains on the surface may develop a whisker
 - Population of whiskers will have a distribution of length, thickness, density

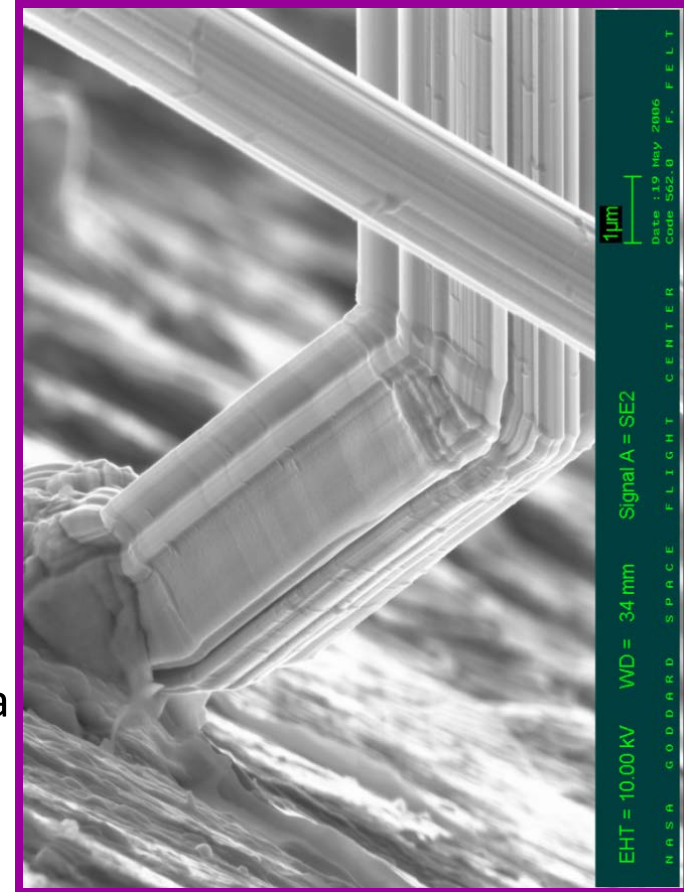

[1] http://www.calce.umd.edu/tin-whiskers/whisker_movie_12min.html

[2] G. Galyon, "A History of Tin Whisker Theory: 1946 to 2004", SMTAI International conference, September 26-30, 2004 (Chicago, IL)

Sn whisker from Sn-Cu plating over Zn

Growth occurred over 9min (displayed here at ~20x the actual speed)

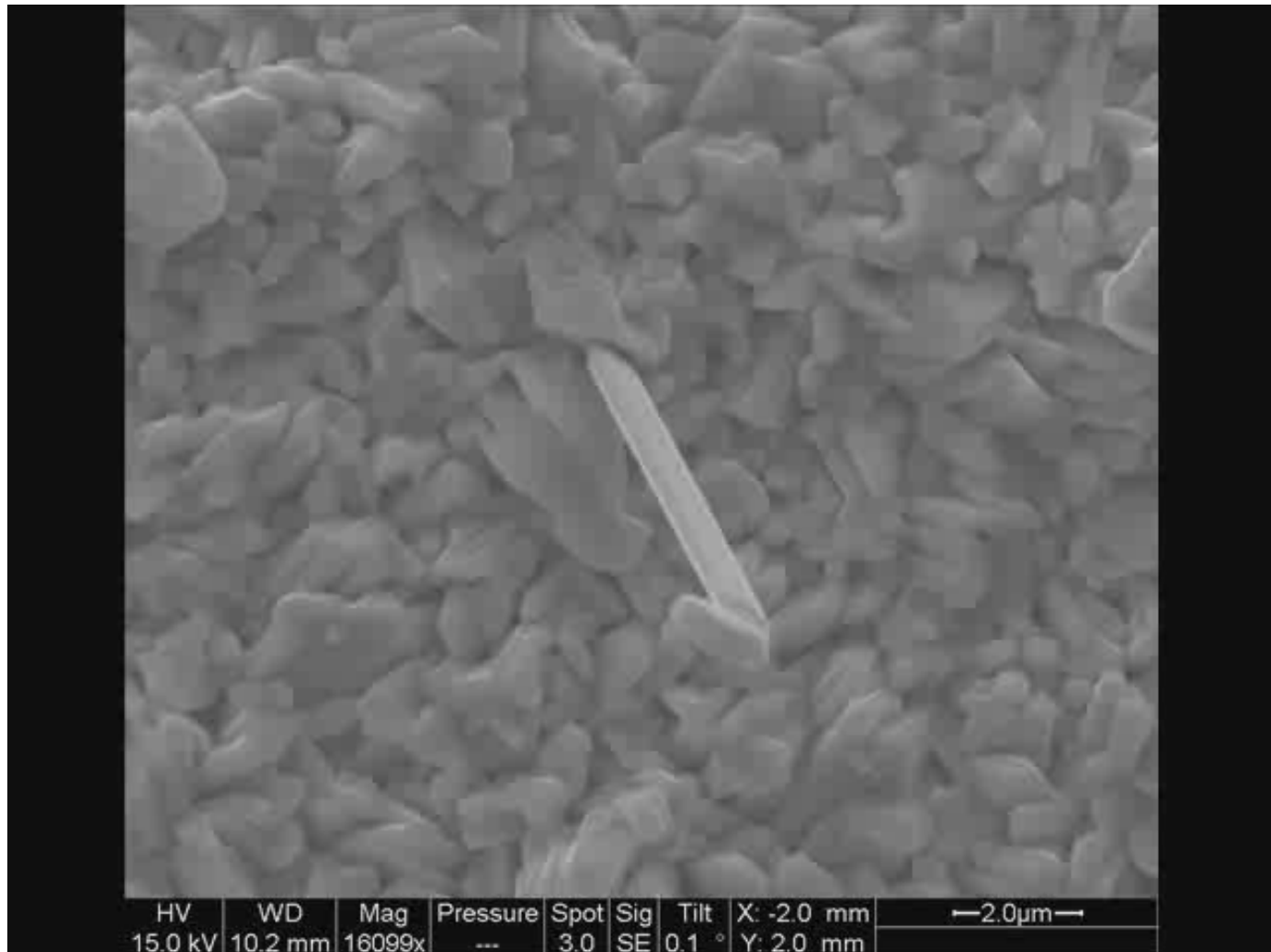

Single Crystals?

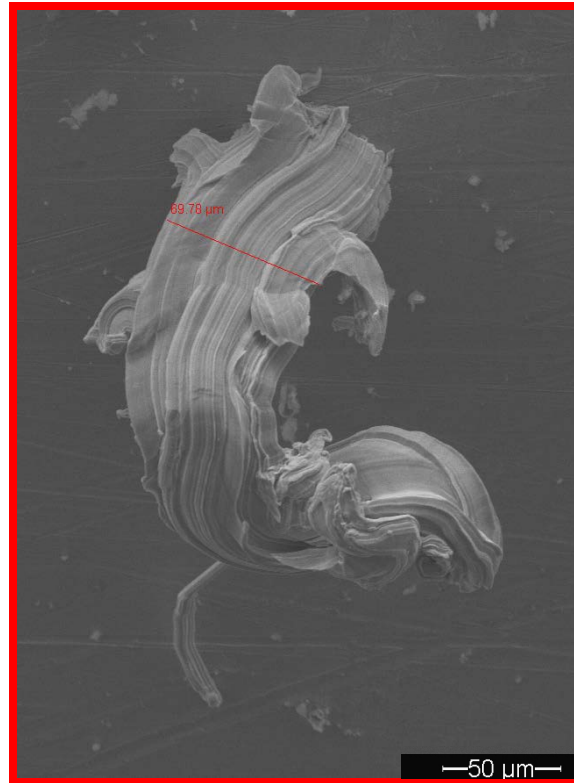

Not Always!

Whisker Growth is Not Exclusively Substrate-Dependent



- Tin deposited on some substrates does appear to aid in whisker growth:
 - Brass (Cu-Zn alloy) substrate under tin in general shows higher whisker propensity. This is primarily linked to the fast diffusion of zinc into tin.
 - Materials with large coefficient of thermal expansion (CTE) mismatches with tin appear to have an effect on whisker growth during temperature cycling.
 - Bulk of literature into whiskers concentrated on tin deposits over copper – with varying results.
- **HOWEVER, whisker growth has been demonstrated when tin is deposited on mica, glass, paper – materials that do not interact with tin. (Bell Labs, Auburn U)**
- Not enough research into cadmium and zinc whiskers to comment on substrate effects.

Sn Whiskers on Semiconductor/Insulator Substrates

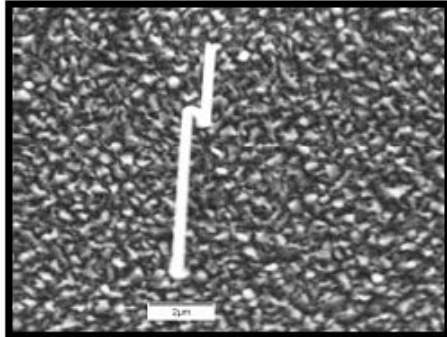

Sn on Si @ 6350X

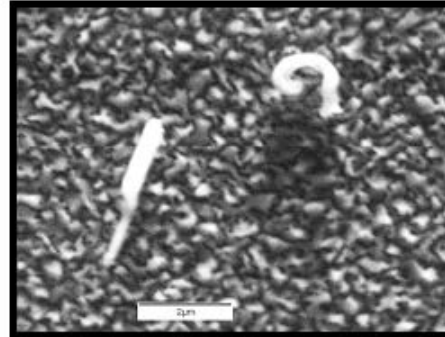

Sn on Glass @ 9050X

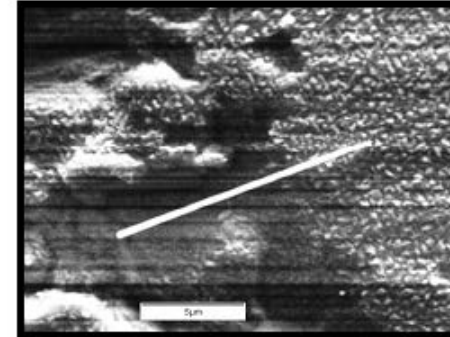

Sn on InAs @ 4020X

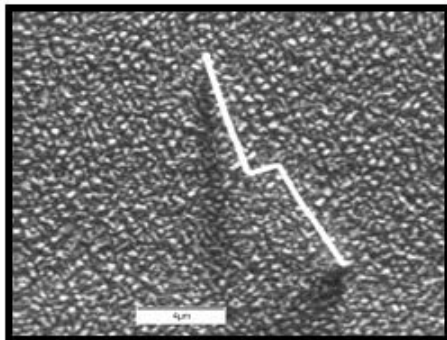

Sn on GaAs @ 4270X

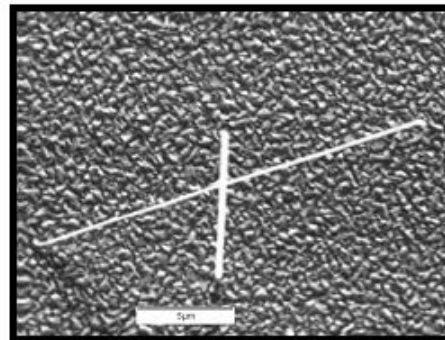

Sn on InP @ 3760X

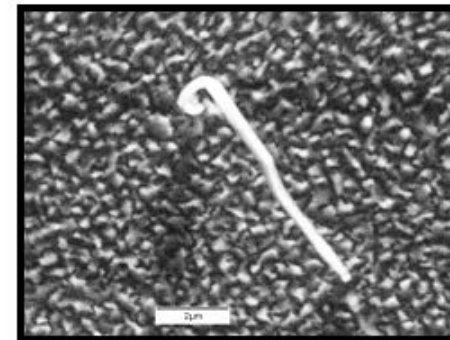

Sn on Ge @ 7100X

cave³

NSF Center for Advanced Vehicle and Extreme Environment Electronics



Why does Pb in Sn work as whisker quencher?

- Pb in Sn is a **mitigation**, not a complete elimination of Sn whiskers. Whiskers may still grow.
- Pb does not affect long-range diffusion of Sn [Woodrow, 2009].
- Thus Pb probably influences the process of whisker initiation.

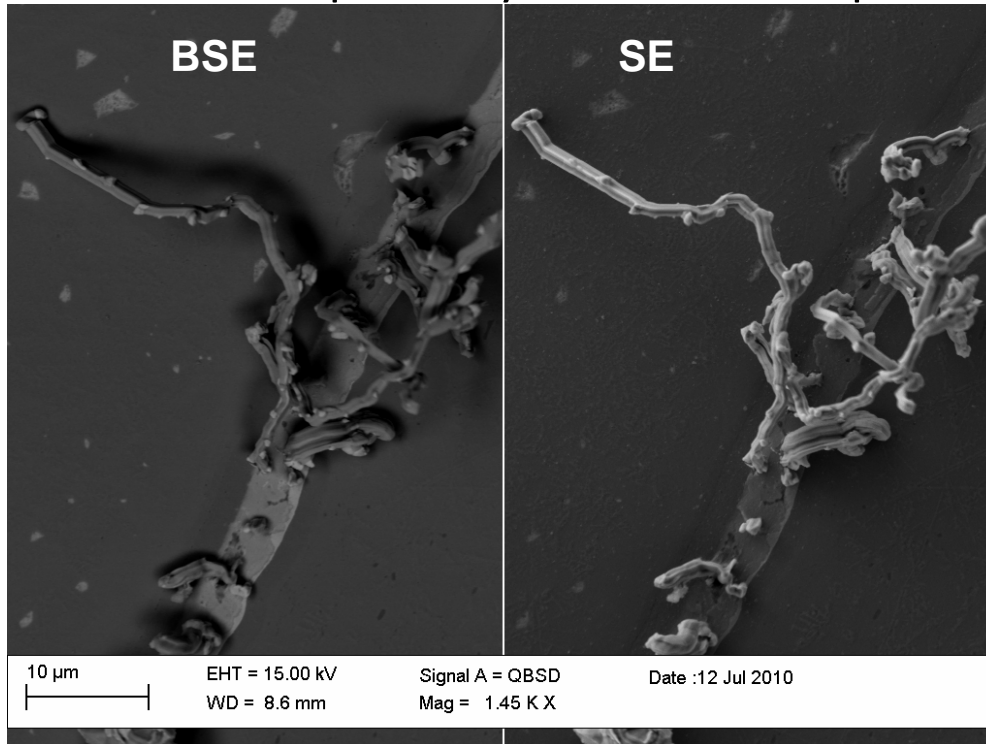

SnPb whiskers growing from SnPb finish in the press-fit connection after polishing.

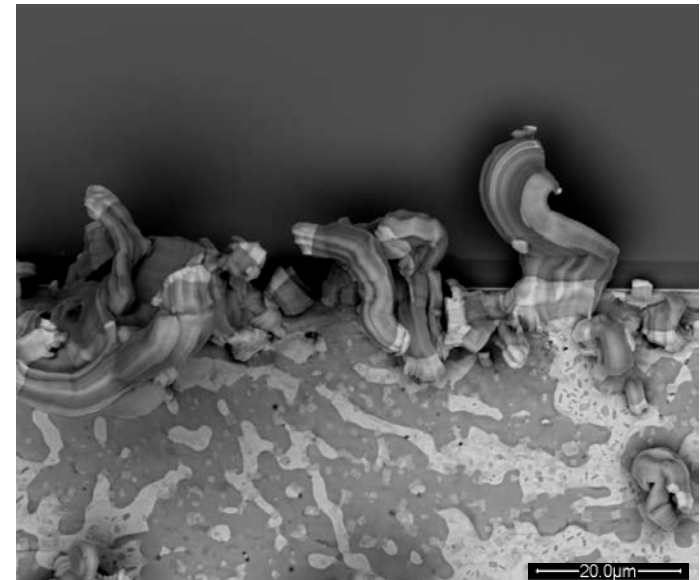

SnPb whisker growing from eutectic SnPb solder attach [failure mode of one of the Laser Diode Arrays in ICESat]

NOT Whiskers: Electrochemical Migration Dendrites

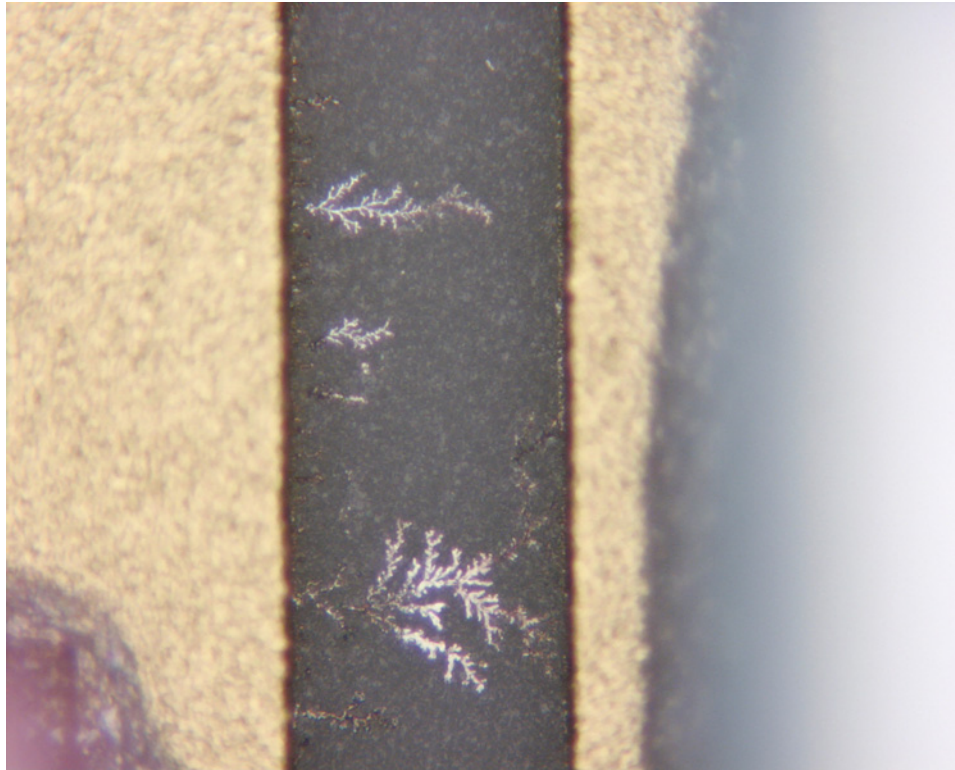
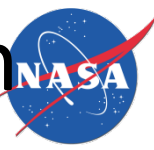

Unlike whiskers, require presence of ionic medium and voltage bias to grow.
These are 2D structures, while whiskers are 3D.

NOT Whiskers: Plating Dendrites

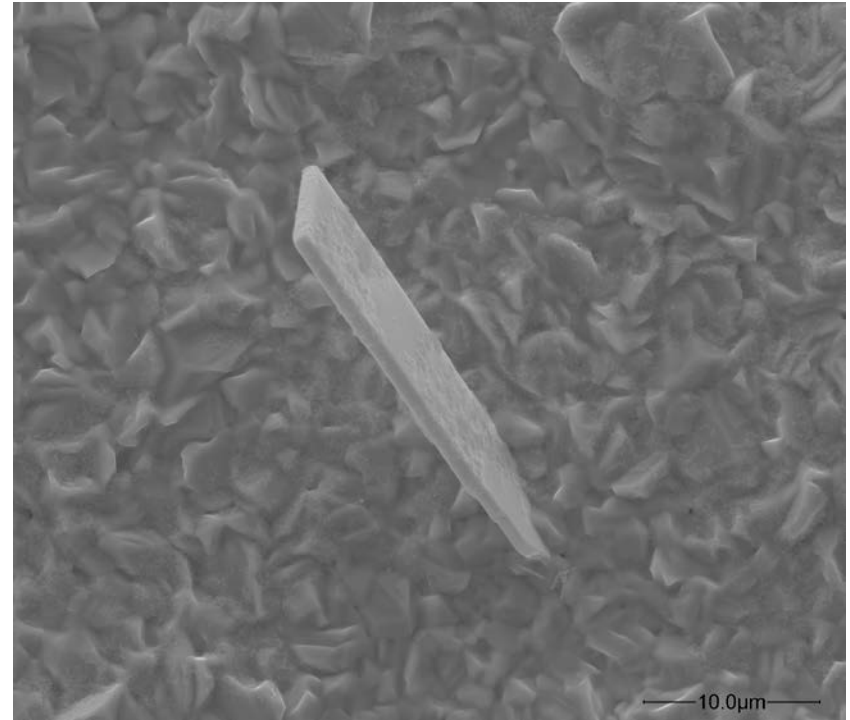
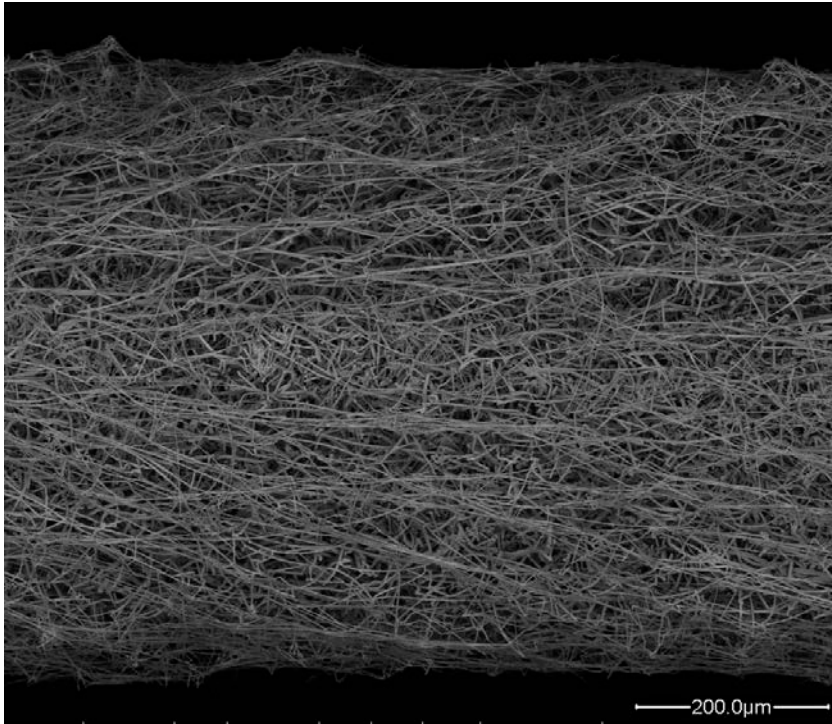

Unlike whiskers, form during electroplating only and do not grow longer with time.
Do not contain characteristic ridges along the length.

NOT Whiskers: Cu-Sn Intermetallic Needles

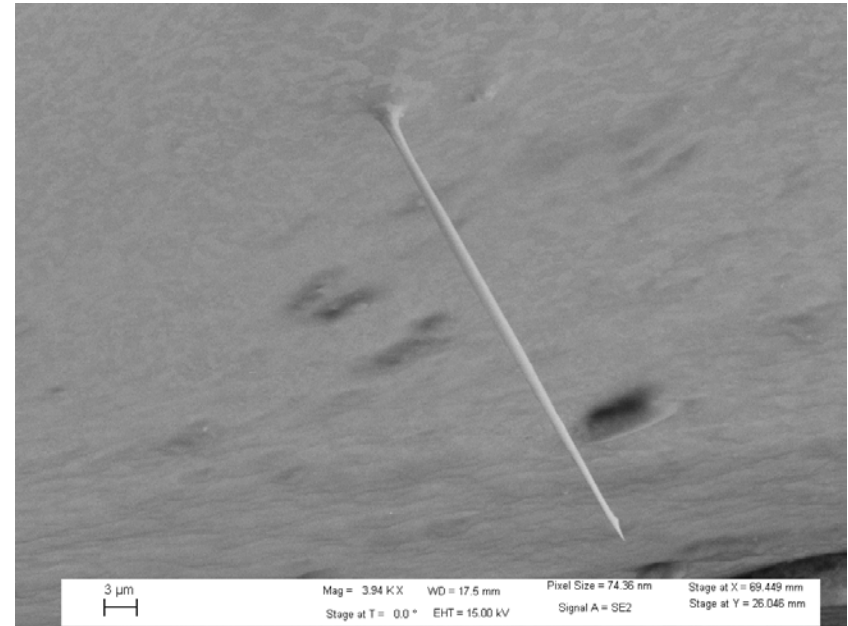
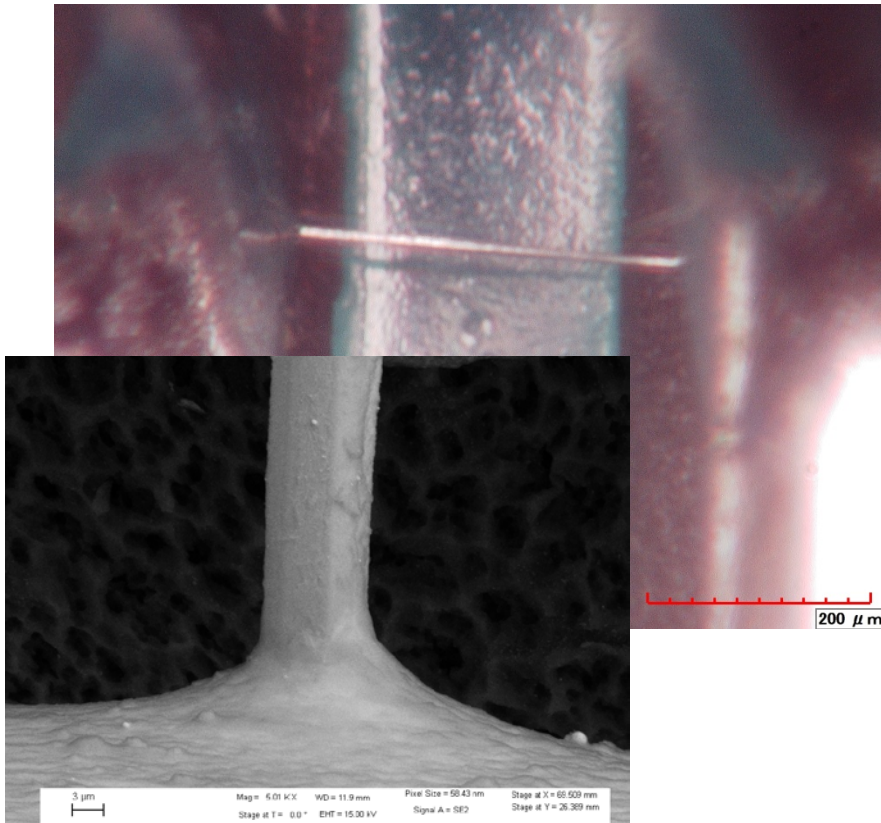

Result of excess Cu in Sn-based solder. Will develop only during soldering or rework – when the solder is molten.
Unlike whiskers, do not grow over time.



Disclaimer

- The material herein is presented “for guidance only”.
- The optical inspection techniques described are NOT guaranteed to detect all metal whiskers. Optical detection of metal whiskers can be hindered by many factors including but not limited to:
 - Operator experience working with actual metal whiskers
 - Dimensions (especially whisker thicknesses) are extremely small and difficult to illuminate
 - Inadequate lighting technique, angle of inspection or magnification
 - Objects adjacent to whiskers may block line of sight and illumination
 - Excessive glare from reflective surfaces can obfuscate whiskers
 - Conformal coatings can produce reflections or haloing
 - Whiskers may be growing INSIDE of packaged devices requiring destructive analysis
 - Operator fatigue from excessive inspection times

A Real Phone Call We Received Circa 2006:



Electronics Technician working in the Aerospace Industry:

“Hi. Today my boss gave me a 3x hand lens and instructed me to look inside a bunch of avionics boxes to see if we have a tin whisker problem.

Will I be able to see any tin whiskers this way?”

Our response went something like:

“Houston, we have a problem!”



Detecting Metal Whiskers: Optical Inspection Tips and Techniques

Generally, there are Three Types of People:

- **Type 1: “The Whisker-Naïve”** ← ~50% of population
“Wait a minute! Are you telling me that I can actually **SEE** metal whiskers without using a Scanning Electron Microscope (SEM)?”
- **Type 2: “The Whisker-Arrogant”** ← ~50% of population
“Hey, I’m a professional. You don’t need to tell me how to use a microscope to see metal whiskers! I could do it blind-folded”
- **Type 3: “The Whisker-Respectful”** ← ~0.1% of population
“Wow.. Those little buggers are really tough to see! However, with lots of practice on actual whiskering specimens using a variety of lighting techniques, varying the angle of inspection, working with low and high magnification, etc., I now at least have a better chance of seeing **SOME ALBEIT NOT ALL** of the whiskers.”

It's Not Always THIS BAD! Nor This Easy to See



VIDEO

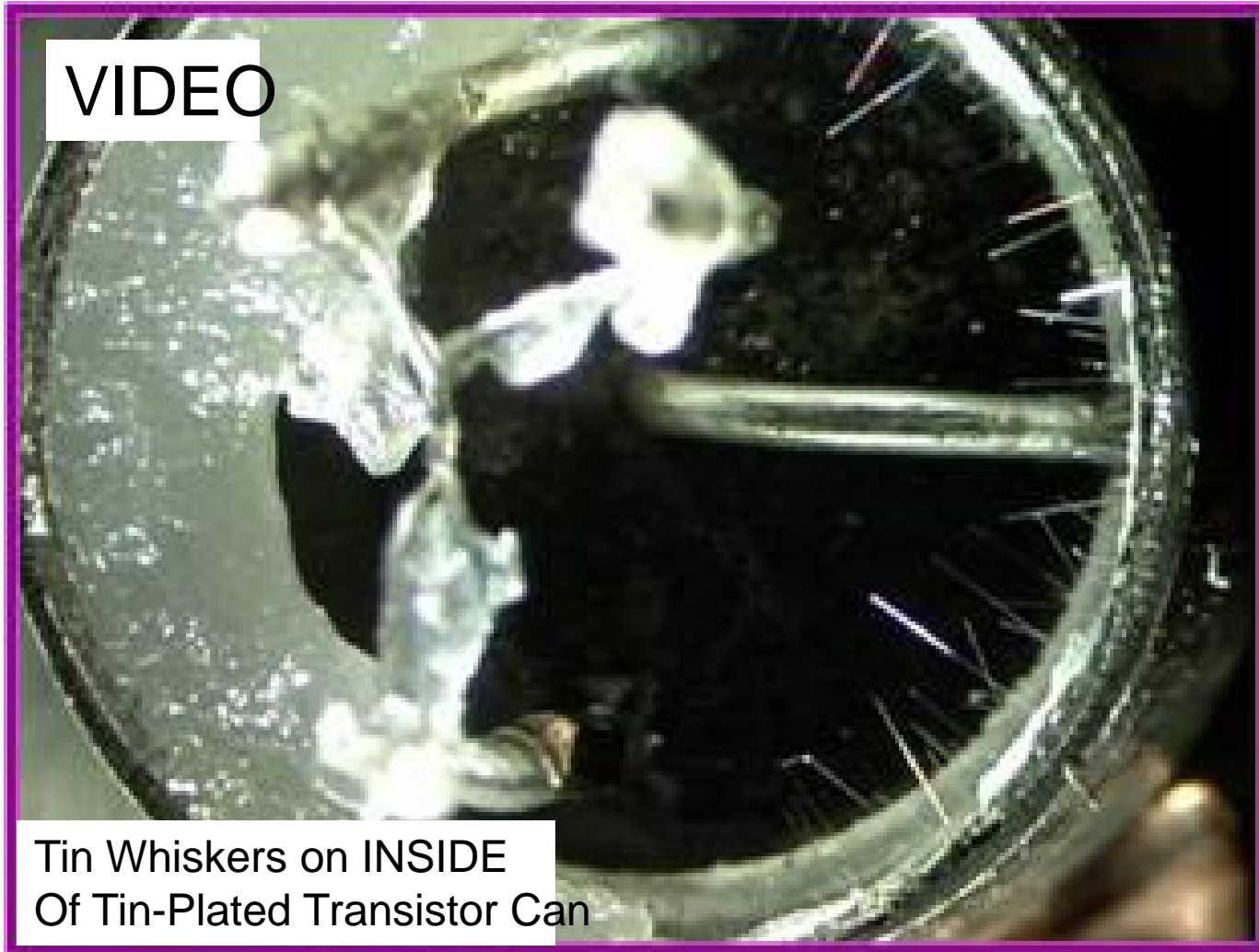

Tin Whiskers on INSIDE
Of Tin-Plated Transistor Can

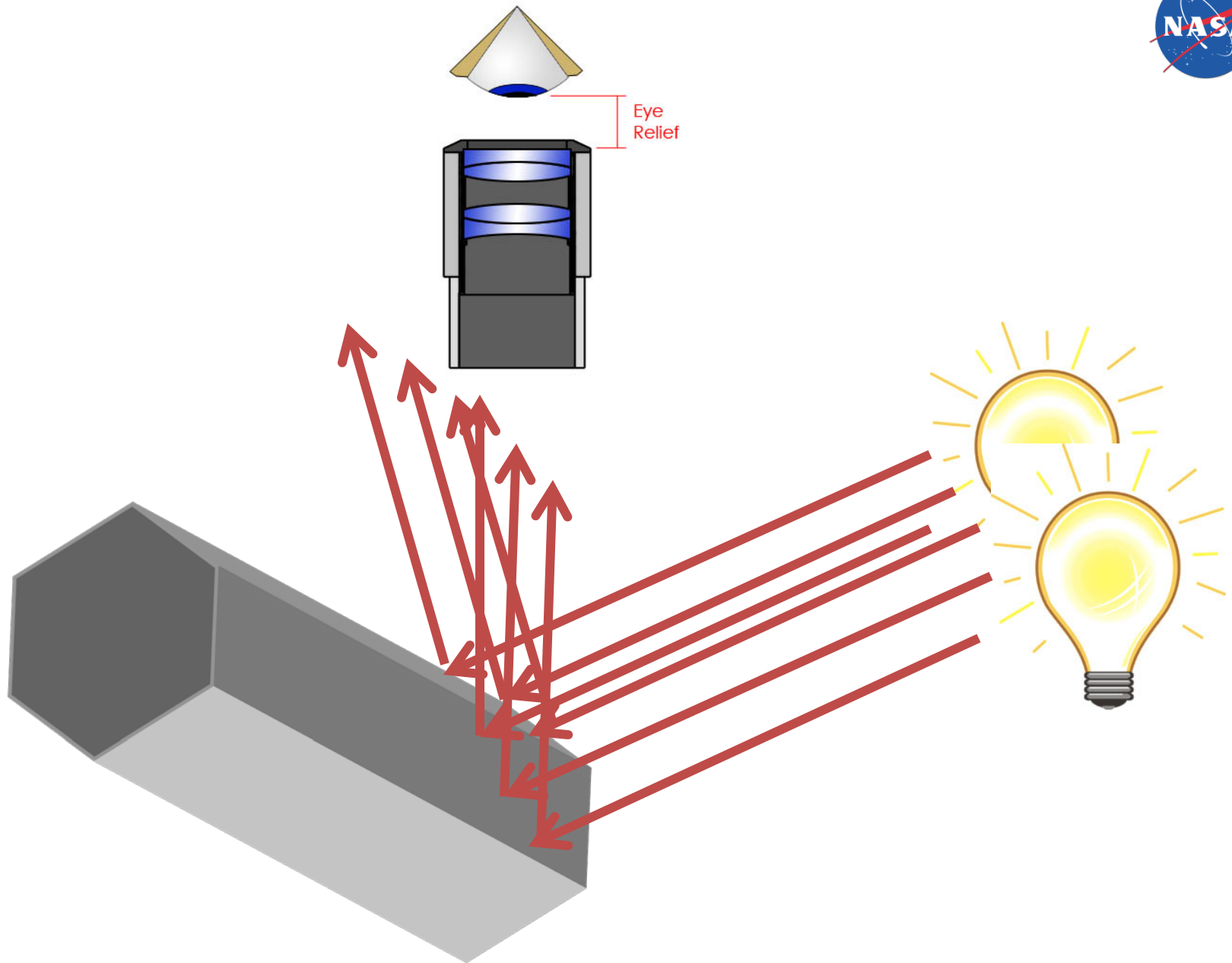



Desirable Capabilities for Optical Inspection for Metal Whiskers

- Microscope
 - Stereo microscope is preferred ← enables better 3D perception
 - Magnification
 - 3x to 100x is a good working range ← Start with low mag, then work to high
 - >100x may be needed for extremely short whiskers (<50 microns)
- Sample Manipulation
 - Ability to tilt the sample (3-axes) to view from various angles
 - Some microscopes come with adapters to enable oblique view and 360° rotation around the axis of the objective lens!
 - Color and reflectivity of the background can enhance/inhibit whisker detection
- Illumination
 - Preferably use FLEXIBLE Lamps NOT Ring Lights
 - Flex light enables varying the angle of illumination which is critical to illuminating the whisker facets at an angle to can be deflected towards the observers eye
 - Ring lights can make whiskers utterly invisible!!!
 - LED or Fiber Optic lighting is preferable over incandescent lamps
 - Provides lighting without shadows from the lamp filament
 - Ability to vary the intensity of light source
 - Can be too bright or too dim

One Example of a Stereo Microscope

Binocular
Eyepieces

Digital Camera to
Record Images &
Video

Focus
Adjustment

Magnification
Adjustment

Ring Light
*NOT Preferred
Lighting Method
For Whiskers*

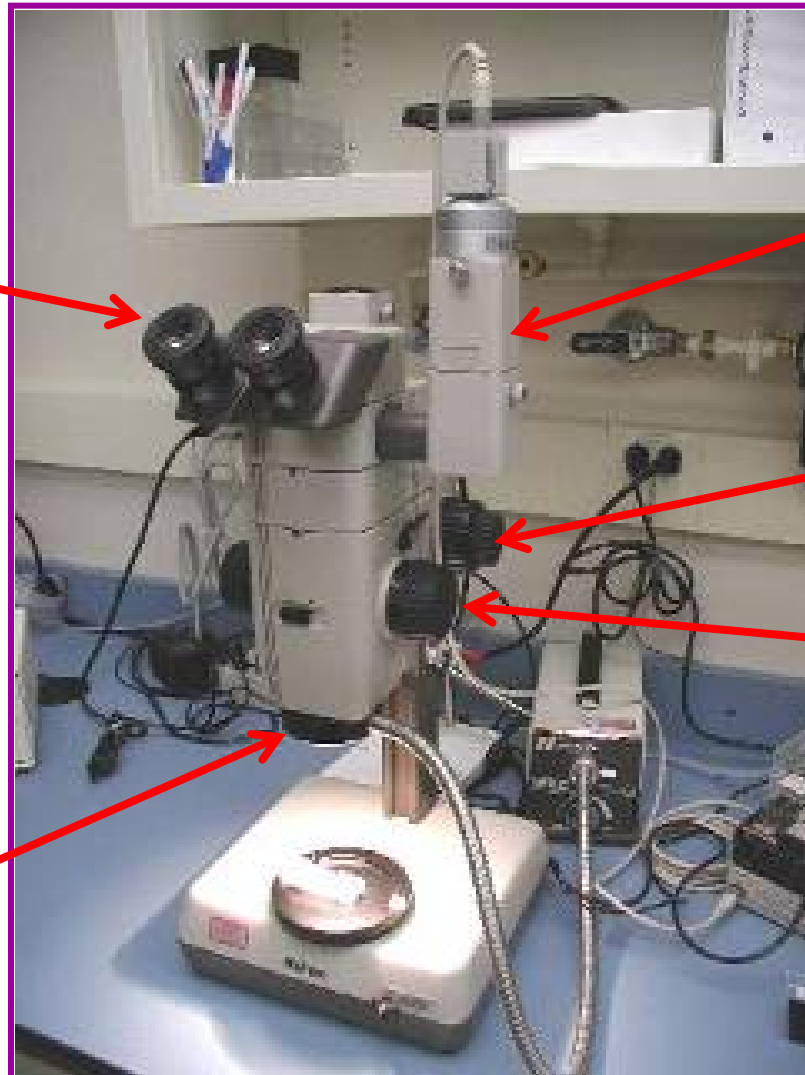

Comparison of Some Lighting Options

Flexible Lighting is generally BEST
Offers ability to vary angle of illumination



Ring Lighting can be HORRIBLE CHOICE
But MOST electronics labs use this type of lighting because it offers uniform lighting to produce shadowless pictures, but this often results in failure to “see” metal whiskers



Demo of Optical Inspection Techniques for Tin Whiskers

Test Specimen: Connector, Plug, Size 3, 25 pin, solder cup
Connector Shell: Tin-plated steel
Contacts: Gold-plated brass
Date of Mfr: Dec. 2004

VIDEO

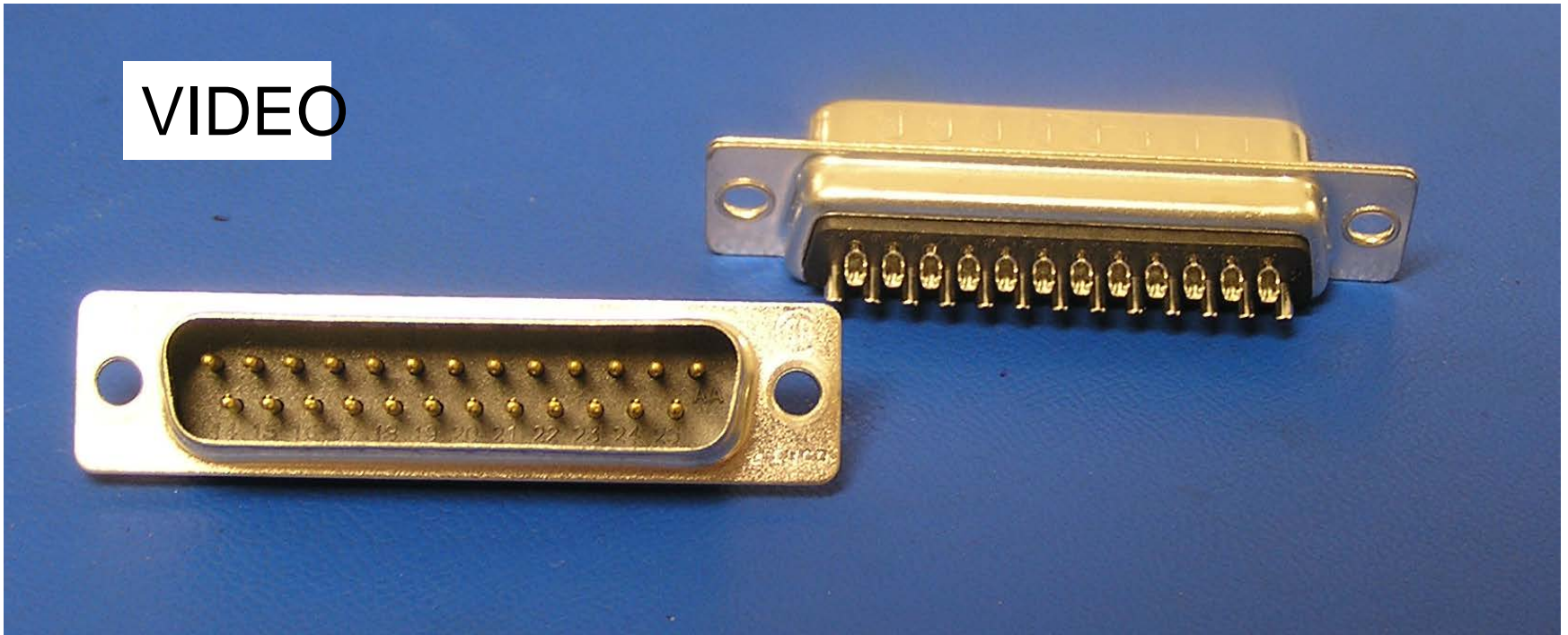

Demo of Optical Inspection Techniques for Tin Whiskers



Lighting Source: RING Light, Fiber Optic

Angle of Illumination: Top Down

Observations: NO WHISKERS!!!
Right???

WRONG ANSWER!



Demo of Optical Inspection Techniques for Tin Whiskers

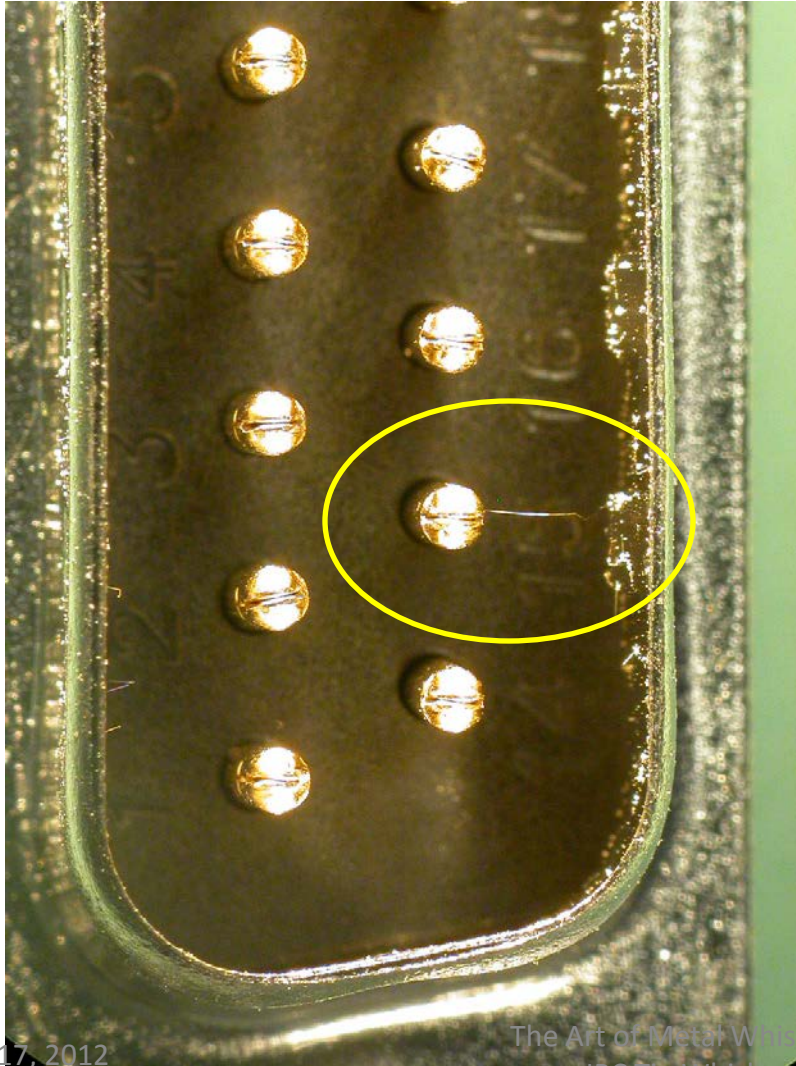

Lighting Source: Flex Light, Fiber Optic
Angle of Illumination: Low Angle Illumination
Observations: Tin Whisker Bridging from Shell to Pin 15

Absence of Evidence

DOES NOT Equal Evidence of Absence!!!

Where are the Whiskers?
Top Down Lighting

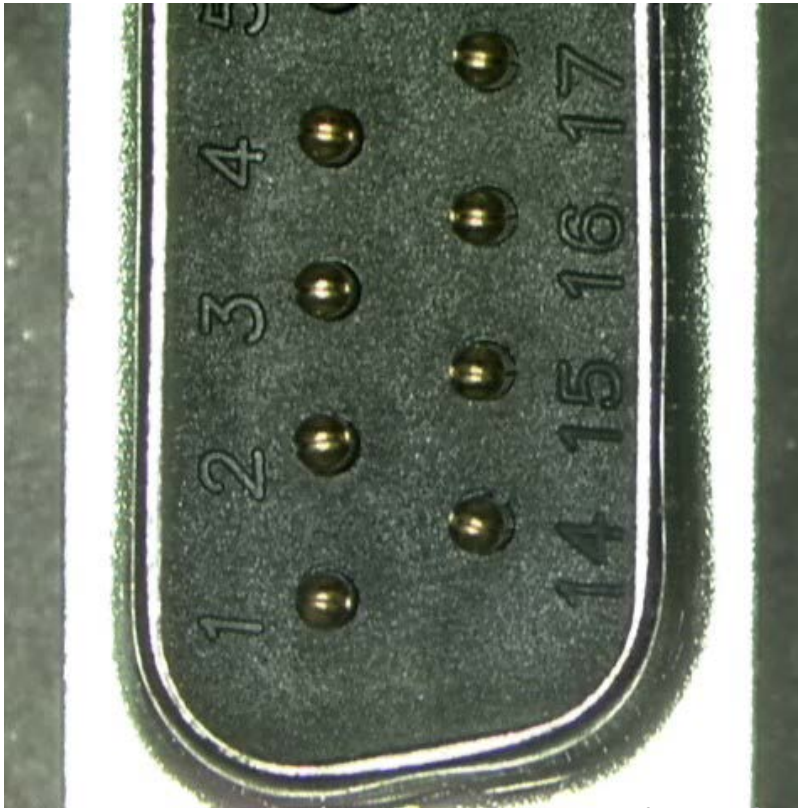

There's One!
Low Angle Lighting

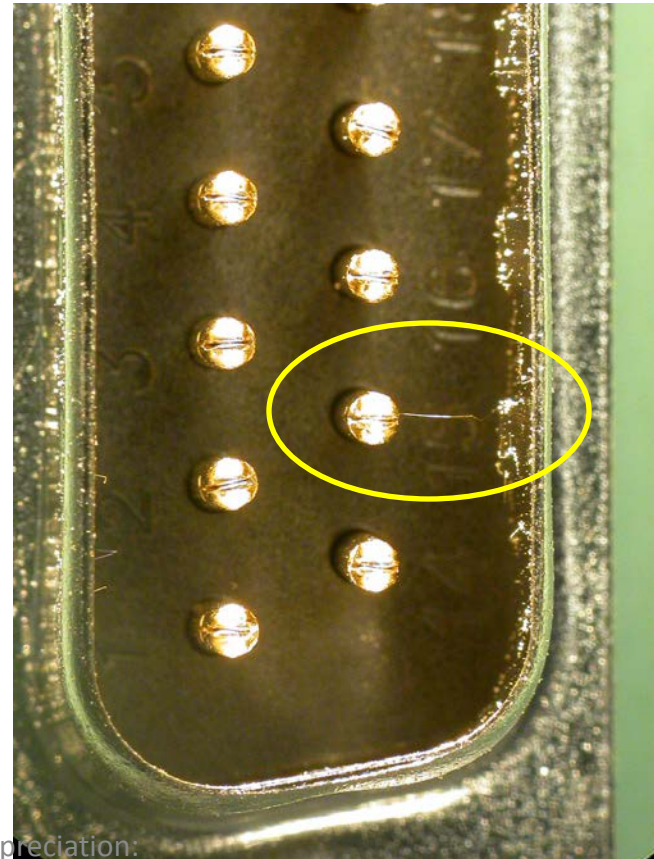



And There are Actually TWO Different Tin Whiskers Bridging From Shell to Pin 15 and Pin 19

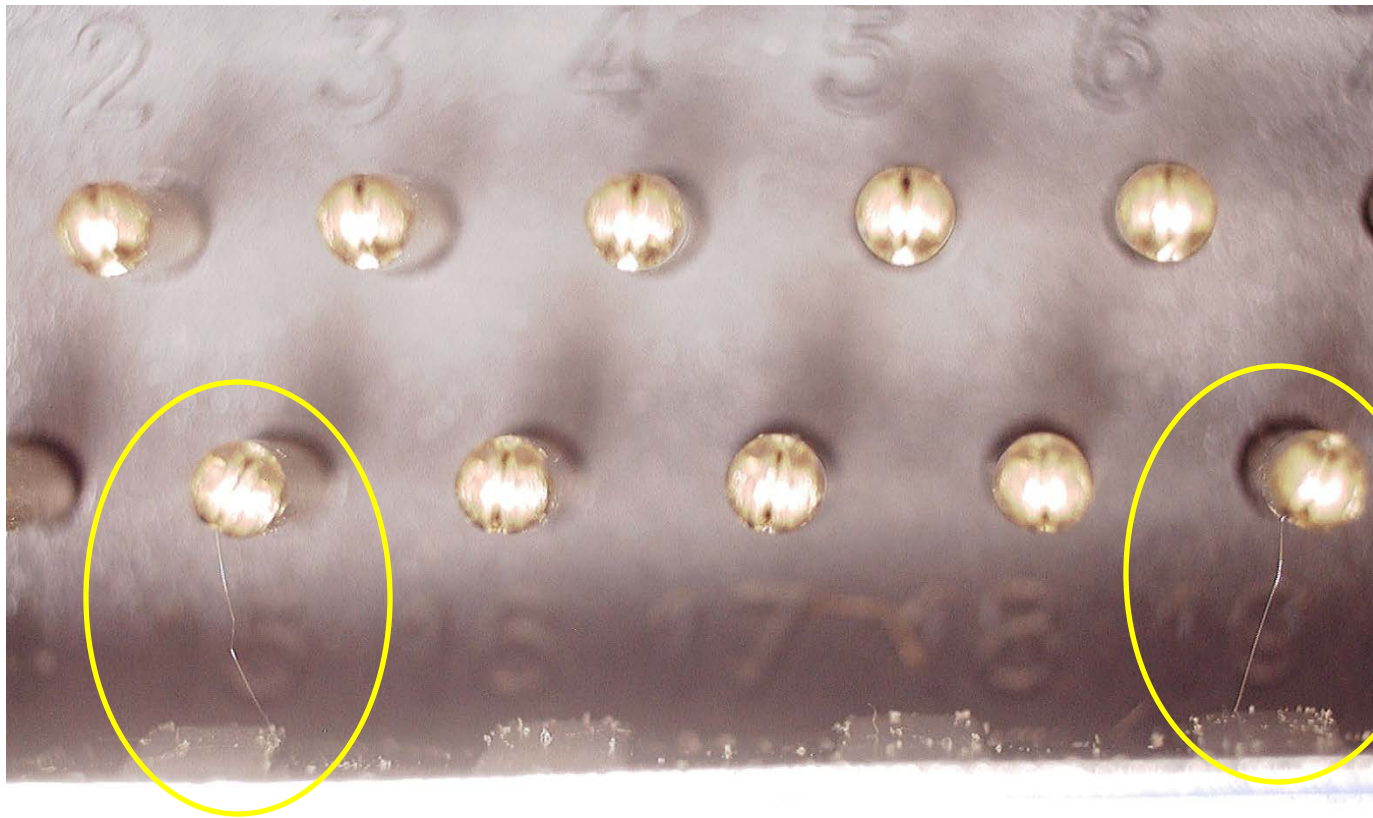

Pop Quiz:

Do ZINC Coatings Grow Metal Whiskers?

Dsub Connectors
with Zinc-Plated Shells



Yes!
Sadly, This Looks All Too Familiar

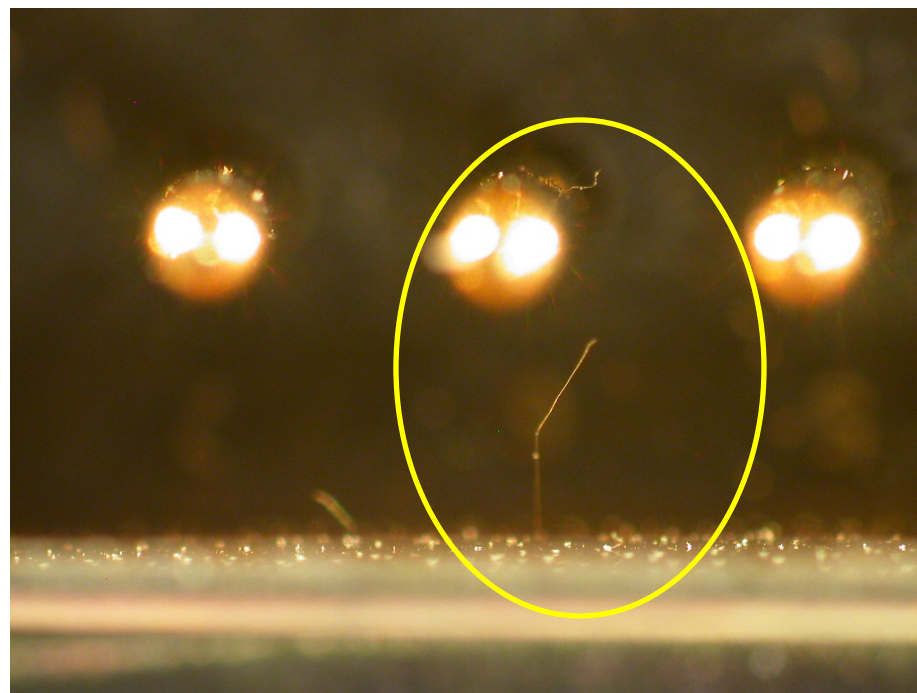

Evidence of “Absence of Whiskers”? (Optical Microscopy)

Tin-Plated Lock Washer

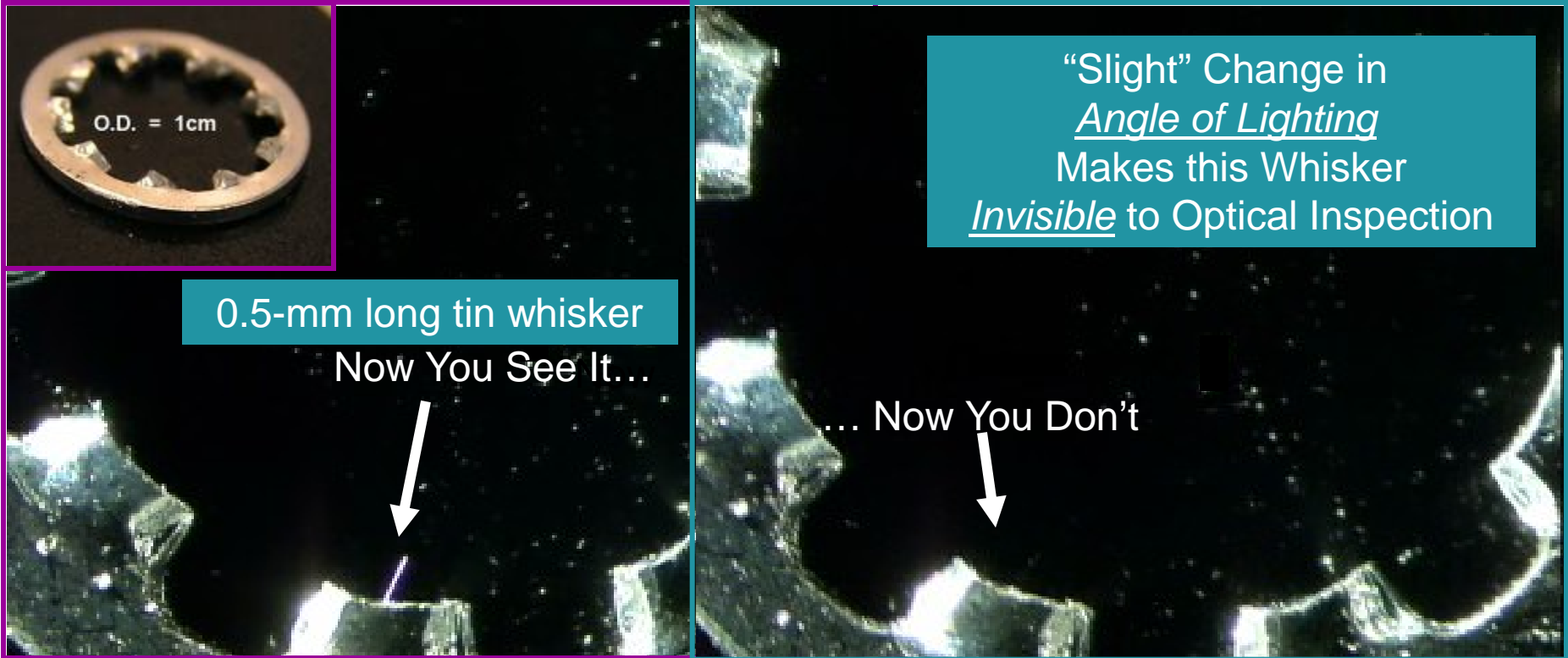

The absence of evidence is NOT evidence of absence

Video Demonstration

Optical Inspection For Metal Whiskers

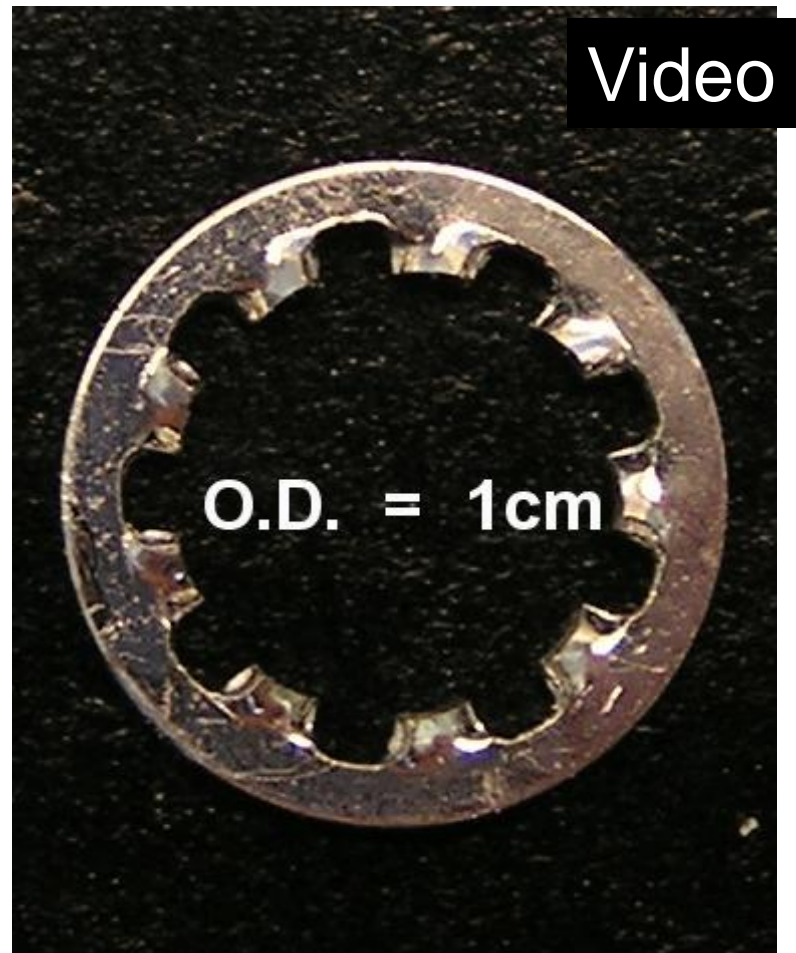



Whisker Statistics

- No two samples with whiskers are ever alike!
- There are variations in whisker length, thickness, density(#/area).
- Studying these parameters, researchers commonly find that:
 - Whisker lengths follow lognormal distribution and span between several μm to over 2cm.
 - Whisker thicknesses follow lognormal distribution, and for tin whiskers are commonly between $0.5\mu\text{m}$ and $10\mu\text{m}$.
 - Whisker densities follow normal distribution and have been shown to span 8 orders of magnitude.
- Knowing these parameters becomes important when evaluating the risk of a whisker causing trouble

Variations in Whisker Density (# of whiskers per Area)

Very High Density of Zinc Whiskers

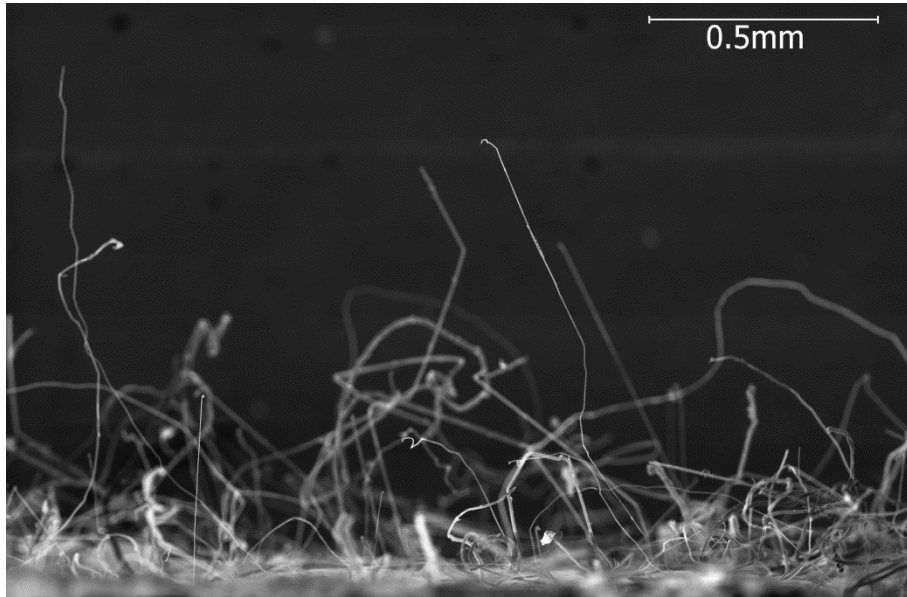

Very Low Density of Tin Whiskers

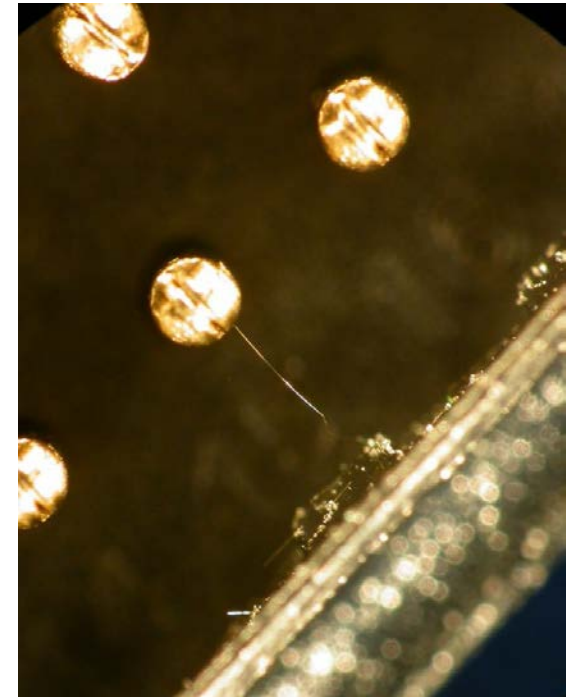

Variations from 10^{-5} to 10^3 whiskers/mm² recorded

That's eight (8) orders of magnitude difference

Tin-Plated Beryllium Copper Card Guides

~19 Year Old Space Shuttle Hardware

Tin Whiskers up to 25mm long were observed!!!

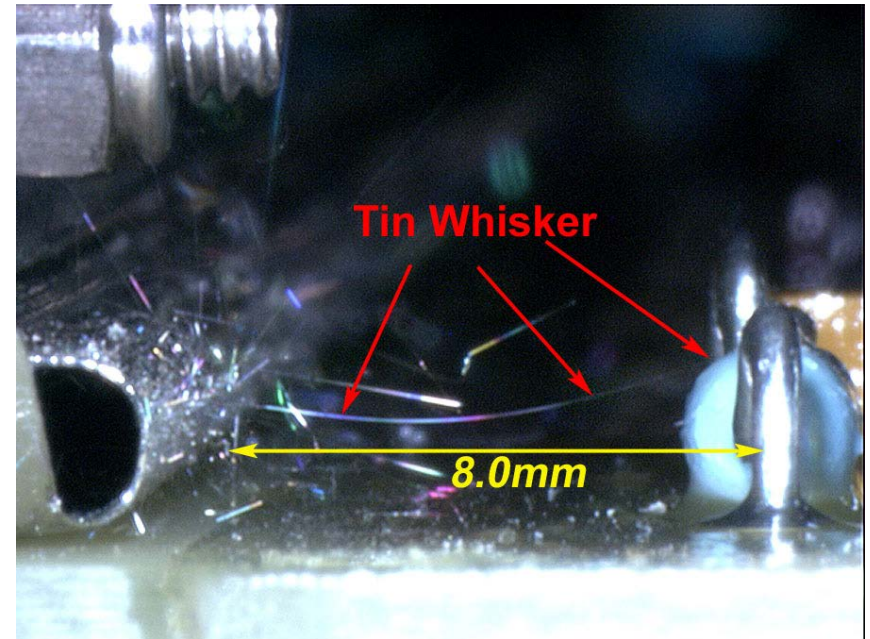
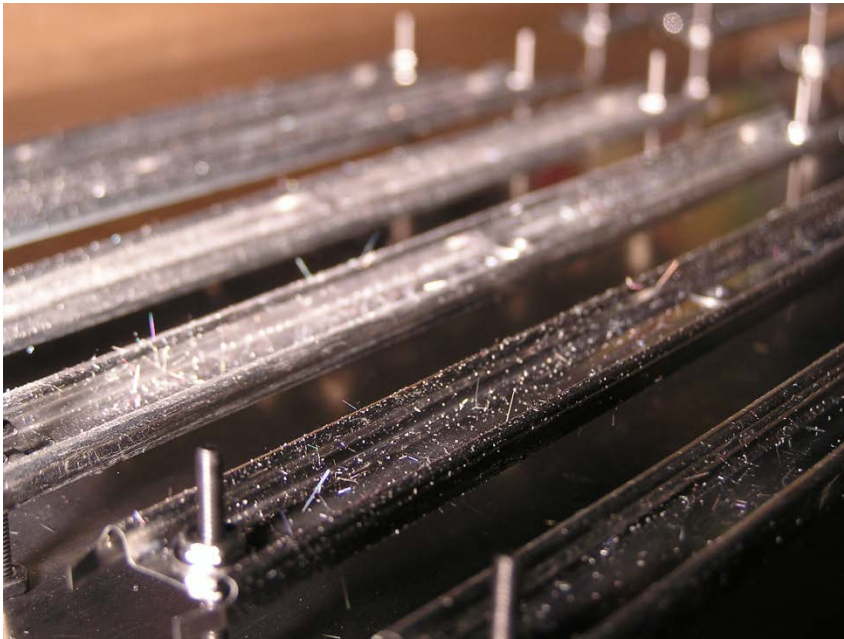

Zinc Whiskers on Hot-Dip Galvanized Pipe: Variations in Thicknesses

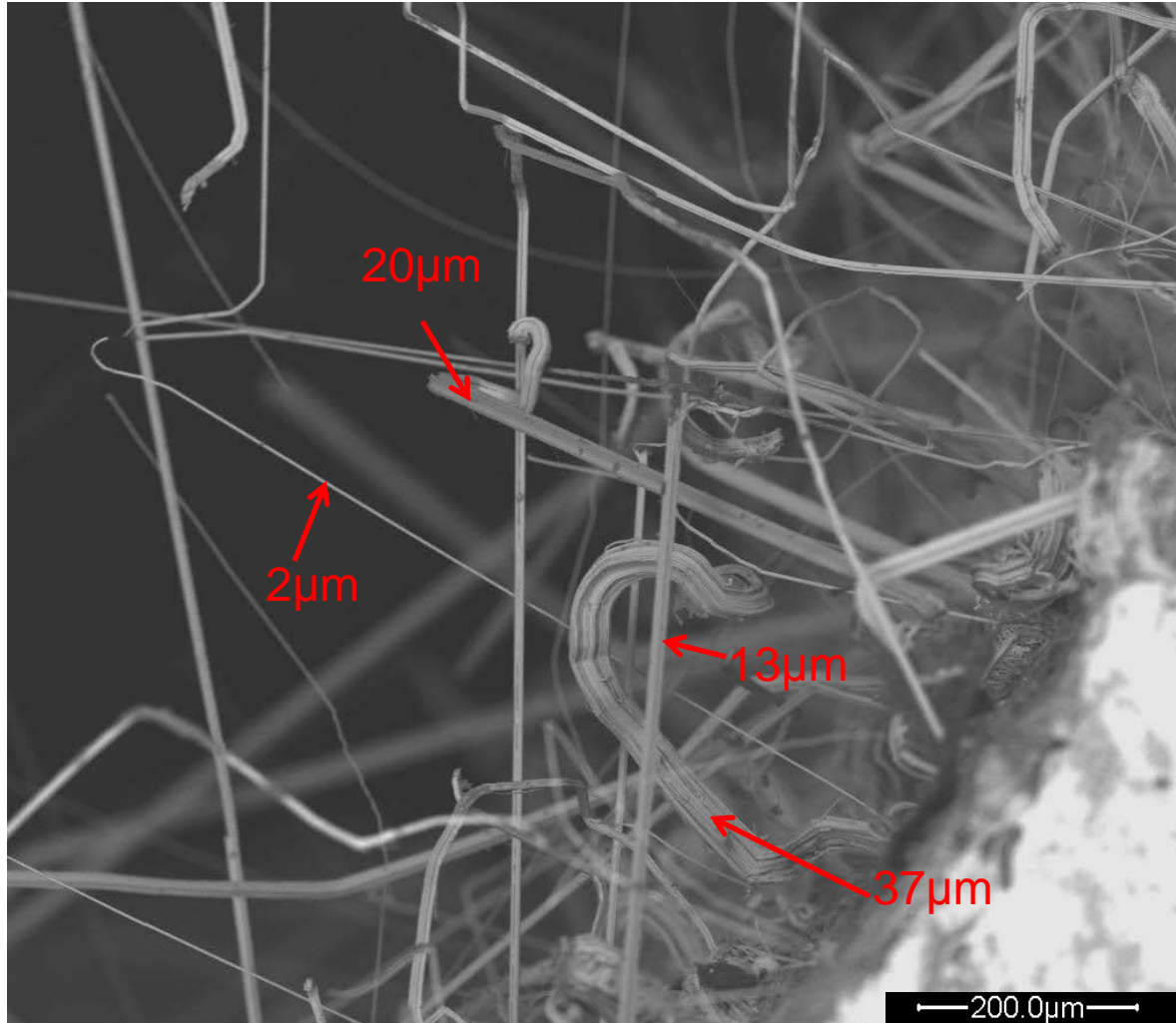

The Erroneous Quest for the “Longest Whisker”



- Whiskers typically represent large populations.
Thousands or even millions of whiskers of various length on a given sample.
- By selecting several whiskers to measure, we are limiting the chances of actually finding the longest one on the surface.
- Thus, a much more meaningful approach is to select a statistically significant number of whiskers to measure and create a distribution.
- From the distribution, it is possible to approximate the probability that a whisker of a certain length exists on the surface.
- Statistical distributions do not contain a ‘longest whisker’. Instead, the probability of existence for a very long whisker is lower.



Example of Tin Whisker Length and Thickness Distributions

Collected for 187 whiskers on tin-plated brass that grew over 11 years of ambient storage

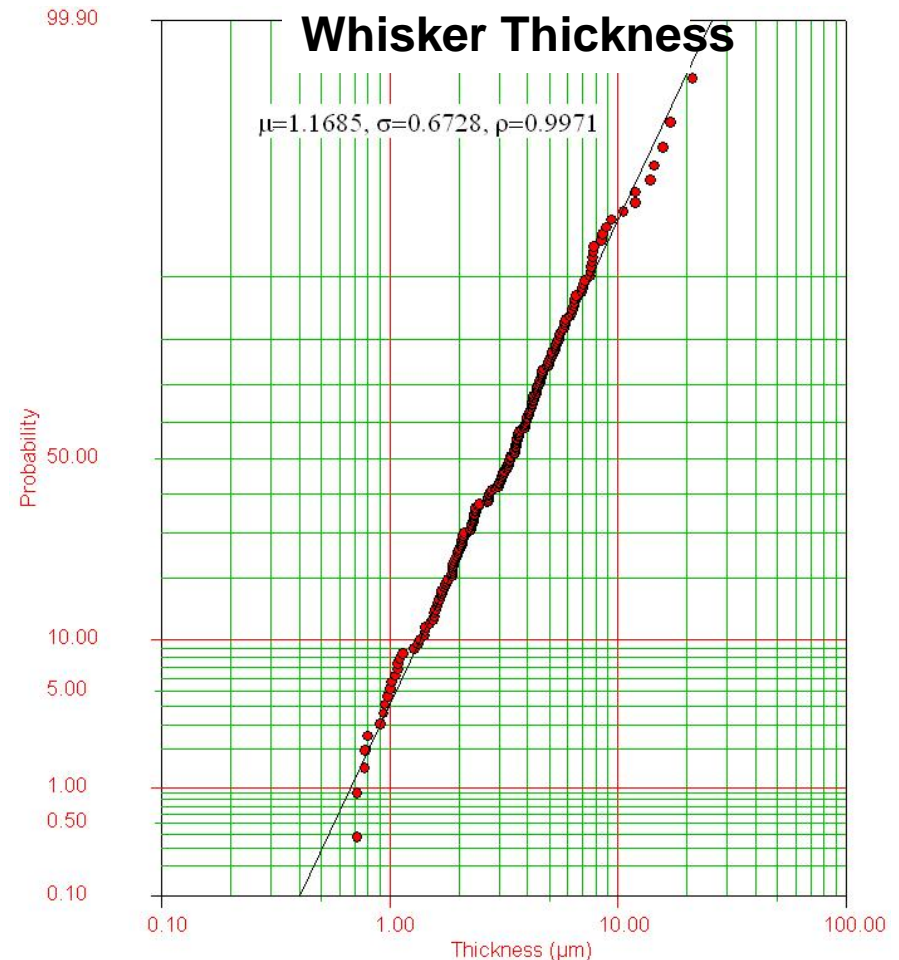
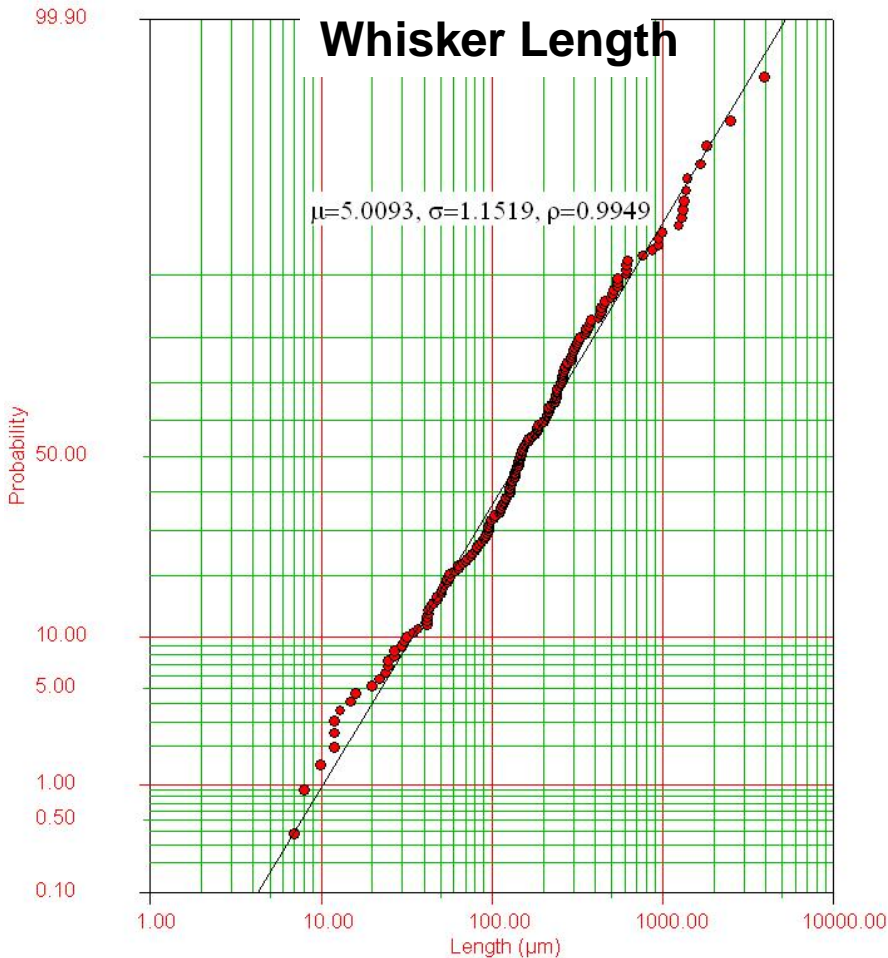

Source: L. Panashchenko "Evaluation of Environmental Tests for Tin Whisker Assessment", MS Thesis, University of MD, December 2009. Figures 59-60



How Good is the Fit?

- Take a look at the whisker length distribution presented above with 187 whisker measured.
- Now, let's take the lognormal parameters for this distribution, and randomly sample 187 points from this distribution.

Parameters used:

$$\mu = 5.01$$

$$\sigma = 1.15$$

- Remember, these are the mean and standard deviation of natural log of the function. These would translate into normal space as:

$$\text{mean} = 290$$

$$\text{standard deviation} = 481$$

Monte Carlo Simulation

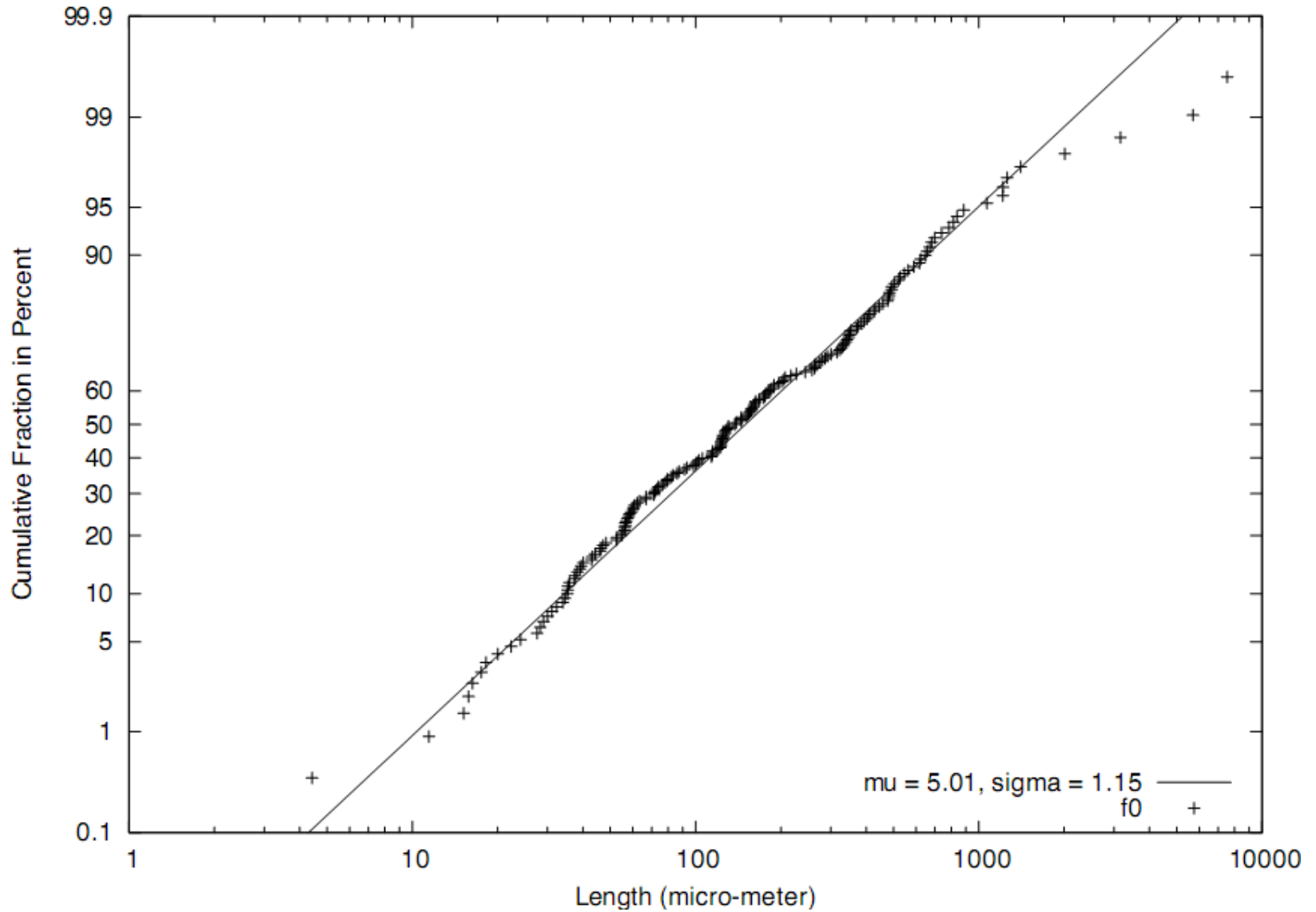

Five Monte Carlo Simulations

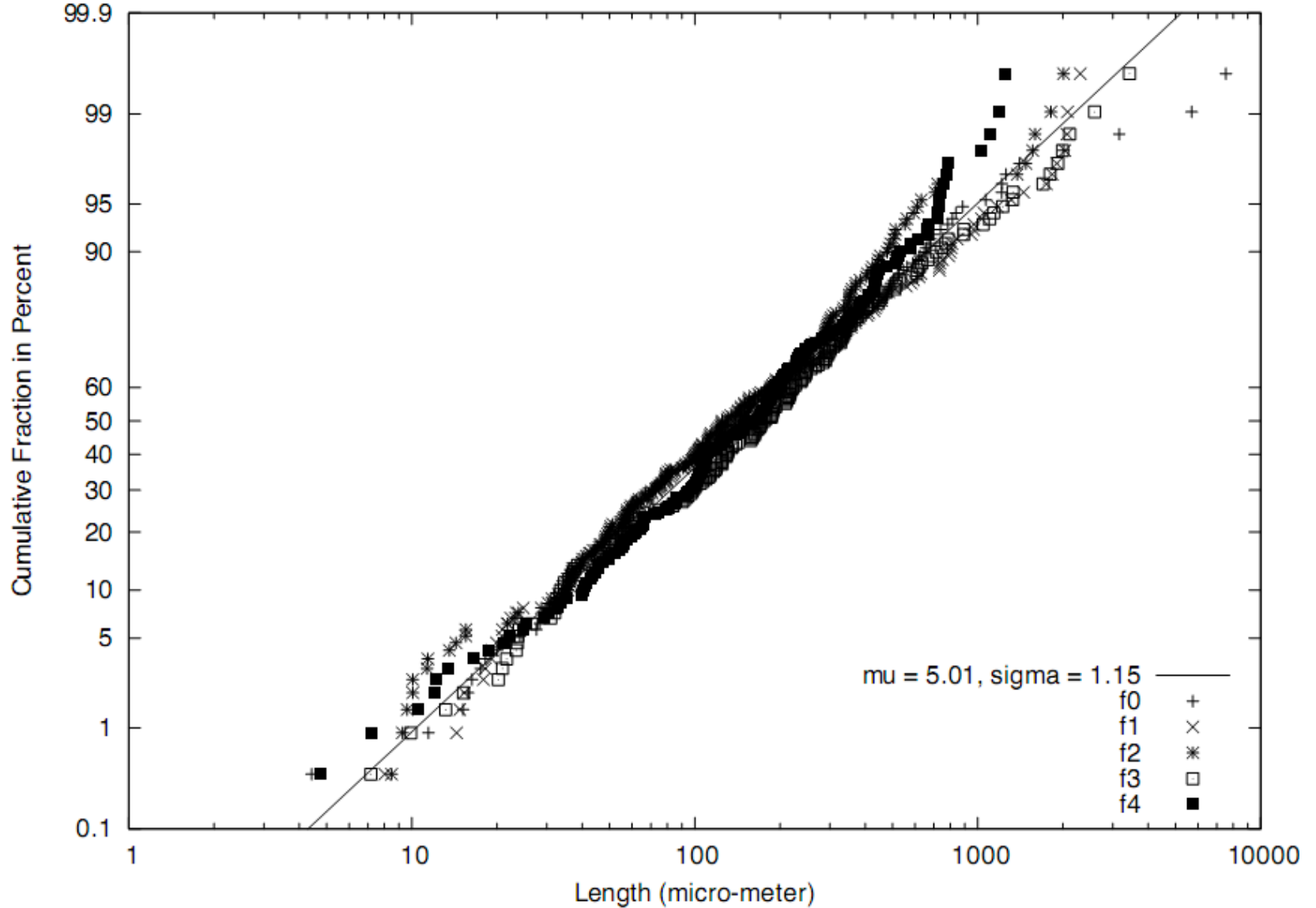

Thirty Monte Carlo Simulations

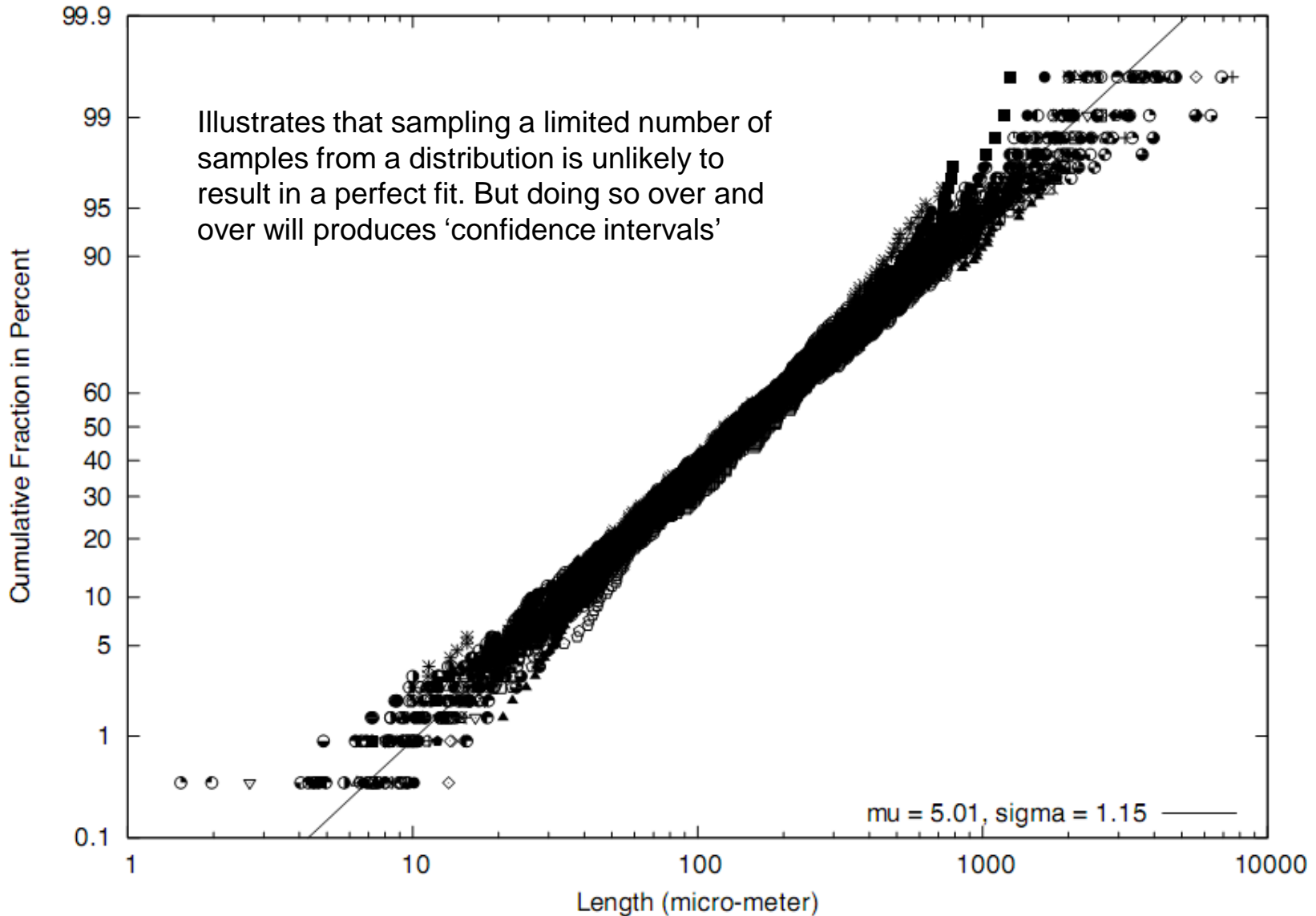

Environmental Testing for Whisker Growth



- Industry attempted to standardize testing for tin whiskers.

While these tests have no predictive power, they are still widely used by component suppliers as ‘proof’ of not whiskering.

- No such attempts seen for zinc or cadmium whiskers
However, claims of ‘our (zinc, cadmium) product will never ever grow whiskers because we say so’ still exist.



Standards for Assessing Tin Whisker Growth

Standard	IEC60068-82-2	JESD22-A121A (†)	ET-7410
Issue Date	2007/5	2008/7	2005/12
Preconditioning	Soldering simulation Lead Forming	Reflow Lead Forming	Lead Forming
Ambient Storage	30 C, 60%RH 25 C, 55%RH 4000 hrs	30 C, 60%RH	30 C, 60%RH 4000 hrs
Elevated Temperature Humidity Storage	55 C, 85%RH 2000 hrs	55 C, 85%RH 60 C, 87%RH (*)	55 C, 85%RH 2000 hrs
Temperature Cycling	Min: -55 C or -40 C Max: 85 C or 125 C 1000 or 2000 Cycles	Min: -55 C or -40 C Max: 85 (+10/-0) C 1000 or 2000 Cycles	-40 C to 85 C 1000 cycles
Acceptance Criteria	50µm	--	--

(†) JESD22-A121A does not prescribe duration of tests or Acceptance criteria. JESD201 should be used for that
 (*) Earlier version JESD22-A121, published May 2005



*“...these test conditions **have not been correlated** with longer environmental exposures of components in service. Thus, there is at present **no way to quantitatively predict** whisker lengths over long time periods based on the lengths measured in the short-term tests described in this document. At the time of writing, the fundamental mechanisms of tin whisker growth are not fully understood and **acceleration factors have not been established.**”*

Disclaimer of JESD22-A121A

Experimental Evaluation of Environmental Tests for Whisker Growth



	Experiment 1	Experiment 2	Experiment 3
Plating	Commercial Sn. Half specimens with Ni underlayer	Commercial Sn electrolytes, plated in lab	Experimental Sn electrolytes, plated in lab
Substrate	Cu (Olin-194, Cu- 2.4Fe-0.03P- 0.1Zn)	Cu (C11000, 99.99% Cu)	Brass 260 (Cu- 30Zn)
Environmental Exposure	2.5yrs in ambient, + 1000 TC +2 months of ETH, + 2 yrs in ambient	1000 TC 3000hrs of ETH	1000 TC + 2 yrs of ambient 12 months of ETH + 1 yr of ambient
Control Exposure	5 yrs in ambient	150 days in ambient	

TC: Temperature Cycling

ETH: Elevated Temperature Humidity

Source: L. Panashchenko "Evaluation of Environmental Tests for Tin Whisker Assessment", MS Thesis, University of MD, December 2009.

The Art of Metal Whisker Appreciation:

April 17, 2012

IPC Tin Whisker Conference

61

Summary of Environmental Exposure Results



Do the environmental tests predict the ambient-storage growth?

No. As currently implemented, they cannot be called predictive

As compared to ambient storage, whisker growth during environmental tests:

- Over-predicted the growth (experiment 1)
 - Whisker growth during environmental storage while no growth occurred before or after. Also, Ni underlayer was ineffective in preventing whisker growth
 - Control ambient specimens saw no whisker growth throughout 5-year period
- Had little distinction (experiment 2)
 - End of temperature cycling and elevated temperature humidity tests show almost the same (but slightly less) whisker growth as compared to ambient storage of same duration
 - Expecting whiskers on ambient-stored specimens to continue grow over time
- Under-predicted the growth (experiment 3)
 - No growth during temperature cycling or for 1 year following
 - Abundant growth after 2 years post-cycling (used as ambient control)
 - Whiskers grew during elevated temperature humidity exposure, but no growth seen throughout 1 year of post-exposure ambient storage, but severely shorter in length than that seen on ambient

Source: L. Panashchenko "Evaluation of Environmental Tests for Tin Whisker Assessment", MS Thesis, University of MD, December 2009.



'Proof' of Whisker-Free?

May 15, 2006

Attention: **To Whom It May Concern**
Re: **Access Flooring**

CONFIRMATION

The [REDACTED] access floor system is clad in steel outer sheets that have been hot-dipped galvanized. The panels do not and never have exhibited zinc whiskers.

Please call if you have any questions.

Yours truly,



Vice President



Electrical Behavior of Whiskers

- Variations expected in whisker resistance
 - $R = \rho \frac{L}{A} = \rho \frac{L}{\pi(d/2)^2}$
 - ρ is metal resistivity, L is whisker length, d is whisker thickness
 - Since both length and thickness vary, so does resistance
- Whiskers are coated with insulative oxide layers
 - Mechanical contact with a whisker does not mean electrical contact
 - Dielectric breakdown of insulative layers required for conduction to occur
- Whiskers will melt with enough current through them!
 - How to protect circuits under failure analysis from burning out a whisker?

Tin Whisker Resistance at Room Temperature for Different Lengths and Thicknesses

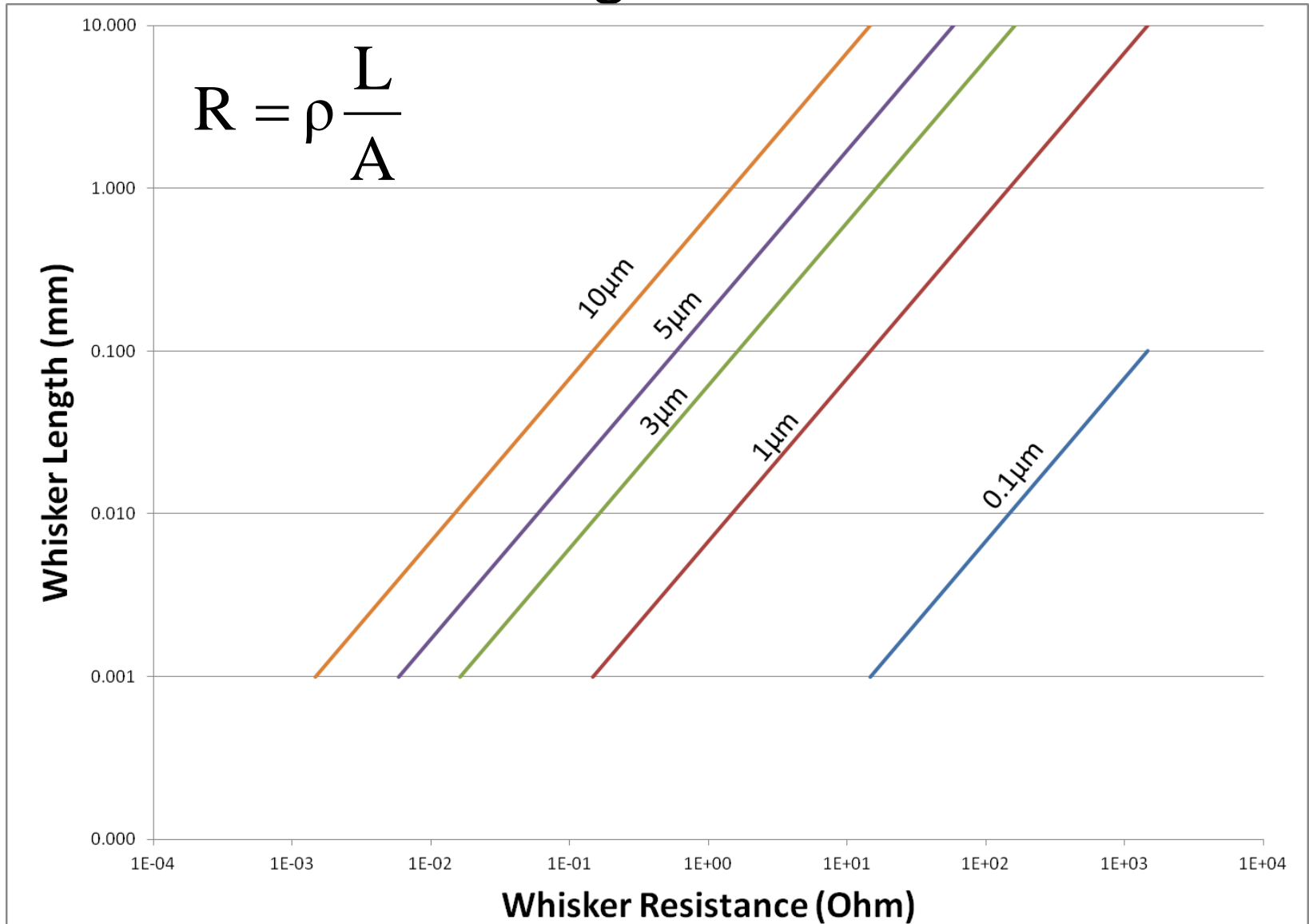
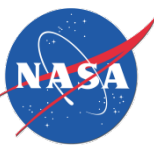

Metal Whiskers and Adjacent Conductors Grow Insulating Films

- Electrically insulating films form within hours on metal whiskers and adjacent conductors
 - Oxides, sulphides, sulphates, chlorides, hydrides, etc.
- These films act as barriers to electrical current flow UNLESS applied voltage exceeds “dielectric breakdown” strength of the combined films
 - Direct **MECHANICAL** contact does NOT guarantee **ELECTRICAL** contact
 - Courey (NASA), among others, have measured the breakdown voltage of films on tin whiskers
 - V_{BD} fit a probability distribution with a wide range (~60mV to >45Volts)
 - Insulating effects of these films are important to recognize
 - Has fooled failure analysts when bench testing (e.g., Ohm-meter) to detect shorts
 - Can explain survival of some electronics in the field despite whisker infestation

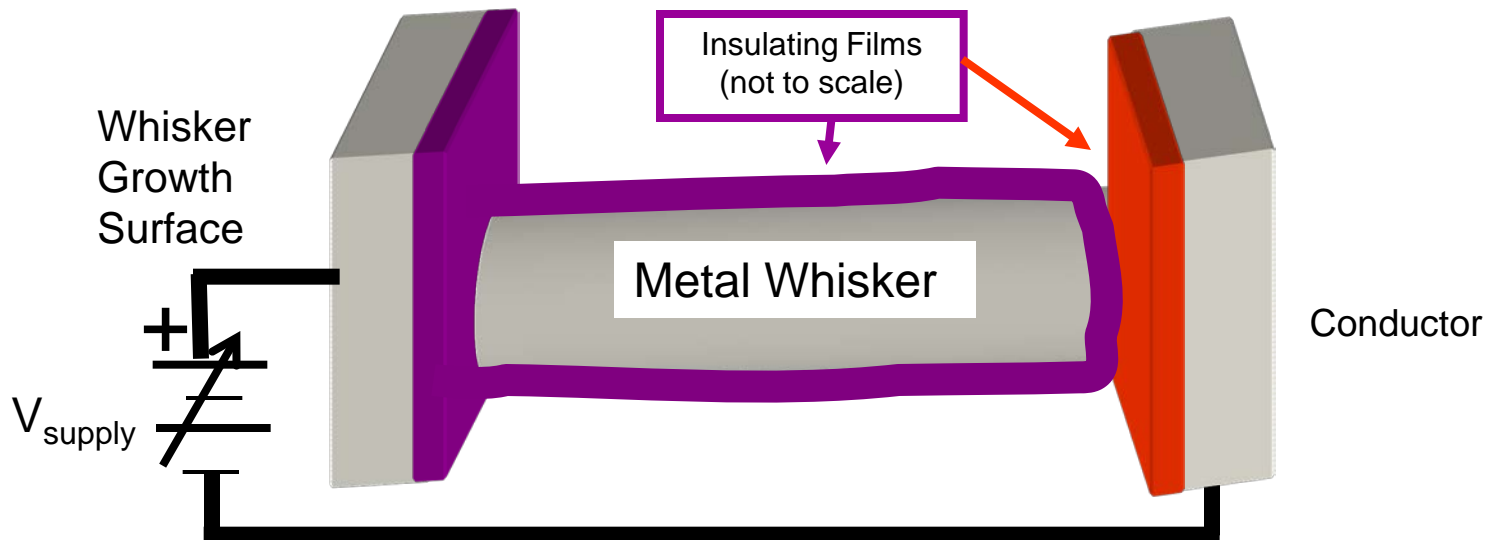



Breakdown Potential of Insulating Films on 200 Tin Whiskers from ~19 Year Old Space Shuttle Hardware when probed using gold-plated probe

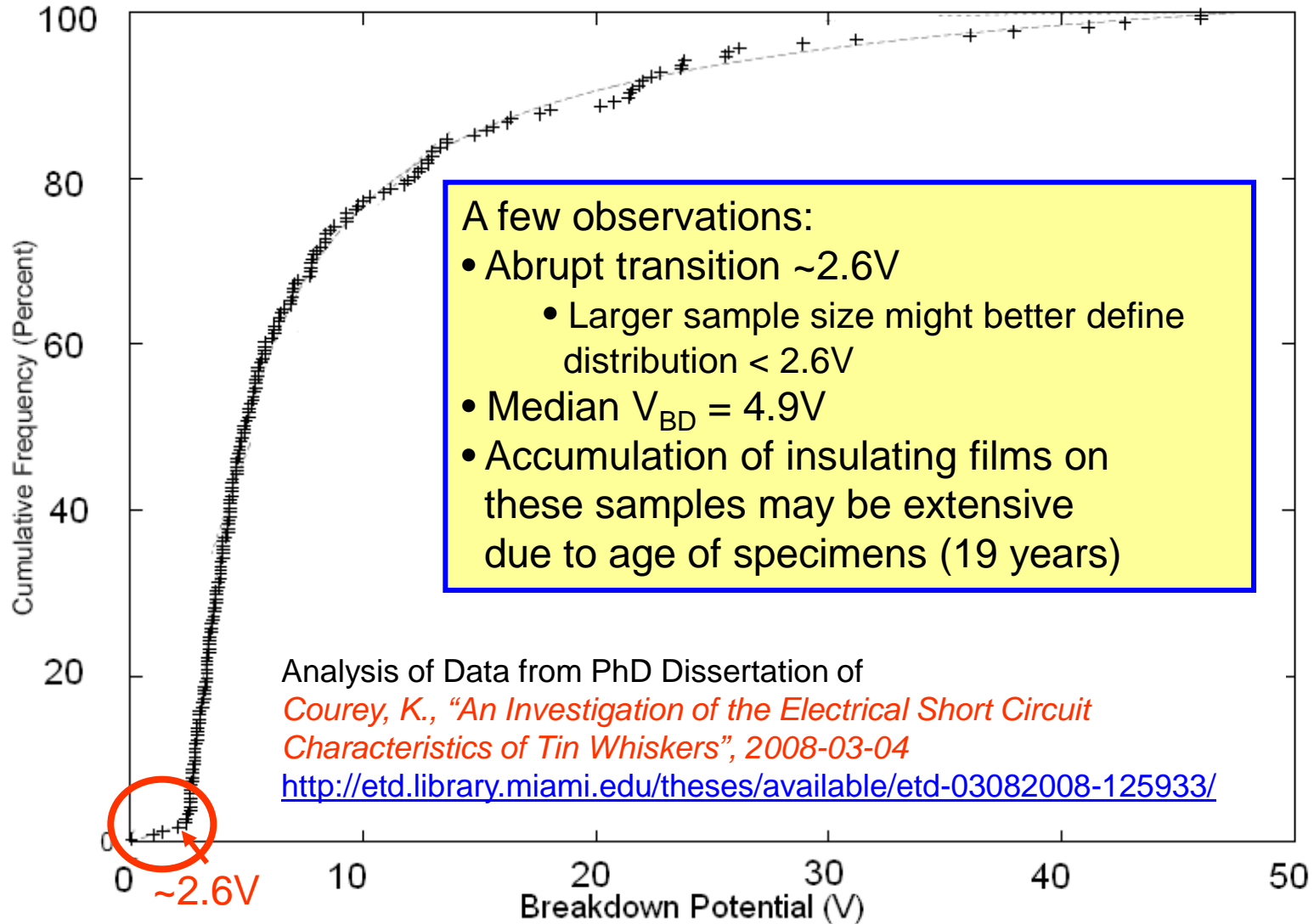



Metal Whisker Melting Current (In Vacuum)

$$I_{melt,vac} = \left[\frac{2\sqrt{LzT_0}}{R_0} \right] \cos^{-1} \left(\frac{T_0}{T_{melt}} \right)$$

See Backup Slides for Derivation

- Where $Lz \sim 2.45 \cdot 10^{-8} (V/K)^2$ is the Lorenz number, T_{melt} = melting temperature,
 T_0 = ambient temperature, R_0 = whisker resistance at ambient

Material	T_{melt}	$I_{melt, vac}$	$V_{melt} = R_0 * I_{melt, vac}$
Tin	505.1K	87.5 mV / R_0	88 mV
Cadmium	594.2K	97.1 mV / R_0	97 mV
Zinc	692.7K	104.4 mV / R_0	104 mV

*If $V_{whisker} > V_{melt}$
 Then the Whisker will Fuse Open*

But there is MORE to this story



Melting Voltage vs. Length for Selected Whisker Diameters

Based on: J.H. Richardson, and B.R. Lasley, "Tin Whisker Initiated Vacuum Metal Arcing in Spacecraft Electronics,"
1992 Government Microcircuit Applications Conference, Vol. XVIII, pp. 119 - 122, November 10 - 12, 1992.

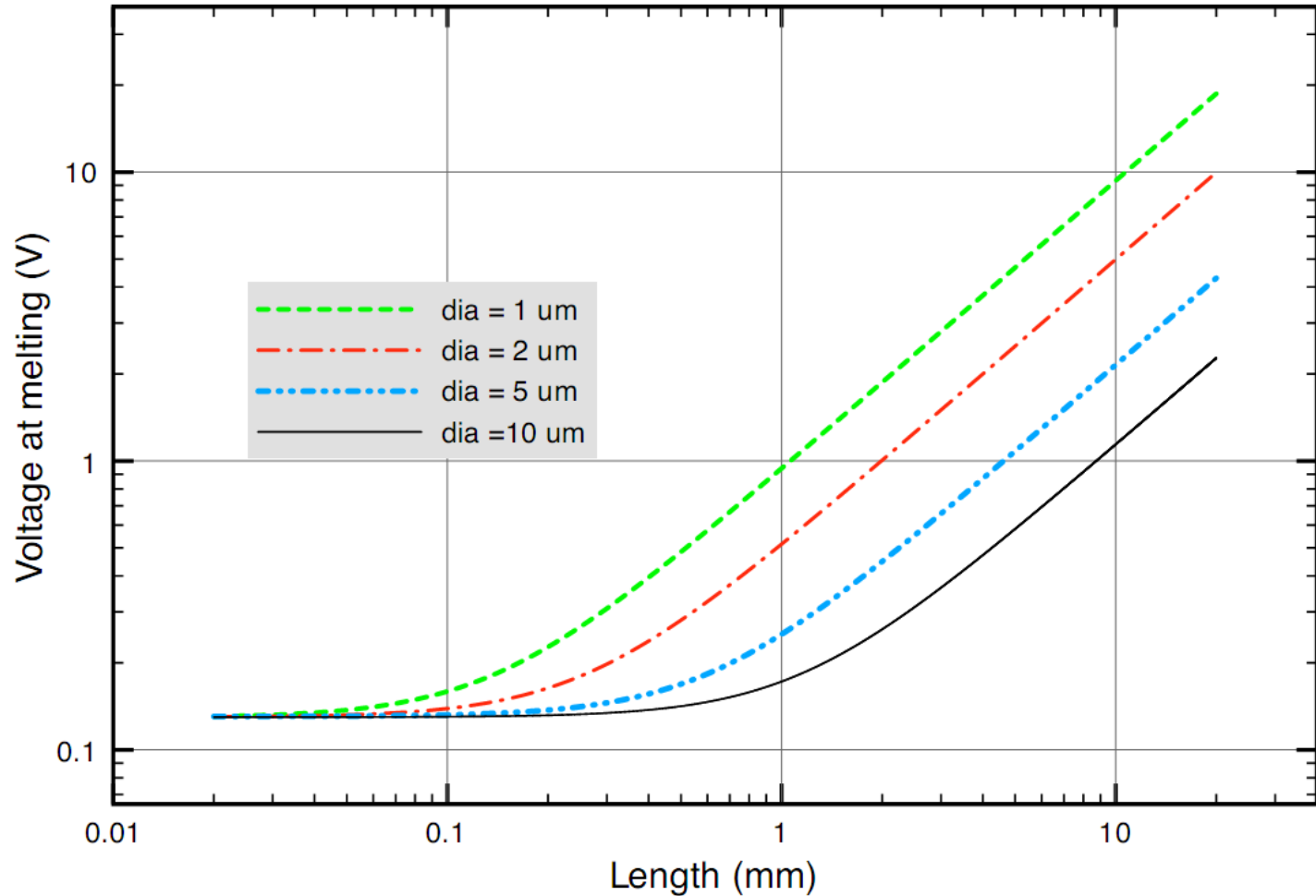

The Killing of a Whisker

Sn whisker is probed with a Au tip, and its resistance is measured using a hand-held ohm-meter.

No protective resistor is in series.

Ohm-meter reading $\sim 2e2\Omega$.

During range switching, whisker is burnt out





Beware of Ohm-Meter Limitations

- Published research shows that ohm-meters detect less than 10% of the bridging whiskers, and sometimes less than 1%
- The investigator may conclude **“No Fault Found”**
 - Ohm-meter may supply $V_{out} < V_{breakdown}$ for the insulating films (oxides, moisture) that form on a metal whisker. No Current will flow – the whisker remains undetected during the few seconds of examination.
“No Fault Found”
 - Ohm-meter may supply $V_{out} > V_{melt}$. Current Will Flow, the whisker melts in less than 1 ms -- no detection happens. There is no longer a bridging whisker to detect.
“No Fault Found”
- Range switching can have the ability to deliver whisker-killing impulses

Charybdis and Scylla: Electrical Detection of Whisker Short Melting Whisker vs. Insulating Film Interference

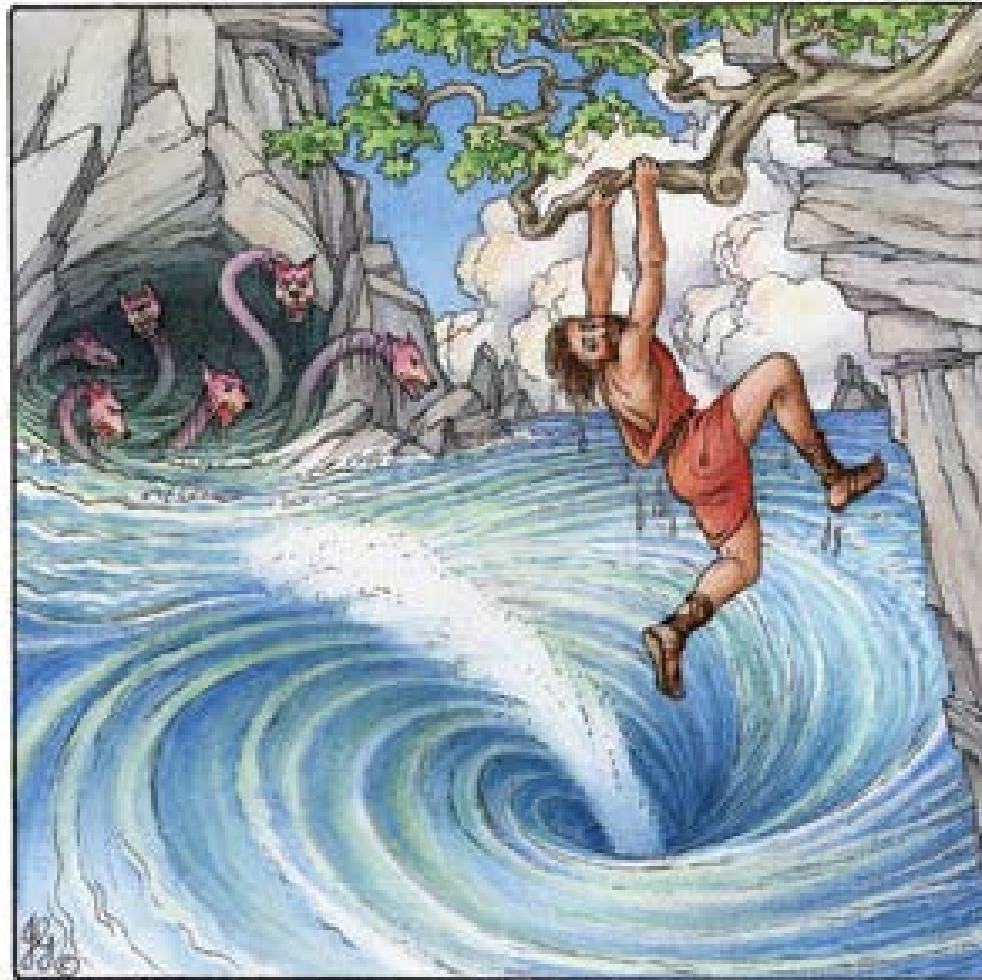

Build Your Own Better Whisker Detector!

- Use a variable power supply (V_{supply}) and a protective resistor in series (R_S) with the whisker to be detected
 - Choose $R_S \sim 100\text{k}\Omega$
 - Adjust $V_{\text{supply}} > V_{\text{breakdown}}$ of insulating films on whisker and conductor being bridged
 - When $V_{\text{supply}} > V_{\text{breakdown}}$, R_S quickly drops $V_{\text{whisker}} < V_{\text{melt}}$

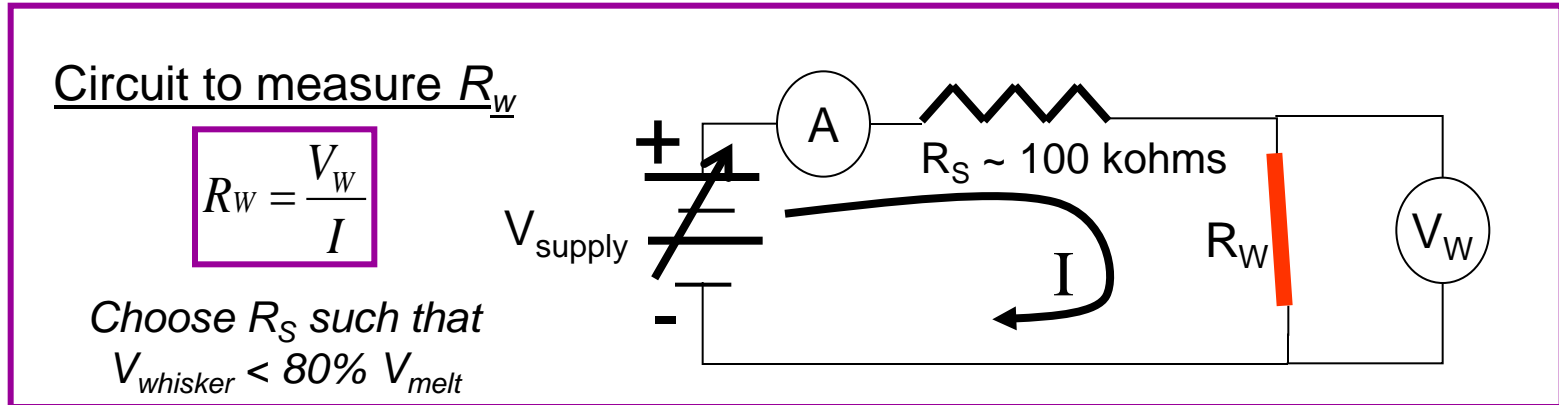

WARNING: “DO NO HARM” principle should be applied:

- The use of this circuit may be damaging to active parts or powered circuits under test
- A high impedance voltage meter should be used for measurements made across a whisker

Carnage and Chaos in Swedish Paper Mill

Tin Whisker-Induced **Metal Vapor Arcing**

Problem in power supplied cabinet (500V AC) resulting in molten bus bars on three different occasions (1997, 2000, and 2009)



See Next Slide for Tin Whiskers That Caused this Havoc

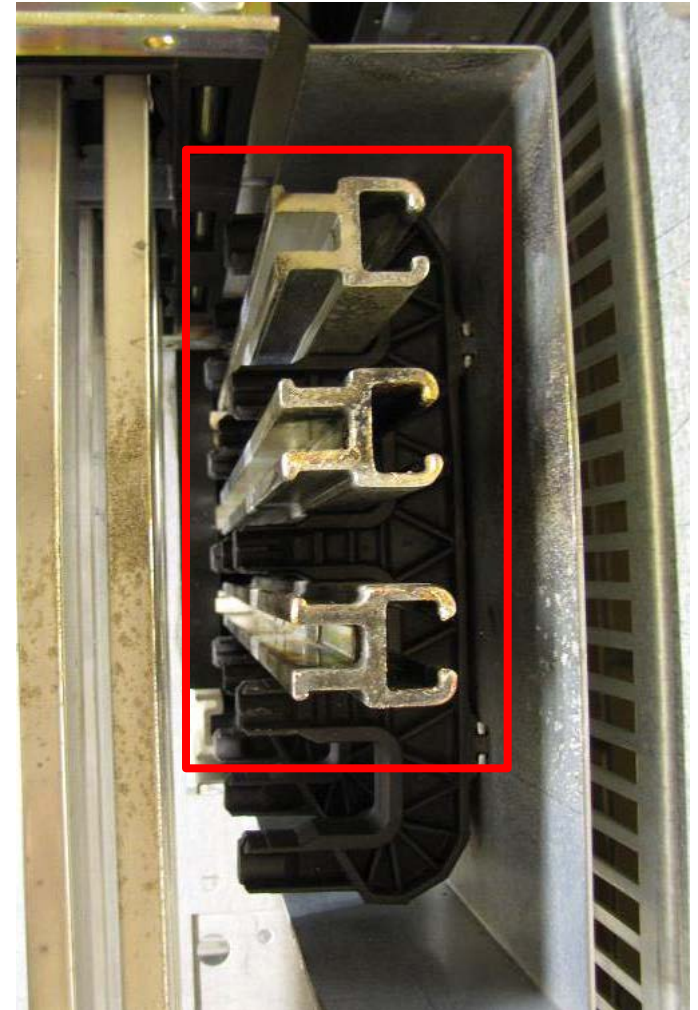

More information at <http://nepp.nasa.gov/whisker/anecdote/2009busbar/2009-brusse-bus-bar-tin-whiskers-sweden.pdf>

Tin Whiskers Responsible for metal Vapor Arcing in Swedish Paper Mill

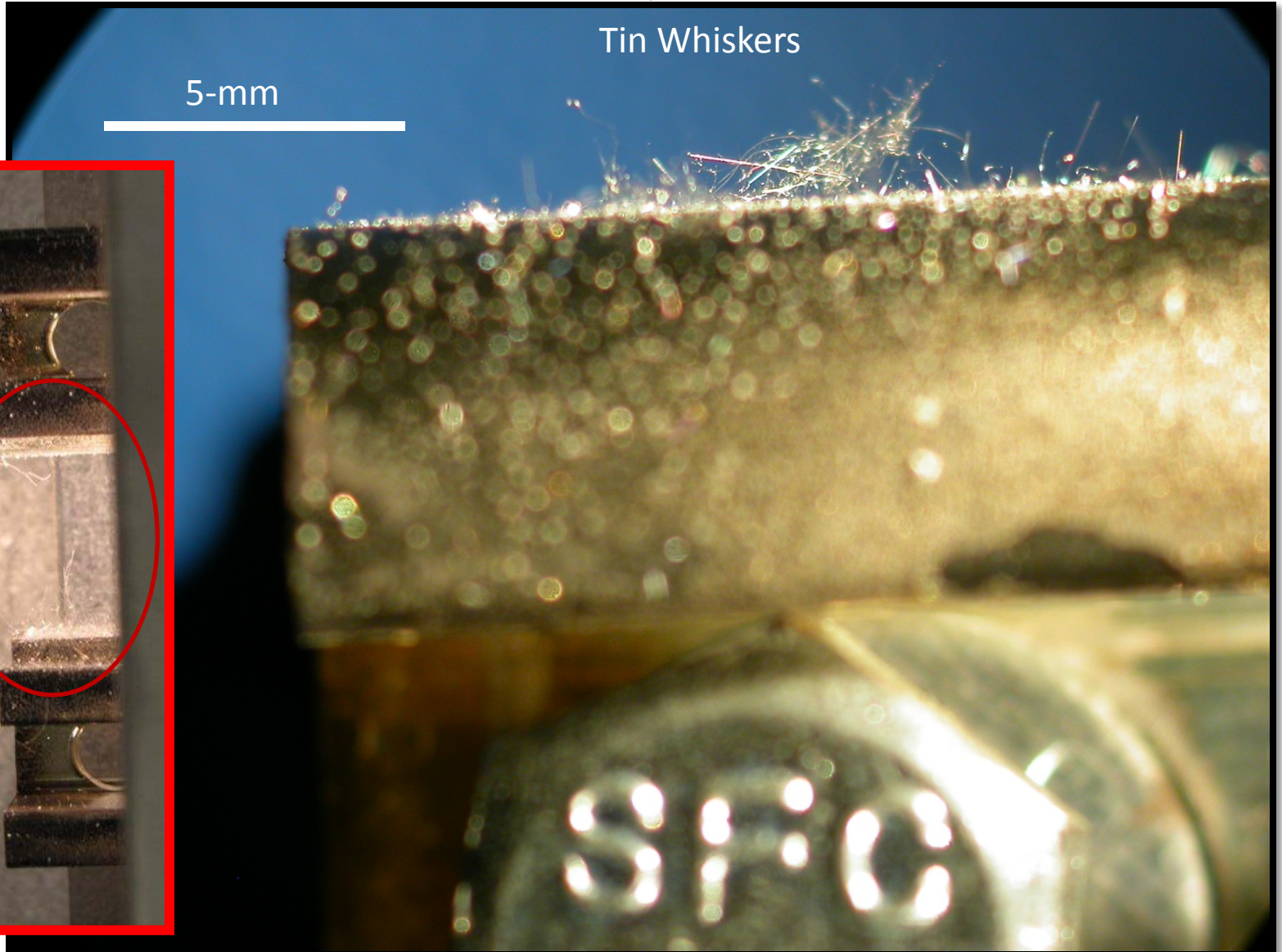



Electromagnetic Relays Tin-Plated Terminals and Case: On-Orbit Metal Vapor Arcing Failure



50 volts at 200 amperes

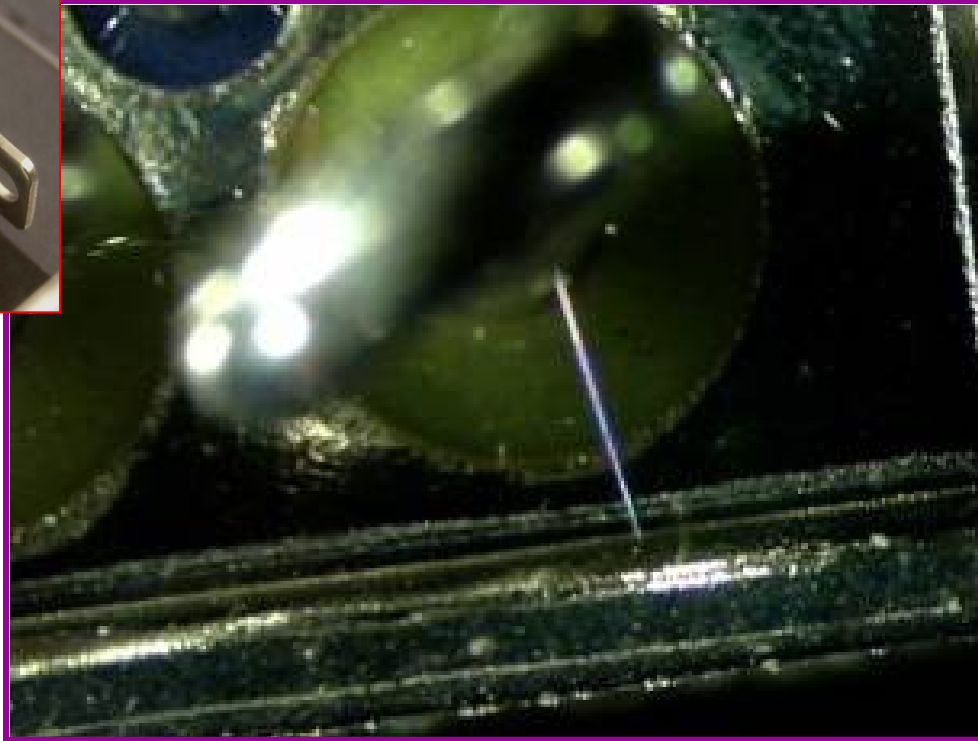

*Spec Required >3% Pb by weight in the Tin Plated Finish;
HOWEVER; PURE TIN was Supplied ANYWAY!!!*

1. http://www.boeing.com/defense-space/space/bss/hsc_pressreleases/98_08_11_601ok.html
2. J.H. Richardson, and B.R. Lasley, "Tin Whisker Initiated Vacuum Metal Arcing in Spacecraft Electronics," 1992 Government Microcircuit Applications Conference, Vol. XVIII, pp. 119 - 122, November 10 - 12, 1992.

Sustained Metal Vapor Arcing Initiated by Metal Whisker

- When a metal whisker shorts two conductors at different potentials, a sustained arc can occur if
 - Current is high enough to vaporize the whisker (i.e., metal gas)
 - Voltage is high enough to ionize the metal gas
- Sustained arcing between metal conductors is possible for voltages as low as ~12 to 14 volts when
 - Arc gap is ***SMALL*** ~ a few tens of microns
 - Available current > ~100 to 300 mA
 - See “Electrical Contacts - Part III” by Paul G. Slade
- However, as arc gap increases, sustaining the arc requires
 - Higher voltage to ionize the metal gas
 - Higher current to boil enough additional metal gas to keep plasma dense enough to sustain it
 - Vacuum (i.e., low pressure) is NOT required, but can reduce the threshold voltage and current required for arcing
- Relevant metal vapor arc testing by NASA of FM08 style fuses with metal filaments ~5 mm long
 - ~75 volts at more than 30 amperes is needed to generate a sustained arc across this arc gap when P ~1 torr

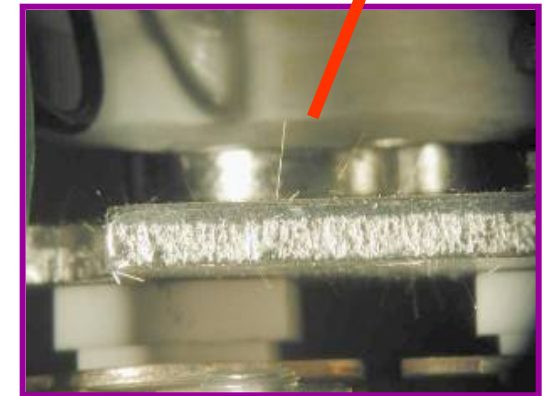
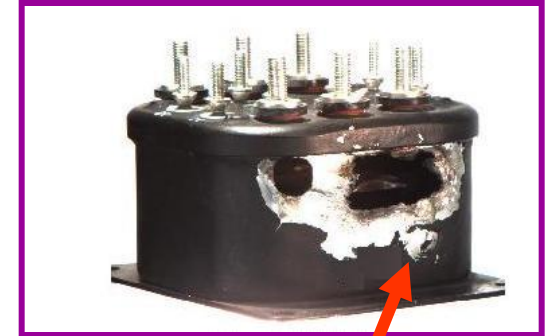

Tin Whiskers Growing on Armature Of Relay Produced Metal Vapor Arc

G. Davy, "[Relay Failure Caused by Tin Whiskers](http://nepp.nasa.gov/whisker/reference/tech_papers/davy2002-relay-failure-caused-by-tin-whiskers.pdf)", Northrop Grumman, Technical Article, October 2002
http://nepp.nasa.gov/whisker/reference/tech_papers/davy2002-relay-failure-caused-by-tin-whiskers.pdf

Tin Whisker Induced Metal Vapor Arcing Video at 50V and 70torr

Video Source: CALCE <http://www.calce.umd.edu/tin-whiskers/mva50V70torr.html>

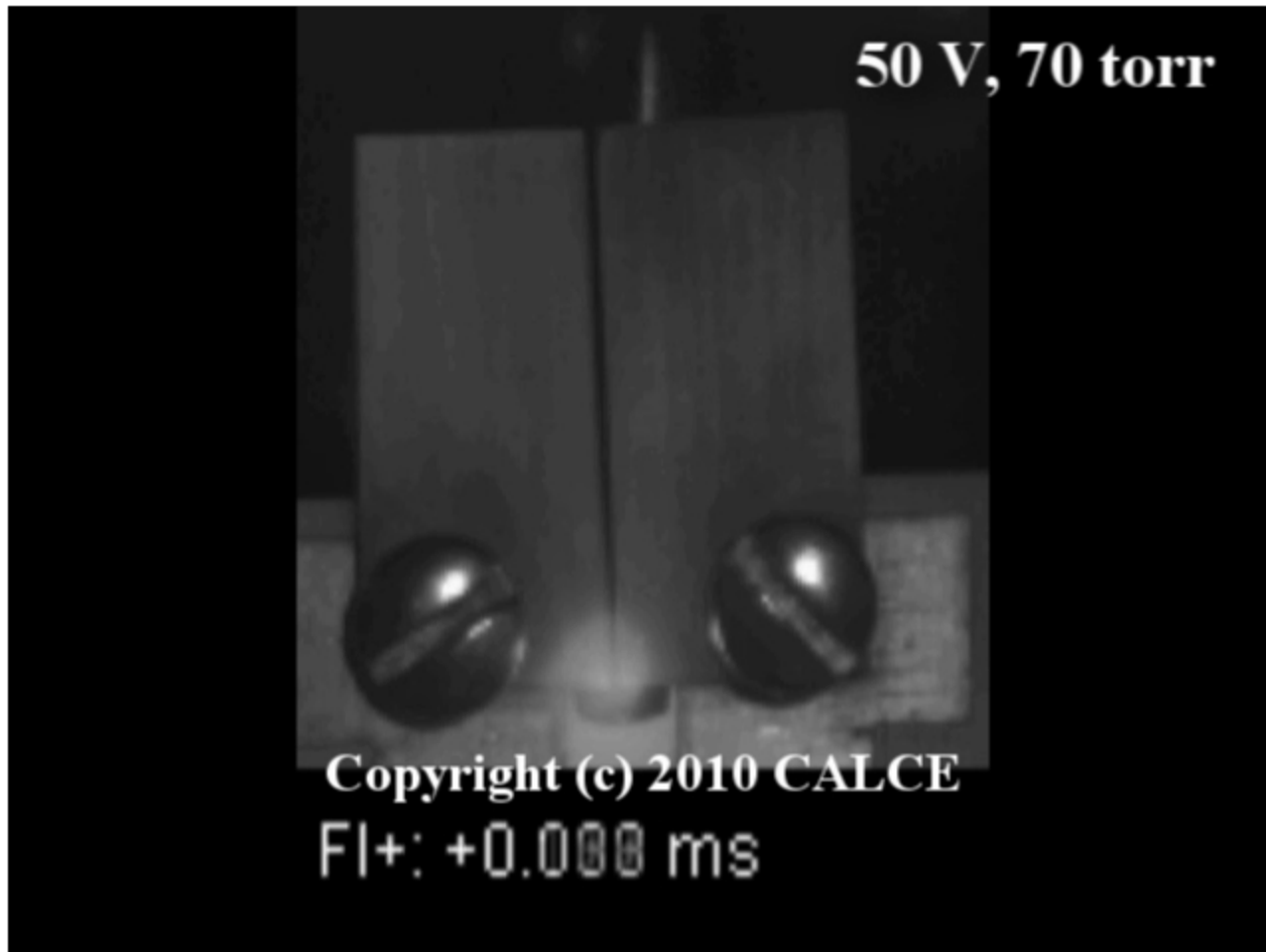



Why Are Tin, Zinc, Cadmium Still Used?

- Not all Tin (or Zinc or Cadmium) surfaces whisker!
 - Rough estimate: 3% to 30% do whisker.
- Not all metal whiskers cause shorts
 - Environment (geometry and electrical potentials matter).
 - Rough estimate: 3% to 30% do short.
- Not all whisker-induced shorts are traced to whiskers
 - They are very hard to see and failure analysis techniques often destroy evidence
 - Rough estimate: 0% to 10% are correctly traced.
- Not all identified whisker adventures are reported
 - Rough estimate: 0% to 3% are reported, once identified
- Hence, we expect between 0.00% and 0.03% of shorting problems caused by these coatings to be reported
 - While some 0.1% to 10% of these coatings are actually causing shorts.
 - With such a few public cases, many say “What, me worry?”
- Whiskering is dramatically inhibited when 0.5% (or more) lead (Pb) is added to Tin coatings: the shorting rate then approaches zero
 - This has been the case for the Hi-Rel community
 - But Pb use is being restricted by international legislation, and so the shorting rate may jump to 10% from zero ==> **SWATCH GROUP** <==



Sometimes Metal Whiskers

adverb

noun

verb

Contact Us!

<http://nepp.nasa.gov/whisker>

Lyudmyla Panashchenko:
lyudmyla.p@nasa.gov

Jay Brusse:
jay.a.brusse@nasa.gov

Henning Leidecker:
henning.w.leidecker@nasa.gov

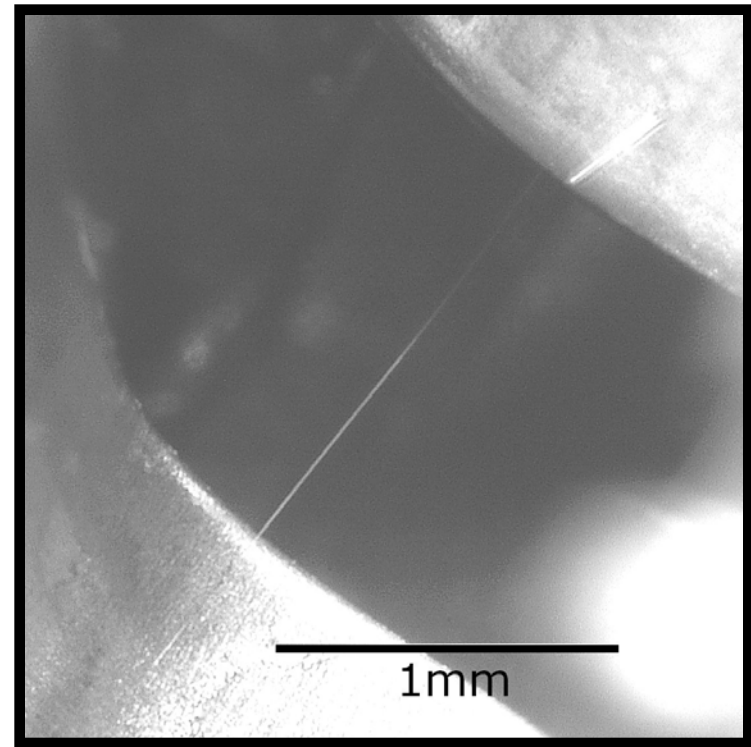

Back-Up



Practicality Issue in Measurements

- Some whiskers exhibit complicated geometries
- Geometry of sample may not allow much degree of freedom, if need to rotate the specimens for better view
- Nevertheless, any modeling of whisker length requires a statistically significant number of whiskers to be measured

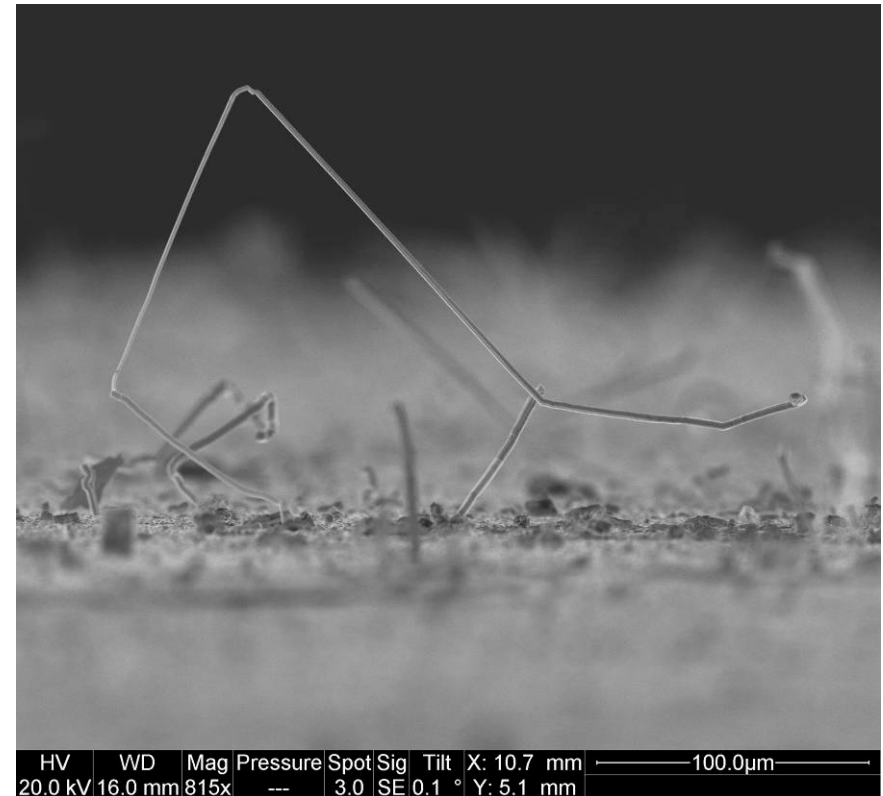

Whisker Length Definition

JESD22-A121(May 2005)

The distance between the finish surface and the tip of the whisker that would exist if the whisker were straight and perpendicular to the surface

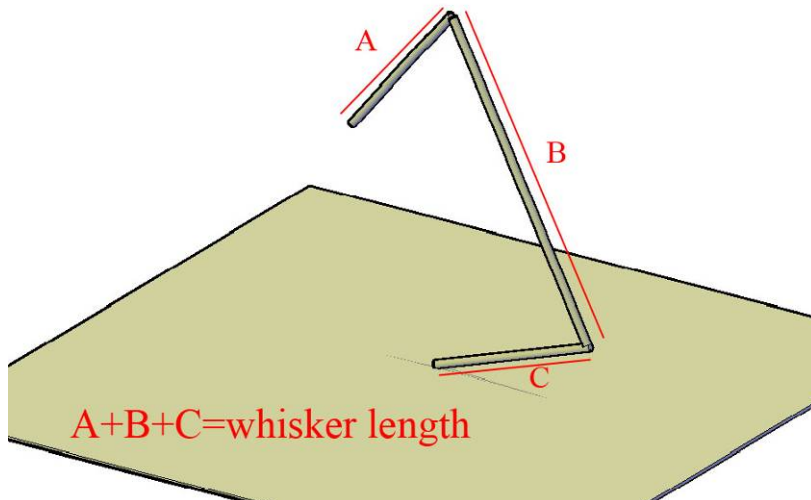

JESD201 (March 2006)

JESD22-A121A (July 2008)

IEC 60068-2-82 (May 2007)

The straight line distance from the point of emergence of the whisker to the most distant point on the whisker

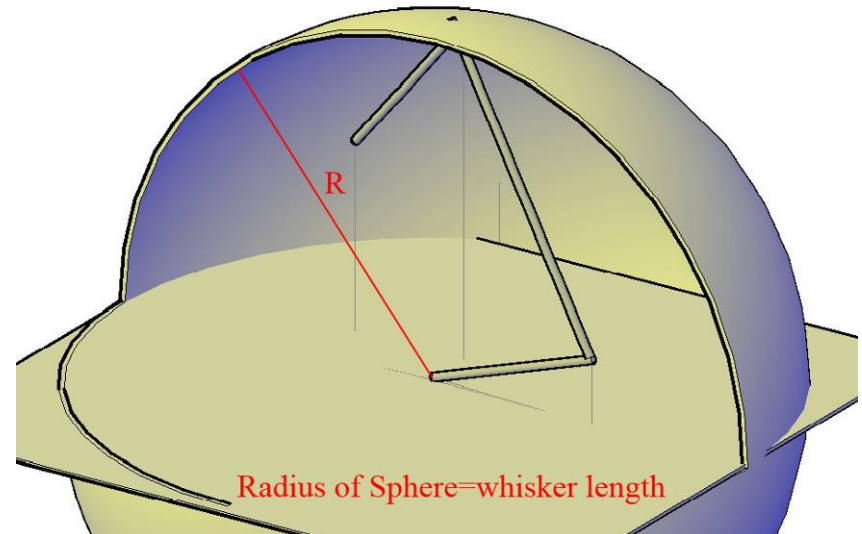

Guidance provided by JESD22-A121 in measurement technique: "... the system must have a stage that is able to move in three dimensions and rotate, such that whisker can be positioned perpendicular to the viewing direction for measurement"

Recommended Length Measurement

A more accurate measurement can be made by using two images offset by a known tilt

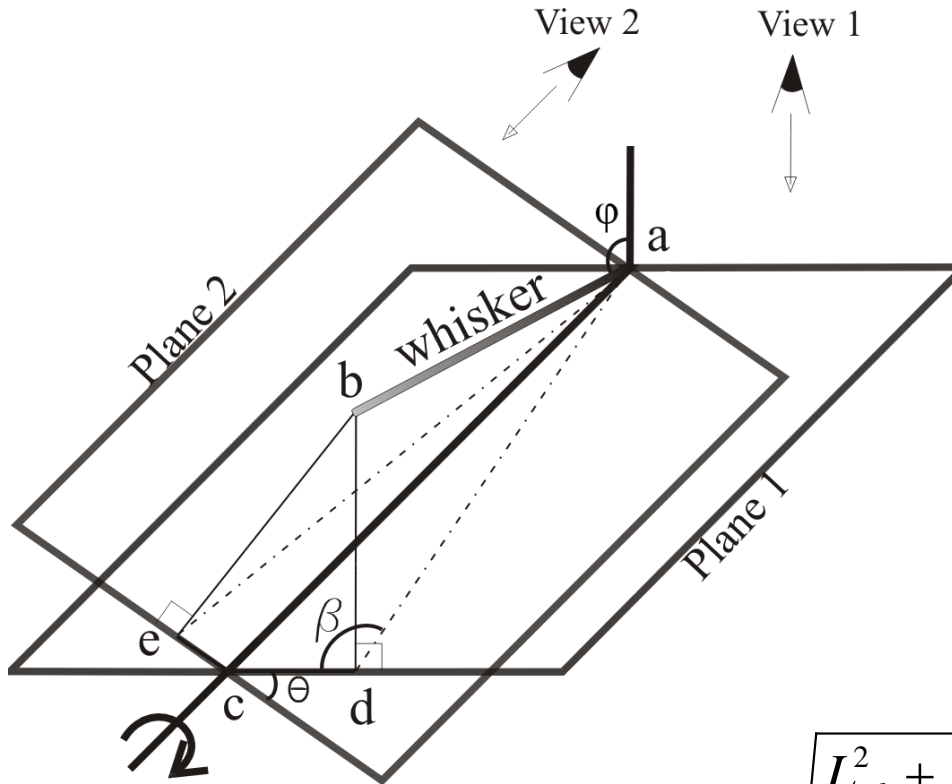

Axis along L_{ac} is the tilt axis

L_{cd} = projection of whisker length on axis perpendicular to tilt axis in Plane 1

L_{ce} = projection of whisker length on axis perpendicular to tilt axis in Plane 2

θ = tilt angle between Plane 1 and Plane 2

β = angle between L_{cd} and L_{ad} in Plane 1

$$L_{ab} = \sqrt{\frac{L_{cd}^2 + L_{ce}^2 - 2L_{cd}L_{ce}\cos\theta}{\sin^2\theta} + (L_{cd}\tan\beta)^2}$$

Whisker Length Measurement Errors

- If measuring whisker length from a single image:

$$\% \text{ Error} = (1 - \cos\alpha) * 100\%$$

- Measuring whisker lengths by tilting and aligning with field of view in SEM:

- 7 participants
- 3 whiskers
- 20% ± 11% error
- 1.5 – 3hrs used up to measure 3 whiskers

- Measuring whisker lengths by two-images method:

- 15 participants
- 15 whiskers
- 7% ± 3% error
- Images capture and measurements in under 10min

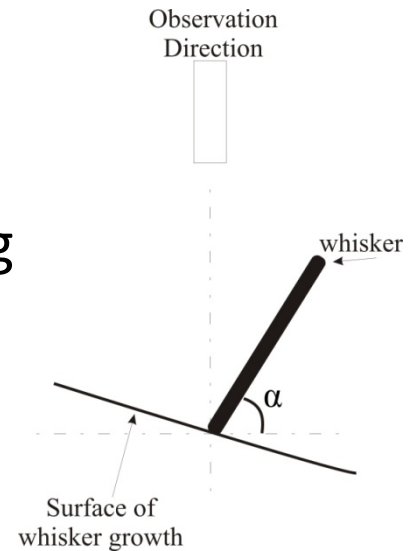

Derivation of Melting Current of a Metal Whisker in Vacuum

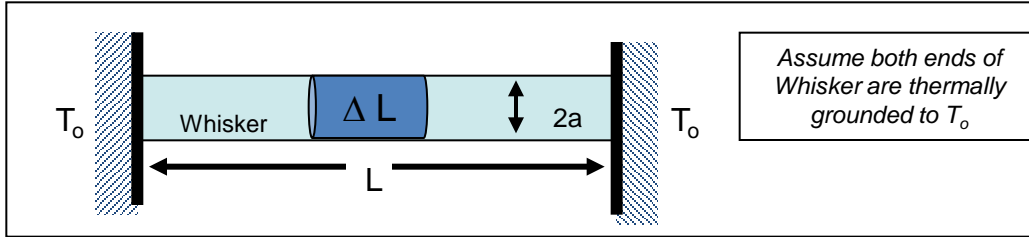

$$\frac{du}{dt} + \Phi = source$$

du/dt

+

Φ

=

source

$$u = C \cdot T \quad c = \frac{C}{V}$$

$$u = \left(\frac{C}{V}\right) \cdot V \cdot T = c \cdot V \cdot T$$

$$u = c \cdot \Delta L \cdot A \cdot T$$

$$\frac{du}{dt} = c \cdot \Delta L \cdot A \cdot \frac{\partial T}{\partial t}$$

$$\Phi = \left(\frac{\partial J}{\partial x}\right) \cdot \Delta L \cdot A$$

Convection loss = 0 for vacuum
Neglect radiation loss

$$J = -k_T \cdot \frac{\partial T}{\partial x} \quad \frac{\partial J}{\partial x} = -k_T \cdot \frac{\partial^2 T}{\partial x^2}$$

$$\Phi = -k_T \cdot \left(\frac{\partial^2 T}{\partial x^2}\right) \cdot \Delta L \cdot A \quad k_T = \frac{Lz \cdot T}{\rho}$$

$$\Phi = -\frac{Lz \cdot T}{\rho} \left(\frac{\partial^2 T}{\partial x^2}\right) \cdot \Delta L \cdot A$$

$$source = I^2 \cdot R$$

$$I = J_e \cdot A \quad R = \frac{\rho \cdot \Delta L}{A}$$

$$source = (J_e^2 \cdot A^2) \cdot \left(\frac{\rho \cdot \Delta L}{A}\right)$$

$$source = (J_e^2 \cdot A) \cdot \rho \cdot \Delta L$$

$$\left[c \cdot \Delta L \cdot A \cdot \frac{\partial T}{\partial t} \right] - \left[\frac{Lz \cdot T}{\rho} \left(\frac{\partial^2 T}{\partial x^2}\right) \cdot \Delta L \cdot A \right] = J^2 \cdot \rho \cdot \Delta L \cdot A$$

$$\left[c \cdot \frac{\partial T}{\partial t} \right] - \left[\frac{Lz \cdot T}{\rho} \left(\frac{\partial^2 T}{\partial x^2}\right) \right] = J^2 \cdot \rho$$

$$I_{melt,vac} = \left[\frac{2\sqrt{LzT_0}}{R_0} \right] \cos^{-1} \left(\frac{T_0}{T_{melt}} \right)$$



"The Five Stages of Metal Whisker Grief"

By Henning Leidecker

Adapted from Elisabeth Kubler-Ross in her book "On Death and Dying",
Macmillan Publishing Company, 1969

Denial

"Metal whiskers?!? We ain't got no stinkin' whiskers! I don't even think metal whiskers exist! I KNOW we don't have any!"

Anger

"You say we got whiskers, I rip your \$%#@ lungs out! Who put them there --- I'll murderize him! I'll tear him into pieces so small, they'll fit under one of those *^&\$#% whiskers!"

Bargaining

"We have metal whiskers? But they are so small. And you have only seen a few of them. How could a few small things possibly be a problem to our power supplies and equipment? These few whiskers should be easy to clean up."

Depression

"Dang. Doomed. Close the shop --- we are out of business. Of all the miserable bit joints in all the world, metal whiskers had to come into mine... I'm retiring from here... Going to open a 'Squat & Gobble' on the Keys. "

Acceptance

"Metal whiskers. How about that? Who knew? Well, clean what you can. Put in the particle filters, and schedule periodic checks of what the debris collectors find. Ensure that all the warranties and service plans are up to date. On with life."



Research on Whiskers vs Conformal Coating (1/2)

	Boeing [2][3][4]	Schlumberger [5]	Lockheed Martin [6][7]	NPL [8]	Raytheon [9]
Acrylic	1 and 3mil thick. OK in ambient. Penetrated in 25°C/95%RH	--	1,2,3 mil thick. 5 years 50°C/50%RH – penetration and tenting of 1mil coating	5-20µm thick. OK after 150days in ambient	--
Silicone	1 and 3mil thick. OK in ambient. Penetrated in 25°C/95%RH	unknown thickness 120C storage and thermal cycles – whiskers penetrated coating of	--	14-588µm thick. OK after 150 days in ambient	Whiskers penetrated (unknown thickness or conditions)
Parylene C	0.4mil thick. OK in ambient. Penetrated in 25°C/95%RH	--	0.5mil thick. 5 years 50°C/50%RH – no tenting or penetration	--	--

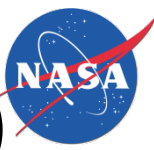

Research on Whiskers vs Conformal Coating (2/2)

	Boeing [2][3][4]	NASA [10][11][12]	Lockheed Martin [6][7]	NPL [8]
Urethane (Polyurethane)	--	2mil thickness fully effective after <u>9 years</u> of ambient	1,2,3 mil thick. 5 years 50°C/50%RH – penetration and tenting of 1mil coating	9-57µm thick. OK after <u>150</u> <u>days</u> in ambient
Urethane Acrylate	1 and 3mil thick. OK in ambient. Penetrated in 25°C/95%RH	--	--	13-79µm thick. OK after <u>150</u> <u>days</u> in ambient

Conformal Coat (Arathane 5750* Polyurethane)

~11 Years of Office Ambient Storage

- **Specimens: 14 total**
 - 1" x 4" x 1/16" Brass 260
 - Tin-Plated 200 microinches
 - A few intentional scratches created after plating in an attempt to induce localized whisker growth
- **Conformal Coating:**
 - Arathane 5750 on ½ of sample
 - Nominal Thickness = 2 mils
 - Locally THIN Regions also examined
- **Storage Conditions:**
 - Office Ambient ~ 11 years

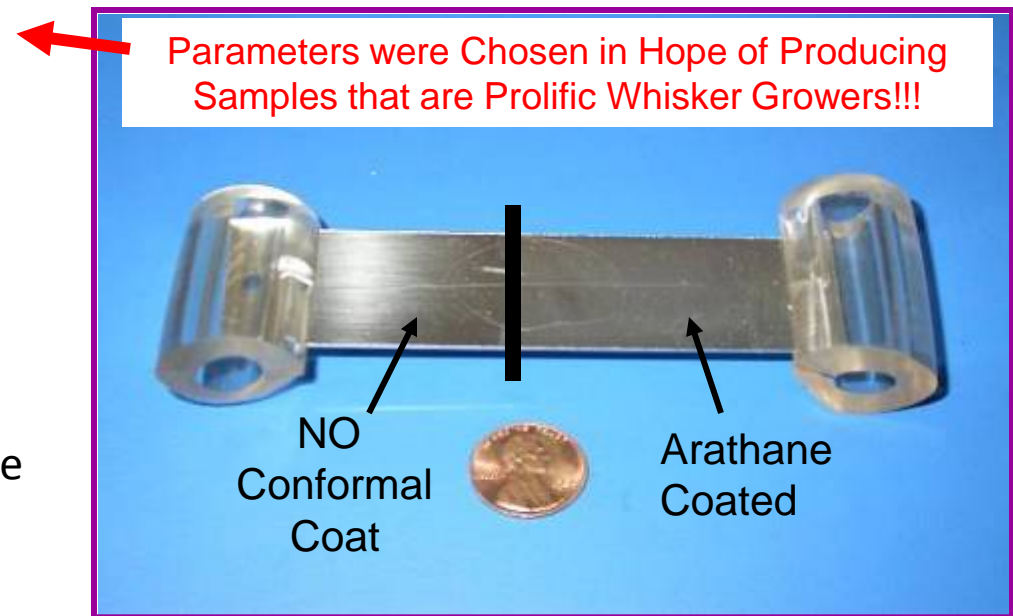

* Arathane™ 5750 was previously known as Uralane™ 5750



Effects of Conformal Coating

- Conclusion 1: *No whiskers have penetrated 2 mils of Arathane 5750 after 11 years*
 - Despite samples being capable of forming approximately 50 whiskers/mm² on coated areas greater than 600mm²
- Conclusion 2: *Whiskers are able to penetrate when Arathane 5750 coating is thinner (~0.1mil or less)*
 - Conformal coating processes can leave “weak zones”
 - Shadowing effects may prevent complete coverage when applying coating
 - Coating may flow/thin prior to completion of cure
 - Thinner coatings are more prone to whisker puncture
- Conclusion 3: *Even “Poor” Coatings Can Offer Some Protection*
 - Long whiskers bend easily (Euler Buckling) and are less likely to re-penetrate even thin conformal coat applied on a distant conductor.
 - Conformal coat protects against a conductive bridge from detached whiskers lying across a pair of coated conductors