

# Containerless Processing Studies in the MSFC Electrostatic Levitator

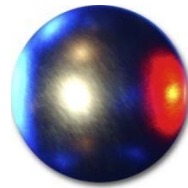

**Jan Rogers and Mike SanSoucie**  
**NASA/MSFC/EM50, Huntsville, AL**

AIAA Aerospace Sciences Meeting, Nashville, TN  
January 11, 2012

# Electrostatic Levitation (ESL) Team

- MSFC ESL Team:
  - Trudy Allen, Info Pro
  - Curtis Bahr, Glenn Fountain, Qualis
  - Mike SanSoucie, EM50
  - Dr. Jan Rogers, EM50
  - Bill Witherow, EV43

# Outline

- Introduction
- ESL Facility Description
- Selected Results
- ISS Investigations Supported
- Conclusions/Future Work

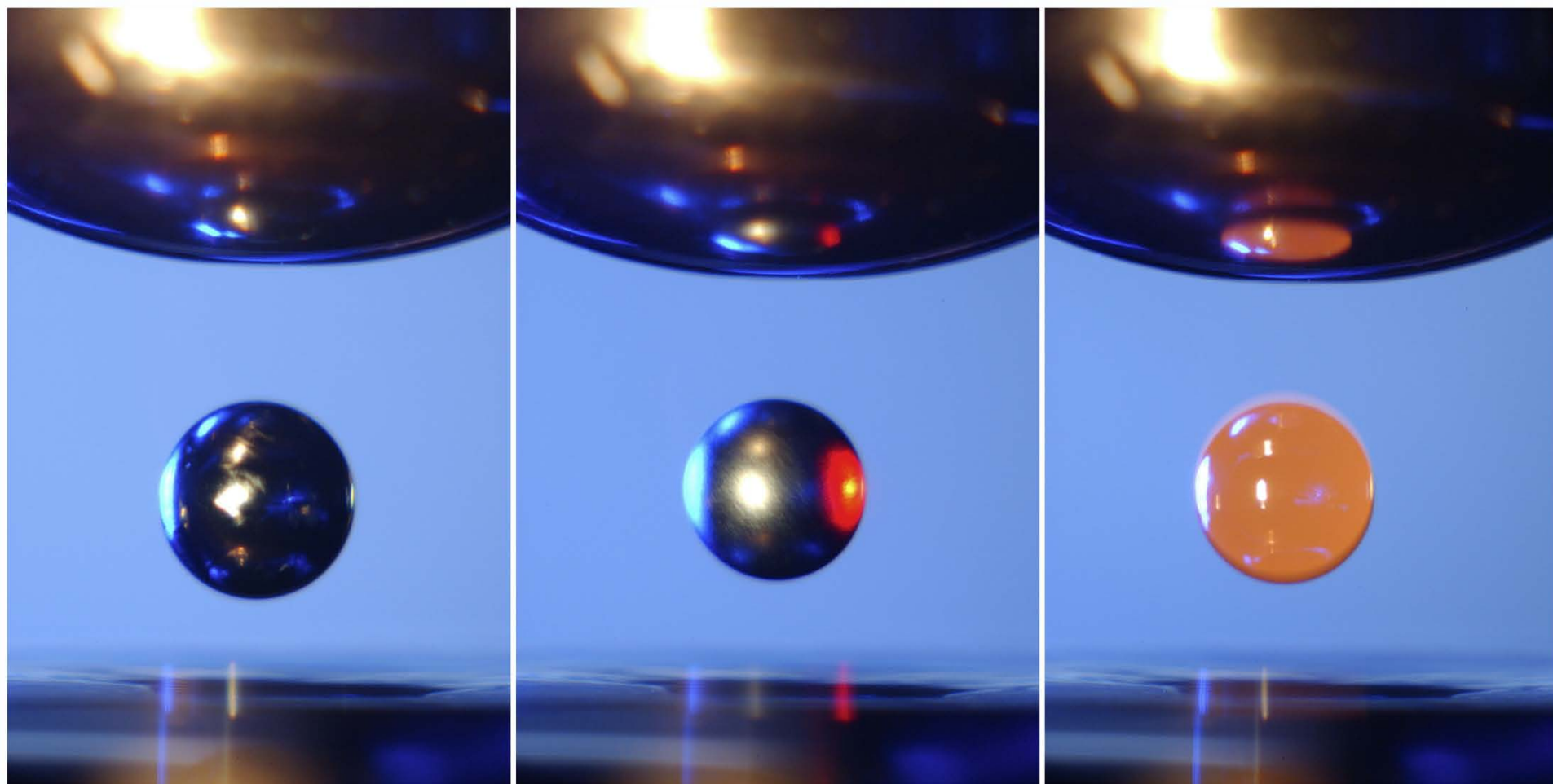

- ESL provides an ideal, containerless method for the study of undercooled melts and metastable states.
- Levitated samples do not contact a container and will not be contaminated by the container or react with it.
- Pyrometry, or non-contact temperature measurements employed in ESL.
- ESL provides a ground-based system to study levitated specimens to complement space-based levitation studies. (ESA's electromagnetic levitator cannot process samples in 1-g)

# MSFC ESL Facility

- The MSFC ESL Facility is a materials characterization facility which provides materials characterization data to users
- Data files for thousands of melt cycles and hundreds of samples have been delivered to investigators, resulting in the development of new alloys, glasses and numerous technical papers and journal articles
- The MSFC Electrostatic Levitation (ESL) facility can provide measurements of thermophysical properties, which include creep strength, density and thermal expansion, emissivity, specific heat and phase diagrams. For melts, viscosity and surface tension can be measured.
- Data can be obtained at ultra-high temperatures for materials being developed for propulsion applications.
- Samples 2-3 mm diameter spheres (30-70 mg)
- Heated by lasers: Nd:YAG, CO<sub>2</sub> and solid state

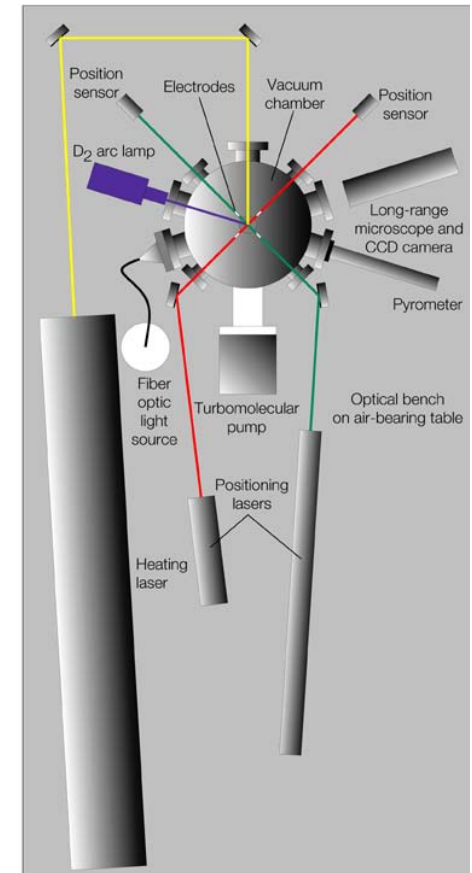

## Materials Processed via ESL

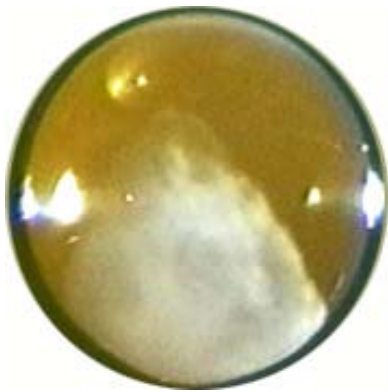

Glass Melt  
with  
Crystallites

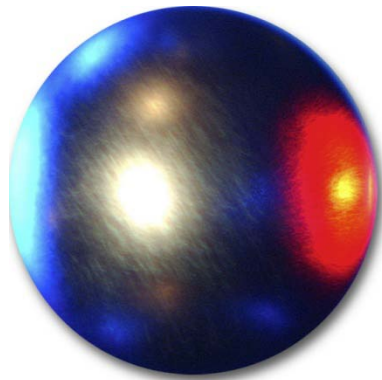

Metals and  
Alloys



Ceramics, including  
pressed materials  
like  $ZrB_2$

Other materials include polymers, semiconductors, solids, melts and liquids.

Delivered data files for hundreds of samples to customers since 1997.

# Nickel Melt Cycle

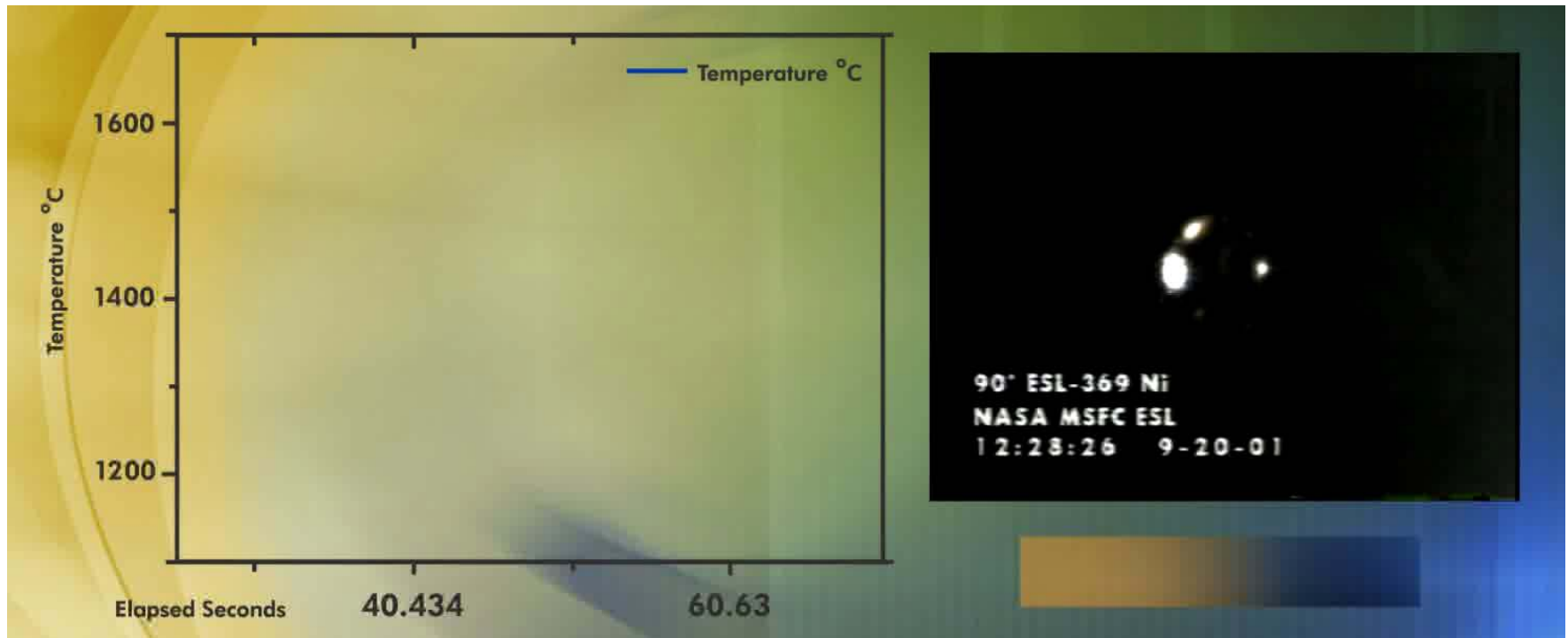



## ESL System for Operations UHV- 5 atm.

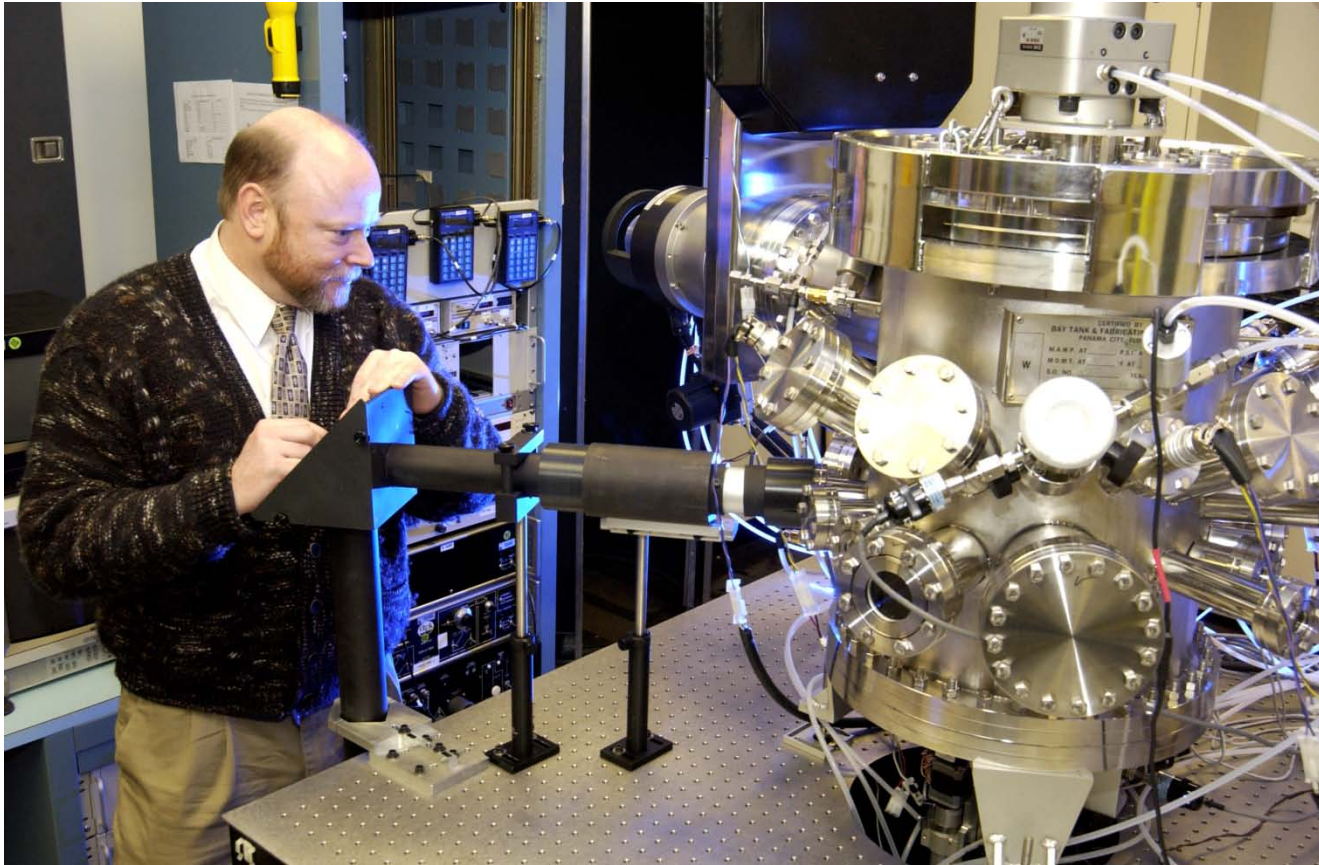



# Sample Fabrication Methods and Shapes

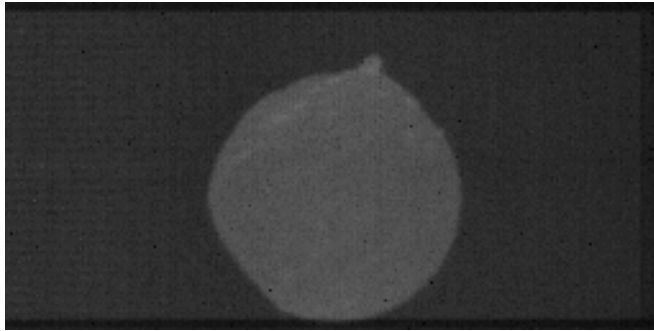

Machined by general-purpose machine shop from Nb rod

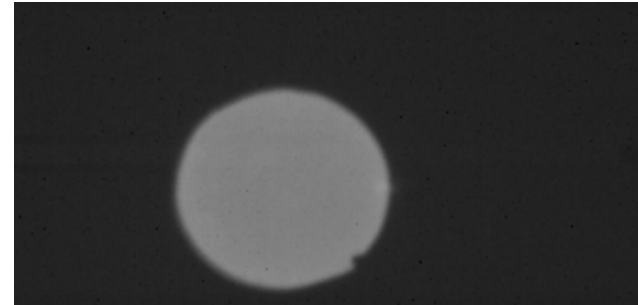

Arc melted Nb by ESL personnel

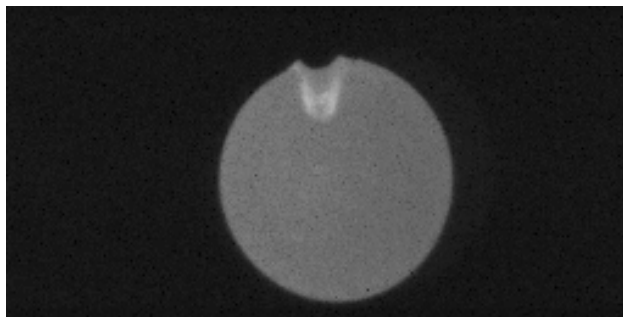

Nb ESL melted and scribed

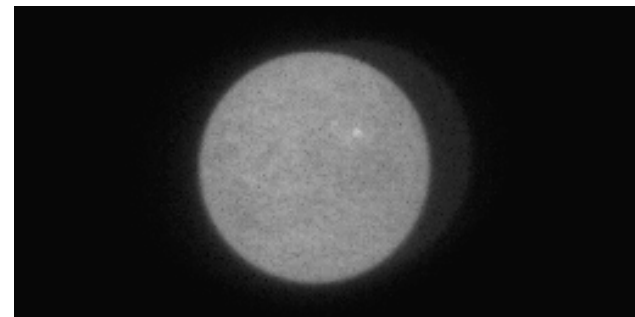

Nb machined by Industrial Tectonics Inc., precision sphere mfg specialists

## Non-contact Temperature Measurement Tools

- Single wavelength/band pyrometers for the range: 200-3500 °C
- Two wavelength pyrometers for the range: 700-1400 °C
- Blackbody calibration source with operating range: 600-3000 °C
- Multi-wavelength spectropyrometers from FAR Associates provide temperature measurements with no operator input, even when the target's surface characteristics change with temperature or processing for the ranges:
  - 800-4000 °C
  - 300-2000 °C.

## ESL Facility Capabilities

- **Phantom V7 provides 12 bit monochromatic images with 800x600 pixel resolution at rates up to 160,000 frames per second.**
- **Redlake Motion ProModel 10,000 provides 8 bit monochromatic images with 1280x1024 pixel resolution at rates up to 10,000 frames per second.**
- **Optical viewports are available on the chambers for user-provided equipment.**
- **Sample load lock and carousel mechanism support high-throughput processing.**
- **Processing at  $10^{-8}$  Torr or at pressures up to 5 atm.**
- **An arc melter is available for sample fabrication.**
- **Additional capabilities include: RGA and mass scales with 1 microgram resolution are available for pre- and post-process weighing to determine mass losses.**

# Density Data Analysis

- **Data from video images**
- **Computer detects edges, calculates volume vs. time**
  - Needs good contrast
- **Correlated with pyrometry, known mass gives density vs. temperature**
- **Typical precision: ~ 0.1% liquid, ~0.05% machined sphere, ~2% sample solidified in ESL**
- **Standard ESL backlighting uses a white light source**
- **At high temperatures, sample becomes a very bright, radiant object and contrast becomes poor**
- **Illumination system designed for high temperature studies using blue laser provide good edge detection to 2800° C.**

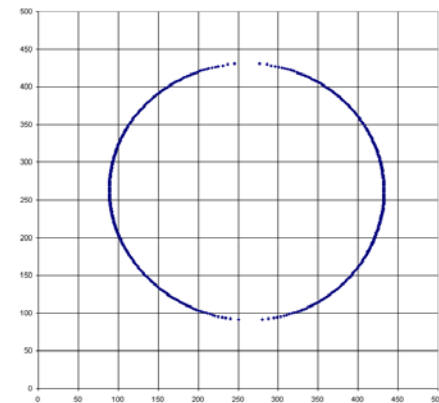
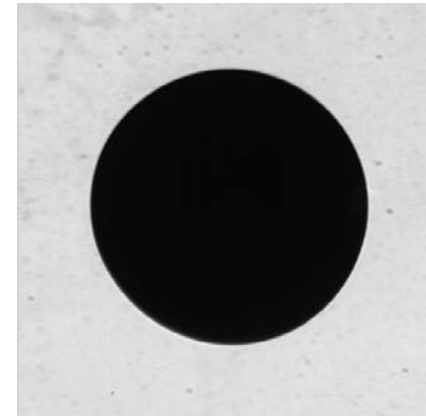

Backlit sample showing excellent contrast and computer detected edge

# Density of solid and liquid Ti<sub>39.5</sub>Zr<sub>39.5</sub>Ni<sub>21</sub>

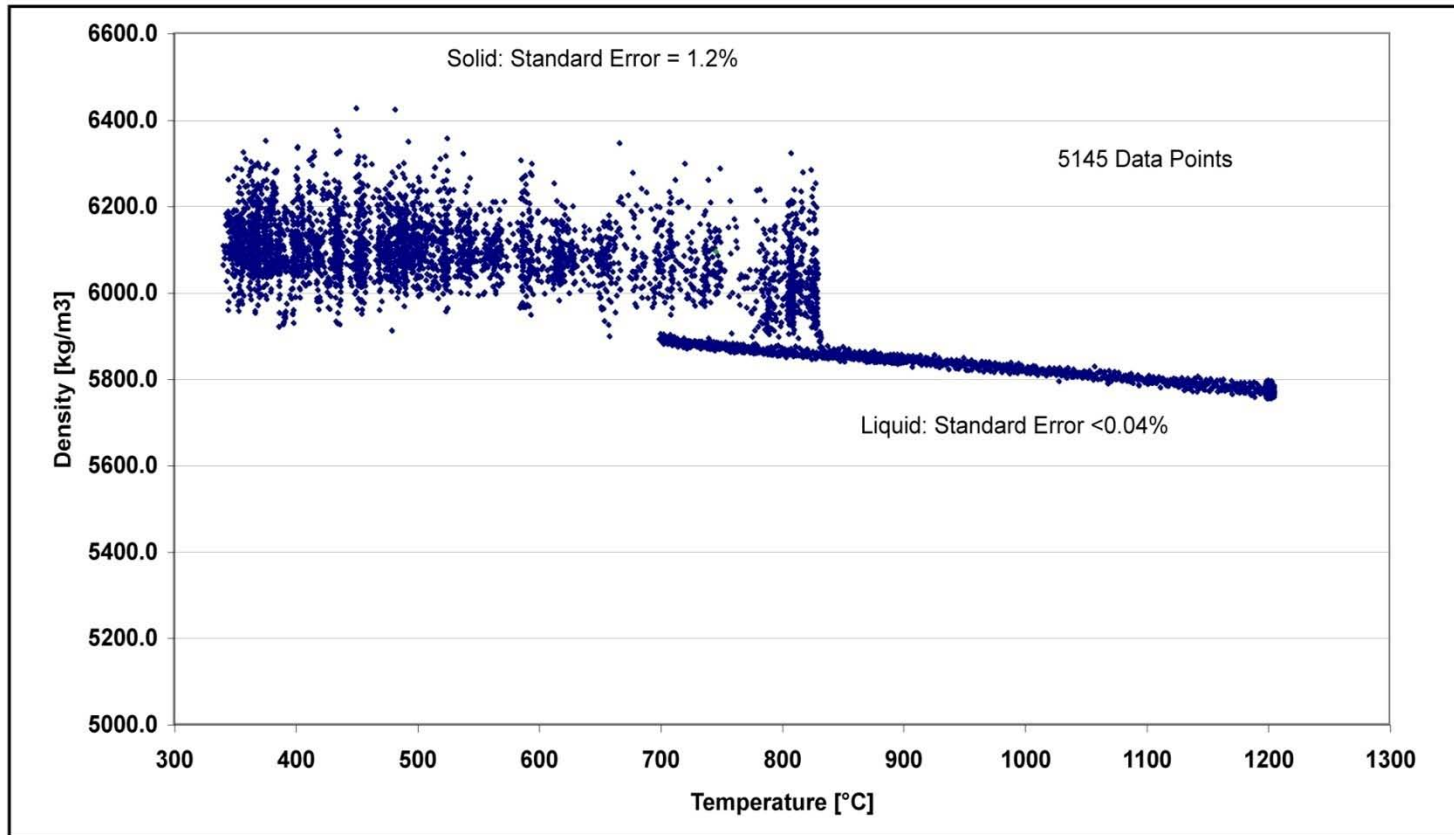

Note: Solid sample was not a precision-machined sphere, and had an irregular shape. Upon melting, the samples become more axisymmetric and the error was greatly reduced.

# Oscillating Drop Method: Viscosity and Surface Tension

- Viscosity and surface tension data needed for advanced modeling of welding and casting
- Damped Oscillations  $\text{Ti}_{37}\text{Zr}_{42}\text{Ni}_{21}$  at 1048 K
- Recorded at 1000 fr/sec, played at 10 fr/sec

$$\omega_l = \sqrt{\frac{l(l-1)(l+2)\gamma}{\rho R_o^3}} \quad \text{Rayleigh (1879)}$$

$$\tau_l = \frac{\rho R_o^2}{(l-1)(2l+1)\mu} \quad \text{Lamb (1881)}$$

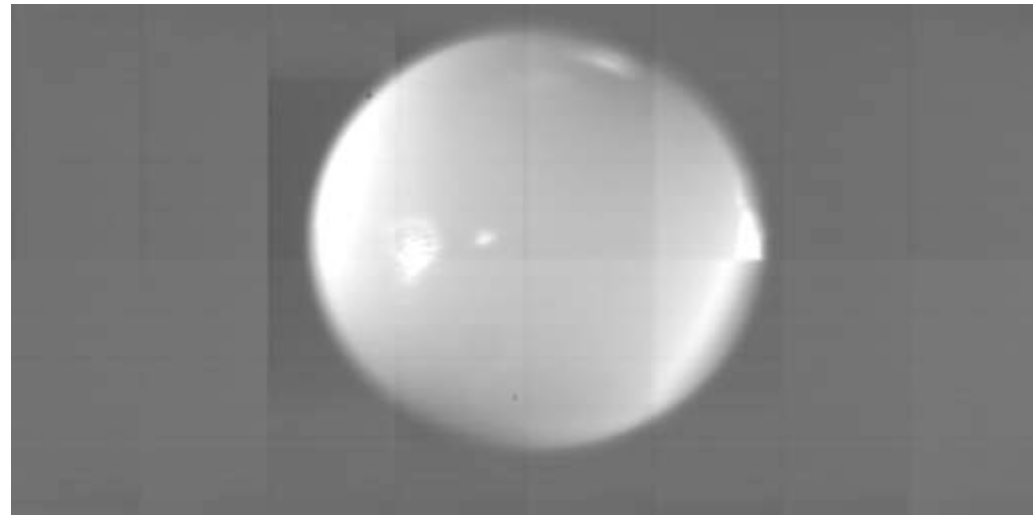

# Phase Diagram Studies

## Portable ESL at Argonne National Lab (ANL)



## X-ray diffraction image from ESL processing at ANL



- Portable ESL used at the high energy (125 keV) synchrotron x-ray source at ANL .
- Provides *in-situ* determination of the atomic structures of equilibrium solid and liquid phases, including undercooled liquids, as well as real-time studies of solid-solid and liquid-solid phase transformations. Studies performed to support Dr. Kelton.
- Use of image plate (MAR345) or GE-Angio detectors enables fast (30 ms – 1s) acquisition of complete diffraction patterns
- More rapid and accurate technique than conventional methods which involve annealing and quenching (to try and preserve high-temperature structure) with subsequent room-temperature x-ray diffraction and electron microscopy studies



# ESL Emissometer System

- Data needed for thermal design
- Emissometer developed by AZ Technology
- Temperature range:
  - 700 to 3500K
- FT-IR capabilities:
  - 0.400 to 28-um
  - Emittance mode
  - Multiple scan ranges
  - Filtering for heating laser wavelengths
- Blackbody source operated at same temperature as sample with matched collection geometry
- Emittance data from sample and blackbody source integrated over spectral range
- Ratio provides measure of total hemispherical emittance
- Preliminary tests with Inconel and stainless steel show good agreement with literature.

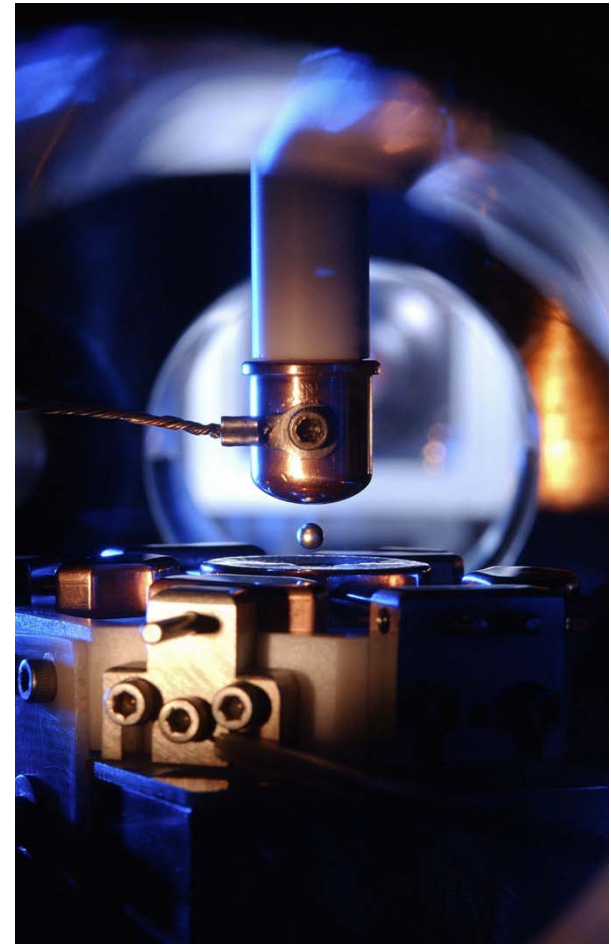

# Schematic of System for Emissivity Measurements

Configuration A: Blackbody Calibration

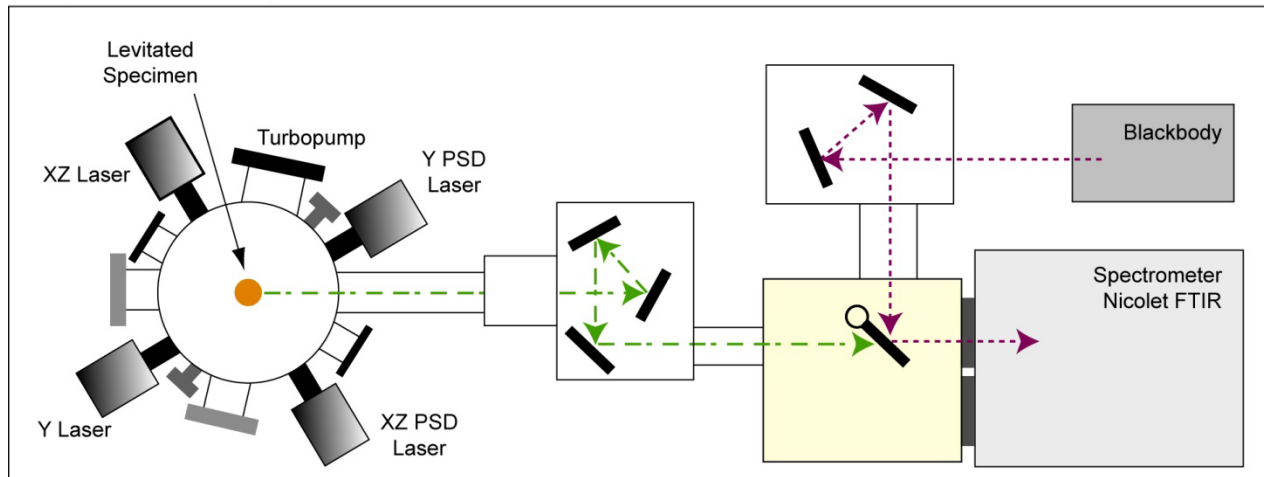

Configuration B: Emissivity Measurements

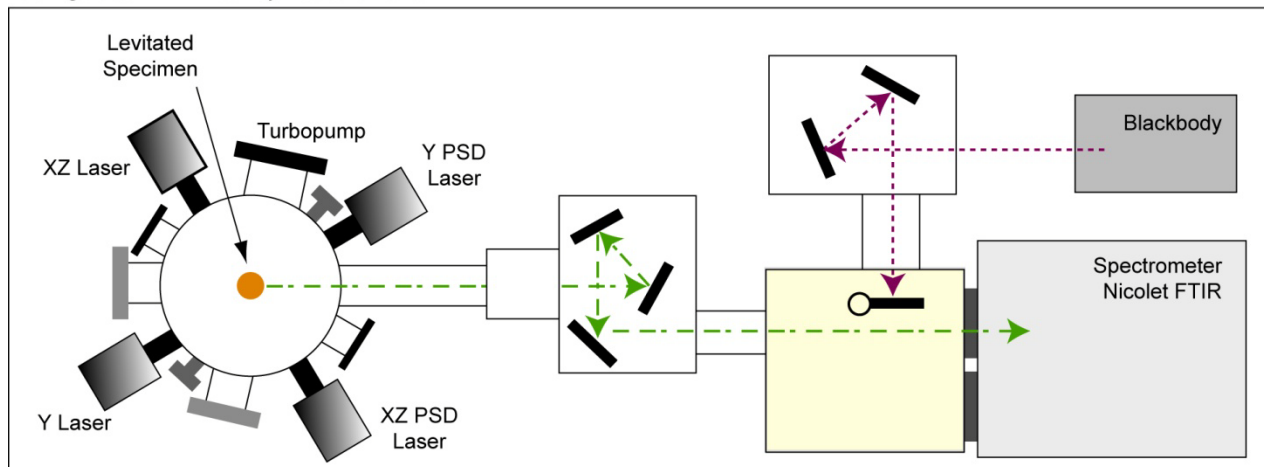

# Phase Selection in Stainless Steel

- Double Recalescence in 72Fe-11.2Cr-16.8Ni Stainless Steel
- Processed in MSFC ESL July 23, 2001
- Recorded at 40,500 frames/sec, played at 10 frames/sec
- Project: “The Role of Convection and Growth Competition on Phase Selection in Microgravity” (LODESTARS-Dr. Matson)

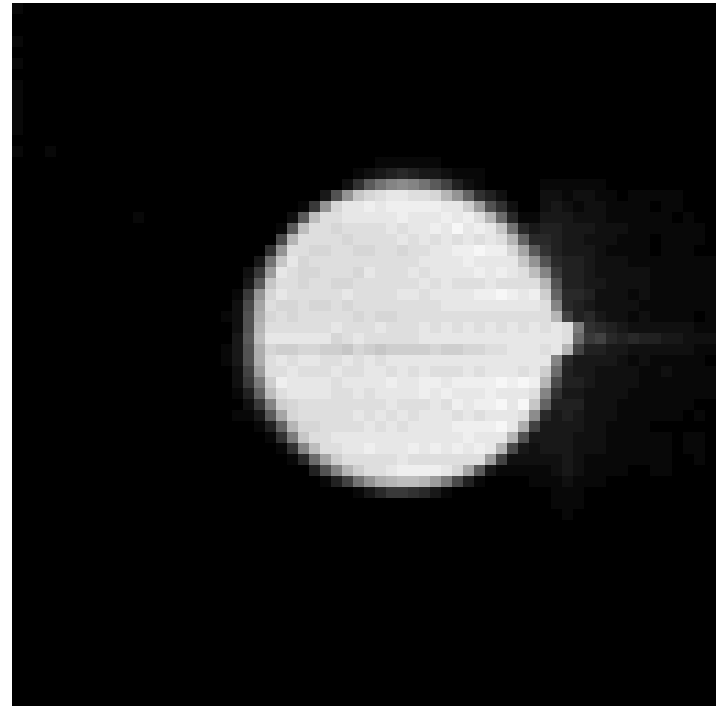

# Triggering NiNb

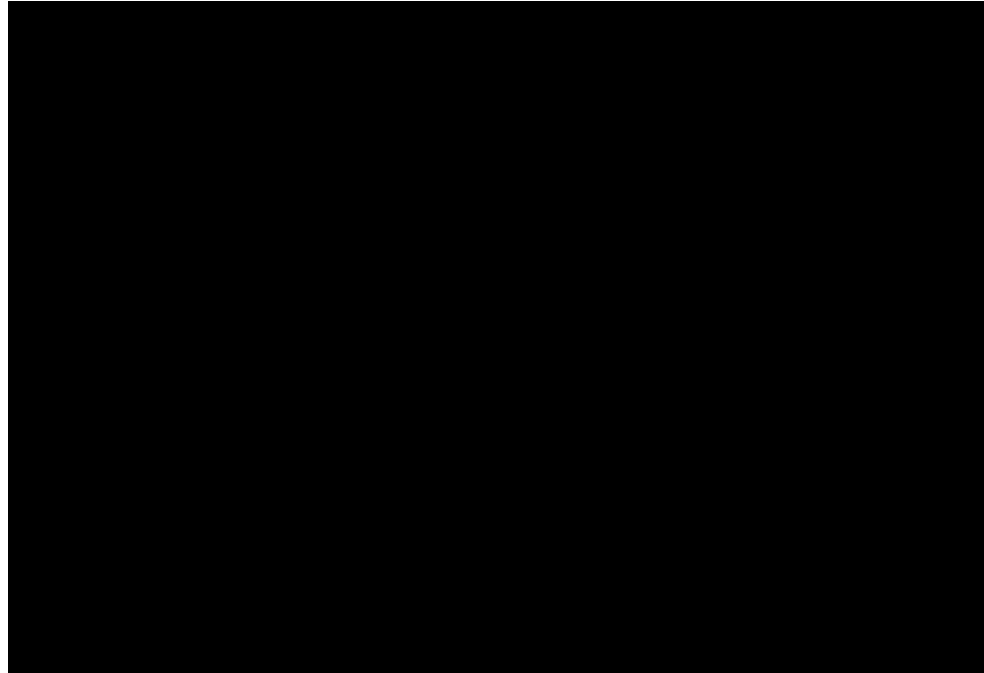

# ISS Investigations

- NASA scientists participate in studies using the ESA/DLR electromagnetic levitation system (EML) as members of Topical Teams:
  1. Thermophysical Properties of Liquid Metallic Alloys - Modelling of Industrial Solidification Processes and Development of Advanced Products (THERMOLAB-ISS)
  2. Thermophysical properties and solidification behaviour of undercooled Ti-Zr-Ni liquids showing an icosahedral short-range order (ICOPROSOL)
  3. Peritectic Alloy Rapid Solidification with Electromagnetic Convection (PARSEC)

# ISS Investigations Supported

1. Dr. Roberts Hyers, University of Massachusetts, “Unified Support for THERMOLAB-ISS, ICOPROSOL, and PARSEC”
2. Dr. Ken Kelton, Washington University, “Studies of Nucleation and Growth, Specific Heat and Viscosity of Undercooled Melts of Quasicrystals and Polytetrahedral-Phase-Forming Alloys”
3. Dr. Ken Kelton, Washington University, “NASA Research under ESA-Based Investigations THERMOLAB and ICOPROSOL”
4. Dr. Doug Matson, Tufts University, “Electromagnetic Levitation Flight Support for Transient Observation of Nucleation Events” (ELFSTONE)
5. Dr. Doug Matson, Tufts University, “Levitation Observation of Dendrite Evolution in Steel Ternary Alloy Rapid Solidification” (LODESTARS)

## Conclusions/Future Work

- **ESL support for ground-based studies:**
  - **Sample processing to provide ground-based levitation studies to assist in the development of flight experiments.**
  - **Ground-based levitation studies with oxygen control system to study the effects of partial pressure of oxygen and thermophysical properties and nucleation**
- **Development of a quench system for undercooling and microstructure studies.**

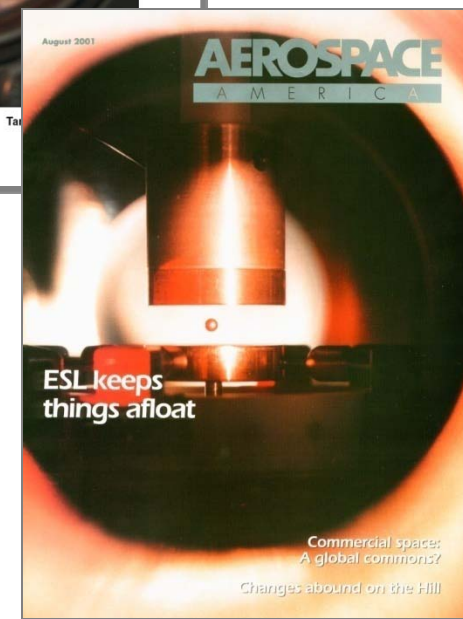
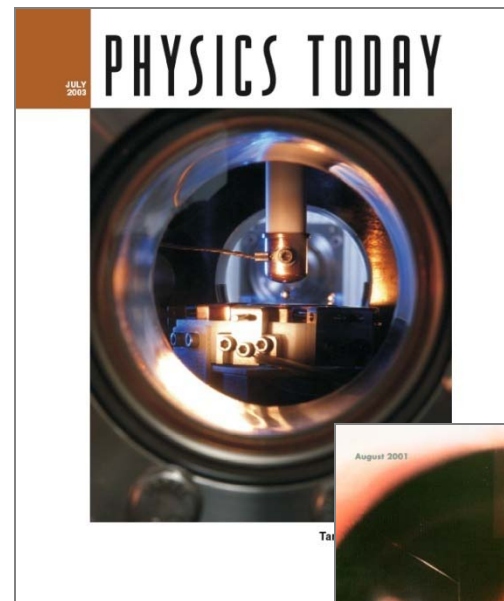



**BACKUP**

# Ultra-High Temperature Creep Resistance via ESL

- Recent project completed to develop, validate and utilize a new ESL technique for studies of creep resistance at ultra-high temperatures. Major project tasks included:
  - Use of centrifugal acceleration (from photon pressure) to induce creep in levitated samples.
  - Capture of images of sample deformation at specified temperatures and times for analysis.
  - Development of software for on-line rotation analysis and creep measurements.
  - Development of predictive finite element model of stress/strain in samples.
  - Validation tests using conventional ASTM test methods.
  - Structural analysis of samples following ESL studies to examine deformation behavior and texture development
  - Magnetic rotation apparatus provides rotation rates up to 30,000 rps
- Results from ESL tests show excellent agreement with results from validation testing at high temperature materials facilities using ASTM Standard E-139.**
- Maximum temperature achieved for Nb creep using state-of-the-art high temperature furnaces was 1985° C
- ESL creep tests with Nb performed successfully at 2300° C (Nb mp ~ 2486° C), higher temperatures are possible.

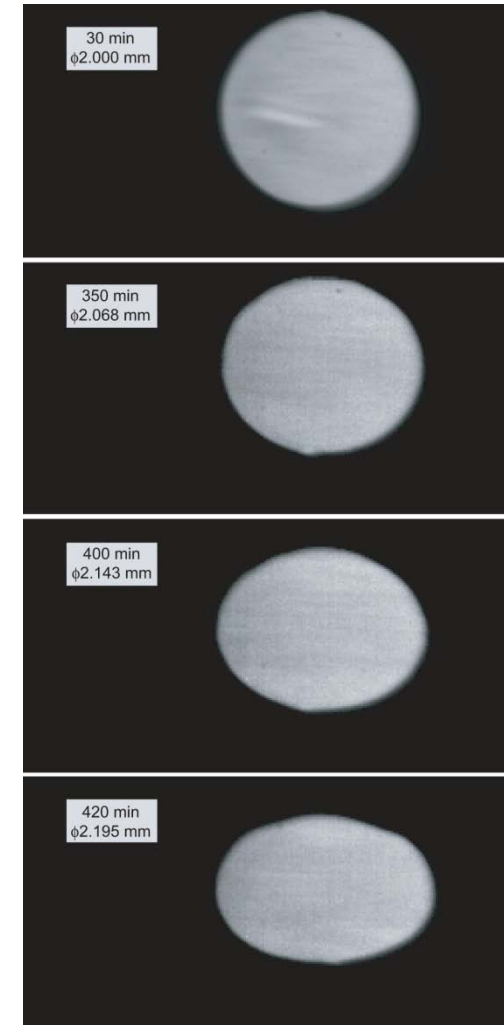

Nb at 1985° C

## Results from ESL Creep Studies

- Creep deformation of Nb at 1985° C was measured using both the ESL technique and a conventional testing method
- The stress exponent from the ESL and conventional creep tests show good agreement with data from literature
- The ESL method provides a unique capability for measuring creep at temperatures over 2000 C, as is required for numerous advanced aerospace applications.
- ESL represents a promising technique for determining creep properties of ultra-high-temperature materials

Method	Stress Exponent for Nb
ESL testing 2006	2.517
ASTM, furnace testing 2006	2.4
EML testing 1985	2.476
Extrapolation from low temp furnace data, 1982	4.4

Constitutive equation for creep in Nb, from Keissig, 1985:

$$\dot{\epsilon} = 2.64 \times 10^{-10} \sigma^{2.476} e^{-\left(\frac{55326}{T}\right)}$$