

Toward adaptive x-ray telescopes

Stephen L. O'Dell^a, Tim W. Button^b, Vincenzo Cotroneo^c, William N. Davis^c, Peer Doeld^d,
Charlotte H. Feldman^e, Mark D. Freeman^c, Mikhail V. Gubarev^a, Jeffery J. Kolodziejczak^a,
Alan G. Michette^f, Brian D. Ramsey^a, Paul B. Reid^c, Daniel Rodriguez Sanmartin^b,
Timo T. Saha^g, Daniel A. Schwartz^c, Susan Trolrier-McKinstry^h, Rudeger H. T. Wilke^h,
Richard Willingale^e, and William W. Zhang^g

^a NASA Marshall Space Flight Center, Space Science Office, Huntsville, AL 35812, USA

^b University of Birmingham, Metallurgy & Materials, Edgbaston, Birmingham B15 2TT, UK

^c Harvard-Smithsonian Center for Astrophysics, 60 Garden St., Cambridge, MA 02138, USA

^d University College London, Physics & Astronomy, Gower St., London WC1E 6BT, UK

^e University of Leicester, Physics & Astronomy, University Rd., Leicester, LE1 7RH, UK

^f King's College London, Physics, The Strand, London, WC2R 2LS, UK

^g NASA Goddard Space Flight Center, Greenbelt, MD 20771, USA

^h Pennsylvania State University, Materials Research Institute, University Park, PA 16802, USA

Abstract

Future x-ray observatories will require high-resolution ($< 1''$) optics with very-large-aperture ($> 25 \text{ m}^2$) areas. Even with the next generation of heavy-lift launch vehicles, launch-mass constraints and aperture-area requirements will limit the surface areal density of the grazing-incidence mirrors to about 1 kg/m^2 or less. Achieving sub-arcsecond x-ray imaging with such lightweight mirrors will require excellent mirror surfaces, precise and stable alignment, and exceptional stiffness or deformation compensation. Attaining and maintaining alignment and figure control will likely involve adaptive (in-space adjustable) x-ray optics. In contrast with infrared and visible astronomy, adaptive optics for x-ray astronomy is in its infancy. In the middle of the past decade, two efforts began to advance technologies for adaptive x-ray telescopes: The Generation-X (Gen-X) concept studies in the United States, and the Smart X-ray Optics (SXO) Basic Technology project in the United Kingdom. This paper discusses relevant technological issues and summarizes progress toward adaptive x-ray telescopes.

Key words: X-ray telescopes, x-ray optics, adaptive optics, piezoelectric devices

Abstract will be submitted to SPIE Optics + Photonics 2011 (August 21-25, San Diego) Conference OP403, *Optics for EUV, X-ray, and Gamma-ray Astronomy V*.

Optics for EUV, X-ray, and Gamma-ray Astronomy V (SPIE 8147)
2011 August 23-25; San Diego, CA (USA)

DRAFT 2011.08.18

Toward adaptive x-ray telescopes

Steve O'Dell

on behalf of the Smart X-ray Optics (UK)
and the Generation-X (USA) collaborations

Co-authors represent Smart X-ray Optics (UK) and Generation-X (USA) teams.

Steve O'Dell^a, Carolyn Atkins^{b,c}, Tim Button^d, Vincenzo Cotroneo^e,
Bill Davis^e, Peter Doel^b, Charly Feldman^f, Mark Freeman^e,
Mikhail Gubarev^a, Jeff Kolodziejczak^a, Alan Michette^g,
Brian Ramsey^a, Paul Reid^e, Daniel Rodriguez Sanmartin^d,
Timo Saha^h, Dan Schwartz^e, Susan Troler-McKinstryⁱ,
Rudeger Wilkeⁱ, Dick Willingale^f, & Will Zhang^h

^a NASA Marshall Space Flight Center (USA)

^b University College London (UK)

^c University of Alabama in Huntsville (USA)

^d University of Birmingham (UK)

^e Harvard–Smithsonian Center for Astrophysics (USA)

^f University of Leicester (UK)

^g King's College London (UK)

^h NASA Goddard Space Flight Center (USA)

ⁱ Pennsylvania State University (USA)

Astronomical x-ray telescopes need large area and high-resolution imaging.

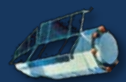

Einstein Observatory (1978-1981)
HPD = 10", $A = 0.04 \text{ m}^2$ ($f = 3.3 \text{ m}$)



ROSAT (1990-1999)
HPD = 5", $A = 0.10 \text{ m}^2$ ($f = 2.4 \text{ m}$)

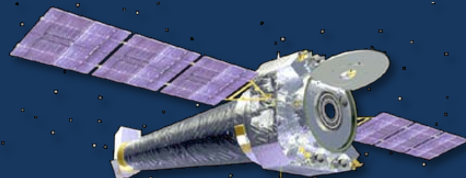

Chandra X-ray Observatory (1999-?)
HPD = 0.6", $A = 0.11 \text{ m}^2$ ($f = 10 \text{ m}$)

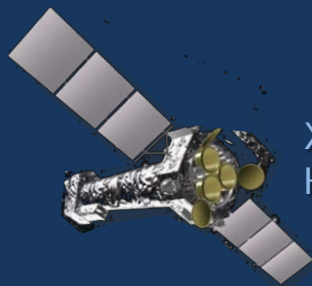

XMM-Newton (1999-?)
HPD = 14", $A = 0.43 \text{ m}^2$ ($f = 7.5 \text{ m}$)

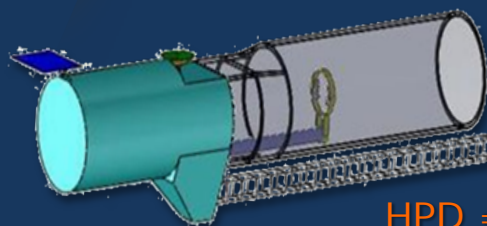

Generation-X (2035+)
HPD = 0.1"-1", $A \approx 5-50 \text{ m}^2$ ($f \approx 20-60 \text{ m}$)

IXO | ATHENA | Con-X (2022+)
HPD = 5"-10", $A \approx 1-3 \text{ m}^2$ ($f \approx 11-20 \text{ m}$)

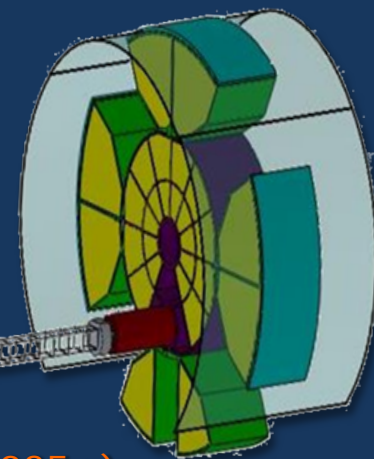
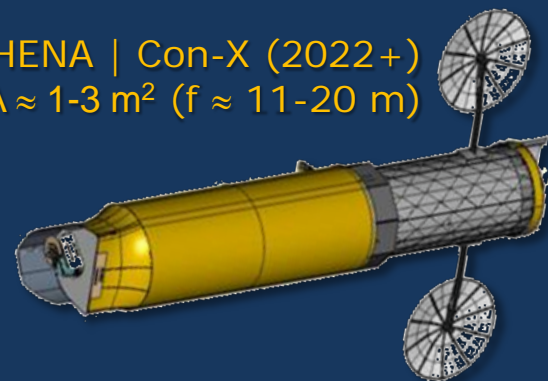

Higher resolution improves both imaging quality and sensitivity (noise reduction).

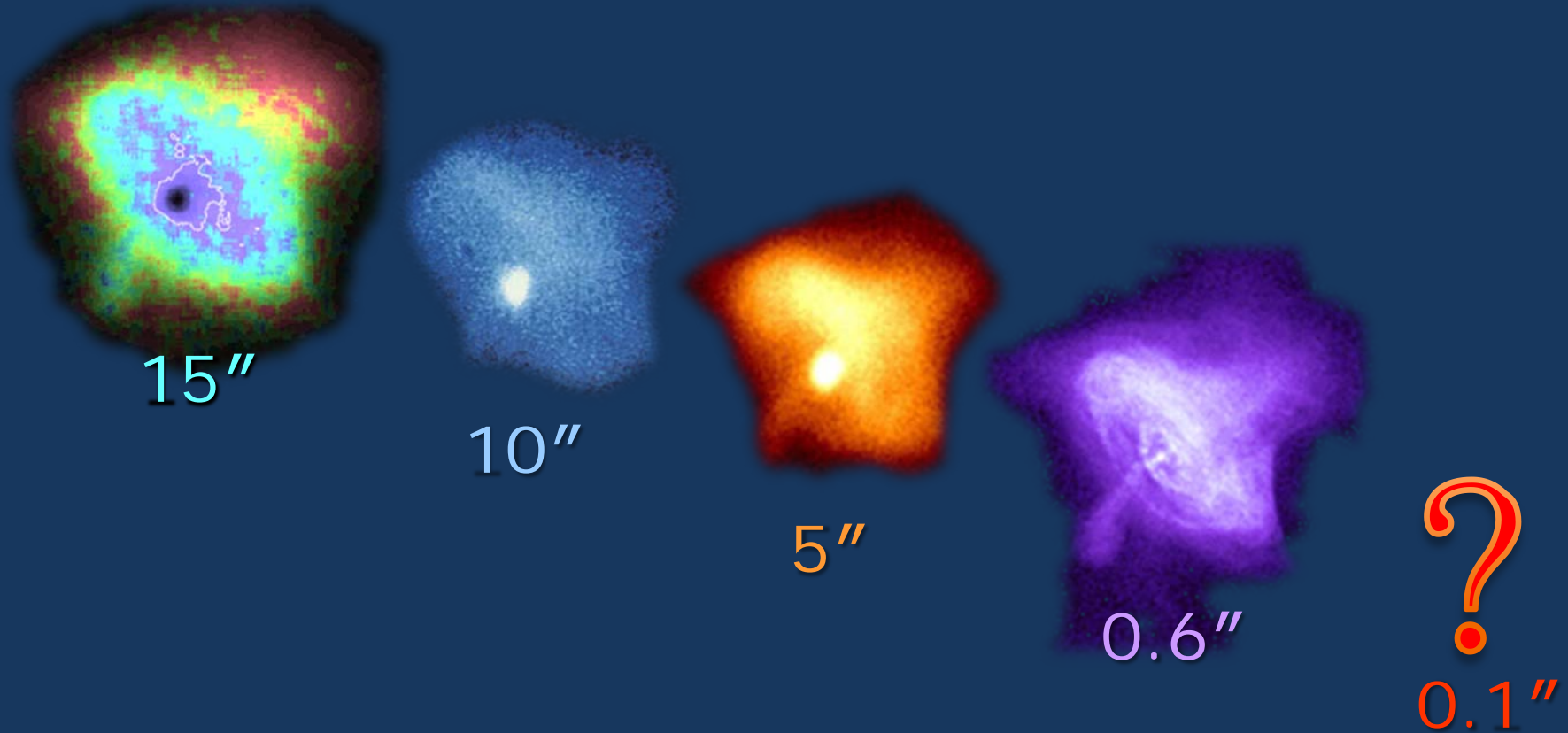

Aperture area improves sensitivity (signal increase), down to the confusion limit.

X-ray optics for in-space applications have some unique requirements.

- ▣ The standard metric for image quality is the half-power diameter (HPD) = half-energy width (HEW).
 - If axial-slope deviations (σ_α RMS) dominate and are gaussian, then $\text{HPD} = 1.35 \times 2(\sqrt{2}) \sigma_\alpha = 3.82 \sigma_\alpha$.
 - Here “high-resolution” means $\text{HPD} < 15''$ ($\sigma_\alpha < 19 \mu\text{r}$).
 - Generation-X goal is $\text{HPD} < 0.1''$ ($\sigma_\alpha < 0.13 \mu\text{r}$).
- ▣ Science objectives call for large aperture areas A_{ap} .
 - At grazing angle α , mirror surface area $A_{\text{surf}} \approx (2/\alpha)A_{\text{ap}}$.
 - Achieving this area requires highly nested shells.
 - Mass and volume limitations then require very thin, lightweight mirrors (1 kg/m^2), which easily distort.
 - High degree of nesting leaves no room for reaction structures for active optics \Rightarrow thin-film bimorphs.

The aperture areal-mass constraint for Generation X is similar to that of IXO.

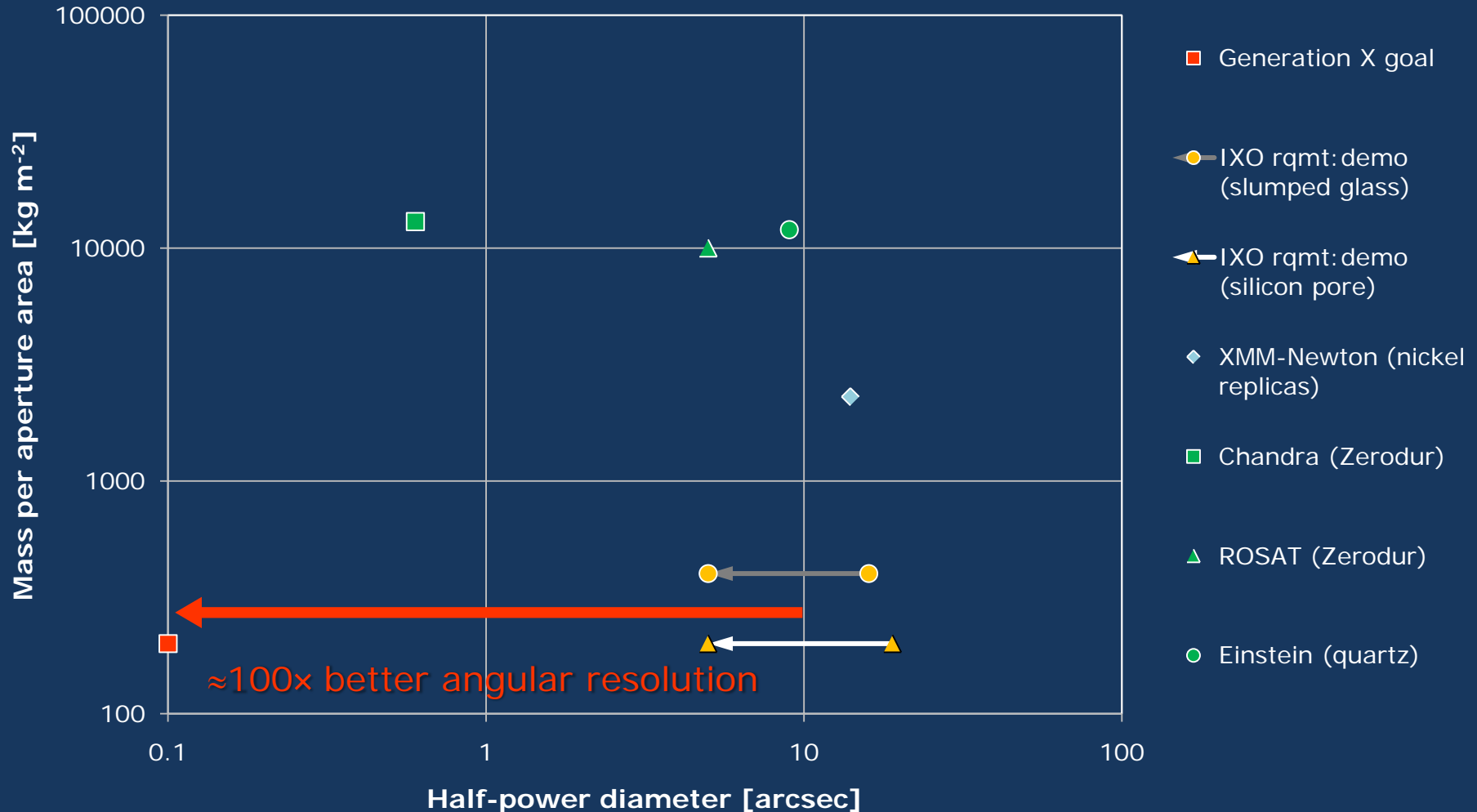

The aperture-area requirement for Generation X more than 10× that of IXO.

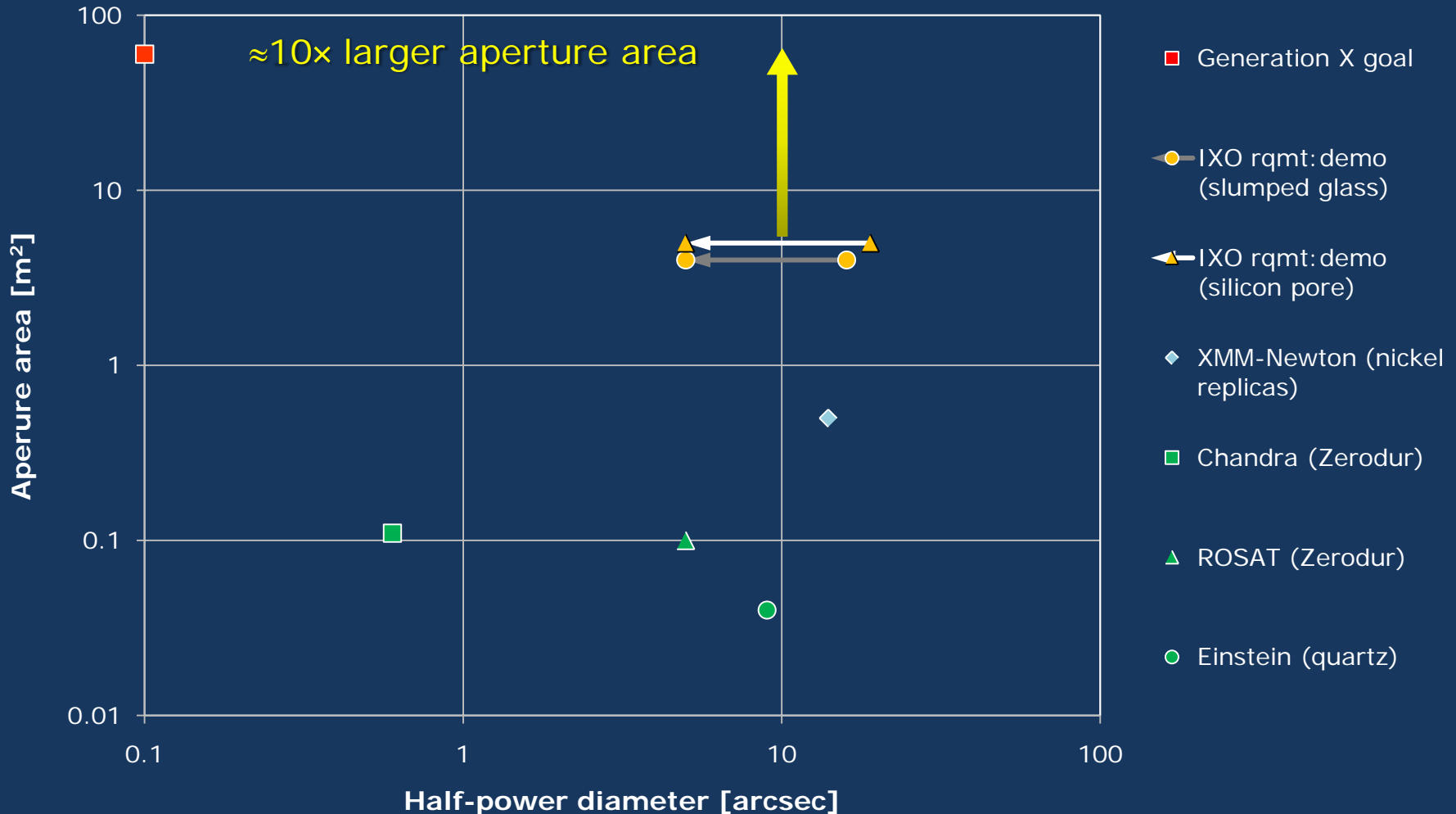

In principle, some segmented optics may be scalable to arbitrarily large areas.

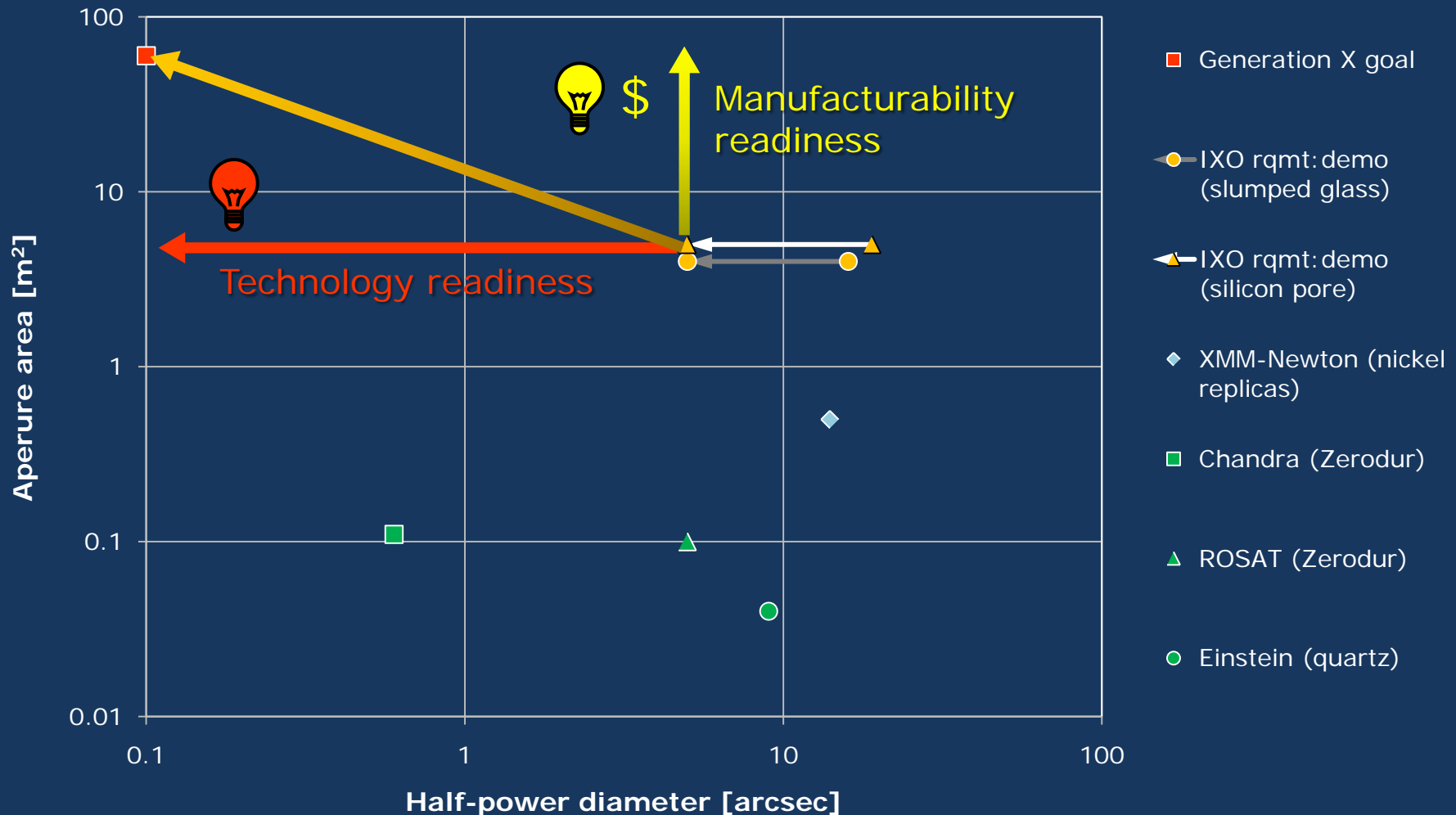

Programmatic constraints require innovation for manufacturing readiness.

- ▣ Optimize mandrel fabrication and replication.
 - Minimize post-replication corrections.
- ▣ Automate all processes as fully as possible.
 - Implement closed-loop fabrication & metrology.

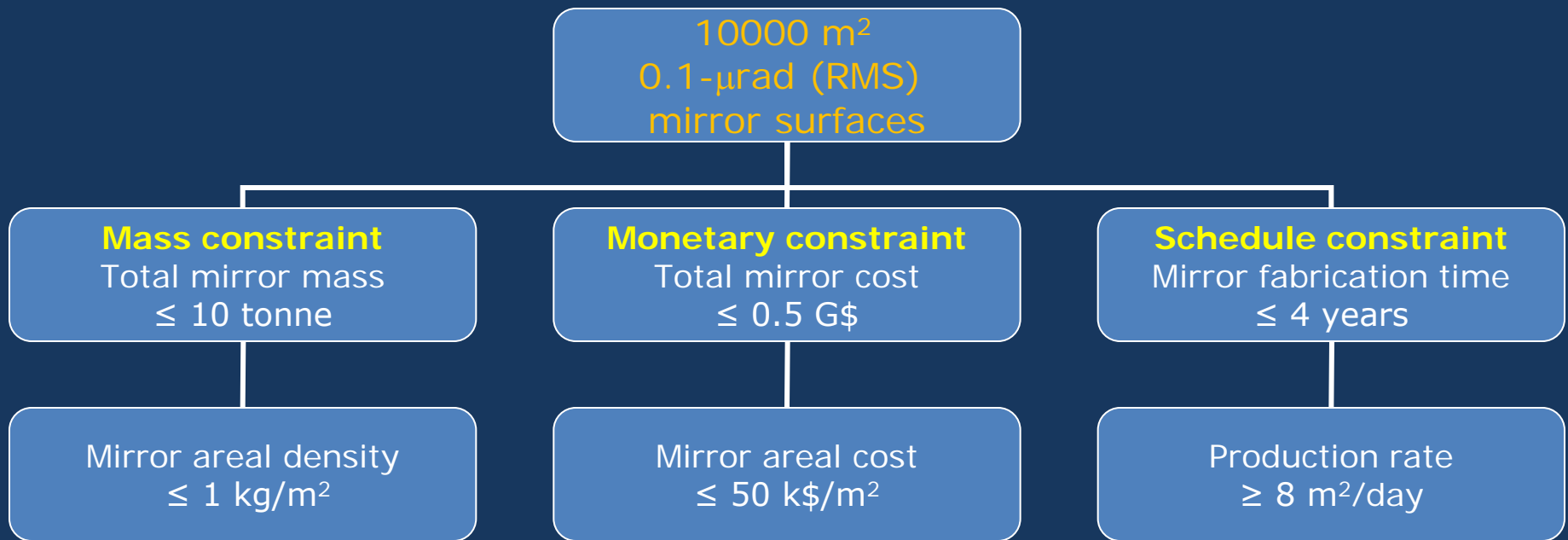

Summary

- ▣ Fundamental needs for future x-ray telescopes
 - Sharp images \Rightarrow excellent angular resolution.
 - High throughput \Rightarrow large aperture areas.
- ▣ Generation-X optics technical challenges
 - High resolution \Rightarrow precision mirrors & alignment.
 - Large apertures \Rightarrow lots of lightweight mirrors.
- ▣ Innovation needed for technical readiness
 - 4 top-level error terms contribute to image size.
 - There are approaches to controlling those errors.
- ▣ Innovation needed for manufacturing readiness
 - Programmatic issues are comparably challenging.

Smart X-ray Optics (SXO) consortium

- ▣ Funding
 - UK Engineering and Physical Sciences Research Council (EPSRC), Basic Technologies Grant
- ▣ Current members of the SXO consortium
 - University College London (UCL)
 - King's College London (KCL)
 - Scottish Microelectronic Centre (SMC)
 - University of Leicester (UoL)
 - University of Birmingham (UoB)
 - Daresbury Laboratory (DL)
 - Diamond Light Source [Associate member]
 - Silson Limited [Associate member]

Shaped piezoelectric pads, glued to back of mirror, modify the mirror's figure.

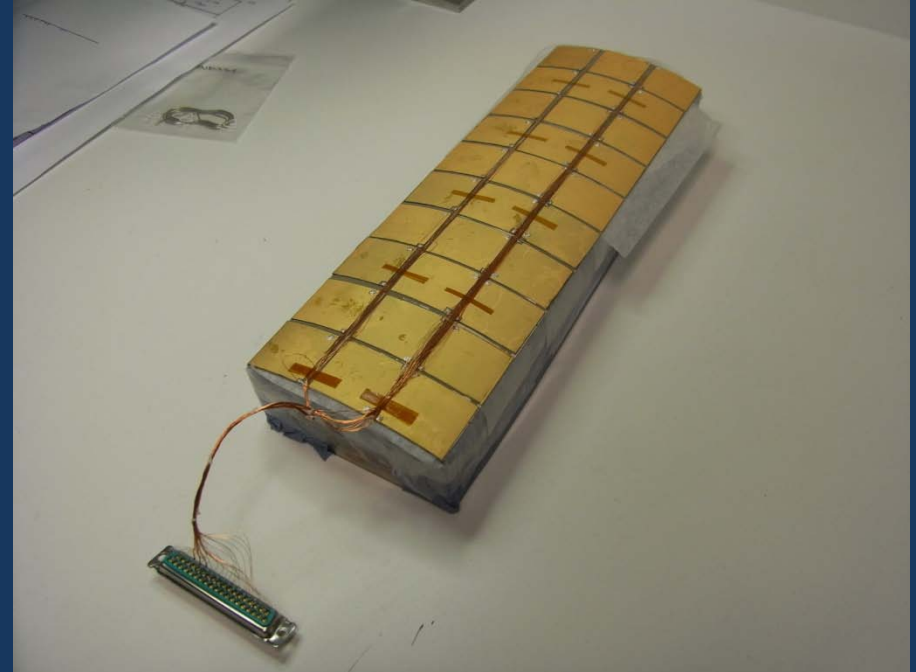
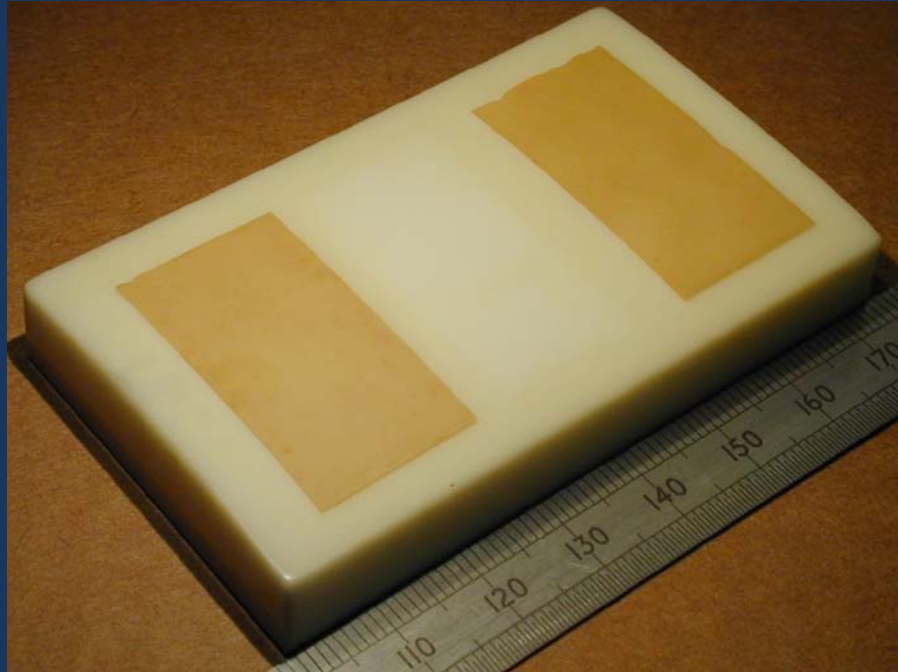

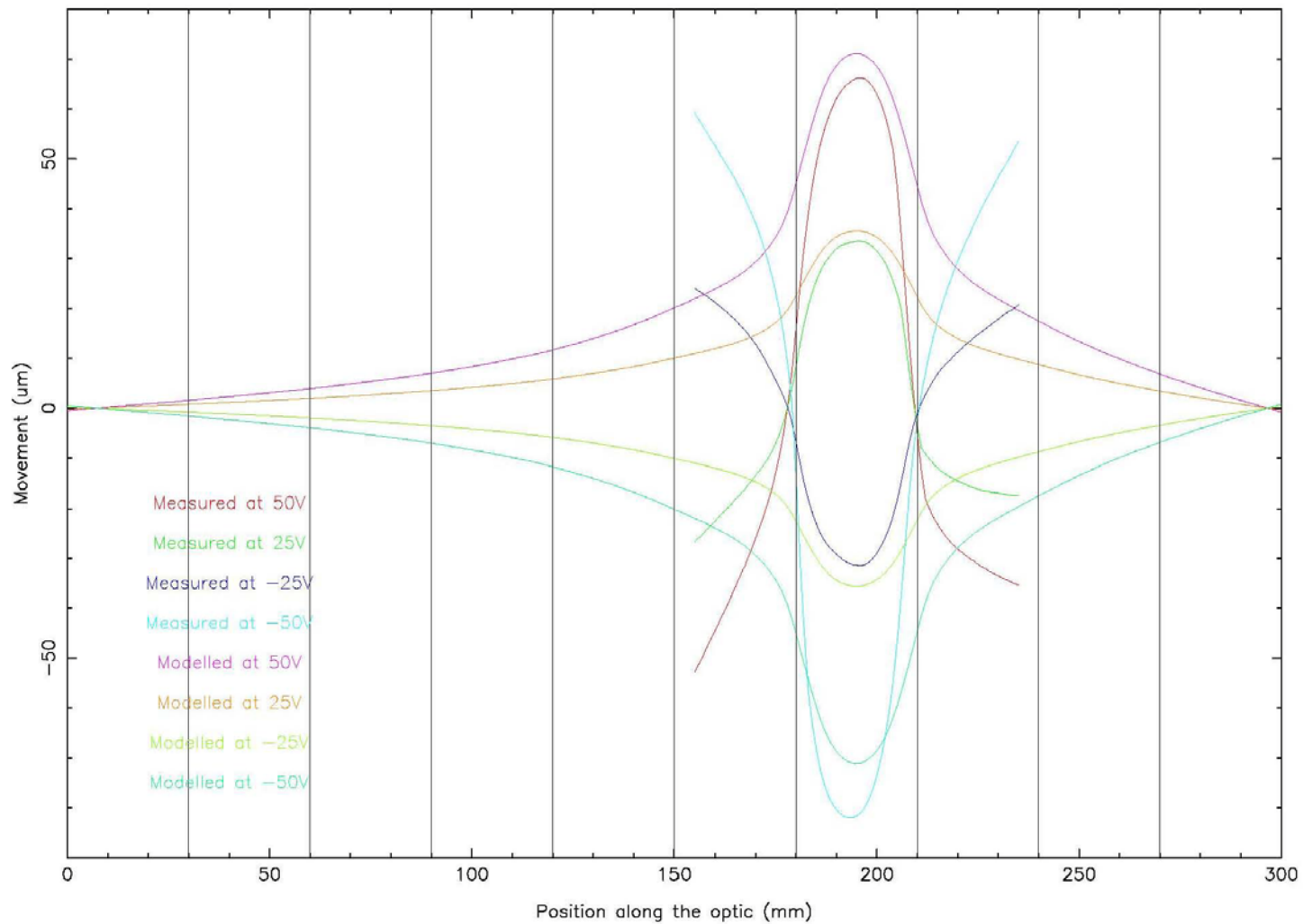

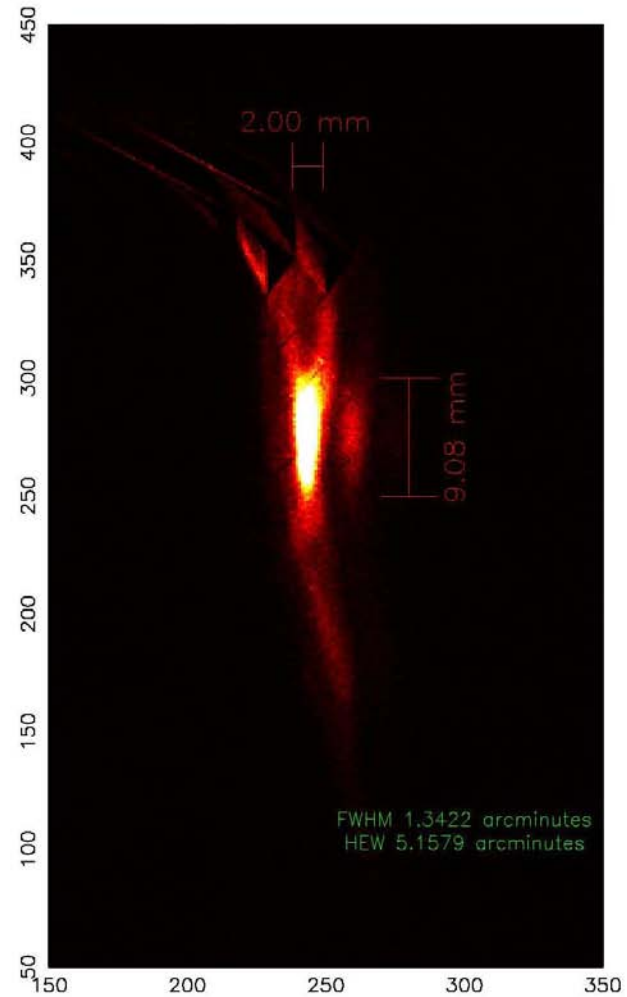
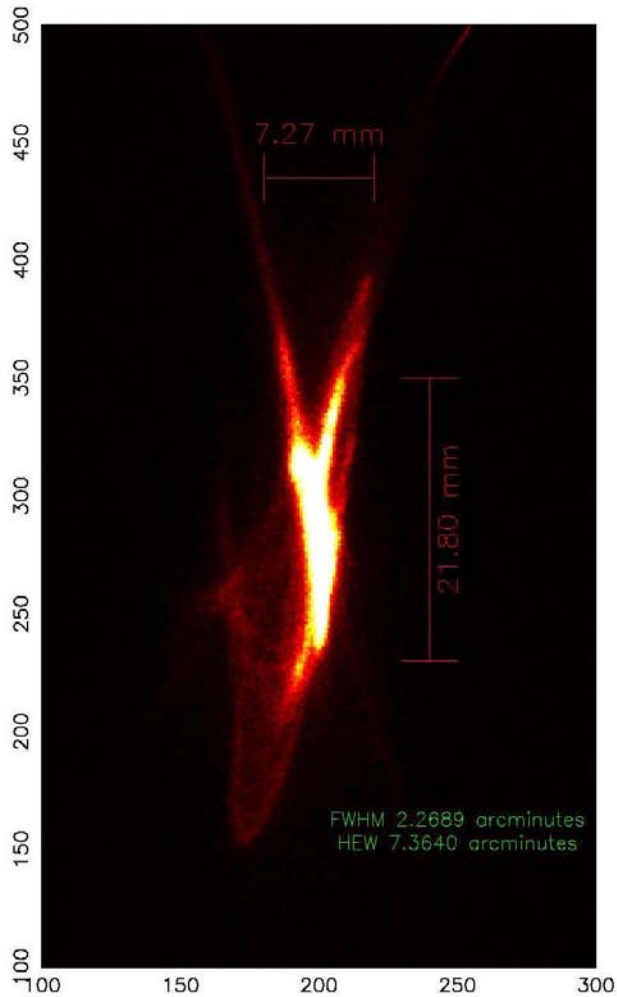

Distortion created by addition of the piezos – Power off

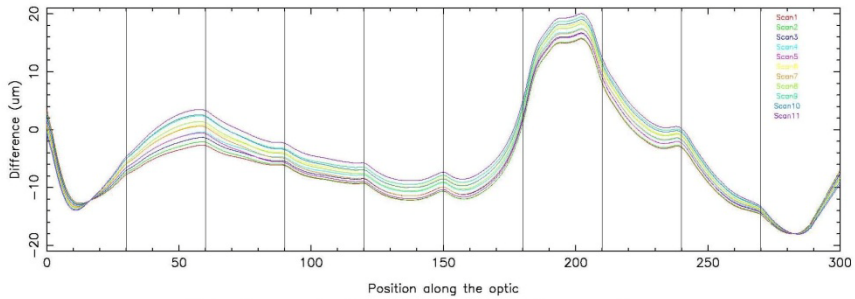

Distortion created by addition of the piezos – Power on

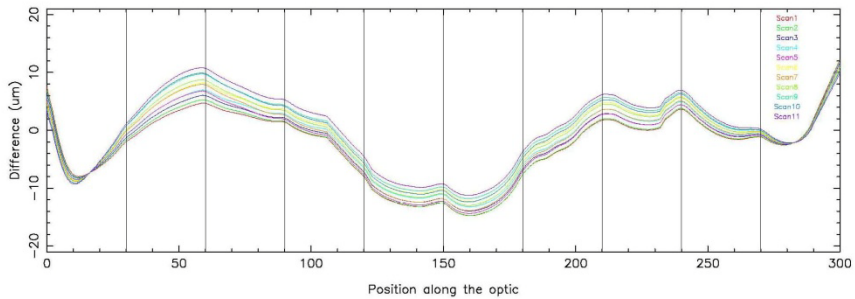

Change of HEW

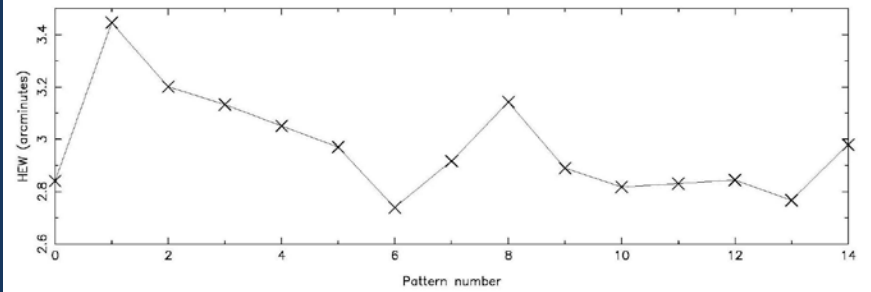

Change of FWHM

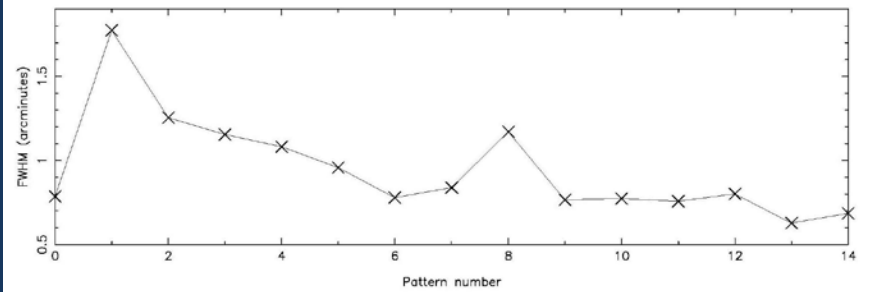

Generation-X Adjustable X-ray Optics team

▣ Funding

- National Aeronautics and Space Administration (NASA)
 - ▣ Vision and Astrophysics Strategic mission concept studies
 - ▣ Technology development
- Gordon and Betty Moore Foundation

▣ Principal members of the Gen-X optics team

- Smithsonian Astrophysical Observatory (SAO)
- NASA Marshall Space Flight Center (MSFC)
- NASA Goddard Space Flight Center (GSFC)
- Pennsylvania State University (PSU)
- Northrop-Grumman [Industrial collaborator]

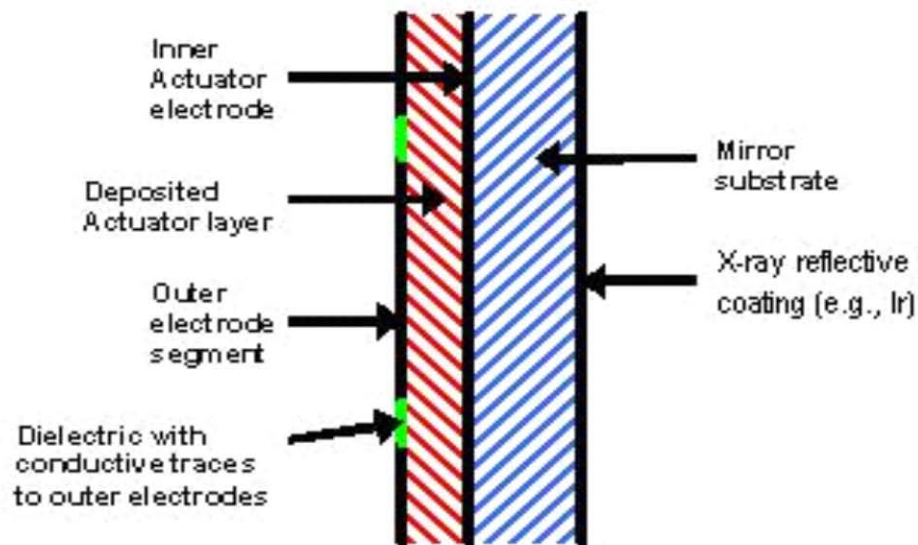
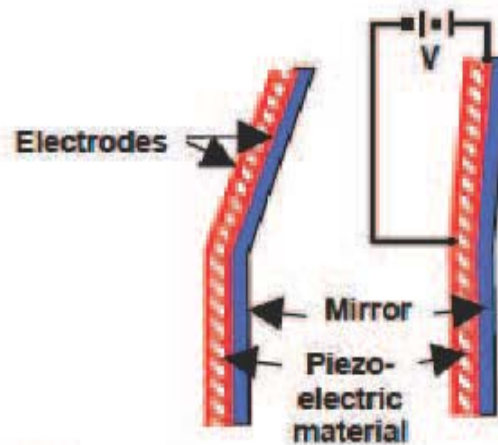

0101 111 1400000-0
 0101000001 1 1 0000 000000 0000 1.000000
 0000000000 1 1 0000 000000 1.000000
 0101000001 1 0000 000000 1.000000
 0101000001 1 0000 000000 1.000000
 VALUE OF DISPLACEMENT

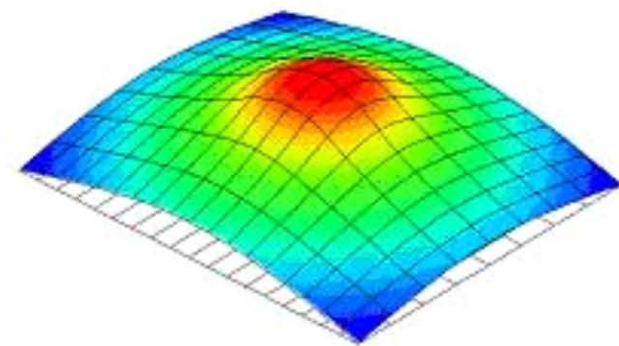

Normalized modeled and measured influence functions

Single piezo cell energized

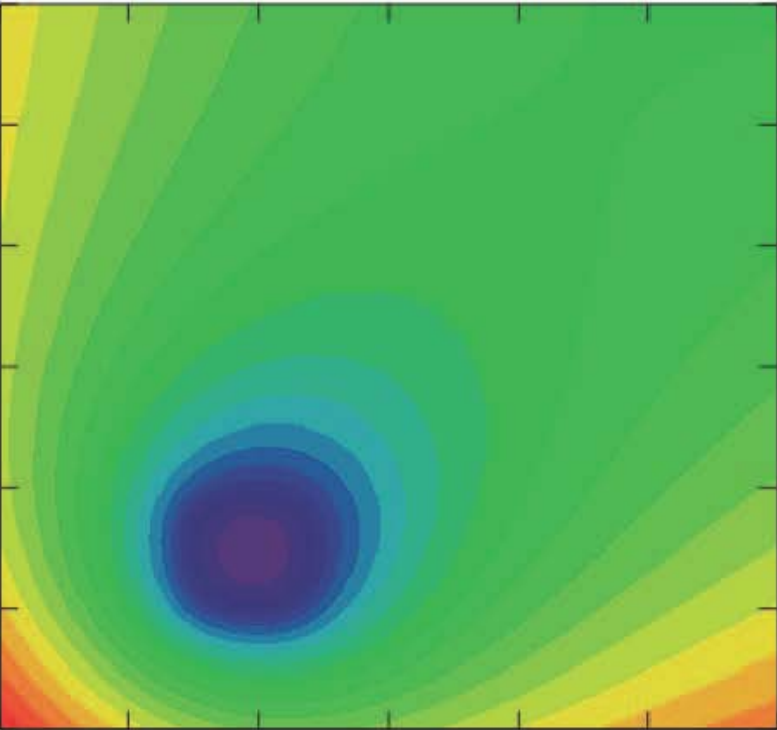

-data42

FE modeled

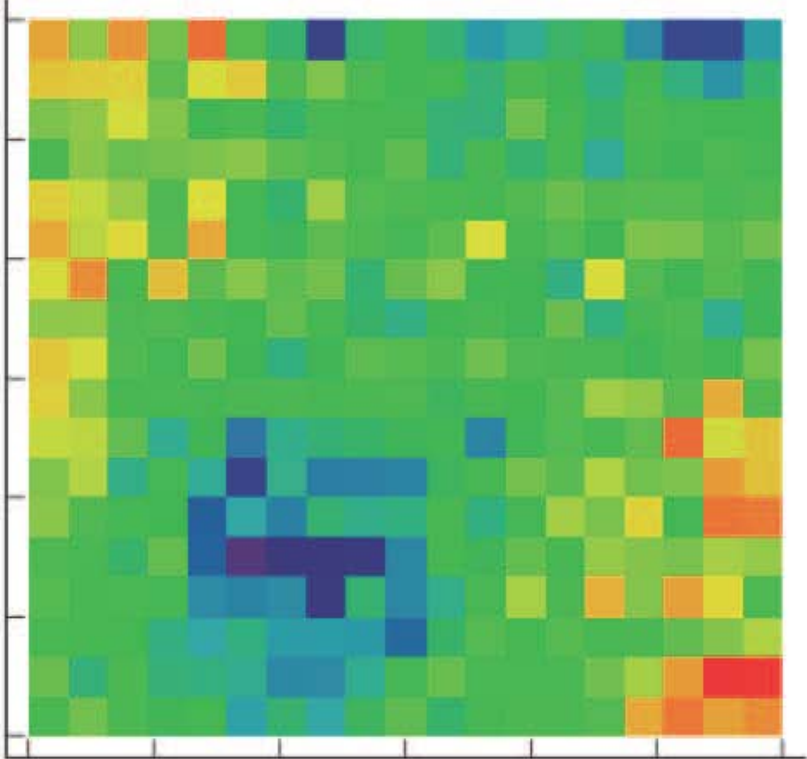

Measured

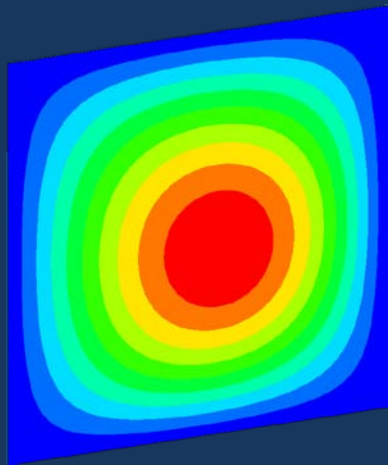

+

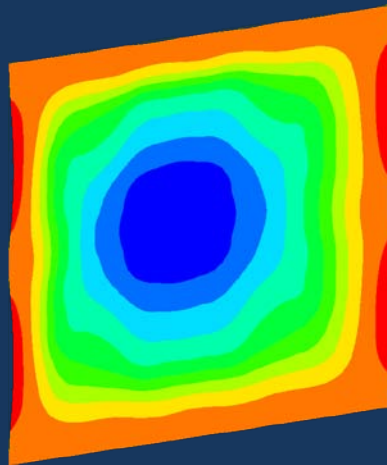

=

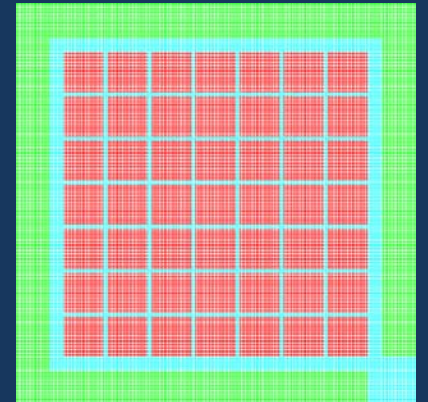
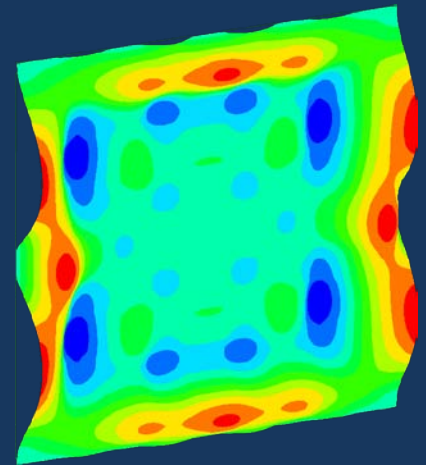

- Investigate feasibility of one time, on-ground only figure correction
 - Examine magnitude of gravity release for a candidate mirror design (2 m diameter, 20 m focal length, 200 mm long mirror segments, 12 point mirror support)
 - Look at amplitude of error and ability to correct gravity release using 1 cm sized piezo cells
- RMS slope error
 - before – 0.105 arc sec
 - after – 0.010 arc sec

