

NASA/CR-2011-217051



# 4D Dynamic Required Navigation Performance Final Report

*Daniel M. Finkelsztein and James L. Sturdy  
Raytheon Company, Hampton, Virginia*

*Omeed Alaverdi  
SAIC, Lexington Park, Maryland*

*Joachim K. Hochwarth  
GE Aviation, Grand Rapids, Michigan*

---

February 2011

## NASA STI Program . . . in Profile

Since its founding, NASA has been dedicated to the advancement of aeronautics and space science. The NASA scientific and technical information (STI) program plays a key part in helping NASA maintain this important role.

The NASA STI program operates under the auspices of the Agency Chief Information Officer. It collects, organizes, provides for archiving, and disseminates NASA's STI. The NASA STI program provides access to the NASA Aeronautics and Space Database and its public interface, the NASA Technical Report Server, thus providing one of the largest collections of aeronautical and space science STI in the world. Results are published in both non-NASA channels and by NASA in the NASA STI Report Series, which includes the following report types:

- **TECHNICAL PUBLICATION.** Reports of completed research or a major significant phase of research that present the results of NASA programs and include extensive data or theoretical analysis. Includes compilations of significant scientific and technical data and information deemed to be of continuing reference value. NASA counterpart of peer-reviewed formal professional papers, but having less stringent limitations on manuscript length and extent of graphic presentations.
- **TECHNICAL MEMORANDUM.** Scientific and technical findings that are preliminary or of specialized interest, e.g., quick release reports, working papers, and bibliographies that contain minimal annotation. Does not contain extensive analysis.
- **CONTRACTOR REPORT.** Scientific and technical findings by NASA-sponsored contractors and grantees.

- **CONFERENCE PUBLICATION.** Collected papers from scientific and technical conferences, symposia, seminars, or other meetings sponsored or co-sponsored by NASA.
- **SPECIAL PUBLICATION.** Scientific, technical, or historical information from NASA programs, projects, and missions, often concerned with subjects having substantial public interest.
- **TECHNICAL TRANSLATION.** English-language translations of foreign scientific and technical material pertinent to NASA's mission.

Specialized services also include creating custom thesauri, building customized databases, and organizing and publishing research results.

For more information about the NASA STI program, see the following:

- Access the NASA STI program home page at <http://www.sti.nasa.gov>
- E-mail your question via the Internet to [help@sti.nasa.gov](mailto:help@sti.nasa.gov)
- Fax your question to the NASA STI Help Desk at 443-757-5803
- Phone the NASA STI Help Desk at 443-757-5802
- Write to:  
NASA STI Help Desk  
NASA Center for AeroSpace Information  
7115 Standard Drive  
Hanover, MD 21076-1320

NASA/CR-2011-217051



# 4D Dynamic Required Navigation Performance Final Report

*Daniel M. Finkelsztein and James L. Sturdy  
Raytheon Company, Hampton, Virginia*

*Omeed Alaverdi  
SAIC, Lexington Park, Maryland*

*Joachim K. Hochwarth  
GE Aviation, Grand Rapids, Michigan*

National Aeronautics and  
Space Administration

Langley Research Center  
Hampton, Virginia 23681-2199

Prepared for Langley Research Center  
under Contract NNL08AA15B

February 2011

Available from:

NASA Center for AeroSpace Information  
7115 Standard Drive  
Hanover, MD 21076-1320  
443-757-5802

# 1 Summary

New advanced four dimensional trajectory (4DT) procedures under consideration for the Next Generation Air Transportation System (NextGen) require an aircraft to precisely navigate relative to a moving reference such as another aircraft. Examples are Self-Separation for en-route operations and Interval Management for in-trail and merging operations. The current construct of Required Navigation Performance (RNP), defined for fixed-reference-frame navigation, is not sufficiently specified to be applicable to defining performance levels of such air-to-air procedures. An extension of RNP to air-to-air navigation would enable these advanced procedures to be implemented with a specified level of performance. The objective of this research effort was to propose new 4D Dynamic RNP constructs that account for the dynamic spatial and temporal nature of Interval Management and Self-Separation, develop mathematical models of the Dynamic RNP constructs, “Required Self-Separation Performance” and “Required Interval Management Performance,” and to analyze the performance characteristics of these air-to-air procedures using the newly developed models. This final report summarizes the activities led by Raytheon, in collaboration with GE Aviation and SAIC, and presents the results from this research effort to expand the RNP concept to a dynamic 4D frame of reference.

# TABLE OF CONTENTS

1	Summary	5
2	Introduction	14
3	Technical Approach	15
4	RNP State-of-the-Art Assessment	15
5	4D Dynamic RNP Overview	16
5.1	Introduction	16
6	Required Self Separation Performance Conceptual Framework	17
6.1	Introduction	17
6.1.1	Separation Background	17
6.1.2	Enabling Technologies: RNP and ADS-B	17
6.2	System Overview	18
6.2.1	ADS-B Transceiver	18
6.2.2	Surveillance	19
6.2.3	State Estimation	19
6.2.4	Navigation	19
6.2.5	ASAS	19
6.2.6	Display and System Alerting	19
6.3	Required Self-Separation Performance	19
6.3.1	Separation System Categories	20
6.3.2	RSSP Concept	20
6.3.3	Application of RSSP	21
6.3.4	RSSP Types	21
6.4	Operational Goals and Applications	21
6.4.1	Overview	22
6.4.2	Concept of Operation	22
6.4.3	Procedure Description	24
6.4.4	Errors and Uncertainties	25
6.5	Assumptions	27
6.5.1	Assumptions Applicable to All Classes	27
6.5.2	Assumptions Applicable to Class A Systems	28
6.6	Definitions	28
6.6.1	Required Self-Separation Performance	28
6.6.2	Trajectory	30
6.6.3	Error Terms	30
6.6.4	Separation Containment Concept	31
6.7	System Performance Requirements	33
6.7.1	Accuracy	33
6.7.2	State Data Accuracy Metrics	33
6.7.3	Additional Metrics	34
6.8	Integrity	34
6.9	Continuity	35
6.10	Availability	35
7	Required Interval Management Performance Conceptual Framework	36
7.1	Introduction	36

7.2	System Overview	36
7.2.1	State Estimation	39
7.2.2	4D Path Definition	40
7.2.3	Speed Control	41
7.2.4	User Interface	42
7.3	Required Interval Management Performance	42
7.3.1	Time Navigation	42
7.3.2	RIMP Concept	42
7.3.3	Application of RIMP	43
7.3.4	RIMP Types	43
7.4	Assumptions	43
7.4.1	Reference Aircraft State	43
7.4.2	Ownship State	44
7.4.3	Reference Aircraft Intent	44
7.4.4	Ownship Intent	44
7.5	Definitions	44
7.5.1	Required Interval Management Performance	44
7.5.2	Trajectory	45
7.5.3	Error Terms	46
7.6	System Performance Requirements	51
7.6.1	Accuracy	51
7.6.2	Integrity	51
7.6.3	Continuity	51
7.6.4	Availability	51
8	Required Self Separation Performance Model	52
8.1	Introduction	52
8.2	Section Overview	52
8.3	TSE Model Derivation	52
8.3.1	Expected Separation Computation	52
8.3.2	Analysis of Sensitivity of Expected Minimum Separation to State Variable Variations	54
8.3.3	Analysis of Error Distribution of Minimum Separation	58
8.3.4	Extension to Other Uncertainty/Error Terms	59
8.4	MATLAB Linearized Sensitivity Model Description	59
8.4.1	Scenario Inputs	59
8.4.2	Sensitivity Analysis Modeling	60
8.4.3	Distribution Analysis Modeling	61
8.5	MATLAB Model Operation	63
8.5.1	Overview	63
8.5.2	System Requirements	63
8.5.3	Installation & Start	63
8.5.4	Scenario Definition	63
8.5.5	Sensitivity Analysis	65
8.5.6	Distribution Analysis	70
8.5.7	Class B Systems	77
9	Required Interval Management Performance Model	82

9.1.1	Introduction	82
9.1.2	Section Overview	82
9.2	RIMP Operation Model	83
9.2.1	Modeling Approach	84
9.2.2	Aircraft Model Configuration	87
9.2.3	Elements of Uncertainty and Operational Limits	91
9.3	Aircraft and Environment Model Derivation	92
9.3.1	Point-Mass Equations of Motion	92
9.3.2	Aircraft Outputs and Measured Parameters	94
9.3.3	Navigation Calculations	97
9.3.4	Guidance and Control Calculations	105
9.4	TTG Estimation	107
9.4.1	Velocity Profile and Associated Assumptions	108
9.4.2	Distance and Time-to-Go Calculations	111
9.4.3	TTG Algorithms	112
9.5	RIMP Speed Control	112
9.5.1	Minimum Required Speed Change	113
9.5.2	Nominal Speed Change	114
9.5.3	Speed Change Logic	114
9.6	Model Setup and Execution Procedures	115
9.6.1	Model Setup	115
9.6.2	Individual Simulation Runs	119
9.6.3	Monte Carlo Simulation Runs	121
10	Required Self Separation Performance Study	122
10.1	Objectives and Motivation	122
10.2	Background	122
10.3	Simulation Platform and Scenarios Description	123
10.3.1	Basic Separation Distribution Model	123
10.3.2	Computation of Required Target $R_{CPA}$	125
10.3.3	Outer Framework	125
10.4	Study Design	125
10.4.1	Plan and Approach	125
10.4.2	Metrics	126
10.4.3	Test Plan	126
10.5	Study Results	127
10.5.1	Class A Systems	127
10.5.2	Class B Systems	131
10.5.3	Comparison of Class A and Class B RSSP Systems	135
10.6	RSSP Study Conclusion	135
11	Required interval Management Performance Study	136
11.1	Objectives and Motivation	136
11.2	Background	137
11.3	Simulation Platform and Scenarios Description	137
11.3.1	Aircraft Flight Dynamics Model	138
11.3.2	Air Traffic Simulation	141
11.3.3	Monte Carlo Simulation	144



11.4	RIMP Study Design	144
11.4.1	RIMP Study Plan and Approach	144
11.4.2	Metrics	147
11.4.3	RIMP Test Plan	148
11.5	RIMP Study Results	149
11.5.1	Baseline Test	149
11.5.2	Single Pair IM	159
11.5.3	Large IM Stream	170
11.6	RIMP Study Conclusion	181
12	Conclusions	182
12.1	Observations	182
12.2	Next Steps	183
	Acknowledgement	185
	References	185
	Acronyms	186

## LIST OF FIGURES

Figure 1 - Separation System Functional Block Diagram .....	18
Figure 2 - Original Estimated Geometry .....	23
Figure 3 - Estimated Geometry after Ownship Slows .....	23
Figure 4 - Estimated Geometry after Ownship Turns.....	24
Figure 5 - Estimated Geometry with Uncertainties and Errors.....	26
Figure 6 - Overview of APS-RIMP Operation .....	37
Figure 7 - APS System Block Diagram .....	39
Figure 8 - Representative Layout of Paired Airplanes in Precision Spacing Mode .....	40
Figure 9 - Along Track Components of Navigation Error Terms .....	46
Figure 10 - Reference Time Profile with Uncertainty .....	48
Figure 11 - Along-Track and Cross-Track Containment Region .....	49
Figure 12 – RSSPSimulator Control Panel.....	63
Figure 13 – Mode Control Panel Configuration for Scenario Inputs.....	64
Figure 14 – Scenario Display Example .....	65
Figure 15 – SPS Control Panel Configuration to Vary Crossing Angle ( $\psi$ ). .....	66
Figure 16 – SPS Sensitivity to Position Error as a Function of Crossing Angle ( $\psi$ ).....	67
Figure 17 – SPS Sensitivity to Velocity Error as a Function of Crossing Angle ( $\psi$ ).....	68
Figure 18 – TPS Control Panel Configuration Varying $S_O$ and $S_R$ . .....	69
Figure 19 – TPS Sensitivity to Position Error as a Function of $S_O$ and $S_R$ . .....	69
Figure 20 – TPS Sensitivity to Velocity Error as a Function of $S_O$ and $S_R$ .....	70
Figure 21 – Distribution Analysis Controls.....	71
Figure 22 – Histogram Limit Warning Dialog. ....	71
Figure 23 – Class A Error Distribution Inputs.....	72
Figure 24 – Class A Single Distribution Control Panel Setup.....	72
Figure 25 – Class A Single Distribution Result.....	73
Figure 26 – Class A SPS Distribution Analysis Control Panel Setup. ....	74
Figure 27 – Class A SPS Distribution Analysis Distribution Result. ....	74
Figure 28 – Class A SPS Distribution Analysis Statistics Result. ....	75
Figure 29 – Class A TPS Distribution Analysis Control Panel Setup. ....	76
Figure 30 – Class A TPS Distribution Analysis Statistics Result.....	76
Figure 31 – Class B Error Distribution Inputs.....	77
Figure 32 – Class B Single Distribution Control Panel Setup.....	78
Figure 33 – Class B Single Distribution Result.....	79
Figure 34 – Class B SPS Distribution Analysis Control Panel Setup.....	80
Figure 35 – Class B SPS Distribution Analysis Distribution Result. ....	80
Figure 36 – Class B SPS Distribution Analysis Statistics Result. ....	81
Figure 37 – RIMP Operation Flow Diagram .....	83
Figure 38 – RIMP Operation Model.....	85
Figure 39 – RIMP model data flow .....	86
Figure 40 – RIMP Aircraft Model .....	88
Figure 41 – Flight Segment and Navigation Modes .....	98
Figure 42 – TRACK Mode Parameters .....	98

Figure 43 – Required Distance for Turn to New Course .....	100
Figure 44 – Waypoint Capture in TURN Mode .....	101
Figure 45 – Corrected Segment Length .....	102
Figure 46 – True Airspeed Control System .....	106
Figure 47 – Vertical Flight Path Control System.....	106
Figure 48 – Lateral Control System in TRACK mode .....	107
Figure 49 – Assumed velocity profile for level segments .....	108
Figure 50 – Assumed velocity profile for descent segments .....	109
Figure 51 – Speed Change Logic.....	114
Figure 52 - Original Estimated Geometry .....	123
Figure 53 -Scenarios A-1—A-4: Required Buffer versus Crossing Angle and Normalized Speed Difference. ....	129
Figure 54 - Scenarios A-1—A-4: Required Buffer versus Crossing Angle, Normalized Speed Difference in the Z-Axis. ....	130
Figure 55 - Scenarios A-1—A-4: Required Buffer versus Normalized Speed Difference, Crossing Angle in the Z-Axis. ....	131
Figure 56 - Scenarios B-1 – B-6: Required Buffer versus Crossing Angle, Normalized Speed Difference in the Z-Axis. ....	134
Figure 57 - Scenarios B-1 – B-6: Required Buffer versus Normalized Speed Difference, Crossing Angle in the Z-Axis. ....	135
Figure 58 Aircraft Flight Dynamics Model in Simulink .....	139
Figure 59 Sensor Model Parameters .....	140
Figure 60 Aircraft Indicated Airspeed Limits.....	140
Figure 61 Air Traffic Model in Simulink .....	142
Figure 62 Aircraft Setup File for IM Operations .....	143
Figure 63 Global Simulation Constants.....	143
Figure 64 Flight Plan File for BGEST Arrival .....	145
Figure 65 Flight Plan Surface Map.....	146
Figure 66 Wind Temperature and Pressure Data.....	147
Figure 67 Altitude Profile .....	151
Figure 68 Flight Segment Completion Histories .....	151
Figure 69 Indicated Airspeed Profile.....	152
Figure 70 Mach Number Profile.....	152
Figure 71 True Airspeed Profile .....	153
Figure 72 Measured Wind Magnitudes and Direction.....	153
Figure 73 Resulting Ground Speed.....	154
Figure 74 Rate of Climb Profile.....	154
Figure 75 Along-Track Distance to Go for Current Segment.....	155
Figure 76 Computed TTG for Nominal Case .....	156
Figure 77 Distribution of Final Spacing with Wind Uncertainty and no IM.....	157
Figure 78 Predicted Spacing Signal.....	158
Figure 79 Final Spacing with Wind and Initial Spacing Uncertainty and no IM .....	159
Figure 80 Achieved Spacing Histogram .....	161
Figure 81 IM Frequency Histogram Total Operation .....	161
Figure 82 IM Frequency Histogram below 10K.....	162
Figure 83 IM Frequency Histogram per Segment .....	162

Figure 84 Estimated Spacing and IM Command History .....	163
Figure 85 Achieved Spacing Histogram .....	165
Figure 86 IM Frequency Histogram Total Operation .....	165
Figure 87 IM Frequency Histogram below 10K .....	166
Figure 88 IM Frequency Histogram per Segment .....	166
Figure 89 Achieved Spacing Histogram .....	168
Figure 90 IM Frequency Histogram Total Operation .....	168
Figure 91 IM Frequency Histogram below 10K .....	169
Figure 92 IM Frequency Histogram per Segment .....	169
Figure 93 Achieved Spacing Histogram .....	171
Figure 94 IM Frequency Histogram Total Operation .....	171
Figure 95 IM Frequency Histogram below 10K .....	172
Figure 96 IM Frequency Histogram per Segment AC#2 .....	172
Figure 97 IM Frequency Histogram per Segment AC#6 .....	173
Figure 98 Achieved Spacing Histogram .....	175
Figure 99 IM Frequency Histogram Total Operation .....	175
Figure 100 IM Frequency Histogram below 10K .....	176
Figure 101 IM Frequency Histogram per Segment AC#2 .....	176
Figure 102 IM Frequency Histogram per Segment AC#6 .....	177
Figure 103 Achieved Spacing Histogram .....	179
Figure 104 IM Frequency Histogram Total Operation .....	179
Figure 105 IM Frequency Histogram below 10K .....	180
Figure 106 IM Frequency Histogram per Segment AC#2 .....	180
Figure 107 IM Frequency Histogram per Segment AC#6 .....	181

## LIST OF TABLES

Table 1: Scenario geometry parameters	126
Table 2: Class A system condition parameters	127
Table 3: Class B system condition parameters	127
Table 4: Class A system statistical results	128
Table 5: Class B system statistical results	132
Table 6: Class B system analysis of uncertainties	133
Table 7: Statistics for baseline test case with wind uncertainty	157
Table 8: Statistics for baseline test case with wind and initial spacing uncertainty	159
Table 9: Statistics for single pair IM test case without uncertainty	160
Table 10: Statistics for single pair IM test case with wind uncertainty	164
Table 11: Statistics for single pair IM test case with wind and initial spacing uncertainty	167
Table 12: Statistics for multi pair IM test case with wind uncertainty	174
Table 13: Statistics for multi pair IM test case with wind and initial spacing uncertainty	178

## 2 Introduction

The Joint Program Development Office (JPDO) Concept of Operations for the Next Generation Air Transportation System (NextGen) considers Four Dimensional Trajectory (4DT) procedures a key enabler to Trajectory Based Operations (TBO). The JPDO defines 4DT as “a precise description of an aircraft path in space and time”. While NextGen assumes that this path is defined within an Earth-reference frame, many 4DT procedure implementations will require an aircraft to precisely navigate relative to a moving reference such as another aircraft to form aggregate flows or a weather cell to allow for flows to shift. Current methods of implementing routes and flight paths rely on aircraft meeting a Required Navigation Performance (RNP) specification and being equipped with a monitoring and alerting capability to annunciate when the aircraft system is unable to meet the performance specification required for the operation. Since all aircraft today operate within the NAS relative to fixed reference points, the current RNP definition is deemed satisfactory. However, it is not well understood how the current RNP construct will support NextGen 4DT procedures where aircraft operate relative to each other or to other dynamic frames of reference. The objective of this research effort is to analyze candidate 4DT procedures from both an Air Navigation Service Provider (ANSP) and aircraft perspective, to identify their specific navigational requirements, assess the shortcomings of the current RNP construct to meet these requirements, to propose an extended 4D “dynamic” RNP construct that accounts for the dynamic spatial and temporal nature of the selected 4DT procedures, and finally, to model and analyze the Dynamic RNP characteristics of these procedures.

This Final Report summarizes the activities led by Raytheon, in collaboration with GE Aviation and SAIC, and presents the results from this research effort to expand the RNP concept to four dimensions relative to a dynamic frame of reference.

A comprehensive assessment of the state-of-the-art international implementation of current RNP was completed and presented in the Contractor Report “RNP State-of-the-Art Assessment, Version 4, 17 December 2008”. The team defined in detail two 4DT operations, Airborne Precision Spacing and Self-Separation, that are ideally suited to be supported by 4D Dynamic RNP and developed their respective conceptual frameworks, “Required Interval Management Performance (RIMP) Version 1.1, 13 April 2009” and “Required Self Separation Performance (RSSP) Version 1.1, 13 April 2009”.

Once the conceptual framework for the RSSP and RIMP operation was established, the team developed respective mathematical models and implemented them in simulation tools. The RSSP simulator, developed using MATLAB, allows a researcher to assess the impact that various error sources and uncertainties have on an aircraft’s ability to accurately predict (and hence control) its minimum separation from a reference aircraft. The model includes computation of the encounter geometry, linearized analysis of the impact of error sources on the predicted separation, and a Monte Carlo based analysis of the impact of error sources on the distribution of separation as a function of encounter geometry in the context of key error terms for RSSP systems. The RSSP model and its simulation tool was documented in “Required Self Separation Performance Modeling, Version 2.2, 31 March 2010”. For RIMP operations, the team developed a framework to analyze RIMP operations in the presence of various uncertainties and operational limitations. An accompanying MATLAB/Simulink model provided a means for

a time-based simulation of paired approaches using the RIMP concept. The RIMP model and its simulation tool is documented in “Required Interval Management Performance Modeling, Version 3.1, 30 May 2010”.

Finally, the team performed a RSSP and a RIMP study using these simulation tools. The RSSP study explored the relationship between various lateral separation geometry parameters (speeds, crossing angle, and time-to-go) and system accuracy metrics (navigation accuracy and surveillance accuracy) and the statistical distribution of expected actual separation distances. The RIMP study assessed the feasibility of a long stream of aircraft to perform RIMP operation in the presence of various uncertainties and aims at quantifying the performance of airborne IM and define the limits of safe and stable operation. The results of the RSSP and RIMP studies were respectively documented in “Required Self Separation Performance Study Report, Version 1.1, 30 July 2010” and “Required Interval Management Performance Study Report, Version 1.1, 30 July 2010”.

### **3 Technical Approach**

The Raytheon team brings a broad and comprehensive perspective on RNP and Trajectory Based Operations including operational support to the FAA for the implementation of Area Navigation (RNAV) and RNP, implementation of advanced 4D capable avionics for airframe manufacturers and operational support to operators, modeling and simulation development of advanced CNS capabilities into ATOS, and support of various experiments for the NextGen Airspace Project. While our technical approach attempts to use and build upon the content and document structure of the Minimum Aviation System Performance Standards (MASPS, DO-236B) and Minimum Operational Performance Specifications (MOPS, DO-283A) developed by RTCA, we have leveraged the team’s breadth of perspective and expertise to determine the practicability of extending this construct to 4D RNP relative to a dynamic frame of reference.

The key elements of our technical approach were:

1. Assessment of international state-of-the-art in 2D, 3D and 4D RNP capability and use of RNP procedures and performance levels
2. Selection of candidate NextGen procedures and applications, and definition of the relevant 4D Dynamic RNP requirements
3. Develop a mathematical construct and a model for 4D Dynamic RNP in support of the selected procedures
4. Implement these models into simulation tools that enable the of operation specific performance metrics as a function of errors and uncertainties
5. Perform one study for each selected procedures using the developed simulation tools

### **4 RNP State-of-the-Art Assessment**

The “RNP State-of-the-Art Assessment, v4, 17 December 2008” retraces the concept of Performance Based Navigation (PBN) from its origin in the early nineties and the development of satellite based technologies to the latest implementations throughout the world. The report documents the conceptual and operational perspectives of lateral, vertical, and time Required Navigation Performance. It also provides a directory of the documents related to PBN/RNAV/RNP, the RNAV and RNP Procedures and a status of international RNP implementation.

## **5 4D Dynamic RNP Overview**

### **5.1 Introduction**

RTCA document DO 236B contains MASPS for RNAV systems operating in an RNP environment. This report will start with DO-236B requirements and apply them to developing performance requirements for aircraft self-separation and self-spacing applications.

The Next Generation Air Transportation System (NextGen) is envisioned as a revolutionary transformation of the U.S. airspace to a performance-based, scalable, network enabled system that will be flexible enough to meet future air traffic needs. One of the major transformations is the use of TBO as the main mechanism for managing traffic at high density or in highly-complex airspace. These TBOs will be specified between the user and the air navigation service provider (ANSP) and agreed in a “contract”, using advanced automation. Overall, preferences for all users are accommodated to the greatest extent possible, and trajectories constrained only to the extent required to accommodate congestion, or for security, safety or environmental reasons. Changes to that “contract” will be made collaboratively, balancing the user preferences with the ANSP constraints.

A major element of TBO is trajectory-based separation management (SM), which uses automation and shared trajectories to better manage separation among aircraft and airspace and hazards such as weather and terrain. TBO provides a means for maintaining a target level of safety (TLS) while increasing traffic densities well beyond what is possible today given the workload, uncertainty, and execution delays inherent in current ground-based air traffic management.



## **6 Required Self Separation Performance Conceptual Framework**

### **6.1 Introduction**

This section examines what would be required in order to ensure a TLS for a scenario, in which aircraft have primary responsibility for providing separation from other aircraft in contrast to the current system where that responsibility lies with the ground-based ANSP. It describes the system components, identifies key system parameters, and derives an RNP-like construct for self-separation operations.

#### **6.1.1 Separation Background**

Separation is the term used to describe the act of keeping aircraft at such distances from each other that the risk of their colliding with each other is below a TLS. Such separation distances are specified as horizontal or vertical standards. Separation in the horizontal plane can be applied either longitudinally, spacing aircraft behind each other; laterally, spacing aircraft side by side; or a composite of the two, providing separation for aircraft whose paths cross. When not horizontally separated, vertical separation is achieved by aircraft operating at different altitudes (flight levels). The required separation is usually expressed in terms of minimum distances in each dimension, which should not be infringed. In the case of horizontal separation, the minimum distance can be expressed in either nautical miles, degrees of angular displacement (e.g.: on departure) or, in the longitudinal dimension, as either time-based or distance-based minima.

The separation minima used by Air Traffic Services (ATS) today in radar-controlled airspace takes into account that any decisions are based on a picture of the airspace derived from radar surveillance. The separation minima used must therefore ensure that even in the worst case surveillance conditions the positive separation of aircraft can be maintained. The implementation of Automatic Dependent Surveillance (ADS) and digital data link communications technologies into the NAS will provide significant improvements beyond current procedural ground-based control. This is due to the increased frequency and accuracy of position updates as well as information on the future intent of the aircraft. The technology should enable significant reductions in separation and spacing minima.

#### **6.1.2 Enabling Technologies: RNP and ADS-B**

Figure 1-1, “Navigation System Block Diagram”, from DO-236B provides a general description of the functions and describes the relationship between the various elements of the navigation system. One of the elements critical to precision separation is the path definition function since it computes the defined path to be flown in relation to the vertical, horizontal, and time dimensions. The RNP concept provides the means for quantifying lateral containment integrity and containment continuity, both of which are needed in order to demonstrate a TLS for TBO.

Unfortunately, DO-236B only discusses, in detail, lateral path definition whereas NextGen envisions TBOs based on full 4DTs. Two dimensional trajectory (2DT) operations are defined by longitudinal and lateral positions and define a ground track. Three dimensional trajectories

(3DT) add the vertical position so that altitude is defined anywhere along the ground track. 4DT adds the time element to trajectory-based operations.

Full 4D TBO will require updated equipment standards and aircraft capabilities:

- a. Navigation and Guidance - more precise definition of vertical profiles and better definition and precision for along track/time-control,
- b. Communication – ability to describe trajectory windows and performance in all dimensions and to access available data and negotiate trajectories,
- c. Surveillance – ability to conduct relative navigation (spacing) or accept delegated separation, and finally
- d. Flight Crew Displays and Decision Support – flight crew awareness and management of TBO.

This report assumes the use of a surveillance technology with the full capabilities defined for Automatic Dependent Surveillance – Broadcast (ADS-B) systems defined in DO-242A to provide aircraft with position, velocity, and identification data about the aircraft operating in their vicinity, and in some instances, more complete intent information than is currently defined in the published ADS-B standards.

## 6.2 System Overview

A key new technology required to support self-separation is an Airborne Separation Assistance System (ASAS). This system is needed to monitor the state and intent of the ownship aircraft in the context of the state and intent of reference aircraft as determined by the onboard surveillance function. The ASAS is expected to not only alert the flight crew to predicted losses of separation (conflicts), but also to supply one or more maneuvers that, if implemented, should resolve such conflict(s). The relationship of the ASAS to other aircraft systems is depicted in Figure 1.

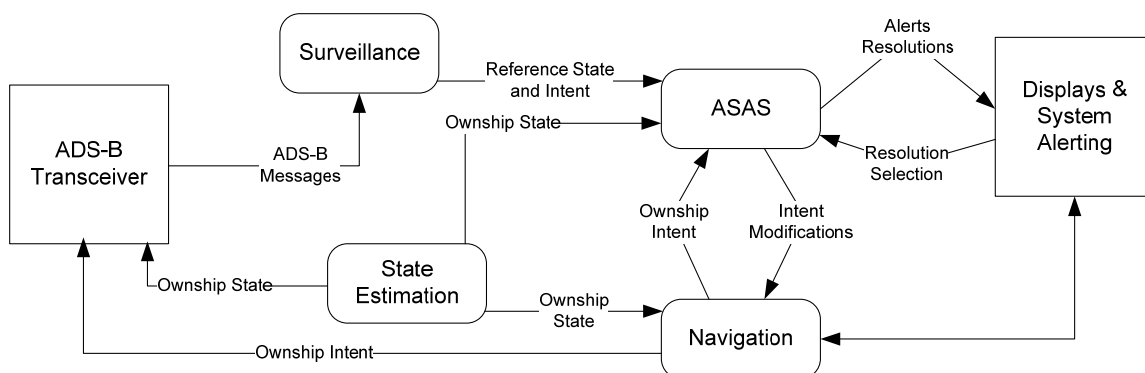

**Figure 1 - Separation System Functional Block Diagram**

### 6.2.1 ADS-B Transceiver

The ADS-B transceiver transmits and receives ADS-B signals. It collects outgoing data from the position estimation and navigation functions. Received ADS-B messages are passed to the Surveillance function for processing.

## **6.2.2 Surveillance**

The Surveillance function assembles ADS-B messages and maintains target and track information for each aircraft within ADS-B range. The Surveillance function is responsible for track initiation and maintenance and ensures that a consistent set of intent data for cooperating targets is available for the other aircraft functions.

## **6.2.3 State Estimation**

The state estimation function maintains the estimate of the aircraft's position, velocity, and the current time. It provides estimates of the quality of the position and velocity data. This function also includes the real-time estimation of the local wind vector based on the difference between ground-referenced velocity and air-referenced velocity.

## **6.2.4 Navigation**

The navigation function generates the expected 4D trajectory of the ownship aircraft (ownship intent). This trajectory is updated in accordance with changes generated by the pilot or when the aircraft state deviates from the trajectory in dimensions that are not being controlled (e.g. time drift when there is not RTA constraint). The navigation function also provides the guidance signals to the flight control system and to the flight crew.

## **6.2.5 ASAS**

The ASAS function compares the aircraft state and trajectory to the estimated state and trajectory of reference aircraft to monitor predicted separation, detect potential conflicts, and provide conflict resolution guidance in order to ensure that safe separation will be maintained. The estimated trajectory of reference aircraft is based either on broadcast intent information (Class A systems) or projection of state information in the absence of reference intent. When a loss of separation is projected within a specified time horizon, the ASAS function presents an indication to the flight crew and computes one or more resolution maneuvers for pilot selection and execution.

## **6.2.6 Display and System Alerting**

This function encompasses the interfaces between the aircraft systems and the flight crew.

## **6.3 Required Self-Separation Performance**

Analogous to the different performance levels used to define RNP capabilities and airspace user requirements, a suitable performance characterization, Required Self-Separation Performance (RSSP), is needed for ASAS equipped aircraft. The expectation is that an RSSP performance level will define a sufficient set of system performance attributes to permit determination of the separation buffer required to attain a specified TLS. Unlike RNP, the RSSP will need to be based on a multi-dimensional set of metrics in order to encompass the main interdependent parameters that affect achieving the target level of safety<sup>1</sup> (TLS) for a given traffic

---

<sup>1</sup> TLS = the requisite Target Level of Safety for the airspace domain, e.g. Where, "fatal accidents per flight hour" is considered to be an appropriate metric, a TLS of  $5 \times 10^{-9}$  fatal accidents per flight hour per dimension for the en-route domain. NOTE: Where fatal accidents per flight hour is not considered to be an appropriate metric, justifiable alternative metrics and methods of assessment providing an acceptable TLS may be established.

density/complexity (or, conversely, the traffic density/complexity for which a given TLS can be sustained)<sup>2</sup>. These interdependent parameters include:

- a) Aircraft navigation and guidance performance (4D RNP);
- b) Surveillance performance (range, accuracy, update rate/latency, update reliability, level of intent detail, and level of intent accuracy which has not yet been defined);
- c) Conflict resolution algorithm capabilities (how boxed in does the ownship need to get before no resolution can be found); and
- d) Look ahead time horizon (how far ahead are conflicts typically detected and resolution maneuvers reflected in intent broadcasts).

The expectation is that controlling these parameters will permit progressively reducing separation standards by reducing uncertainty and unpredictability in the overall system, thereby permitting higher-performing aircraft to operate in higher density airspace. These parameters are interdependent in that an increase or decrease in any single parameter may result in a corresponding increase or decrease in some or all of the others. RSSP is a consolidation of RNP, Required Communications Performance (RCP) of the surveillance datalink, and Required Surveillance Performance (RSP)<sup>3</sup>. RSSP is effectively a Communications, Navigation, and Surveillance (CNS)/ATM matrix where the outcome is directly related to a level of capability that is required to operate in a particular airspace.

### **6.3.1 Separation System Categories**

This document recognizes two distinct classes of self-separation system. Class B systems use only position and velocity surveillance data (state data) from the reference aircraft in order to detect conflicts and determine separation maneuvers. Class A systems use not only the state data of class B systems, but also provide and receive intent data as part of the surveillance data exchange. Having this intent data greatly reduces the errors and uncertainties associated with linearly projecting state data into the future and permits Class A systems to make more accurate predictions further into the future than Class B systems and to account for planned maneuvers of other aircraft. The two classes are distinguished because the presence or absence of intent data has a significant impact on the analysis of separation errors.

### **6.3.2 RSSP Concept**

The accuracy, integrity, and continuity concepts for longitudinal/time performance (and vertical performance) has not been addressed by ICAO or FAA to the level of detail that RNP (lateral) has, and the MASPS address accuracy requirements of Estimated Time of arrival (ETA), Time of Arrival Control (TOAC), and Vertical Navigation (VNAV) only at a very high level. Currently, the standards only address performance relative to a fixed, earth-referenced path and do not in any way address performance measurement in a dynamic frame of reference, such as flight

---

United States TERPS criteria provide an example for obstacle clearance at  $10^{-7}$  per approach or  $10^{-9}$  instantaneous collision from an obstacle.

<sup>2</sup> The numeric determination of a level of safety will depend upon the traffic density/complexity because the traffic density/complexity is a primary driver of conflict probability and the likelihood of finding conflict-free airspace to use for a conflict resolution.

<sup>3</sup> Definitions and standards for RCP and RSP are in development. The concepts of RCP and RSP have been discussed at ICAO. The FAA Associate Administrator for Safety talked about RCP, RSP and Required Total System Performance (RTSP) at the New technologies workshop in January 2007. Both are discussed in the NextGen ConOps.

relative to another aircraft. Because of the need to be able to quantify a level of safety associated with self-separation operations, this document develops a proposed RSSP concept and associated requirements.

For consistency with the ICAO definition of RNP, the document defines RSSP as: A statement of the self-separation performance accuracy, integrity, continuity, and availability necessary for conducting self-separation operations within self-separation permissible airspace<sup>4</sup>.

### **6.3.3 Application of RSSP**

The term RSSP is applied as a descriptor for airspace where self-separation is permitted. This could encompass a large area, such as one or more en route or oceanic sectors, or to a more constrained volume such as a flow corridor as defined in the NextGen Concept of Operations (ConOps).

### **6.3.4 RSSP Types**

The term RSSP -x-y is introduced to denote both an area of self-separation permitted airspace and, simultaneously, the minimum aircraft system performance required to perform self-separation within that airspace.

The ‘x’ indicates the class of RSSP system. Currently, two classes are defined:

- Class A systems provide and use both state and detailed intent information.
- Class B systems need only provide and use state information.

The ‘y’ indicates the category of required system performance. Each such category is associated with performance metrics that, taken together, define an aircraft’s ability to identify and resolve conflicts to a particular standard. The set of metrics is enumerated in Section 6.4.4. The definition of the specific categories and the metric thresholds associated with them, however, is beyond the scope of this document.

## **6.4 Operational Goals and Applications**

Under a performance-based system, as envisioned by NextGen, excess separation resulting from today’s control imprecision (a product of available data and controller workload) and lack of predictability are minimized which enables reduced separation among aircraft. Also, separation management responsibility may be delegated or transferred to aircraft having the capability to perform that function. Self separating aircraft, as envisioned by NextGen, are required to maintain separation from all other aircraft, and obstacles and hazards, in the airspace. Aircraft follow the proper separation procedures and avoid any maneuvers that generate immediate conflicts with any other aircraft. Self separation procedures are conducted only in self separation airspace. Eventually, self separating aircraft will have 4 dimensional trajectories (4DT). Either the separation maneuver will leave the aircraft within the constraints of its 4DT, or the flight crew will need to negotiate a new 4DT. This document does not attempt to define a complete

---

<sup>4</sup> While self-separation is only expected to take place in RSSP designated airspace, this statement does not imply that such airspace may not also contain aircraft for whom separation assurance is being provided for by the ANSP. This report does not address such ‘mixed’ operations or the related equipage requirements for non-RSSP aircraft that would result if RSSP aircraft are required to maintain separation from the non-RSSP aircraft.

concept of operations for self-separation, and in particular, does not address issues such as the unambiguous handoff of separation responsibility when transitioning into and out of self-separation airspace.

### 6.4.1 Overview

The self-separation scenario looks at the situation when one aircraft (ownship) must pass no closer than a specified separation distance (or more generally, an exclusion zone)<sup>5</sup> from another aircraft (reference)<sup>6</sup>. In order to perform this maneuver reliably, ownship must target a separation that includes some extra buffer in addition to the required separation to account for uncertainties in ownship and reference aircraft state estimation and performance. Because this additional buffer represents inefficiency in the operation (use of airspace, excess ownship maneuvering, etc.), it is desirable to keep it to the practical minimum. The necessary size of this additional buffer, however, is a complex function of the uncertainties inherent in the measurement of the ownship and reference aircraft state, knowledge of reference aircraft intent (future maneuvers before reaching the point of closest approach), crossing geometry, and predictions of future aircraft positions based on current measurements. The necessary buffer size is also a function of the ownship ability to execute the required maneuvers accurately and in a timely fashion. The goal of this analysis is to be able to specify a mathematical construct, analogous to RNP in the cross-track direction, that can be used for determining the size of buffer required to produce a given level of assurance that ownship will not pass within the exclusion zone of reference (or cause reference to pass through ownship's exclusion zone) in the lateral and/or vertical dimensions<sup>7</sup>, though for the purposes of this analysis, the focus will be on lateral separation.

### 6.4.2 Concept of Operation

The scenario assumes that at some point in time  $T_0$ , ownship determines (via ATC instruction, automation, or pilot) that it must maneuver to miss reference (i.e. be outside of the exclusion zone at the point of closest approach (PCA) to the boundary of the exclusion zone) by at least a specified distance, Figure 2.<sup>8</sup> The determination of which aircraft must maneuver is expected to be based on a set of rules, analogous to the *International Regulations for Preventing Collisions at Sea* and applied without the need for explicit coordination between aircraft.

---

<sup>5</sup> This separation distance or exclusion zone must at a minimum account for the physical extent of each aircraft plus the wake vortex avoidance area behind each (not only must ownship not pass through reference's wake before it has decayed sufficiently, ownship must also not make reference pass through ownship's wake). If mitigation strategies are relied upon to account for excess uncertainty, mitigation will add to the separation distance.

<sup>6</sup> Or, in the general case, a non-stationary constraint such as a convective weather cell.

<sup>7</sup> This level of assurance is an element, along with alerting and mitigation strategies, of the analysis required to demonstrate a TLS.

<sup>8</sup> While many of the errors and uncertainties considered in this analysis pertain to the accuracy of this determination, the focus will be on the post-maneuver portion of the case in order to include the contribution of maneuver uncertainty to the total.

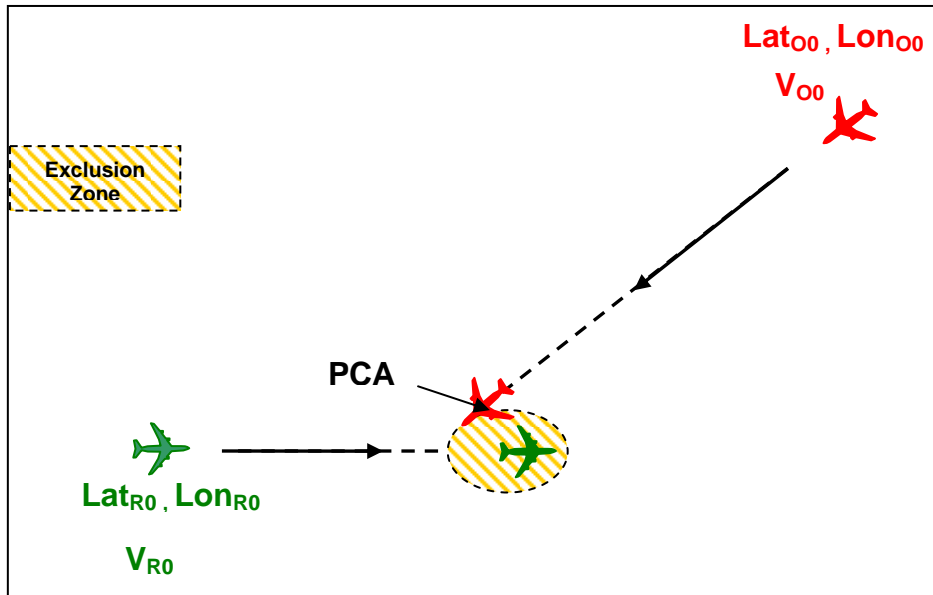

**Figure 2 - Original Estimated Geometry**

At  $T_0$ , ownship has an estimate of the position and velocity of both ownship and reference. Ownship may also have an estimate of the future trajectory of ownship and reference (intent information). In the horizontal plane, the maneuver could consist of a change of speed, as shown in Figure 3, or direction, as shown in Figure 4. Of course, a combination of these, or a change of altitude are also possible resolution maneuvers.

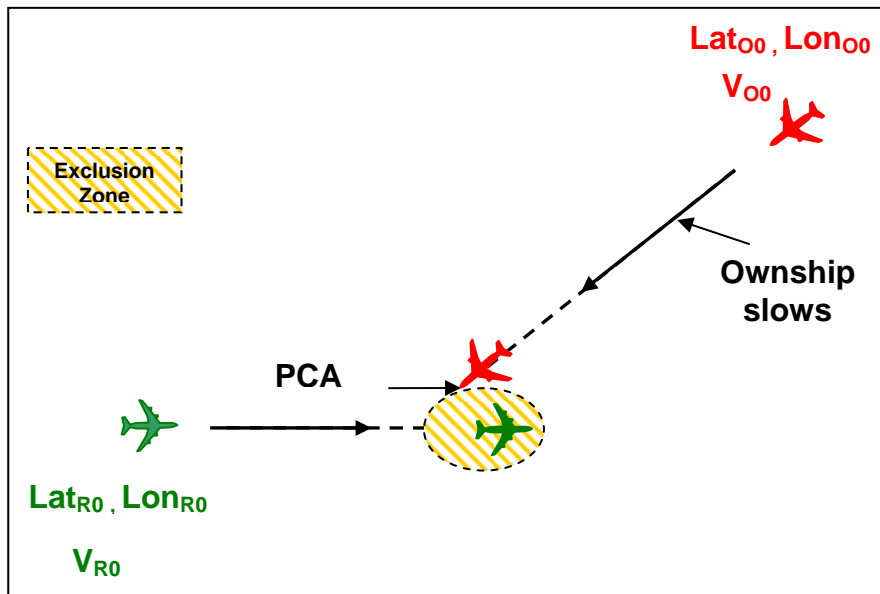

**Figure 3 - Estimated Geometry after Ownship Slows**

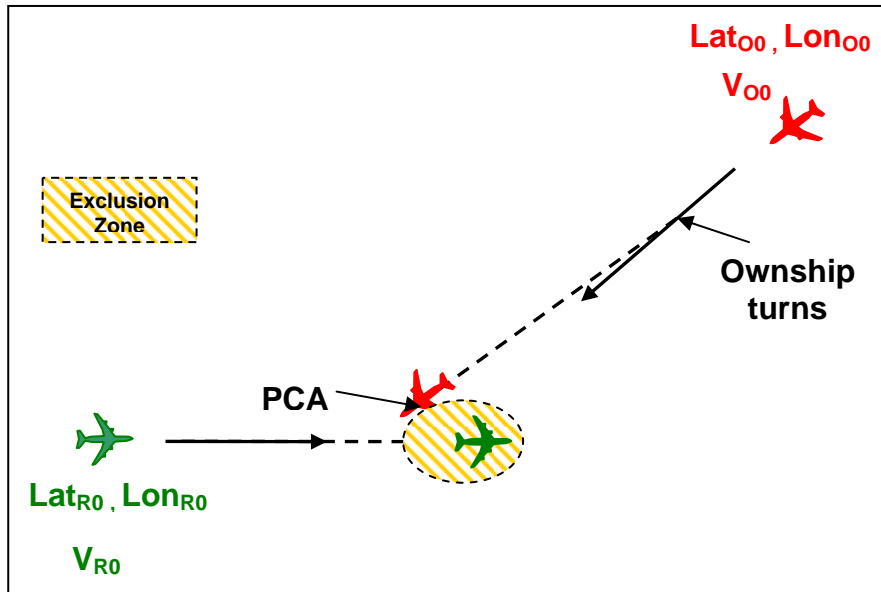

Figure 4 - Estimated Geometry after Ownship Turns

The scenario assumes that ownship has measurements of relevant state parameters and their accuracy and integrity from the onboard navigation system. It also assumes that ownship has some measurement of reference's state parameters and their accuracy and integrity via ADS-B transmissions from reference received by ownship's ADS-B receiver. For Class A systems, the scenario also assumes that some level of reference aircraft intent information is available, for example by ADS-B transmission of one or more Trajectory Change Points (TCPs), but the extent of that information will be kept as a parameter in the mathematical construct. The extent to which reference is permitted to maneuver without broadcasting intent adds directly to the uncertainty of the predicted separation and is outside the scope of this document. The analysis will also assume that ownship has measurements of wind and other relevant atmospheric parameters as well as knowledge of the accuracy and integrity of those measurements.

### 6.4.3 Procedure Description

How responsibility for maintaining the minimum separation is transferred from ATC to ownship is immaterial to this analysis and will not be considered as part of the procedure. It is sufficient to begin with the premise that ownship has this responsibility. Furthermore, barring the introduction of new constraints, this procedure assumes that ownship will execute the maneuver(s) determined after  $T_0$  without further alteration to compensate for error accumulation, so the maneuver(s) must include an adequate separation buffer<sup>9</sup>.

#### 6.4.3.1 Timeline/Decomposition of Events

- $T_0$  Ownship systems determine that a maneuver will be required to assure maintenance of the specified separation and inform the pilot.

<sup>9</sup> This assumption/constraint is introduced in recognition of the cockpit workload implications of a strategy that continuously updates the maneuver based on the evolving state of the two aircraft.



- T<sub>1</sub> Ownship automation determines one or more candidate maneuvers that will assure maintenance of the specified separation and present them to the pilot.<sup>10</sup>
- T<sub>2</sub> Ownship pilot selects which maneuver candidate will be executed.
- T<sub>3</sub> Ownship pilot configures onboard navigation system to perform the selected maneuver sequence.
- T<sub>4</sub> Ownship ADS-B begins broadcasting new intent information (Class A systems).
- T<sub>5</sub> Ownship executes planned maneuver(s).
- T<sub>6</sub> Ownship passes Point of Closest Approach (PCA) to reference, which, if the buffer used was adequate, meets or exceeds the specified separation distance.

### 6.4.3.2 Pilot Procedures

The ownship pilot is assumed to have already accepted responsibility for maintaining separation from reference before the scenario begins. Within the scenario, the pilot is responsible for:

1. Selecting the preferred separation maneuver(s),
2. Configuring the navigation system to perform the selected maneuver(s),
3. Ensuring that ownship performs the selected maneuver(s), and
4. Monitoring to ensure that the maneuver provides at least the specified separation (this monitoring is aided by the onboard tools).

### 6.4.4 Errors and Uncertainties

The construct for determining the required separation performance needs to account for:

1. Accuracy and integrity of ownship state data.
2. Accuracy of ownship planned trajectory (both current and planned maneuver), which depends on:
  - a. Control method accuracy (manual vs. automatic guidance)
  - b. Accuracy of modeling method (e.g. 6 DOF vs. kinematic) and modeling parameters (thrust, drag, etc).
  - c. Accuracy of predicted wind and temperature data.
  - d. Accuracy of earth model.
  - e. Correspondence between planned/predicted maneuver and actual maneuver executed (time of execution, acceleration/deceleration magnitude and transition, roll-in/roll-out transitions, turn-rate/bank angle used). This should directly correspond to 4D RNP performance level.
3. Accuracy and integrity of reference state data.
4. Accuracy and completeness of reference intent data (which depends on the same factors as the ownship data).
5. Encounter geometry (e.g. crossing angle).
6. ETE to point of closest approach in the resolution maneuver.
7. Anticipated ownship FTE bounds near point of closest approach.

The effects of these errors are represented in Figure 5. Note that it is expected that the total uncertainty will increase the further into the future that the aircraft state is predicted. For Class

---

<sup>10</sup> We assume that the tools leave sufficient time before the assumed initiation of each maneuver candidate to allow pilot selection and implementation to take place before the initiation time.

A systems, this increase will be capped by the 4D RNP accuracy and containment associated with the ownship trajectory and reference aircraft intent. For Class B systems, this growth is a result of integrating velocity over time in order to make the predictions of future position. In practice, this growth may be exponential for the prediction of the reference aircraft's state because of the possibility of unannounced maneuvers by the reference aircraft.<sup>11</sup> For the purposes of performance evaluation, however, any such maneuvering would be considered to create a new encounter situation.

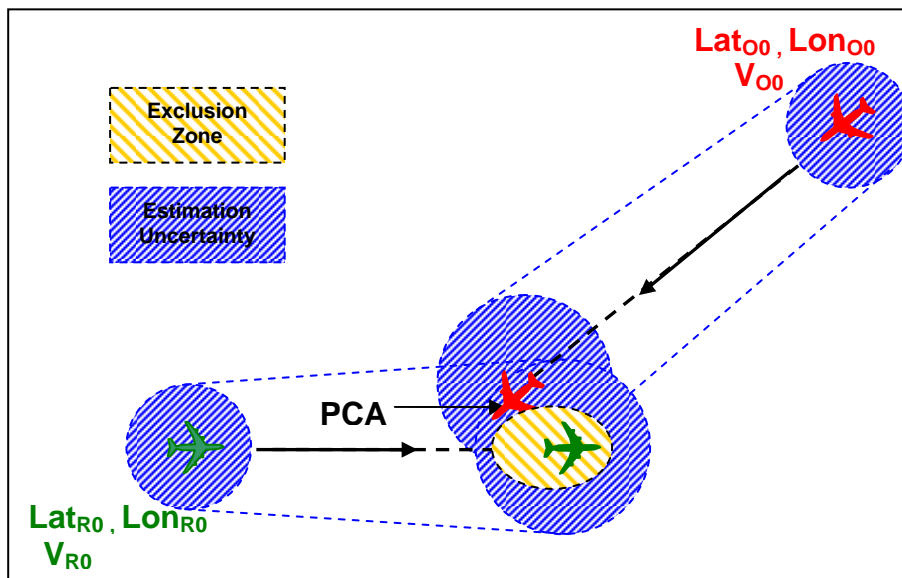

**Figure 5 - Estimated Geometry with Uncertainties and Errors**

The overall separation performance can be quantified by defining containment boundaries in the lateral and vertical dimension. These boundaries correspond to the region within which the actual separation will fall 95% of the time. They can also be used to define a further region that the actual separation will not exceed without alert with extremely high probability. Unlike in the case of RNP-RNAV, however, definition of the containment boundaries is not, in itself, adequate to be able to quantify a TLS. For RNP-RNAV, considerable freedom is left to the designer to make performance tradeoffs among the various system characteristics that contribute to overall lateral performance. For RSSP, however, there is a need to place additional constraints on this trade-space because the separation performance depends on the combined performance characteristics of two independent vehicles.

In order to ensure that any pair of vehicles conforming to a given RSSP performance level will yield the desired overall separation performance, additional vehicle error, uncertainty, and system characteristics must be constrained for a given RSSP performance level. These errors, uncertainties, and system characteristics are captured using the following metrics which will be further defined in Section 6.7.1:

<sup>11</sup> The expectation is that such maneuvers would be away from ownship, except in the case of near-simultaneous maneuvering.

- a) 4D RNP performance level<sup>12</sup>;
- b) Accuracy, integrity and continuity of surveillance data from reference aircraft, including intent data if present;
- c) How quickly the aircraft can respond (the relative time between recognizing that a conflict requires a resolution maneuver and completion of that resolution maneuver);
- d) How long before closest point of approach conflict resolution maneuvers can be selected;
- e) How long before initiation of non-emergency maneuvers new intent information is broadcast;
- f) Surveillance system range at X% message reception probability and other surveillance datalink performance characteristics; and
- g) Degrees of freedom employed for resolution maneuvers (lateral, longitudinal, vertical, and combinations thereof);

## **6.5 Assumptions**

This document makes several assumptions applicable to all classes of system, and the remainder applies to Class A systems only.

### **6.5.1 Assumptions Applicable to All Classes**

#### **6.5.1.1 Uniformity of Equipage**

Because the RSSP capability is expected to be applied to a volume of airspace, it is assumed that all aircraft operating in that airspace will at least meet the minimum RSSP standards required by the airspace.

#### **6.5.1.2 Reference Aircraft State**

The RSSP concept assumes that all aircraft in the airspace continuously transmit and receive ADS-B data in compliance with RTCA DO-242A including the following parameters:

- Target identity
- Latitude and longitude
- Pressure altitude
- Position accuracy and integrity
- North and east velocity
- Vertical speed
- Velocity accuracy and integrity
- Time of applicability (reference time of the other state parameters)

It is further assumed that ownship and reference are either using the same transmission format for ADS-B (e.g. 1090ES or UAT) or the airspace is served by an Automatic Dependent Surveillance – Rebroadcast (ADS-R) service that reliably echoes messages between the two transmission formats with negligible delay.

---

<sup>12</sup> The 4D RNP performance level defines the accuracy, integrity, and continuity performance of each aircraft in the lateral (RNP-RNAV), longitudinal/time (TOAC), and vertical (VNAV) dimensions.

### **6.5.1.3 Ownship State**

The ASAS function has access to at least the set of ownship state parameters for that is available via ADS-B for the reference aircraft.

## **6.5.2 Assumptions Applicable to Class A Systems**

### **6.5.2.1 Reference Aircraft Intent**

The primary differentiator between Class A and Class B systems is the availability of intent information for the reference aircraft. The intent information, which is not yet fully defined in the relevant ADS-B standards, will at least describe the intended motion of reference as a sequence of segments within which intermediate 4D states may be computed without significant accuracy degradation using the assumption of uniform (possibly zero) acceleration along the three primary aircraft axes. This intent information should cover at least the minimum time horizon required by the applicable RSSP performance level for conflict detection. The intent information will be updated whenever the reference aircraft's current intent differs significantly relative to the accuracy requirements of the intent broadcast (which will in turn be specified either by the ADS-B standard or by the RSSP performance level). For RSSP performance levels intended for use in dense and complex airspace, there is a requirement that the reference aircraft broadcast a change in intent at least a minimum notification time in advance of performing a maneuver<sup>13</sup> that had not been included in prior intent broadcasts. This requirement is needed to reduce the likelihood of simultaneous conflicting near-term maneuvers.

### **6.5.2.2 Ownship Intent**

The RSSP concept assumes that a Class A system has access to detailed and accurate ownship intent information and associated accuracy metrics from the onboard Flight Management System (FMS) or equivalent. Ownship is assumed to be operating at a specified 4D RNP level (a successor to the current standard that defines containment in the longitudinal/time and vertical dimensions in addition to the lateral dimension) such that guidance is provided to maintain conformance to broadcast intent in all dimensions. Alternatively, ownship intent will be updated before significant deviations accumulate in the longitudinal/time or vertical dimensions.

## **6.6 Definitions**

The definition of key terms used in this section is collected below for convenience. Italics are used to denote terms in these definitions that may be found in this section.

### **6.6.1 Required Self-Separation Performance**

#### **SELF-SEPARATION**

The process by which one aircraft assumes responsibility for managing the distance between itself and one or more reference aircraft without direct involvement of the ANSP.

---

<sup>13</sup> Obviously, this requirement would not apply to the non-normal case of a maneuver required for collision avoidance or other safety-related exigency.

## **REQUIRED SELF-SEPARATION PERFORMANCE (RSSP)**

A statement of the *self-separation* performance necessary for operation within a defined airspace.

### **CLASS**

The type or category of RSSP compliant system.

### **CLASS A**

An RSSP compliant system that uses intent information to provide more robust conflict detection and avoidance capabilities in airspace where aircraft can reasonably be expected to be maneuvering (e.g. terminal or high density airspace).

### **CLASS B**

An RSSP compliant system that needs only position and velocity information to perform conflict detection and resolution.

### **EXCLUSION ZONE**

The volume around an aircraft that no other aircraft may be permitted to transgress, either due to risk of physical contact or risk of significant wake vortex encounter.

### **POINT OF CLOSEST APPROACH (PCA)**

The *3D position* where the lateral distance of one aircraft to the other aircraft's *exclusion zone* is at a minimum, or, in the vertical dimension, the *3D position* where the vertical distance of one aircraft to the other aircraft is at a minimum while either aircraft is within the lateral extent of the other aircraft's *exclusion zone*<sup>14</sup>.

### **DESIRED SEPARATION**

The required lateral (or vertical) distance, between Ownship and Reference Aircraft at the *PCA*.

### **DEFINED SEPARATION**

The lateral (or vertical) distance, between Ownship and Reference Aircraft at the *PCA* that is input to the ASAS function.

### **ACTUAL SEPARATION**

The true lateral (or vertical) distance, between Ownship and Reference Aircraft when they are at the true *PCA*.

### **ESTIMATED SEPARATION**

The output of the separation computation function, equal to the computed lateral (or vertical) separation at the computed *PCA*. This does not take into account potential future maneuvers that are not reflected in the ownship *predicted trajectory* or the reference aircraft *intent*.

---

<sup>14</sup> The concept of exclusion zone is introduced to distinguish between pure metal-on-metal contact-based standards versus future standards that need to account for such things as wake vortices because of their reduced dimensions.

## 6.6.2 Trajectory

### 3D POSITION

A position in space consisting of latitude, longitude, and altitude.

### TIME REFERENCE

The reference time source for the trajectory; for example, Universal Coordinated Time (UTC).

### CURRENT TIME

The present time according to the *time reference*.

### PREDICTED TRAJECTORY

The predicted *3D position* of an aircraft as a function of time.

### INTENT

The representation of an aircraft's *predicted trajectory* that is encoded in ADS-B messages.

### ESTIMATED TIME

The time input to the trajectory prediction function, synchronized to the *time reference*.

### ESTIMATED 3D POSITION

The *3D position* input to the trajectory prediction function. This position is determined by a Navigation function based on sensor inputs.

### ESTIMATED TIME OF ARRIVAL (ETA)

The time at which an aircraft will arrive at a defined point on the *predicted trajectory*.

### TIME TO GO (TTG)

The duration from the *current time* until the aircraft reaches a defined point, typically in this discussion, the *PCA*.

### TRAJECTORY CHANGE POINT (TCP)

A discrete point on the *predicted trajectory* containing the latitude, longitude, altitude, time, and speed (either CAS or Mach). This is a basic set of variables that may be standardized and/or expanded in the future.

## 6.6.3 Error Terms

### SEPARATION ERROR

The difference between the planned separation at the *PCA* when a clearance maneuver was formulated and the separation at the actual *PCA*. The tails of the statistical distribution of this parameter are effectively bounded for each combination of RSSP class and performance level and conflict encounter geometry (crossing angle and speeds).

### LATERAL SEPARATION ERROR

The separation error measured in the horizontal plane.

**SEPARATION DEFINITION ERROR (SDE)**

The difference between the *desired separation* and the *defined separation*, for example due to approximations used in the separation function to define the *exclusion zone*.

**ESTIMATED TIME ERROR (ETE)**

The difference between the *current time* and the *estimated time*, synchronized to the *time reference*.

**ESTIMATED POSITION ERROR (EPE)**

The difference between the true *3D position* and the *estimated 3D position* of the aircraft.

**COMPUTED SEPARATION ERROR (CSE)**

The difference between the *estimated separation* and the *defined separation*.

**SEPARATION ESTIMATION ERROR (SEE)**

The error in the computation of *estimated separation*.

**SEPARATION CONTROL AUTHORITY (SCA)**

The ability of ownship to maneuver in order to compensate for *computed separation error* and *separation estimation error*.

**TOTAL SEPARATION ERROR (TSE)**

The difference between the *actual separation* and the *desired separation*. It is equal to the sum of the *separation definition error*, *computed separation error*, and *separation estimation error* less the *separation control authority*. The *separation control authority* is subtracted because it represents a controllable portion of the error. The uncontrollable portion of the error is analogous to the FTE in RNP.

#### 6.6.4 Separation Containment Concept

The concept of separation containment is based on the concept of lateral (or cross-track) containment as defined in RTCA DO-236B, but the manner in which it is measured differs. For RSSP, the “RNP value” used in RNP-RNAV is replaced with a pair of measures, Separation Boundary Lateral (SBL) and Separation Boundary Vertical (SBV). This pair of measures defines limits, in the lateral and vertical dimensions respectively, around the *desired separation* within which the *actual separation* will fall for at least 95% of encounters requiring some form of resolution maneuver.

**Separation containment integrity** requirements limit the probability of the *Total Separation Error* exceeding the SBL/SBV requirements with no annunciation at least some specified time T before reaching the *PCA*.

**Separation containment continuity** requirements limit the probability of a loss of function. In this context, function is defined as the ability to meet the separation containment requirement (i.e. to be within the desired SBL/SBV limits at and after time T).

There are five possible system states relative to the SBL/SBV limits. These states are:

- |   |                     |
|---|---------------------|
| 1) S1: TSE > SBL/SBV, TTG > T, no alert | (Integrity)         |
| 2) S2: TTG > T, alert                   | (Continuity)        |
| 3) S3: TSE > SBL/SBV, TTG < T, no alert | (Integrity)         |
| 4) S4: TTG < T, alert                   | (Continuity)        |
| 5) S5: TSE < SBL/SBV, no alert          | (Normal Operations) |

Note:  $P(S1) + P(S2) + P(S3) + P(S4) + P(S5) = 1$  where  $P(x)$  is the probability of the system being in State  $x$ .

$T$  is the minimum amount of time prior to reaching *PCA* that the alert must be made if the aircraft cannot achieve the *desired separation*.

States 1 and 3 represent the set of events associated with a loss of separation performance with no annunciation (alert), and are thus the **integrity requirements**. The uncertainties associated with separation predictions generally increase with time or distance from the current position (primarily due to forecast wind uncertainties). Thus, the probability of State 1 will be greater than the probability of State 3 ( $P(S1) \gg P(S3)$ ) due to  $TTG > T$ . However, it also needs to be considered that the control authority that ownship has to correct for these uncertainties will also generally decrease as the aircraft approaches the *PCA*. This needs to be considered when determining a prior time  $T$  beyond which it is critical that an annunciation be received. Thus, the probability of S1 must be less than  $XX^{15}$  per flight hour, while the probability of S3 must be less than  $YY$  per operation.

The **continuity requirement** applies to states S2 and S4 where the loss of function is detected and annunciated. When current time is still far before  $T$ , the available control authority will be larger, and thus the probability of state S2 must be less than  $WW$  per flight hour. When the aircraft is close to time  $T$  the control authority is greatly reduced, and thus the probability of S4 must be less than  $ZZ$  per flight hour. S5 represents the normal operation where the error is less than the SBL/SBV.

In addition to the containment requirements, there is an **uncertainty parameter** associated with the predicted separation. This uncertainty must be bounded to ensure appropriate control authority is available.

## CONTAINMENT

A set of interrelated parameters used to define the performance of a separation control system. These parameters are *containment integrity* and *containment continuity*.

## CONTAINMENT INTEGRITY

A measure of confidence in the estimate, expressed as the probability that the system will detect and annunciate the condition where the TSE is greater than the SBL/SBV limit and the condition has not been detected.

---

<sup>15</sup> This and the following probability parameters will need to be determined based on a TLS and any mitigations that are identified as part of the procedures defined by the ANSP. In practice, they will likely be tailored to specific RSSP performance categories.



## **CONTAINMENT CONTINUITY**

The capability of the total system to satisfy the performance limit without nonscheduled interruptions during the intended operation. Nonscheduled interruption is defined to be either 1) total loss of time prediction capability; 2) a failure of the system which is annunciated as a loss of time performance capability; or 3) a false annunciation of loss of time performance capability.

## **CONTAINMENT REGION**

A region in both the along-track and cross-track dimensions, centered on the *desired along track position* on the *desired path* at a desired time T, to which the *containment integrity* and *containment continuity* are referenced.

## **SEPARATION BOUNDARY LATERAL (SBL)**

The limit in the lateral dimension around the *desired separation* within which the *actual separation* will fall for at least 95% of encounters requiring some form of resolution maneuver.

## **SEPARATION BOUNDARY VERTICAL (SBV)**

The limit in the vertical dimension around the *desired separation* within which the *actual separation* will fall for at least 95% of encounters requiring some form of resolution maneuver.

## **6.7 System Performance Requirements**

### **6.7.1 Accuracy**

Accuracy is a measure of the difference between an aircraft's intended separation from a reference aircraft at the PCA (relative to the exclusion zone boundary) and the true separation at the true PCA. It is given by a value associated with a confidence interval. For example; within airspace requiring a particular RSSP performance level, the separation error will not be greater than 0.5 nautical miles for 95% of the conflicts requiring a resolution maneuver.

### **6.7.2 State Data Accuracy Metrics**

#### **6.7.2.1 The first two metrics deal with the accuracy of navigation data available to ownship and of the surveillance data provided by reference (and by inference, provided by ownship). Ownship Navigation Accuracy**

If ownship is operating according to 4D RNP standards, then those standards define the lateral and longitudinal accuracy and containment parameters for ownship state estimation both at the present position and along ownship's 4D trajectory. This is the expected norm for Class A systems. For Class B systems, it will be necessary to break this metric into individual lateral position, longitudinal position, and velocity sub-metrics in order to specify the ownship navigation accuracy.

#### **6.7.2.2 Reference Surveillance Accuracy**

The position and velocity accuracy and integrity for the reference accuracy are reported in ADS-B messages as the navigation accuracy for position and velocity plus the surveillance integrity level. When intent data is broadcast, it will need similar reported metrics. For a given RSSP

performance level, a set of minimum acceptable values for each of these quality metrics will constitute the reference surveillance accuracy metric.

### **6.7.3 Additional Metrics**

In order to characterize the ability of an aircraft to perform self-separation, especially in more congested airspace, additional metrics also need to be specified.

#### **6.7.3.1 Response Time**

This metric measures how quickly the aircraft can respond to the need to resolve a conflict. This applies whether the time to go to an anticipated conflict has just reached a threshold value or the reference aircraft has either maneuvered or broadcast new intent. It is measured as the relative time between recognizing that a conflict requires a resolution maneuver and completion of that resolution maneuver.

#### **6.7.3.2 Look Ahead**

Look ahead measures how long before the closest point of approach a conflict resolution maneuvers can be selected. It is primarily dictated by the accuracy of separation prediction as a function of time to go to PCA and the characteristics of the surveillance datalink (reception probability versus range).

#### **6.7.3.3 Intended Maneuver Anticipation Time**

For Class A systems, it is expected that the ASAS function will plan the resolution maneuver to commence some time in the future in order to provide notice of the change in intent to neighboring aircraft before the maneuver begins. This metric captures the amount of time before the initiation of non-emergency maneuvers that new intent information is broadcast.

#### **6.7.3.4 Surveillance Datalink Performance**

In order to function effectively, the ASAS function needs to have surveillance data at a range that exceeds its required look ahead time. Given assumptions of maximum closing speeds expected in a particular class of airspace, this can be translated into a surveillance range requirement defined as the range at which there is at least an X% ( $X \geq 95$ ) probability of receiving each transmission from reference.

#### **6.7.3.5 Resolution Flexibility**

Lower performance category ASAS systems might only provide simple lateral maneuvers, such as turns or sidesteps, to resolve conflicts. Higher performance systems would take advantage of lateral, vertical, and speed controls to find resolutions. The highest performing systems might be able to plan complex combinations of the three and be able to find resolution paths in the presence of multiple potentially conflicting aircraft. This metric seeks to enumerate or quantify these differing performance levels. Looked at another way, this metric captures the robustness with which the ASAS can find a path through multiple constraints.

## **6.8 Integrity**

Integrity is a measure of the probability that information provided by a system will not be hazardously misleading. It is generally expressed as a probability of occurrence per operating

hour, which expresses likelihood that a system will send the user bad/incorrect information that could cause a potentially dangerous situation without a timely warning. For example the likelihood that the separation error exceeds a maximum of 1.0 nautical miles, without having alerted the flight crew at least 90 seconds in advance of the exceedance, shall be less than  $10^{-5}$  per flight hour.

## **6.9 Continuity**

Continuity is the capability of a total system to perform its intended function without a non-scheduled interruption during the intended operation assuming the system was available when the procedure was initiated. Continuity is expressed per unit of time. For example; the calculations of a single thread transponder mean time to failure of 5,000 hours.

## **6.10 Availability**

Availability is the probability that a system will perform its required function at the initiation of the intended operation. For example, the FAA target for availability of the Wide Area Augmentation System is 0.999.

## **7 Required Interval Management Performance Conceptual Framework**

### **7.1 Introduction**

Airborne Precision Spacing (APS) has been developed by NASA as an element of pair-wise interval management to improve the merging and spacing performance during approach and landing for high-density operations. APS provides speed control guidance to the flight crew with an assigned spacing interval in the time domain at the runway threshold or a common waypoint with respect to a paired leading airplane (reference aircraft). Speed control guidance is derived from both the reference aircraft and ownship's flight profiles, current states of the reference aircraft and the ownship, and speed and altitude constraints at intermediate points along the approach routes. The projected benefits of APS include providing the flight crew and air traffic controllers an automated speed control tool and advisories in delivering airplanes at the runway threshold at precise time intervals. This precise performance can optimize the flow of traffic approaching the runway, and may increase the runway throughput [1]. The concept of APS is also in full conformance with two key NextGen environment components as defined by Joint Planning and Development Office (JPDO) [2], which are Performance-Based Operations and Services and Aircraft Trajectory-Based Operations (TBO). The extension of Required Navigation Performance (RNP) in the time domain based on APS is a natural step towards the objectives of the NextGen air traffic environment. The Required Interval Management Performance (RIMP) will provide a means to assure the interval management accuracy, availability, continuity, and integrity during terminal and approach phases of flight. This can lead to a time-based interval management concept of operations. One of the benefits of a time-based RIMP is to allow enroute and terminal air traffic controllers to manage the spacing via time in seconds instead of closely monitoring merging traffic's speed and distance for maintaining safe separation and compressing the traffic flow from en-route minima [3]. With the combination of APS and RIMP (APS-RIMP), workload of Air Navigation Service Provider (ANSP) controller can be potentially reduced. RIMP compliant airplanes will also ensure the performance and accuracy in delivering airplanes at managed spacing intervals. This document will present the concept of applying RIMP in APS, describe the system components, identify key system parameters, and discuss the derivation of RIMP requirements, procedures, assumptions, and RIMP dependency of uncertainties in airplane's flying performance and equipment performance.

### **7.2 System Overview**

The air traffic operations outlined in this document provide an APS-RIMP concept for aircraft converging to a common destination such as a runway or an intermediate navigation fix. APS is a potential speed advisory element of future high-density arrival and departure operations envisioned in the NextGen air traffic system. The focus of this APS-RIMP concept is the terminal and final approach portions of the flight. The precision spacing is accomplished by sequencing the arriving aircraft early in the initial descent phase. Each aircraft is assigned a reference aircraft to follow as shown in Figure 6. The paired aircraft may share a portion of the final assigned route, but this is not required. To achieve significant arrival density increase, this concept relies on precise spatial and temporal navigation that must be achieved for safe flight

operation. This is accomplished by extending the RNP methodology to include an interval management time performance with associated uncertainty in seconds. Similar to the lateral RNP rating, an interval management time rating will define a maximum uncertainty and a containment time which is defined in section 1.4.4 of this document.

All aircraft engaged in this APS operation must meet a certain level of RIMP. Different levels of RIMP are described in section 1.4.4 of this document. This applies to both the reference aircraft and the ownship. This concept applies to sequences of paired aircraft where the ownship itself becomes the reference aircraft for the subsequent following aircraft.

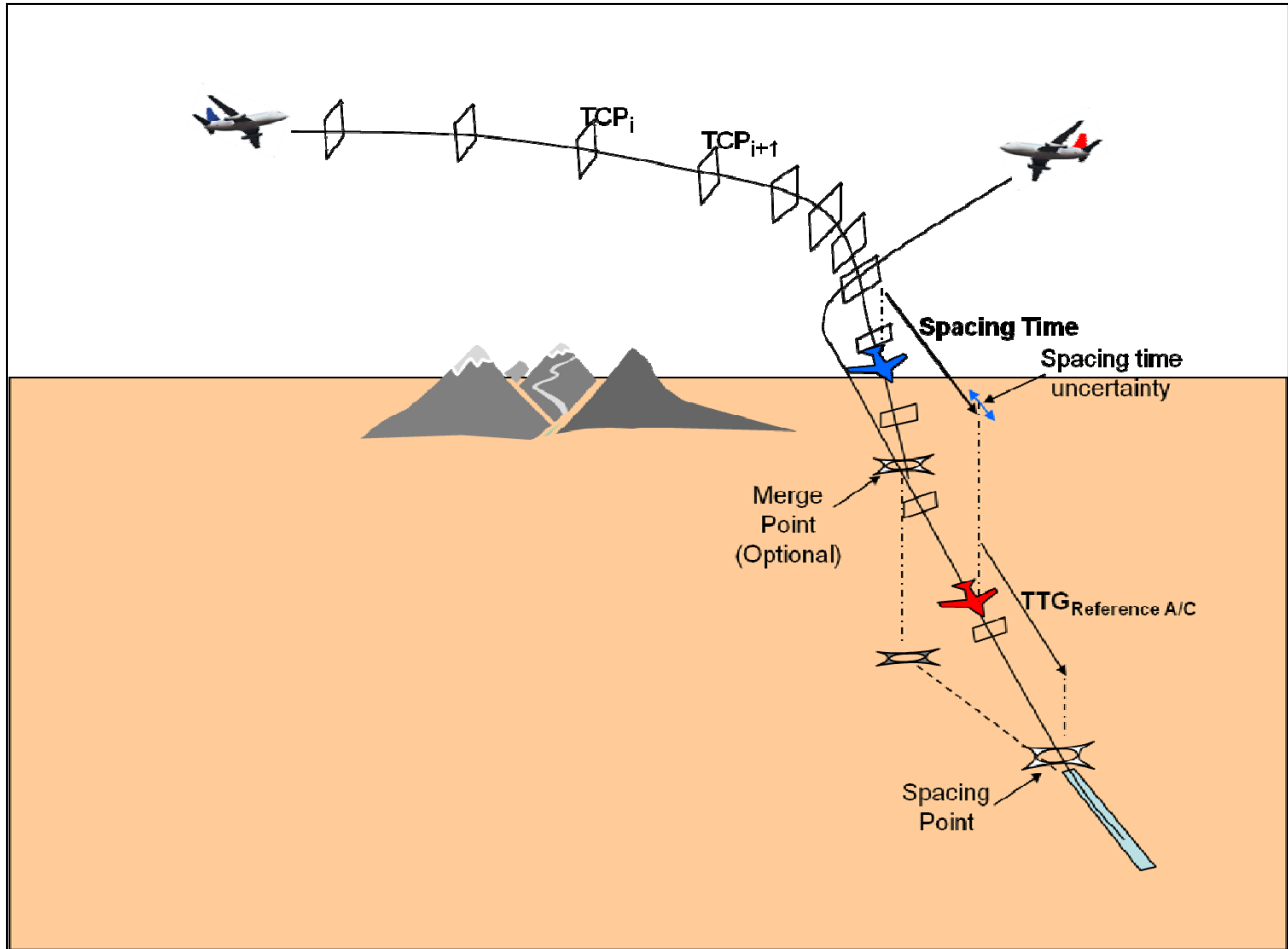

**Figure 6 - Overview of APS-RIMP Operation**

The APS-RIMP precision spacing concept outlined here uses many aspects of the NextGen technology to perform the required navigation and guidance. This includes integrated surveillance capabilities provided by Automated Dependent Surveillance – Broadcast (ADS-B), Traffic Information Service – Broadcast (TIS-B), Flight information Service – Broadcast (FIS-B) and associated ground radars, and precision navigation and timing provided through Global Navigation Surveillance System (GNSS). It also relies on digital data link communication with the ANSP facilities and personnel. The techniques used to accomplish the precision spacing include automatic 4 Dimension (4D) trajectory generation to the desired destination or

navigation fix, real-time adjustments to the prescribed velocity profile to maintain the desired separation, and 4D navigation performance monitoring to ensure the RNP and RIMP for the precision spacing operation is available and attainable.

An integrated navigation system as addressed here includes one or more navigation sensors (such as Inertial Navigation System (INS)/Global Positioning System (GPS)), one or more air data sensors, and other relevant aircraft sensors (such as angle of attack, propulsion system sensors, etc.) to assess overall system performance, surveillance sensors (such as ADS-B), digital data link with the air traffic control authority (ANSP) and extensive processing capability to define 4D trajectories and perform the required 4D guidance (Figure 7). The navigation and guidance algorithms developed in support of this concept perform position estimation, path definition, path steering, and calculation of Time-To-Go (TTG) to the destination (navigation fix or runway threshold) for the aircraft as well as for the lead aircraft to which the ownship has been paired to follow.

The APS system will provide a precise adjustment to the nominal speed command to achieve the spacing constraint, and provide the flight crew with situation indications and alert them if the required spacing can not be achieved.

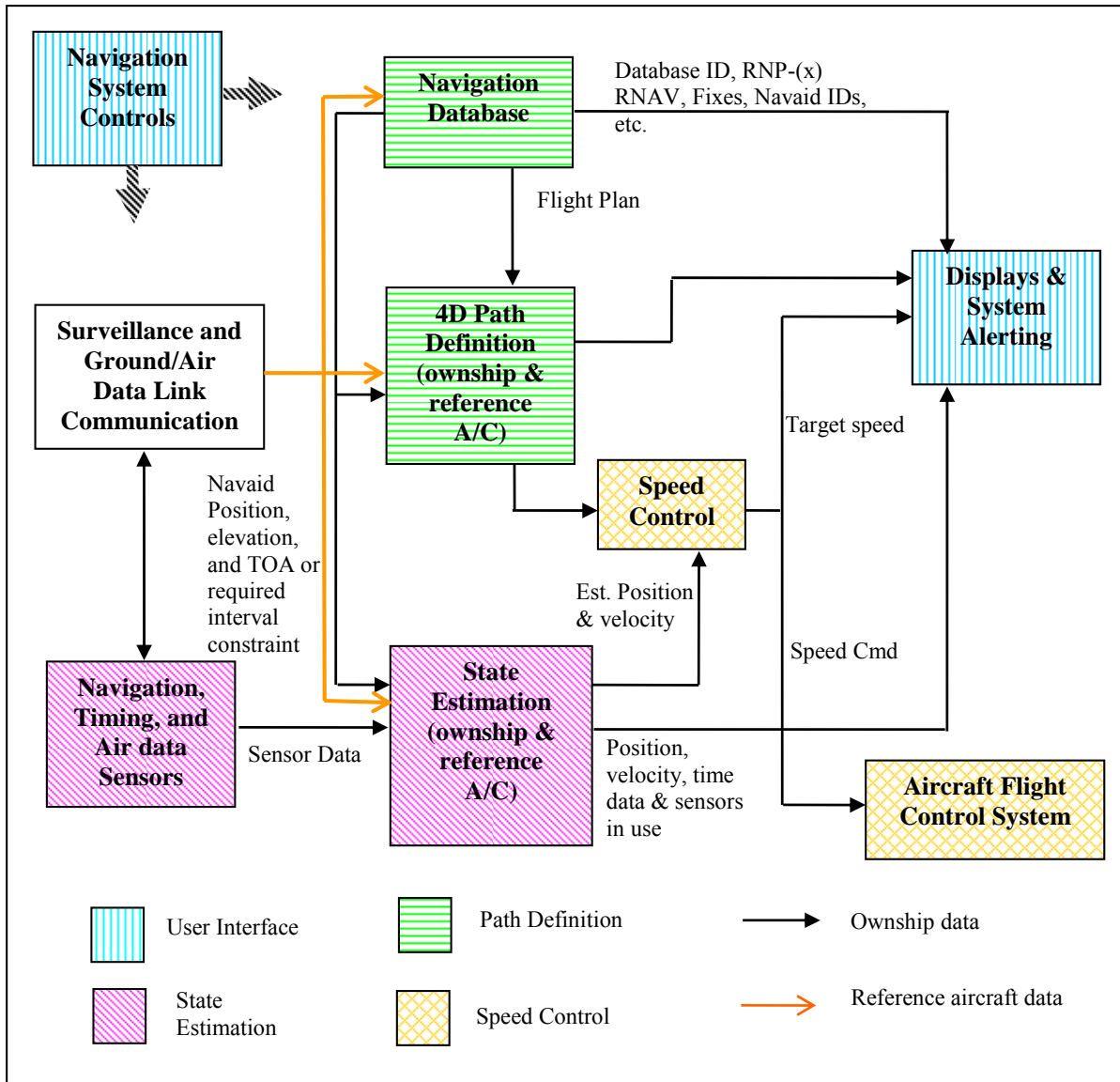

Figure 7 - APS System Block Diagram

### 7.2.1 State Estimation

Position estimation requirements are outlined in RTCA DO-236B (section 1.2.1) [3]. Additionally, APS-RIMP operation will require timing, surveillance, wind and air temperature information. Precise time measurement using a common time reference and an accurate estimate of time uncertainty associated with that measurement are needed to arrive at the ownship time-to-go estimates. The current position and speed of reference aircraft and its intended 4D trajectory are needed for the reference aircraft's time-to-go calculations. Finally, the predicted or measured wind field along the terminal operation and approach path is needed.

The method by which the precise timing, surveillance data, and wind and air temperature estimates are acquired is not provided here. However, this document provides overall requirements for system performance, accuracy, integrity, continuity, and availability of the data.

### 7.2.2 4D Path Definition

The path definition function computes the defined 3D path and associated speeds to be flown. A complete 4D path will consist of a number of straight or arc segments in the horizontal plane plus altitude and speed specifications as shown in Figure 8. Each segment ends at a trajectory change point (TCP). The TCPs are assigned by a 4D trajectory generation algorithm which attempts to optimize the spacing and merging of the ownship with the assigned reference aircraft. A TCP may overlap an existing navigation fix (Area Navigation (RNAV) waypoint, airway fix, etc.) but this is not required. It is, however, anticipated that the trajectory endpoint will coincide with a known navigation fix such as the runway threshold or final approach fix (FAF). Each generated trajectory segment or leg will include complete horizontal and vertical navigation information as well as a nominal target speed (CAS or Mach) to fly.

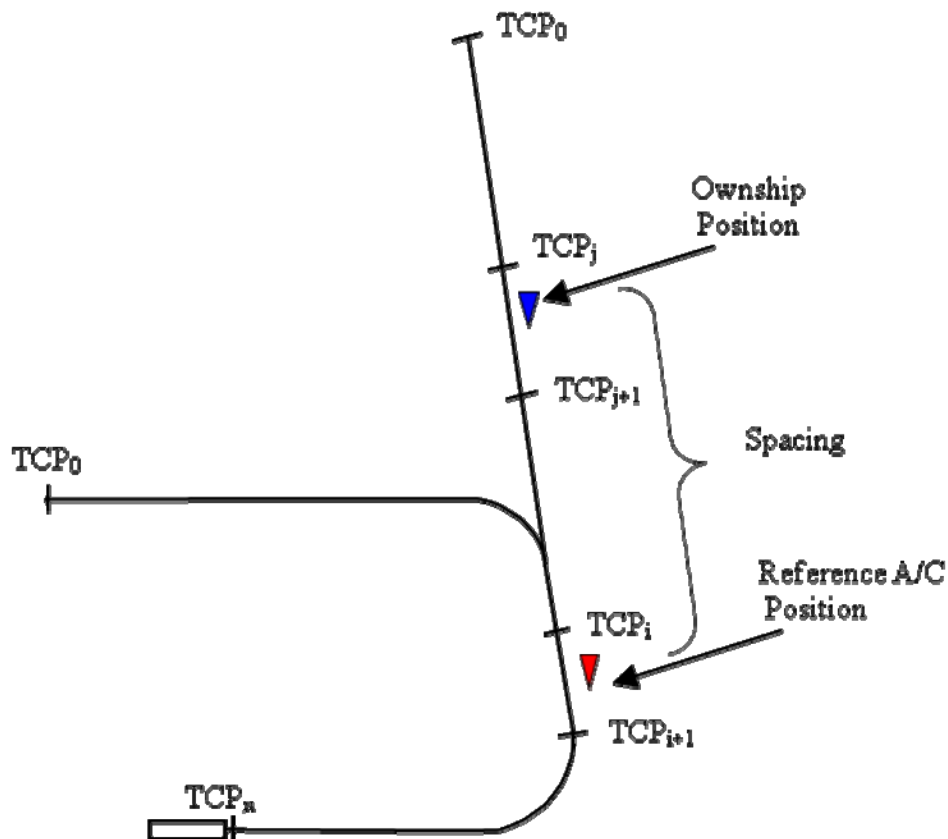

**Figure 8 - Representative Layout of Paired Airplanes in Precision Spacing Mode**

For each leg of the trajectory, the lateral aspects of path definition determine a geographically fixed ground track from origin to destination. This defines a 2D component of the flight path. The sub-functions involved are:

1. TCP location definition in latitude and longitude, or in the case of TCP definitions that do not have exact location information, an estimate of the TCP position based on the known or predicted state of the aircraft;
2. Leg type definition as provided in RTCA DO-236B and ARINC 424;



3. Leg transition definition which specifies turning to the next leg prior to intercepting the waypoint or flying through the waypoint prior to turning, etc.;

For each leg of the trajectory, the vertical aspect of the path definition determines an elevation change from the TCP at the beginning of the leg to the TCP at the end of the leg. This adds the 3<sup>rd</sup> dimension to the defined flight path. The vertical aspect sub-functions are:

1. Altitude or flight level constraints associated with waypoint definition; (Flight Level, corrected barometric altitude, temperature compensated altitude, or height above ellipsoid for GPS based precision approach)
2. Optional vertical angle or altitude change associated with the leg definition and vertical transition definition which specifies how the leg should be flown. For example, climb and hold or follow a glideslope;
3. Optional speed constraint;

The temporal aspects of the path definition determine the method used to satisfy time constraints associated with either the precision separation requirement or time of arrival constraint at the destination waypoint. The time constraints must take into account the lateral and vertical trajectory, the flight environment, and real-time parameters provided by the ANSP and the assigned reference aircraft. This is accomplished through speed control which controls the fourth dimension (time) for the flight path. The temporal aspect sub-functions are:

1. Nominal interval management time;
2. Optional speed constraint;

### **7.2.3 Speed Control**

The speed control function uses the planned 4D trajectories of both the ownship and the lead aircraft along with current measured positions and velocities of both the ownship and the reference aircraft, latest wind estimates, and other associated parameters to determine the along-path range to the spacing point, speed variation, and target speed command. These parameters are used to correct errors and interval variations relative to the reference aircraft. The lateral and vertical steering functions are defined in RTCA DO-236B [3] and are omitted from this document. This document instead focuses on the speed control function.

To achieve precise arrival spacing, the navigation system must compute a number of parameters for both the ownship and the reference aircraft. These parameters include the distance along the trajectory from the current estimated position to the interval management point (such as the runway threshold or a common merge point), estimated ground speed for each segment of the trajectory, and a total TTG to arrive at the interval management point. These calculations require knowledge of the current and predicted states of the ownship and lead aircraft, as well as external factors such as the forecast wind and temperatures along the trajectory. Prior to the start of this paired approach, the trajectory generation algorithms generate an optimum profile for both the ownship and the reference aircraft. When executed, these 4D trajectories will ensure achieving the desired interval at the interval management point, and will provide an efficient terminal area operation (with constraints such as fuel burn, noise abatement, etc.). Once the aircraft are paired, the precision spacing function computes a change in planned speed for the ownship as needed to

attain the precise spacing interval upon arrival at the interval management point. The target speed will be the sum of the planned trajectory speed at the current location on the trajectory plus the required adjustment to account for variations of aircraft states of both the ownship and the reference aircraft. The target speed may be periodically updated as new navigation data and/or new constraints become available and as the estimates of the atmospheric parameters change. This target speed will be displayed to the flight crew and could also be supplied to the flight control system for possible automated speed control operations.

The accuracy of TTG prediction for interval control purposes will depend upon the accuracy of the parameters input or calculated, the control system accuracy, external factors such as winds, and the aircraft performance (including operating limits). As the reference aircraft approaches the interval management point, the accuracy of the TTG prediction will increase. The aircraft performance limitations such as speed and angle of attack limits will become the primary constraint on achieving the required spacing time without altering the flight path.

## **7.2.4 User Interface**

### **7.2.4.1 Controls, Displays, and System Alerting**

The user interface is achieved through system controls, displays, and alerting functions. These functions provide the means for system initialization, 4D trajectory generation and progress monitoring, active speed control and presentation of spacing time data for flight crew situational awareness. Refer to RTCA DO-236B (section 1.2.4.1) for additional information on user interfaces.

### **7.2.4.2 Reporting**

The aircraft's instantaneous position and velocity must be reported via a digital data link (ADS-B). Depending on the required level of RIMP, other critical parameters may be required in the data link such as the planned 4D trajectory currently being flown by the aircraft.

## **7.3 Required Interval Management Performance**

### **7.3.1 Time Navigation**

The NextGen TBO environment is expected to include precise time-based operations where aircraft will be required to arrive at a point at a specified time. This time may be a fixed time of arrival or a time relative to the arrival time of the reference aircraft. The first type of time operation is referred to as Time of Arrival Control (TOAC), while the second is referred to as relative time spacing.

In addition to time computation and control accuracy, there is also a need to provide a level of confidence in which aircraft can perform time operations at the geographic fixes in a TBO environment.

### **7.3.2 RIMP Concept**

The concept of time performance has not been defined by the ICAO in the same manner as RNP, and the Minimum Aviation System Performance Specification (MASPS) addresses accuracy

requirements of ETA and TOAC at only a very high level. Because of the perceived importance of time-based operations in the NextGen Air Traffic Management (ATM) environment, this document develops a proposed RIMP construct and associated requirements.

For consistency with the ICAO definition of RNP, this document defines RIMP as: A statement of the time navigation performance accuracy, integrity, continuity and availability necessary for time interval management operations within a defined airspace.

### **7.3.3 Application of RIMP**

The term RIMP is applied as a descriptor for operations that can be part of airspaces, routes, and procedures. Unlike RNP, the descriptor is only applied to each instance where RIMP is required and not the entire airspace, since interval management is done on an operation-by-operation basis. This concept, however, could eventually be applied to the entire airspace.

### **7.3.4 RIMP Types**

The term RIMP-x-y is introduced to denote RIMP operations.

The x indicates the type of RIMP operation

A – Absolute Time

R – Relative Time (ASAS Spacing)

O – Open Loop (Time prediction only, no time control).

*Note: The open loop is a place holder in anticipation of future changes to DO-236B [2]. Additional types of operations may be defined in the future as well. One such operation could be a combination of absolute time at a geographic fix with relative spacing prior to the fix.*

The y indicates the limit of RIMP accuracy in seconds (e.g. RIMP-A-10 indicates absolute time control with 10 seconds required accuracy). There is a correlation between the type and accuracy where the Open Loop type can only achieve a low accuracy. The RIMP accuracy for open loop is expressed in % of TTG as it is expected to only be used for pairings where ownship and the reference aircraft are further out.

## **7.4 Assumptions**

The APS concept of operations relies on the premise that by knowing both the ownship and the reference aircraft's 4D trajectories and the aircraft position along that 4D trajectory, it is possible to determine the ownship and the reference aircraft's Time-To-Go to a given point on their individual trajectories. Therefore, it is necessary to define a means of acquiring the aircraft planned trajectory and position on that trajectory, and define an assumptions-based predictive model for the computation of a 4D trajectory and Time-To-Go.

### **7.4.1 Reference Aircraft State**

The RIMP concept assumes that all aircraft in the airspace continuously transmit and receive ADS-B data in compliance with RTCA DO-242A including the following parameters:

- Target identity
- Latitude and longitude

- Pressure altitude
- Position accuracy and integrity
- North and east velocity
- Vertical speed
- Velocity accuracy and integrity
- Time of applicability (reference time of the other state parameters)

It is further assumed that ownship and reference are either using the same transmission format for ADS-B (e.g. 1090ES or UAT) or the airspace is served by an Automatic Dependent Surveillance – Rebroadcast (ADS-R) service that reliably echoes messages between the two transmission formats with negligible delay.

#### **7.4.2 Ownship State**

The spacing function has access to at least the set of ownship state parameters that is available via ADS-B for the reference aircraft.

#### **7.4.3 Reference Aircraft Intent**

The APS concept assumes that the aircraft has knowledge of the reference aircraft lateral, vertical, and speed profile. There are many possible mechanisms for acquiring an aircraft trajectory ranging from assuming that the reference aircraft will adhere to a published augmented Standard Terminal Arrival Route (STAR) with the augmentation in the form of altitude or speed crossing restrictions at waypoints on the route, to the acquisition in real time of a Flight Management System (FMS) profile being broadcast by the reference aircraft. The method used is a determinant factor in quantifying the level of accuracy and integrity of the trajectory.

Regardless of the method used, the RIMP level of performance will be a function of:

1. The errors and uncertainty in the reference aircraft actual lateral, vertical and speed profile flown versus its published profile. The Reference aircraft is assumed to be RNP compliant in that its lateral and vertical deviation from the published profile is bounded by the profile’s published RNP accuracy and integrity figures of merit.
2. The errors and uncertainties in the true wind field and temperature profile versus the forecast. It is assumed that ownship has access to a forecast wind field and temperature profile applicable to both the ownship and the reference aircraft.

#### **7.4.4 Ownship Intent**

The RIMP concept assumes access to detailed and accurate ownship intent information and associated accuracy metrics from the onboard FMS or an equivalent system. Ownship is assumed to be operating at a specified RNP level.

### **7.5 Definitions**

This section defines key terms that are used throughout this document.

#### **7.5.1 Required Interval Management Performance**

##### **REQUIRED INTERVAL MANAGEMENT PERFORMANCE (RIMP)**

A statement of the performance accuracy of an in-trail paired interval management operation between two aircraft.

## **PAIRED INTERVAL MANAGEMENT**

An operation where a trailing aircraft is required to arrive at a *waypoint* a specified time period after a specified reference aircraft arrives at that same *waypoint*.

## **OWNSHIP**

The trailing aircraft which is controlling the interval in a *paired interval management* operation.

## **REFERENCE AIRCRAFT**

The leading aircraft which *Ownship* is required to space relative to.

## **7.5.2 Trajectory**

### **3D POSITION**

A position in space consisting of latitude, longitude, and altitude.

### **WAYPOINT**

A predetermined geographical position used for route definition and/or progress reporting purposes that is defined by latitude and longitude [2].

### **TIME REFERENCE**

The reference time source for the trajectory; for example, Universal Coordinated Time (UTC).

### **CURRENT TIME**

The present time according to the *time reference*.

### **PREDICTED TRAJECTORY**

The predicted *3D position* of an aircraft as a function of time.

### **ESTIMATED TIME**

The time input to the trajectory prediction function, synchronized to the *time reference*.

### **ESTIMATED TIME OF ARRIVAL (ETA)**

The time at which an aircraft will arrive at a defined point on the *predicted trajectory*.

### **ESTIMATED TIME TO GO (ETTG)**

The predicted duration from the *current time* until the aircraft reaches a defined point.

### **TIME TO GO (TTG)**

The duration from the *current time* until the aircraft reaches a defined point, typically in this discussion, the *Interval Management Point*.

### **TRAJECTORY CHANGE POINT (TCP)**

A discrete point on the *predicted trajectory* containing the latitude, longitude, altitude, time, and speed (either CAS or Mach). This is a basic set of variables that may be standardized and/or expanded in the future.

## INTERVAL MANAGEMENT POINT

A defined *waypoint* on the *predicted trajectory* at which the specified interval between ownship and the reference aircraft is defined.

### 7.5.3 Error Terms

#### 7.5.3.1 Along-Track

This document considers only along-track error. Cross-Track and Vertical errors are considered only as they contribute to the along track error. Figure 9 below summarizes these terms.

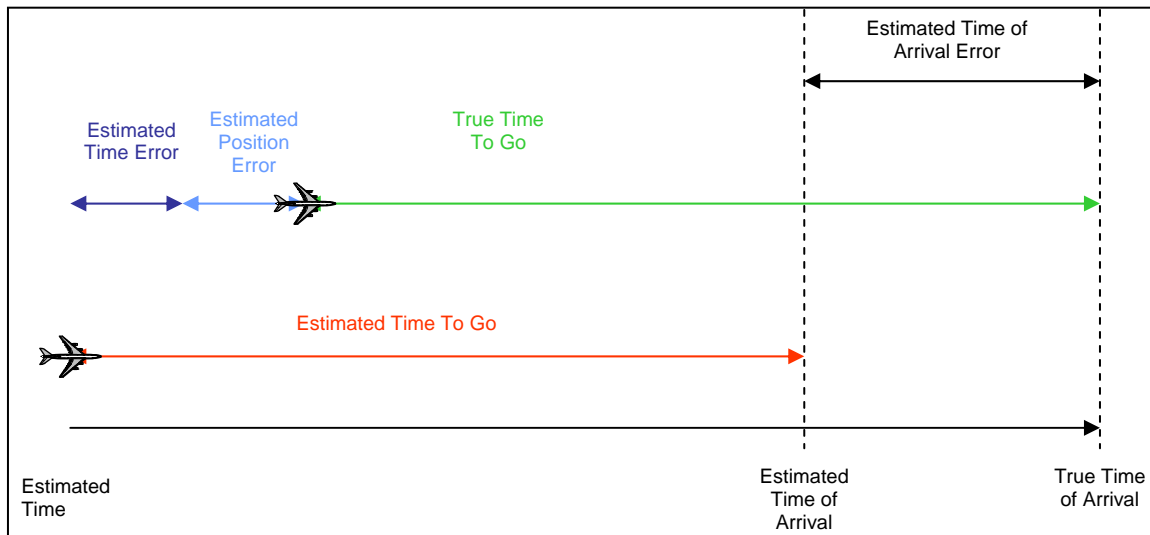

**Figure 9 - Along Track Components of Navigation Error Terms**

#### ESTIMATED TIME ERROR (ETE)

The difference between the *current time* and the *estimated time*, synchronized to the *time reference*.

#### ESTIMATED POSITION ERROR (EPE)

The arrival time error due to difference between the true position and the *estimated position* along the current heading of the aircraft, expressed in seconds.

#### TIME TO GO ERROR (TTGE)

The difference between the true time to go and the *estimated time to go*.

#### ESTIMATED TIME OF ARRIVAL ERROR (ETAE)

The difference between the true time of arrival and the *estimated time of arrival* at a point. This is equal to the vector sum of the *estimated time error*, *estimated position error*, and *time to go error*.

#### 7.5.3.2 Interval Management Performance

There are errors associated with a paired interval management operation which must be considered in the Required Interval Management Performance.

**DESIRED SPACING**

The required time interval, in seconds, between Ownship and Reference Aircraft at the Interval Management Point as might be contained in an instruction issued by the ANSP or defined in a procedure.

**DEFINED SPACING**

The time interval, in seconds, between Ownship and Reference Aircraft at the Interval Management Point that is input to the spacing computation function.

**ESTIMATED SPACING**

The output of the spacing computation function, equal to the difference between Reference Aircraft's *estimated time of arrival* and ownship's *estimated time of arrival* at the *interval management point*. This does not take into account potential future speed changes prior to the *interval management point* that are not reflected in the *predicted trajectory*.

**ESTIMATED TIME BIAS (ETB)**

The portion of the *estimated time of arrival error* that will be identical between ownship and reference aircraft (for example due to a shared wind error along a common path segment).

**SPACING DEFINITION ERROR (SDE)**

The difference between the *desired spacing* and the *defined spacing*, for example due to a difference in resolution between the spacing input and the necessary spacing.<sup>16</sup>

**COMPUTED SPACING ERROR (CSE)**

The difference between the *estimated spacing* and the *defined spacing*.

**SPACING ESTIMATION ERROR (SEE)**

The error in the computation of *estimated spacing*. This is equal to the sum of the *estimated time of arrival error* for both ownship and reference aircraft minus any *estimated time bias*.

**SPACING CONTROL AUTHORITY (SCA)**

The ability of ownship to maneuver in order to compensate for *computed spacing error* and *spacing estimate error*.

**TOTAL SPACING ERROR (TSE)**

The difference between the true spacing and the *desired spacing*. Until ownship has reached the *interval management point*, TSE can only be estimated based on a prediction of ownship *time to go*, either reference *time to go* or measurement of reference *IMP* crossing time, and estimated *spacing control authority*. It is equal to the sum of the *spacing definition error*, *computed spacing error*, and *spacing estimation error* less the *spacing control authority*. The *spacing control authority* is subtracted because it represents a controllable portion of the error. The uncontrollable portion of the error is analogous to the Flight Technical Error (FTE) in RNP.

---

<sup>16</sup> For example, if the desired spacing specified by ATC is in seconds but the defined spacing that is input into the system can only be in tenths of minutes, there could be up to a 3 second spacing definition error.

Since the *spacing estimation error* has to rely on a probabilistic prediction, there may be a need for future control actions to correct for “true” disturbances and errors that were not part of the prediction. Figure 10 also shows how the uncertainty of the predicted time grows the farther from ownship the spacing point is located.

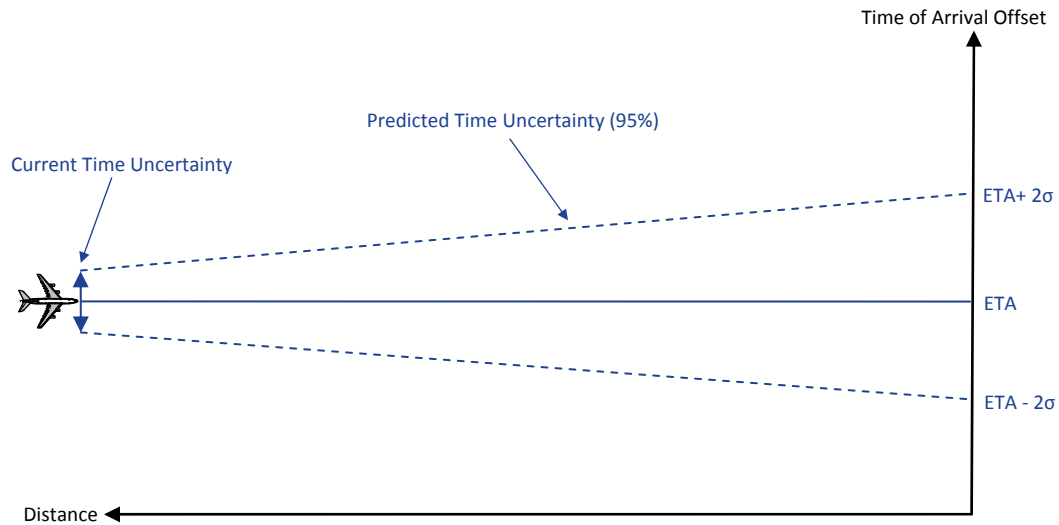
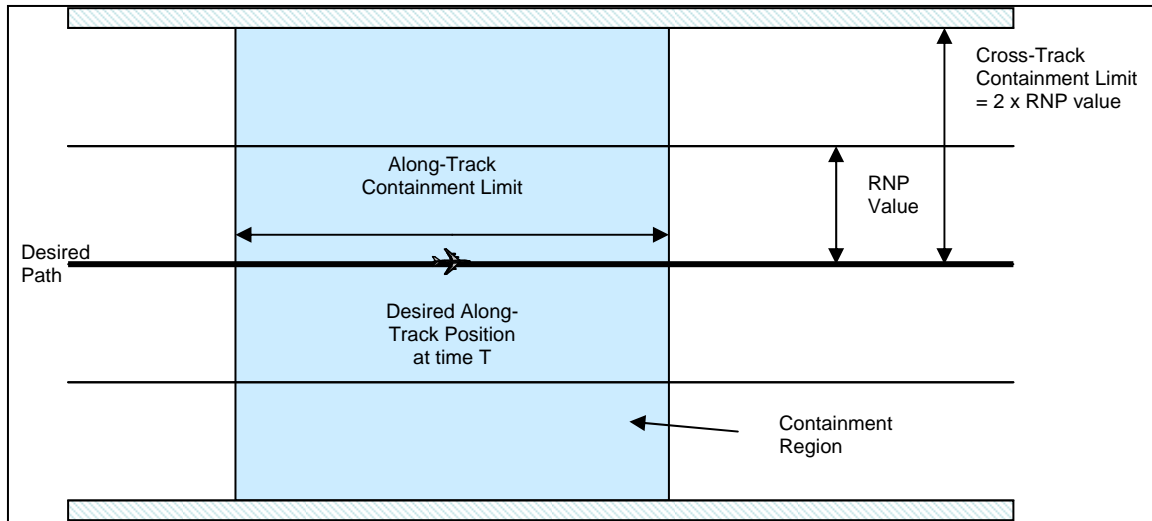

**Figure 10 - Reference Time Profile with Uncertainty**

### 7.5.3.3 Along Track Containment Concept

The concept of along-track containment must be coupled with the concept of lateral (or cross-track) containment as defined in RTCA DO-236B. If a desired lateral path exists, the Cross-Track Containment Limit combined with the Along-Track Containment Limit defines a region around the desired location of the aircraft at a defined future time T. The probability that the aircraft will be within that region in both the cross-track and along-track domains at time T, can be bounded. This time T may be a fixed time, or it may be an offset time relative to another aircraft’s ETA. This concept is depicted in Figure 11 below, and the definitions of these terms follow.





**Figure 11 - Along-Track and Cross-Track Containment Region**

Along-Track **containment integrity** requirements limit the probability of the Total Spacing Error exceeding the Along-Track Performance requirements with no annunciation at least some specified time before the defined time T.

Along-Track **containment continuity** requirements limit the probability of a loss of function. In this context, function is defined as the ability of the APS system to meet the along track containment requirement (i.e. to be within the desired containment limit at time T).

There are five possible system states relative to along-track containment limit, C. These states are:

- 6) S1: TSE Error > C, TTG >  $\Delta T$ , no alert (Integrity)
- 7) S2: TSE Error > C, TTG >  $\Delta T$ , alert (Continuity)
- 8) S3: TSE Error > C, TTG <  $\Delta T$ , no alert (Integrity)
- 9) S4: TSE Error > C, TTG <  $\Delta T$ , alert (Continuity)
- 10) S5: TSE Error < C, no alert (Normal Operations)

Note:  $P(S1) + P(S2) + P(S3) + P(S4) + P(S5) = 1$  where  $P(x)$  is the probability of the system being in State x.

$\Delta T$  is the minimum amount of time prior to reaching the Interval Management Point that the alert must be made if the aircraft cannot achieve the required spacing time.

States 1 and 3 represent the set of events associated with a loss of along-track performance with no annunciation (alert), and are thus the **integrity requirements**. The uncertainties associated with time predictions generally increase with distance from the current trajectory point (primarily due to forecast wind uncertainties). Therefore, the probability that the along-track performance cannot be achieved will generally decrease with distance to the Interval Management Point. Thus, the probability of State 1 will be greater than the probability of State 3 ( $P(S1) \gg P(S3)$ ) due to TTG being >  $\Delta T$ . However, it also needs to be considered that the control authority that ownership has to correct for these uncertainties will also generally decrease as the aircraft

approaches the Interval Management Point. This needs to be considered when determining a time T beyond which it is critical that an annunciation be received. Thus, the probability of S1 must be less than XX<sup>17</sup> per flight hour, while the probability of S3 must be less than YY per operation.

The **continuity requirement** applies to states S2 and S4 where the loss of function is detected and annunciated. When current time is still far before T ( $TTG > \Delta T$ ), the available control authority will be larger, and thus the probability of state S2 must be less than WW per flight hour. When the aircraft is close to time T the control authority is greatly reduced, and thus the probability of S4 must be less than ZZ per flight hour. S5 represents the normal operation where the error is less than the containment limit.

In addition to the containment requirements, there is an **uncertainty parameter** associated with the predicted ETA at various points on the predicted trajectory. This uncertainty must be bounded to ensure appropriate control authority is available.

## **CONTAINMENT**

A set of interrelated parameters used to define the performance of a time control system. These parameters are *containment integrity*, *containment continuity*, and *containment region*.

### **CONTAINMENT INTEGRITY**

A measure of confidence in the estimate, expressed as the probability that the system will detect and annunciate the condition where the TSE is greater than the along-track containment limit and the condition has not been detected.

### **CONTAINMENT CONTINUITY**

The capability of the total system to satisfy the performance limit without nonscheduled interruptions during the intended operation. Nonscheduled interruption is defined to be either 1) total loss of time prediction capability; 2) a failure of the system which is annunciated as a loss of time performance capability; or 3) a false annunciation of loss of time performance capability.

### **CONTAINMENT REGION**

A region in both the along-track and cross-track dimensions, centered on the *desired along track position* on the *desired path* at a desired time T, to which the *containment integrity* and *containment continuity* are referenced.

### **CROSS-TRACK CONTAINMENT LIMIT**

As defined in DO-236B MASPS.

### **ALONG-TRACK CONTAINMENT LIMIT**

A time that defines the one-dimensional containment limit in the along-track dimension. The resulting *containment region* is centered on desired along-track position at desired time T and is bounded by  $\pm$  the along-track containment limit in the along-track dimension.

---

<sup>17</sup> This and the following probability parameters will need to be determined based on a TLS and any mitigations that are identified as part of the procedures defined by the ANSP. In practice, they will likely be tailored to specific RIMP performance categories.

## **ESTIMATED TIME OF ARRIVAL UNCERTAINTY**

A measure based on a defined scale in seconds which conveys the performance of the estimated time of arrival at the center of that containment region.

This measure is required because a type of integrity performance measure is needed. It is based on a defined scale (e.g. 95%).

The containment region is bound around ETA where the actual time of arrival will be within the ETA uncertainty in seconds.

The RNP-equivalent for the ETA uncertainty is the Estimated Position Uncertainty.

## **7.6 System Performance Requirements**

### **7.6.1 Accuracy**

A measure of the difference between an aircraft's reported planned interval, i.e. ADS-B report, as compared to its achieved interval. It is given by a number bounded by a confidence value. For example; within the RIMP-R-10 interval management operation the Total Spacing Error cannot be greater than 10.0 seconds 95% of the time.

### **7.6.2 Integrity**

The probability that information provided by a system will not be hazardously misleading. It is generally a number, per operating hour, which expresses likelihood that a system will send the user bad/incorrect information that could cause a potentially dangerous situation without a timely warning. For example; the likelihood that a Total Spacing Error exceeds a maximum of 10.0 seconds containment, without detection, shall be less than  $10^{-5}$  per flight hour.

### **7.6.3 Continuity**

The capability of a total system to perform its intended function without a non-scheduled interruption during the intended operation assuming the system was available when the procedure was initiated. Continuity is expressed per unit of time. For example; the calculations of a single thread transponder mean time to failure of 5,000 hours.

### **7.6.4 Availability**

The probability that a system will perform its required function at the initiation of the intended operation. For example; the FAA target for availability of the Wide Area Augmentation System is 0.999.

## 8 Required Self Separation Performance Model

### 8.1 Introduction

The document, *Required Self Separation Performance, Version 1.1*, examined what would be required in order to ensure a Target Level of Safety (TLS) for a scenario, such as Trajectory-Based Airspace and Operations (TBO), in which properly equipped aircraft have primary responsibility for avoiding other aircraft. This is in contrast to the current system where that responsibility lies with the Air Navigation Service Provider (ANSP). It described the system components, identified key system parameters, and derived a Required Navigation Performance (RNP)-like construct for self-separation operations. This section, and the accompanying MATLAB model, expands upon the Total System Error (TSE) analysis included as Appendix B in that document to provide a means of assessing the impact that various error sources and uncertainties have on an aircraft's ability to accurately predict (and hence control) its minimum separation from a reference aircraft. The model includes computation of the encounter geometry, linearized analysis of the impact of error sources on the predicted separation, and a Monte Carlo based analysis of the impact of error sources on the distribution of separation as a function of encounter geometry in the context of key error terms for Class A and Class B RSSP systems. This analysis is currently confined to separation in the horizontal plane.

### 8.2 Section Overview

Derivation of the basic mathematical model for separation prediction is presented in Section 8.3. Section 8.4 describes the translation of the mathematical model into a MATLAB tool framework. Information on the operation of the MATLAB tool is provided in Section 8.5. **Error! Reference source not found.** provides a table of acronyms and a list of symbols used throughout this section and the model.

### 8.3 TSE Model Derivation

The first step in developing a mathematical construct for characterizing the errors in computing and achieving lateral separation from another vehicle is to be able to calculate the expected separation at closest approach for two targets in unaccelerated (at least in the horizontal plane) flight. With such a solution in hand, it is then possible to assess the linearized sensitivity of the computed separation to various present or future state estimation uncertainties by taking partial derivatives of the solution equation with respect to the various uncertainty terms, such as current/initial position, groundspeed, and ground track angle or to assess the impact of perturbations of input parameters about a nominal condition. The solution can also be used to perform Monte Carlo analysis to predict the distribution of actual separations about a nominal condition based on error distributions for input terms.

#### 8.3.1 Expected Separation Computation

The expected minimum separation can be relatively simply expressed given the assumptions of unaccelerated (i.e. linear with time) motion in a flat plane<sup>18</sup>. The derivation is accomplished by expressing the separation between the two vehicles (ownship, O, and reference aircraft, R) as

---

<sup>18</sup> This is a reasonably good assumption given the relatively small distances of interest here.

functions of time, finding the time for which the derivative of the separation with respect to time is zero (corresponding to the minimum of the function), and then substituting this time back into the distance function.

The coordinates of ownship as a function of time can be expressed as the time-dependent coordinates

$$P_O(t) = (x_{0O} + v_{xO}t, y_{0O} + v_{yO}t) \quad (1)$$

Likewise, the position of the reference aircraft can be expressed as

$$P_R(t) = (x_{0R} + v_{xR}t, y_{0R} + v_{yR}t) \quad (2)$$

The distance  $R$  between the two at any time  $t$  can be expressed as

$$R(t) = \sqrt{(x_R(t) - x_O(t))^2 + (y_R(t) - y_O(t))^2} \quad (3)$$

which can be expanded to

$$R(t) = \sqrt{[(x_{0R} - x_{0O}) + (v_{xR} - v_{xO})t]^2 + [(y_{0R} - y_{0O}) + (v_{yR} - v_{yO})t]^2} \quad (4)$$

Making the following substitutions to express the differences in initial position and speed along each axis

$$x_0 = (x_{0R} - x_{0O}), \quad y_0 = (y_{0R} - y_{0O}) \quad \text{and} \quad (5), (6)$$

$$v_x = (v_{xR} - v_{xO}), \quad v_y = (v_{yR} - v_{yO}) \quad (7), (8)$$

the range equation simplifies to

$$R(t) = \sqrt{(x_0 + v_x t)^2 + (y_0 + v_y t)^2} \quad (9)$$

which can be expanded and regrouped (using  $R_0^2 = x_0^2 + y_0^2$  to express the range at time 0)

$$R(t) = \sqrt{R_0^2 + 2(x_0 v_x + y_0 v_y) \cdot t + (v_x^2 + v_y^2) \cdot t^2} \quad (10)$$

The point of closest approach occurs when the derivative of range with respect to time is zero, which is equivalent to when the derivative of range squared with respect to time is zero

$$0 = \frac{\partial R^2(t)}{\partial t} = 2(x_0 v_x + y_0 v_y) + 2(v_x^2 + v_y^2) \cdot t \quad (11)$$

So, the time of closest approach,  $t_{CPA}$ , is given by

$$t_{CPA} = -\frac{(x_0 v_x + y_0 v_y)}{(v_x^2 + v_y^2)} \quad (12)$$

Note that a negative  $t_{CPA}$  indicates that the two aircraft are already beyond their point of closest approach and that  $t_{CPA}$  is defined in all cases except when the aircraft are traveling at the same speed along parallel tracks.

The range at closest approach can be found by substituting the expression for  $t_{CPA}$  back into the range equation and simplifying

$$R_{CPA} = \sqrt{R_0^2 - \frac{(x_0 v_x + y_0 v_y)^2}{(v_x^2 + v_y^2)}} \quad (13)$$

### 8.3.2 Analysis of Sensitivity of Expected Minimum Separation to State Variable Variations

The first analysis performed by the model computes the sensitivity of the  $R_{CPA}$  prediction to errors in position and velocity inputs. The sensitivity of  $R_{CPA}$  to variations in the initial position or velocity of either aircraft can be found by taking the partial derivative of  $R_{CPA}$  with respect to the parameter of interest. As a first step,  $U$  will be defined as

$$U = R_0^2 - \frac{(x_0 v_x + y_0 v_y)^2}{(v_x^2 + v_y^2)} \text{ so } R_{CPA} = \sqrt{U} \quad (14), (15)$$

By the chain rule, the derivative of  $R_{CPA}$  with respect to any parameter  $\alpha$  is

$$\frac{\partial R_{CPA}}{\partial \alpha} = \frac{1}{2\sqrt{U}} \frac{\partial U}{\partial \alpha} \quad (16)$$

Noting that  $\sqrt{U} = R_{CPA}$ , this can also be written

$$\frac{\partial R_{CPA}}{\partial \alpha} = \frac{1}{2R_{CPA}} \frac{\partial U}{\partial \alpha} \quad (17)$$

Further, substituting

$$V = \frac{(x_0 v_x + y_0 v_y)^2}{(v_x^2 + v_y^2)} \quad (18)$$

the partial derivative becomes

$$\frac{\partial R_{CPA}}{\partial \alpha} = \frac{1}{2R_{CPA}} \left[ \frac{\partial R_0^2}{\partial \alpha} - \frac{\partial V}{\partial \alpha} \right] \quad (19)$$

Expanding V by letting  $V = \frac{A}{B}$  where  $A = (x_0 v_x + y_0 v_y)^2$  and  $B = (v_x^2 + v_y^2)$  and using the

quotient rule,  $\frac{\partial V}{\partial \alpha} = \frac{B \frac{\partial A}{\partial \alpha} - A \frac{\partial B}{\partial \alpha}}{B^2}$ , the general form of the partial derivative is

$$\frac{\partial R_{CPA}}{\partial \alpha} = \frac{1}{2R_{CPA}} \left[ \frac{\partial R_0^2}{\partial \alpha} - \frac{B \frac{\partial A}{\partial \alpha} - A \frac{\partial B}{\partial \alpha}}{B^2} \right] \text{ or} \quad (20)$$

$$\frac{\partial R_{CPA}}{\partial \alpha} = \frac{1}{2R_{CPA}} \left[ \frac{\partial R_0^2}{\partial \alpha} - \frac{1}{B} \frac{\partial A}{\partial \alpha} + \frac{A}{B^2} \frac{\partial B}{\partial \alpha} \right] \quad (21)$$

### 8.3.2.1 Position Uncertainty

For this first case, consider the sensitivity of  $R_{CPA}$  to variation in the x coordinate of ownship or reference aircraft. Using the above expressions and noting that  $\frac{\partial R_0^2}{\partial x_{0R}} = 2x_0$ ,  $\frac{\partial x_0}{\partial x_{0R}} = 1$ , and

$\frac{\partial v_x}{\partial x_{0R}} = 0$  it can be shown that

$$\frac{\partial R_{CPA}}{\partial x_{0R}} = \frac{1}{R_{CPA}} \left( x_0 - \frac{(x_0 v_x^2 + y_0 v_x v_y)}{(v_x^2 + v_y^2)} \right) \text{ and} \quad (22)$$

$$\frac{\partial R_{CPA}}{\partial x_{0O}} = \frac{-1}{R_{CPA}} \left( x_0 - \frac{(x_0 v_x^2 + y_0 v_x v_y)}{(v_x^2 + v_y^2)} \right) \quad (23)$$

Likewise,

$$\frac{\partial R_{CPA}}{\partial y_{0R}} = \frac{1}{R_{CPA}} \left( y_0 - \frac{(y_0 v_y^2 + x_0 v_x v_y)}{(v_x^2 + v_y^2)} \right) \text{ and} \quad (24)$$

$$\frac{\partial R_{CPA}}{\partial y_{0O}} = \frac{-1}{R_{CPA}} \left( y_0 - \frac{(y_0 v_y^2 + x_0 v_x v_y)}{(v_x^2 + v_y^2)} \right) \quad (25)$$

### 8.3.2.2 Velocity Uncertainty

Since  $R_0$  is not a function of any velocity term, its derivative with respect to velocity is zero. Therefore, the impact of velocity uncertainty reduces to just the second term

$$\frac{\partial R_{CPA}}{\partial v} = \frac{-1}{2R_{CPA}} \left[ \frac{\partial V}{\partial v} \right] \quad (26)$$

Or, using the same expansion of the inner derivative as before,

$$\frac{\partial R_{CPA}}{\partial v} = \frac{1}{2R_{CPA}} \left[ \frac{A}{B^2} \frac{\partial B}{\partial v} - \frac{1}{B} \frac{\partial A}{\partial v} \right] \quad (27)$$

Using the partial derivatives

$$\frac{\partial A}{\partial v_x} = 2(x_0^2 v_x + x_0 y_0 v_y), \quad \frac{\partial A}{\partial v_y} = 2(y_0^2 v_y + x_0 y_0 v_x) \quad (28), (29)$$

$$\frac{\partial B}{\partial v_x} = 2v_x, \text{ and } \frac{\partial B}{\partial v_y} = 2v_y \quad (30), (31)$$



yields

$$\frac{\partial R_{CPA}}{\partial v_x} = \frac{1}{R_{CPA}} \left[ \frac{(x_0 v_x + y_0 v_y)^2}{(v_x^2 + v_y^2)^2} v_x - \frac{(x_0^2 v_x + x_0 y_0 v_y)}{(v_x^2 + v_y^2)} \right] \text{ and} \quad (32)$$

$$\frac{\partial R_{CPA}}{\partial v_y} = \frac{1}{R_{CPA}} \left[ \frac{(x_0 v_x + y_0 v_y)^2}{(v_x^2 + v_y^2)^2} v_y - \frac{(y_0^2 v_y + x_0 y_0 v_x)}{(v_x^2 + v_y^2)} \right] \quad (33)$$

Sensitivity to the individual aircraft velocities can then be found by observing

$$\frac{\partial v_x}{\partial v_{xR}} = 1, \quad \frac{\partial v_x}{\partial v_{xO}} = -1, \quad \frac{\partial v_y}{\partial v_{yR}} = 1, \quad \text{and} \quad \frac{\partial v_y}{\partial v_{yO}} = -1 \quad (34), (35), (36), (37)$$

so that

$$\frac{\partial R_{CPA}}{\partial v_{xR}} = \frac{\partial R_{CPA}}{\partial v_x}, \quad \frac{\partial R_{CPA}}{\partial v_{xO}} = -\frac{\partial R_{CPA}}{\partial v_x}, \quad (38), (39)$$

$$\frac{\partial R_{CPA}}{\partial v_{yR}} = \frac{\partial R_{CPA}}{\partial v_y}, \quad \text{and} \quad \frac{\partial R_{CPA}}{\partial v_{yO}} = -\frac{\partial R_{CPA}}{\partial v_y}. \quad (40), (41)$$

### 8.3.2.3 Uncertainty with respect to Groundspeed and Ground Track Angle

If the velocity components are expressed in terms of groundspeed,  $S$ , and ground track angle,  $\psi$  (measured clockwise from North), so that the speed components may be written

$$v_x = S \sin \psi \quad \text{and} \quad v_y = S \cos \psi \quad (42), (43)$$

The sensitivity to these measures of velocity can also be determined from

$$\frac{\partial R_{CPA}}{\partial S_{R,O}} = \frac{\partial R_{CPA}}{\partial v_x} \frac{\partial v_x}{\partial S_{R,O}} + \frac{\partial R_{CPA}}{\partial v_y} \frac{\partial v_y}{\partial S_{R,O}} \quad \text{and} \quad (44)$$

$$\frac{\partial R_{CPA}}{\partial \psi_{R,O}} = \frac{\partial R_{CPA}}{\partial v_x} \frac{\partial v_x}{\partial \psi_{R,O}} + \frac{\partial R_{CPA}}{\partial v_y} \frac{\partial v_y}{\partial \psi_{R,O}} \quad (45)$$

Using the partial derivatives yields

$$\frac{\partial v_x}{\partial S_R} = \sin \psi_R, \quad \frac{\partial v_y}{\partial S_R} = \cos \psi_R, \quad (46), (47)$$

$$\frac{\partial v_x}{\partial S_O} = -\sin \psi_O, \quad \frac{\partial v_y}{\partial S_O} = -\cos \psi_O, \quad (48), (49)$$

$$\frac{\partial v_x}{\partial \psi_R} = S_R \cos \psi_R, \quad \frac{\partial v_y}{\partial \psi_R} = -S_R \sin \psi_R, \quad (50), (51)$$

$$\frac{\partial v_x}{\partial \psi_O} = -S_O \cos \psi_O, \quad \text{and} \quad \frac{\partial v_y}{\partial \psi_O} = S_O \sin \psi_O \quad (52), (53)$$

### 8.3.3 Analysis of Error Distribution of Minimum Separation

The second analysis performed by the model generates a probabilistic distribution of achieved  $R_{CPA}$  values as a function of geometry and the error distributions associated with the input geometry parameters. This analysis will capture the full non-linear contribution of the various error sources to errors in the prediction of the separation distance at closest approach.

The approach for this analysis is to start with a nominal geometry as input as well as specifications for the distribution functions of each measurement variable. For Class A systems<sup>19</sup>, the distribution functions are for the lateral uncertainty (traditional RNP) and longitudinal deviation (along-track position uncertainty) for each aircraft appropriate for the intent trajectory segments containing the nominal Closest Point of Approach (CPA). This assumes that the prediction is for a time far enough in the future that the error terms associated with the intent information dominate the errors associated with current position and velocity measurement. For Class B systems<sup>20</sup>, the distribution functions are for position uncertainty and velocity uncertainty (both uncertainties assumed to be uniformly distributed in azimuth). Once the nominal conditions and measurement variable distributions have been defined, a Monte Carlo analysis approach is used to determine the distribution of  $R_{CPA}$  for comparison with the nominal value. For cases where the errors are significant relative to the nominal  $R_{CPA}$ , it is expected that crossing order given a particular set of perturbed parameters may be the opposite of the nominal case crossing order. When this occurs, the computed  $R_{CPA}$  for that case should be considered a negative quantity.

<sup>19</sup> Class A systems transmit and receive intent information as part of their ADS-B message set.

<sup>20</sup> Class B systems need only transmit and receive position and velocity information as part of their ADS-B message set.

### 8.3.4 Extension to Other Uncertainty/Error Terms

To the extent that other uncertainties and errors can be modeled as the above uncertainties in the initial conditions, their impact can also be understood by extension of the above analyses.

For example, the impact of modeling and execution errors in making a speed or track adjustment can be understood if the errors and uncertainties can be translated to errors and uncertainties in the vehicle position and velocity at the end of the maneuver. The end of maneuver state can then be used to compute the new expected minimum separation and the associated sensitivity to the (perhaps larger) initial condition uncertainties.

## 8.4 MATLAB Linearized Sensitivity Model Description

### 8.4.1 Scenario Inputs

The fundamental inputs to the mathematical model are:

1. Groundspeed of ownship ( $S_O$ )
2. Groundspeed of reference ( $S_R$ )
3. Crossing angle (difference in ground track angle) ( $\psi$ )<sup>21</sup>
4. Order of crossing (ownship crosses in front of reference or behind)
5. Time to CPA ( $t_{CPA}$ )
6. Separation at CPA ( $R_{CPA}$ )

All parameters are for the nominal condition before the introduction of uncertainties.

Assuming a coordinate frame aligned such that ownship is nominally traveling in the direction of the positive x-axis, the relative speeds of the two aircraft along each axis are given by:

$$v_x = S_R \cos(\psi) - S_O \quad (54)$$

$$v_y = S_R \sin(\psi) \quad (55)$$

Given the scenario input parameters and using (54) and (55) to compute  $v_x$  and  $v_y$ , the initial position of reference with respect to ownship,  $(x_0, y_0)$ , can be found by solving the two simultaneous equations using equations (12) and (13), which, by expanding  $R_0^2 = x_0^2 + y_0^2$ , can be rewritten explicitly in terms of these variables and the input parameters as shown below:

$$R_{CPA} = \sqrt{(x_0^2 + y_0^2) - \frac{(x_0 v_x + y_0 v_y)^2}{(v_x^2 + v_y^2)}} \quad (56)$$

---

<sup>21</sup>  $\psi$  is positive if reference is crossing from ownship's right to left (mathematically,  $\psi$  is measured from ownship's speed vector (x-axis) towards reference's speed vector counter-clockwise positive).

The solution is given by the following equations:

$$x_0 = \frac{-t_{CPA}(v_x^2 + v_y^2)}{v_x} + \frac{\left[ t_{CPA}(v_x^2 v_y + v_y^3) \pm R_{CPA} |v_x| \sqrt{v_x^2 + v_y^2} \right] v_y}{(v_x^2 + v_y^2) v_x} \text{ and} \quad (57)$$

$$y_0 = \frac{-t_{CPA}(v_x^2 v_y + v_y^3) \pm R_{CPA} |v_x| \sqrt{v_x^2 + v_y^2}}{(v_x^2 + v_y^2)} \quad (58)$$

The ambiguity in whether to take the positive or negative square root is determined from the specified crossing order. The two solutions for  $(x_0, y_0)$ , one corresponding to using positive square roots, the other corresponding to using negative square roots, represent the two crossing orders. The solution with the smaller value of  $x_0$  represents the case where ownship crosses behind reference. The solution with the larger value of  $x_0$  represents the case where ownship passes in front of reference.

The above solution for  $x_0$  also contains a singularity for scenarios that result in a  $v_x$  of 0 (DIV/0). In that case, the solution for  $x_0$  equals  $\pm R_{CPA}$  with the sign, again, depending on the crossing order.

## 8.4.2 Sensitivity Analysis Modeling

The linearized implementation of the model uses partial derivatives to provide an initial look at the sensitivity of separation distance prediction to errors in some of the input parameters for a nominal initial geometry.

Partial differential equations derived in Section 8.3.2 reflect the fundamental sensitivities of the minimum separation to state estimation uncertainties<sup>22</sup>, but it is not certain that the non-linearities can be neglected in the general case, and they likely cannot be neglected in the case where the uncertainty is not a small fraction of the nominal separation at CPA<sup>23</sup>.

For the linear case, the relation between input parameter uncertainty and  $R_{CPA}$  uncertainty is a simple scaling factor. The model can generate a plot of the scaling factor as a function of one input (2-D plot) or two inputs (3-D plot) with the remaining inputs held at a specified value.

For positional errors (either ownship or intent-based reference), positional uncertainty may be asymmetrically expressed in the along-track and cross-track dimensions. Using the coordinate system introduced above, ownship along-track uncertainty corresponds to uncertainty along the x-axis, and cross-track uncertainty coincides with the y-axis. For reference, along-track and cross-track uncertainties are mapped to the x- and y-axes using the crossing angle.

<sup>22</sup> It would be equally valid to use small perturbations to approximate the derivatives rather than using the partial derivative formulae.

<sup>23</sup> Or, in the case of velocity or time uncertainty, does not translate to a position uncertainty at the time of CPA that is a significant proportion of the nominal separation.

Time of arrival uncertainty (ownship or reference) may be mapped to along-track position uncertainty using the appropriate nominal groundspeed.

### 8.4.3 Distribution Analysis Modeling

The distribution analysis is performed using a Monte Carlo approach and then examining the set of outcomes. Unlike the sensitivity analysis, this analysis does account for the non-linearities inherent in determining the distance at closest approach.

The fundamental inputs to establish the nominal condition before the introduction of uncertainties for this analysis are those described in Section 8.4.1.

Once the nominal conditions have been determined, perturbations are applied to the positions (Class A systems) or the positions and velocities (Class B systems) according to the input uncertainties. Equation (56) for  $R_{CPA}$  is then re-solved using the perturbed values to determine  $R_{CPA}$  for the perturbed condition, with care taken to use a negative result if the perturbation results in a reversal of the crossing order. Sufficient numbers of perturbed condition samples are examined to enable generation of a resulting distribution plot for the variation in  $R_{CPA}$ .

The distribution function inputs will depend on whether a Class A pair of systems or a Class B pair of systems is being evaluated. For Class A systems, it is assumed that the aircraft are both operating according to 4D flight plans and are broadcasting Trajectory Change Points (TCPs) with known lateral and longitudinal accuracy characteristics. The input parameters will therefore be taken to represent the standard deviation for lateral and longitudinal uncertainties (a Gaussian distribution is assumed). These uncertainties are meant to reflect a time approximately  $t_{CPA}$  in the future. For Class B systems, it is assumed that the aircraft only rely on current position and velocity measurements, and that the accuracy characteristics of these measurements are Gaussian and non-directional (errors are uniformly distributed in azimuth).

The following equations are used to apply the errors to the initial positions of both ownship and the reference aircraft for a Class A system:

$$x_{0O_{Perturbed}} = x_{0O} + NormDist(\sigma_{ATO}) \quad (59)$$

$$y_{0O_{Perturbed}} = y_{0O} + NormDist(\sigma_{CTO}) \quad (60)$$

$$x_{0R_{Perturbed}} = x_{0R} + \cos(\Psi) NormDist(\sigma_{ATR}) - \sin(\Psi) NormDist(\sigma_{CTR}) \quad (61)$$

$$y_{0R_{Perturbed}} = y_{0R} + \sin(\Psi) NormDist(\sigma_{ATR}) + \cos(\Psi) NormDist(\sigma_{CTR}) \quad (62)$$

Where:

$Norm Dist(\sigma)$  is a Gaussian distribution with standard deviation  $\sigma$ .

In the case of a Class B system, the errors are applied to the initial positions and speeds of both ownship and the reference aircraft<sup>24</sup>:

$$x_{0O/R_{Perturbed}} = x_{0O/R} + NormDist(\sigma_{pO/R}) \cos(UniformDist(0 \dots 2\pi)) \quad (63)$$

$$y_{0O/R_{Perturbed}} = y_{0O/R} + NormDist(\sigma_{pO/R}) \sin(UniformDist(0 \dots 2\pi)) \quad (64)$$

$$v_{xO_{Perturbed}} = S_O + NormDist(\sigma_{vO}) \cos(UniformDist(0 \dots 2\pi)) \quad (65)$$

$$v_{yO_{Perturbed}} = NormDist(\sigma_{vO}) \sin(UniformDist(0 \dots 2\pi)) \quad (66)$$

$$v_{xR_{Perturbed}} = S_R \cos(\Psi) + NormDist(\sigma_{vR}) \cos(UniformDist(0 \dots 2\pi)) \quad (67)$$

$$v_{yR_{Perturbed}} = S_R \sin(\Psi) + NormDist(\sigma_{vR}) \sin(UniformDist(0 \dots 2\pi)) \quad (68)$$

For single distribution and SPS analyses, the probability mass function ( $f_X(R_{CPA})$ ) will be determined. In addition, the resulting mean ( $\mu$ ) and standard deviation ( $\sigma$ ) of the samples are calculated as follows:

$$\mu_{Samples} = \frac{1}{N_S} \sum_{i=1}^{N_B} Samples(i) R_{CPA}(i) \quad (69)$$

$$\sigma_{Samples} = \sqrt{\frac{1}{N_S} \sum_{i=1}^{N_B} Samples(i) (R_{CPA}(i) - \mu_{Samples})^2} \quad (70)$$

Where:

- $N_B$             Number of Bins
- $N_S$             Total Number of Samples
- $R_{CPA}(i)$      $R_{CPA}$  of Bin  $i$
- $Samples(i)$  Number of Samples in Bin  $i$

The calculated mean and standard deviation are used to calculate a normal distribution that is plotted over the probability mass function for comparison purposes in single distribution analyses.

Additionally, the probability distribution function is “integrated” to find the value of  $R_{CPA}$  that contains 5% of the samples ( $R_{CPA}(5\%)$ ).  $R_{CPA}(5\%)$  is the separation distance for which there is a

---

<sup>24</sup> Note that the same sample from  $UniformDist(0 \dots 2\pi)$  is used for each pair of equations (63)-(64), (65)-(66), and (67)-(68).

probability of 5% that the  $R_{CPA}$  could be less than  $R_{CPA}(5\%)$  given the specified geometry and errors, and conversely, there is a 95% probability that  $R_{CPA}$  will be greater than  $R_{CPA}(5\%)$ .

## 8.5 MATLAB Model Operation

### 8.5.1 Overview

The RSSPSimulator allows for the simulation and visualization of certain aspects of the mathematical model derived in the previous Section.

### 8.5.2 System Requirements

The RSSPSimulator has been developed and tested with the following versions of MATLAB (Help > About MATLAB):

- R2008a (Version 7.6)
- R2009a (Version 7.8)

### 8.5.3 Installation & Start

The `RSSPSimulator.fig` and `RSSPSimulator.m` files need to be copied into a directory to which the current directory of MATLAB has to be set. The RSSPSimulator can be started by typing `RSSPSimulator` in the MATLAB Command Window (i.e. `>> RSSPSimulator ↵`).

MATLAB will then display the control panel shown in Figure 12 below.

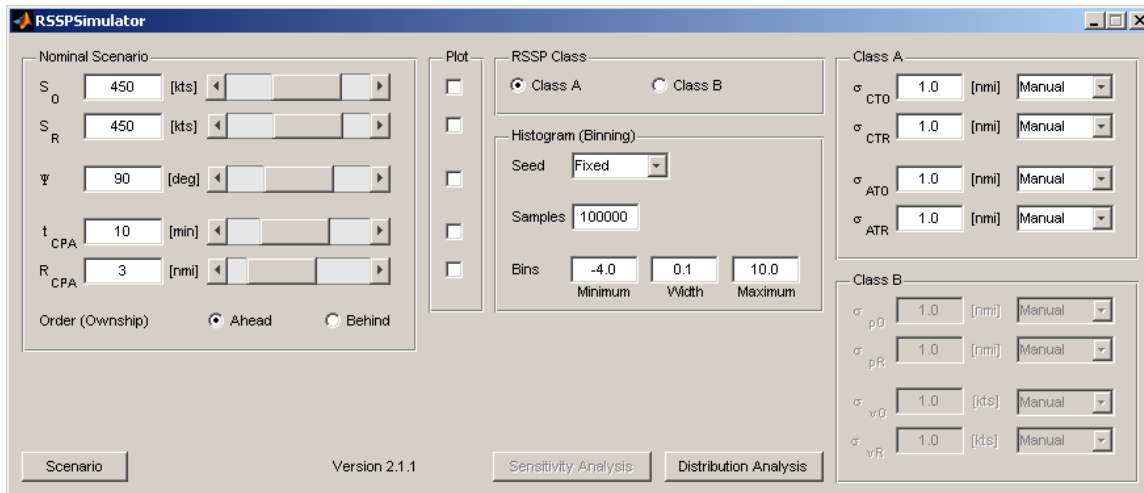
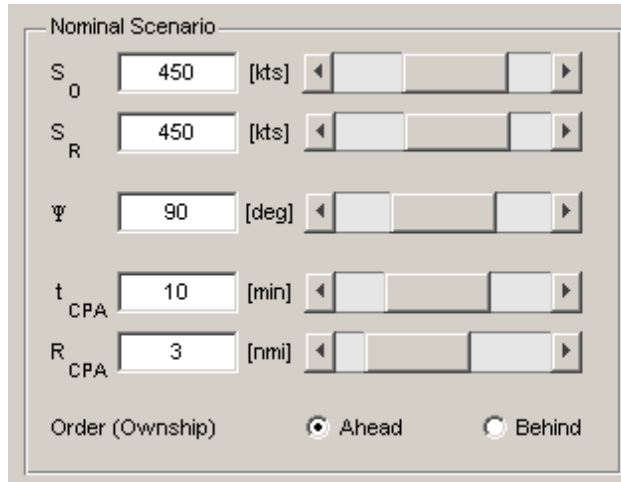

Figure 12 – RSSPSimulator Control Panel

### 8.5.4 Scenario Definition

The scenario parameters are defined using the left side of the control panel as shown in Figure 13. The initial values for the modifiable variables are set to a typical scenario.



**Figure 13 – Mode Control Panel Configuration for Scenario Inputs**

The Order determines whether ownship passes Ahead or Behind of the reference aircraft.

The following ranges for of these variables were chosen to allow the analysis of reasonable scenarios:

<b>Symbol</b>	<b>Parameter</b>	<b>Minimum</b>	<b>Maximum</b>	<b>Units</b>
$S_O/S_R$	Groundspeed of ownship/reference aircraft	200	600	knots
$\psi$	Crossing angle	10	170	degrees
$t_{CPA}$	Time to CPA	2	20	minutes
$R_{CPA}$	Separation at CPA	0.5	10	nmi

Pressing the “Scenario” button will open a MATLAB figure titled “Figure 1: Scenario” that shows the geometry of the scenario for the specified values as shown below.



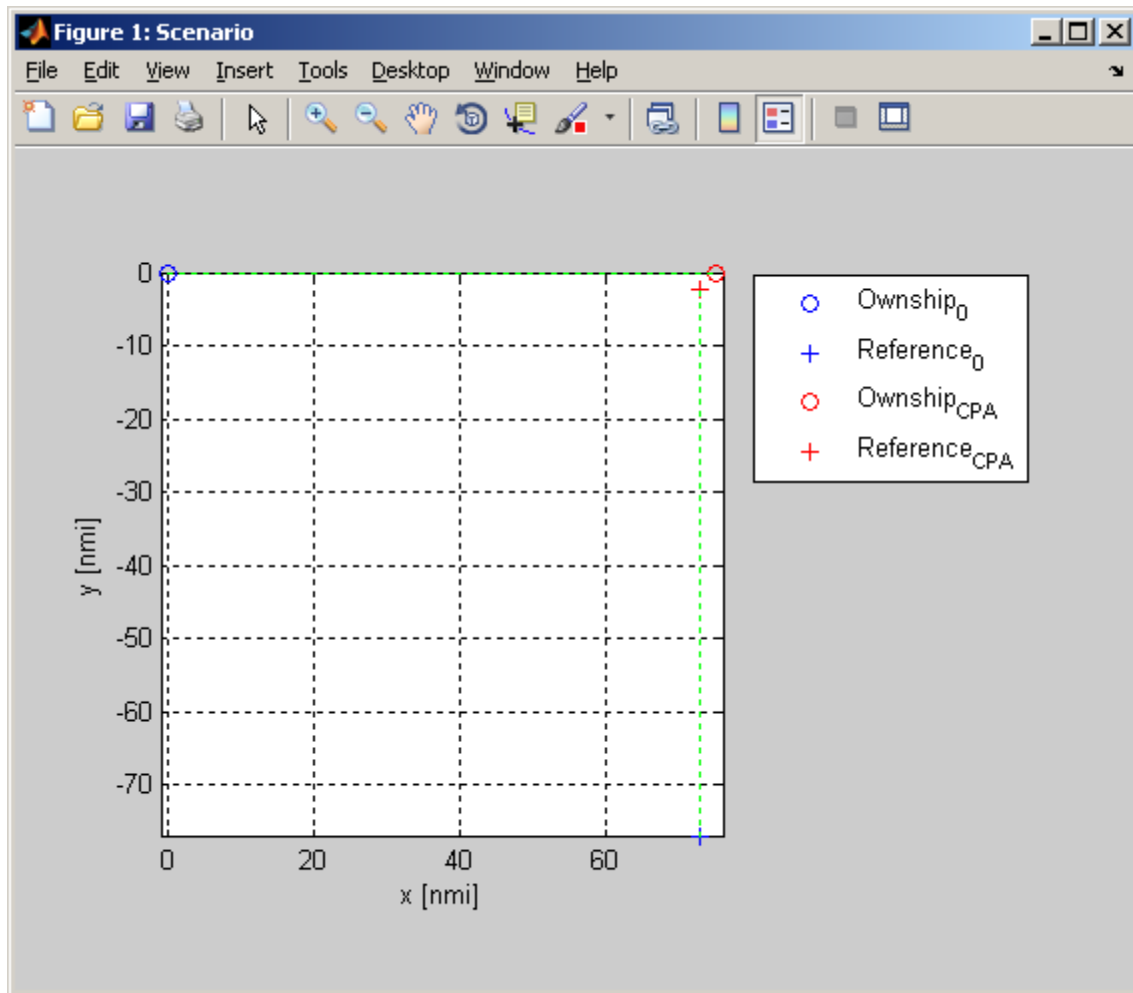

Figure 14 – Scenario Display Example

The “Scenario” button is available as long as none of the “Plot” checkboxes are selected.

### 8.5.5 Sensitivity Analysis

The Sensitivity Analysis implements the analyses described in Section 8.4.2.

#### 8.5.5.1 Single-Parameter Sweep Mode

The Single-Parameter Sweep (SPS) mode of the sensitivity analysis allows for a set of computations where a single selected variable is varied (“swept”) through a pre-defined range<sup>25</sup>. The other variables are kept constant and the results of the sensitivity analysis of the separation at the closest point of approach ( $R_{CPA}$ ) with respect to position and speed uncertainties are visualized.

Figure 15 shows how the crossing angle ( $\psi$ ) was chosen for the analysis by selecting its “Plot” checkbox. Pressing the “Sensitivity Analysis” button will open two MATLAB figures that visualize the sensitivity of  $R_{CPA}$  to position and speed errors. Examples of these can be seen in

<sup>25</sup> The ranges are specified by the entry range of each variable.

Figure 16 and Figure 17 respectively. The positions and speeds are shown in along-track and cross-track components with regard to the respective aircraft (e.g. ownship or reference). The SPS sensitivity analysis may be performed whenever a single “Plot” checkbox is selected.

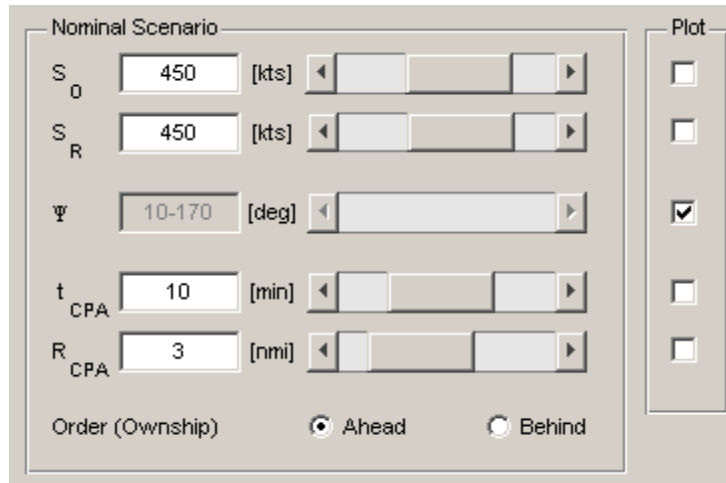

Figure 15 – SPS Control Panel Configuration to Vary Crossing Angle ( $\psi$ ).

The following two equations are used to transform the x/y components of the reference aircraft position and speed to along- and cross-track components:

$$\text{Along-Track}_R = \cos(\psi) x + \sin(\psi) y \quad (71)$$

$$\text{Cross-Track}_R = -\sin(\psi) x + \cos(\psi) y \quad (72)$$

The step-sizes for the sweep were determined for best computational performance and visualization:

$S_O/S_R$	20	[kts]
$\psi$	5	[deg]
$t_{CPA}$	1	[min]
$R_{CPA}$	0.5	[nmi]

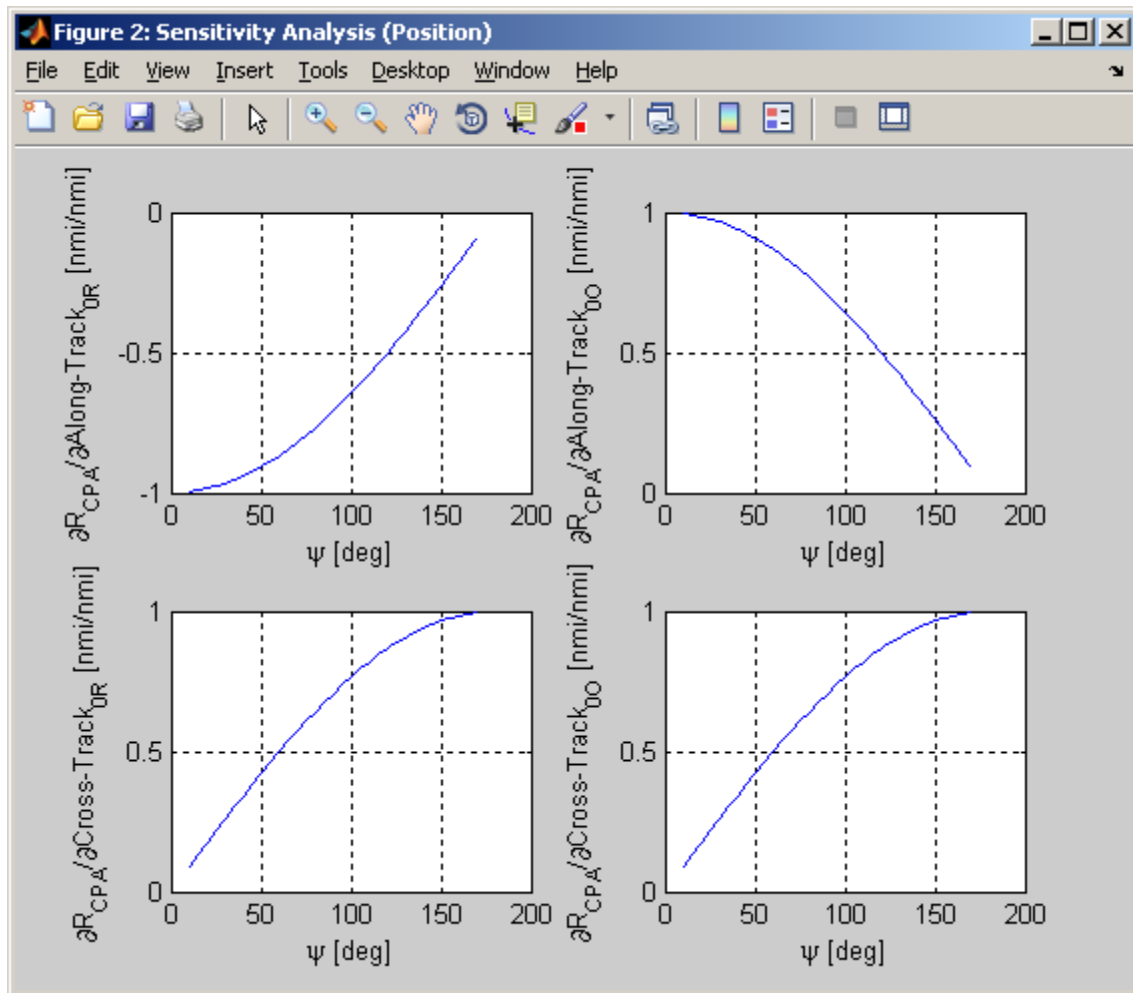

Figure 16 – SPS Sensitivity to Position Error as a Function of Crossing Angle ( $\psi$ ).

The interpretation of this figure is that the prediction of  $R_{CPA}$  is most sensitive to along-track position errors when the crossing angle is small (tail-chase) and is most sensitive to cross-track position errors when the crossing angle is large (near head-on). Because of the linearized nature of this analysis, the magnitude of the sensitivity to position errors will never exceed unity.

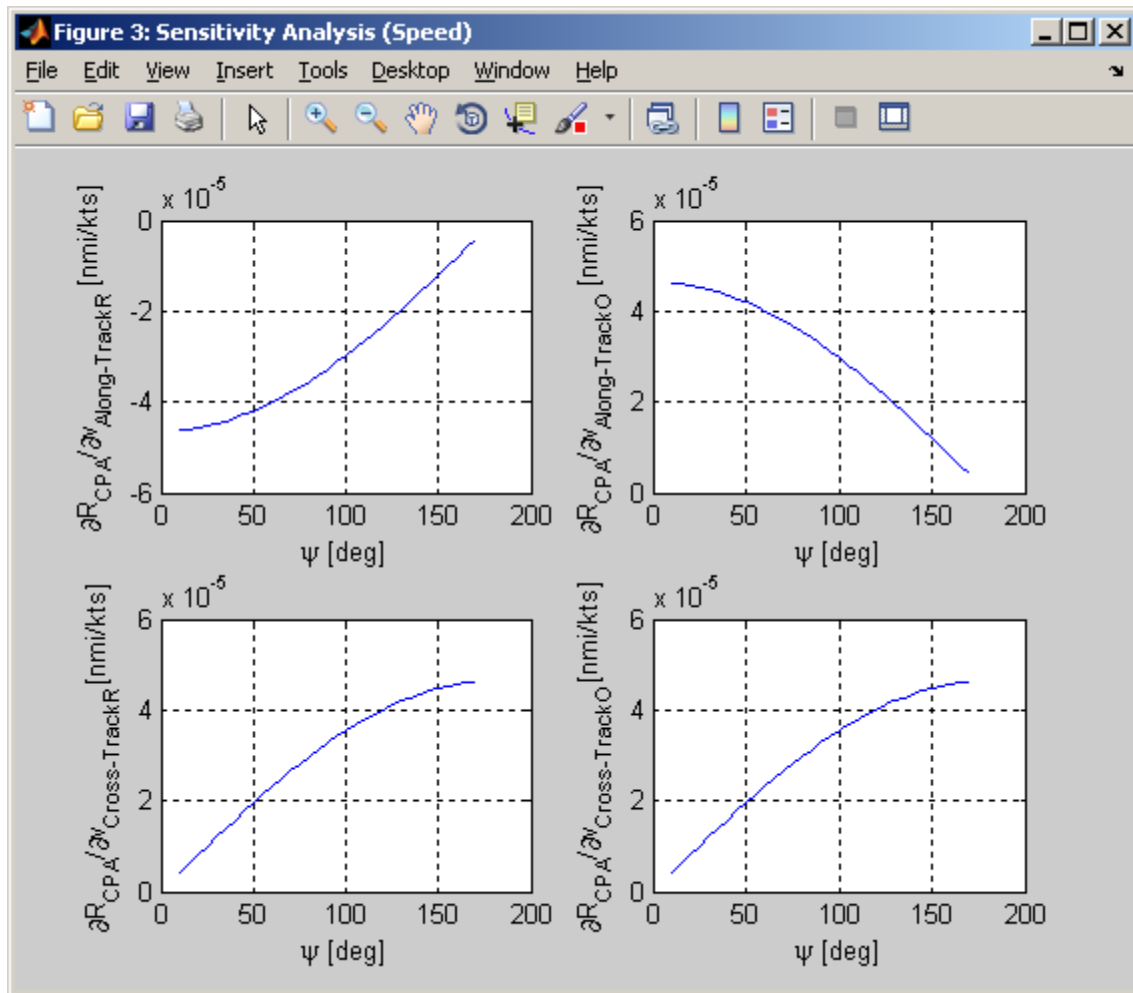

Figure 17 – SPS Sensitivity to Velocity Error as a Function of Crossing Angle ( $\psi$ ).

The interpretation of this figure is that the prediction of  $R_{CPA}$  is most sensitive to along-track velocity errors when the crossing angle is small (tail-chase) and is most sensitive to cross-track velocity errors when the crossing angle is large (near head-on).

### 8.5.5.2 Two-Parameter Sweep Mode

The Two-Parameter Sweep (TPS) mode of sensitivity analysis allows for a set of computations where two selected variable are varied (“swept”) through a pre-defined range. The other variables are kept constant and the results of the sensitivity analysis of the separation at the closest point of approach ( $R_{CPA}$ ) with regard to position and speed uncertainties are visualized in 3D MATLAB figures.

This is similar to the SPS mode with the only difference that two of the “Plot” checkboxes have to be checked as demonstrated in Figure 18. Pressing the “Sensitivity Analysis” button will then open two MATLAB figures that visualize the sensitivity of  $R_{CPA}$  to position and speed errors. Examples of these can be seen in Figure 19 and Figure 20 respectively.

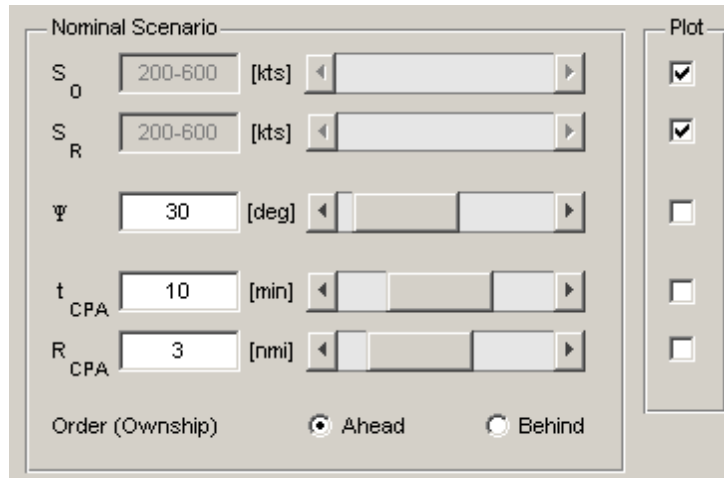

Figure 18 – TPS Control Panel Configuration Varying  $S_O$  and  $S_R$ .

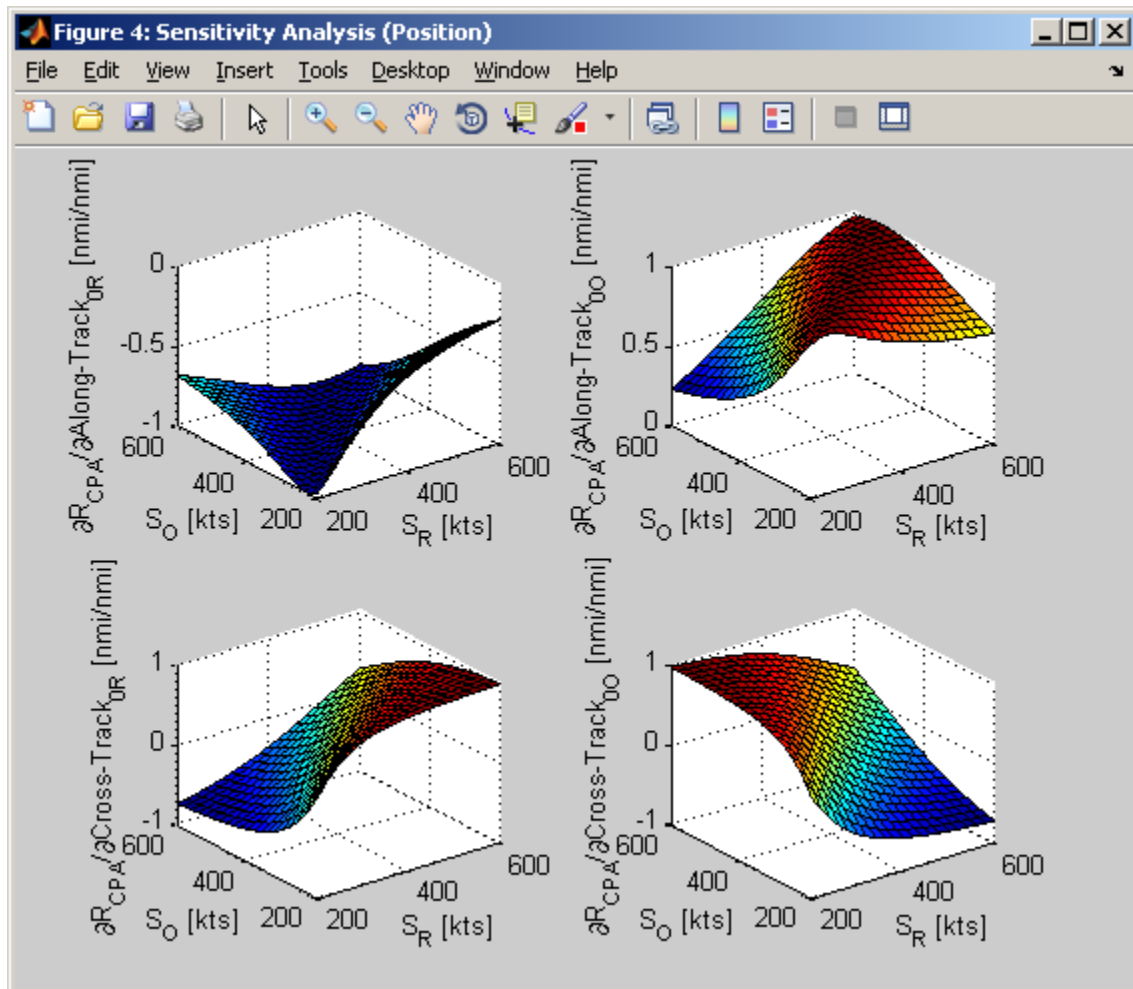

Figure 19 – TPS Sensitivity to Position Error as a Function of  $S_O$  and  $S_R$ .

The interpretation of this figure is that, for this nominal geometry, the prediction of  $R_{CPA}$  is most sensitive to along-track position errors when the two groundspeeds are equal and is most sensitive to cross-track position errors when the two groundspeeds are quite different. Again,

because of the linearized nature of this analysis, the magnitude of the sensitivity to position errors will never exceed unity.

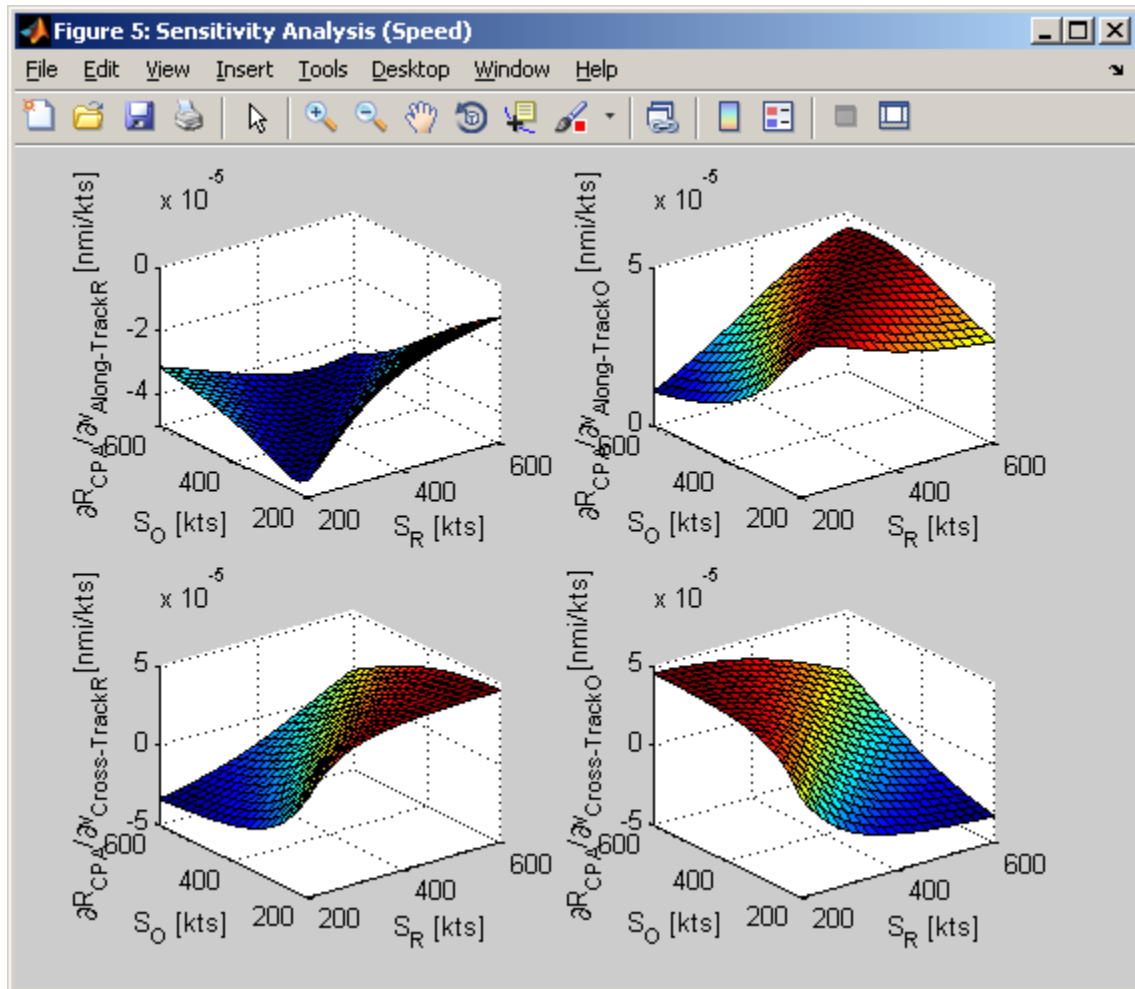

Figure 20 – TPS Sensitivity to Velocity Error as a Function of  $S_O$  and  $S_R$ .

The interpretation of this figure is that, for this nominal geometry, the prediction of  $R_{CPA}$  is most sensitive to along-track velocity errors when the two groundspeeds are equal and is most sensitive to cross-track velocity errors when the two groundspeeds are quite different.

## 8.5.6 Distribution Analysis

The Distribution Analysis implements the analyses described in Section 8.4.3. These analyses require more input parameters than the Sensitivity Analysis as discussed in the following.

### 8.5.6.1 Additional Configuration Inputs

The additional configuration inputs applicable to both Class A and Class B system distribution analyses are contained in the middle portion of the RSSPSimulator control panel as depicted in Figure 21.

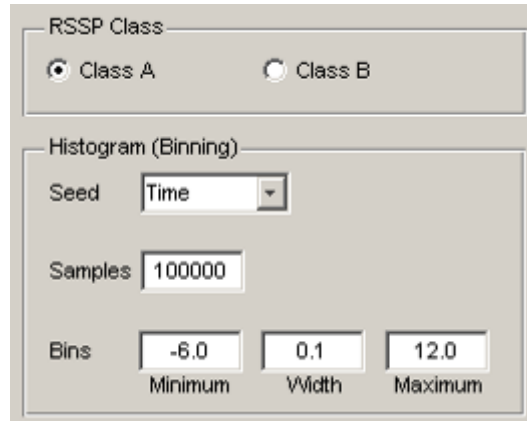

**Figure 21 – Distribution Analysis Controls.**

Here, the user can specify whether the analysis is to be performed for a Class A or Class B system and control the parameters used to generate the sample distributions and the histograms used to plot the results.

The random number generator can be set to use either a fixed value (“Fixed”) or a seed randomized using the system clock (“Time”).

There is no hard-coded upper limit to the value of Samples but performance will slow down significantly with large values. This is in particular the case when performing swept-parameter analyses.

The “Bins” parameters control the width and granularity of the generated  $R_{CPA}$  histograms. If the Minimum or Maximum limits are exceeded by some samples, a dialog, such as shown in Figure 22, will appear in addition to the histogram plot. Examination of the histogram will typically reveal which limit needs to be relaxed.

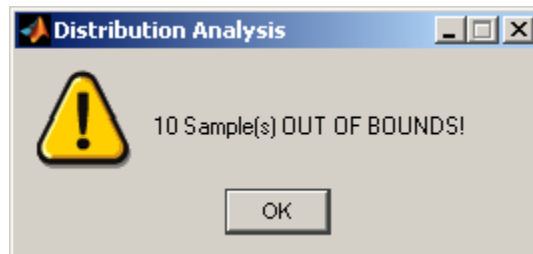

**Figure 22 – Histogram Limit Warning Dialog.**

### 8.5.6.2 Class A Systems

Having selected the “Class A” radio button in the upper center of the control panel, the user can set the corresponding error distribution inputs in the upper right portion of the panel as shown in Figure 23 below.

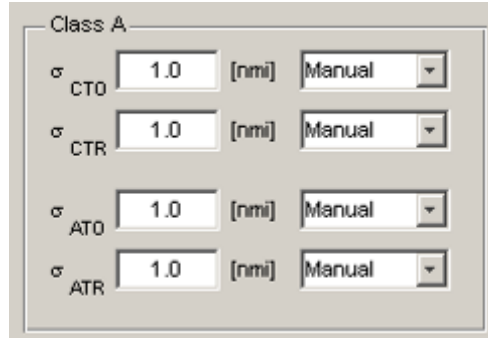

Figure 23 – Class A Error Distribution Inputs.

This set of inputs permits entry of standard deviations for the along-track and cross-track error distributions of ownship and the reference aircraft. The drop-down menus to the right of each entry permit selection of the standard deviation by manual entry (“Manual”), RNP equivalent (“RNP-\*”), or no error (“Disable”). For consistency with the definitions used in the RNP standards, the RNP-\* selections will represent a 95% ( $= 2\sigma$ ) confidence boundary for an assumed Gaussian distribution ( $Norm\ Dist(\sigma)$ ) and the RNP values will be converted into the standard deviation using the following equation:

$$\sigma = \frac{RNP}{\sqrt{2} \operatorname{erf}^{-1}(95\%)} \quad (73)$$

Where:  $\operatorname{erf}^{-1}$  is the Inverse Error Function.

### 8.5.6.3 Single Distribution

With none of the “Plot” checkboxes selected, pressing the “Distribution Analysis” button will generate a single distribution plot. While MATLAB is busy processing, a “Running...” progress bar will appear to the left of the version number label. For the example control panel shown in Figure 24, the resultant distribution is depicted in Figure 25.

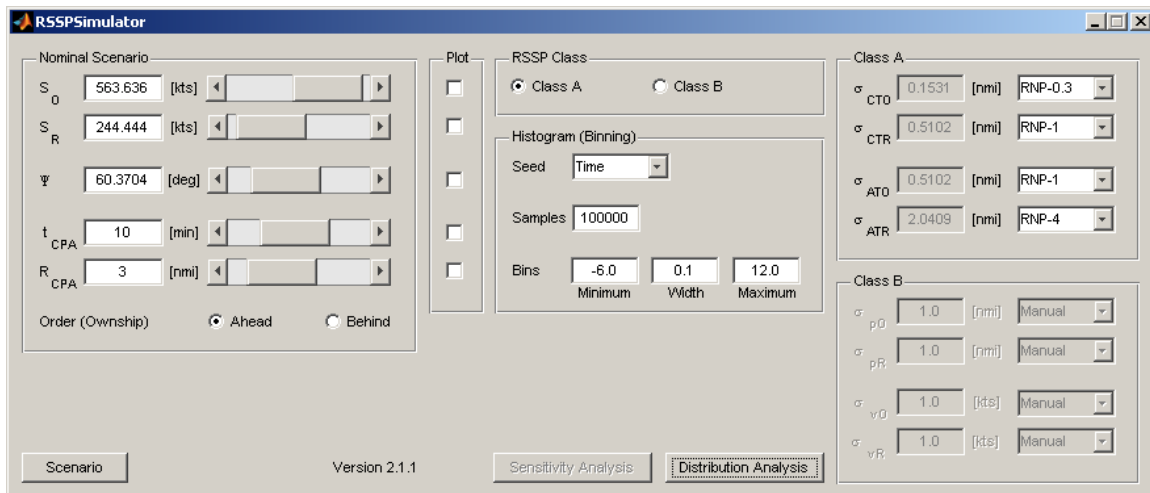

Figure 24 – Class A Single Distribution Control Panel Setup.



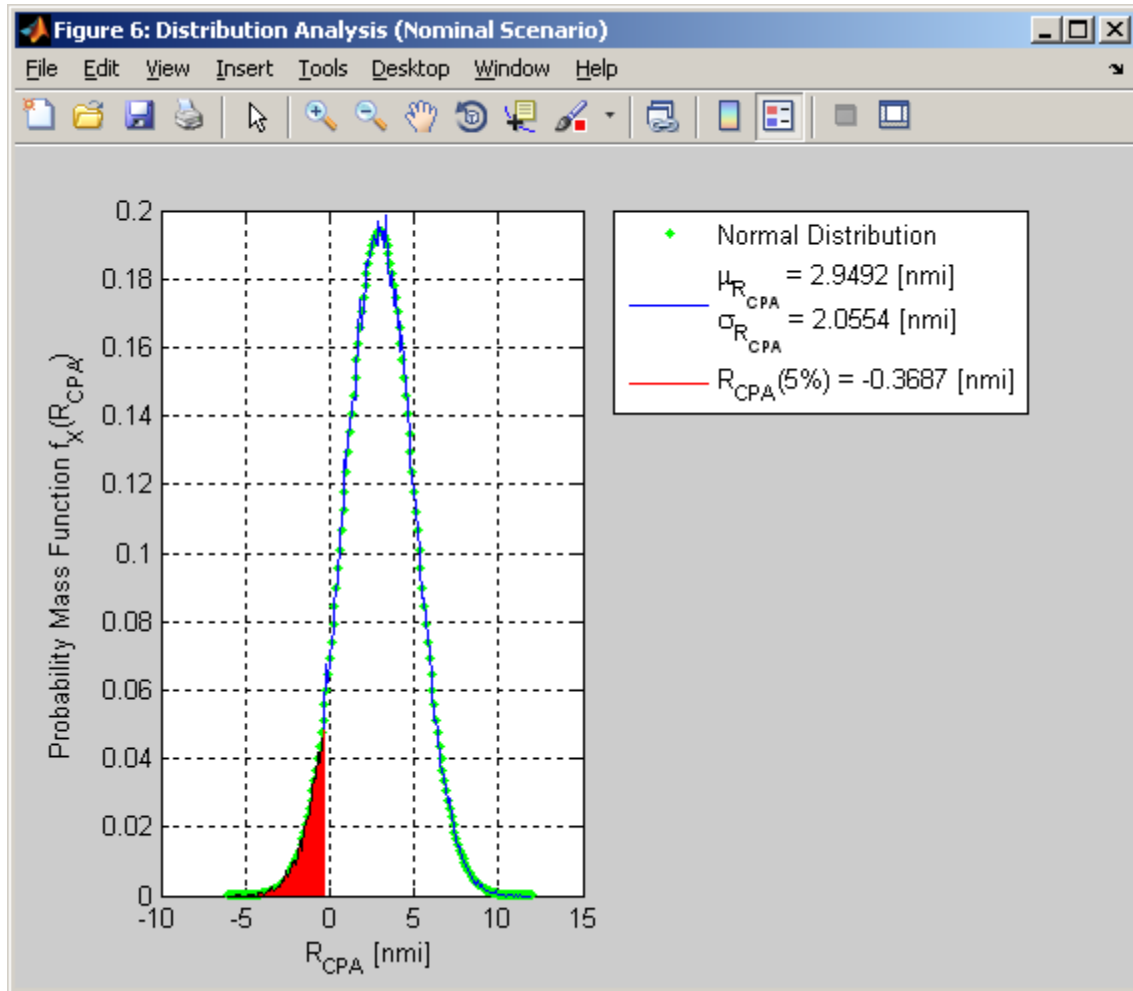

Figure 25 – Class A Single Distribution Result.

The blue line in this figure represents the normalized histogram of outputs for a random sampling of input conditions about the nominal condition given the statistics of the position errors. The mean and standard deviation of the distribution are displayed in the legend at the right. The green points represent a normal distribution with an equivalent mean and standard deviation for reference. The 5% figure, as well as the red shaded area on the plot, represent the value for  $R_{CPA}$  below which 5% of the samples lie (or, conversely, above which 95% of the samples lie). It is common for the mean to be slightly lower than the target value for  $R_{CPA}$  because of the non-linearities involved.

#### 8.5.6.4 Single-Parameter Sweep Distribution Analysis

With one of the “Plot” checkboxes selected, pressing the “Distribution Analysis” button will generate a set of distribution plots corresponding to a sweep of values for the checked parameter. In addition to the 3D plot showing the distribution as a function of the swept parameter, a second set of plots will appear to show the variation in the mean, standard deviation, and 5% point as a function of the swept parameter. For the example control panel shown in Figure 26, the resultant plots are depicted in Figure 27 and Figure 28.

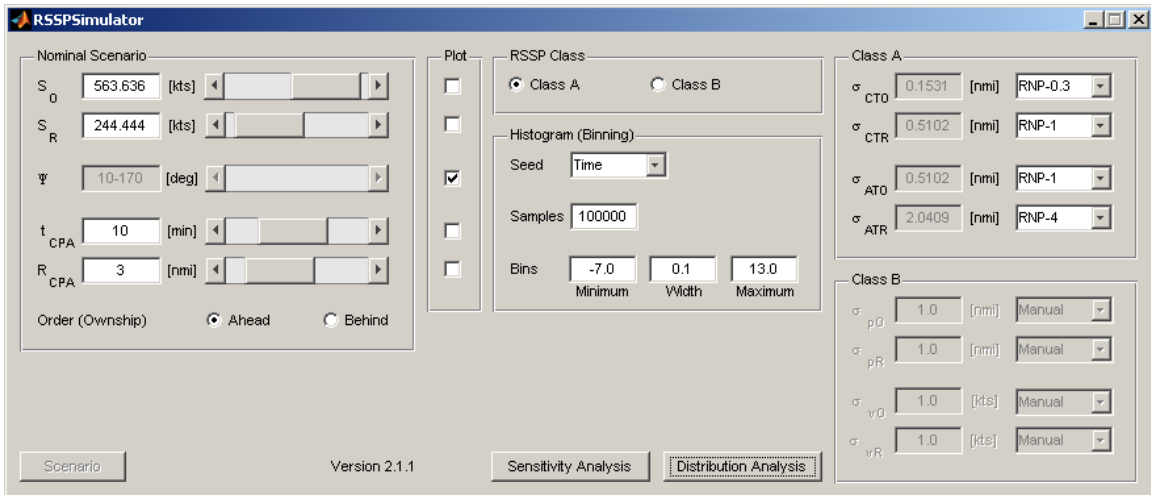

Figure 26 – Class A SPS Distribution Analysis Control Panel Setup.

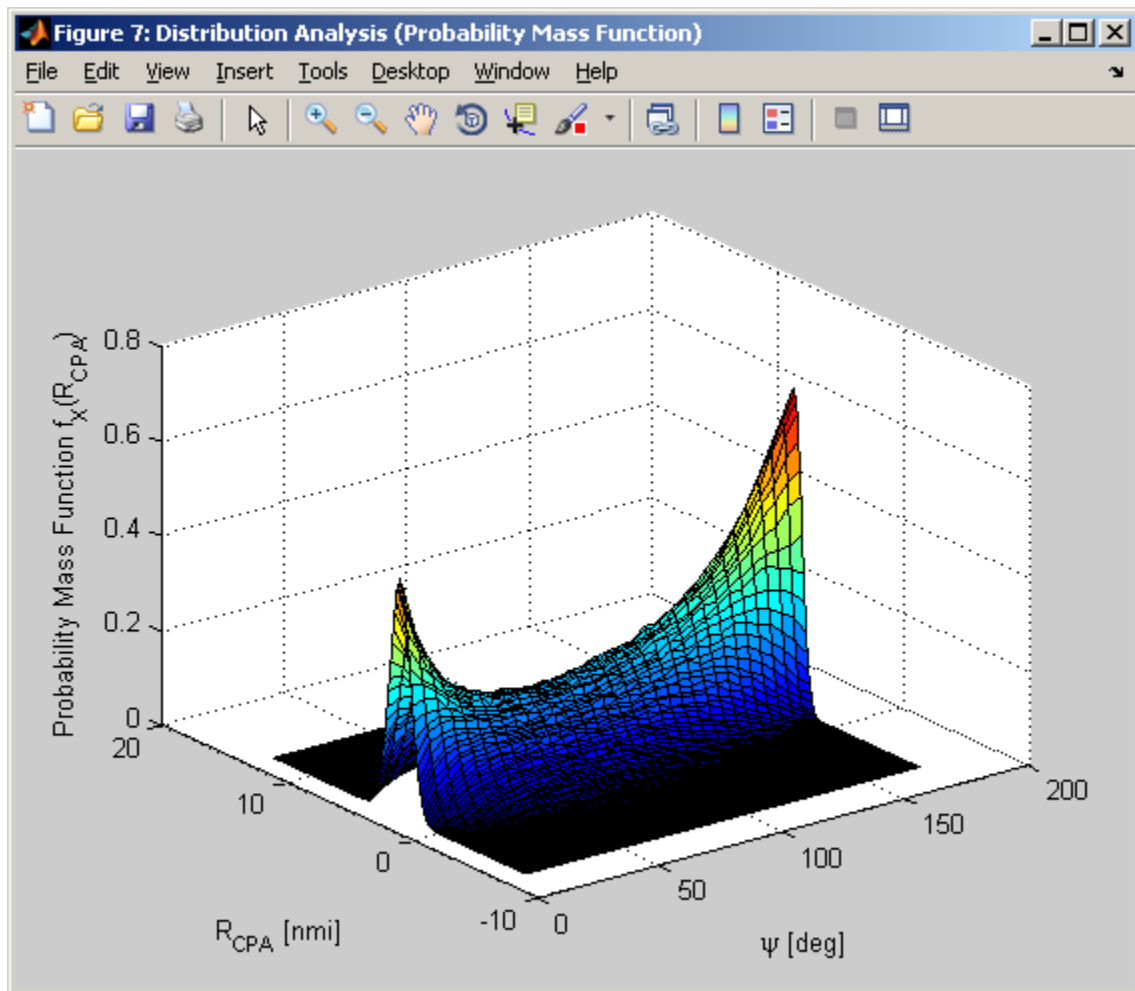

Figure 27 – Class A SPS Distribution Analysis Distribution Result.

The 3D figure represents the normalized histogram of outputs for a random sampling of input conditions about the nominal condition given the statistics of the position errors for each value of

the swept parameter (here, crossing angle,  $\psi$ ). This example shows a broadening of the distribution for crossing angles around 60 degrees.

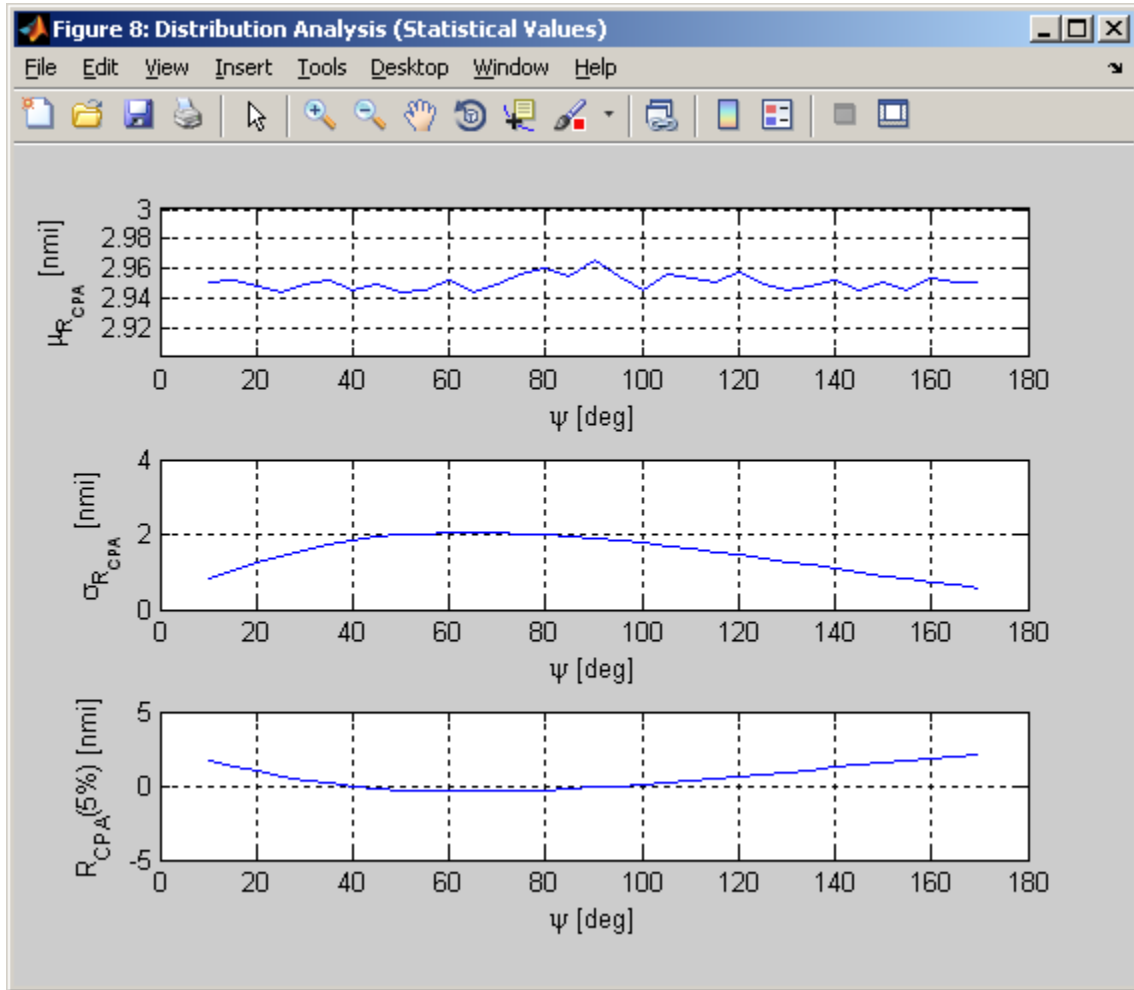

Figure 28 – Class A SPS Distribution Analysis Statistics Result.

The mean and standard deviation of the distributions are plotted in the second set of graphs along with the 5% figure that represent the value for  $R_{CPA}$  below which 5% of the samples lie (or, conversely, above which 95% of the samples lie) for each distribution.

### 8.5.6.5 Two-Parameter Sweep Distribution Analysis

With two of the “Plot” checkboxes selected, pressing the “Distribution Analysis” button will generate a set of statistical value plots corresponding to a sweep of values for the checked parameters. A 3D set of plots will appear to show the variation in the mean, standard deviation, and 5% point as a function of the swept parameters. For the example control panel shown in Figure 29, the resultant plots are depicted in Figure 30. These plots are analogous to the plots in Figure 28, but now represented across the two parameters chosen for the sweep.

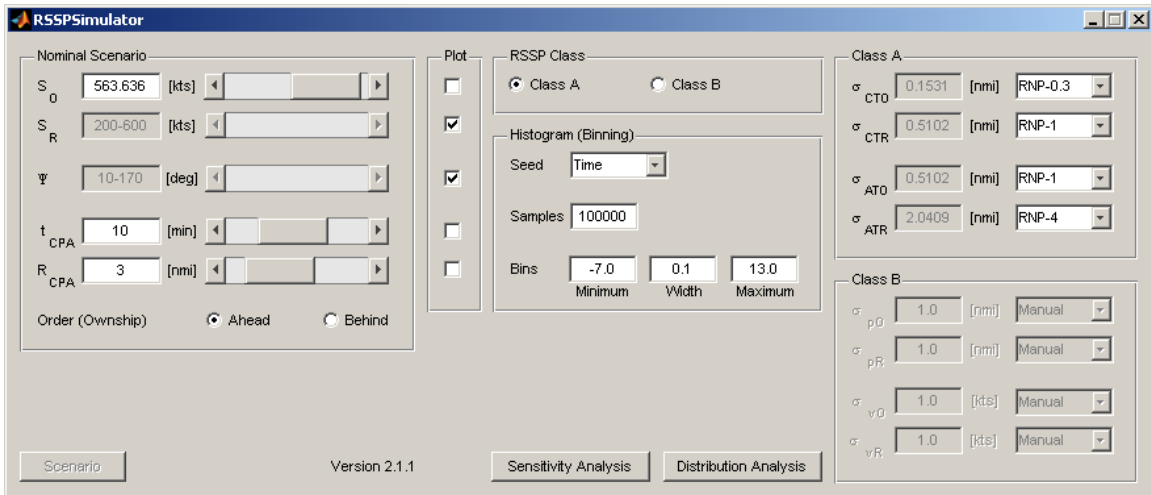

Figure 29 – Class A TPS Distribution Analysis Control Panel Setup.

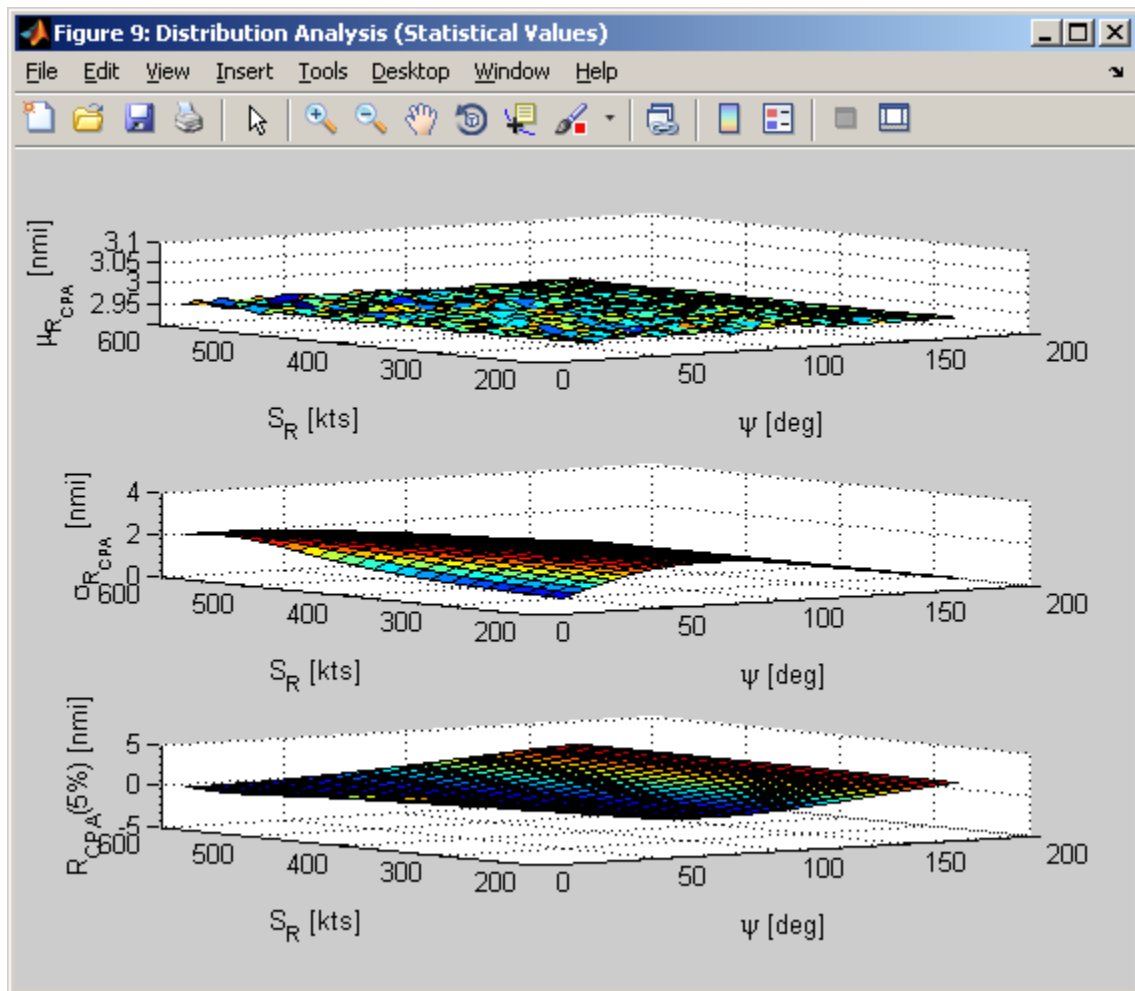

Figure 30 – Class A TPS Distribution Analysis Statistics Result.

### 8.5.7 Class B Systems

Having selected the “Class B” radio button in the upper center of the control panel, the user can set the corresponding error distribution inputs in the lower right portion of the panel as shown in Figure 31 below.

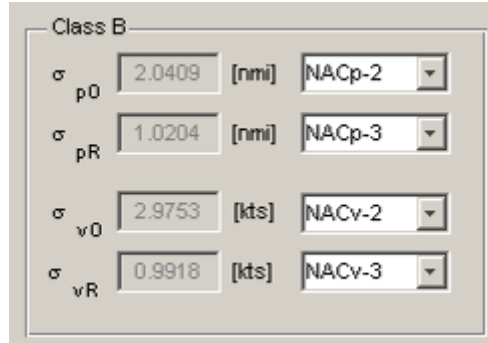

Figure 31 – Class B Error Distribution Inputs.

This set of inputs permits entry of standard deviations for the position and velocity error distributions of ownship and the reference aircraft. These errors are assumed to be uniformly distributed in azimuth. The drop-down menus to the right of each entry permit selection of the standard deviation by manual entry (“Manual”), NAC<sub>p</sub>/NAC<sub>v</sub> equivalent (“NAC<sub>p/v</sub>-\*”), or no error (“Disable”). For consistency with the definitions used for NAC<sub>p</sub> and NAC<sub>v</sub> in the ADS-B standards, the NAC<sub>p/v</sub>-\* selections represent a specific accuracy category, and the standard deviation will be computed based on the corresponding 95% confidence boundary assuming a Gaussian distribution (*Norm Dist*( $\sigma$ )) for error magnitude that is uniformly distributed (*Uniform Dist*(*Range*)) in azimuth. The pre-defined NAC<sub>p</sub> and NAC<sub>v</sub> values (shown with their corresponding 95% confidence boundaries) are:

NAC <sub>p</sub> -1	10	[nmi]
NAC <sub>p</sub> -2	4	[nmi]
NAC <sub>p</sub> -3	2	[nmi]
NAC <sub>p</sub> -4	1	[nmi]
NAC <sub>p</sub> -5	0.5	[nmi]
NAC <sub>p</sub> -6	0.3	[nmi]
NAC <sub>p</sub> -7	0.1	[nmi]
NAC <sub>p</sub> -8	0.05	[nmi]

NAC <sub>v</sub> -1	10	[m/s]
NAC <sub>v</sub> -2	3	[m/s]
NAC <sub>v</sub> -3	1	[m/s]
NAC <sub>v</sub> -4	0.3	[m/s]

These values will be converted into standard deviations using Equation (73).

### 8.5.7.1 Single Distribution

With none of the “Plot” checkboxes selected, pressing the “Distribution Analysis” button will generate a single distribution plot. For the example control panel shown in Figure 32, the resultant distribution is depicted in Figure 33.

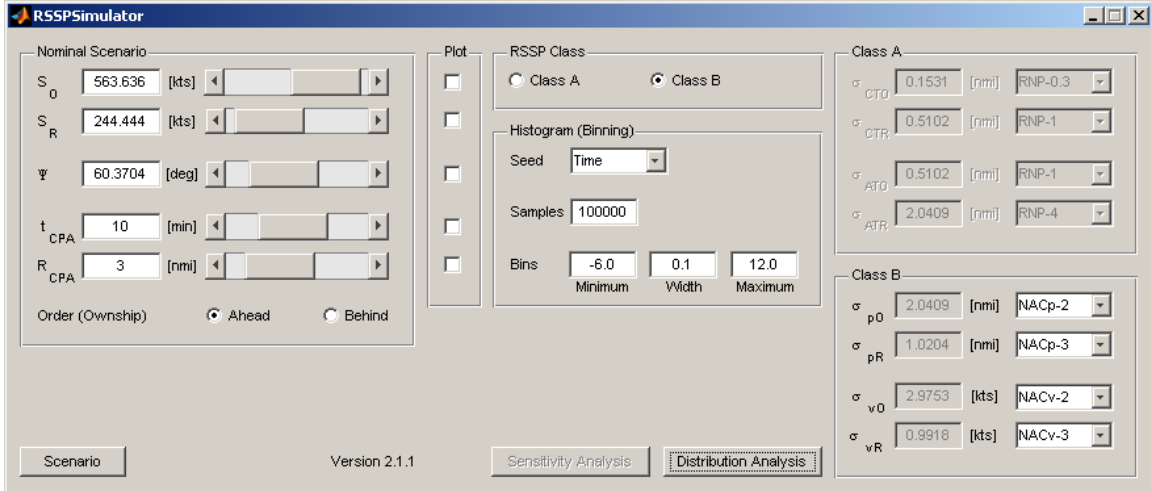
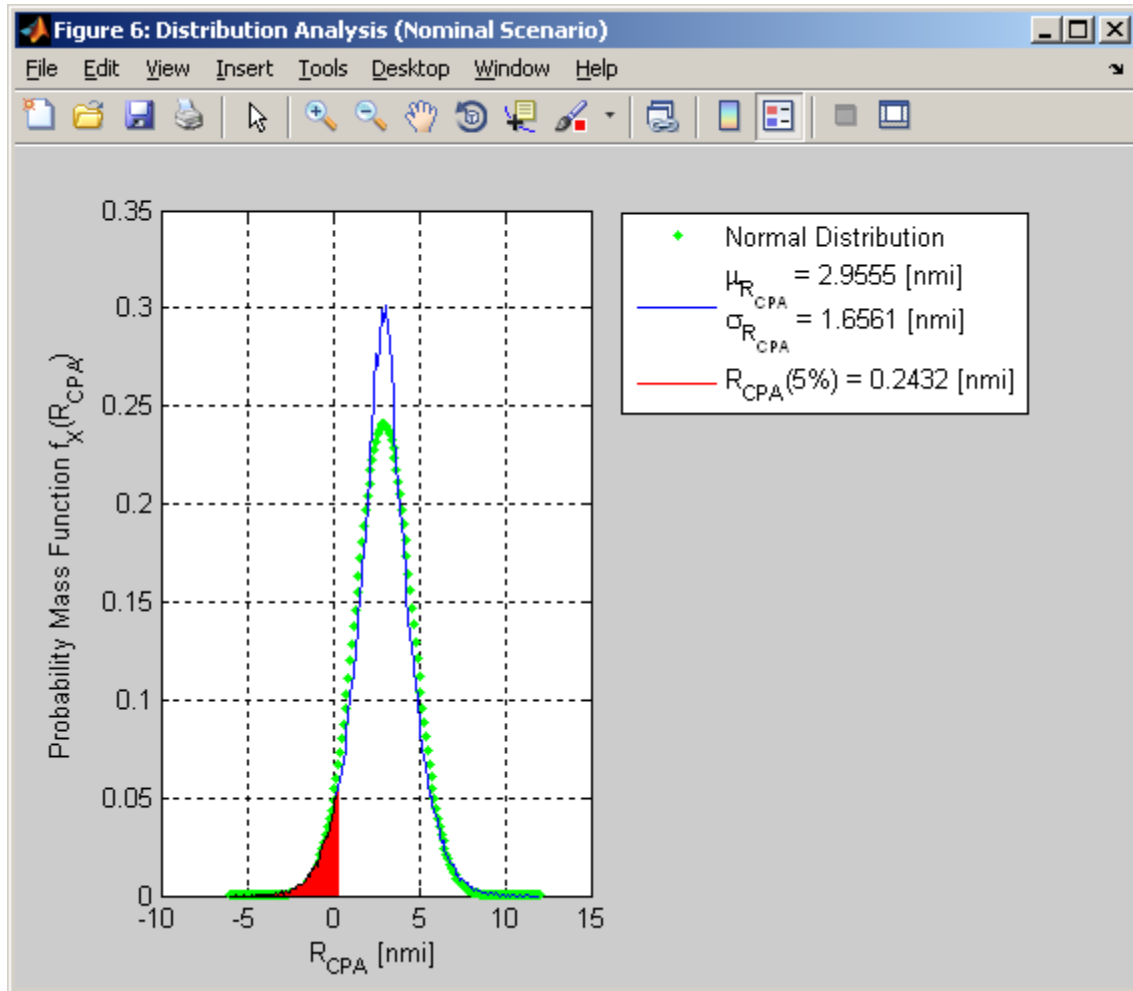

Figure 32 – Class B Single Distribution Control Panel Setup.



**Figure 33 – Class B Single Distribution Result.**

The blue line in this figure represents the normalized histogram of outputs for a random sampling of input conditions about the nominal condition given the statistics of the position and velocity errors. The mean and standard deviation of the distribution are displayed in the legend at the right. The green points represent a normal distribution with an equivalent mean and standard deviation for reference. The 5% figure, as well as the red shaded area on the plot, represent the value for  $R_{CPA}$  below which 5% of the samples lie (or, conversely, above which 95% of the samples lie).

### **8.5.7.2 Single-Parameter Sweep Distribution Analysis**

As was shown above for Class A system distribution analysis, with one of the “Plot” checkboxes selected, pressing the “Distribution Analysis” button will generate a set of distribution plots corresponding to a sweep of values for the checked parameter. In addition to the 3D plot showing the distribution as a function of the swept parameter, a second set of plots will appear to show the variation in the mean, standard deviation, and 5% point as a function of the swept parameter. For the example control panel shown in Figure 34, the resultant plots are depicted in Figure 35 and Figure 36.

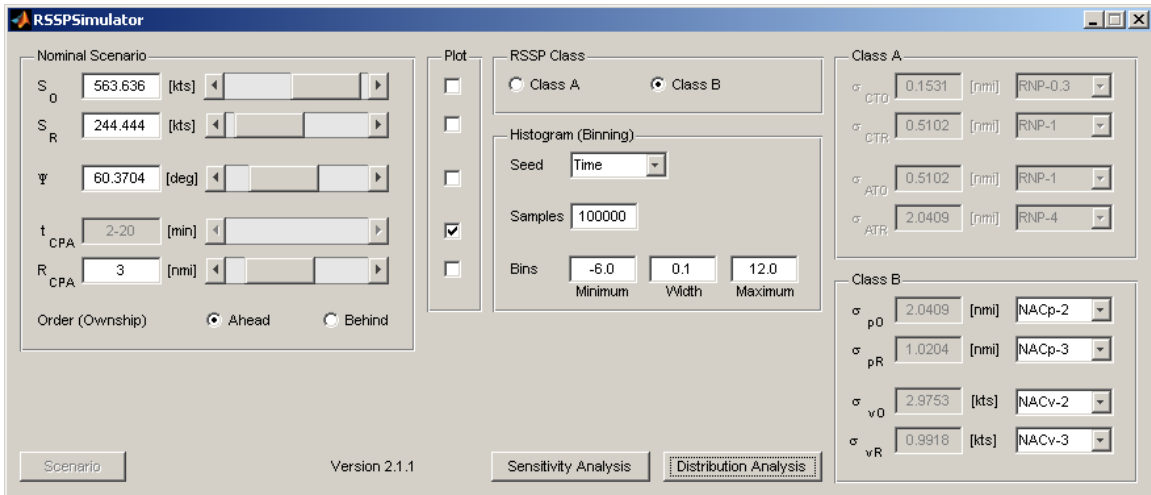

Figure 34 – Class B SPS Distribution Analysis Control Panel Setup.

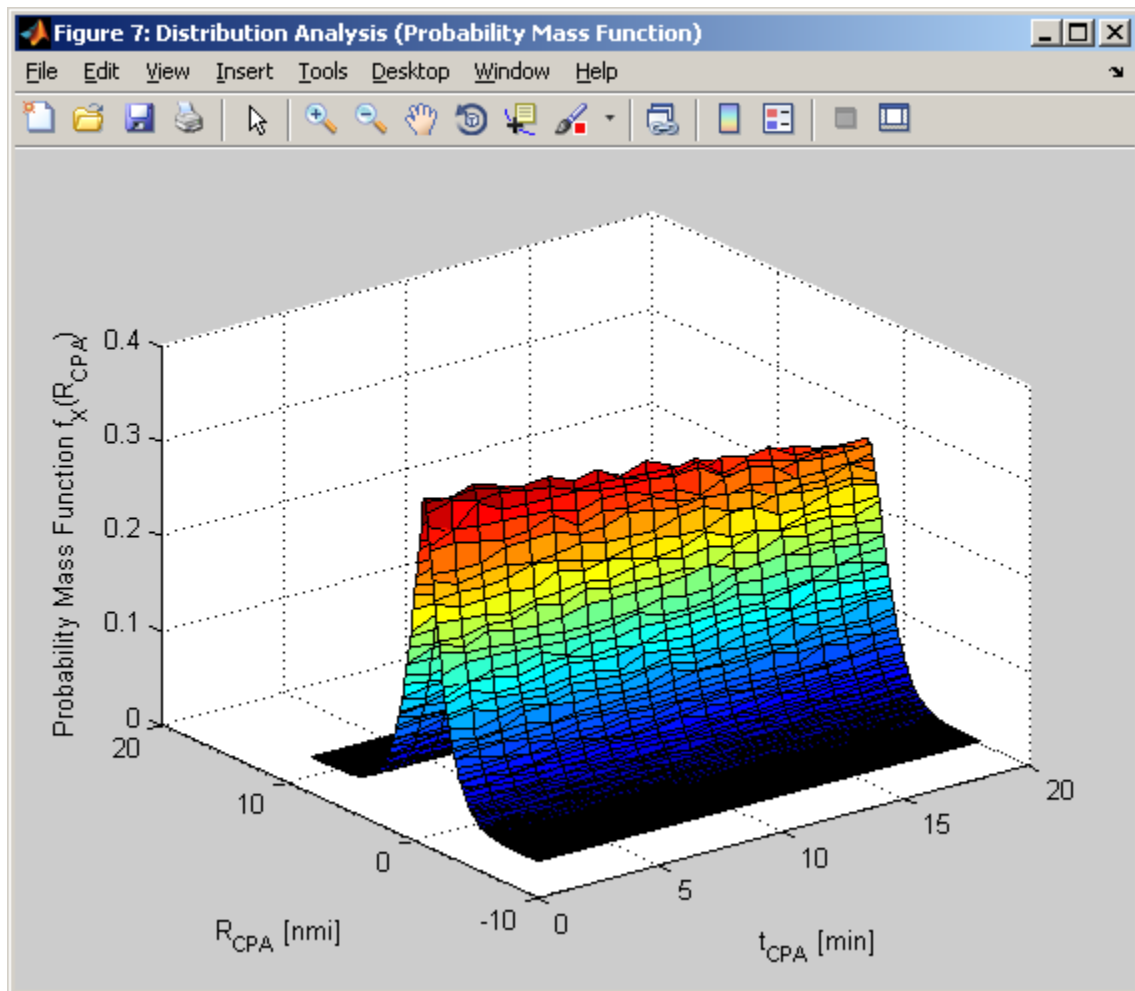

Figure 35 – Class B SPS Distribution Analysis Distribution Result.

The 3D figure represents the normalized histogram of outputs for a random sampling of input conditions about the nominal condition given the statistics of the position and velocity errors for



each value of the swept parameter (here,  $t_{CPA}$ ). This example shows a broadening of the distribution as  $t_{CPA}$  increases.

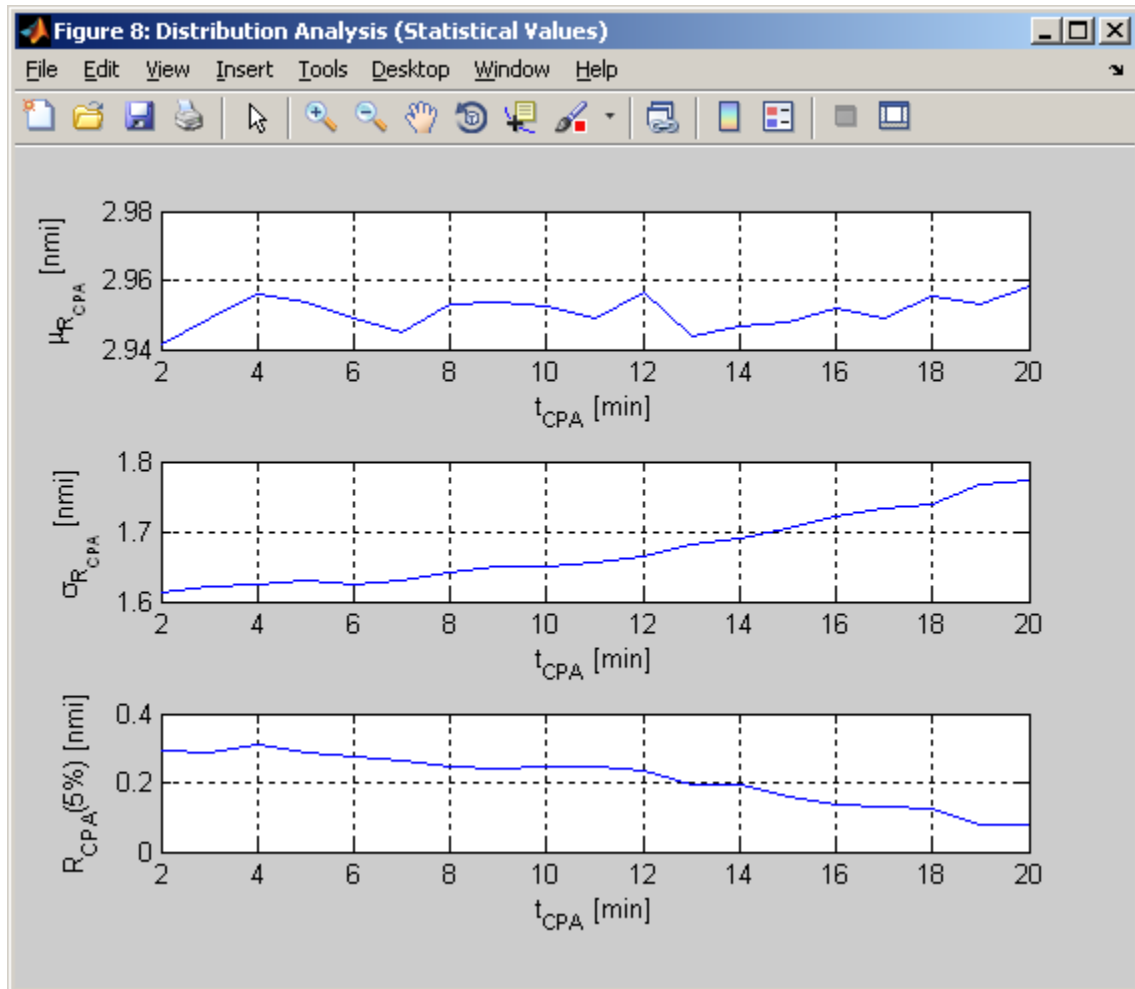

Figure 36 – Class B SPS Distribution Analysis Statistics Result.

The mean and standard deviation of the distributions are plotted in the second set of graphs along with the 5% figure that represent the value for  $R_{CPA}$  below which 5% of the samples lie (or, conversely, above which 95% of the samples lie) for each distribution.

### 8.5.7.3 Two-Parameter Sweep Distribution Analysis

Likewise, Two-Parameter Sweeps can be performed for Class B systems in the same manner as demonstrated in Section 8.5.6.5 for Class A systems.

## **9 Required Interval Management Performance Model**

### **9.1.1 Introduction**

The concept of Required Interval Management Performance (RIMP) was presented in an earlier report titled “*Required Interval Management Performance, Version 1.1*”. It is a metric to describe the performance of an interval management system which provides guidance for an aircraft (ownship) to arrive at an “Interval Management Point” at a precise time interval after another aircraft (reference aircraft). RIMP operation relies on the NextGen concepts of Trajectory-Based Airspace and Operations (TBO), airborne surveillance technologies such as ADS-B, precise navigation technologies including the RNAV/RNP operations, and various data link technologies.

Aircraft engaged in TBO fly a flight plan agreed-upon by the operator and the Air Navigation Service Provider (ANSP). That planned trajectory is available to other aircraft within the airspace. The planned trajectory provides 4-dimensional intent information that includes the horizontal route (ground track) of the flight, altitude constraints and vertical profile, and the planned speed for each leg (segment) of the planned trajectory plan. The planned speed is presented here as the aircraft true airspeed. In addition, it is assumed that all participating aircraft have access to weather information containing detailed wind and altitude data for the areas of interest. Access to this information is needed to perform the required calculations to estimate the enroute time or “Time to Go” (TTG) to the spacing point for both the ownship as well as the reference aircraft. This will be necessary as it is not assumed that the TTG (plus an associated uncertainty) will be broadcast. It is also expected that excessive deviation from the agreed-upon flight plan will necessitate the negotiation of a revised flight plan between the operator and the ANSP. Many parameters can influence the planned operations and impact the behavior of the system. This section provides a framework to analyze RIMP operations in the presence of various uncertainties and operational limitations. An accompanying MATLAB/Simulink model provides a means for a time-based simulation of paired approaches using the RIMP concept. The results of this study will provide a benchmark to measure Interval Management (IM) performance and provide a way to determine the RIMP in order to achieve a spacing interval that meets appropriate levels of safety, predictability, and reliability.

### **9.1.2 Section Overview**

Section 9.2.1 provides an overview of the simulation model, a description of RIMP operations, and the parameters that insert error and uncertainty into this operation.

Section 9.3 describes the aircraft equations of motion, environmental variables such as wind and temperature, and sensor model.

Section 9.4 describes the Time-to-Go (TTG) calculations.

Section 9.5 outlines a simplified RIMP Speed Control concept implemented within the simulation model.

## 9.2 RIMP Operation Model

An operation flow diagram for RIMP is provided in Figure 37. The process is initiated when the ANSP assigns ownership a reference aircraft to follow.

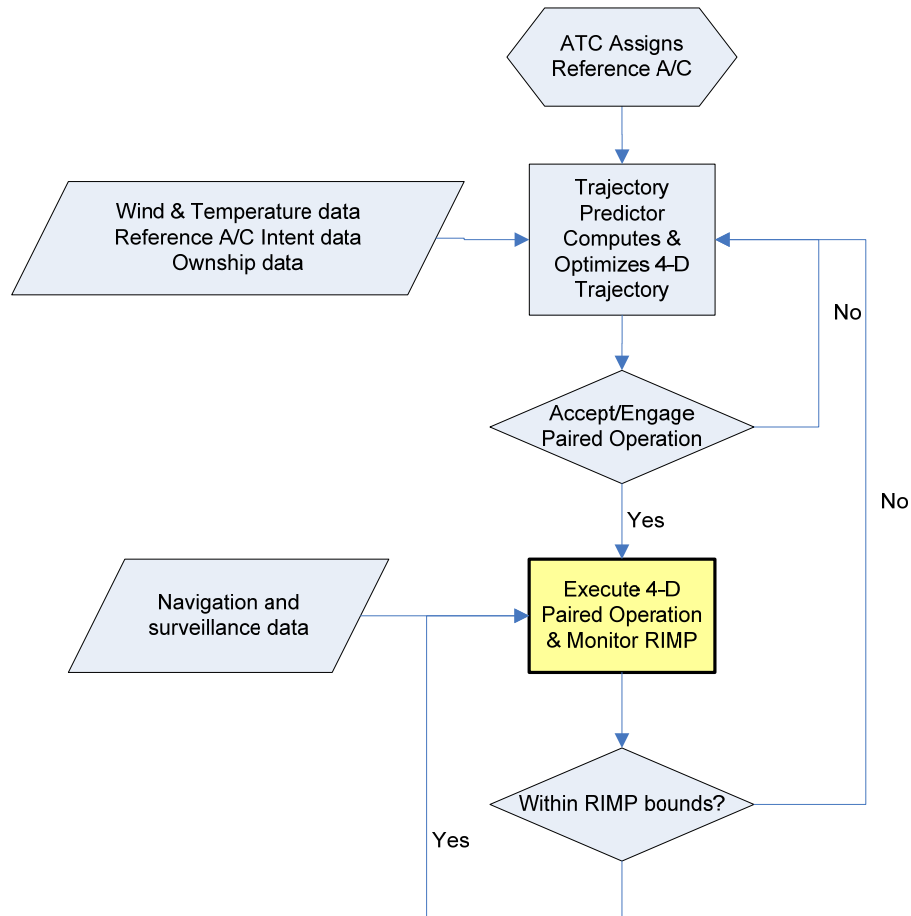

Figure 37 – RIMP Operation Flow Diagram

There are two primary processes involved in this operation. First, a 4-D planned trajectory is developed and optimized based on the current estimates of wind and temperature at specific points throughout the flight plan. This process includes information regarding position, altitude, time, reference aircraft intent information, ownship navigation and intent information, and ownship expected performance.

The output of this step is a 4-D trajectory that specifies a series of 3-D legs and an expected true airspeed for each leg. Once the flight crew accepts the proposed solution and engages the paired operation, this trajectory information is broadcast to other traffic as well as Air Navigation Service Provider (ANSP).

The second process (highlighted) is the execution of interval management. This includes monitoring ownship progress relative to the reference aircraft and providing interval management guidance commands (speed changes). It also includes monitoring the required performance associated with RIMP. It may be necessary to revise the original flight plan in

order to maintain the desired level of RIMP. In that case, a cycle through the first process will be necessary.

The current version of the RIMP analysis model includes the ability to operate a 4-D trajectory. The trajectory consists of Trajectory Change Points (TCP) defined by their latitude, longitude, altitude, and a true airspeed to fly. The IM utilizes speed change commands for a finite length of time. Additional provisions are made to enable implementation and testing of the “IM Turn<sup>26</sup>” in the planned trajectory. It is assumed that significant changes to the planned trajectory including prolonged speed change will require a rebroadcast and possibly re-negotiation with other aircraft engaged in paired operation and/or ANSP.

The focus of this mathematical modeling effort is the execution of the paired IM operation. The results of this analysis may also be used in the future to further develop the 4-D planned trajectory generation and optimization process. The intent of developing a representative mathematical model for IM operations is to quantify the effects of real-life variations and limitations on its “behavior”.

The current aircraft spacing standards in Instrument Flight Rules (IFR) conditions are based on various limitations imposed on the IM operations such as the Air Traffic Control (ATC) workload, surveillance system accuracy and update rate, communication limitations, and speed control limitations (e.g. aerodynamic limits). A mathematical representation of the system should be able to shed some light on the impact of various limitations and allow to verify the validity of current operations as well as to demonstrate how the spacing time can be safely reduced when the appropriate navigation, surveillance, and automated procedures are used.

### **9.2.1 Modeling Approach**

A simplified non-linear simulation of an aircraft executing the RIMP operation was developed using the MATLAB/Simulink environment. This model can be used for a Monte Carlo simulation which will collect statistics that are not analytically obtainable due to the lack of a closed-form solution. A Simulink concept called “Reference Model<sup>27</sup>” is used to represent each of the aircraft engaged in the RIMP operation. The aircraft models are identical in their format, but can be provided with different internal parameters to make them represent different aircraft performance and limitations.

Figure 38 shows the Simulink top level view of the RIMP model. An implementation of 6-aircraft RIMP pairings is depicted.

Each aircraft within the RIMP operation model is assigned a unique identification number (e.g. #4). This enables different aircraft to be associated with a specific flight plan and a specific initial condition file. In addition, a unique aircraft performance data file is associated with each aircraft. Two other data files are used by the RIMP model. These are common among all aircraft and specify general simulation constants as well as sensor characteristics.

---

<sup>26</sup> The “IM Turn” is a form of path length modification used to make larger adjustments to the time of arrival estimate than can be achieved by speed control alone.

<sup>27</sup> A Simulink Reference Model allows the use of a single model in multiple instances for easier maintainability.

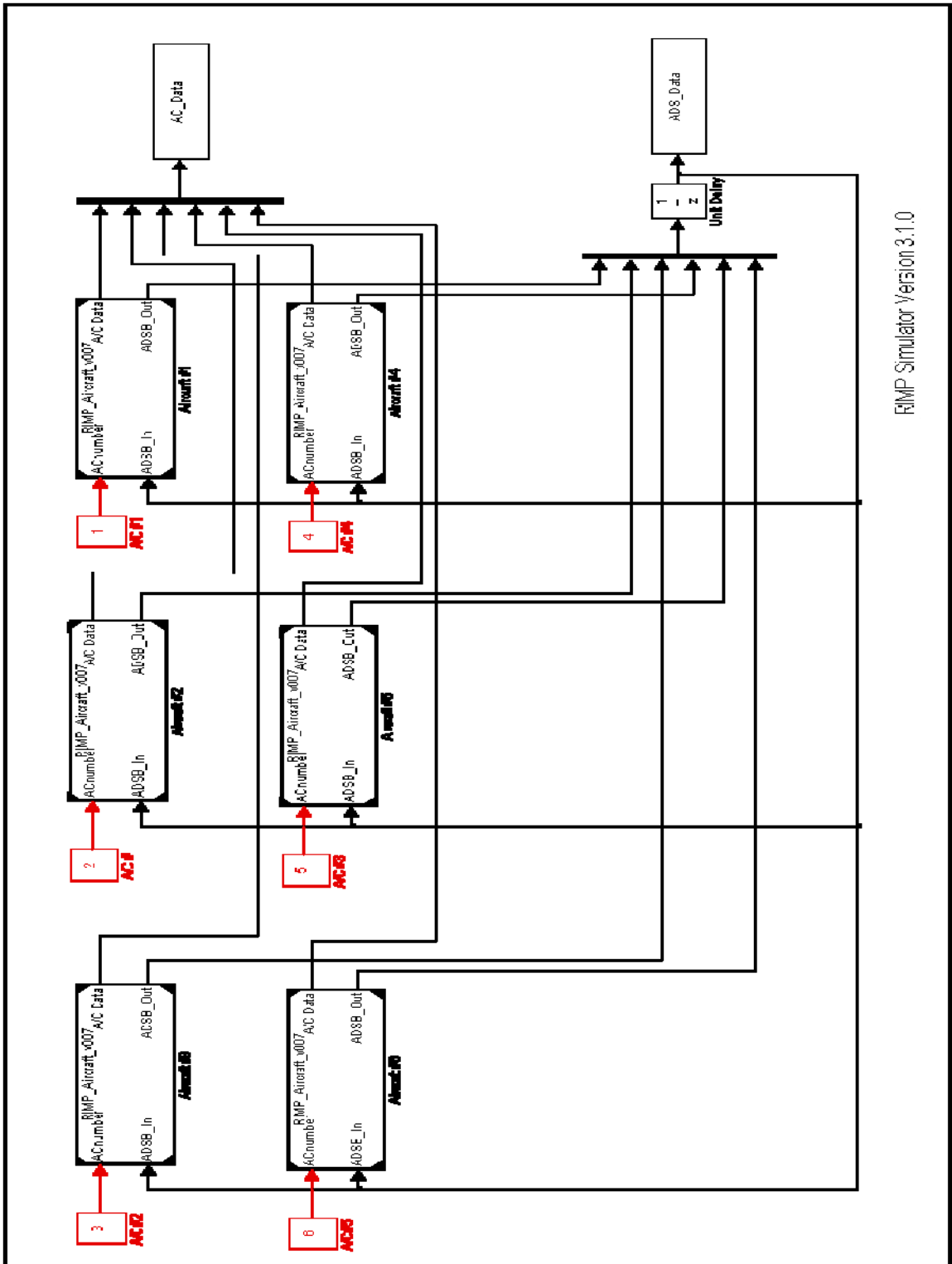
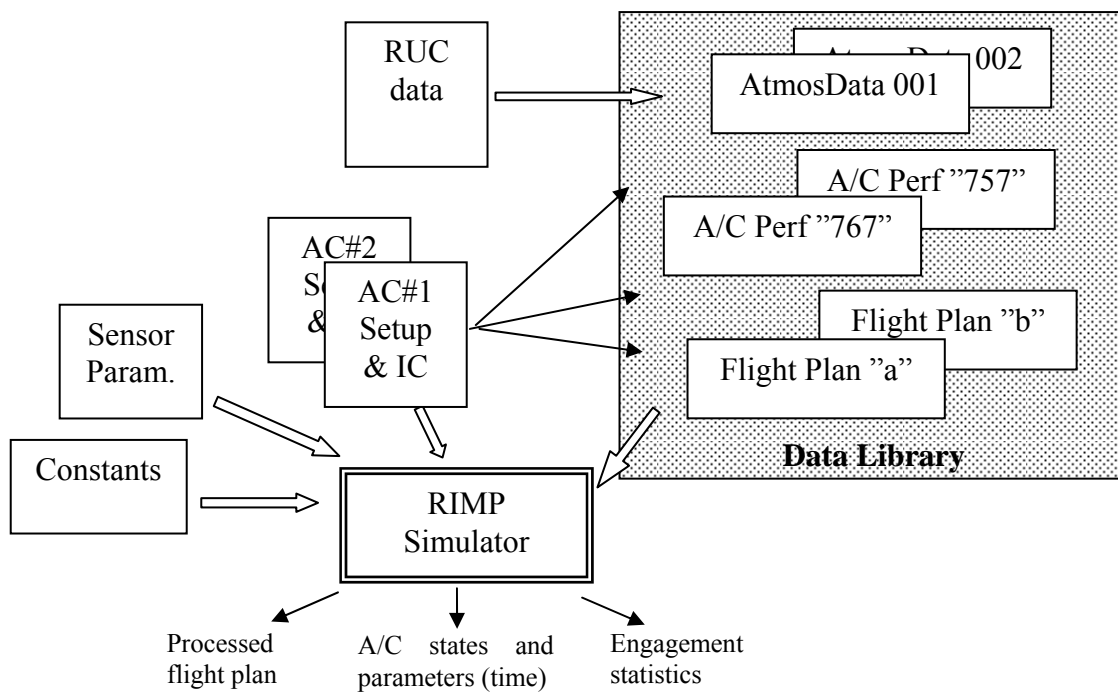

Figure 38 – RIMP Operation Model

Figure 39 provides an overview of the RIMP operation model data flow. At the start of the simulation, the flight plan, aircraft limits, and aircraft setup files are read and the appropriate variables within the MATLAB simulation are populated. The aircraft setup file points to the appropriate flight plan, aircraft limit, and pre-processed wind data file. The setup file also includes data needed to initialize and configure the specific aircraft operation within the interval management stream. The execution of the model also includes two common files that describe the sensor properties (common among all aircraft) as well as other constant parameters used for the execution of RIMP.

The model generates a time series of aircraft states at a sampling rate of once per second for each of the aircraft. In addition, the processed flight plan information for each aircraft is available. Finally, a set of statistics for each aircraft RIMP execution will be stored.



**Figure 39 – RIMP model data flow**

The RIMP operation simulation model consists of a number of aircraft models executing interval management operations. The communication between the aircraft is currently accommodated by a simple message structure where each aircraft writes its own states and from it reads the states of all other aircraft from. At present, a single frame delay is used in this communication and it is assumed that the total system latency is accounted for in the sensor model for each aircraft. However, the mechanism is in place to add additional delay frames for the communication system. It should be noted that the nominal system update is currently done at 100 Hz (10 millisecond update rate).

### **9.2.2 Aircraft Model Configuration**

Figure 40 provides an overview of the RIMP aircraft model. The primary input to each aircraft is a unique aircraft number. Upon the start of the simulation, each aircraft model will access the base MATLAB workspace and retrieve the parameters associated with the specified aircraft number. This includes aircraft operational and performance parameters as well as the assigned flight plan. In addition, a dynamic dataset called “ADS\_Data” is read by each aircraft at each execution frame (ADSB\_in). This dataset provides “current” information on all the vehicles involved in the RIMP operations. The aircraft model generates two output vectors. One is the “ADSB\_Out” vector which is shared by all the other aircraft during operation. The other is the relevant aircraft data including the measurement of dynamic states as well as other desired simulation parameters.

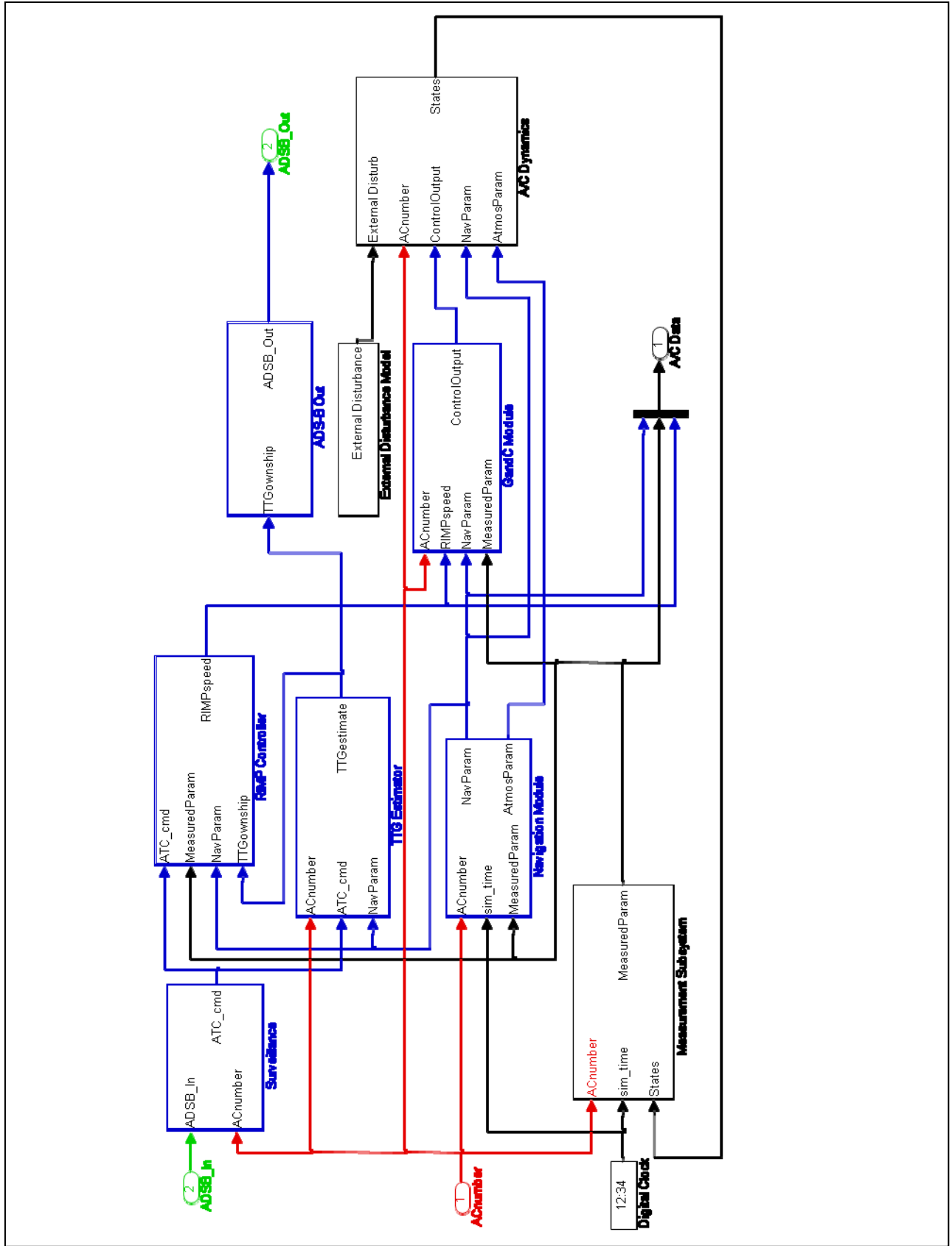

Figure 40 – RIMP Aircraft Model



Each aircraft model contains all the necessary components to complete the 4-D flight plan and to perform RIMP operations. At the core of the aircraft model is the “A/C Dynamics” block that contains the equations of motion, initialization, and wind environment components. Other system components include the “measured output” module which contains various sensor properties, “navigation” module, “guidance and control” module, “time-to-go estimator”, “ADS-B input”, “ADS-B output”, and “RIMP control” modules.

### **9.2.2.1 Aircraft Dynamics Model**

The aircraft dynamics model provides a simplified set of equations of motion for propagation of a point mass in three-dimensions plus the east and north wind velocities. The output of the aircraft dynamics model is considered as the truth model and is fed to the sensor model. The inertial velocities are defined using the total inertial velocity, plus a ground track and a vertical flight path angle. The position states include the Easting, Northing, and altitude relative to sea level and a navigation origin point defined in the “constants” data file.

The wind states include east and north components. Wind states model a spatially varying wind defined at each waypoint and linearly varying to the adjoining waypoints. Each wind “node” includes forecast wind plus a random wind component which is different for each aircraft. Essentially, this represents a slowly time-varying component of the wind in addition to the forecast wind since aircraft are separated by approximately one minute.

### **9.2.2.2 Measurement Model**

The measurement model receives the truth aircraft states from the aircraft model which it uses to compute several derived parameters such as groundspeed, vertical speed, and airspeed. The sensor model adds various elements of errors and uncertainties associated with each specific sensor to “perturb” the data and simulate typical sensor output. The output of the sensor model is then used by various components of the simulation to generate a realistic system response.

### **9.2.2.3 Navigation Module**

The flight plan is preprocessed for each aircraft to generate a sequence of segments for the aircraft to fly. Each segment includes an origin waypoint and a destination waypoint with associated altitudes. This information is translated to a required ground track, a required flight path angle and a planned airspeed to fly.

During the execution of the simulation, the navigation module compares the current measurement of aircraft states against the desired navigation information and calculates such navigation parameters as cross-track error, glideslope deviation, desired turn rate, desired climb rate, etc. A critical function of the navigation module is to keep track of the progress of the flight and automatically sequence through the specified waypoints. As a part of this function, the navigation module computes when the aircraft must start turning towards the next segment course and when to declare a waypoint sequenced.

The navigation module operates under two normal navigation modes; “Turn Mode” and “Track Mode”. “Turn Mode” provides navigation commands to intercept the next segment course at the proper moment using a constant radius turn. As the aircraft inertial speed is changed due to the

wind environment, the rate of turn is adjusted to maintain a constant radius to complete the intercept turn correctly. When in Track mode, the navigation system provides the appropriate parameters to enable the aircraft to track the desired course and null any detected cross-track error. In either mode, the navigation system provides the appropriate desired flight path angle and true airspeed to fly the current segment.

#### **9.2.2.4 Guidance and Control**

The guidance model attempts to fly the aircraft as directed by the navigation module and RIMP control module. In essence, the guidance and control module replaces the function of the pilot or autopilot. The linear acceleration command is generated and adjusted such that the commanded true airspeed is achieved and maintained. Similarly, turn rate and rate of change of vertical flight path are adjusted in order to either achieve the desired navigation commands or to null the cross-track or glideslope error predicted by the navigation module.

The guidance and control module also monitors the specified aircraft envelope and limits the commands to preserve the required flight envelope. For example, if the RIMP controller requests an airspeed reduction beyond the aircraft specified envelope, the guidance and control module will limit the airspeed command.

#### **9.2.2.5 TTG Estimator**

The “time-to-go” or TTG estimator computes an estimate of time required to fly to the RIMP interval management point. It uses the current position and velocity information from the sensor model, as well as current and future planned trajectory parameters from the flight plan. The TTG estimator uses the planned airspeed and average forecast winds to compute an “expected” groundspeed for each segment. The current segment calculations use the measured winds and current airspeed, but the system assumes that the airspeed will be adjusted to the planned value. Since the actual winds are statistically different than the forecast values and the simulation model linearly changes the winds while enroute, the wind error terms will directly affect the TTG estimates.

The current version of the simulation assumes that each aircraft broadcasts its time-to-go estimate. This is a simplification in the current model. However, since all aircraft have access to the flight plan of their reference aircraft, a duplicate copy of the TTG estimator can be used to estimate TTG for the reference aircraft.

#### **9.2.2.6 Surveillance Model**

The surveillance model acts as a conduit to supply the reference aircraft position, speed, and other parameters to the ownship. In practice, a combination of ADS-B messages and other data link information provide the surveillance function. In the simulation model, this component adds the appropriate time delays to the affected parameters as needed. In the initial version of the simulation, this model is essentially a pass-through model providing the TTG broadcast by the reference aircraft.

### 9.2.2.7 RIMP Speed Control

The current version of RIMP speed control monitors the TTG for ownship and the reference aircraft and generates a positive or negative increment to the speed guidance commands. This is effectively an increment to the planned true airspeed of aircraft.

### 9.2.3 Elements of Uncertainty and Operational Limits

The interval management operation relies on ownship aircraft navigation, extensive surveillance information received from other participating aircraft, and a number of assumptions concerning the intent and procedures executed by all participating aircraft. One key element of this procedure is the estimate of TTG to the interval management point for both ownship and the reference aircraft. The desired or commanded interval time is written as the difference between the time-to-go of ownship and the reference aircraft. To model the real-life uncertainties in navigation, flight planning, wind variation from the forecast values and many other terms affecting the RIMP operations, the following modeling terms have been added:

- 1- Wind uncertainty (relative to predicted local winds)
- 2- Speed measurement uncertainty
- 3- 3-D Position/Distance-to-go uncertainty
- 4- Altitude measurement uncertainty
- 5- Integration error
- 6- Input time uncertainty
- 7- Speed guidance accuracy
- 8- Temperature and pressure uncertainty impacts the calculation of speed of sound and air density. This affects the calculation of Mach number and indicated airspeed. In the current implementation, the temperature variation is included but its uncertainty is not modeled.
- 9- Performance data accuracy (for predictions/trajectory integration) affects the ability of the aircraft to meet the planned trajectory. The airspeed limitations are modeled as a function of altitude. However, propulsion system limitation and aerodynamic drag uncertainties are not directly introduced in the current version of the simulation.

In addition to the above, a number of “pure time delay” terms are added to the interval time calculations. These are:

- 10- Surveillance time delay
- 11- Onboard calculation time delay
- 12- Communication time delay
- 13- Equivalent human performance delay and/or autopilot time delays are indirectly modeled. These terms are pure time delays associated with the onset of responses to events.

The interval-time equations include the following basic parameters that may be adjusted, and need to be maintained (controlled) within a given limit:

- 14- Planned acceleration or deceleration

- 15- Planned Mach or indicated airspeed is maintained. True airspeed is calculated. The TTG for the current segment is based on the current true airspeed and current measured winds. The time-to-go for future segments is based on forecast wind values along with the planned true airspeed.
- 16- Planned 3-D flight path

Effective resolution of signals or parameters used to control the RIMP operation introduces an equivalent dead-band<sup>28</sup>. For example, airspeed change is customarily commanded by air traffic control in increments of 10 Knots. The indicated airspeed is typically displayed with a resolution of 1 Knot. Several “dead-band” components are included:

- 17- Airspeed control dead-band
- 18- Interval management dead-band
- 19- Position and altitude control dead-band

Several limits are used to restrict the available solution-space. In most cases, reaching a limit could affect the method of control or may require a revision of the 4-D flight plan.

- 20- Indicated or Equivalent airspeed upper and lower limits as a function of altitude
- 21- Acceleration and deceleration limits
- 22- Rate of turn limits
- 23- Rate of change of flight path angle limits
- 24- Available power for airspeed control is not currently implemented.

The interval time equations essentially yield the dynamic response of the system in the presence of the above terms. Since Interval Management is essentially a feedback control system, the intent of this analysis is to assess the performance and stability properties of this system by exercising these equations.

### **9.3 Aircraft and Environment Model Derivation**

This section defines the simplified point-mass equations of motion, sensor model, and various uncertainty and variability components added to the basic model.

#### **9.3.1 Point-Mass Equations of Motion**

##### **9.3.1.1 Inertial States**

For this analysis it is assumed that the aircraft is strictly a point mass. Therefore, orientation concepts such as heading and pitch angles are undefined. However, the aircraft inertial velocity vector is used to define a total velocity, a ground track, and a vertical flight path angle. The time derivative of the inertial velocity vector is the input to the equations of motion. The equations of motion propagate the following relations.

---

<sup>28</sup> A dead-band is an area of signal range or band where no action occurs.

$$\begin{bmatrix} a \\ \dot{\chi} \\ \dot{\gamma} \end{bmatrix} \Rightarrow \int \Rightarrow \begin{bmatrix} V \\ \chi \\ \gamma \end{bmatrix} \Rightarrow \begin{bmatrix} v_E \\ v_N \\ v_U \end{bmatrix} \Rightarrow \int \Rightarrow \begin{bmatrix} Easting \\ Northing \\ Altitude \end{bmatrix} \quad (74)$$

Since the aerodynamic forces such as lift and drag depend on the true airspeed and air density experienced by the aircraft, it is necessary to compute the instantaneous true airspeed experienced at the aircraft position. This is accomplished by computing an instantaneous wind vector independent of the aircraft's inertial states described above.

The acceleration and angular rates are computed by the guidance and control module. The total acceleration and angular rates used by the equations of motion include the commanded terms plus random external components that can be used to mimic external disturbances such as atmospheric turbulence or other factors altering the intended flight path.

$$\begin{bmatrix} a \\ \dot{\chi} \\ \dot{\gamma} \end{bmatrix}_{Total} = \begin{bmatrix} a \\ \dot{\chi} \\ \dot{\gamma} \end{bmatrix}_{Command} + \begin{bmatrix} a \\ \dot{\chi} \\ \dot{\gamma} \end{bmatrix}_{ExternalDisturbance} \quad (75)$$

The east, north, and up components of the velocity vector are computed using the integrated acceleration and angular rate terms above.

$$\begin{bmatrix} v_E \\ v_N \\ v_U \end{bmatrix} = \begin{bmatrix} V \cdot \cos(\gamma) \cdot \sin(\chi) \\ V \cdot \cos(\gamma) \cdot \cos(\chi) \\ V \cdot \sin(\gamma) \end{bmatrix} \quad (76)$$

The position and altitude states are computed by direct integration of east, north, and up velocities.

### 9.3.1.2 Wind States

The horizontal wind magnitude and direction is pre-defined at each waypoint location and altitude. These are the forecast wind parameters. For a better representation of a real-world wind field, a random component is added to the forecast wind value for each waypoint and each aircraft. Therefore, subsequent aircraft flying over the same waypoint at the same altitude will experience somewhat different wind field. The waypoint winds are defined as:

$$\begin{bmatrix} W_{Speed} \\ W_{dir} \end{bmatrix}_{Forecast} \Rightarrow \begin{bmatrix} w_E \\ w_N \\ w_U = 0 \end{bmatrix}_{Forecast} \quad (77)$$

$$\begin{bmatrix} w_E \\ w_N \\ w_U = 0 \end{bmatrix}_{Total} = \begin{bmatrix} w_E \\ w_N \\ w_U = 0 \end{bmatrix}_{Forecast} + \begin{bmatrix} \Delta w_E \\ \Delta w_N \\ 0 \end{bmatrix}_{Random} \quad (78)$$

The random wind components do not change during the simulation execution. However, the implementation of the wind variation for different aircraft mimics a slowly varying random wind field affecting the flow of traffic. To ensure a continuously varying wind field from one waypoint to the next, a set of wind rate of change terms are computed. These rates are integrated to compute the instantaneous east and north wind components.

$$\begin{bmatrix} \dot{w}_E \\ \dot{w}_N \\ 0 \end{bmatrix} \Rightarrow \int \Rightarrow \begin{bmatrix} w_E \\ w_N \\ 0 \end{bmatrix} \quad (79)$$

When traveling towards waypoint  $i$ , the instantaneous rate of change of east and north wind velocities are computed using the following relationship relating the current east and north winds and total wind velocity defined at the waypoint.

$$\begin{aligned} \dot{w}_E &= \frac{w_{E_i} - w_{E_{current}}}{d_{AlongTrack}} \cdot V_{AlongTrack} \\ \dot{w}_N &= \frac{w_{N_i} - w_{N_{current}}}{d_{AlongTrack}} \cdot V_{AlongTrack} \end{aligned} \quad (80)$$

The terms  $d_{AlongTrack}$  and  $V_{AlongTrack}$  are the instantaneous along-track distance-to-go and along-track inertial velocity of the ownship to the current destination waypoint.

### 9.3.2 Aircraft Outputs and Measured Parameters

The integrated aircraft states corrected for initial conditions constitute the output vector. The aircraft output vector is the input to the sensor model. The sensor model output vector is the aircraft output parameters adjusted for sensor error, uncertainty, and dynamics. The measured parameter vector is based on the sensor output vector with additional derived parameters, such as indicated and true airspeeds, Mach number, density, and speed of sound.

#### 9.3.2.1 Sensor Model Error and Uncertainty

The modeled sensor outputs include errors and uncertainties that affect the basic navigation and guidance of the aircraft as well as RIMP TTG estimate and speed control functions. The model

includes a complete list of parameter uncertainties and has the ability to vary them deterministically or randomly to accommodate different types of analyses.

A general sensor formulation includes the following components:

- 1- Scale factor correction (nominal = 1)
- 2- Bias correction (nominal = 0)
- 3- Measurement noise (nominal mean = 0, appropriate variance)
- 4- Measurement dynamics. This is essentially the sensor noise attenuation ability. For simplicity, two first-order lag filters with appropriate time constants are placed in series and filter the added noise signal.
- 5- Upper and lower measurement limits (sensor-dependent)
- 6- Signal quantization, defining the resolution of digital signals and effective resolution of analog signals or gauges.
- 7- A pure time delay is added to the signal to account for processing delays associated with multiple digital avionics components that are integrated in a typical aircraft. Additionally, this term can be used to represent an overall lag associated with control actuation and aircraft response.
- 8- For certain signals such as GPS-based position estimates, the typical long term drifts can be modeled using a properly configured random walk signal.

The overall form for each sensor is represented as:

$$v_m(t) = \text{delay} \left( \text{discrete} \left\{ \left[ \text{bias} + SF \cdot v(t) + \text{noise} \right]_{\text{lowlimit}}^{\text{uplimit}} + \text{random\_walk} \right\} \right) \quad (81)$$

The sensor output vector consists of the following parameters:

- 1- Measured inertial velocity in Meters per second
- 2- Measured ground track in Radians
- 3- Measured vertical flight path angle in Radians
- 4- Measured East wind in Meters per second
- 5- Measured North wind in Meters per second
- 6- Measured outside air temperature in degrees Kelvin
- 7- Measured static pressure in Millibars
- 8- Measured East distance from reference coordinates in Meters
- 9- Measured North distance from reference coordinates in Meters
- 10- Measured altitude (MSL) in Meters

### 9.3.2.2 Temperature and Pressure Prediction Uncertainty

The forecast pressure and temperature as a function of position, altitude, and time is provided in the RUC atmospheric data. This data is used to develop the flight plan which is then executed by the RIMP model. Since flight operation is conducted with constant Mach number or constant equivalent (or indicated) airspeed, variation between the predicted and actual local air

temperature and pressure will result in a difference between the predicted and actual true airspeed and thus the predicted ground speed of the aircraft. The temperature and pressure uncertainty terms are not currently implemented in the simulation model. The aircraft is exposed to continually varying temperature and pressure based on the forecast values. However, small changes from the forecast will be observed in measured temperature and pressure values due to sensor uncertainties described above.

### 9.3.2.3 Airspeed and Mach Calculations

The true airspeed signal is computed from the total inertial velocity and the instantaneous wind vector using the following equation.

$$TAS(t) = \sqrt{\left((V_E + W_E)^2 + (V_N + W_N)^2 + (V_U)^2\right)} \quad (82)$$

As described in the equations of motion section (9.3.1.1), the instantaneous wind vector is computed by integrating wind acceleration terms. The current formulation essentially provides a linearly varying wind from one waypoint to the next. At each waypoint, the total wind vector consists of the forecast wind plus a random wind uncertainty or error term that is constant and determined at the beginning of the simulation run.

The local speed of sound in meters per second is computed based on the measured outside air temperature.

$$C(t) = \sqrt{\gamma \cdot R \cdot T} \quad (83)$$

Assuming dry adiabatic air properties,  $\gamma=1.4$ ,  $R=287.05$  (N.m)/(Kg.°K), and T is temperature in degrees Kelvin. The local density in kilogram per cubic meter is computed based on the measured outside air temperature and pressure

$$\rho(t) = \frac{P\left(\frac{N}{m^2}\right)}{R\left(\frac{N \cdot m}{Kg \cdot ^\circ K}\right)T(^{\circ}K)} \quad (84)$$

The atmospheric pressure data is provided in millibars and the above equation is multiplied by 100 to account for that unit. The aircraft Mach number is calculate using the following equation.

$$M = \frac{TAS}{C} \quad (85)$$

The indicated or equivalent airspeed is computed as:



$$IAS = TAS \cdot \sqrt{\frac{\rho}{1.2250}} == TAS \cdot \sqrt{\sigma} \quad (86)$$

### 9.3.3 Navigation Calculations

The navigation module monitors the progress of the aircraft along its flight plan, sequences the flight plan waypoints, and directs the aircraft to follow a straight path or turn to a specified new direction. An extended description of the navigation module is provided here.

A special case for the navigation model is given when the aircraft arrives at the runway. Upon arriving over the runway touchdown point, the navigation system commands the appropriate deceleration and rotates the aircraft to a zero vertical flight path angle. This special case is described later in this section. The normal flight operation is described first.

The navigation module treats the flight plan to be executed as a sequence of flight segments. Each segment is defined with an origin waypoint and a destination waypoint. These waypoints or “trajectory change points” (TCP) include a latitude, longitude, altitude, and speed. The speed to fly the segment is the true airspeed defined at the destination waypoint. It is assumed that the aircraft will decelerate or accelerate at a pre-defined level to achieve and maintain the specified true airspeed. The line connecting the origin and destination waypoint defines the course heading, glideslope, and absolute segment length. In general, the aircraft will attempt to fly as close as possible to this line.

The navigation module monitors the progress of the flight and retains a memory of which segment of flight is completed and which waypoints are sequenced. Therefore, the current segment number is a “state” parameter for the navigation module and this memory is used to select the appropriate flight plan information during execution of the flight.

During normal operation (when the aircraft has not arrived at the touchdown point on the runway), the navigation mode operates in one of two modes: TRACK or TURN. The module retains a memory of in which operating mode it is and this mode is only changed when the appropriate set of requirements are met. Figure 41 provides a pictorial example of the origin and destination waypoints defining a segment. The blue segments indicate that the navigation mode is TURN, and the orange line indicates where the navigation mode is in TRACK.

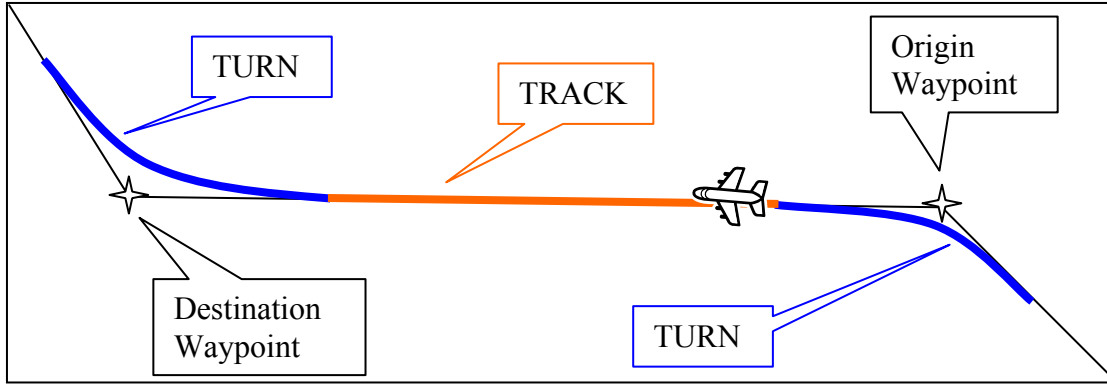

Figure 41 – Flight Segment and Navigation Modes

### 9.3.3.1 TRACK Mode

When operating in TRACK mode, the “desired” turn rate is set to zero and the “desired” track angle is set to the segment course. This combination is used by the guidance and control module to attempt to zero the cross-track error computed by the navigation module. Figure 42 depicts the segment length ( $D_{segment}$ ), cross-track error (CTE), and along-track distance-to-go (ATD2G) geometries.

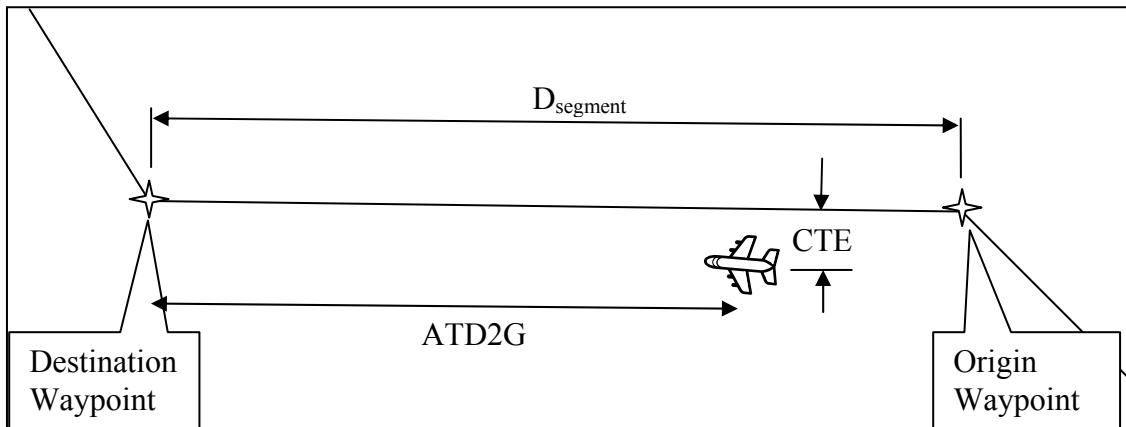

Figure 42 – TRACK Mode Parameters

$$D_{seg} = \sqrt{((E_{dest} - E_{orig})^2 + (N_{dest} - N_{orig})^2)} \quad (87)$$

$$ATD2G = \frac{(N_{dest} - N_{A/C}) \cdot (N_{dest} - N_{orig}) - (E_{dest} - E_{A/C}) \cdot (E_{dest} - E_{orig})}{D_{seg}} \quad (88)$$

$$CTE = \frac{(E_{dest} - E_{A/C}) \cdot (N_{dest} - N_{orig}) - (N_{dest} - N_{A/C}) \cdot (E_{dest} - E_{orig})}{D_{seg}} \quad (89)$$

The cross-track error is positive when the course path is on the right side of the aircraft and a right turn is required to correct for it.

When the aircraft is operating in the TRACK mode, the navigation module computes the required distance before reaching the destination waypoint at which point a turn to a new course is necessary. This calculation depends on the current groundspeed of aircraft, the nominal rate of turn specified in the “constants” file, and the total change of course required. The nominal turn radius is computed as:

$$R_{turn} = \frac{V_{GS}}{\dot{\chi}_{nominal}} \quad (90)$$

The required turn angle is the rectified difference between the next segment course and the current aircraft track angle. The rectified difference provides a result between  $-\pi$  and  $+\pi$ . It should be noted that both the segment course and aircraft ground track are rectified between 0 and  $2\pi$  (0 to 360 degrees) as measured from true North. The magnitude of the turn angle is limited to 150 degrees. This is consistent with airline flight operations. Figure 43 provides a pictorial presentation of the required distance before the waypoint to start the turn.

$$\Delta\chi = \text{rect}(\chi_{seg+1} - \chi_{A/C}) \quad (91)$$

$$d_{before} = \frac{R_{turn} \cdot \sin(|\Delta\chi|)}{1 + \cos(|\Delta\chi|)} \quad (92)$$

When the aircraft reaches the required turn before the waypoint, the navigation system will set the mode state to TURN. At this point, the reference groundspeed is set to the current groundspeed. This parameter is needed in the memory in order to maintain the turn radius constant as groundspeed changes due to varying wind impact on the aircraft. In addition, the “Start Capture” flag is set to TRUE, the “desired” turn rate is set to the nominal value, and the “desired” final track angle is set to the next segment course.

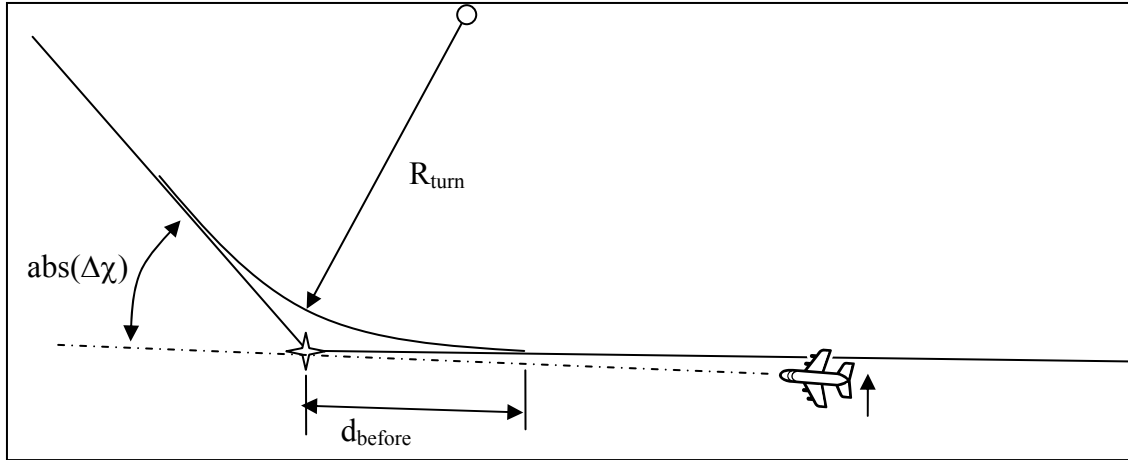

Figure 43 – Required Distance for Turn to New Course

### 9.3.3.2 TURN Mode

When the navigation module is in TURN mode, the along-track distance-to-go or cross-track error parameters are not used for navigation or guidance. Instead, a turn radius is computed based on the reference groundspeed set prior to switching to TURN mode. This procedure ensures that the system maintains a constant radius of turn through the course capture procedure. The desired turn rate is then scaled based on the current groundspeed measurements as time progresses and the aircraft changes its orientation.

$$R_{turn} = \frac{V_{GS\_reference}}{\dot{\chi}_{no\ min\ al}} = \frac{V_{GS\_current}}{\dot{\chi}_{desired}} \quad (93)$$

Continually varying the desired turn rate to maintain the turn radius ensures accurate intercept and merging with the next segment course. When the magnitude of the difference between the desired final track angle and current aircraft track angle is less than a tolerance value set in the “Constants” file, the navigation mode is switched to TRACK and the desired track is set to the current segment course.

### 9.3.3.3 Waypoint Sequencing Computations

While the aircraft executes segment  $i$  of the flight plan, it is traveling from waypoint  $i-1$  to waypoint  $i$ . The waypoint capture criteria depend on the mode of the navigation system.

When in TRACK mode, if the direct distance to the waypoint is less than a set value (defined in the “constants” file) the waypoint is flagged as “captured”. Otherwise, a check is made to see if the missed waypoint conditions are met. If the waypoint is missed, the waypoint is considered complete and the segment number is sequenced. Otherwise, the navigation module continues along the current segment. The missed waypoint logic compares the current aircraft bearing with the segment course. If the rectified difference between these angles exceeds 85 degrees and the waypoint has not been captured yet, it flags it as a missed waypoint.

$$Bearing = \tan^{-1} \left( \frac{E_{dest} - E_{A/C}}{N_{dest} - N_{A/C}} \right) \quad (94)$$

$$missed\_waypoint = |rectify(\chi_{seg} - Bearing)| > 85^\circ$$

When in TURN mode, a waypoint is considered captured when the aircraft track reaches halfway through the total planned turn. For example, if the aircraft was turning from a ground track of 220 to 300 degrees, the waypoint is considered captured once the ground track reaches 260 degrees. Figure 44 depicts the capture geometry in TURN mode.

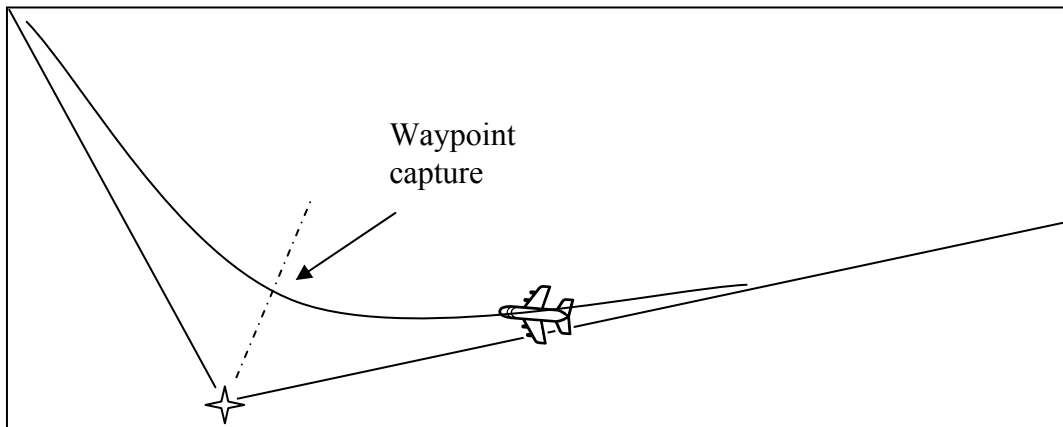

Figure 44 – Waypoint Capture in TURN Mode

The logic is configured such that the segment sequencing is completed once during over-flight of a waypoint or during turn to a new direction. Therefore, addition of noise in the position and velocity signals will not affect the waypoint sequencing logic.

#### 9.3.3.4 Corrected Segment Length

The lateral navigation parameters described above rely on a segment length defined by the actual horizontal distance between adjoining waypoints. In the general case where the aircraft starts a turn prior to reaching each waypoint, the actual distance traveled by the aircraft as it covers the planned trajectory is slightly less than the full distance between fly-by waypoints. This difference in distance covered affects the vertical navigation calculations and time-to-go estimation which will be covered later in this section. Both of these issues can be addressed through the introduction of a corrected segment length concept.

Figure 45 provides a description of the geometry being considered. The flight plan switches to segment  $i$  halfway during the turn into the current segment and will switch to the next segment halfway through the turn to the next segment.

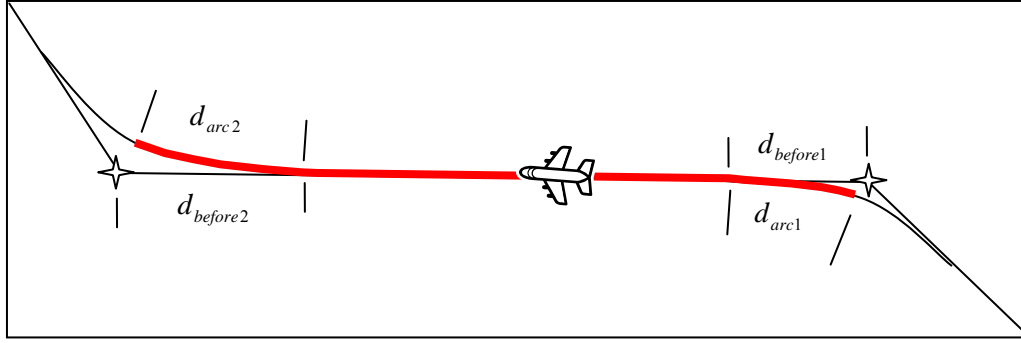

**Figure 45 – Corrected Segment Length**

The corrected segment length consists of the arc lengths at the start and the end of each segment plus the linear distance in-between. The total length is always slightly less than the linear distance between fly-by waypoints. To perform this calculation a nominal rate of turn is computed based on planned average groundspeed of the aircraft as it covers the entire segment. It is understood that uncertainty in actual wind will introduce an error into this equation. However, this allows providing a first-order approximation to the segment length problem. Since the planned ground speed may be very different between the start and end turns on each segment, two separate turn radii are defined.

$$R_{turn1} = \frac{V_{GS\_plan1}}{\dot{\chi}_{nominal}} \quad (95)$$

$$R_{turn2} = \frac{V_{GS\_plan2}}{\dot{\chi}_{nominal}}$$

The planned groundspeed is based on the planned Mach number or indicated airspeed, forecast wind speed and forecast wind direction at the closest waypoints. Using the forecast air temperature and pressure at each waypoint an estimate of true airspeed can be calculated. The true airspeed is then used to arrive at the planned ground speed. The turn angle and distance before (and after) the waypoints and associated arc lengths are computed below.

$$\Delta\chi_1 = \text{rect}(\chi_{seg} - \chi_{seg-1}) \quad (96)$$

$$\Delta\chi_2 = \text{rect}(\chi_{seg+1} - \chi_{seg})$$

$$d_{before1} = \frac{R_{turn1} \cdot \sin(|\Delta\chi_1|)}{1 + \cos(|\Delta\chi_1|)} \quad (97)$$

$$d_{before2} = \frac{R_{turn2} \cdot \sin(|\Delta\chi_2|)}{1 + \cos(|\Delta\chi_2|)}$$

$$d_{arc1} = 0.5 \cdot R_{turn1} \cdot |\Delta\chi_1| \quad (98)$$

$$d_{arc2} = 0.5 \cdot R_{turn2} \cdot |\Delta\chi_2|$$

The corrected segment length is defined as:

$$D_{seg\_corr} = D_{seg} - d_{before1} - d_{before2} + d_{arc1} + d_{arc2} \quad (99)$$

Similarly, a corrected along-track distance needs to be computed to go based on the simple linear ATD2G computed above. This can be approximated by comparing the linear ATD2G value with the segment lengths computed above and taking into account the current ground track offset from the segment course.

If  $ATD2G > D_{seg} - d_{before1}$ , the aircraft is still turning to intercept the segment course. The difference between current track and segment course is used to compute the appropriate arc length.

$$\Delta\chi = \text{rect}(\chi_{seg} - \chi_{A/C}) \quad (100)$$

$$d_{arc} = R_{turn1} \cdot |\Delta\chi| \quad (101)$$

$$ATD2G_{corr} = D_{seg} - d_{before1} - d_{before2} + d_{arc} + d_{arc2} \quad (102)$$

If  $ATD2G > D_{seg} - d_{before1} - d_{before2}$ , the aircraft is on the straight section of the segment and has not yet started its turn to the next track. The corrected along-track distance-to-go is computed as:

$$ATD2G_{corr} = ATD2G - d_{before2} + d_{arc2} \quad (103)$$

If  $ATD2G < d_{before2}$ , the aircraft has started its turn to the next track. The corrected along-track distance-to-go is computed as:

$$\Delta\chi = \text{rect}(\chi_{A/C} - \chi_{seg}) \quad (104)$$

$$d_{arc} = R_{turn2} \cdot |\Delta\chi| \quad (105)$$

$$ATD2G_{corr} = d_{arc2} - d_{arc} \quad (106)$$

### 9.3.3.5 Vertical Navigation

The vertical navigation parameters include the vertical flight path angle and a glide slope deviation. The vertical flight path angle is the angle in the vertical plane for a line connecting

the origin waypoint to the destination waypoint. Assuming a straight-in flight profile between the origin and destination waypoints, the desired flight path can be written as:

$$\gamma_{seg} = \tan^{-1}\left(\frac{Alt_{dest} - Alt_{orig}}{D_{seg}}\right) \quad (107)$$

The instantaneous glideslope deviation is a measure of vertical distance above or below the nominal vertical flight path line described above. Given the current along-track position of the aircraft (along-track distance-to-go on the current segment) and the current altitude, the following equation computes the glideslope error. If the current altitude of the aircraft is below the glideslope, the error will be positive and a positive increase in the aircraft flight path angle will be required.

$$GSE = Alt_{dest} - Alt_{A/C} - ATD2G \cdot \left(\frac{Alt_{dest} - Alt_{orig}}{D_{seg}}\right) \quad (108)$$

The dependency of this calculation on the assumed segment length and along-track distance-to-go is evident. As described above, when the aircraft turns to intercept a new flight plan segment, it effectively shortens the segment length and alters the along-track distance-to-go. Therefore, an apparent glideslope error (GSE) will be experienced during such turn maneuvers. The current version of the RIMP simulation model does not fully correct for this apparent error. This error is small when total ground track angle changes less than 90 degrees.

### 9.3.3.6 Landing Mode Operations

Once the aircraft arrives over the touchdown waypoint, a special set of modified navigation equations are used to command the aircraft to stop on the runway.

In the lateral axis, the desired track is set equal to the segment course. This course is the same as the previous segment course. The desired turn rate is set to zero and the cross-track error is also set to zero.

In the vertical axis, the desired vertical path is set to zero and the glideslope error is also set to zero. It should be noted that typically, the final approach segment has a vertical glideslope angle of -3 degrees. Therefore, the navigation system will command the aircraft flight path angle to be increased to zero.

The desired segment airspeed is set to zero for the landing operation, and the along-track speed is set to the current aircraft speed. Within the guidance and control module, the speed specification during landing is interpreted as slowing the aircraft to zero groundspeed. Therefore, in the presence of non-zero surface wind, the aircraft will retain a non-zero airspeed.



### 9.3.4 Guidance and Control Calculations

The guidance and control module compares the current measured aircraft states and navigation module outputs to derive acceleration and angular rate commands. The module uses several guidance and control gains that are specified in the “constants” data file.

#### 9.3.4.1 Airspeed Control

Depending on the mode of operation the aircraft will be commanded to maintain a constant Mach number or maintain a constant indicated airspeed. In either case, the aircraft must stay within a specified indicated airspeed (or dynamic pressure) range. As a result, during the early stages of descent, the aircraft will maintain a Mach number in the descent until the indicated airspeed reaches the nominal high value. The aircraft will then maintain this nominal value until reaching the destination waypoint of the current segment.

The above behavior will result in a continually increasing true airspeed until the desired dynamic pressure is reached. After this, the true airspeed will be continually decreasing as the aircraft descends. Since the RIMP operation model computes the instantaneous pressure, temperature, density, and speed of sound, the commanded Mach number or commanded indicated airspeed can be related to an instantaneous commanded true airspeed. The total airspeed command includes a RIMP airspeed increment. The total airspeed is limited within the indicated airspeed upper and lower limits set for each aircraft type as a function of aircraft altitude (or Flight Level). If the speed command is less than 1.1, it is assumed that a constant Mach number is commanded.

$$IAS_{plan} = M_{cmd} \cdot c \cdot \sqrt{\sigma} \quad (109)$$

Otherwise, it is assumed that a constant indicated airspeed is commanded. The RIMP speed increment is then added to the resulting indicated airspeed command, and the result is limited before converting back to an instantaneous true airspeed signal. Figure 46 depicts the airspeed control system.

$$\begin{aligned} KIAS_{min} &= f(Alt) \\ KIAS_{max} &= f(Alt) \\ IAS_{cmd} &= [IAS_{plan} + \Delta IAS_{RIMP}]_{IAS_{min}}^{IAS_{max}} \\ TAS_{cmd} &= IAS_{cmd} / \sqrt{\sigma} \end{aligned} \quad (110)$$

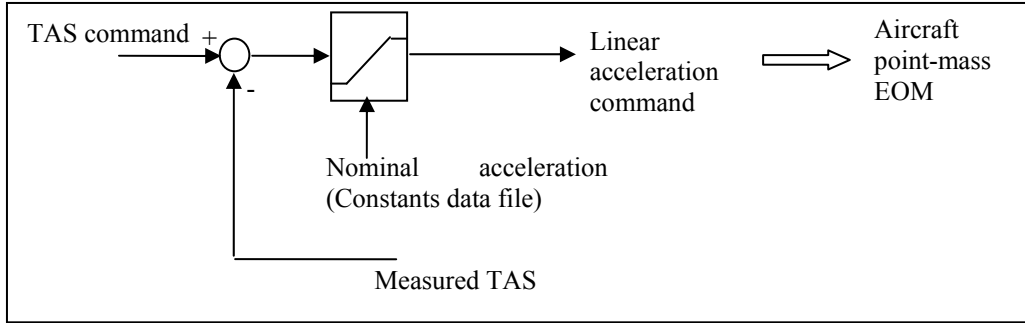
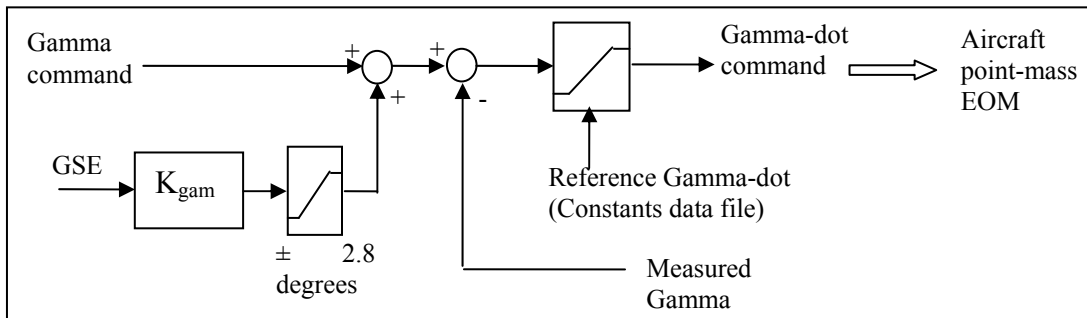

**Figure 46 – True Airspeed Control System**

Additional logic within the acceleration limiter block ensures that the system inhibits zero-crossing within an update frame when the airspeed error signal is very small.

### 9.3.4.2 Vertical Flight Path Control

The total vertical flight path command consists of the planned vertical flight path angle plus corrections needed to zero the computed glideslope error (GSE). To mimic typical aircraft operations, the flight path correction angle is limited to  $\pm 2.8$  degrees of the nominal value. Figure 47 depicts the vertical flight path control system.



**Figure 47 – Vertical Flight Path Control System**

Additional logic within the flight path rate limiter block ensures that the system inhibits zero-crossing within an update frame when the flight path error signal is very small.

### 9.3.4.3 Lateral Path Control

When the navigation module operates in TRACK mode, a desired track angle and a cross-track correction angle are provided to the guidance and control module. The controller attempts to fly the aircraft to zero the cross-track error (CTE). A track correction angle  $\Delta\chi_{corr}$  is computed using the following equation.

$$\Delta\chi_{corr} = \sin^{-1} \left( \sqrt{\frac{|CTE|}{2 \cdot R_{turn}}} \right) \cdot \text{sign}(CTE) \quad (111)$$

The turn radius in the above equation is computed based on the current ground speed and a maximum bank angle of 10 degrees (Appendix A). The controller attempts to zero the error between the measured ground track and the sum of desired track and the track correction angle. Figure 48 depicts the lateral control system when operating in TRACK mode. To ensure correct operation, the sum of desired track angle and track correction angle must be rectified between 0 and 360 degrees as measured from true North (0 to  $2\pi$ ). In addition, the subtraction of measured and total commanded angles must be put through an “error rectifier” algorithm to properly rectify the difference between  $-\pi$  and  $+\pi$ .

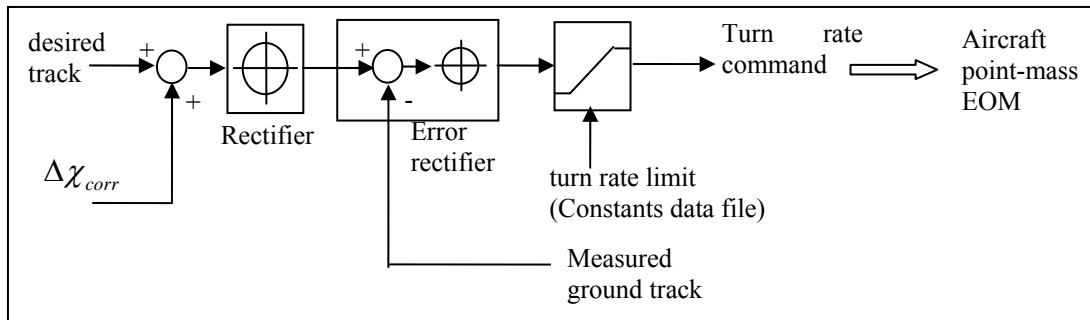

**Figure 48 – Lateral Control System in TRACK mode**

The limited turn rate signal shown is the smaller of the reference turn rate and a turn rate that would result in a 10 degrees bank angle at the current groundspeed. Additional logic within the turn rate limiter block ensures that the system inhibits zero-crossing within an update frame when the track error signal is very small.

When the navigation module operates in TURN mode, a desired turn rate and a desired final track angle are provided. The difference between the desired track angle and current measured ground track is put through an error rectifier circuit to define the proper direction of turn. The sign of this signal is then applied to the desired turn rate supplied by the navigation module to create the turn rate command sent to the equation of motion.

#### **9.3.4.4 Operation while Landing**

During landing operation, the controller operates in a special mode. The speed control switches to using groundspeed and attempts to zero the groundspeed. The maximum deceleration limit is increased to 2.0 meters per second or 0.2 g's. The vertical flight path controller attempts to zero the vertical flight path angle at an increased rate of 2.8 degrees per second. Finally, the turn rate command is set to zero and no attempt is made to “stay on the runway”. Since the intent of the RIMP simulation model is the flight portion, this landing arrangement provides an adequate termination condition and not necessarily an accurate landing model for the air vehicles.

### **9.4 TTG Estimation**

The TTG estimation function is required for the RIMP operation. TTG calculations can be performed for both the ownship and the reference aircraft.

### 9.4.1 Velocity Profile and Associated Assumptions

For calculating estimated time of travel or time to go on a segment an estimate of the ground speed is needed. As described in the earlier sections, the typical speed command will be either a constant Mach number or a constant indicated airspeed. A typical segment is 15 nautical miles or less and wind variation within a level altitude segment is considered relatively small. It is therefore reasonable to assume that the velocity profile for such a level segment follows an “accelerate and hold” behavior. This means that while executing the current segment, the aircraft will accelerate or decelerate from the velocity specified for previous segment  $i-1$  using a known constant acceleration to the velocity specified for the current segment  $i$ . This is depicted in Figure 49 – Assumed velocity profile for level segments. In addition, it is assumed that the algorithms used to generate the flight plan provide adequate segment length so that the required acceleration/deceleration can be accommodated in the current segment.

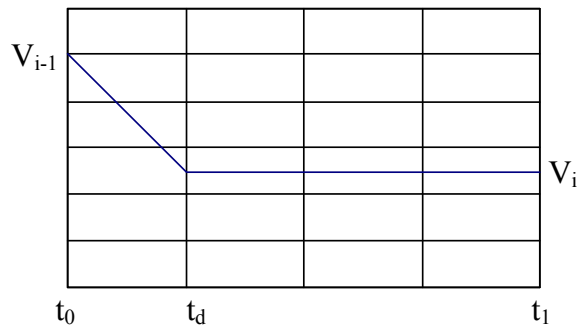
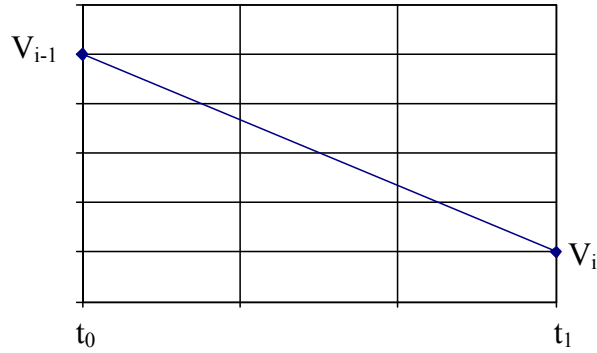

Figure 49 – Assumed velocity profile for level segments

However, in the case of descending flight, a constant Mach number will result in a continuously increasing true airspeed and a constant indicated airspeed will result in a continuously decreasing true airspeed. In addition, it is normal to experience significant wind variation as a function of altitude. Therefore, during descents it is typical to experience an almost linearly varying true airspeed and ground speed as the aircraft proceeds to the current destination waypoint.

This is a very different velocity profile from the one described for level segments. For simplification it is necessary to assume that the resulting inertial velocity is linearly changing from one waypoint (position and altitude) to the next. This velocity profile is depicted in Figure 50.



**Figure 50 – Assumed velocity profile for descent segments**

Based on historical and empirical data as well as aeronautical standards for passenger comfort the following acceleration/deceleration levels during maneuvering are anticipated:

Comfortable level:	<0.315 [m/s <sup>2</sup> ]	or <0.032 [g]
Slightly uncomfortable:	0.315 – 0.63 [m/s <sup>2</sup> ]	or 0.032 – 0.064 [g]

Maintaining a constant acceleration both in the vertical (z) and horizontal (x, y) axes during flight operation is generally considered necessary for passenger comfort. For the purpose of this study, a constant acceleration for each speed change maneuver is assumed, and it is assumed that this acceleration is a known or pre-defined value. The general case would associate a constant acceleration with a given flight plan segment. An additional simplifying assumption is made for this version of study is to fix the acceleration to a given value. So, all speed changes are performed using a constant known acceleration referred to as  $a_{ref}$ . Possible variations in acceleration are considered as uncertainty in the model.

The along-track acceleration and inertial velocity change occur as the aircraft changes heading (into and away from the wind) or descends or climbs into different wind. The guidance algorithms attempt to limit the commanded linear acceleration at the  $a_{ref}$  level. However, no attempt is made to limit the combined acceleration from the wind and the airspeed change. In the general case, a net acceleration slightly larger than the magnitude of the reference acceleration may be experienced. For the purpose of this analysis tool, the differences between commanded and achieved acceleration terms are considered as modeling uncertainty.

For the segment  $i$  of the trajectory, the velocity profile can be written as:

$$v_i(t) = V_{i-1} + \int_{t_0}^t a(t) \cdot dt \quad (112)$$

$$V_i = V_{i-1} + \int_{t_0}^{t_1} a(t) \cdot dt \quad (113)$$

$V_{i-1}$  is the previous desired inertial speed. The time  $t_0$  is the initial time for the integration. It is either the start time for the segment, or as will be discussed, it could be the current time of the calculations. The time  $t_1$  is the arrival-time at TCP number  $i$ .

Based on the previously discussed constant acceleration profile,

$$a(t) = \begin{cases} 0 \\ a_{seg} \end{cases} \quad (114)$$

The term  $a_{seg}$  is equal to the reference acceleration during level segments and is set equal to the required speed change during the segment for descending segments as described earlier. A default maximum value for this acceleration will be  $\pm 0.05$  [g]. With the above acceleration profile, the required time to accelerate or decelerate to the new commanded speed in the level segment can be written as:

$$(t_d - t_0) = \frac{1}{a_{ref}} (V_i - V_{i-1}) \quad (115)$$

In order to achieve the required or specified velocity  $V_i$  while still on the current segment of the trajectory, the following condition must hold:

$$(t_1 - t_0) \geq (t_d - t_0) \quad (116)$$

It is assumed that the planned trajectory being executed by this simulation correctly accommodates for time and distance to decelerate to the commanded airspeed. For the descending segments, the required acceleration is computed using the following relation.

$$a_{seg} = \frac{(V_i - V_{i-1})}{(t_1 - t_0)} \quad (117)$$

Note that the inertial velocity at each waypoint can be derived by subtracting the wind components from the planned true airspeed values. However, since it is assumed that the wind velocity varies linearly between the waypoints, the assumption of equation 36 will not apply if a large change in wind velocity or direction is introduced in a short trajectory segment. In addition, we assume that an average wind value for the entire segment provides sufficient fidelity to use in these simplified equations.

### 9.4.2 Distance and Time-to-Go Calculations

The segment length or distance to travel given the above velocity profile is written as:

$$R_i = \int_{t_0}^{t_1} v_i(t) \cdot dt \quad (118)$$

Substituting the above velocity profile, the following closed-form solution can be derived

$$R_i = V_i \cdot (t_1 - t_0) - \frac{1}{2a_{seg}} (V_i - V_{i-1})^2 \quad (119)$$

Define a trajectory segment time as the difference between the initial and final on the segment. All “time” parameters are in seconds.

$$T_i = (t_1 - t_0) \quad (120)$$

The time of travel for each segment can therefore be written as:

$$T_i = \frac{1}{V_i} \left( R_i + \frac{1}{2a_{seg}} (V_i - V_{i-1})^2 \right) \quad (121)$$

Note that the velocity terms here are inertial velocities in the horizontal plane (groundspeed). The remaining time on segment  $k$  is written as:

$$T_{current} = \frac{1}{V_k} \left( R_{current} + \frac{1}{2a_{seg}} (V_k - v_m)^2 \right) \quad (122)$$

The total time to go (TTG) to the spacing point is calculated as:

$$TTG = T_{current} + \sum_{i=k+1}^n T_i \quad (123)$$

The spacing time is computed as:

$$Spacing = TTG_{ownership} - TTG_{refA/C} \quad (124)$$

### 9.4.3 TTG Algorithms

#### 9.4.3.1 Current Segment Calculations

The current segment index is denoted as  $k$ . The current inertial velocity in the along-track direction is  $v_{AT}$  and is provided by the navigation module. The current velocity command is  $V_{cmd}$ , which is derived from the planned true airspeed and average forecast winds along the current segment. It is also resolved in the along-track direction.

The navigation module computes the remaining distance on the current segment. To account for the turns at the start and end of each segment, a corrected along-track distance to go parameter is computed. This corrected value is used here.

$$R_{current} = ATD2G_{corr} \quad (125)$$

The time of travel remaining on the current segment is computed using the following equation.

$$T_{current} = \frac{1}{V_k} \left( R_{current} + \frac{1}{2a_{seg}} (V_k - v_{AT})^2 \right) \quad (126)$$

#### 9.4.3.2 Subsequent Segment Calculations

The next segment index is denoted as  $k+1$ . The velocity and time of travel calculations for the next segment is comparable to the current segment. The remaining distance on the segment is equal to the total length of the segment. Again, the corrected segment length is used for this calculation.  $V_{k+1}$  is the flight plan groundspeed based on specified true airspeed and forecast wind components.

$$R_{K+1} = D_{seg\_corr} \quad (127)$$

$$T_{k+1} = \frac{1}{V_{k+1}} \left( D_{seg\_corr} + \frac{1}{2a_{seg}} (V_{k+1} - V_k)^2 \right) \quad (128)$$

### 9.5 RIMP Speed Control

Although the design of a RIMP control system is not the intent of this effort, at least a simplified functioning control system is required to manipulate the RIMP environment and assess the sensitivity of various components to uncertainties, errors, and perturbations. A simple RIMP control described below consists of a minimum speed change calculation used as a scaling parameter followed by calculation of the required speed change and associated logic.



### 9.5.1 Minimum Required Speed Change

The minimum required speed change is a calculated speed change based on the current estimate of the spacing error and current time-to-go of the reference aircraft. It defines a speed change which if started instantly and applied up to the interval management point, will adjust the spacing interval by the time the reference aircraft arrives at the interval management point. This provides for the longest duration allowed for the speed change to adjust the interval time. As expected, when the aircraft is far from the spacing point, the calculated minimum speed change will be very small. As the aircraft approaches the reference point, the minimum speed change value will increase. Therefore, it can be seen that the minimum speed change is akin to a scaling parameter for the RIMP operation. Instead of using the distance to the reference point, the simplified equations use the TTG of the reference aircraft for this measure.

The along-track distance to go must be flown at either a nominal speed or at the nominal speed plus a speed increment. For this calculation it is assumed that the current aircraft ground speed is the nominal value to fly the rest of the plan.

$$ATD2G = V_{measured} \cdot TTG_{own-nominal} = (V_{measured} + \Delta V_{min}) \cdot (TTG_{own-nominal} + \Delta TTG) \quad (129)$$

Assuming a general speed trend of faster speed to slower speed during RIMP operation, a simplified but conservative solution can be derived based on the current speed of ownship, time-to-go of the reference aircraft, and the spacing error. This solution is conservative since the current speed used in the above equation is equal or faster than the speed used in the planned trajectory. Therefore, the estimated TTG adjustment is equal or less than what is achievable in the course of the flight.

The simplified equations do not work at the limit when the reference aircraft is very close to the RIMP reference point. However, assuming that  $(TTG_{refA/C} + T_{IM}) \gg 1$  second, the following minimum required speed change can be computed.

$$\Delta V_{min} = \frac{-V_{measured} \cdot (T_{IM} - (TTG_{own} - TTG_{ref}))}{(TTG_{refA/C} + T_{IM})} \quad (130)$$

The sign of the required speed change is negative for deceleration and positive for acceleration.

This value is significant since it has the longest time to impact the RIMP operation. If no action is taken as the paired aircraft proceed on their flight plans, the magnitude of the minimum required speed change will increase. Operationally, once a reasonable threshold value is reached, the minimum required speed change must become the speed change command, and should be used to re-negotiate the flight plan.

### 9.5.2 Nominal Speed Change

In the simplified RIMP control model, the nominal speed change is computed as the speed change to resolve the current spacing error in 600 seconds.

$$\Delta V_{nom} = \frac{-V_{measured} \cdot (T_{IM} - (TTG_{own} - TTG_{ref}))}{600} \quad (131)$$

The required speed change is the larger of the nominal and minimum speed change values.

$$\Delta V_{IM} = sign(\Delta V_{nom}) * \max(|\Delta V_{nom}|, |\Delta V_{min}|) \quad (132)$$

The resulting speed change is then passed through a speed change logic (described below) to quantize the speed change events. The result is then multiplied by the speed change factor to generate the commanded change in speed, and in this particular case, change in true airspeed of the aircraft. This commanded speed change does not take into account if the aircraft is operating at the specified airspeed limit. The guidance module limits the sum of planned and RIMP commanded airspeed.

### 9.5.3 Speed Change Logic

To ensure that the RIMP speed command is engaged in a pseudo-discrete sense and to minimize the nuisance occurrence of speed change events the following simplified logic has been implemented. A RIMP speed logic state is defined in the memory. It is currently setup to include two speed-up steps, three slow-down steps and a null step. Figure 51 provides a logic flow diagram for the speed change algorithm.

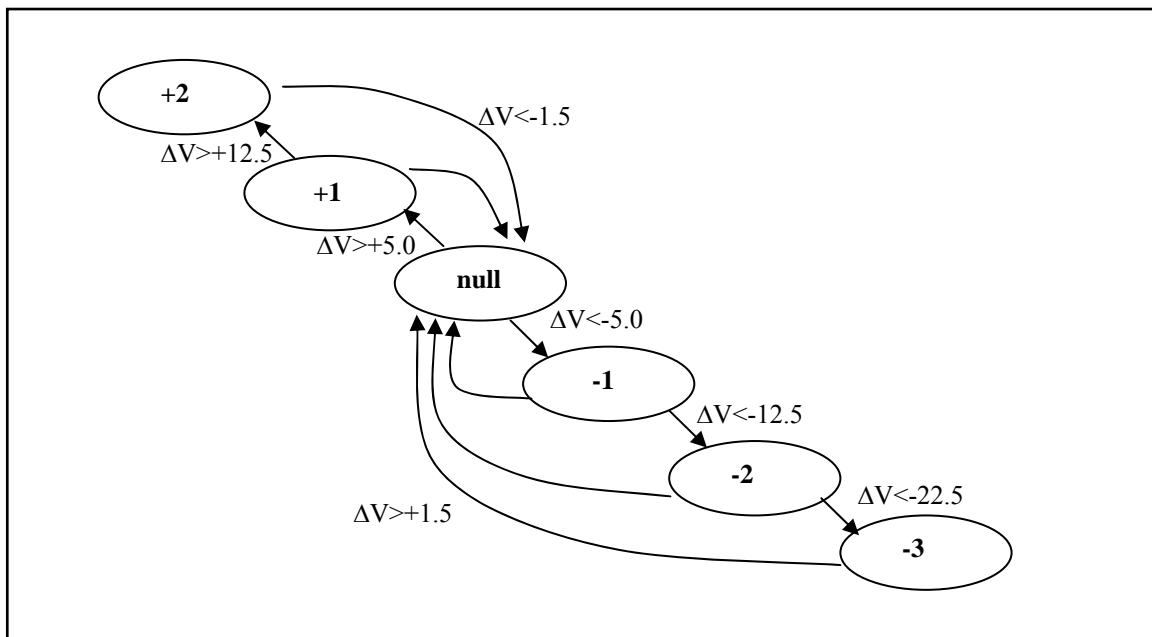

Figure 51 – Speed Change Logic

When the logic state is in the null mode, the speed change command is set to zero. If the “IM speed change” described above becomes greater than 5.0, the logic mode is switched to “+1 Speed-Up”. If the speed change drops below -5.0, the logic mode is switched to “-1 Slow-Down”.

When the logic state is in “+1 Speed-Up” mode if the IM speed change drops below -1.5, the mode is switched to null. If the IM speed change increases past +12.5, the mode is switched to +2 Speed-Up.

When the logic state is in +2 Speed-Up mode if the IM speed change drops below -1.5, the mode is switched to null.

When the logic state is in -1 Slow-Down mode if the IM speed change drops below -12.5, the mode is switched to “-2 Slow-Down”. If the IM speed change increases past +1.5, the mode is switched to null.

When the logic state is in “-2 Slow-Down” mode if the IM speed change drops below -22.5, the mode is switched to “-3 Slow-Down”. If the IM speed change increases past +1.5, the mode is switched to null.

When the logic state is in “-3 Slow-Down” mode if the IM speed change increases past +1.5, the mode is switched to null.

The final RIMP speed command is set equal to the above mode number multiplied by the IM spacing multiplier specified in the “Constants” data file. Nominally, this multiplier is set to equal to 10 Knots. RIMP speed control is disabled when commanded spacing is set to zero, and upon reaching the reference waypoint.

## **9.6 Model Setup and Execution Procedures**

This section describes the steps in preparing the input and configuration data files, and details the execution of the RIMP simulation. The RIMP simulation model is coded in MATLAB/Simulink environment and is configured for specific analysis tasks. The description provided below is for a multi-aircraft scenario where continuous-descent arrivals are performed into Louisville, Kentucky.

### **9.6.1 Model Setup**

#### **9.6.1.1 Flight Plan Specification**

The “Flight Plan” is used to define the aircraft operation during the simulation. Multiple aircraft may use the same flight plan. This file is read by a MATLAB script and all text to the right of % sign is comment.

```

% Louisville BGEST CDA1
%
% Flight Plan Data File Version 3.0
% Waypoint ID number
% Waypoint type (1=enroute (default), 2=turn back, 3=land)
% Waypoint Latitude (degrees decimal)
% Waypoint Longitude (degrees decimal)
% Altitude at waypoint (feet, MSL)
% IAS/Mach at waypoint (Knots/Mach)
% Waypoint name
%
%-----
% #, Type, Latitude, Longitude, Altitude, IAS or M, Name
%-----
FP = [
0 1 38.53117000 -91.63363900 37000 0.8 cellstr('start')
1 1 38.41999860 -89.15899780 37000 0.8 cellstr(' ENL')
2 1 38.38000000 -88.40000000 37000 0.8 cellstr('xxTOD')
3 1 38.37723889 -88.20648056 36000 0.8 cellstr('ZARDA')
4 1 38.32920278 -87.61643611 28000 0.8 cellstr('PRINC')
5 1 38.12002778 -86.40452778 11000 240 cellstr('BGEST')
6 1 38.01983055 -85.85327778 4600 190 cellstr('PTINO')
7 1 37.98333333 -85.75000000 4000 190 cellstr('BASKT')
8 1 38.02111111 -85.69444444 3000 180 cellstr('DNKIT')
9 1 38.06438889 -85.70835000 2400 170 cellstr('CRDNL')
10 3 38.16081600 -85.74017300 513 140 cellstr('RW35L')];

```

### 9.6.1.2 Atmospheric Data

The “Wind-Temperature-Pressure” file is pre-processed from the desired RUC data for the specific flight plan to be flown. It includes the East and North winds, outside air temperature, and static pressure at each waypoint location and altitude.

```

%
% Wind pressure and temperature data
% First column is waypoint number
% Second column is East wind in meters per second
% Third column is North wind in meters per second
% Fourth column is static pressure in millibars
% Fifth column is OAT in degrees Kelvin
%
0.0 -6.3341029e+001 -3.2106923e+001 2.1730000e+002 2.1923351e+002
1.0 -6.8598146e+001 -3.3449491e+001 2.1730000e+002 2.1831580e+002
2.0 -7.0793884e+001 -3.1034921e+001 2.1730000e+002 2.1809949e+002
3.0 -7.1651931e+001 -3.2510421e+001 2.2800000e+002 2.2015837e+002
4.0 -5.7738696e+001 -3.2149985e+001 3.2990000e+002 2.3670349e+002
5.0 -1.9763707e+001 -8.0108517e+000 6.6704391e+002 2.6876573e+002
6.0 -5.4049351e+000 -8.5042564e+000 8.5055624e+002 2.7791416e+002
7.0 -3.8262500e+000 -6.1950000e+000 8.6968250e+002 2.7832625e+002
8.0 -3.0130864e-001 -3.1112469e+000 9.0268727e+002 2.7755280e+002
9.0 3.7290236e+000 -2.1433883e+000 9.2352290e+002 2.7520866e+002
1.0 4.1435416e+000 8.3606477e-001 9.8653519e+002 2.7357225e+002
%

```

### 9.6.1.3 Aircraft Performance Models

The “Aircraft Limits” file is used to specify maximum and minimum airspeeds (indicated or equivalent airspeeds) in Knots as a function of altitude in Flight Level. These limits are used by the aircraft guidance and control algorithms to limit the commanded speeds when necessary. An additional “nominal” equivalent airspeed specified is used as a limiting speed during constant Mach descents. So, during such operation, when the equivalent airspeed reaches this nominal value, the speed is limited to maintain it. In this case, additional speed increase may still be commanded by the RIMP controller.

```
% AircraftLimits_767.m
% Airspeed limits for 767-200
%
% Altitude [ft], VMin [kts], VMax [kts]

FltLvl = [ 0, 50, 100, 120, 180, 240, 300, 340, 400];
MaxIAS = [ 200, 240, 250, 310, 330, 330, 330, 330, 330];
NomIAS = [ 150, 240, 250, 290, 310, 310, 310, 310, 310];
MinIAS = [ 110, 160, 170, 180, 190, 210, 210, 210, 210];
%
```

### 9.6.1.4 Aircraft Setup and Initialization Data

The following “Setup File” is used to specify the initial conditions, flight plan, aircraft limits, and wind information for each aircraft within the RIMP simulation. Each aircraft must have a unique copy of the Setup file. The numbers specified below are for example only and are adjusted for each specific application. This file is read by a MATLAB script and all text to the right of % sign is comment.

```

% AC_Setup_5.m
% Aircraft number 5.
%
FPfilename = 'FlightPlan_BGEST_CDA1';
WindTempFi = 'BGEST_CDA1_001.txt';
ALfilename = 'AircraftLimits_767';
Temp1 = [
error (TAS) [kts]                    0.          % Initial true airspeed
[Ft]                                  0.          % Initial altitude error
error [Nautical miles]                0.          % Initial east position
error [Nautical miles]                0.          % Initial north position
200.          % Start time offset [Seconds]
Sequence)                             5           % Aircraft number (ATC
aircraft (ATC Sequence)                4           % Assigned reference
10          % Assigned reference waypoint number
50. ]; % Nominal spacing time [Seconds]
%

```

### 9.6.1.5 Sensor Model Setup

The following sensor model parameters are specified in the *Sensor Parameter* data file. The numbers used in this example case are representative values. They do not represent a particular system implementation and are not aircraft specific.

In the current simulation setup all aircraft share the same sensor parameters. Future development of this model may change this to have sensor variations between different aircrafts.

```

% Sensor Number
% Scale Factor (SF)
% Bias
% Noise Signal Mean (Mean)
% Noise Signal Variance (Var)
% Filter Denominator coeff (change based on Tau and dt)
% Lower Limit (LLim)
% Upper Limit (ULim)
% Quantization Interval (Quant)
% Time Delay (tDel) [s]
%
% SF | Bias | Mean | Var | Tau | LLim | ULim | Quant | tDel
1, 0.0, 0.0, 0.0, 0.05, 0.990, 0.0, 400.0, 0.1, 0.10 % Inertial Speed [m/s]
2, 0.0, 0.0, 0.0, 0.0001, 0.990, -15.0, 15.0, 0.001, 0.01 % Ground track [rad]
3, 0.0, 0.0, 0.0, 0.0001, 0.990, -2.0, 2.0, 0.001, 0.01 % Gamma [rad]
4, 0.0, 0.0, 0.0, 0.05, 0.990, -250.0, 250.0, 0.01, 0.10 % Wind East [m/s]
5, 0.0, 0.0, 0.0, 0.05, 0.990, -250.0, 250.0, 0.01, 0.10 % Wind North [m/s]
6, 0.0, 0.0, 0.0, 0.05, 0.990, 160.0, 328.0, 0.1, 0.10 % OAT [degK]
7, 0.0, 0.0, 0.0, 0.1, 0.990, 50.0, 1090.0, 0.1, 0.01 % P static [mBar]
8, 0.0, 0.0, 0.0, 0.1, 0.990, -800000.0, 800000.0, 0.1, 0.10 % East Position [m]
9, 0.0, 0.0, 0.0, 0.1, 0.990, -800000.0, 800000.0, 0.1, 0.10 % North Position [m]
10, 0.0, 0.0, 0.0, 0.1, 0.990, -1000.0, 20000.0, 0.1, 0.10 % Altitude [m]
%

```

### 9.6.1.6 Model Constants

The following information is specified in the *Constants* data file. The numbers specified below are for example only and are adjusted for each specific application as required. This file is read by a MATLAB script and all text to the right of % sign is comment.

```
0.05 % 1- Reference linear acceleration [g]
1.5  % 2- Reference rate of turn [deg/sec]
0.5  % 3- Reference rate of vertical flight path [deg/sec]
100.0 % 4- Waypoint capture tolerance (meters)
1.0  % 5- Course track capture tolerance (deg)
10.0 % 6- Reference RIMP Delta Velocity (Delta V Reference) [kts]
0.0  % 7- Reserved
0.0  % 8- Reserved
0.01 % 9- Flight path correction constant (deg/m)
0.0  % 10- Reserved
0.0  % 11- Reserved
0.0  % 12- Reserved
-1   % 13- Random Sequence Initial Seed (-1 = CLOCK)
0.0  % 14- Wind Error Mean [m/s]
5.0  % 15- Wind Error Standard Deviation (m/s) -----
5.0  % 16- Start time offset standard deviation (sec) -----
0.0  % 17- Reserved
38.16081600 % 18- Zero Reference Latitude, degrees
-85.74017300 % 19- Zero Reference Longitude, degrees
0.0 % 20- Zero Reference Altitude, Meters
%-----
```

## 9.6.2 Individual Simulation Runs

To perform an individual RIMP simulation run, the associated setup files, flight plan files, wind and temperature files, and other data files described above must be configured and appropriately referenced in the setup file or placed in the working directory of the MATLAB session.

### 9.6.2.1 Executing the Model

To execute a single simulation run from the MATLAB command line the following MATLAB commands are used. The first command initializes the simulation parameters. The second command executes the Simulink model.

```
>> run RIMP_Configure_6
>> sim('RIMPSimulator_v310_6')
```

### 9.6.2.2 Output Parameters and Plotting

The following parameters are saved during each simulation run. These values are store once every second. Parameters are stored for all the aircraft in the simulation.

```

%-----
% "AC_Data" vector:
%
% 1- Destination waypoint number
% 2- Flight Status (0 = in progress, 1= arrived, 2= frozen)
% 3-
% 4- Along-Track Distance to Go "ATDG" (Nm)
% 5- Along-Track inertial speed (Kts)
% 6- Required distance before WP to start turn (m)
% 7- Desired track (rad)
% 8- Cross track error (m)
% 9- Desired vert. flight path (rad)
% 10- Glideslope (vert.) error (m)
% 11- Desired turn rate (deg/sec)
% 12- Current speed command (M or KIAS)
%
% 13- Ground Speed (Kts)
% 14- Vertical Speed (Kts)
% 15- Ground track (deg) (rectified 0-360)
% 16- Vertical flight path angle (deg)
% 17- Wind Speed (Kts)
% 18- Wind Direction (deg)
% 19- East Position (nautical miles)
% 20- North Position (nautical miles)
% 21- Altitude (ft)
% 22- True Airspeed (Kts)
% 23- Indicated Airspeed (Kts)
% 24- Mach number
% 25- OAT (degK)
% 26- Static Pressure (mBar)
% 27- Air Density (Kg/m3)
% 28- Speed of sound (m/s)
%
% 29- RIMP speed (Knots)
%-----

```

In addition, the time-vector “ADS\_Data” holds the “Time to Go” information for each aircraft as a function of simulation time. Other simulation and flight plan parameters are also available for examination and plotting.

To extract the pre-defined statistics related to IM frequency and achieved spacing parameters, the following MATLAB scripts can be executed.

```
>> run RIMP_statistics
```

There are several scripts for plotting the flight history and various performance parameters. The following commands can be used to plot lead aircraft only, an aircraft pair performing IM, and three aircraft (2 pairs) performing IM respectively.

```
>> run RIMP_plotData_base
>> run RIMP_plotData2
>> run RIMP_plotData
```



### 9.6.3 Monte Carlo Simulation Runs

The RIMP simulation model is designed to address the random components of the simulation using the MATLAB pseudo-random number stream with a specified seed. If the random seed is set to “-1” the seed is initialized using the computer time. This setting allows for repeated simulation runs with random components as would be needed in a Monte Carlo analysis.

#### 9.6.3.1 Model Setup and Execution

A MATLAB script file is used to execute the RIMP simulation model repeatedly and to extract the required statistics from each run. Prior to executing this script, the analyst must examine the script and all associated simulation setup files to ensure that proper parameters are specified. The desired number of simulation runs is specified at the top of the Monte Carlo script. This will execute the entire Monte Carlo simulation analysis.

```
>> run RIMP_MonteCarlo
```

#### 9.6.3.2 Model Statistics Collected

The following statistics are collected for each simulation run:

- IM frequency per flight plan segment is the number of IM speed changes (increase or decrease) during the segment divided by the duration of the segment.
- IM frequency below flight level 100 is the number of IM speed changes (increase or decrease) during that part of flight below 10,000 feet divided by the duration of the flight below 10,000 feet.
- IM frequency total flight is the number of IM speed changes (increase or decrease) during that entire flight operation from the “merge” point to the reference point divided by the duration of this operation.
- IM achieved spacing is the difference in time of arrival of the reference aircraft and ownship at the IM reference waypoint.
- IM achieved spacing error is the difference between the commanded spacing and actual or achieved spacing at the reference waypoint.

#### 9.6.3.3 Model Output and Plotting

At the completion of a Monte Carlo simulation run, the histogram of the statistics and associated mean, standard deviation, maximum, and minimum values can be plotted and displayed by executing the following MATLAB script file.

```
>> run RIMP_plotData_stats
```

In addition, the time history data from the last simulation run will also be available to plot as an example of simulation parameters.

## **10 Required Self Separation Performance Study**

The Next Generation Air Transportation System (NextGen) is envisioned as a revolutionary transformation of the U.S. airspace to a performance-based, scalable, network-enabled system that will be flexible enough to meet future air traffic needs. One of the major transformations is the use of Trajectory-Based Operations (TBO) as the main mechanism for managing traffic at high density or in highly-complex airspace. These TBOs will be specified between the user and the Air Navigation Service Provider (ANSP) and agreed in a “contract”, using advanced automation. Overall, preferences for all users are accommodated to the greatest extent possible, and trajectories constrained only to the extent required to accommodate congestion, or for security, safety, or environmental reasons. Changes to that “contract” will be made collaboratively, balancing the user preferences with the ANSP constraints.

A major element of TBO is trajectory-based Separation Management (SM), which uses automation and shared trajectories to better manage separation among aircraft, airspace, and hazards such as weather and terrain. TBO provides a means for maintaining a Target Level of Safety (TLS) while increasing traffic densities well beyond what is possible today given the workload, uncertainty, and execution delays inherent in current ground-based air traffic management. Concepts for moving the SM function into the cockpit have been explored [6], and the need to characterize the performance of such functions in a manner that supports quantitative analysis of the overall safety of the ATM system has been identified [7]. An analogous construct for the characterization of system performance has already been defined and adopted by the aviation community for lateral navigation. This construct has been termed Required Navigation Performance (RNP) [8].

The document, *Required Self Separation Performance, Version 1.1* [9], defined an RNP-like construct for defining the performance of systems capable of performing airborne self-separation operations. A key metric for this construct was overall separation prediction accuracy and the assumption that this prediction accuracy could be determined based on parameters (state and system accuracy) known at the time of prediction.

### **10.1 Objectives and Motivation**

This study explored the relationship between various lateral separation geometry parameters (speeds, crossing angle, and time-to-go) and system accuracy metrics (navigation accuracy and surveillance accuracy) and the statistical distribution of expected actual separation distances. With an eye to demonstrating separation containment, this study determined the minimum separation distance that should be targeted in order to ensure with 95% confidence that an encounter will result in an actual separation of at least a certain target distance.

### **10.2 Background**

Reference [9] examined what would be required in order to ensure a TLS for a scenario, such as TBO, in which properly equipped aircraft have primary responsibility for avoiding other aircraft. This concept contrasts with the current system where that responsibility lies with the ANSP. It described the system components, identified key system parameters, and derived a RNP-like construct for self-separation operations. An accompanying MATLAB model, the

RSSPSimulator, expanded upon the Total System Error (TSE) analysis included as Appendix B in that document to provide a means of assessing the impact that various error sources and uncertainties have on an aircraft's ability to accurately predict (and hence control) its minimum separation from a reference aircraft. The model included computation of the encounter geometry, linearized analysis of the impact of error sources on the predicted separation, and a Monte Carlo based analysis of the impact of error sources on the distribution of separation as a function of encounter geometry in the context of key error terms for Class A and Class B Required Self-Separation Performance (RSSP) systems in the horizontal plane. The two classes of RSSP capable systems are examined independently because of their different characteristics and input error terms. As defined in [9], RSSP Class A systems generate and use intent information whose spatial error characteristics are numerically bounded. RSSP Class B systems, on the other hand, need only produce and make use of present position and velocity inputs for the computation of conflicts and resolutions.

### 10.3 Simulation Platform and Scenarios Description

#### 10.3.1 Basic Separation Distribution Model

The simulation platform used for this study is based on the distribution analysis core of the RSSPSimulator V2.1.1 [10]. The distribution analysis was performed using a Monte Carlo approach. The inputs used to establish the nominal geometry and state before the introduction of uncertainties for this analysis are the scenario geometry parameters (ownship groundspeed ( $S_O$ ), reference aircraft groundspeed ( $S_R$ ), crossing angle ( $\psi$ ), nominal time to CPA ( $t_{CPA}$ ), target range at CPA ( $R_{CPA}$ ), and crossing order (ownship passes ahead or behind reference) as represented in Figure 52. These inputs are used to compute the additional dependent geometry parameters which define the initial relative position of the two aircraft ( $x_0$  and  $y_0$ ).

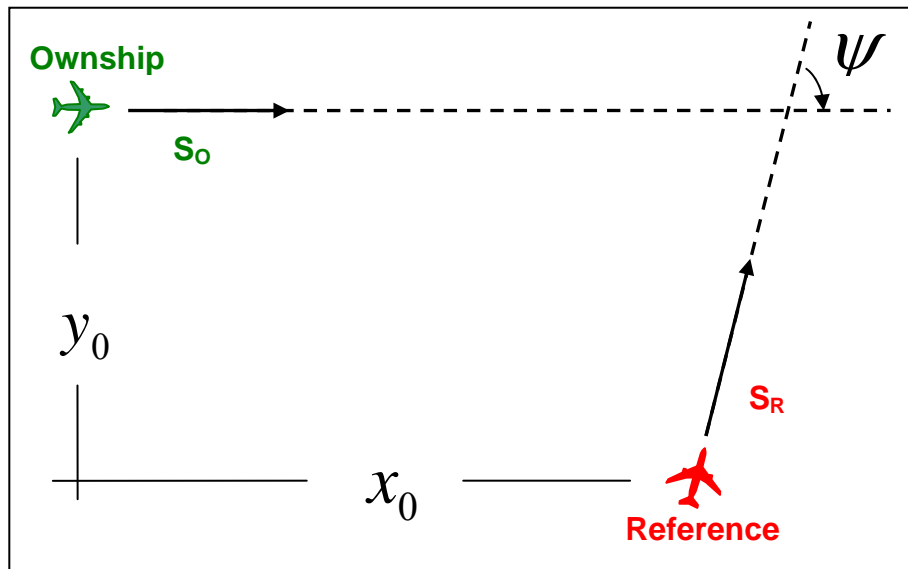

Figure 52 - Original Estimated Geometry

Once the nominal geometry and state have been determined, perturbations are applied to the positions (Class A systems) or the positions and velocities (Class B systems) according to the

input uncertainties. The equation for  $R_{CPA}$ , which was used to determine  $x_0$  and  $y_0$ , is then solved using the perturbed values to determine the sample outcome  $R_{CPA}$  resulting from the perturbed geometry and state, with care taken to use a negative result if the perturbation results in a reversal of the crossing order. Sufficient numbers of perturbed condition samples are examined to enable generation of a resulting distribution of statistics for the resulting actual  $R_{CPA}$  for each perturbed condition.

The distribution function inputs used to perturb the nominal geometry and state will depend on whether a Class A pair of systems or a Class B pair of systems is being evaluated. Classification as a Class A RSSP system, implies that the aircraft are both operating according to four dimensional (4D) flight plans and are broadcasting TCPs with known lateral and longitudinal accuracy characteristics. The input parameters will therefore be taken to represent the standard deviation for lateral and longitudinal uncertainties (a Gaussian distribution is assumed). These uncertainties are meant to reflect a time approximately  $t_{CPA}$  in the future. Classification as a Class B RSSP system, on the other hand, implies that the aircraft only rely on current position and velocity measurements, and that the accuracy characteristics of these measurements are Gaussian and non-directional (errors are uniformly distributed in azimuth). The formulae used to compute perturbed parameters based on the system class and uncertainties may be found in 10.

The distribution statistics computed for each set of uncertainties and nominal geometry include the resulting 5% confidence boundary ( $R_{CPA}(5\%)$ ), mean ( $\mu_{R_{CPA}}$ ) and standard deviation ( $\sigma_{R_{CPA}}$ ) of the “actual” separation at the point of closest approach. Once the Monte Carlo results have been organized into bins to form a histogram, the values for  $\mu_{R_{CPA}}$  and  $\sigma_{R_{CPA}}$  are calculated as follows:

$$\mu_{R_{CPA}} = \frac{1}{N_S} \sum_{i=1}^{N_B} Samples(i) R_{CPA}(i) \quad (133)$$

$$\sigma_{R_{CPA}} = \sqrt{\frac{1}{N_S} \sum_{i=1}^{N_B} Samples(i) (R_{CPA}(i) - \mu_{R_{CPA}})^2} \quad (134)$$

Where:

- $N_B$             Number of Bins
- $N_S$             Total Number of Samples
- $R_{CPA}(i)$      $R_{CPA}$  of Bin  $i$
- $Samples(i)$  Number of Samples in Bin  $i$

Finally, the probability distribution function is “integrated” to find the value of  $R_{CPA}$  that contains 5% of the samples ( $R_{CPA}(5\%)$ ).  $R_{CPA}(5\%)$  is the separation distance for which there is a probability of 5% that the actual  $R_{CPA}$  could be less than  $R_{CPA}(5\%)$  given the specified geometry and errors. That is,  $R_{CPA}(5\%)$  represents the larger separation distance that must be targeted to ensure that the smaller minimum separation distance will be achieved at least 95% of the time.

### 10.3.2 Computation of Required Target $R_{CPA}$

A MATLAB function, `RSSPEXperiment`, was written around the above core to iteratively find the required target  $R_{CPA}$  that yields an  $R_{CPA}(5\%)$  within 0.005 nmi of a specified minimum separation over a set of speed and crossing angles. This MATLAB function takes scenario parameters of system class and associated uncertainty parameters,  $t_{CPA}$ , and minimum separation as input. It then sets the target  $R_{CPA}$  and uses the core separation distribution model to determine  $R_{CPA}(5\%)$  for each combination of ownship groundspeed ( $S_O$ ), reference aircraft groundspeed ( $S_R$ ), and crossing angle ( $\psi$ ). If this is not within tolerance of the specified minimum separation, the target  $R_{CPA}$  is adjusted and the process is repeated until the solution converges. Then, the relevant geometry sweep parameters and output variables ( $R_{CPA}(5\%)$ ,  $R_{CPA}$ ,  $\mu_{R_{CPA}}$ , and  $\sigma_{R_{CPA}}$ ) are stored in the results file.

### 10.3.3 Outer Framework

An additional MATLAB script, `RSSPEXperimentLauncher`, was used to invoke `RSSPEXperiment` for each of the test conditions. This script permits the unattended execution of multiple study scenarios.

## 10.4 Study Design

### 10.4.1 Plan and Approach

In order to explore the relationship between various lateral separation geometry parameters and system accuracy metrics and the lateral separation target required to ensure (with 95% confidence) that the actual separation will be above a required minimum value (required target separation)<sup>29</sup>, the `RSSPSimulator` was used to perform Monte Carlo studies over a range of encounter geometry and system accuracy parameters while adjusting the target separation for each parametric run to ensure that only 5% of cases fall below a specified minimum separation value. The analysis was conducted for both Class A (intent based) and Class B (state only) RSSP types of systems.

This study was designed to verify the following expected behavior:

1. For a given minimum separation value, the required target separation will decrease as navigation and surveillance accuracy increases.
2. The required target separation will be a function of encounter geometry in addition to navigation and surveillance accuracy.
3. The average range at closest approach will always be less than the targeted range at closest approach by an amount that is a function of both geometry and accuracy.
4. The standard deviation of actual range at closest approach can be predicted using the sensitivity analysis to scale the navigation and surveillance accuracy as a function of encounter geometry.

---

<sup>29</sup> The required target separation is equivalent to the minimum separation plus the additional buffer required to account for the uncertainties.

### 10.4.2 Metrics

The primary metric for this study were the target lateral separation required to ensure that the actual separation will be greater than a specified minimum with 95% confidence. In order to facilitate comparisons across different separation minima, this will typically be reported as a buffer rather than the full target separation distance. Additional metrics include the mean and standard deviation of actual separation values (i.e.,  $R_{CPA}$ ) achieved for a given geometry and across geometries for a given system type and set of uncertainties. These metrics can be summarized as:

- Required Buffer (Buffer)      The target  $R_{CPA}$  (needed to attain the 95% confidence) minus the specified minimum separation
- Average  $R_{CPA}$  Offset  
( $\mu_{R_{CPA}} - R_{CPA}$ )      The average actual  $R_{CPA}$  for perturbations of each input geometry within a scenario minus the nominal  $R_{CPA}$  for the scenario.
- $R_{CPA}$  Standard Deviation  
( $\sigma_{R_{CPA}}$ )      The standard deviation of the actual  $R_{CPA}$  for perturbations of each input geometry within a scenario.

### 10.4.3 Test Plan

For each scenario of specified minimum lateral separation, RSSP class, and system accuracy indicated in the tables below, the necessary target separation was determined for geometry parameters generated according to Table 1.

Table 1: Scenario geometry parameters

Parameter	Min	Max	Step	Units
Ownship Ground Speed	200	600	50	kts
Reference Aircraft Ground Speed	200	600	50	kts
Crossing Angle	10	170	10	degrees

For Class A systems, the analysis was conducted for the following input parameter scenarios indicated in Table 2.

Table 2: Class A system condition parameters

Scenario	Ownship cross-track $\sigma$ (nmi)	Reference cross-track $\sigma$ (nmi)	Ownship along-track $\sigma$ (nmi)	Reference along-track $\sigma$ (nmi)	Minimum Separation (nmi)
A-1	0.1531 (RNP-0.3)	0.1531 (RNP-0.3)	0.1531 (RNP-0.3)	0.1531 (RNP-0.3)	1.0
A-2	0.1531 (RNP-0.3)	0.1531 (RNP-0.3)	0.5102 (RNP-1)	0.5102 (RNP-1)	1.0
A-3	0.1531 (RNP-0.3)	0.1531 (RNP-0.3)	0.5102 (RNP-1)	0.5102 (RNP-1)	5.0
A-4	0.5102 (RNP-1)	0.5102 (RNP-1)	0.5102 (RNP-1)	0.5102 (RNP-1)	5.0

For Class B systems, the analysis was conducted for the following input parameter scenarios indicated in Table 3. The values used for input uncertainties were selected to be consistent with the Navigation Accuracy Category for position (NACp) and Velocity (NACv) limits specified in 11.

Table 3: Class B system condition parameters

Scenario	Ownship Position $\sigma$ (nmi)	Reference Position $\sigma$ (nmi)	Ownship Velocity $\sigma$ (kts)	Reference Velocity $\sigma$ (kts)	Time to CPA (min)	Minimum Separation (nmi)
B-1	0.51 (NACp-4)	0.51 (NACp-4)	0.99 (NACv-3)	0.99 (NACv-3)	2	5.0
B-2	0.51 (NACp-4)	0.51 (NACp-4)	0.99 (NACv-3)	0.99 (NACv-3)	10	5.0
B-3	0.51 (NACp-4)	0.51 (NACp-4)	0.99 (NACv-3)	0.99 (NACv-3)	20	5.0
B-4	2.04 (NACp-2)	2.04 (NACp-2)	9.9 (NACv-1)	9.9 (NACv-1)	2	5.0
B-5	2.04 (NACp-2)	2.04 (NACp-2)	9.9 (NACv-1)	9.9 (NACv-1)	20	5.0
B-6	0.51 (NACp-4)	2.04 (NACp-2)	0.99 (NACv-3)	9.9 (NACv-1)	20	5.0

## 10.5 Study Results

Because Class A RSSP systems and Class B RSSP systems have fundamentally different error sources and characteristics the results for each class are examined separately.

### 10.5.1 Class A Systems

Table 4 summarizes the statistics of the metrics for the Class A scenarios defined in Table 2 computed across the geometry parameter sweeps specified in Table 1.

None of the Class A system results showed any sensitivity to crossing order.

Table 4: Class A system statistical results

Scenario	Metric	Mean	StdDev	Min	Max	Median
A-1	Buffer	0.359	0.000	0.359	0.359	0.359
	$\mu_{R_{CPA}} - R_{CPA}$	-0.050	0.000	-0.051	-0.049	-0.050
	$\sigma_{R_{CPA}}$	0.218	0.000	0.218	0.219	0.218
A-2	Buffer	0.768	0.234	0.371	1.189	0.813
	$\mu_{R_{CPA}} - R_{CPA}$	-0.050	0.001	-0.052	-0.048	-0.050
	$\sigma_{R_{CPA}}$	0.466	0.142	0.226	0.721	0.494
A-3	Buffer	0.768	0.234	0.371	1.188	0.813
	$\mu_{R_{CPA}} - R_{CPA}$	-0.050	0.001	-0.052	-0.048	-0.050
	$\sigma_{R_{CPA}}$	0.466	0.142	0.226	0.722	0.494
A-4	Buffer	1.187	0.002	1.181	1.194	1.187
	$\mu_{R_{CPA}} - R_{CPA}$	-0.050	0.001	-0.054	-0.047	-0.050
	$\sigma_{R_{CPA}}$	0.722	0.001	0.720	0.725	0.722

For conditions A-1 and A-4, the standard deviation of all three metrics was zero or near zero. This result indicates that the Buffer metrics were all insensitive (within the 0.005 nmi convergence threshold) to the swept scenario geometry parameters (Ownship Ground Speed, Reference Aircraft Ground Speed, and Crossing Angle). For both of these symmetric scenarios, the standard deviation of  $R_{CPA}$ ,  $\sigma_{R_{CPA}}$ , is approximately the  $\sqrt{2}$  times the standard deviation of each aircraft's overall position uncertainty<sup>30</sup>. It is interesting to note that in both scenarios, the mean Buffer is almost exactly  $1.645 \sigma_{R_{CPA}}$ . This is consistent with the value used for a 90% confidence interval about the mean of a Gaussian distribution<sup>31</sup>, but does not seem to include the slight negative bias of the mean separation.

The results for scenarios A-2 and A-3, the two scenarios with different lateral and longitudinal uncertainties, showed considerable sensitivity to encounter geometry. That their normalized statistics are effectively identical indicates a lack of correlation to minimum separation (the only control variable that differs between the two scenarios).

In order to facilitate visualization of the output metrics as a function of the three geometry variables, a means was sought to combine the two input groundspeeds into a single normalization parameter to collapse the 4-dimensional space into 3 dimensions for easier representation in 2 dimensions. As a first attempt, the two speed dimensions,  $S_O$  and  $S_R$ , were represented in a single dimension using the difference in speeds ( $S_O - S_R$ ), but this normalization

<sup>30</sup>Since the two components of position uncertainty for a Class A system are independent, orthogonal, and equal in magnitude, the standard deviation of the overall position uncertainty is the same as the single-axis standard deviation. When the position uncertainties of the two aircraft are combined, the relative position uncertainty is then  $\sqrt{2}$  times the individual position uncertainty.

<sup>31</sup>It is appropriate to use the 90% interval rather than the 95% interval here because the concern in this case is only with the half of the outliers in one tail of the distribution.



showed evidence of sensitivity to overall speed. When the two speeds were instead represented as the difference in speed divided by the average speed, no normalization artifacts were found across the entire speed profile. Therefore, all plots below will use normalized speed difference,  $(S_O - S_R) / [(S_O + S_R)/2]$ , and crossing angle for the geometry axes.

Figure 53, Figure 24, and Figure 55 show two perspectives of the 3D plot of the average Buffer metric versus geometry parameters for scenarios A-1, A-2, A-3, and A-4. Scenario A-4 is top plane. Scenario A-1 is the bottom plane. Scenarios A-2 and A-3 were indistinguishable in this representation.

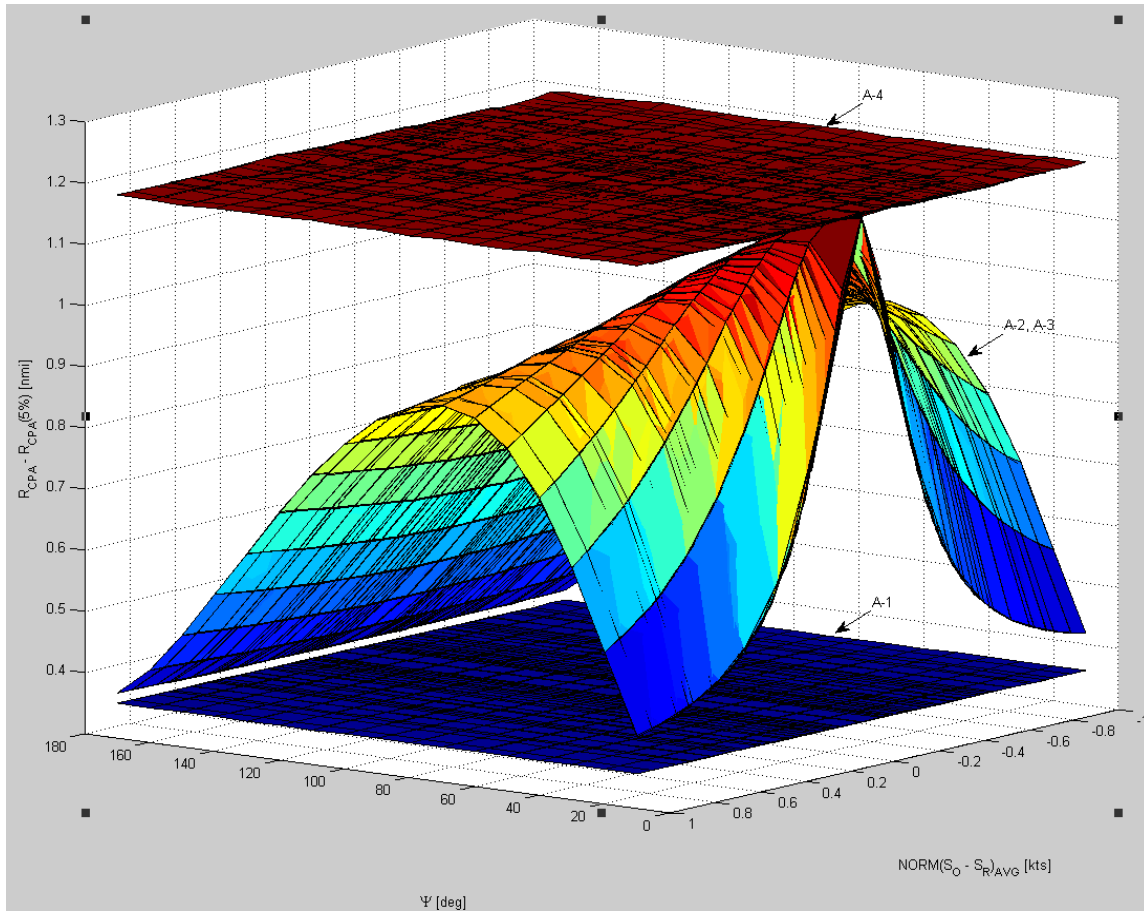

**Figure 53 -Scenarios A-1—A-4: Required Buffer versus Crossing Angle and Normalized Speed Difference.**

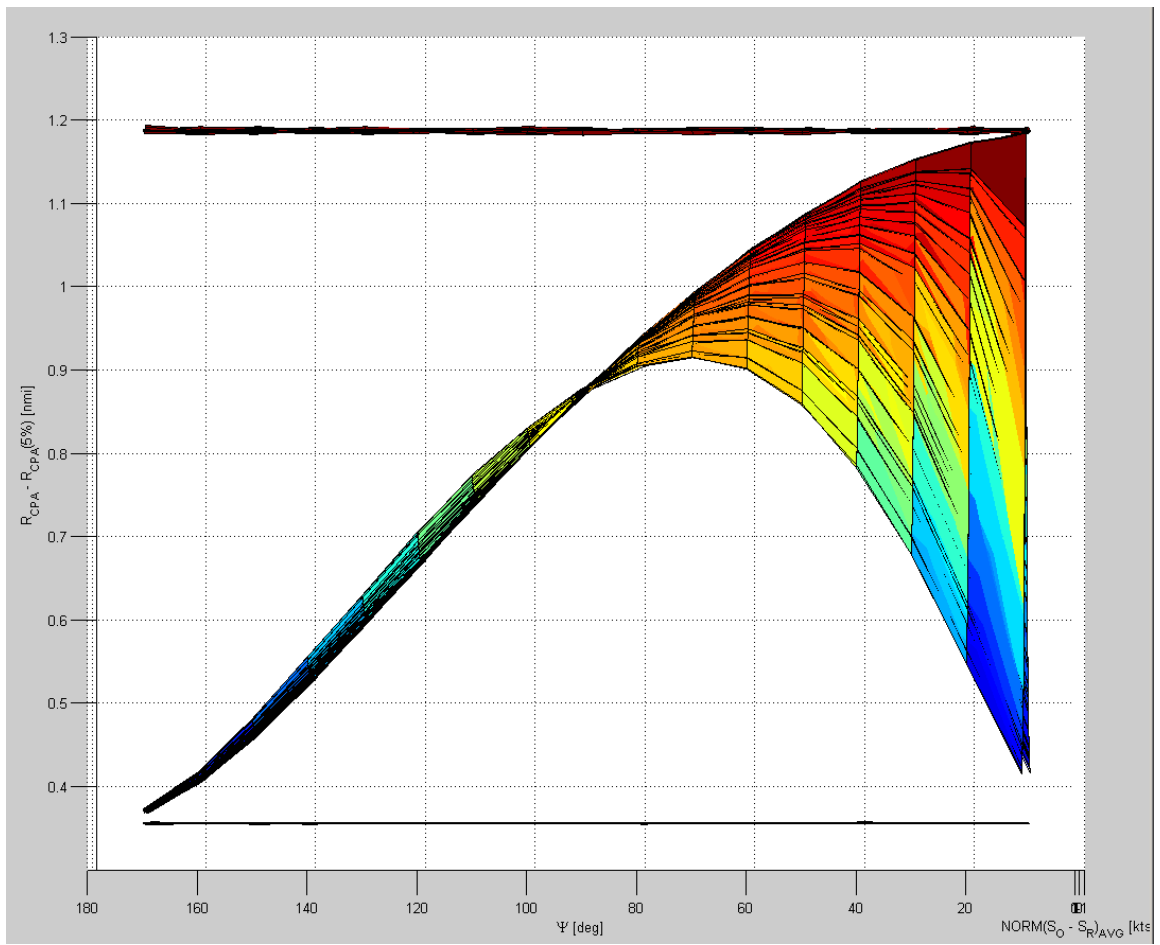

**Figure 54 - Scenarios A-1—A-4: Required Buffer versus Crossing Angle, Normalized Speed Difference in the Z-Axis.**

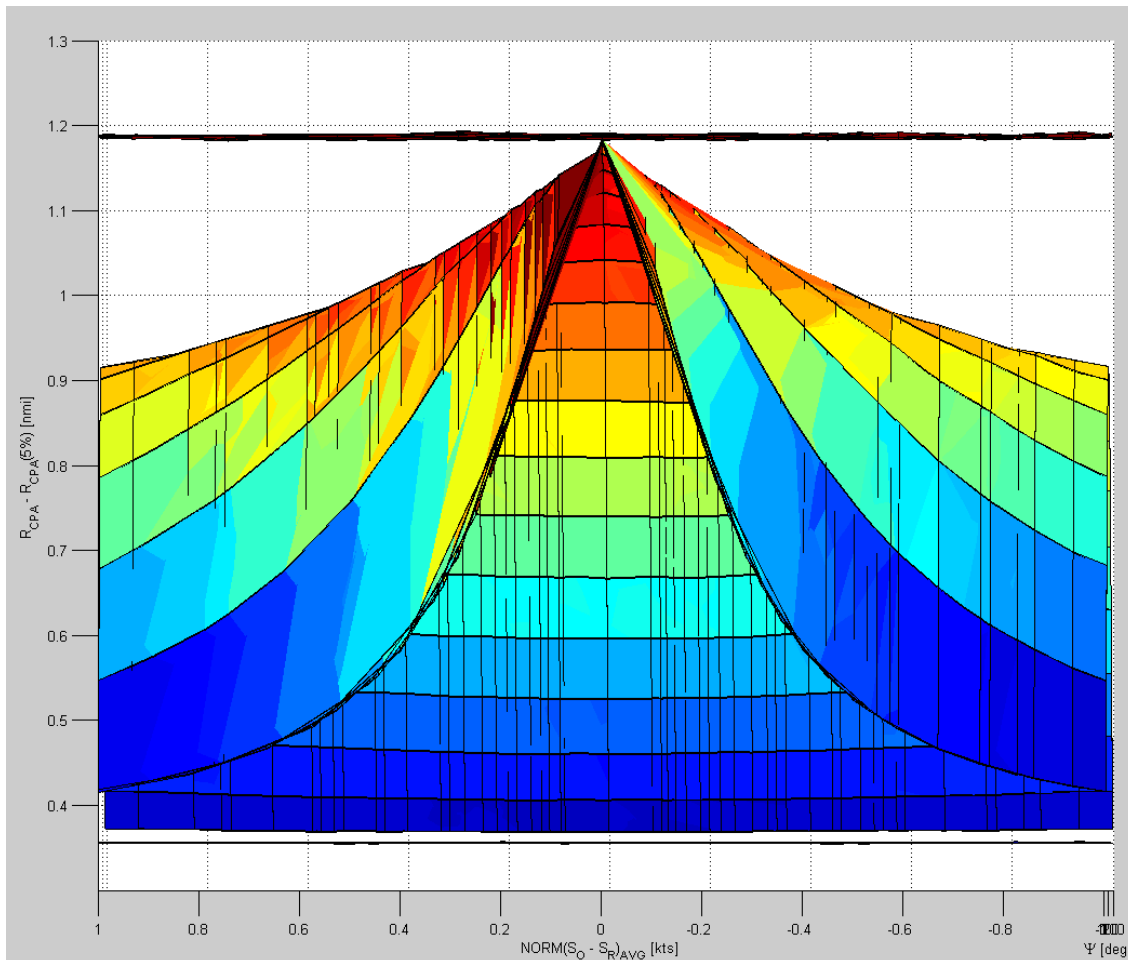

**Figure 55 - Scenarios A-1—A-4: Required Buffer versus Normalized Speed Difference, Crossing Angle in the Z-Axis.**

These figures demonstrate the strong dependence of required buffer to encounter geometry (speeds and crossing angle). It is also interesting to note that all of the data points lie between the required buffers found in scenarios A-1 and A-4. This is as expected given that the uncertainties in scenarios A-2 and A-3 are a hybrid of the A-1 and A-4 uncertainties. These figures also show that the larger lateral uncertainty plays the largest role in geometries in which the speeds are similar and the crossing angle is small (tail-chase) and much less of a role in near head-on geometries regardless of relative speed.

### 10.5.2 Class B Systems

Table 5 summarizes the statistics of the metrics for the Class B scenarios defined in Table 3 computed across the geometry parameter sweeps specified in Table 1 as was done for the Class A systems in the previous section. Again, none of the Class B system results showed any significant sensitivity to crossing order.

Table 5: Class B system statistical results

Scenario	Parameter	Mean	StdDev	Min	Max	Median
B-1	Buffer	0.849	0.002	0.844	0.856	0.849
	$\mu_{R_{CPA}} - R_{CPA}$	-0.050	0.001	-0.052	-0.048	-0.050
	$\sigma_{R_{CPA}}$	0.512	0.001	0.510	0.514	0.512
B-2	Buffer	0.888	0.002	0.882	0.894	0.887
	$\mu_{R_{CPA}} - R_{CPA}$	-0.050	0.001	-0.052	-0.048	-0.050
	$\sigma_{R_{CPA}}$	0.537	0.001	0.535	0.539	0.537
B-3	Buffer	1.002	0.002	0.996	1.009	1.002
	$\mu_{R_{CPA}} - R_{CPA}$	-0.050	0.001	-0.053	-0.048	-0.050
	$\sigma_{R_{CPA}}$	0.609	0.001	0.607	0.611	0.609
B-4	Buffer	3.435	0.025	3.411	4.085	3.432
	$\mu_{R_{CPA}} - R_{CPA}$	-0.055	0.017	-0.457	-0.043	-0.052
	$\sigma_{R_{CPA}}$	2.069	0.010	2.060	2.194	2.068
B-5	Buffer	6.418	0.056	6.374	7.720	6.409
	$\mu_{R_{CPA}} - R_{CPA}$	-0.057	0.025	-0.618	-0.035	-0.053
	$\sigma_{R_{CPA}}$	3.888	0.017	3.871	4.038	3.886
B-6	Buffer	4.626	0.024	4.587	5.147	4.623
	$\mu_{R_{CPA}} - R_{CPA}$	-0.053	0.010	-0.267	-0.040	-0.052
	$\sigma_{R_{CPA}}$	2.781	0.003	2.771	2.814	2.781

These data show the expected increase in required buffer as uncertainties increase, either as the result of greater look-ahead times as seen comparing scenarios B-1, B-2, and B-3, or greater data uncertainty as seen by comparing scenarios B-1 and B-4 or B-3 and B-5. As was seen for symmetric Class A scenarios, the required buffer is approximately 1.65 times the measured  $\sigma_{R_{CPA}}$ , which is consistent with a normal distribution. A comparison of the measured  $\sigma_{R_{CPA}}$  to an approximation for each aircraft's position uncertainty at the nominal time of CPA<sup>32</sup> reveals that the RMS of the standard deviation of each aircraft's position uncertainty is a good predictor of  $\sigma_{R_{CPA}}$  as seen in Table 6.

<sup>32</sup> The standard deviation of the position uncertainty of each aircraft at  $T_{CPA}$  is taken as the RMS of the standard deviation of the initial position uncertainty and the standard deviation of the velocity uncertainty times  $T_{CPA}$ .

Table 6: Class B system analysis of uncertainties

<b>Scenario</b>	<b>Ownship Position <math>\sigma</math> (nmi) at <math>T_{CPA}</math></b>	<b>Ownship Position <math>\sigma</math> (nmi) at <math>T_{CPA}</math></b>	<b>RMS of Position Uncertainties</b>	<b>RMS * <math>\sqrt{2}</math></b>	<b><math>\sigma_{RCPA}</math></b>
B-1	0.361	0.361	0.361	0.511	0.512
B-2	0.379	0.379	0.379	0.536	0.537
B-3	0.430	0.430	0.430	0.607	0.609
B-4	1.461	1.461	1.461	2.067	2.069
B-5	2.743	2.743	2.743	3.880	3.888
B-6	0.430	2.743	1.963	2.777	2.781

A comparison of scenario B-6 (a hybrid of B-3 and B-5) to scenarios B-5 and B-3 shows that the required buffer is much more than found for B-3, but less than found for B-5. This implies that buffers may be reduced somewhat if ownship uncertainties are less than reference aircraft uncertainties, though the effects of the greater uncertainty will likely dominate.

Given that all uncertainties for Class B systems are uniform with azimuth, the results from scenarios A-1 and A-4, which also had uncertainties that were uniform in azimuth and showed no variation with geometry, might suggest a lack of dependence on geometry for Class B systems, and that largely seems to be the case, especially for scenarios B-1, B-2, and B-3, which show near zero standard deviation and little difference between minima and maxima across the tested encounter geometries. While the standard deviation of the parameters for scenarios B-4, B-5, and B-6 are also relatively small, the data does show some significant differences between minima and maxima for each parameter. The location of these extremes can be seen in Figure 56 and Figure 57 which depict two views of the results in like manner to Figure 24 and Figure 55. These figures show the flatness of the results for the first three scenarios, similar in form to surfaces for scenarios A-1 and A-4, but show significant peaks for the latter three scenarios at small crossing angles and small to slightly negative relative speeds ( $S_R > S_O$ ). There are also slight peaks (which are difficult to see in the figures) at the 170 degree crossing angle.

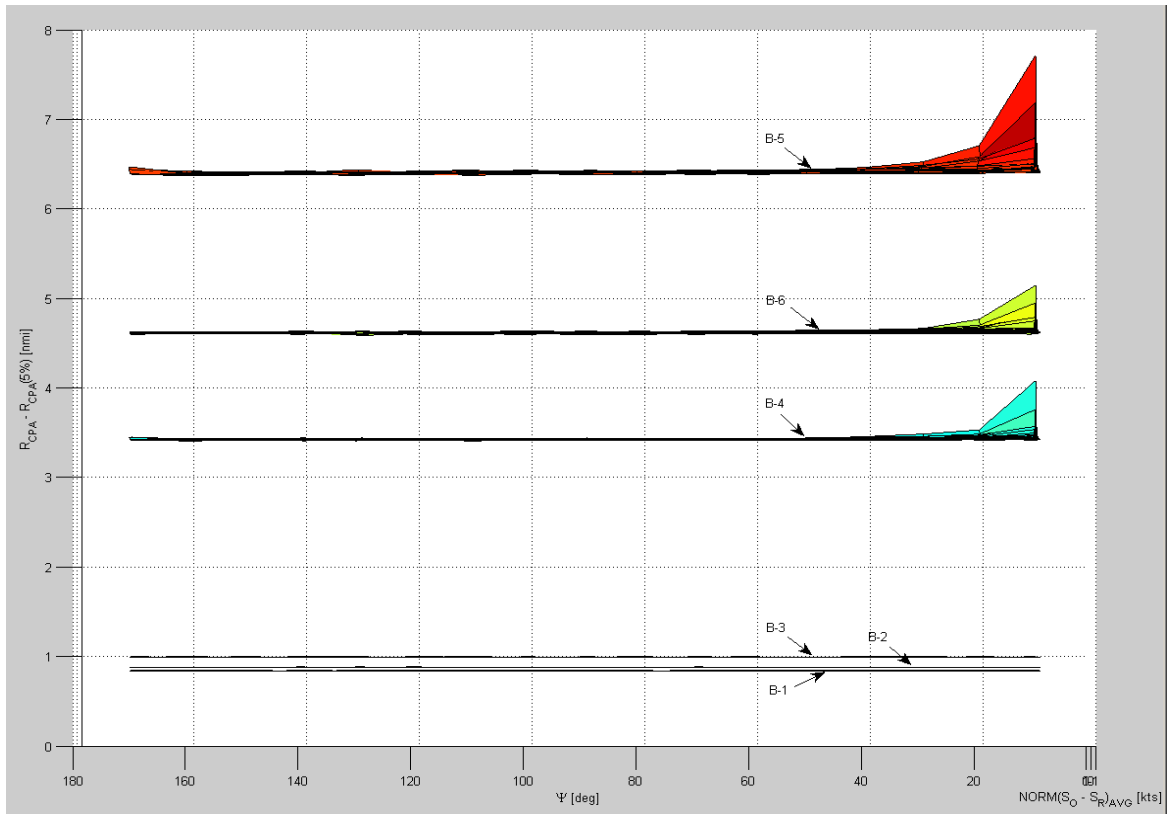

**Figure 56 - Scenarios B-1 – B-6: Required Buffer versus Crossing Angle, Normalized Speed Difference in the Z-Axis.**

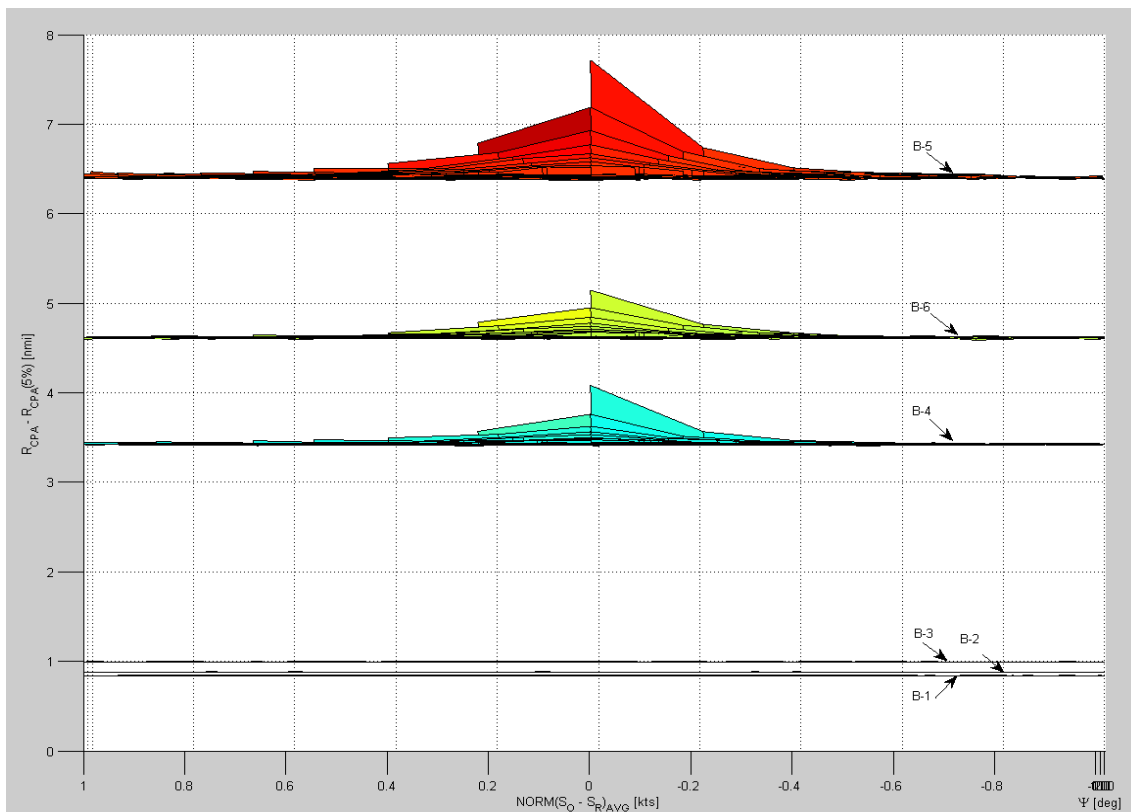

**Figure 57 - Scenarios B-1 – B-6: Required Buffer versus Normalized Speed Difference, Crossing Angle in the Z-Axis.**

A probable source of these peaks is the larger magnitude of the velocity uncertainty in scenarios B-4, B-5, and B-6. At low speeds and shallow crossing angles (e.g. 10 degrees and 170 degrees), the lateral closing velocities are quite small. The standard deviation for a velocity of 9.9 knots (NACv-1) used in these scenarios will result in significant changes in the actual crossing angle, and when the nominal crossing angle is quite small, will sometimes result in actual crossing angles near the singularity points of 0 and 180 degrees.

### **10.5.3 Comparison of Class A and Class B RSSP Systems**

For all scenarios in which uncertainties were uniformly distributed in azimuth, there was almost no dependence of the required buffer with the encounter geometry parameters (speeds and crossing angle). The exception to this was for Class B RSSP systems at very narrow crossing angles (near 0 degrees or near 180 degrees). In general, the Class A systems required smaller buffers partly because smaller uncertainties were used and partly because the overall uncertainty does not increase with time as it does for a Class B RSSP system. As demonstrated by scenarios A-2 and A-3, Class A RSSP systems open up the opportunity to reduce buffer sizes when favorable encounter geometries exist and lateral RNP performance is better than longitudinal RNP performance (which is typical).

## **10.6 RSSP Study Conclusion**

A mathematical model of Required Self-Separation Performance was exercised in a Monte Carlo study to provide insight into the separation buffers required to achieve a minimum separation with a given degree of confidence. The results indicated that, for a given minimum separation value, the required target separation will decrease as navigation and surveillance accuracy increases. While the data did show that the average range at closest approach will always be less than the targeted range at closest approach, the difference is relatively unaffected by geometry or the magnitude of uncertainties except in extreme cases where lateral uncertainties (especially velocity) result in the possibility of a 0/180 degree crossing angle. While the required target separation was found to be largely independent of encounter geometry for cases with directionally uniform uncertainties, it was found to be a complex function of encounter geometry in the case where lateral and longitudinal uncertainties differed significantly.

## **11 Required interval Management Performance Study**

The Next Generation Air Transportation System (NextGen) is envisioned as a revolutionary transformation of the U.S. airspace to a performance-based, scalable, network-enabled system that will be flexible enough to meet future air traffic needs. One of the major transformations is the use of Trajectory-Based Operations (TBO) as the main mechanism for managing traffic at high density or in highly-complex airspace. These TBOs will be specified between the user and the Air Navigation Service Provider (ANSP) and agreed in a “contract”, using advanced automation. Overall, preferences for all users are accommodated to the greatest extent possible, and trajectories constrained only to the extent required to accommodate congestion, or for security, safety, or environmental reasons. Changes to that “contract” will be made collaboratively, balancing the user preferences with the ANSP constraints.

A component of 4-D RNP operation is onboard Interval Management (IM) performed by appropriately equipped aircraft. At present, interval management is performed by ground controllers and through the use of air traffic control radar and with little or no automation. It is expected that insertion of modern ADS-B surveillance technologies, precision navigation and guidance technologies, airborne automation tools, and other NextGen concepts, will enable a more precise airborne interval management operation that significantly increases the system capacity without adversely impacting the safety and reliability of air traffic operations.

A complete set of operational requirements for automated IM has not yet been fully defined. A number of studies are being conducted to evaluate various uncertainties and operational parameters that affect IM. The document *Required Interval Management Performance Version 1.1*, submitted under contract #NNL08AA15B, NASA Task Order #NNL08AB13T, defined a Required Navigation Performance (RNP)-like construct for defining the performance of systems capable of performing airborne interval management operations. Several significant uncertainty elements were identified and a number of parameters affecting the IM performance were considered. The Required Interval Management Performance (RIMP) must ultimately address the ability of each participating aircraft to achieve an agreed-upon spacing at the defined IM point behind the reference (lead) aircraft. The accuracy of this operation in the presence of various uncertainties is the topic of this study.

### **11.1 Objectives and Motivation**

This study assessed the feasibility of a long stream of aircraft to perform RIMP operation in the presence of various uncertainties. The resulting data is intended to quantify the performance of airborne IM and define the limits of safe and stable operation.

Successful IM achievement depends on many factors including accuracy of forecast winds, surveillance capabilities of aircraft engaged in IM, precision of navigation system, and the specific capabilities of the IM control system itself. One specific objective of this study is to develop metrics to assess how a given IM system performs compared to other comparable IM control systems. This type of quantification will allow further development of RIMP standards to ensure reliable achievement of the Target Level of Safety (TLS).



## **11.2 Background**

Earlier investigation identified a number of key elements of navigation and surveillance systems used in IM operation that would contribute to achievement of an overall required TLS. The goal of this effort was to identify a set of performance-based parameters that can relate the capabilities of an equipped aircraft to safely execute IM operation within a given performance envelope. This is comparable to the Required Navigation Performance (RNP) operation, but its scope extends to both trailing and leading (reference) aircraft equipage and capabilities and includes an estimate of relative enroute time as a key element of the operational performance.

To evaluate the proposed RIMP standards, a simplified RIMP operation model was developed in the MATLAB/Simulink environment. The model included along-track motion only. Additional simplifications and assumptions included constant acceleration in the along-track direction. A Time-To-Go (TTG) estimator based on constant forecast winds for each segment of the flight plan was implemented and a simple IM control system was developed to adjust aircraft speed as needed to maintain the desired interval. The initial model included a reference aircraft and one trailing aircraft performing airborne IM operations.

The current RIMP model included a four dimensional (4-D) point-mass model of multiple aircraft performing RIMP operations. The model also incorporated spatially varying wind states to provide a more realistic atmospheric environment. The flight operations were based on a commanded true airspeed profile specified in the flight plan. A comprehensive navigation and guidance model was used to realistically operate the aircraft through its flight plan. The model included random elements and uncertainty terms in the wind field, starting conditions, sensor outputs, and overall aircraft motion. This model used a very simple IM control scheme with limited ability to tune for specific performance goals.

NASA research efforts have looked at various aspects of airborne IM operations and have attempted to identify capacity increase and fuel saving metrics [14]. IM accuracy and reliability, as well as stability of a stream of aircraft performing airborne IM, have also been studied [15]. However, variation in assumptions concerning the IM operation itself, along with different IM control strategies selected by different investigators, can introduce differing results. Therefore, this effort produced a series of sensitivity and robustness studies to show how different IM control schemes or different assumptions on the IM operation itself can impact the performance of airborne IM.

## **11.3 Simulation Platform and Scenarios Description**

The simulation platform is a MATLAB/Simulink model utilizing simplified aircraft motion models. The modeling consists of three structural levels. The lowest level contains the individual aircraft flight dynamics models. The second level modeled the stream of aircraft performing the interval management operation. Individual aircraft models are utilized to generate this stream. The last level provided the Monte Carlo engine which repeatedly executes the air traffic stream models and collects the relevant statistics.

### 11.3.1 Aircraft Flight Dynamics Model

The general layout of the aircraft flight dynamics model is depicted in Figure 58. The model contains several subsystems and embedded MATLAB scripts. A complete description of the model is provided in reference [12]. Specific model parameters are setup using data files. This provides the flexibility to adjust the model to fit the study requirements.

The flight dynamics equations solve a point-mass model flying in 3-dimensional space with varying linear acceleration and rotation rates. The primary aircraft state derivatives are the rate of change of inertial speed, rate of change of vertical flight path angle, and rate of change of ground track. The state vector includes the inertial speed, vertical flight path angle, ground track, East relative position, North relative position, and altitude. Additional states being integrated are the instantaneous east and north wind components, as well as instantaneous atmospheric temperature and pressure. The air-relative velocities including indicated and true airspeeds and Mach number are computed based on local atmospheric properties, wind velocities, and aircraft inertial speed.

The wind, temperature, and pressure field is specified in a Rapid Update Cycle (RUC) data file. The complete RUC file is parsed for the expected position and altitudes specified in the desired flight plan. This reduced data is used during the execution of the simulation model to provide the “forecast” wind, temperature, and pressure values at each specified waypoint in the flight plan. It is assumed that the wind and temperature states vary linearly (in position and altitude) between the waypoints. To represent the wind uncertainty, a set of random wind increments are added at each waypoint for each simulation run. Since different aircraft performing the flight are spatially and temporally separated, different wind increments are applied for each aircraft, although they share the same forecast wind field.

The aircraft simulation includes a sensor model that introduces error, noise and uncertainty, and time delay into the measured parameters used for guidance and navigation. Currently, all aircraft utilize the same set of sensor parameters outlined in Figure 59.

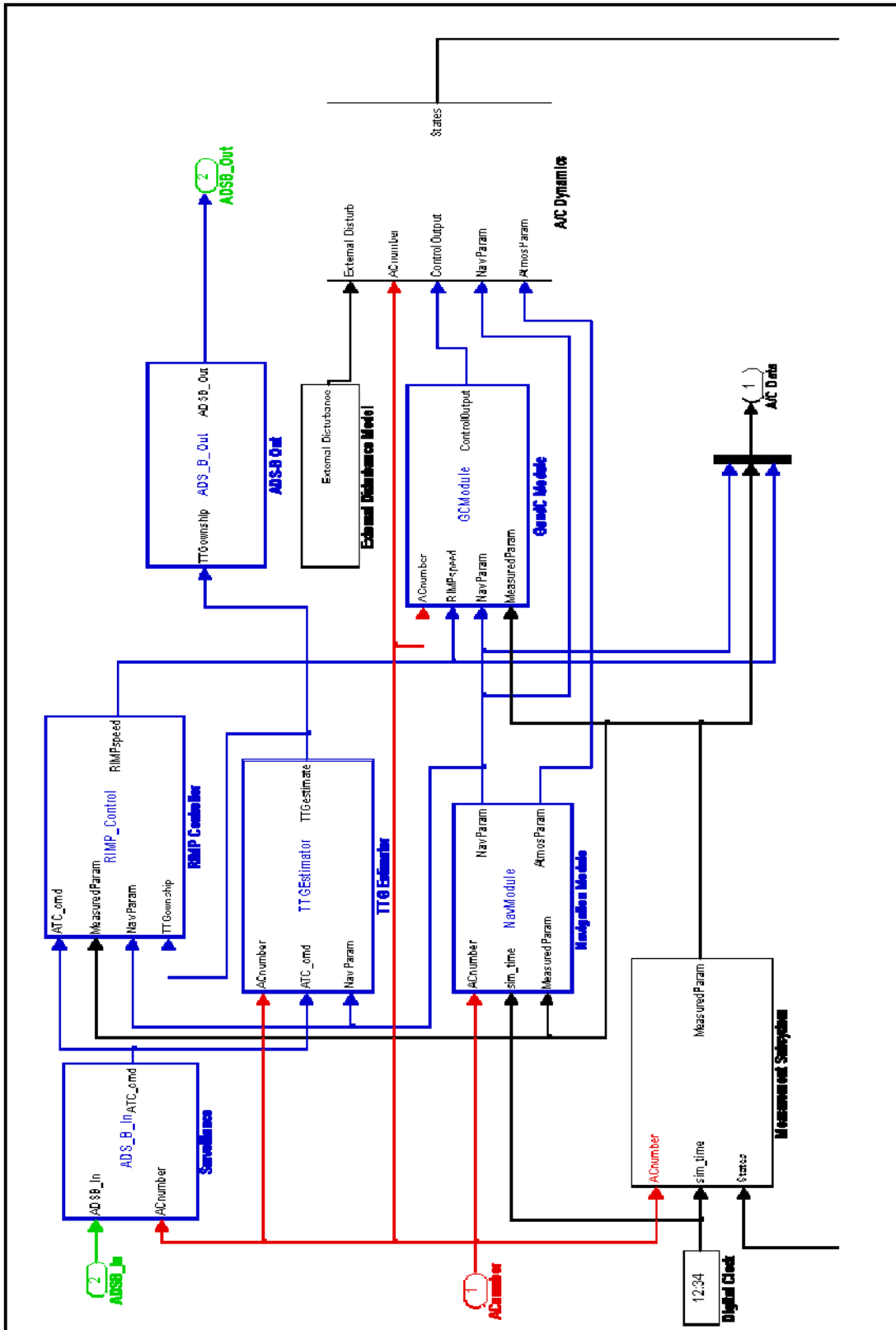

Figure 58 Aircraft Flight Dynamics Model in Simulink

```

% Sensor Number
% Scale Factor (SF)
% Bias
% Noise Signal Mean (Mean)
% Noise Signal Variance (Var)
% Filter Denominator coeff (change based on Tau and dt)
% Lower Limit (LLim)
% Upper Limit (ULim)
% Quantization Interval (Quant)
% Time Delay (tDel) [s]
%
% SF | Bias | Mean | Var | Tau | LLim | ULim | Quant | tDel
1, 0.0, 0.0, 0.0, 0.05, 0.990, 0.0, 400.0, 0.1, 0.10 % Inertial Speed [m/s]
2, 0.0, 0.0, 0.0, 0.0001, 0.990, -15.0, 15.0, 0.001, 0.01 % Ground track [rad]
3, 0.0, 0.0, 0.0, 0.0001, 0.990, -2.0, 2.0, 0.001, 0.01 % Gamma [rad]
4, 0.0, 0.0, 0.0, 0.05, 0.990, -250.0, 250.0, 0.01, 0.10 % Wind East [m/s]
5, 0.0, 0.0, 0.0, 0.05, 0.990, -250.0, 250.0, 0.01, 0.10 % Wind North [m/s]
6, 0.0, 0.0, 0.0, 0.05, 0.990, 160.0, 328.0, 0.1, 0.10 % OAT [degK]
7, 0.0, 0.0, 0.0, 0.1, 0.990, 50.0, 1090.0, 0.1, 0.01 % P static [mBar]
8, 0.0, 0.0, 0.0, 0.1, 0.990, -800000.0, 800000.0, 0.1, 0.10 % East Position [m]
9, 0.0, 0.0, 0.0, 0.1, 0.990, -800000.0, 800000.0, 0.1, 0.10 % North Position [m]
10,0.0, 0.0, 0.0, 0.1, 0.990, -1000.0, 20000.0, 0.1, 0.10 % Altitude [m]
%

```

Figure 59 Sensor Model Parameters

The guidance and control module within each aircraft model attempts to achieve and maintain the specified flight profile. In the vertical axis, it adjusts the flight path angle to achieve the desired instantaneous altitude and to zero the glideslope error, if any. In the horizontal plane, it changes the aircraft heading (ground track) to zero any cross track error and maintain the desired ground track. In the longitudinal axis, the speed is adjusted in order to achieve and maintain the desired Mach number or the desired indicated (equivalent) airspeed (IAS). The desired Mach or IAS values are specified in the flight plan. The IM guidance is added to the desired speed profile. The resulting total airspeed command is limited using maximum and minimum IAS tables. These tables are presented as a function of altitude and are aircraft-dependent. An example is provided in Figure 60.

```

% AircraftLimits_767.m
% Airspeed limits for 767-200
%
% Altitude [ft], VMin [kts], VMax [kts]

FltLvl = [ 0, 50, 100, 120, 180, 240, 300, 340, 400];
MaxIAS = [ 200, 240, 250, 310, 330, 330, 330, 330, 330];
NomIAS = [ 150, 240, 250, 290, 310, 310, 310, 310, 310];
MinIAS = [ 110, 160, 170, 180, 190, 210, 210, 210, 210];
%

```

Figure 60 Aircraft Indicated Airspeed Limits

During typical Continuous Descent Approach (CDA) operation, a constant Mach number is maintained during the initial descent until the IAS reaches the value specified in the “NomIAS” table. At this point, the “NomIAS” table values are maintained as the aircraft descends. The flight plan specifies a crossover altitude at which point speed command is switched to a specific IAS. During this operation, the IM speed change command is added to the speed command and the resulting total speed command is limited using the MaxIAS and MinIAS curves specified for the aircraft.

Two other important components of each aircraft model are the Total TTG estimator and the IM controller. The TTG estimator assumes linear speed variation from the current measured speed

to the next waypoint speed specified in the flight plan. It is assumed that the wind will also vary linearly from the current measured value to the forecast value at the waypoint. For all the flight plan segments ahead of the current segment, the TTG estimator assumes that the forecast winds and specified airspeeds hold true. The IM controller uses the TTG value from the TTG estimator for both the ownship and the reference aircraft to derive an instantaneous interval time. This time is compared with the specified interval and appropriate speed-up or slow-down commands are issued to zero the error between the commanded and measured (estimated) intervals.

### **11.3.2 Air Traffic Simulation**

The next layer of the simulation modeling is to combine the operation of multiple aircraft performing a stream of arrivals into a common destination. This is done using the MATLAB/Simulink environment. Figure 61 depicts a six-aircraft configuration of this stream. Each aircraft is implemented as a Simulink model. Each aircraft publishes its own TTG estimate and receives TTG estimates from all other aircraft. This setup is intended to simplify the modeling process needed for IM operation.

Figure 62 provides an example of an aircraft “Setup” file. Shown is the setup file for aircraft number 5 in the IM stream. Each aircraft is assigned a flight plan filename, a wind and temperature data filename, and an appropriate aircraft limits filename. The start time offset (in this case 200 seconds) specifies the number of seconds after the start of the overall simulation when the aircraft “leaves” the initial waypoint. For the current simulation setup, the initial waypoint is effectively the “merge” point and the start of the IM operations. The ownship assigned number (in this case 5) and the reference aircraft number (in this case 4) are also specified. The assigned reference waypoint (in this case 10) is the common waypoint where the TTG calculations are based at. Time of arrival at the reference waypoint is used to compute the achieved spacing for each IM pair. Finally, the nominal spacing time is specified (in this case 50 seconds) for each aircraft in the stream.

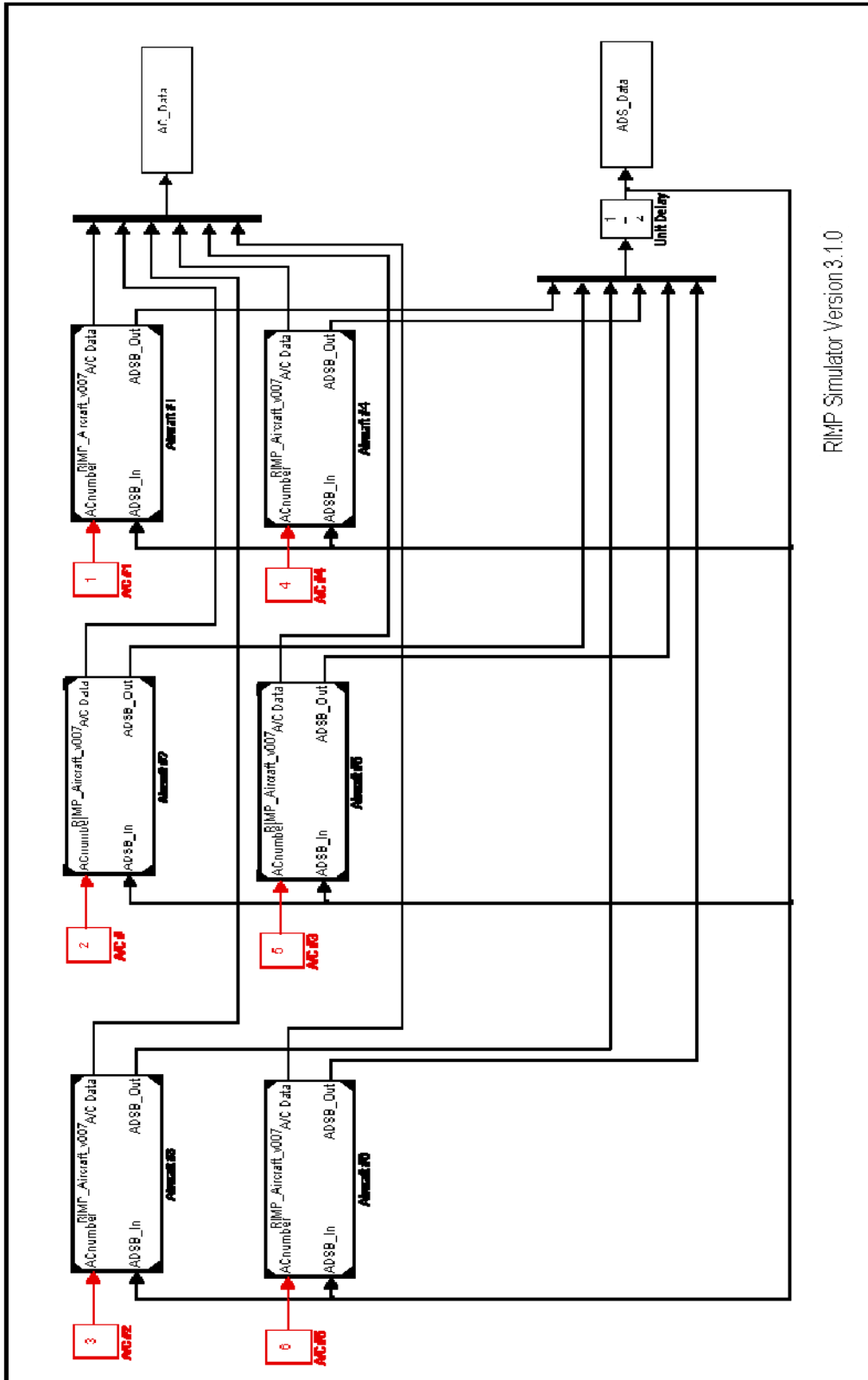

RIMP Simulator Version 3.1.0

Figure 61 Air Traffic Model in Simulink

```

% AC_Setup_5.m
% Aircraft number 5.
%
FPfilename = 'FlightPlan_BGEST_CDA1';
WindTempFi = 'BGEST_CDA1_001.txt';
ALfilename = 'AircraftLimits_767';
Temp1 = [
(TAS) [kts]                                0.          % Initial true airspeed error
                                              0.          % Initial altitude error [Ft]
                                              0.          % Initial east position error
[Nautical miles]
                                              0.          % Initial north position error
[Nautical miles]
      200.      % Start time offset [Seconds]
(AIRCRAFT) [Aircraft number]                5          % Aircraft number (ATC Sequence)
(AIRCRAFT) [Assigned reference aircraft]     4          % Assigned reference aircraft
(ATC Sequence)
      10       % Assigned reference waypoint number
      50. ]; % Nominal spacing time [Seconds]
%

```

Figure 62 Aircraft Setup File for IM Operations

The “Constants” file specifies several global simulation parameters shared by all aircraft within the stream. Figure 63 provides an example as used in the current simulation study.

```

0.05 % 1- Reference linear acceleration [g]
1.5  % 2- Reference rate of turn [deg/sec]
0.5  % 3- Reference rate of vertical flight path [deg/sec]
100.0 % 4- Waypoint capture tolerance (meters)
1.0  % 5- Course track capture tolerance (deg)
10.0 % 6- Reference RIMP Delta Velocity (Delta V Reference) [kts]
0.0  % 7- Reserved
0.0  % 8- Reserved
0.01 % 9- Flight path correction constant (deg/m)
0.0  % 10- Reserved
0.0  % 11- Reserved
0.0  % 12- Reserved
-1   % 13- Random Sequence Initial Seed (-1 = CLOCK)
0.0  % 14- Wind Error Mean [m/s]
5.0  % 15- Wind Error Standard Deviation (m/s) -----
5.0  % 16- Start time offset standard deviation (sec) -----
0.0  % 17- Reserved
38.16081600 % 18- Zero Reference Latitude, degrees
-85.74017300 % 19- Zero Reference Longitude, degrees
0.0  % 20- Zero Reference Altitude, Meters
%-----
%

```

Figure 63 Global Simulation Constants

The MATLAB random number generator is used to generate a pseudo-random sequence used for all of the signals that have uncertainty associated with them. The random sequence is initialized at the start of each simulation run. When the random seed is set to “-1” (Constant array element 13) the random sequence is initialized using the computer time. This is the default setting for all the uncertainty terms in the RIMP simulator. The wind uncertainty mean and standard deviation terms as well as the standard deviation for the start time uncertainty are set in the Constant array (Figure 63) as well. The mean and standard deviation values for sensor noise are set in the “Sensor Parameter” data file (Figure 59).

### **11.3.3 Monte Carlo Simulation**

The MATLAB script file “*RIMP\_MonteCarlo.m*” is used to execute a Monte Carlo analysis using the air traffic control simulation model. The simulation model is setup for a pre determined run duration (3600 seconds in this case) and is repeatedly executed by the Monte Carlo script file. At the end of each simulation run, the desired statistics are computed and stored. The random sequence is initialized based on the current computer time and thus each run will have a different initial seed.

## **11.4 RIMP Study Design**

### **11.4.1 RIMP Study Plan and Approach**

This study evaluates the RIMP operations while performing a CDA procedure into Louisville, Kentucky (SDF). The arrival procedure is based on the “BGEST ONE” arrival. This is a continuous descent and approach to runway 35L at SDF developed by UPS.

The study will be performed in three stages. The first stage is the baseline configuration of the air traffic movement without IM operation. The impact of wind and initial start time offset in the spacing is investigated. The second stage will include one reference aircraft and one trailing aircraft performing IM operations. This simple setup will be used to evaluate the sensitivity of key metrics to initial spacing and wind uncertainty given the IM controller developed for this study. A Monte Carlo simulation setup will be used to collect the required statistical data samples.

The third stage of the study will utilize a stream of 6 aircraft performing IM operations. The intent of this part of the study is to demonstrate the stability of IM operations in a complex stream. The same metrics used for the single pair operation will be collected for each of the engaged aircraft pairings. The study will attempt to quantify the behavioral differences as the size of the aircraft stream grows. Again, Monte Carlo simulation setup will be used to collect the desired samples.

The hypothesis of this study is that airborne IM can accurately deliver a stream of interval-managed aircraft using only moderate speed variations from nominal speed profiles under conditions of X and Y uncertainty.

#### **11.4.1.1 Flight Plan**

The flight plan used for this study is a CDA procedure into Louisville, Kentucky (SDF) runway 35L. It utilizes the BGEST waypoint and hence is referred to as the “BGEST ONE” arrival. The merging point in this case is also the “start” waypoint, so each aircraft in the air traffic simulation arrives at the “start” waypoint at the prescribed initial start time. The flight plan is depicted in Figure 64.



```

% Louisville BGEST CDAL
%
% Flight Plan Data File Version 3.0
%
% Waypoint ID number
% Waypoint type (1=enroute (default), 2=turn back, 3=land)
% Waypoint Latitude (degrees decimal)
% Waypoint Longitude (degrees decimal)
% Altitude at waypoint (feet, MSL)
% IAS/Mach at waypoint (Knots/Mach)
%
% Waypoint name
%
%-----
% #, Type, Latitude, Longitude, Altitude, IAS or M, Name
%-----
FP = [
0 1 38.53117000 -91.63363900 37000 0.8 cellstr('start')
1 1 38.41999860 -89.15899780 37000 0.8 cellstr(' ENL')
2 1 38.38000000 -88.40000000 37000 0.8 cellstr('xxTOD')
3 1 38.37723889 -88.20648056 36000 0.8 cellstr('ZARDA')
4 1 38.32920278 -87.61643611 28000 0.8 cellstr('PRINC')
5 1 38.12002778 -86.40452778 11000 240 cellstr('BGEST')
6 1 38.01983055 -85.85327778 4600 190 cellstr('PTINO')
7 1 37.98333333 -85.75000000 4000 190 cellstr('BASKT')
8 1 38.02111111 -85.69444444 3000 180 cellstr('DNKIT')
9 1 38.06438889 -85.70835000 2400 170 cellstr('CRDNL')
10 3 38.16081600 -85.74017300 513 140 cellstr('RW35L')
];

```

**Figure 64 Flight Plan File for BGEST Arrival**

Figure 65 depicts the shape of the flight profile in an East-North map where the East and North axes have different scales. The IM reference waypoint is CRDNL. This defines segment number 9 of the flight plan and the 10<sup>th</sup> waypoint specified. The achieved spacing values are measured at this waypoint. The final waypoint is RWY35L. Once the aircraft arrives at this waypoint, it is commanded to maintain runway heading, rotate to a zero degree vertical flight path angle and decelerate to zero ground speed.

As shown in Figure 64, airspeed values specified as less than 1.0 are interpreted as commanded Mach numbers. Values greater than 1.0 are interpreted as IAS (or equivalent airspeed) in Knots.

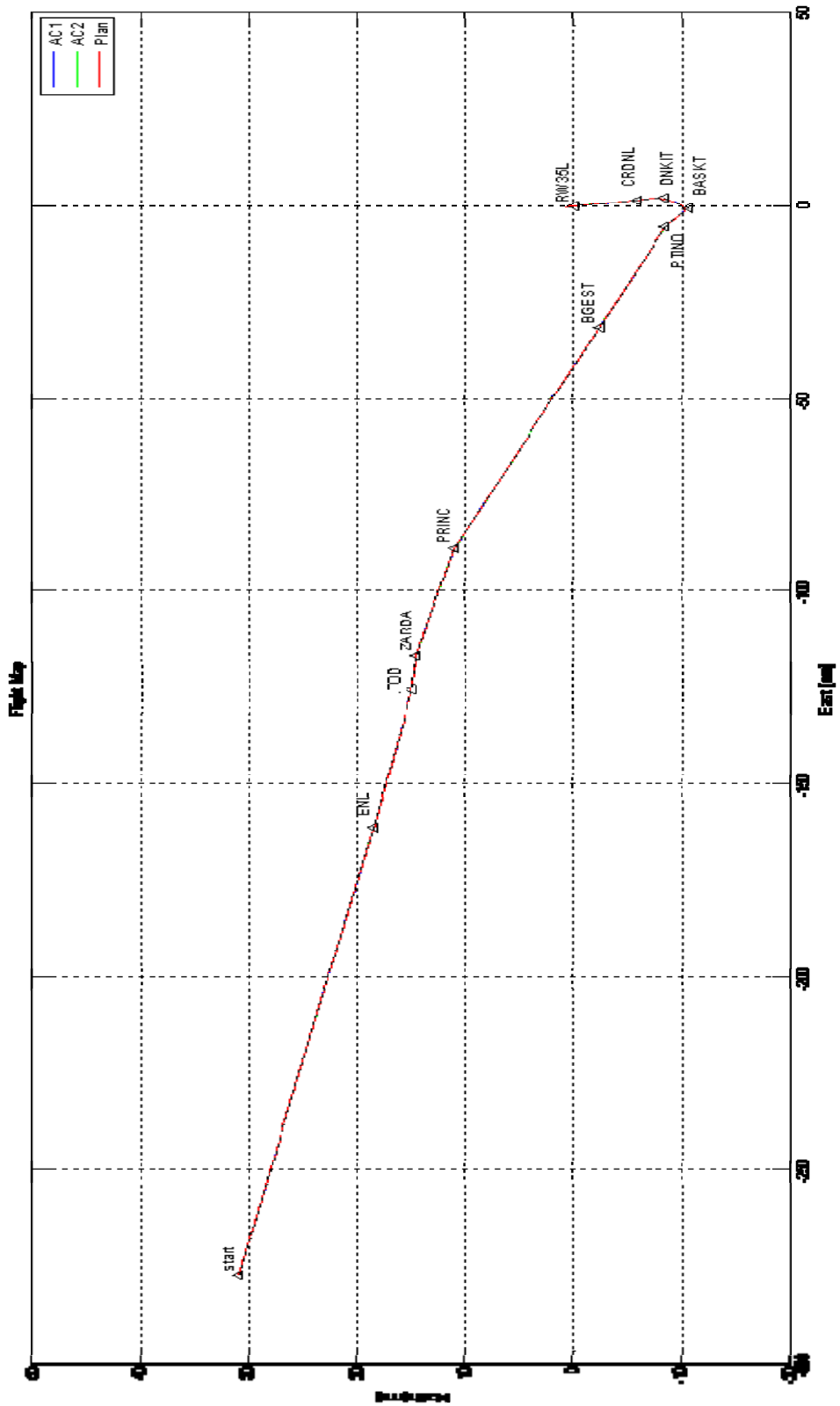

Figure 65 Flight Plan Surface Map

### 11.4.1.2 Forecast Wind and Temperature

For this analysis, the RUC data for 0800Z January 6, 2009 is used. To simplify the simulation process, a pre-processor is used to extract wind, temperature, and pressure data from the RUC data file for the specific waypoint positions, altitudes, and times as applicable. An example of a reduced data file is provided in Figure 66.

```
%  
% Wind pressure and temperature data  
% First column is waypoint number  
% Second column is East wind in meters per second  
% Third column is North wind in meters per second  
% Fourth column is static pressure in millibars  
% Fifth column is OAT in degrees Kelvin  
%  
0.0000000e+000 -6.3341029e+001 -3.2106923e+001 2.1730000e+002 2.1923351e+002  
1.0000000e+000 -6.8598146e+001 -3.3449491e+001 2.1730000e+002 2.1831580e+002  
2.0000000e+000 -7.0793884e+001 -3.1034921e+001 2.1730000e+002 2.1809949e+002  
3.0000000e+000 -7.1651931e+001 -3.2510421e+001 2.2800000e+002 2.2015837e+002  
4.0000000e+000 -5.7738696e+001 -3.2149985e+001 3.2990000e+002 2.3670349e+002  
5.0000000e+000 -1.9763707e+001 -8.0108517e+000 6.6704391e+002 2.6876573e+002  
6.0000000e+000 -5.4049351e+000 -8.5042564e+000 8.5055624e+002 2.7791416e+002  
7.0000000e+000 -3.8262500e+000 -6.1950000e+000 8.6968250e+002 2.7832625e+002  
8.0000000e+000 -3.0130864e-001 -3.1112469e+000 9.0268727e+002 2.7755280e+002  
9.0000000e+000 3.7290236e+000 -2.1433883e+000 9.2352290e+002 2.7520866e+002  
1.0000000e+001 4.1435416e+000 8.3606477e-001 9.8653519e+002 2.7357225e+002  
%
```

Figure 66 Wind Temperature and Pressure Data

## 11.4.2 Metrics

Several key metrics are relevant to interval management performance. These are provided in the order of their importance below.

### 11.4.2.1 Achieved Spacing Error

The achieved spacing error is defined as the actual time of arrival of the trailing aircraft at the reference IM point less the actual time of arrival of the lead aircraft at the same location. In the presence of various uncertainties, it is expected to have a statistically relevant sample of achieved spacing error using Monte Carlo simulation setup. Therefore the following statistics will be computed: mean, standard deviation, lower 5% tail, upper 5% tail, and absolute 95% (absolute of  $\pm$  error) statistics.

### 11.4.2.2 Frequency of IM Speed Commands

The number of speed commands per minute is a key measure of pilot workload. Several speed command frequency metrics will be considered.

- Per flight plan segment
  - Maximum
  - Average
  - 95%
- Pre-merge (Not used in this analysis)
  - Maximum
  - Average

- 95%
- During CDA
  - Maximum
  - Average
  - 95%
- Below 10,000 feet
  - Maximum
  - Average
  - 95%
- Overall
  - Maximum
  - Average
  - 95%

### **11.4.2.3 Cumulative Speed Changes**

The cumulative speed change is a measure of total true airspeed or indicated airspeed change from the planned value. It is used to measure excessive speed changes required by the IM control system.

### **11.4.2.4 Predicted Spacing Error**

The predicted spacing error is defined as the difference between the estimated TTG of the trailing and reference aircraft. A history of the predicted spacing error as the flight progresses, enables the evaluation of the validity of assumptions and simplifications made in the modeling of the IM operation.

## **11.4.3 RIMP Test Plan**

The RIMP simulation software was used to perform this study. Although the simulation can be set up with an arbitrary number of aircraft in a stream, with different aircraft performance parameters, different flight plans, and different IM control parameters, this study utilized only one type of aircraft performance and a common flight plan. Furthermore, only one forecast wind field was used for all the tests.

### **11.4.3.1 Baseline Test**

To generate a measure of basic operational parameters, a pair of aircraft flying the specified flight plan in a varied wind field and varied initial spacing is tested. The resulting data provide the necessary datum for the flight plan and simulation configurations used in this study. Also, the basic performance characteristics of the TTG estimator will be assessed. This test is completed in three steps:

- Zero wind uncertainty and unbiased initial spacing. The aircraft will have variation in sensor noise and thus there will be slight differences in flight profile.
- Include wind uncertainty but have unbiased initial spacing.
- Include both wind uncertainty and initial spacing error.

The initial spacing error is computed based on the difference between the trailing aircraft's TTG and the reference aircraft TTG when the trailing aircraft starts its simulation run. However, no IM speed change is performed during this test scenario.

### **11.4.3.2 Single Pair IM**

For this test, the reference aircraft executes the assigned flight plan and the trailing aircraft performs IM. This test is also completed in three steps:

- Zero wind uncertainty and unbiased initial spacing. Each aircraft has variation in sensor noise and thus there will be slight differences in flight profile.
- Include wind uncertainty but have unbiased initial spacing.
- Include wind uncertainty and initial spacing error; set interval time to 50 seconds.

Due to schedule constraints, the evaluation of IM operations at various interval times was not completed.

### **11.4.3.3 Large IM Stream**

This test simulates a large stream of aircraft performing IM. This includes one reference aircraft with a fixed flight plan and 5 trailing aircraft performing IM. The intent of the test is to evaluate the overall operations including accuracy and stability of the stream. Additionally, this test is desired to assess when re-negotiation of flight plans becomes necessary. This test is completed in three steps as well:

- Zero wind uncertainty and unbiased initial spacing. The aircraft will have variation in sensor noise and thus there will be slight differences in its flight profile.
- Include wind uncertainty but have unbiased initial spacing.
- Include wind uncertainty and initial spacing error; set interval time to 50 seconds.

Due to schedule constraints, the evaluation of IM operations at various interval times was not completed.

## **11.5 RIMP Study Results**

### **11.5.1 Baseline Test**

#### **11.5.1.1 Baseline Test - No Wind or Initial Spacing Error**

For these tests, the wind and start time (initial spacing) standard deviations were set to zero ("Constants" file) to effectively turn off the random terms. In addition the commanded spacing time ("Setup" file) was set to zero to disable IM operations. The resulting nominal operation is depicted in Figure 67 through Figure 76.

The altitude profile is shown in Figure 67. The aircraft maintains an altitude of 37,000 feet until arriving at the Top of Descent (TOD). Figure 68 shows the progression of the flight as subsequent segments are completed. For this particular aircraft example, the TOD occurs at approximately 1000 seconds into the simulation run and the aircraft arrives at the reference waypoint at approximately 2300 seconds into the simulation run.

Figure 69 and Figure 70 show the indicated airspeed and Mach number, flown by the aircraft, respectively. Based on the flight plan described earlier, the aircraft must maintain  $M=0.8$  until arriving at the BGEST waypoint. However, during descent, the indicated airspeed increases. Upon reaching a nominal airspeed value specified in the aircraft limit file (in this case 310 Knots), the flight control system limits the commanded speed to maintain the specified indicated airspeed. This behavior is shown in the indicated airspeed (Figure 69) and Mach number (Figure 70) plots. The constant Mach number is maintained beyond the TOD (approximately 950 seconds into the run) while the IAS increases. Shortly after reaching the nominal maximum IAS of 310 Knots (approximately 1200 seconds into the run), the flight plan calls for a reduction of IAS to 240 Knots. The guidance and control systems decelerate the aircraft and maintain the commanded IAS. The acceleration and deceleration are performed at the specified rate of 0.05 g's referenced to the inertial speed of the aircraft.

The true airspeed achieved using the specified Mach/IAS speed profile is shown in Figure 71. As expected, during descents, the true airspeed linearly varies between waypoints. The true airspeed signal along with measured wind magnitude and direction, as shown in Figure 72, are used to compute the ground speed for the aircraft. The wind profile shown does not include any added uncertainty. It is the forecast winds at each waypoint location and altitude, and is linearly interpolated between waypoints. The ground speed signal is depicted in Figure 73, showing the nearly linear variation of ground speed from one waypoint to the next as the aircraft progresses through the flight plan.

Although the ground speed generally varies linearly between waypoints, during certain portions of the descent, there are significant differences between the planned and actual velocity profile due to IAS limiting. The TTG estimator currently implemented in the simulation model accounts for the linearly varying ground speed, but it does not fully account for the possible large speed differences. During certain long segments of the flight plan, a difference between the planned speed profile and actual speed profile will result in substantial Estimate Time Enroute (ETE) error for that segment. This introduces significant problems in the interval management since the total TTG is based on the summation of individual segment ETE. These problems will be addressed later in this section.

The rate of climb profile is shown in Figure 74. Although the change in altitude and resulting total energy change is fairly smooth (as shown in Figure 67), the change in air-relative and inertial velocities during descent requires fairly noticeable change in the rate of climb while performing this continuous descent.

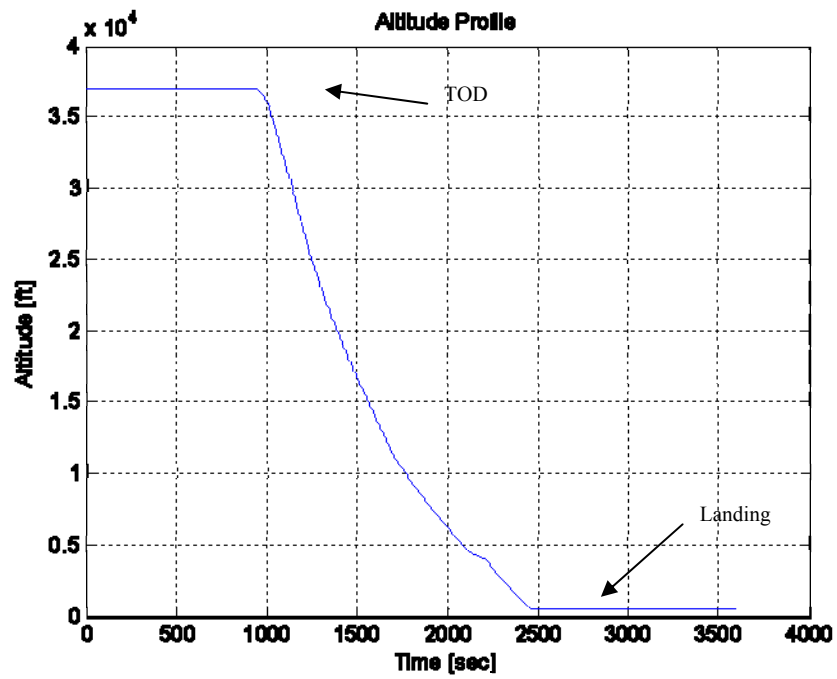

Figure 67 Altitude Profile

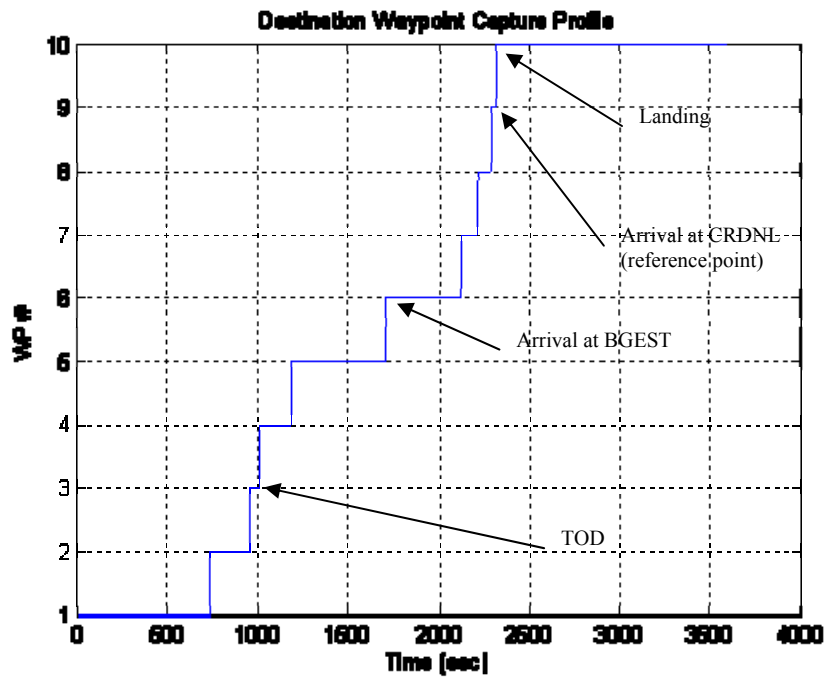

Figure 68 Flight Segment Completion Histories

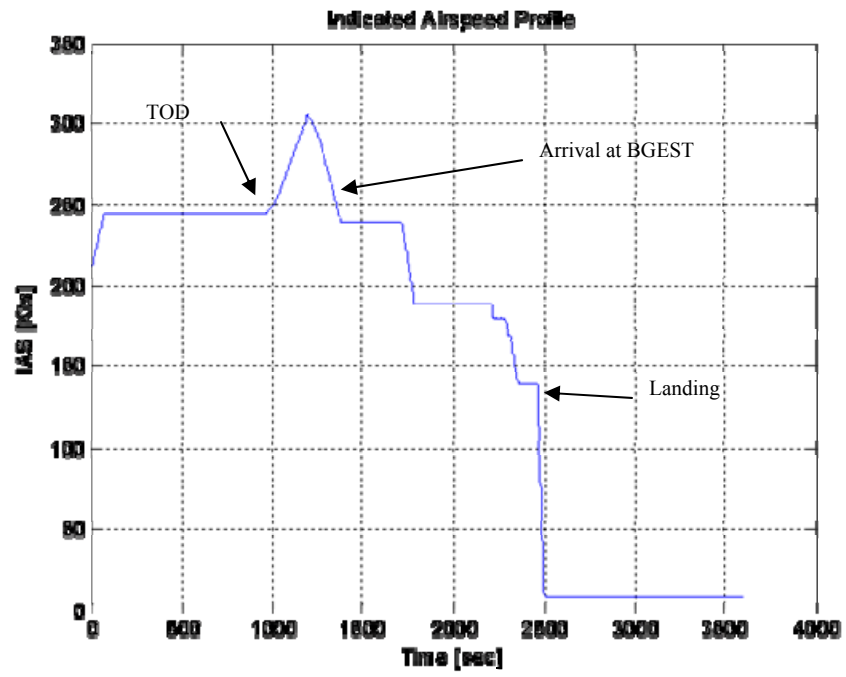

Figure 69 Indicated Airspeed Profile

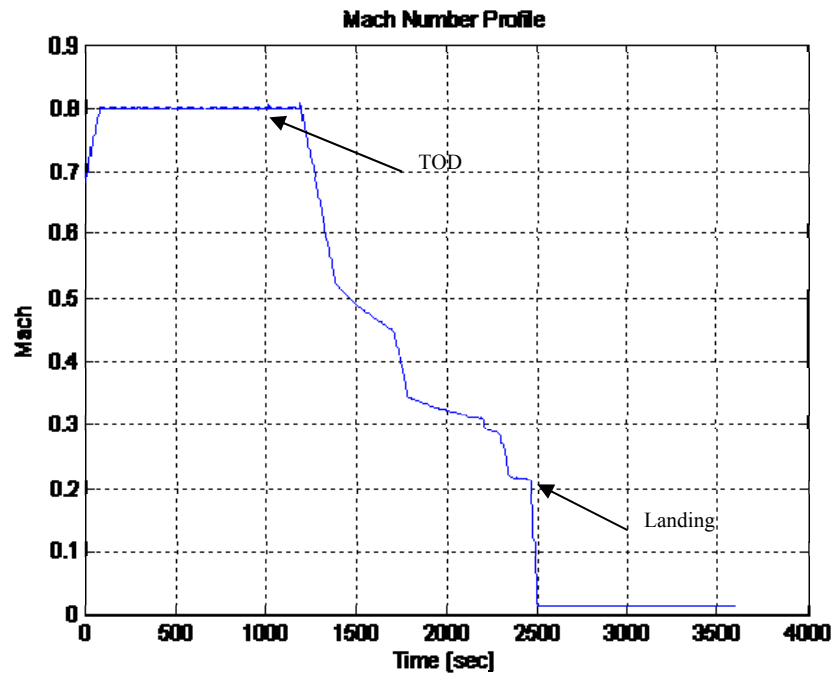

Figure 70 Mach Number Profile



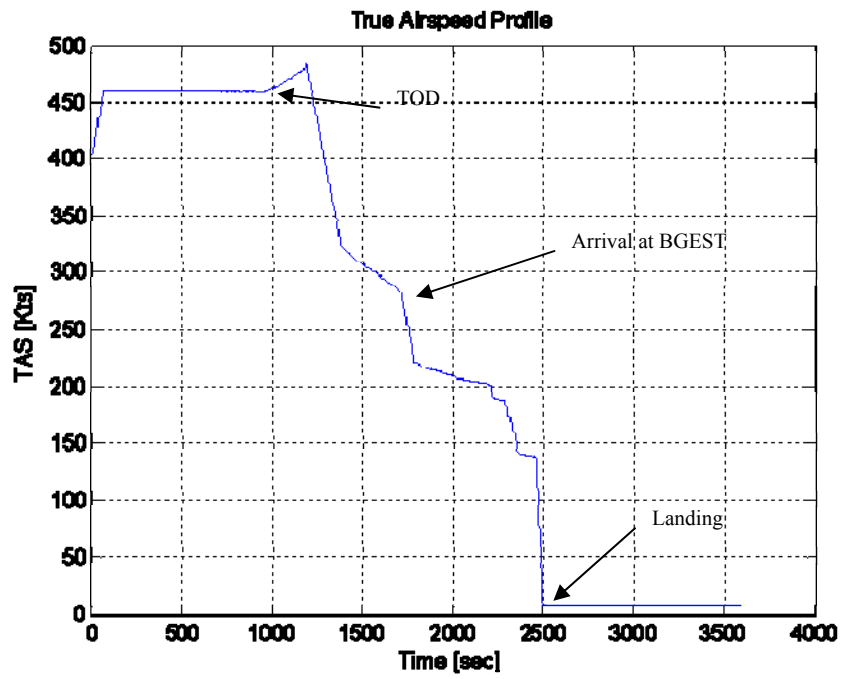

Figure 71 True Airspeed Profile

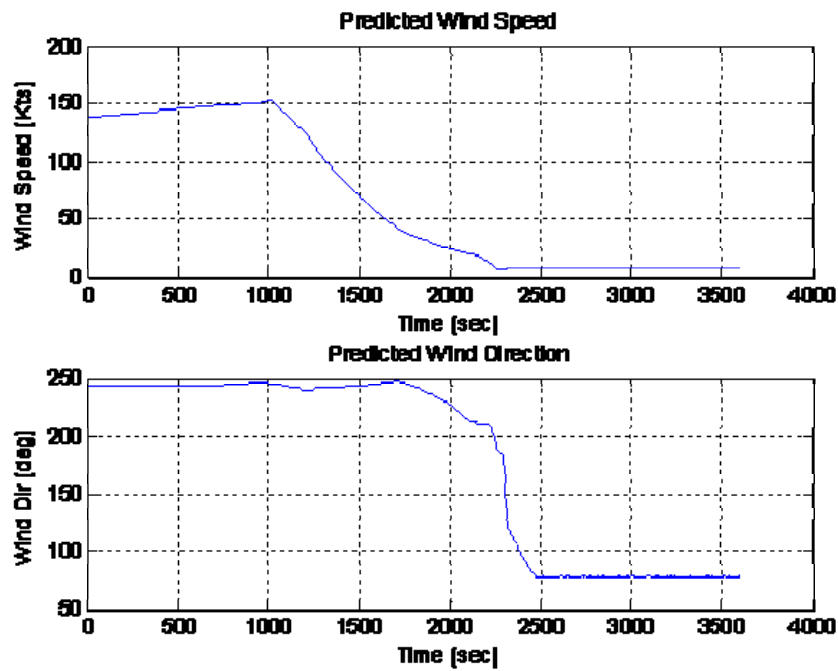

Figure 72 Measured Wind Magnitudes and Direction

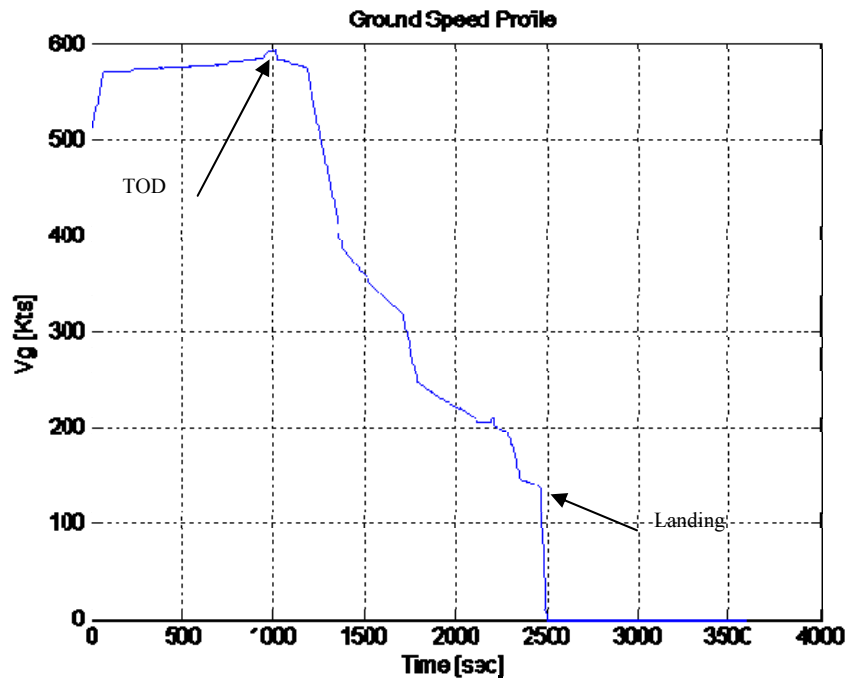

Figure 73 Resulting Ground Speed

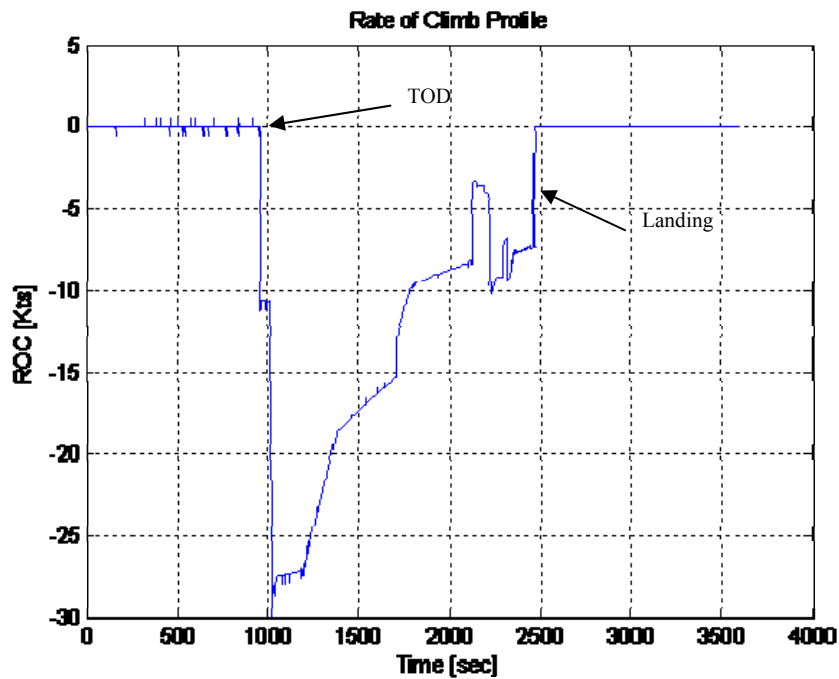

Figure 74 Rate of Climb Profile

The navigation module within each aircraft model computed the instantaneous along-track distance to the waypoint for each segment of the flight plan. This output is shown in Figure 75. This shows the distance flown for each waypoint as a function of simulation run time. The

along-track distance is adjusted to account for initial and final turns from the previous segment track and to the next segment track.

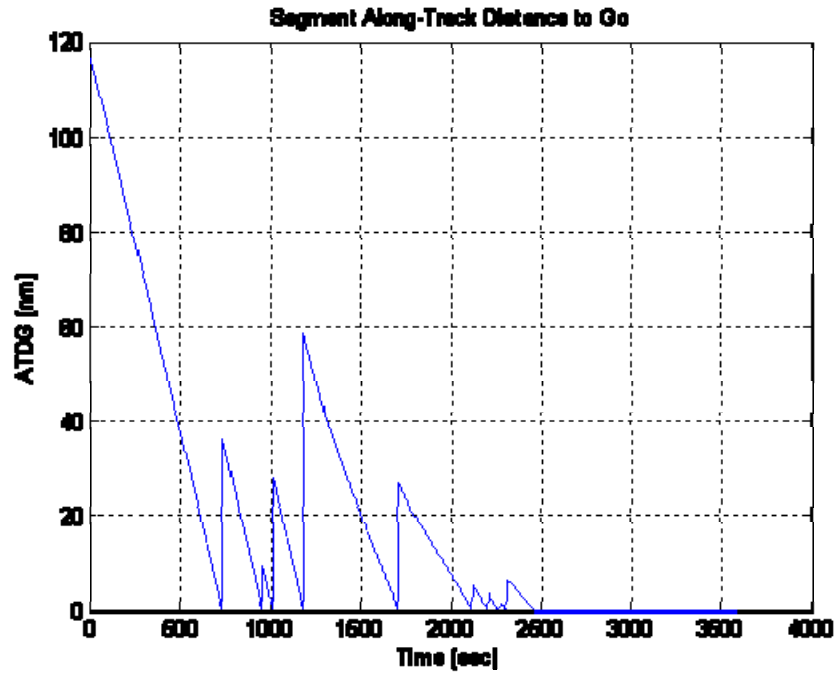

Figure 75 Along-Track Distance to Go for Current Segment

The estimated TTG is depicted in Figure 76. Ideally, the TTG signal is smooth with a slope of -45 degrees. However, as shown in this figure, any difference between the planned ground speed and actual ground speed will result in “kinks” in the TTG curve. The TTG from the current waypoint  $k$  to the reference waypoint  $n$  is computed using the ETE for the current segment and all the future segments.

$$TTG = ETE_k + \sum_{i=k+1}^n ETE_i \quad (135)$$

In the current implementation of the TTG estimator, ETEs for all future segments are computed based on planned speeds and forecast winds. The current segment ETE uses the current measured ground speed of the vehicle and assumes that the aircraft will linearly decelerate to the planned speed at the waypoint. As a result of this assumption, variations in the achieved speed at the waypoint will result in a vertical shift in the TTG curve as shown in Figure 76 at 1200 and 1700 seconds into the run. The significant jumps shown at the point of crossing the PRINC and BGEST waypoints are due to larger differences between the planned and actual ground speeds and the length of segments associated with these speeds.

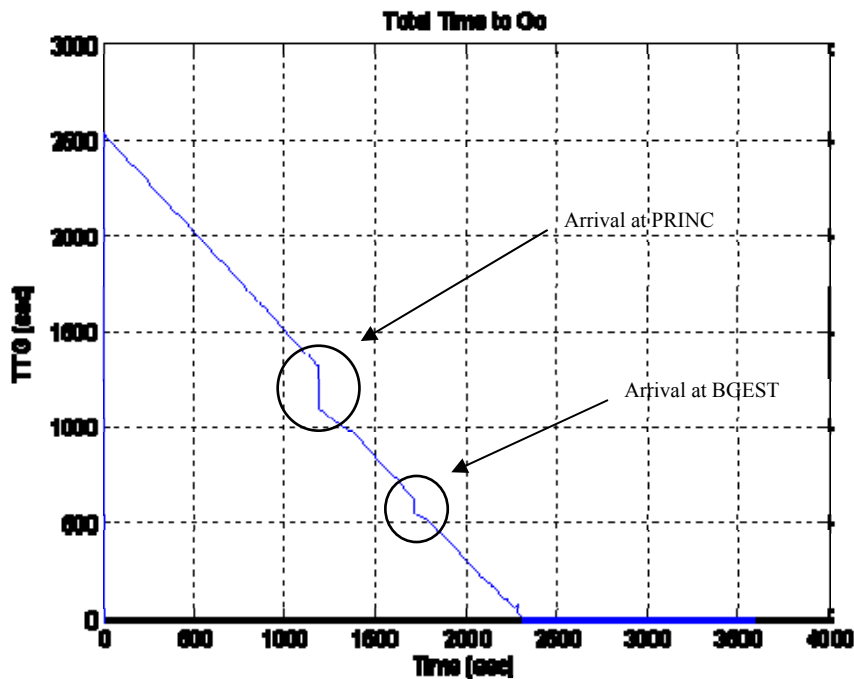

Figure 76 Computed TTG for Nominal Case

The achieved spacing for the baseline case with no wind uncertainty and no start time error is  $50 \pm 1$  seconds, which is the nominal start time offset. The resolution of the simulation data is 1 second.

### 11.5.1.2 Baseline Test - With Wind Uncertainty

For these tests, the random wind components were activated with a mean of zero and a standard deviation of 5 meters per second for both the East and North winds. The standard deviation for the start time (initial spacing) uncertainty was set to zero. In addition, the commanded spacing time (“Setup” file) was set to zero to disable IM operations. The initial spacing was fixed at 50 seconds. In this setup, neither aircraft is performing IM nor adjusting speed to achieve a Required Arrival Time (RTA). In this case, the difference between the time of arrival of the lead aircraft and the trailing aircraft at the reference waypoint is referred to as the “equivalent” spacing.

A total of 500 simulation runs were conducted. Figure 77 shows a histogram of the equivalent spacing at the reference waypoint with wind uncertainty and with IM operations disabled. Due to limited sample size, this histogram only roughly represents a normal distribution about the nominal 50 seconds of separation at the reference waypoint. A list of statistics for this case is provided in Table 7: Statistics for baseline test case with wind uncertainty. The collected time-based data has a sample rate of 1 second. Therefore, resolution of the statistics presented here is  $\pm 1$  second.

**Table 7: Statistics for baseline test case with wind uncertainty**

Mean Value for equivalent spacing	49.4 seconds
Standard Deviation	35.2 seconds
Maximum equivalent spacing	160 seconds
Minimum equivalent spacing	-54 seconds

Figure 78 provides an example of the predicted spacing signal between the lead aircraft and the ownship given the wind uncertainty. The large spikes in predicted spacing signal are due to the nature of the TTG estimated signal described in section 11.5.1.

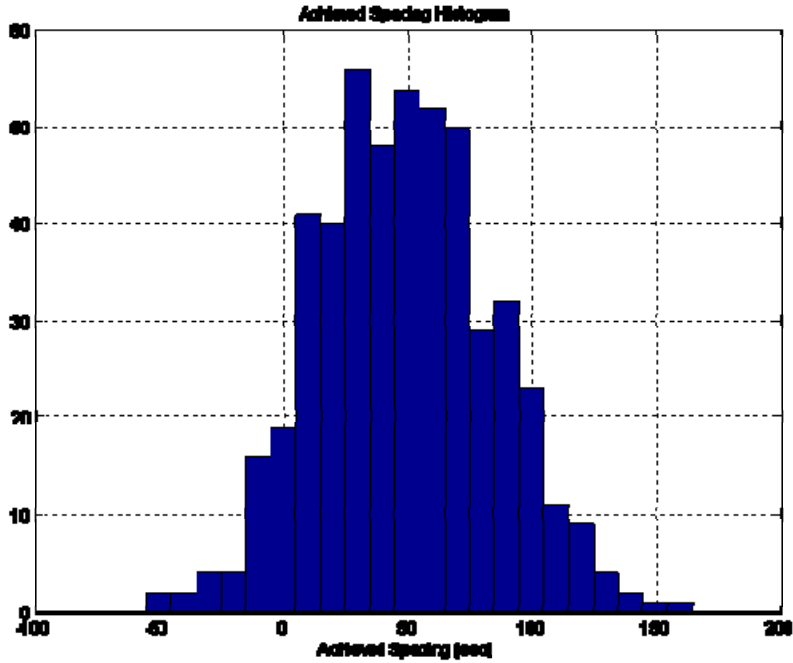

**Figure 77 Distribution of Final Spacing with Wind Uncertainty and no IM**

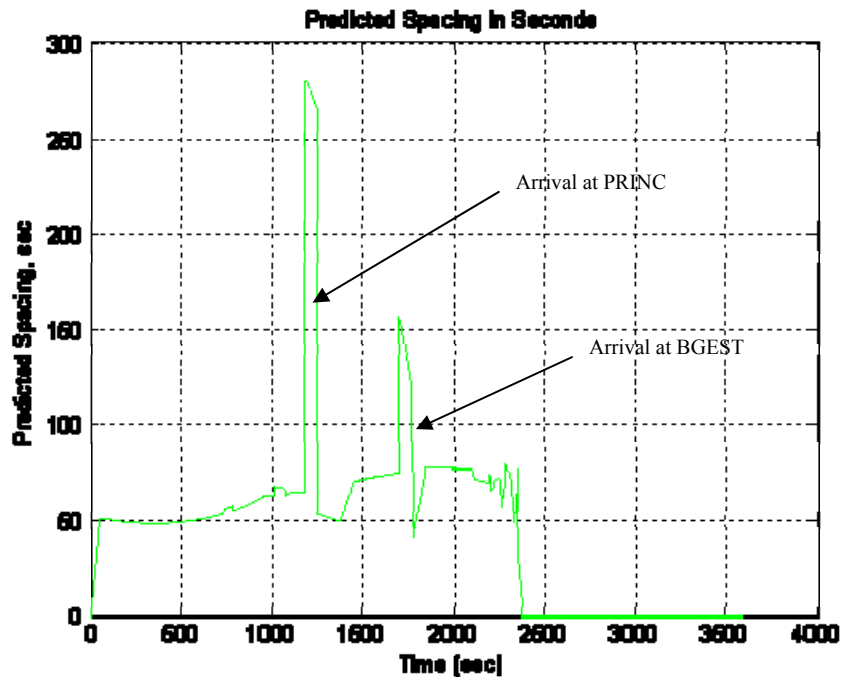

Figure 78 Predicted Spacing Signal

### 11.5.1.3 Baseline Test - With Wind and Initial Spacing Uncertainty

For these tests, the random wind components are activated with a mean of zero and a standard deviation of 5 meters per second for both the East and North winds. The standard deviation for the start time (initial spacing) uncertainty is set to 5 seconds. In addition, the commanded spacing time (“Setup” file) is set to zero to disable IM operations. The initial spacing was fixed at 50 seconds. As with previous test described in section 11.5.2, neither aircraft is performing IM nor adjusting speed to achieve a RTA. The difference between the time of arrival of the lead aircraft and the trailing aircraft at the reference waypoint is referred to as the “equivalent” spacing.

A total of 500 simulation runs were conducted to arrive at the results. Figure 79 shows a histogram of the equivalent spacing at the reference waypoint with wind and initial uncertainty, and with IM operations disabled. The “rough” shape of the distribution is due to limited sample size. The expected nominal shape of the histogram is a normal distribution about the nominal 50 seconds of separation at the reference waypoint. A list of statistics for this case is provided in Table 8. The resolution of the statistics presented here in this table is  $\pm 1$  second. Qualitatively, the distribution of equivalent spacing at the reference waypoint is comparable to the distribution for the case with wind uncertainty only.

**Table 8: Statistics for baseline test case with wind and initial spacing uncertainty**

Mean Value for achieved spacing	48.4 seconds
Standard Deviation	36.7 seconds
Maximum achieved spacing	143 seconds
Minimum achieved spacing	-45 seconds

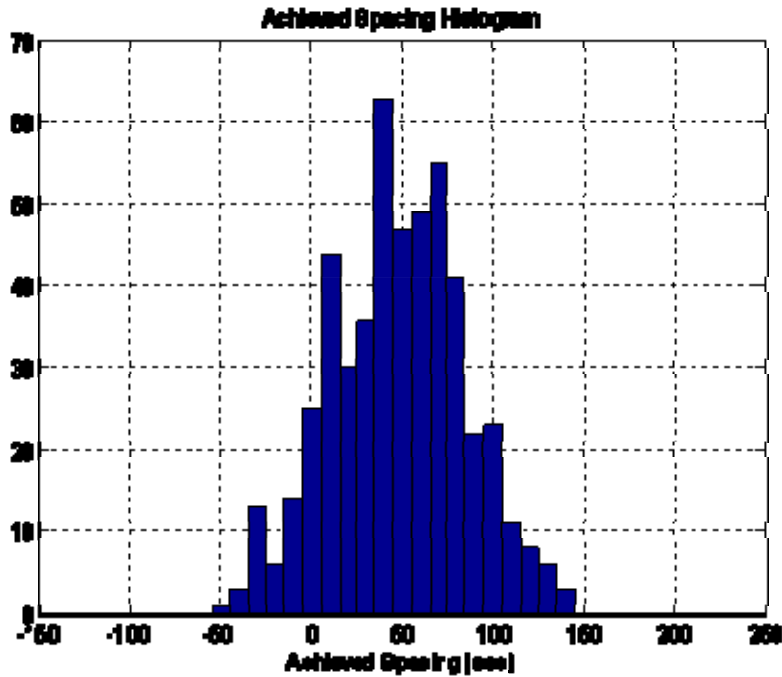

Figure 79 Final Spacing with Wind and Initial Spacing Uncertainty and no IM

## 11.5.2 Single Pair IM

### 11.5.2.1 Single Pair IM - No Wind or Initial Spacing Uncertainty

For these tests, the random wind components and the initial spacing uncertainty are deactivated by setting the standard deviations to 0. The commanded spacing time (“Setup” file) is set to 50 seconds for the in-trail aircraft (aircraft number 2) in order to activate the IM operation.

A total of 250 simulation runs were conducted to arrive at the results. Zero wind or initial spacing uncertainty was included and the timing signal was collected at a rate of once per second. The simulation includes random noise and variation in the sensor model, however, the guidance and control system for each aircraft compensates for this variation within the once per second output signal resolution. As a result, the IM system response is strictly deterministic. Figure 80 shows a histogram of the achieved spacing at the reference waypoint. Since the response is deterministic, all the achieved spacing values fall within the 52 second frame. Figure 81 provides a histogram of the IM frequency (number of IM speed commands per minute) averaged over the total duration of the operation. This indicates an average IM speed command frequency of less than 1 per minute. Figure 82 provides a histogram of the IM frequency (per

minute) for that portion of operation below an altitude of 10,000 feet. The results indicate an IM frequency of less than 2 per minute below 10,000 ft. Figure 83 shows a histogram of IM frequency (per minute) for each segment of the flight plan. It is evident that all the “high activity” IM actions with a frequency of 2 per minute or higher occur during the final three segments of the operation.

The basic statistics associated with the IM operation are listed in Table 9.

**Table 9: Statistics for single pair IM test case without uncertainty**

Mean Value for achieved spacing	52 seconds
Standard Deviation	0 seconds
Maximum achieved spacing	52 seconds
Minimum achieved spacing	52 seconds

Mean Value for IM frequency, total	0.5337 per minute
Standard Deviation	0
Maximum	0.5337
Minimum	0.5337

Mean Value for IM frequency, below 10K	1.59 per minute
Standard Deviation	0
Maximum achieved spacing	1.59
Minimum achieved spacing	1.59

Mean Value for IM frequency, Seg. #1	0 per minute
Mean Value for IM frequency, Seg. #2	0
Mean Value for IM frequency, Seg. #3	1.09
Mean Value for IM frequency, Seg. #4	0.70
Mean Value for IM frequency, Seg. #5	0.35
Mean Value for IM frequency, Seg. #6	0.43
Mean Value for IM frequency, Seg. #7	2.73
Mean Value for IM frequency, Seg. #8	3.33
Mean Value for IM frequency, Seg. #9	6.25



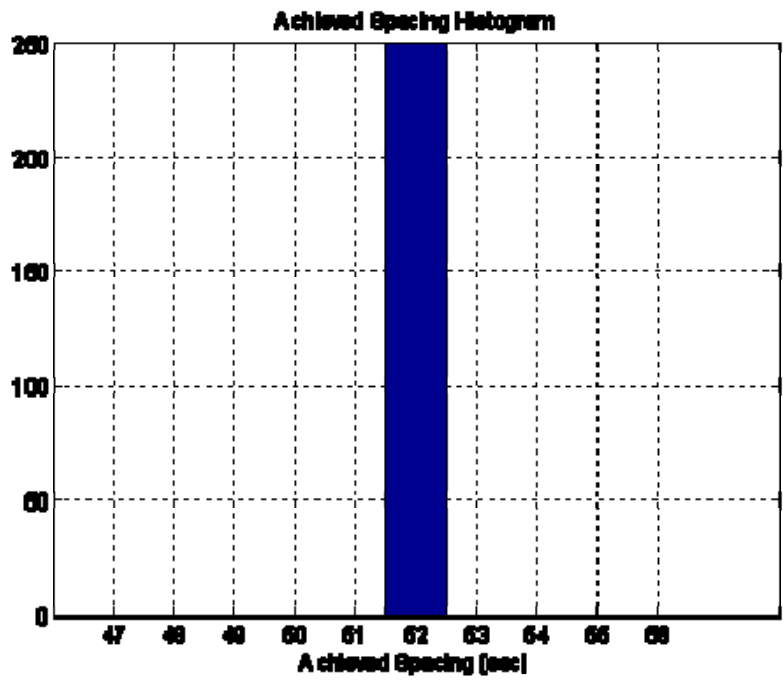

Figure 80 Achieved Spacing Histogram

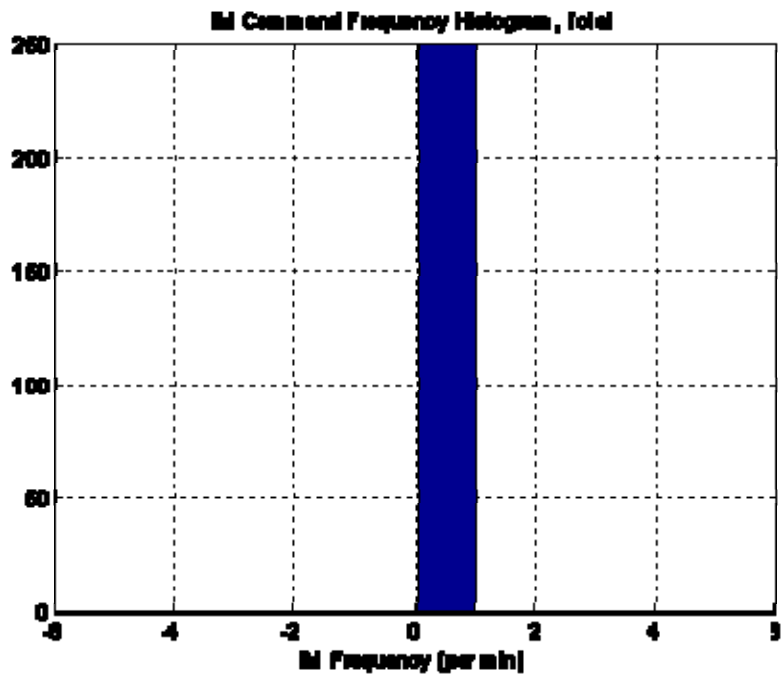

Figure 81 IM Frequency Histogram Total Operation

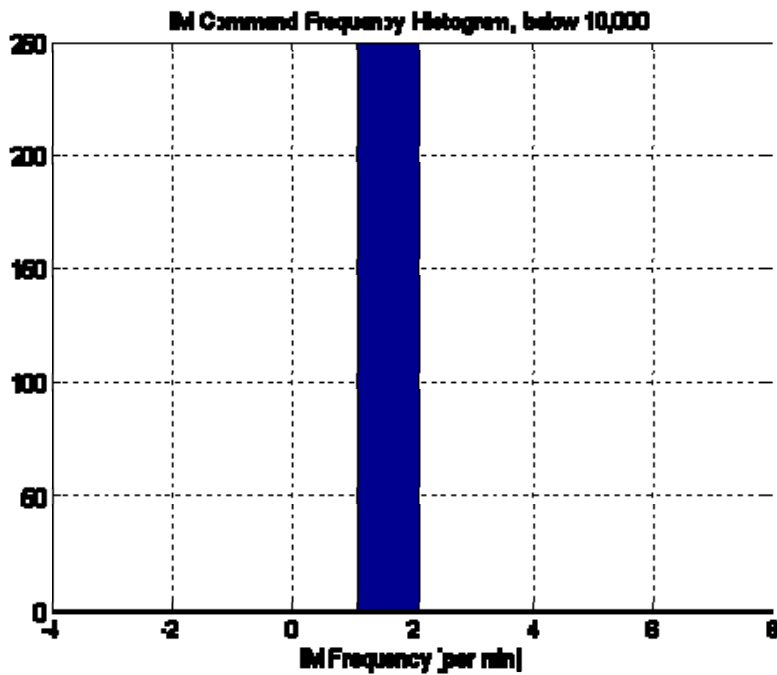

Figure 82 IM Frequency Histogram below 10K

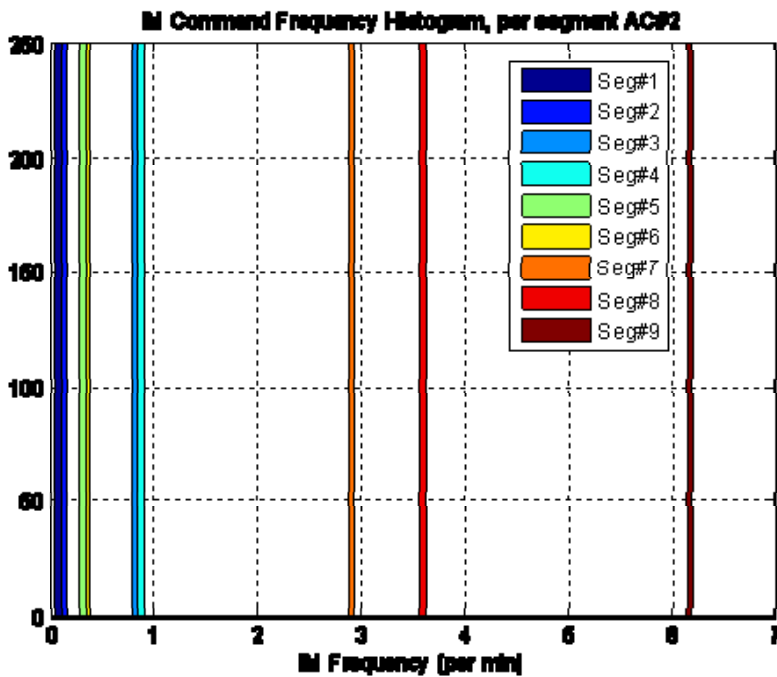

Figure 83 IM Frequency Histogram per Segment

Figure 84 provides an example of the estimated interval and the resulting IM command signal. The estimated interval is computed as the difference between the ownship TTG and reference aircraft TTG. The current implementation does not include any form of filtering for this signal

and as described before, ground speed variation between the planned and actual flight operations introduce large enough differences to adversely impact the IM operation. As shown in this figure, an apparent error of 200 seconds in interval time is estimated as the reference aircraft passes the PRINC waypoint at approximately 1200 seconds into the simulation. Once the trailing aircraft passes through the same waypoint, the estimated interval returns to a more accurate level. This error in interval time is caused by the assumptions in the TTG estimator. The IM controller attempts to correct the 200 seconds excess in interval time by commanding a higher speed. Once the trailing aircraft passes the PRINC waypoint, the TTG estimate for the ownship is similarly reduced and the interval time used by the IM controller is abruptly reduced by more than 200 seconds.

Therefore, it can be seen that modifications to the TTG estimator are needed before any IM control optimization can be attempted. An estimation scheme that avoids the observed jumps in the TTG calculation is required for this operation.

Additionally, no attempt is made in this analysis to abort the IM operation if an excessive IM error is encountered. For future studies, a method for aborting IM operation and reengaging such operation must also be developed and implemented.

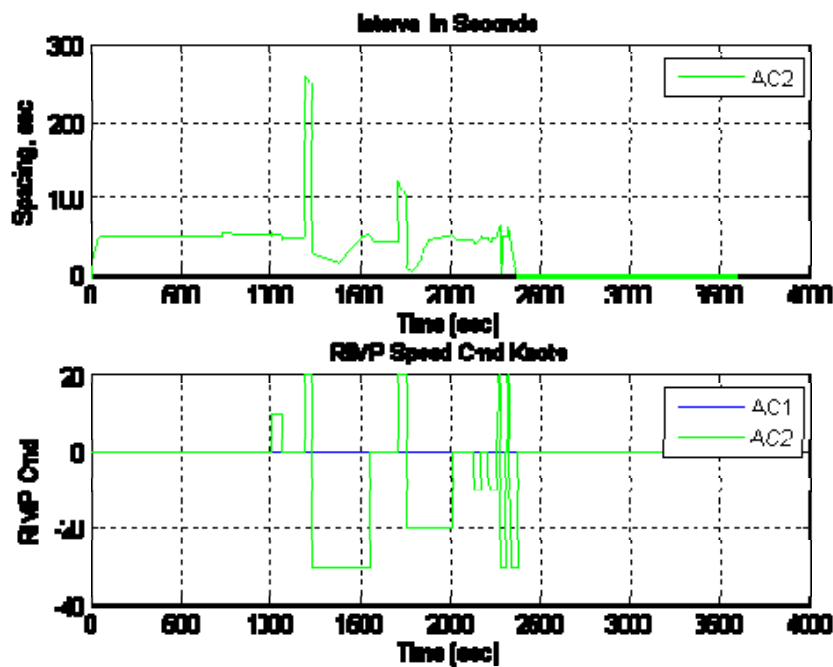

Figure 84 Estimated Spacing and IM Command History

### 11.5.2.2 Single Pair IM - With Wind Uncertainty

For these tests, the random wind components are activated with a mean of zero and a standard deviation of 5 meters per second for both the East and North winds. The standard deviation for

the start time (initial spacing) uncertainty is set to zero. In addition, the commanded spacing time (“Setup” file) is set to 50 seconds for the in-trail aircraft (aircraft number 2).

A total of 250 simulation runs were conducted to arrive at the results. Figure 85 shows a histogram of the achieved spacing at the reference waypoint with wind uncertainty and with the second aircraft performing IM operations. Although the available sample size is limited, the achieved spacing appears to have a normal distribution about approximately 51 seconds. This is consistent with the spacing signal resolution of 1.0 second.

The IM speed change frequency (per minute) averaged over the total duration of the operation is shown in Figure 86. This histogram depicts an average IM frequency of 0.5 speed changes per minute. Figure 87 provides a histogram of the IM frequency (per minute) for that portion of operation below an altitude of 10,000 feet. Approximately 1.5 to 2 speed change events per minute are depicted as average below 10,000 ft. Figure 88 shows a histogram of IM frequency (per minute) for each segment of the flight plan. As expected, all the “high activity” IM actions with a frequency of 2 per minute or higher occur during the final three segments of the operation (segments 7, 8, and 9). This is in part due to the simple design of the IM controller and can be significantly improved upon using a more optimized IM control scheme.

The basic statistics associated with the IM operation are listed in Table 10 below.

**Table 10: Statistics for single pair IM test case with wind uncertainty**

Mean Value for achieved spacing	51.3 seconds
Standard Deviation	5.9 seconds
Maximum achieved spacing	74 seconds
Minimum achieved spacing	11 seconds

Mean Value for IM frequency, total	0.529 per minute
Standard Deviation	0.101
Maximum	0.752
Minimum	0.225

Mean Value for IM frequency, below 10K	1.579 per minute
Standard Deviation	0.414
Maximum achieved spacing	2.584
Minimum achieved spacing	0.204

Mean Value for IM frequency, Seg. #1	0.078 per minute
Mean Value for IM frequency, Seg. #2	0.076
Mean Value for IM frequency, Seg. #3	0.443
Mean Value for IM frequency, Seg. #4	0.506
Mean Value for IM frequency, Seg. #5	0.324
Mean Value for IM frequency, Seg. #6	0.473
Mean Value for IM frequency, Seg. #7	2.589
Mean Value for IM frequency, Seg. #8	4.365
Mean Value for IM frequency, Seg. #9	4.124

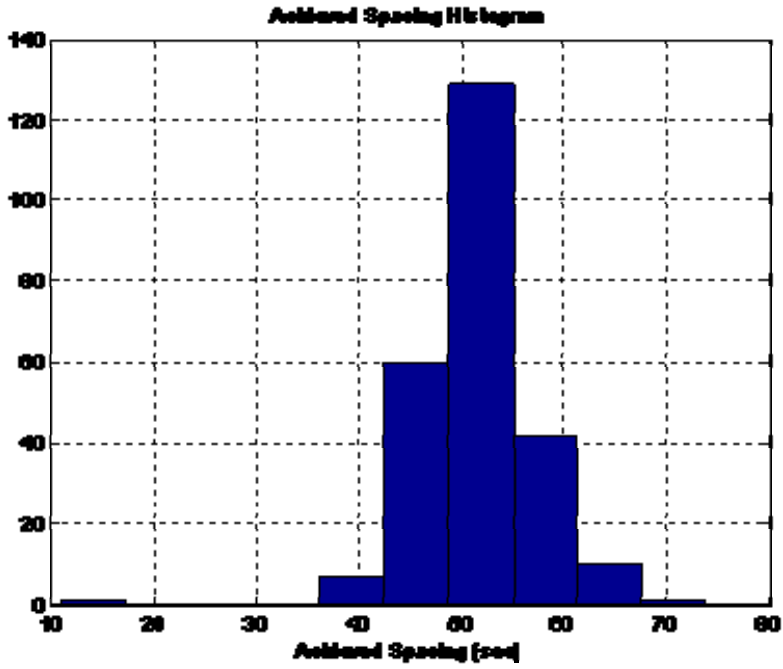

Figure 85 Achieved Spacing Histogram.

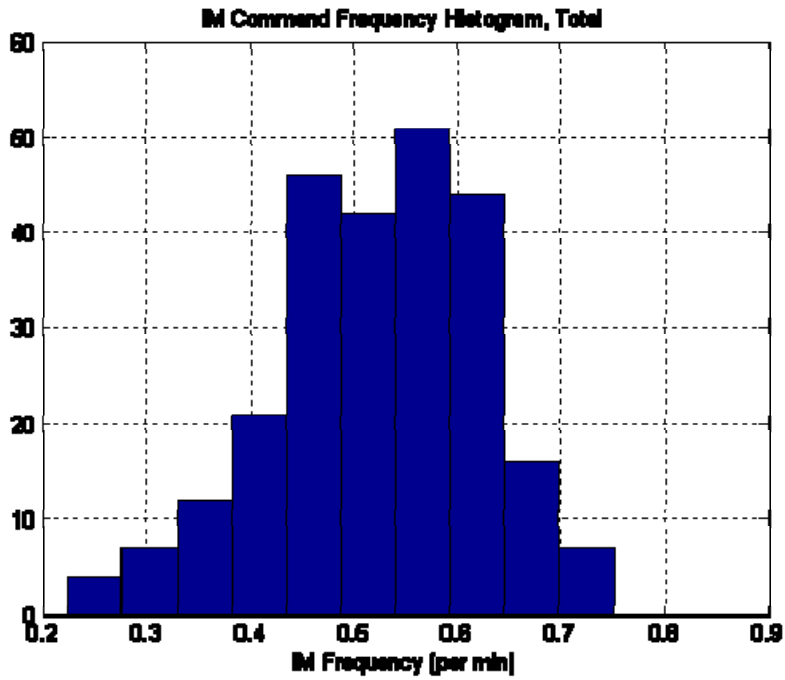

Figure 86 IM Frequency Histogram Total Operation

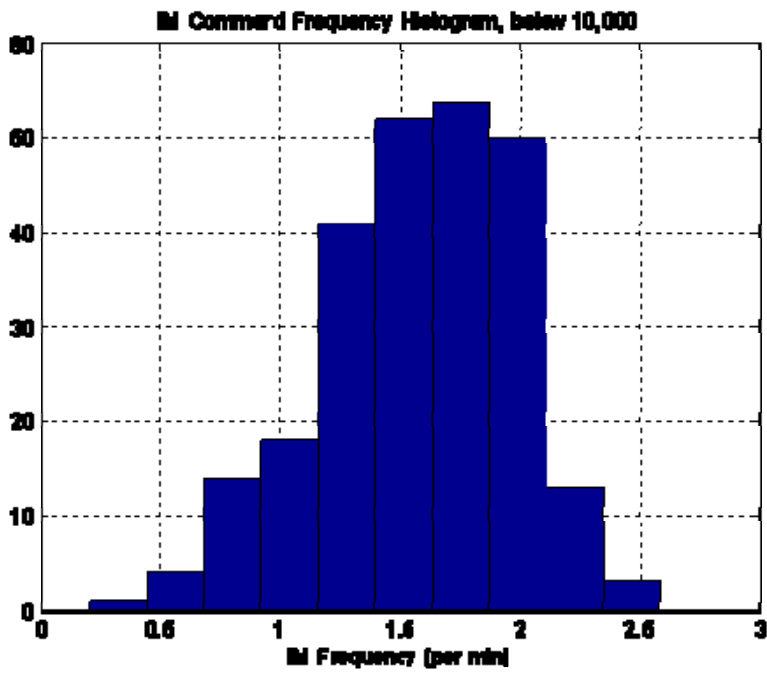

Figure 87 IM Frequency Histogram below 10K

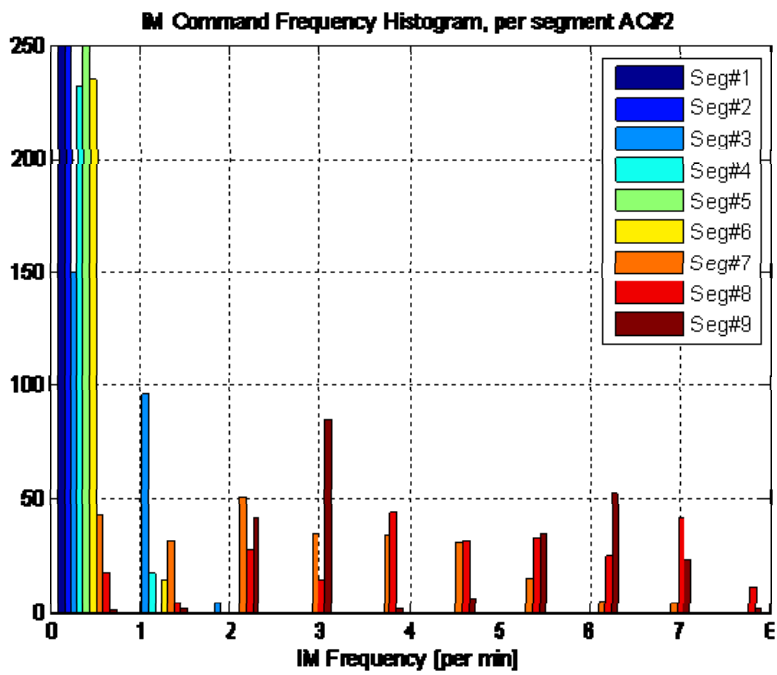

Figure 88 IM Frequency Histogram per Segment

### 11.5.2.3 Single Pair IM - With Wind and Initial Spacing Uncertainty

For these tests, the random wind components are activated with a mean of zero and a standard deviation of 5 meters per second for both the East and North winds. The standard deviation for the start time (initial spacing) uncertainty is set to 5 seconds. In addition the commanded spacing time (“Setup” file) is set to 50 seconds for the in-trail aircraft (aircraft number 2).

A total of 173 simulation runs were conducted to arrive at the results. Figure 89 shows a histogram of the achieved spacing at the reference waypoint with wind and initial spacing uncertainty and with the second aircraft performing IM operations. Figure 90 provides a histogram of the IM frequency (per minute) averaged over the total duration of the operation. Figure 91 provides a histogram of the IM frequency (per minute) for that portion of operation below an altitude of 10,000 feet. Figure 92 shows a histogram of IM frequency (per minute) for each segment of the flight plan.

Normal distributions were expected for all of the histograms presented in this section. However, due to the limited number of test runs, the distributions appear irregular. The basic statistics associated with the IM operation are listed in Table 11.

**Table 11: Statistics for single pair IM test case with wind and initial spacing uncertainty**

Mean Value for achieved spacing	51.7 seconds
Standard Deviation	5.3 seconds
Maximum achieved spacing	71 seconds
Minimum achieved spacing	34 seconds
Mean Value for IM frequency, total	0.553 per minute
Standard Deviation	0.10
Maximum	0.763
Minimum	0.278
Mean Value for IM frequency, below 10K	1.627 per minute
Standard Deviation	0.383
Maximum achieved spacing	2.491
Minimum achieved spacing	0.587
Mean Value for IM frequency, Seg. #1	0.124 per minute
Mean Value for IM frequency, Seg. #2	0.069
Mean Value for IM frequency, Seg. #3	0.418
Mean Value for IM frequency, Seg. #4	0.525
Mean Value for IM frequency, Seg. #5	0.324
Mean Value for IM frequency, Seg. #6	0.465
Mean Value for IM frequency, Seg. #7	2.784
Mean Value for IM frequency, Seg. #8	4.518
Mean Value for IM frequency, Seg. #9	4.239

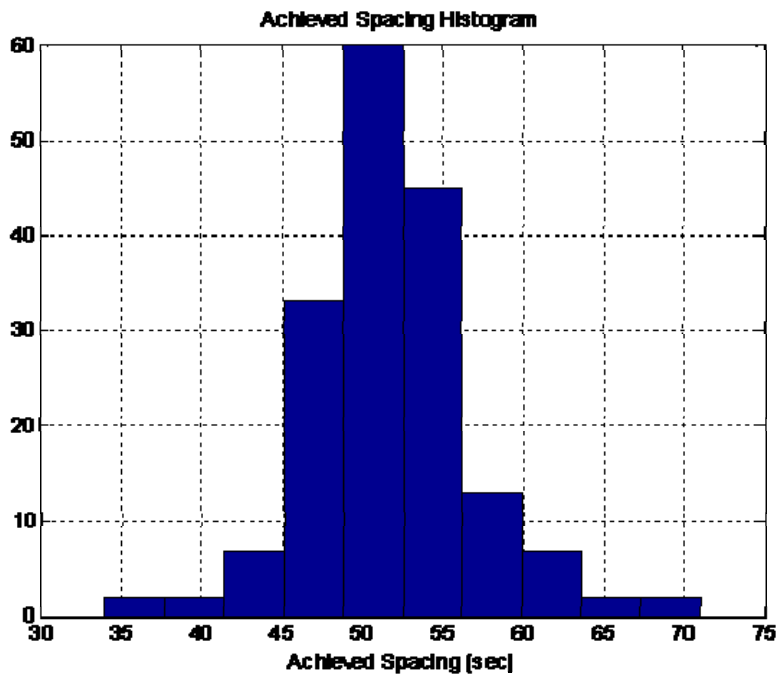

Figure 89 Achieved Spacing Histogram.

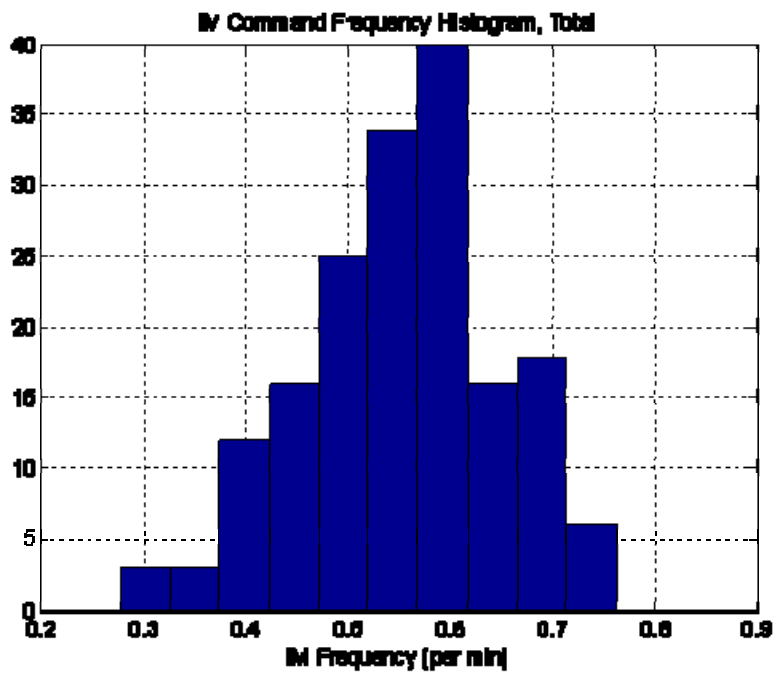

Figure 90 IM Frequency Histogram Total Operation



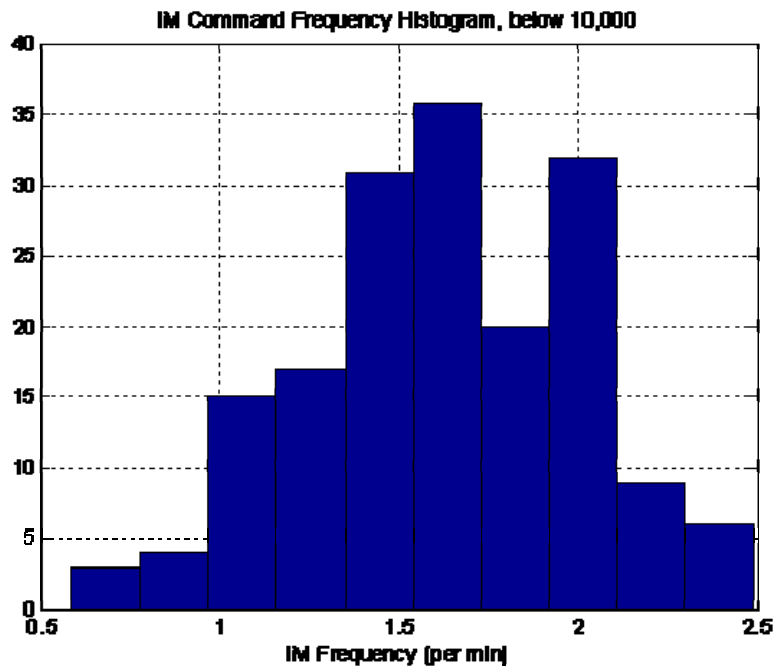

Figure 91 IM Frequency Histogram below 10K

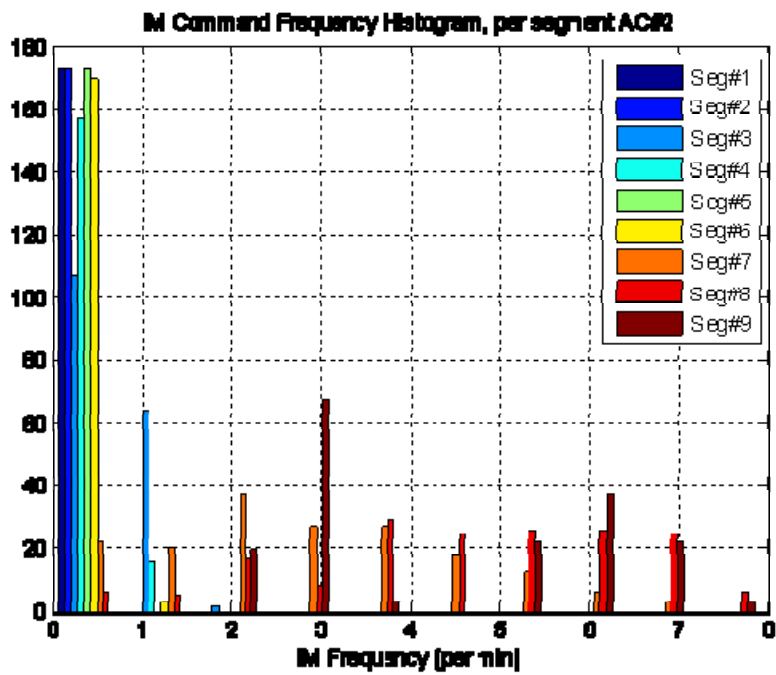

Figure 92 IM Frequency Histogram per Segment

### **11.5.3 Large IM Stream**

In this section, an IM stream of 6 aircraft is analyzed. The first aircraft follows the flight plan-specified speeds. The following aircraft perform interval management relative to the aircraft directly ahead of them.

#### **11.5.3.1 Multi Pair IM - No Wind or Initial Spacing Uncertainty**

For these tests, the random wind components and the initial spacing uncertainty are deactivated by setting the standard deviations to 0. The commanded spacing time (“Setup” file) is set to 50 seconds for the in-trail aircraft (aircraft number 2 through 6) in order to activate the IM operation. Each aircraft model contains random noise and variability in its sensor model, however, the guidance and control system for each aircraft compensates for this variation. As a result, the IM system response is strictly deterministic within the once per second output data.

A total of 250 simulation runs were conducted to arrive at the results. Figure 93 shows a histogram of the achieved spacing at the reference waypoint. The response is deterministic; however different aircraft in the IM stream achieve slightly different spacing. The second aircraft achieves a spacing of 52 seconds. Aircraft number 4 achieves a spacing of 59 seconds while aircraft number 3 consistently achieves a spacing of less than 47 seconds.

Figure 94 provides a histogram of the IM frequency averaged over the total duration of the operation. This indicates an average IM speed command frequency of around 0.5 for all aircraft. However, aircraft number 5 and number 6 are shown to have a slightly lower average IM frequency. Figure 95 provides a histogram of the IM frequency (per minute) for that portion of operation below an altitude of 10,000 feet. The results indicate an IM frequency of around 1.5 per minute below 10,000 feet for aircraft number 2, 3, and 4. Aircraft number 5 has an IM frequency of 1.1, while aircraft number 6 has an IM frequency of less than 1 per minute. Figure 96 shows a histogram of IM frequency (per minute) for aircraft number 2 at each segment of the flight plan. Figure 97 shows a histogram of IM frequency (per minute) for aircraft number 6 at each segment of the flight plan.

The mechanism for the variation in achieved spacing and IM activity among the participating aircraft is not fully investigated. This variation changes with changes to the flight plan parameters, as well as by changing the guidance, control, and IM control parameters within the simulation model. A main contributor is the significant difference between actual and estimated time enroute for certain long flight segments.

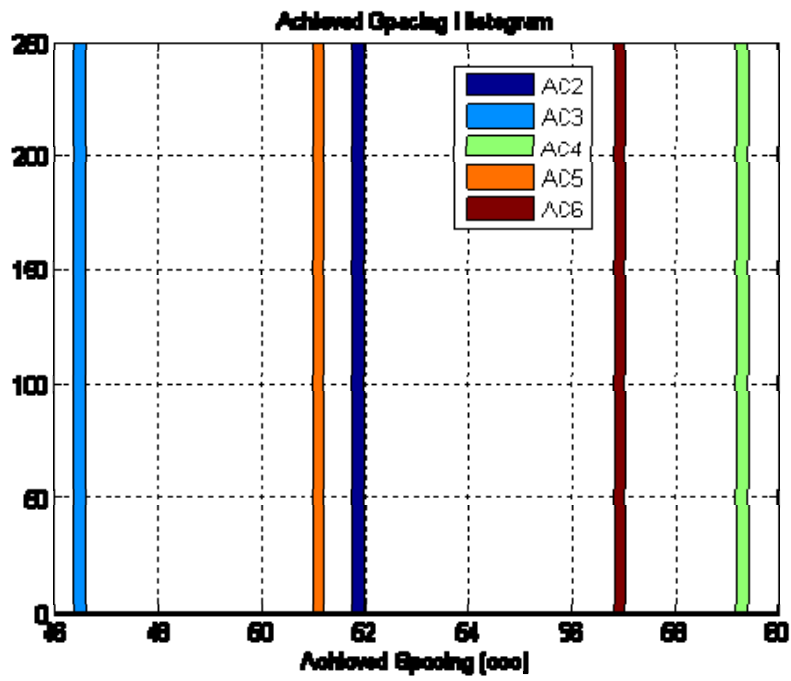

Figure 93 Achieved Spacing Histogram.

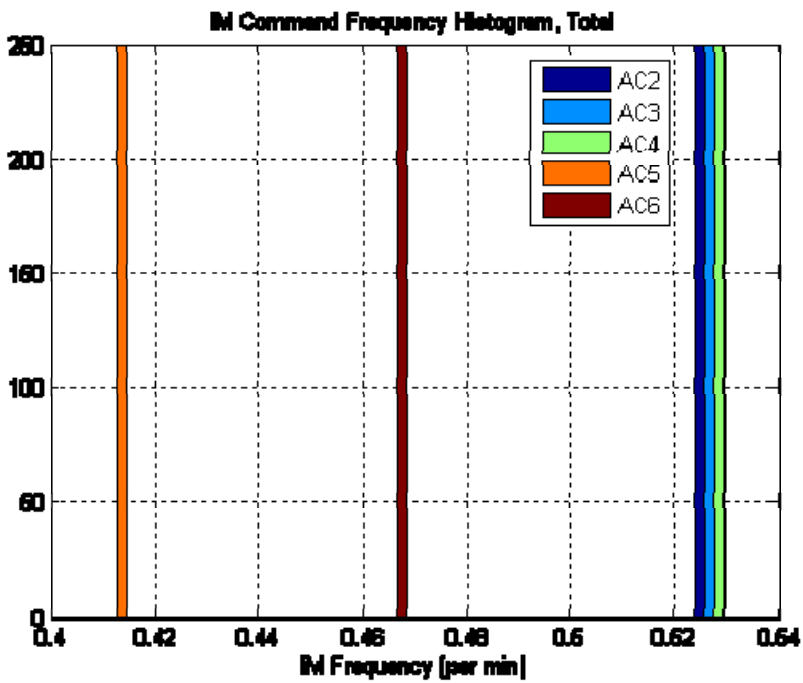

Figure 94 IM Frequency Histogram Total Operation

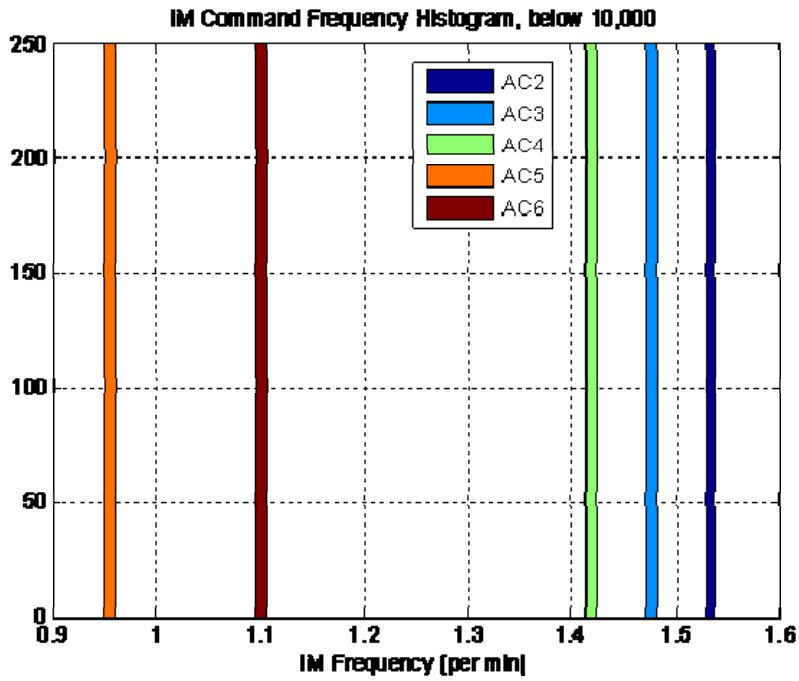

Figure 95 IM Frequency Histogram below 10K

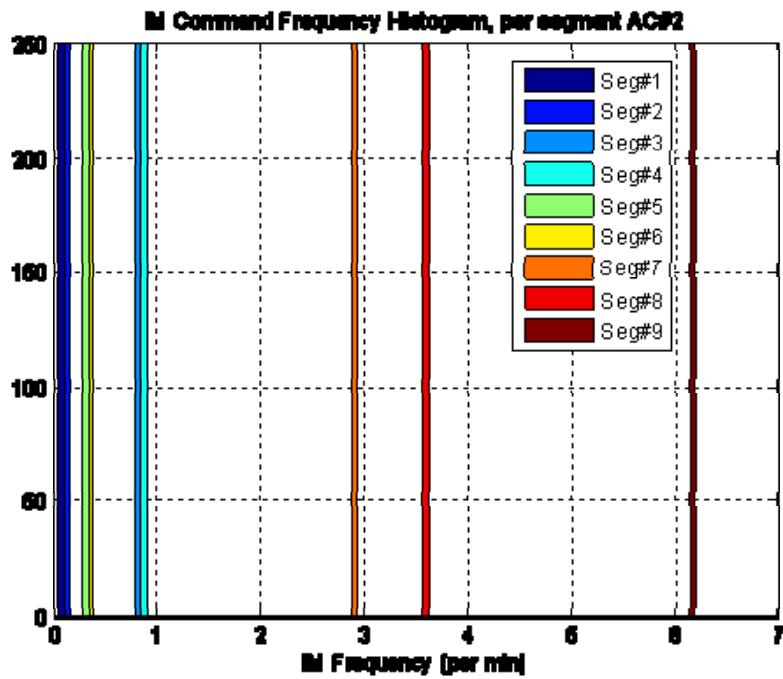

Figure 96 IM Frequency Histogram per Segment AC#2

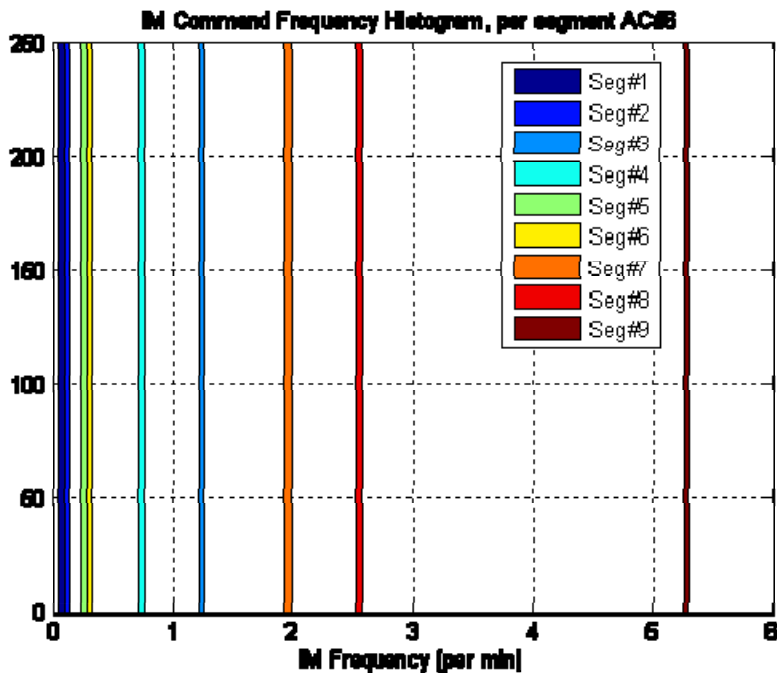

Figure 97 IM Frequency Histogram per Segment AC#6

### 11.5.3.2 Multi Pair IM - With Wind Uncertainty

The random wind components are activated with a mean of zero and a standard deviation of 5 meters per second for both the East and North winds. The standard deviation for the start time (initial spacing) uncertainty is set to zero. All aircraft arrive at the merge point (starting waypoint in the simulation) exactly 50 seconds apart. In addition, the commanded spacing time (“Setup” file) is set to 50 seconds for aircraft numbers 2 through 6.

A total of 250 simulation runs were conducted to arrive at the results. Figure 98 shows a combined histogram of the achieved spacing at the reference waypoint with wind uncertainty for all aircraft engaged in IM. Aircraft number 1 follows a specified flight plan with no additional speed changes. Aircraft numbers 2 through 6 perform IM operations. This indicates a normal distribution with a mean of around 51 seconds. There is no obvious difference in achieved spacing statistics for aircraft 5 and 6 at the end of the IM stream.

Figure 99 provides a histogram of the IM speed command frequency (per minute) averaged over the total duration of the operation. Figure 100 provides a histogram of the IM speed command frequency (per minute) for that portion of operation below an altitude of 10,000 feet. In both cases, aircraft number 5 and 6 appear to have fewer IM speed commands than the aircraft in front of the stream. Although the number of samples is very limited, the results indicate a normal distribution. Figure 101 and Figure 102 show histograms of IM frequency (per minute) for each segment of the flight plan for aircraft number 2 and aircraft number 6 respectively. As with the earlier results, all the “high activity” IM actions with a frequency of 2 per minute or higher occur during the final three segments of the operation. This is in part due to the simple design of the

IM controller and can be significantly improved upon using a more optimized IM control scheme.

The basic statistics associated with the IM operation are listed in Table 12 below.

**Table 12: Statistics for multi pair IM test case with wind uncertainty**

Achieved spacing, seconds	mean	$\sigma$	max	min
AC #2	51.3	5.9	74	11
AC #3	51.2	7.6	79	21
AC #4	51.2	7.6	71	15
AC #5	49.9	7.4	69	25
AC #6	50.2	7.4	66	24

IM frequency, total (per minute)	mean	$\sigma$	max	min
AC #2	0.529	0.10	0.752	0.225
AC #3	0.481	0.10	0.778	0.245
AC #4	0.463	0.10	0.731	0.197
AC #5	0.442	0.10	0.674	0.142
AC #6	0.427	0.10	0.706	0.210

IM frequency, below 10K (per minute)	mean	$\sigma$	max	min
AC #2	1.579	0.41	2.584	0.204
AC #3	1.325	0.37	2.300	0.475
AC #4	1.193	0.34	2.095	0.183
AC #5	1.076	0.30	1.752	0.168
AC #6	0.982	0.28	1.823	0.155

Although only very limited data has been collected, it is evident that there is no indication of instability due to the size of the stream in the presence of random wind uncertainty with a standard deviation of 5 m/s (or approximately 10 Knots) in both East and North directions. The tests indicated that even with the observed shortcomings of the TTG estimator and the IM controller implemented in this model, the last IM aircraft in the stream performs equally well as the first IM aircraft. This implies that the IM stream is stable.

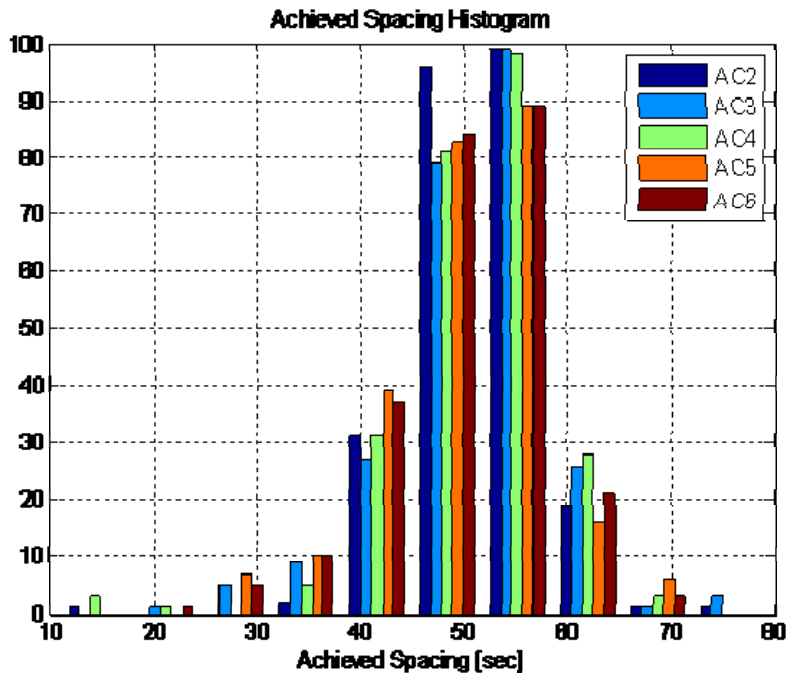

Figure 98 Achieved Spacing Histogram.

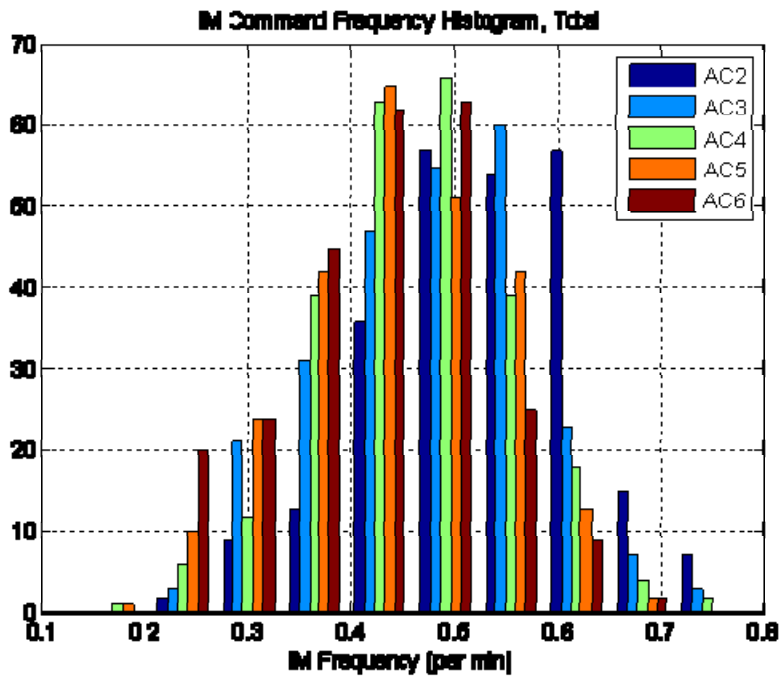

Figure 99 IM Frequency Histogram Total Operation

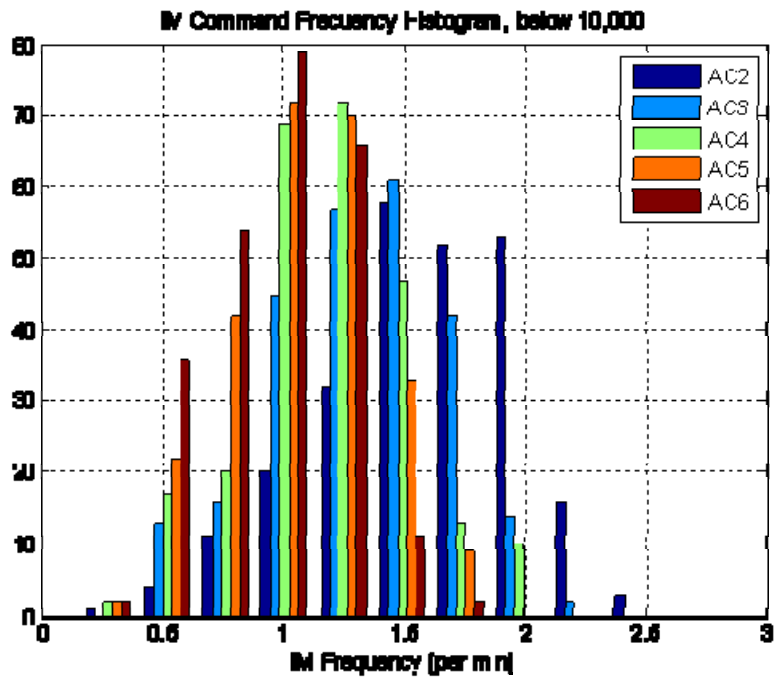

Figure 100 IM Frequency Histogram below 10K

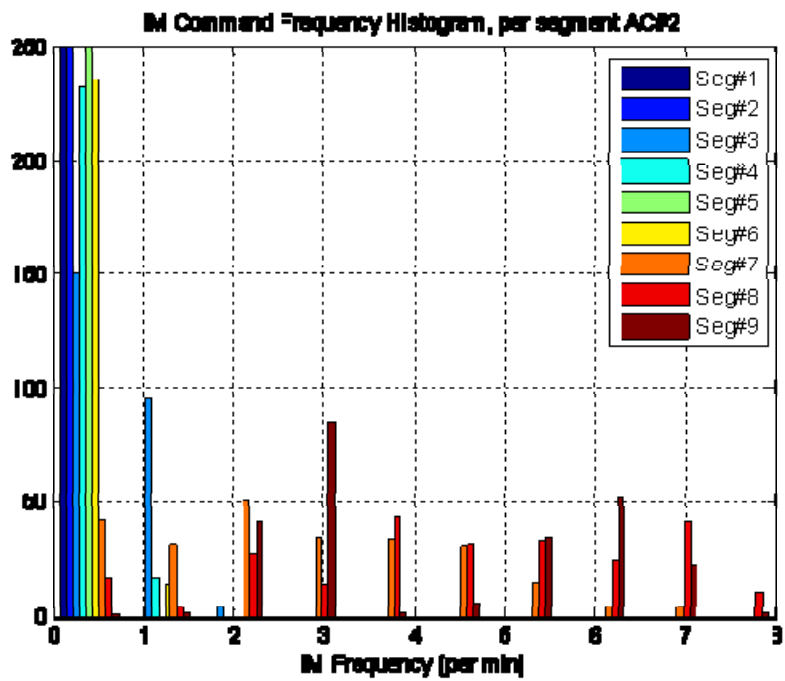

Figure 101 IM Frequency Histogram per Segment AC#2



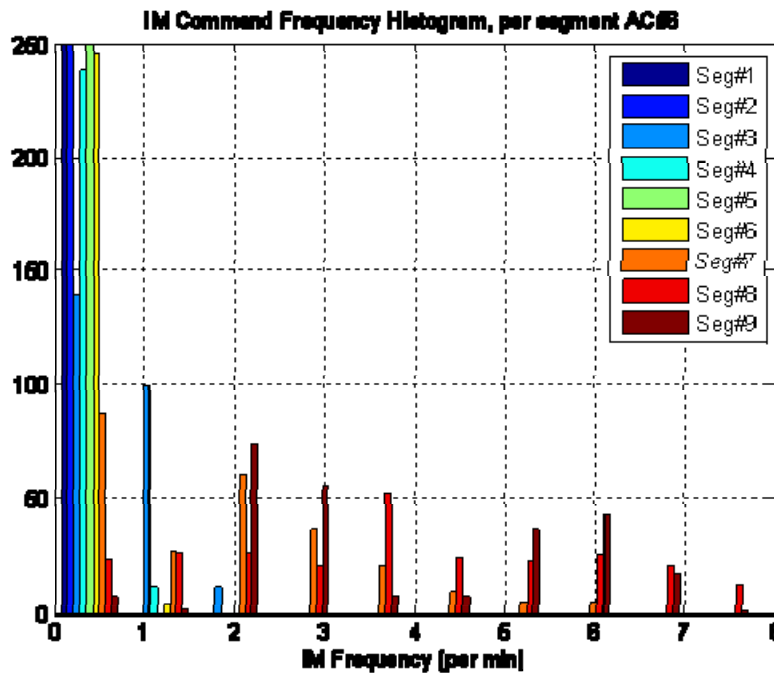

Figure 102 IM Frequency Histogram per Segment AC#6

### 11.5.3.3 Multi Pair IM - With Wind and Initial Spacing Uncertainty

For these tests, the random wind components are activated with a mean of zero and a standard deviation of 5 meters per second for both the East and North winds. All aircraft arrive at the merge point (starting waypoint in the simulation) at a mean of 50 seconds apart and with a standard deviation of 5 seconds. In addition, the commanded spacing time (“Setup” file) is set to 50 seconds for aircraft numbers 2 through 6.

A total of 173 simulation runs were conducted to arrive at the results. This is not a sufficient sample. However, limited schedule and computational limitations prevented a larger sample.

A combined histogram of the achieved spacing at the reference waypoint with wind and initial spacing uncertainties is shown in Figure 103. The lead aircraft is flown to the specified flight plan with no additional speed changes. The second through sixth aircraft perform IM speed change operations. This is consistent with a normal distribution with a mean of between 50 and 51 seconds. Considering the resolution of sample time resolution of one second, it can be deduced that the average achieved spacing is nearly the same for all aircraft in the IM stream.

Figure 104 provides a histogram of the IM speed change frequency (per minute) averaged over the total duration of the operation. Figure 105 provides a histogram of the IM speed change frequency (per minute) for that portion of operation below an altitude of 10,000. These results are consistent with the wind-only uncertainty case. The average IM speed change frequency for the aircraft in front of the IM stream appears to be slightly higher than that for the aircraft later in

the stream. Figure 106 and Figure 107 show histograms of IM frequency (per minute) for each segment of the flight plan for aircraft number 2 and aircraft number 6 respectively.

The basic statistics associated with the IM operation are listed in Table 13.

**Table 13: Statistics for multi pair IM test case with wind and initial spacing uncertainty**

Achieved spacing, seconds	mean	$\sigma$	max	min
AC #2	51.7	5.3	71	34
AC #3	51.5	8.1	75	13
AC #4	51.2	7.1	65	22
AC #5	49.3	8.1	66	13
AC #6	49.9	7.8	74	19

IM frequency, total (per minute)	mean	$\sigma$	max	min
AC #2	0.553	0.10	0.763	0.278
AC #3	0.494	0.10	0.761	0.150
AC #4	0.477	0.10	0.767	0.191
AC #5	0.456	0.10	0.750	0.190
AC #6	0.447	0.10	0.684	0.162

IM frequency, below 10K (per minute)	mean	$\sigma$	max	min
AC #2	1.627	0.38	2.491	0.587
AC #3	1.328	0.39	2.256	0.192
AC #4	1.188	0.34	1.960	0.176
AC #5	1.060	0.33	1.966	0.174
AC #6	0.991	0.27	1.577	0.158

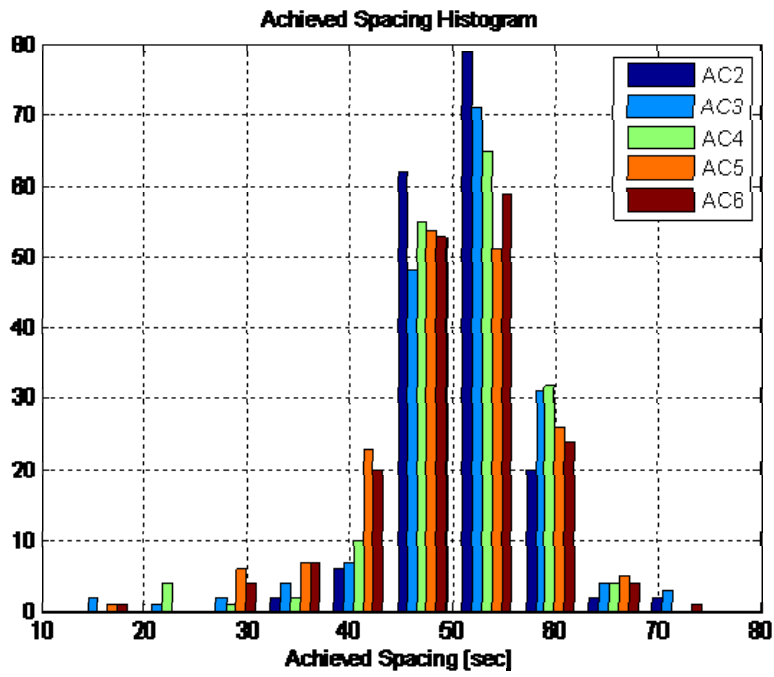

Figure 103 Achieved Spacing Histogram.

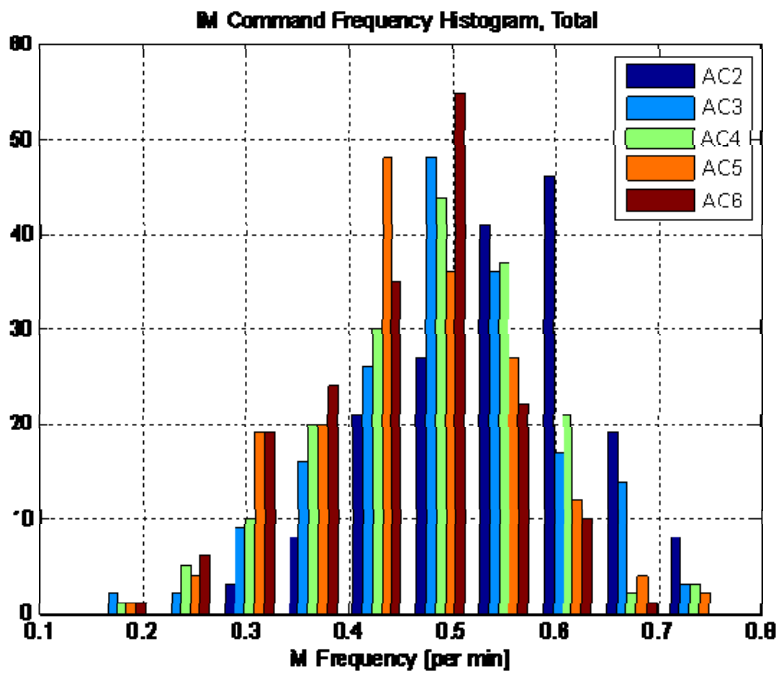

Figure 104 IM Frequency Histogram Total Operation

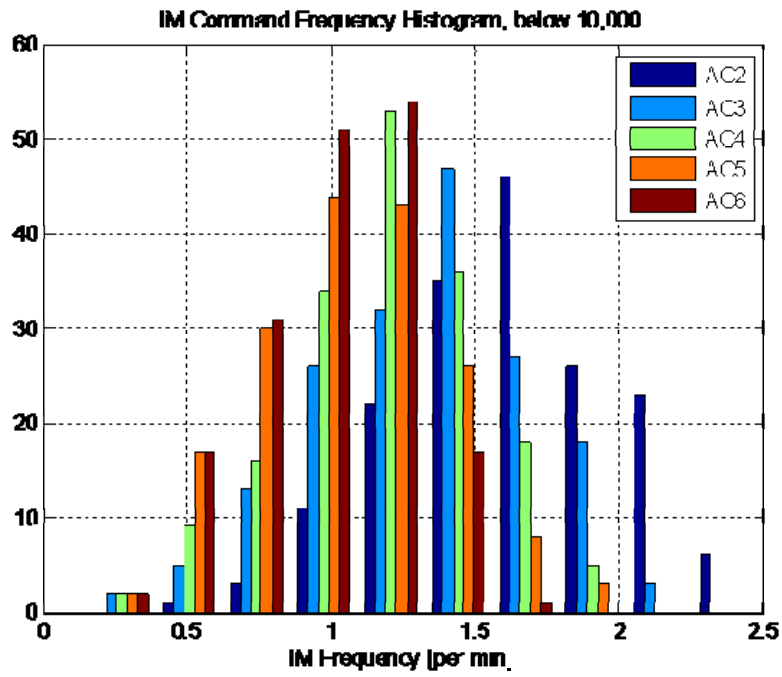

Figure 105 IM Frequency Histogram below 10K

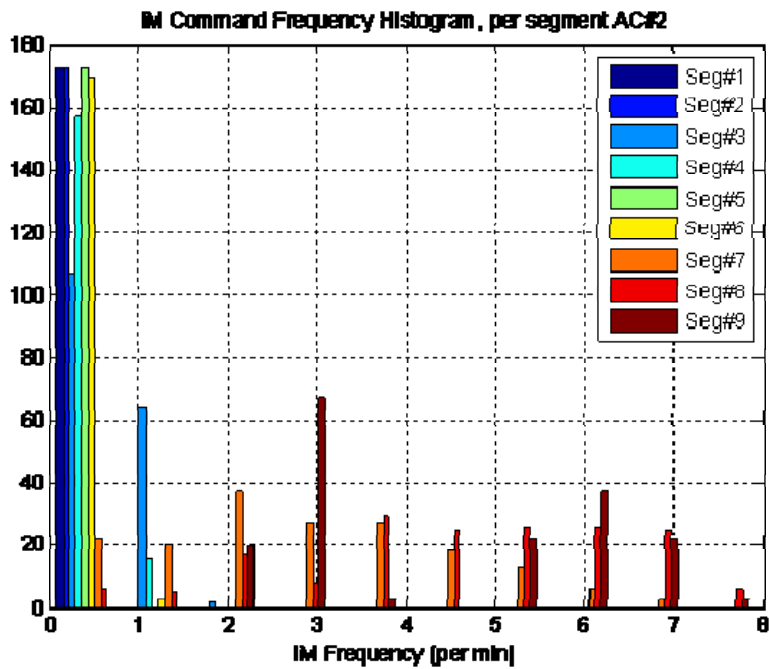

Figure 106 IM Frequency Histogram per Segment AC#2

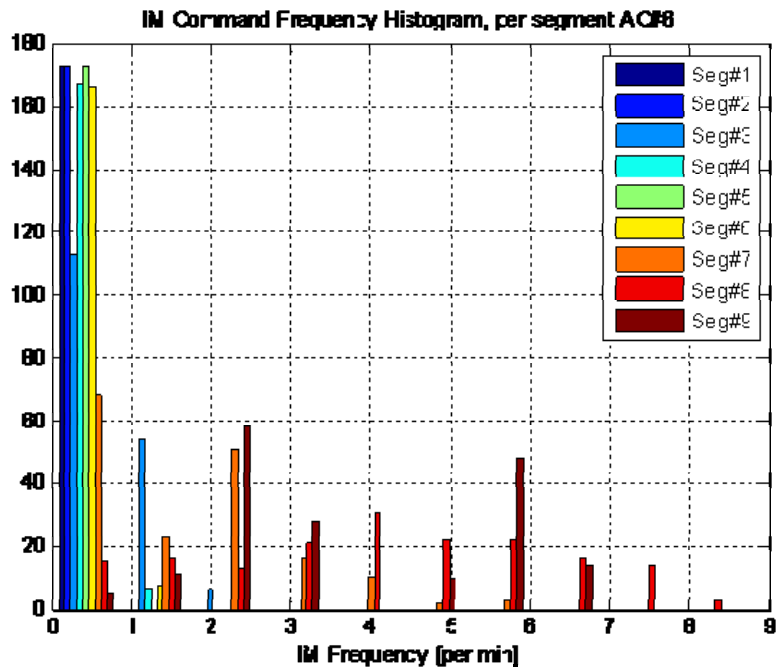

Figure 107 IM Frequency Histogram per Segment AC#6

## 11.6 RIMP Study Conclusion

A simulation of a multi-aircraft stream performing interval management operations was developed and used to analyze the sensitivity of the operation to various uncertainties, in particular forecast wind and initial spacing uncertainty. The simulation was developed in the MATLAB/Simulink environment and was set up to run in a Monte Carlo simulation environment. Each simulation run consisted of six 767-like aircraft flying a CDA procedure into Louisville, KY. The simulation started at a predefined point at the cruise altitude and proceeded to landing of all aircraft. The simulation execution length was 3600 seconds. The aircraft flight dynamic states were updated every 0.01 seconds, and data sampling from the model was taken once per second.

Each aircraft in the simulation computed an estimate of its TTG to the reference waypoint. This estimated time was transmitted to all aircraft in the stream. The aircraft performing IM compared their ownship TTG to their respective reference aircraft TTG to compute an instantaneous interval time. The IM control algorithm in each aircraft used this interval time to command a speed increase or a decrease as necessary.

A series of assumptions on the aircraft speed profile and how to predict the ground speed during the CDA were needed in order to develop the TTG estimator. The study results presented here show several shortcomings with the current scheme for this TTG estimation. During longer CDA segments where the aircraft speed deviated from a linear profile between the start and end waypoints, a large change to the estimated time enroute introduce a significant error. This error manifested itself as a step change in TTG when the lead aircraft crosses a waypoint, followed by

another step change back to the original timing when the trailing aircraft reaches the same waypoint. Since the size of this step change in estimated time is as big as 200 seconds, it overwhelms the IM control algorithm and introduces an incorrect system response. It is therefore necessary to address this shortcoming before optimization or redesign of the IM controller is attempted.

Another anticipated problem with the IM operation implemented here is that the IM command frequency increases as the aircraft comes closer to the reference waypoint. Additional filtering of the TTG estimates as well as optimization of the IM controller will alleviate this problem. However, more detailed Concepts of Operations (ConOps) need to be developed in order to proceed with such a design.

No procedure for aborting the IM operation was installed. Such a step is required before proceeding with additional testing. Once the “Required” IM performance is violated, the aircraft must exit the IM stream.

Due to computational shortcomings and limited schedule, a relatively small set of simulation runs were completed and thus many of the relevant statistics are sparse. However, the trends indicate that the IM operation can accurately deliver a stream of aircraft using moderate speed variations. The results indicated that over 90% of the aircraft arrived within  $\pm 10$  seconds of the commanded spacing of 50 seconds.

The simulation setup provides a suitable research platform to evaluate many aspects of IM operations. Aside from evaluating the sensitivity of the operation to various uncertainties, the tool has shown the complexities associated with different time of travel estimates and their impact on performing IM.

## **12 Conclusions**

### **12.1 Observations**

From the outset, this effort planned to use the existing RNP concept as a baseline for extending the construct to encompass several operations involving constraints that are not fixed relative to the Earth’s surface (‘static’ RNP) but rather are relative to the position of other aircraft (‘dynamic’ RNP). Basing these dynamic RNP constructs on the existing RNP formulation provided a useful starting point and encouraged casting the problems in generally recognized terms, such as TLS and containment.

An attempt was made to follow the RNP MASPS as a template to document these concepts. The MASPS document outline was adequate for capturing, explaining, and organizing requirements, but it was not well suited to the task of providing a clear description and analysis of new and unfamiliar air traffic management concepts. Initially, the study team sought a unified construct capable of encompassing a wide range of multi-vehicle operations, but the team was unable to formulate such a generic construct for defining containment and integrity without defining the nature of the operation. Therefore, the study was refocused on two specific types of two-vehicle operation: RSSP and RIMP.

The extension of the static RNP construct to the 4D dynamic operations described in the preceding sections uncovered a number of complications. The first difficulty was the lack of well developed existing constructs for vertical and longitudinal RNP. Though the existing RNP standards include vertical and longitudinal performance measures, they do not contain fully developed constructs for containment and integrity as has been developed for the lateral case. At a minimum, the longitudinal construct was required for both operations examined in this work. To complete the RSSP construct, a detailed vertical construct will be required. While extending the lateral containment and integrity constructs to the longitudinal dimension was difficult, the issues associated with defining a performance standard based on the interaction of two independent vehicles further compounded the problem. Finally, extending the analysis beyond the present state of the vehicle to encompass key metrics that exist only as predicted future quantities added another layer of complexity. Trying to properly account for external (not intrinsic to the aircraft system) error sources, such as the impact of unquantified wind prediction/estimation errors on trajectory predictions, proved particularly elusive.

Trying to define generic constructs not coupled to a specific set of procedures and algorithms led to unresolved issues for both constructs examined. Some aspects of the self-separation performance were found to depend on how and when trajectory adjustments are made (e.g. a few discrete maneuvers vs. continuous adjustment). Similarly for the spacing problem, the spacing performance was found to likely depend on the tuning of the speed adjustment algorithm (e.g., whether predicted errors are nulled early or late; whether speed changes are continuous or discrete). Issues also arose as to how mixed-equipage operations would be addressed in a performance standard, as well as transitions into and out of self-separation and interval-management operations.

## **12.2 Next Steps**

Before the level of safety can be analyzed for either type of operation, each construct needs to have a detailed ConOps developed. The ConOps would include procedures, operational constraints, and mitigation strategies for non-normal conditions.

The complete RSSP concept needs to address the vertical dimension. The containment construct for RSSP should capture the nonlinearities of the problem and address non-circular exclusion zones. The safety case for RSSP will require a much deeper understanding of the impact of traffic density/complexity and trajectory predictability and stability on the achieved level of safety. Extensive Monte Carlo testing will be required to generate a quantitative understanding of these factors. Extension of RSSP concepts to constraints other than air vehicles (e.g. weather cells, prohibited airspace, volcanic ash clouds, etc.) is expected to be relatively straightforward.

For the RIMP construct, one or more representative interval management algorithms (including both ETA prediction and speed profile management) need to be employed to permit quantitative analysis of performance. The authors have determined that such analysis can only be performed using simulation-based techniques. A basic capability has been constructed using a simple interval control algorithm.

The following recommendations for future work aim at improving the performance and the capabilities of the RIMP simulator to support expanded research:

- 1- Update Matlab/Simulink code to support faster simulation and more robust operation needed for large sample Monte Carlo analysis. The modification will enable the optimized model to run without the need for re-compiling.
- 2- Upgrade the calculation of Estimated Time Enroute and Total Time-to-Go to include the speed changes performed by the ownship RIMP controller. The current algorithms assume that the aircraft will continually try to achieve the planned speed. Thus, during RIMP operation, the RIMP speed change introduces a momentary error in calculation of ETE, which is fed back to the RIMP controller.
- 3- Upgrade the calculation of ETE and TTG to compensate for constant Mach and maximum dynamic pressure descent profiles. The current algorithms ignore this specific behavior. During longer segments of the flight plan, this deficiency can result in an apparent spacing error in excess of 100 seconds.
- 4- Add appropriate logic so that each aircraft can monitor its own RIMP progress and when necessary to abort the RIMP operation. This feature addresses the required performance construct associated with RIMP and will add considerable fidelity to the IM stream simulation. It will be used to assess the behavior of IM streams in the extreme cases as well in mixed operations where self-spacing aircraft operate along with conventionally controlled aircraft.
- 5- Repeat Monte Carlo simulation runs with a large sample of at least 10,000 runs or until the histogram plots indicate appropriate distribution.
- 6- Implement alternate ETE calculations and Interval Management control schemes. The current model is a simplified approach developed by this team for this effort. Other IM concepts have addressed various aspects of this operation and may prove to be more effective or have other desirable characteristics. This will enable comparative analysis.
- 7- Implement IM turn capability and add associated control logic. The IM-turn uses the ability to lengthen or shorten a specific leg of the flight plan in order to accommodate precise spacing of the aircraft. This approach is expected to significantly enhance the speed-change-only IM operation. In particular during the final segments of IM operation prior to arriving at the reference waypoint, the IM turn may completely replace speed change. Further analysis is needed to refine the procedures, algorithms, and performance metrics for this operation.



## Acknowledgement

The team wishes to thank David Wing, the NASA Technical Monitor, for sponsoring this research effort as well as the many subject matter experts who provide valuable feedback and guidance: Terrance Abbott, Bryan Barmore, Brian Baxley, Joel Klooster, and Mike Cramer,

## References

1. Barmore, Bryan E., Abbott, T.S., Capron, W.R., and Baxley, B.T.: "Results for Airborne Precision Spacing along Continuous Descent Arrivals," AIAA ATIO 2008.
2. Joint Planning and Development Office: "Concept of Operation for the Next Generation Air Transportation System", Version 2.0, 13 June 2007
3. RTCA DO-236B: "Minimum Aviation System Performance Standards: Required Navigation Performance for Area Navigation" RTCA, Incorporated
4. Hull, James, Barmore, B., and Abbott, T.: "Technology-Enabled Airborne Spacing and Merging," IEEE 2004.
5. Abbott, T.S.: "A Trajectory Algorithm to Support En Route and Terminal Area Self-Spacing Concepts," NASA/CR-2007-214899.
6. Wing D.: *A Potentially Useful Role for Airborne Separation in 4D-Trajectory ATM Operations*. 5<sup>th</sup> AIAA Aviation Technology, Integration and Operations Conference, Arlington, VA, AIAA-2005-7336, 2005.
7. Wing D.: *Performance Basis For Airborne Separation*. 26<sup>th</sup> International Congress of the Aeronautical Sciences, Anchorage, Alaska, 14-19 September 2008.
8. RTCA: *Minimum Aviation System Performance Standards: Required Navigation Performance for Area Navigation*. DO-236B, Washington, DC, October 2003.
9. *Required Self Separation Performance Version 1.1*, report submitted under Contract #NNL08AA15B, NASA Task Order #NNL08AB13T on April 13<sup>th</sup> 2009.
10. *Required Self Separation Performance Accuracy Modeling Version 2.1.1*, report submitted under Contract #NNL08AA15B, NASA Task Order #NNL08AB13T on May 28<sup>th</sup> 2010.
11. RTCA: *Minimum Aviation System Performance Standards For Automatic Dependent Surveillance Broadcast (ADS-B)*. DO-242A, Washington, DC, June 25, 2002.
12. "Required Interval Management Performance Modeling, Version 3.1" May 2010
13. "Required Interval Management Performance Study Plan, Version 1.0" March 2010
14. Barmore, Bryan; Abbott, Terence; Krishnamurthy, Karthik, "Airborne-Managed Spacing in Multiple Arrival Streams", 2004, NASA 20040110959
15. Barmore, B., "Airborne Precision Spacing: A Trajectory-based Approach to Improve Terminal Area Operations", 2006, NASA 20080013631

## Acronyms

4D	4 Dimensional
A/C	Aircraft
ADS-B	Automatic Dependent Surveillance - Broadcast
ADS-R	Automatic Dependent Surveillance - Rebroadcast
ANSP	Air Navigation Service Provider
APS	Airborne Precision Spacing
ASAS	Airborne Separation Assurance/Assistance System
ATM	Air Traffic Management
ATS	Air Traffic Services
CAS	Calibrated Air Speed
CNS	Communication, Navigation, Surveillance
ConOps	Concept of Operations
CSE	Computed Spacing Error
DOF	Degrees Of Freedom
EPE	Estimated Position Error
ETA	Estimated Time of Arrival
ETAE	Estimated Time Of Arrival Error
ETB	Estimated Time Bias
ETE	Estimated Time Error
ETTG	Estimated Time To Go
FAA	Federal Aviation Administration
FAF	Final Approach Fix
FIS-B	Flight Information Service - Broadcast
FMS	Flight Management System
FTE	Flight Technical Error
GNSS	Global Navigation Surveillance System
GPS	Global Positioning System
ICAO	International Civil Aviation Organization
INS	Inertial Navigation System
JPDO	Joint Planning and Development Office
MASPS	Minimum Aviation System Performance Standards
NAS	National Airspace System
NASA	National Aeronautics and Space Administration
PCA	Point of Closest Approach
RIMP	Required Interval Management Performance
RNAV	Area Navigation
RNP	Required Navigation Performance
RSSP	Required Self Separation Performance
RTCA	Radio Technical Commission for Aeronautics
SBL	Separation Boundary Lateral
SBV	Separation Boundary Vertical
SCA	Spacing Control Authority
SDE	Spacing Definition Error
SEE	Spacing Estimation Error

SM	Separation Management
STAR	Standard Terminal Arrival Route
TBO	Trajectory Based Operation
TCP	Trajectory Change Point
TIS-B	Traffic Information Service - Broadcast
TLS	Target Level of Safety
TOAC	Time Of Arrival Control
TSE	Total Spacing Error
TTG	Time To Go
TTGE	Time To Go Error
UAT	Universal Access Transceiver
UTC	Universal Coordinated Time
VNAV	Vertical Navigation

**REPORT DOCUMENTATION PAGE**

*Form Approved  
OMB No. 0704-0188*

The public reporting burden for this collection of information is estimated to average 1 hour per response, including the time for reviewing instructions, searching existing data sources, gathering and maintaining the data needed, and completing and reviewing the collection of information. Send comments regarding this burden estimate or any other aspect of this collection of information, including suggestions for reducing this burden, to Department of Defense, Washington Headquarters Services, Directorate for Information Operations and Reports (0704-0188), 1215 Jefferson Davis Highway, Suite 1204, Arlington, VA 22202-4302. Respondents should be aware that notwithstanding any other provision of law, no person shall be subject to any penalty for failing to comply with a collection of information if it does not display a currently valid OMB control number.  
**PLEASE DO NOT RETURN YOUR FORM TO THE ABOVE ADDRESS.**

<b>1. REPORT DATE (DD-MM-YYYY)</b> 01-02-2011		<b>2. REPORT TYPE</b> Contractor Report		<b>3. DATES COVERED (From - To)</b>	
<b>4. TITLE AND SUBTITLE</b> 4D Dynamic Required Navigation Performance Final Report				<b>5a. CONTRACT NUMBER</b> NNL08AA15B	
				<b>5b. GRANT NUMBER</b>	
				<b>5c. PROGRAM ELEMENT NUMBER</b>	
<b>6. AUTHOR(S)</b> Finkelsztein, Daniel M.; Sturdy, James L.; Alaverdi, Omeed; Hochwarth, Joachim K.				<b>5d. PROJECT NUMBER</b>	
				<b>5e. TASK NUMBER</b>	
				<b>5f. WORK UNIT NUMBER</b> 411931.02.51.07.01	
<b>7. PERFORMING ORGANIZATION NAME(S) AND ADDRESS(ES)</b> NASA Langley Research Center Hampton, VA 23681-2199				<b>8. PERFORMING ORGANIZATION REPORT NUMBER</b>	
<b>9. SPONSORING/MONITORING AGENCY NAME(S) AND ADDRESS(ES)</b> National Aeronautics and Space Administration Washington, DC 20546-0001				<b>10. SPONSOR/MONITOR'S ACRONYM(S)</b> NASA	
				<b>11. SPONSOR/MONITOR'S REPORT NUMBER(S)</b> NASA/CR-2011-217051	
<b>12. DISTRIBUTION/AVAILABILITY STATEMENT</b> Unclassified - Unlimited Subject Category 03 Availability: NASA CASI (443) 757-5802					
<b>13. SUPPLEMENTARY NOTES</b> Langley Technical Monitor: David J. Wing					
<b>14. ABSTRACT</b> New advanced four dimensional trajectory (4DT) procedures under consideration for the Next Generation Air Transportation System (NextGen) require an aircraft to precisely navigate relative to a moving reference such as another aircraft. Examples are Self-Separation for enroute operations and Interval Management for in-trail and merging operations. The current construct of Required Navigation Performance (RNP), defined for fixed-reference-frame navigation, is not sufficiently specified to be applicable to defining performance levels of such air-to-air procedures. An extension of RNP to air-to-air navigation would enable these advanced procedures to be implemented with a specified level of performance. The objective of this research effort was to propose new 4D Dynamic RNP constructs that account for the dynamic spatial and temporal nature of Interval Management and Self-Separation, develop mathematical models of the Dynamic RNP constructs, "Required Self-Separation Performance" and "Required Interval Management Performance," and to analyze the performance characteristics of these air-to-air procedures using the newly developed models. This final report summarizes the activities led by Raytheon, in collaboration with GE Aviation and SAIC, and presents the results from this research effort to expand the RNP concept to a dynamic 4D frame of reference.					
<b>15. SUBJECT TERMS</b> Interval management; Performance based operations; RNP; Self-separation					
<b>16. SECURITY CLASSIFICATION OF:</b>			<b>17. LIMITATION OF ABSTRACT</b>	<b>18. NUMBER OF PAGES</b>	<b>19a. NAME OF RESPONSIBLE PERSON</b>
<b>a. REPORT</b>	<b>b. ABSTRACT</b>	<b>c. THIS PAGE</b>			STI Help Desk (email: help@sti.nasa.gov)
U	U	U	UU	188	<b>19b. TELEPHONE NUMBER (Include area code)</b> (443) 757-5802