

FEDERAL LAB

LASER

TECH BRIEFS

Fall 1994
Vol. 2 No. 4

REPORTING THE LATEST FEDERALLY-DEVELOPED PHOTONICS TECHNOLOGY

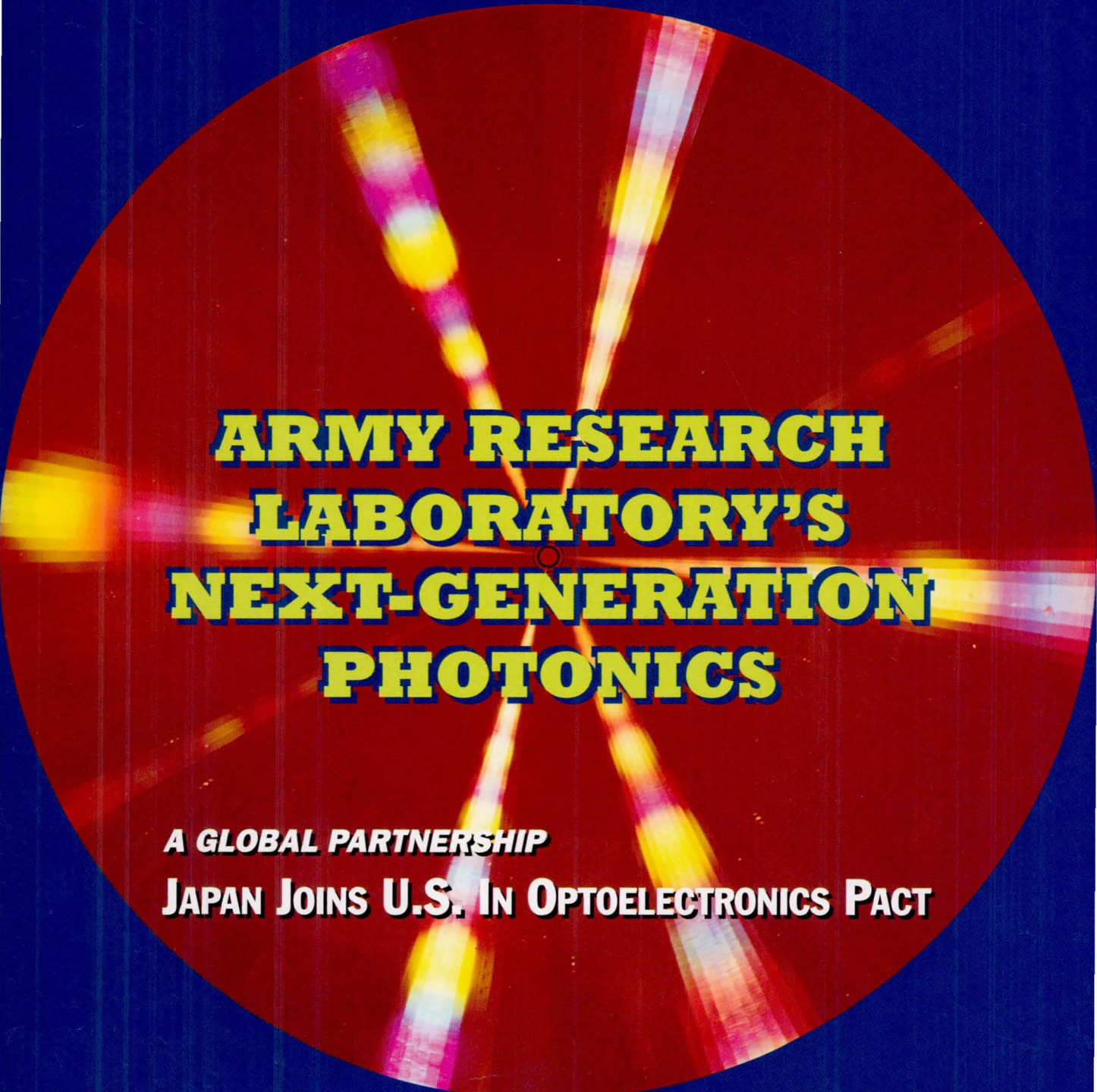

ARMY RESEARCH LABORATORY'S NEXT-GENERATION PHOTONICS

A GLOBAL PARTNERSHIP

JAPAN JOINS U.S. IN OPTOELECTRONICS PACT

LASERS • OPTICS • ELECTRO-OPTICS
IMAGING • FIBER OPTICS • SENSORS

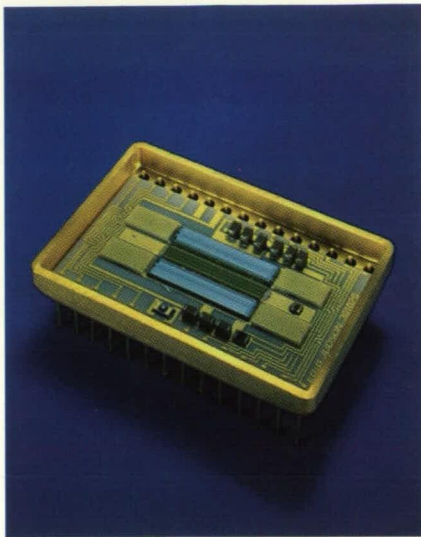

NIR Linear Arrays

Low cost NIR linear photodiode arrays are now available for wavelengths ranging from 800 to 1800 nm. InGaAs and Ge arrays with pixel sizes ranging from 50x100µm to 0.1x2.5mm are available in lengths up to one inch for highly sensitive liquid nitrogen, TE cooled and room temperature applications such as spectroscopy, imaging, far-field beam analysis and astronomy.



IR Detectors in Dewars

EG&G Judson offers standard dewars for 77° Kelvin detector operating temperature. Repumpable metal dewars are recommended for laboratory or R&D use. Advantages include rugged construction, low cost, long hold time, optional mounting flanges and a wide range of window material. Long life, permanently sealed glass dewars as well as dewars with custom configurations are also available upon request.

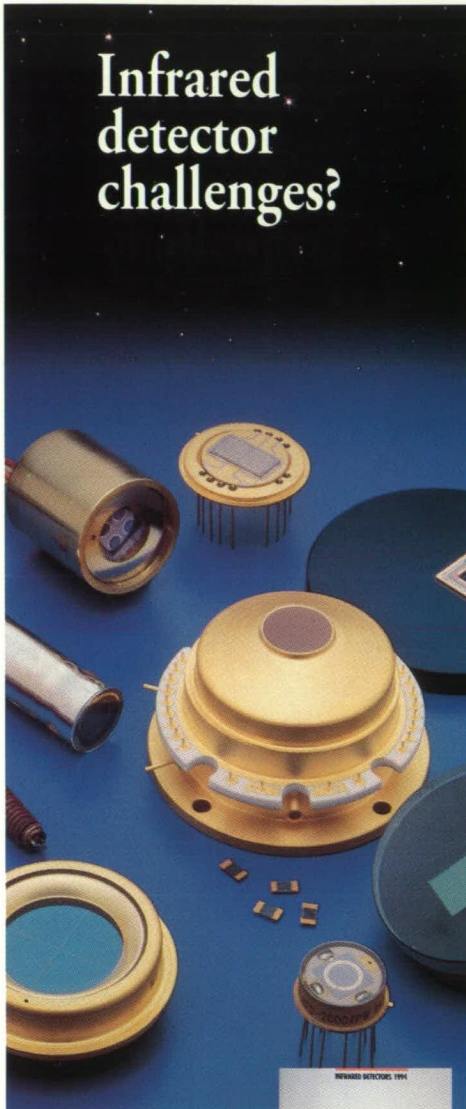

Infrared detector challenges?

Try some of the world's most advanced IR detector technology.

Whatever your IR detector challenge, chances are EG&G Judson already has a solution.

Germanium (Ge), Indium Arsenide (InAs), Indium Antimonide (InSb), Mercury Cadmium Telluride (HgCdTe). From simple photodetectors to complex integrated assemblies, EG&G Judson technology spans the IR spectrum.

- Specialized detectors
- Cooler systems
- Preamplifier electronics
- Multi-element detector arrays
- MIL spec qualified detectors

Our total in-house capabilities include advanced material process development, fully space-qualified/MIL spec hardware programs, engineering prototype programs, environmental/qualification testing, pilot-run and full-scale production, and technical support.

We'll meet your IR detector challenges imaginatively, effectively, and efficiently with some of the world's most advanced IR detector technology.

Call 1-800-986-OPTO to receive your copy of EG&G Judson's IR detector catalog.

221 Commerce Drive
 Montgomeryville, PA 18936
 Tel: 215-368-6901
 Fax: 215-362-6107

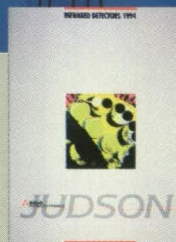

Judson
 Canada
 Electro-Optics
 Heiman
 Reticon
 Vactec



NEW!

Sterling Coolers

Fully integrated detector/cooler assemblies for 77° Kelvin operation are now available in production quantities. Integral rotary coolers weigh less than one pound and run at less than five watts of input power. Dual opposed piston split sterling linear cooler assemblies are available where low microphonics and 24-hour operation are the primary concerns.

For More Information Write In No. 300

What Goes Up, Usually Comes Down...

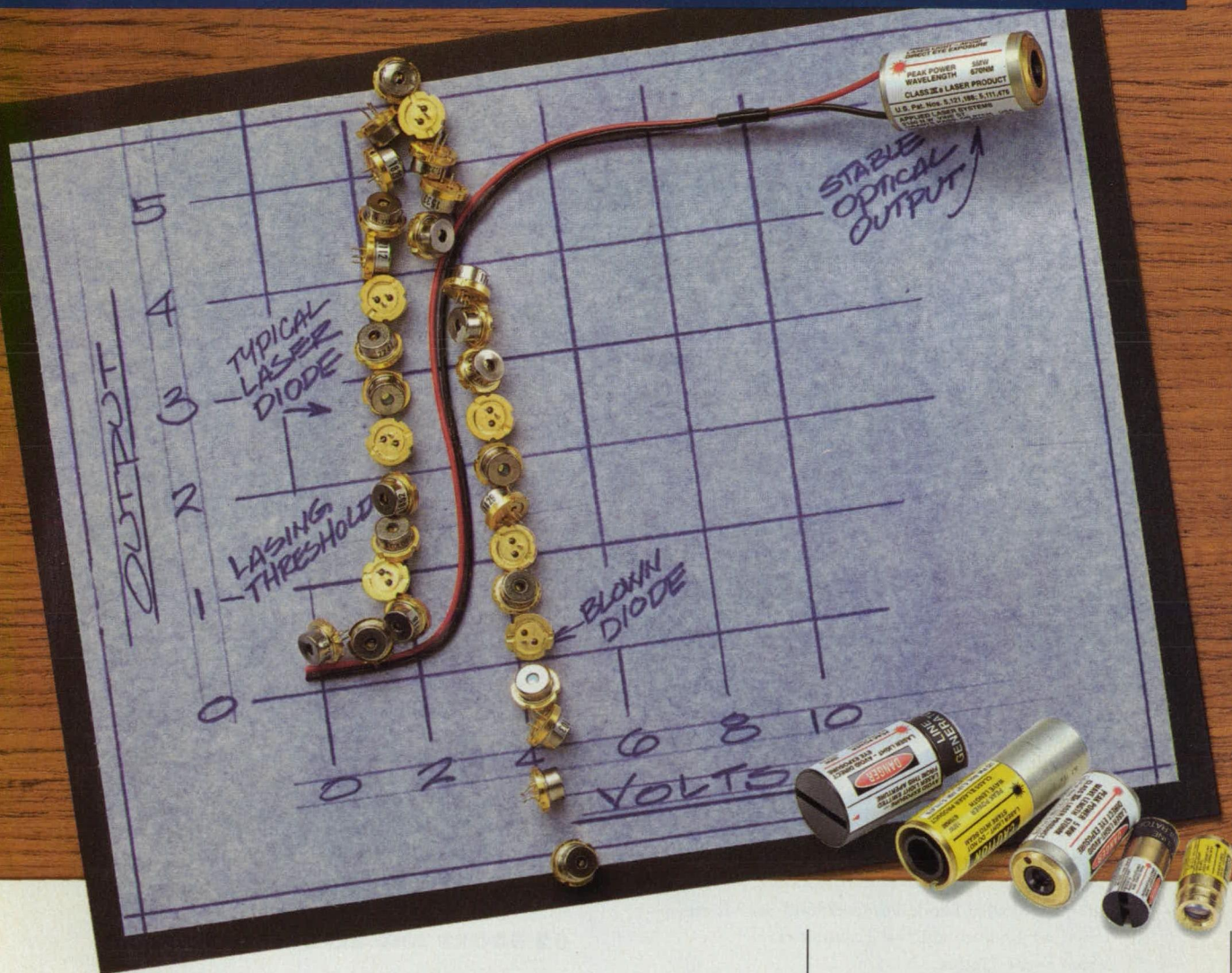

Unless

...the laser diode destined for your product application is completely protected against the forces of electro-static discharge, temperature and handling abuse. That's because a raw laser diode is a fragile and highly volatile device with extreme threshold behavior that will quickly "blow up" under unstable environmental conditions. The typical laser diode is capable of turning on in "one millionth" of a second...and one very short "mistake" usually results in total destruction, rendering the laser diode useless. Applied Laser Systems (ALS) has solved this problem and makes the laser diode usable in the real world.

So, while it may seem practical to engineer your laser product "from the ground up," it makes far more sense to bypass the frustrating process of trying to stabilize the laser diode by simply "plugging in" our patented

VLM™ product directly into your application. Our modular system is so user friendly, all you have to do is add a power supply.

Simply put, the ALS Visible Laser Module, or VLM™ product is the most advanced laser module system on the market today. Our miniature design incorporates the laser diode, drive circuits, and sophisticated optics into one tiny, self-contained, shock resistant package, allowing us to maximize power efficiency while protecting the internal circuitry from electro-static discharge, spiking overload and reverse polarity. In short, the VLM™ product makes the fragile laser diode virtually indestructible.

And with a field failure rate of less than 1 percent, Applied Laser Systems supports its products with a full **two year warranty**, setting the industry standard. In addition, a small green LED indicator is mounted on the rear of each module to indicate when the laser is operating...a safety factor that ALS alone provides.

The versatile VLM™ product comes ready-to-use in a variety of beam configurations and wavelengths, in both the visible and infra-red bands. Modules can easily be integrated into a wide variety of applications that require precision and accuracy, such as alignment and positioning, counting and timing, signal transmission, testing and measurement, and illumination... right out of the box.

Why waste critical R&D funds on costly experimentation? At ALS we've already figured it out!

ALS

APPLIED LASER SYSTEMS

2160 N.W. Vine Street
Grants Pass, OR 97526, U.S.A.
Fax: (503) 476-5105
Telephone: (503) 474-6560

**For QWIK-FAX Information
call (503) 479-1526**

Protected by U.S. Patents Nos. 5,121,188; 5,111,476

CONTENTS

FEATURES

12 Editorial Notebook: Japan Joins U.S. in Optoelectronic Partnership

14 Army Research Laboratory: Focused Photonics for Lean Times

TECHNICAL SECTION

20 ELECTRONIC COMPONENTS AND CIRCUITS

- 20 Improved Thermoelectrically Cooled Laser-Diode Assemblies
- 21 Diffractive Optics Enhance the Performance of Optical Signal Processors
- 22 Optoelectronic Attenuator for Microwave Signal
- 26 Optical Heterodyne with Lower Phase Noise

28 ELECTRONIC SYSTEMS

- 28 Internally Folded Diode-Pumped Solid-State Laser
- 28 Low-Cost Photoconductive Transmitter
- 31 Video Event Trigger
- 33 Monolithic Optical-to-Electronic Receiver
- 33 Fiber-Optic Terahertz Data-Communication Networks
- 39 Optoelectronic Tool Measures Steps and Gaps Between Tiles
- 39 Uncooled Laser Diode in E-Format Standard Electronic Module

42 PHYSICAL SCIENCES

- 42 Diffractive Optical Elements for Optics Education
- 42 Corrective Optics for Camera on Telescope
- 43 Laser Velocimeter for the Measurement of Hyper-Velocity Particles
- 45 High-Temperature Microphone with Fiber-Optic Output
- 46 Array of Sensors Measures Broadband Radiation
- 48 New Remote Gas Sensor Using Rapid Electro-Optical Path Switching

- 49 Improved Fiber-Optic-Coupled Pressure and Vibration Sensors
- 50 Reflective Baffles for Telescope
- 51 Triboluminescent Fiber-Optic Sensors Measure Stresses
- 52 Generating a Strobed Laser Light Sheet

53 MATERIALS

- 53 Cubic GaS: a Surface Passivator for GaAs

54 COMPUTER PROGRAMS

- 54 Software for a Laser Vibrometer

57 FABRICATION TECHNOLOGY

- 57 Deposition of Carbide Coatings Using a Two-Laser Process
- 58 Etching Polymer Optical Waveguides with Atomic Beams

60 MATHEMATICS AND INFORMATION SCIENCE

- 60 Subband and Transform Compression of Video Signals

61 LIFE SCIENCES

- 61 Intraocular Laser Surgical Probe

62 BOOKS AND REPORTS

- 62 Diffractive Optics for Geostationary Earth Observatory

On The Cover:

The photo shows reflections from a chrome-on-glass mask of a Fresnel zone plate used in the production of diffractive lenses via microelectronic fabrication techniques. See the brief beginning on page 21. Photo courtesy Army Research Laboratory.

DEPARTMENTS

- 8 Technology Transfer Services
- 63 New Product Showcase
- 66 New Literature
- 72 Advertisers Index

Permissions: Authorization to photocopy items for internal or personal use, or the internal or personal use of specific clients, is granted by Associated Business Publications, provided that the flat fee of \$3.00 per copy is paid directly to the Copyright Clearance Center (21 Congress St., Salem, MA 01970). For those organizations that have been granted a photocopy license by CCC, a separate system of payment has been arranged.

Laser Tech Briefs, Vol. 2, No. 4, copyright © 1994 in U.S., is published quarterly by Associated Business Publications Co., Ltd., 41 E. 42nd St., New York, NY 10017-5391. The copyrighted information does not include the (U.S. rights to) individual tech briefs supplied by NASA. Editorial, sales, production, and circulation offices at 41 E. 42nd St. New York, NY 10017-5391. Second-class postage pending at New York, N.Y. and additional mailing offices. Postmaster: please send address changes to Laser Tech Briefs, 41 E. 42nd St., Suite 921, New York, NY 10017-5391.

BPA INTERNATIONAL MEMBERSHIP APPLIED FOR JANUARY, 1994.

Current or Voltage Low-Noise Preamplifiers

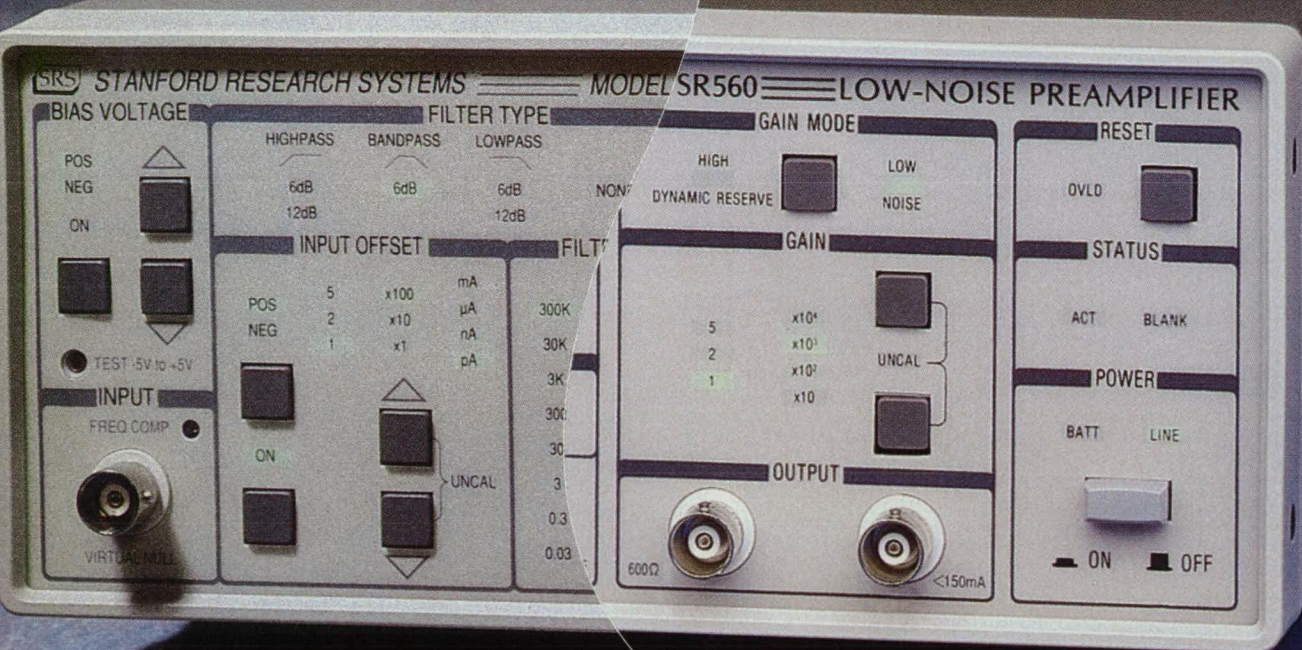

The new SR570 Current Preamplifier is a low noise, high gain amplifier, appropriate for a variety of photonic, low temperature and low noise applications. The SR570 is a transimpedance amplifier, outputting a voltage proportional to the input current with these impressive specifications:

- **5 fA/ $\sqrt{\text{Hz}}$ Input noise**
- **1 MHz bandwidth**
- **1 pA/V maximum sensitivity**
- **Adjustable bias voltage and input offset current**
- **\$1895**

Our SR560 Voltage Preamplifier is designed for high gain, low noise amplification of single ended or differential signals. Use it with detectors, microphones, transducers, or any small voltage that needs to be accurately amplified or measured. The SR560 features:

- **4 nV/ $\sqrt{\text{Hz}}$ Input noise**
- **1 MHz bandwidth**
- **1 to 50,000 Variable Gain**
- **100 dB CMRR**
- **\$1895**

Both low-noise preamplifiers share outstanding features, such as adjustable (high, low or bandpass) filters to reject unwanted noise, an internal rechargeable battery for up to 15 hours of remote operation, and an optoisolated RS-232 interface for noise free communication. For more information contact SRS at (408)744-9040.

The new SR570 and the SR560 Preamplifiers –
clearly the choice for amplifying your smallest current or voltage.

For More Information Write In No. 503



STANFORD RESEARCH SYSTEMS

1290 D Reamwood Avenue • Sunnyvale, CA 94089 TEL(408)744-9040 FAX: 4087449049

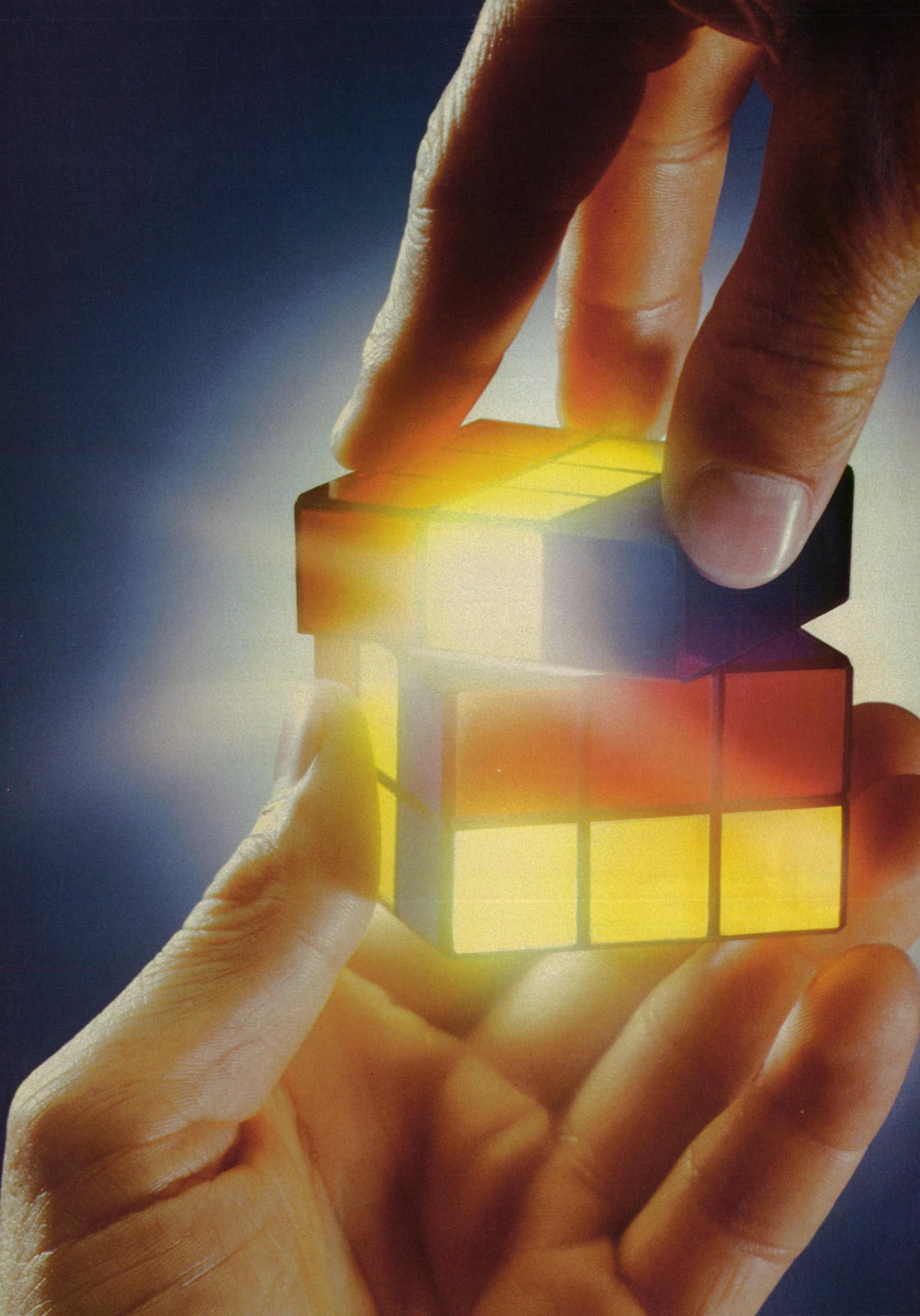

The Logical Choice.

However challenging your optoelectronic requirements, the divisions of EG&G Optoelectronics can help you fit the pieces together.

Backed by a diversified, high technology *Fortune* 200 company serving a worldwide market, our combined divisions have amassed

*Your
single source
for the countless
possibilities
of light.*

a depth of knowledge and experience unique to the industry. Together, we have developed a vast range of engineered solutions... including economical off-the-shelf detectors, light sources, custom opto assemblies, and some of the world's most advanced image sensors... solutions which await you today.

Whatever your needs... from UV to IR, from emitters and photocells to some of the most sophisticated lasers, detectors, and electronic imaging devices... make the logical choice: EG&G Optoelectronics. Because chances are we already have the combination that's just right for you.



Call for our brochure, fax us at 408-720-0794, or write
345 Potrero Avenue, Sunnyvale, CA 94086.

Call 1 800 775-OPTO

For More Information Write In No. 371

 **EG&G**
OPTOELECTRONICS

*Canada
Electro-Optics
Heimann
Judson
Reticon
Vactec*

Hard to find Positioning Equipment

Hundreds to choose from

Linear Slides
Rotary Tables
X-Y Tables

Widths: 1½" to 9"
Lengths: 2" to 90"

Single or
OEM Quantities

Compact
Durable
Economical

Get your FREE
36 page
catalog
today!



UNISLIDE® ASSEMBLIES

VELMEX INC.

800 642-6446
FAX: 716 657-6153
In NYS: 716 657-6151
East Bloomfield, N. Y. 14443

For More Information Write In No. 355

OPTICAL ADHESIVES

Designed to Your Specifications
MASTER BOND EP30 EPOXY SYSTEM

- High optical clarity
- Excellent bond strength to similar and dissimilar substrates
- Fast, room temperature cure
- Low shrinkage
- Minimal outgassing
- High durability
- Outstanding chemical resistance
- Easy to apply
- Convenient packaging

For information, call or write:
Master Bond Inc.
154 Hobart Street
Hackensack, NJ 07601
201-343-8983

Master Bond Inc.
Adhesives, Sealants & Coatings

For More Information Write In No. 578

LASER

TECH BRIEFS

From the Publishers of NASA Tech Briefs

BPA International membership applied for January, 1994.

Published by.....**Associated Business Publications**
President/Chief Executive Officer**Bill Schnirring**
Publisher**Joseph T. Pramberger**
Editor.....**Robert S. Clark**
Contributing Editor.....**Sarah L. Gall**
Director of Manufacturing.....**Gregg Weatherby**
Art Director.....**Pierre Granier**
Production Manager.....**Donna Eichenlaub**
Advertising Coordinator.....**Margery Koen**
Marketing Director.....**Wayne Pierce**
Telemarketing Specialist.....**Evelyn Mars**
Reader Service Manager.....**Scott Floman**
Assistant to Reader Service Manager.....**Damiana Garcia**
Circulation Director.....**Martin J. Horan**

Briefs are provided to Laser Tech Briefs by the National Aeronautics and Space Administration, Technology Transfer Division, Washington, DC:
Administrator.....**Daniel S. Goldin**
Deputy Assistant Administrator(Programs).....**Frank E. Penaranda**
Deputy Director Technology Transfer Division
(Publications Manager).....**Leonard A. Ault**
Manager, Technology Transfer Office, NASA Center
For AeroSpace Information.....**Walter M. Heiland**

ASSOCIATED BUSINESS PUBLICATIONS

41 East 42nd Street, Suite 921, New York, NY 10017-5391
(212) 490-3999 FAX (212) 986-7864

President/Chief Executive Officer**Bill Schnirring**
Executive Vice President/Chief Operating Officer**Domenic A. Mucchetti**
Treasurer**Joseph T. Pramberger**
Controller**Athena Thomas**
Credit/Collection**Felecia Lahey**
Staff Accountant**Larry Duze**
Trade Show Director**Wendy S. Janiel**
Trade Show Coordinator**Danielle Krasny**
Human Resources Manager**Lourdes Del Valle**
MIS Manager**Ted Morawski**
Assistant MIS Manager.....**Pak Tong**
Office Manager.....**Sylvia Valentin**
Mailroom Operations.....**Thomas C. Snyder, Rose D'Addozio**
Receptionist.....**Tracy A. Wenz**

ADVERTISING: New York Office: (212) 490-3999 FAX (212) 986-7864

National Sales Manager.....**Robert Hubbard**
at (212) 490-3999

LASER TECH BRIEFS ACCOUNT EXECUTIVES:

NY, NJ.....**Brian Clerkin**
at (201) 366-2751
PA, DE, NJ (Area Code 609), VA, DC, MD, WV, NC**Tara Morie**
at (215) 640-3118
Eastern MA, NH, ME, RI.....**Paul Gillespie**
at (508) 429-8907; **Bill Doucette** at (508) 429-9861
Western MA, CT, VT**George Watts**
at (802) 875-3310
Southeast, South Central**Douglas Shaller**
at (212) 490-3999
OH, MI, IN, KY.....**Robert Hubbard**
at (212) 490-3999
IL, WI, MO, IA, MN, ND, SD, NE, KS**Melinda Mead**
at (312) 296-2040
N. CA, WA, OR, ID, MT, WY, CO**Bill Hague**
at (206) 858-7575
S. CA, AZ, NV, NM, UT**Tom Stillman**
at (310) 372-2744
Japan**Akio Saijo**
at 03 (3555) 0106

Full Spectrum Custom Standard & OEM Optics and Coatings From Prototype to Production

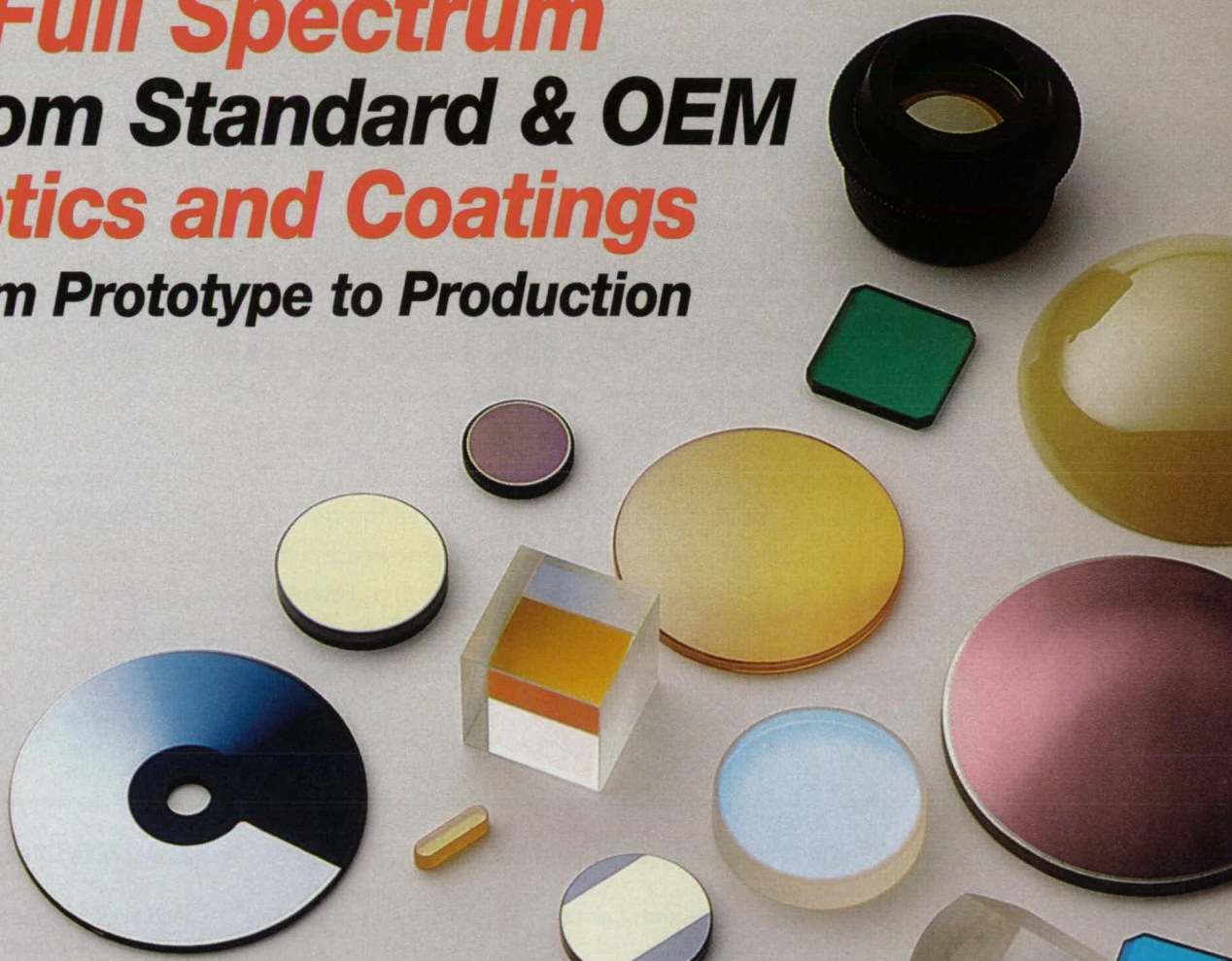

Complete In-House Capabilities

- Advanced Engineering
- Extensive UV to FIR Fabrication
- State-of-the-Art Coatings - Low & High Power
- SPC and Environmental Testing
- Unique Assemblies

Full Spectrum Optical Components & Assemblies

- Lenses, prisms, retro-reflectors, windows, wedges, interferometer flats, beam-splitters, mirrors, filters, output couplers, polarizers, non-polarizers, waveplates and more

Advanced Coating Designs, Types and Methods

Coating Designs

ANTI-REFLECTIVE:

- Single & Multi-layer
- Narrow & Broadband
- Multi-Wavelength

REFLECTIVE/TRANSMISSIVE

- Partial/Output Coupler
- Narrow & Broadband
- Beamcombining
- Beamsplitting

MIRROR:

- Protected & Enhanced
- Phase Retarding
- Hot & Cold
- Dielectric-Low/High Power

FILTER:

- Narrow & Broadband
- Long Wave Pass
- Short Wave Pass
- Variable
- Neutral Density
- Dichroic-Color Separation

POLARIZING COMPONENTS:

- Waveplates- $1/4$ & $1/2$ Wave
- Standard Zero & Multi-Order
- Achromatic Zero & Multi-Order
- Cube Beamsplitters
- Low & High Power
- Polarizing & Non-polarizing
- Narrow & Broadband
- High Power Polarizers
- Thin Film Plate Polarizers

COATING TYPES

- Metallic
- Dielectric
- Metallic/Dielectric Hybrid
- Diamond-Like Carbon (DLC)
- Indium-Tin Oxide (ITO)

COATING METHODS

- Electron Beam Evaporation
- Thermal Evaporation
- Ion-Beam Sputtering
- Magnetron Sputtering

Quality Customer Service & Support



ROCKY MOUNTAIN INSTRUMENT

Germany: RMI GmbH Tel: 49-421-2208-147 Fax: 49-421-2208-157

Japan: Opto-Science Inc. Tel: 81-3-3356-1064 Fax: 81-3-3356-3466

Korea: Woo Kyung Electro-Optics Corp. Tel: 82-345-494-6855 Fax: 82-345-494-6859

USA: 1501 S. SUNSET, LONGMONT, CO 80501

Tel: 303-651-2211 Fax: 303-651-2648

For More Information Write In No. 505

How You Can Access TECHNOLOGY TRANSFER SERVICES at Federal Laboratories Featured in This Issue

If you need further information about new technologies described in *Laser Tech Briefs*, use the Reader Information Card to request it by writing in the number that appears at the end of the brief. In many cases the brief also will contain the name of a researcher or a laboratory contact from whom further information can be obtained. If it does not, you can contact the Technology Utilization or Technology Transfer Officer at the laboratory, who can arrange for assistance in applying the technology by putting you in touch with the people who developed it. If you want information about the patent status of a technology or are interested in licensing an invention, many of the labs have patent counsels to advise you.

NASA Field Centers and Contributing Federal Laboratories

Goddard Space Flight Center

Dr. George Alcorn
(301) 286-5810

George C. Marshall Space Flight Center

Ismail Akbay
(205) 544-2223
(800) 437-5186

Lyndon B. Johnson Space Center

Richard B. Ramsell
(713) 483-3809

John C. Stennis Space Center

Richard A. Galle
(601) 688-1929

John F. Kennedy Space Center

James A. Aliberti
(407) 867-3017

Langley Research Center

C.J. Shoemaker
(804) 864-2488

Jet Propulsion Lab

Arif Husain
(818) 354-4862
Technology Utilization
Manager:
Wayne Schober
(818) 354-2240
Technical Information
Inquiries: 1-800-832-4575

Ames Research Center

Geoffrey S. Lee
(415) 604-4044

Lewis Research Center

Anthony F. Ratajczak
(216) 433-5568

NASA Headquarters

Leonard A. Ault
(202) 358-0721

Army Research Lab

Norma Vaught
(301) 394-2952

Armstrong Laboratory, Brooks AFB

TASC
Dean Knisely
(210) 536-3709

Department of Energy:

Brookhaven National
Laboratory
Margaret C. Bogosian
(516) 282-7338

Naval Air Warfare Center, Warfare Division, China Lake

Dr. Bill Webster
(619) 939-1074

Naval Command, Control, and Ocean Surveillance Center, San Diego

RDT&E Division
Harvey Fendelman
(619) 553-3001

Naval Surface Warfare Center, Crane Division

Mike Gentile
(812) 854-2379

NASA Center for AeroSpace Information can answer questions about NASA's Technology Transfer Network and its services and documents. Call or write to: NASA Center for AeroSpace Information, Technology Transfer Office, 800 Elkridge Landing Rd., Linthicum Heights, MD 21240-2934. Walter M. Heiland, Manager, (410) 859-5300, Ext. 245.

SUPERIOR PERFORMANCE. SIMPLE TO USE.

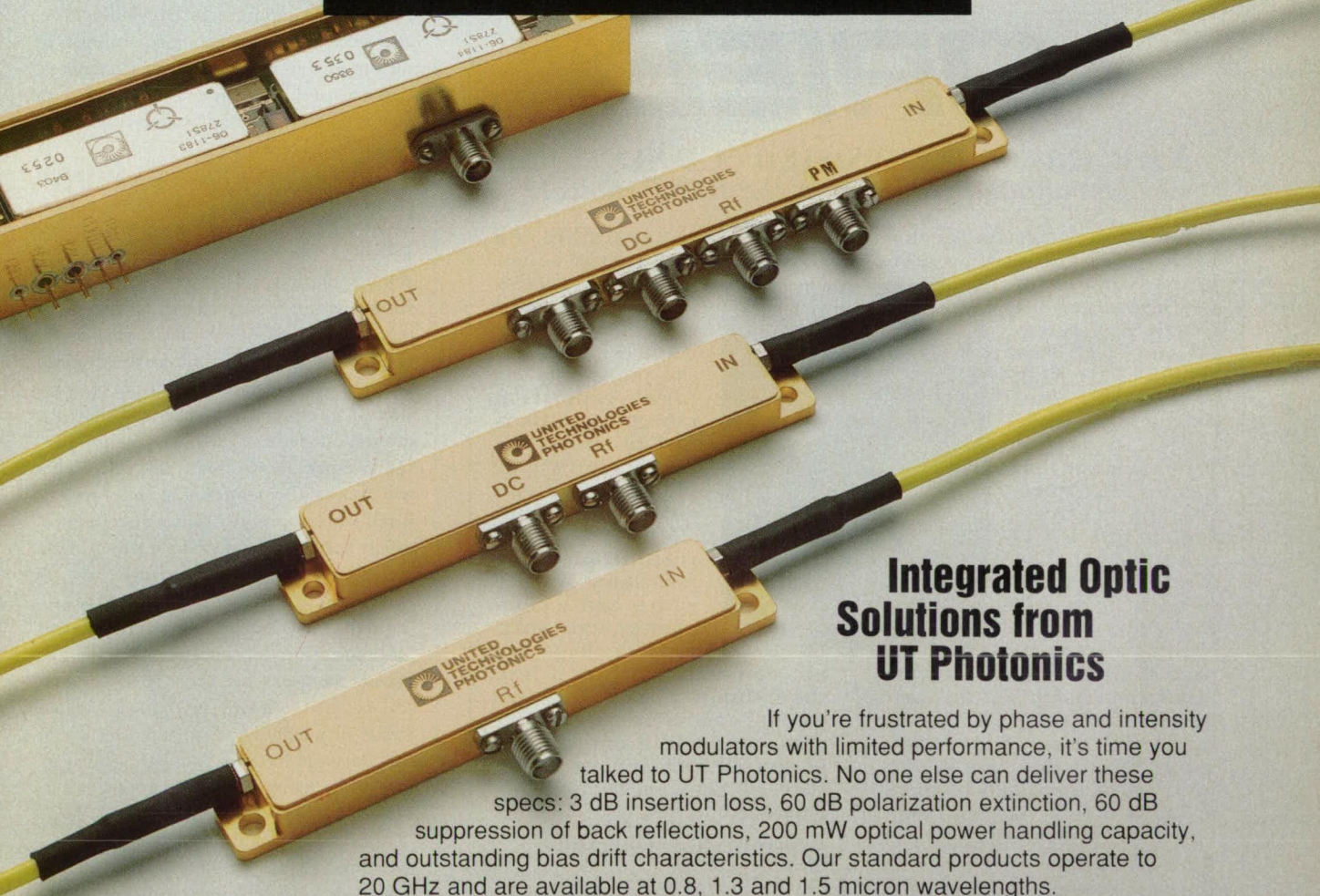

Integrated Optic Solutions from UT Photonics

If you're frustrated by phase and intensity modulators with limited performance, it's time you talked to UT Photonics. No one else can deliver these specs: 3 dB insertion loss, 60 dB polarization extinction, 60 dB suppression of back reflections, 200 mW optical power handling capacity, and outstanding bias drift characteristics. Our standard products operate to 20 GHz and are available at 0.8, 1.3 and 1.5 micron wavelengths.

We said our devices were easy to use and we meant it. Only UT Photonics gives you single or dual outputs, APC connectors and cabled fiber. For high-performance applications we can even integrate the bias stabilization electronics and photodetector for control, all within the modulator package.

Our rigorous quality control and production capabilities have produced thousands of ultra-reliable devices. These modulators have withstood the shock of cannon blasts, the chill of liquid nitrogen and the demands of cable TV distribution.

If you need something special, we'll put our applications engineering expertise to work on designs that are transferable to high volume production.

To find out more about our family of modulators, send for our free brochure.



1289 Blue Hills Avenue, Bloomfield, CT 06002 Tel: 203 769-3000 Fax: 203 769-3001

For More Information Write In No. 301

EDITORIAL NOTEBOOK

Japan Joins U.S. In Optoelectronic Partnership

As I write, Japanese and American negotiators are deadlocked on trade concessions by Japan, and the threat of sanctions hangs in the air. In this context it is refreshing to know that the two countries are cooperating in an optoelectronic project of potentially great mutual benefit.

In April, representatives of the two countries signed the Implementation Plan of the U.S.-Japan Joint Optoelectronics Project, and late in June they agreed on the final critical step toward realization of the agree-

ment's goals. The Project is to be part of Japan's Real World Computing Partnership (RWCP), a 10-year, \$700-million initiative to develop the next generation of information-processing technologies.

Four years ago a Washington interagency group and representatives of Japan's Ministry of International Trade and Industry (MITI) began looking at how U.S. manufacturers could participate in the RWCP. Consultations with the technical communities in both countries led to the selection of optoelectronics as the means to meet the demands for speed and throughput for next-generation computers. In December 1992, after what Judson French, a co-chairman of the project's Joint Management Committee, calls extensive meetings and workshops with people in industry and academia, the two nations came to terms.

The step taken in June was agreement on the process for selecting and funding a "broker" through which the project will be carried out in the U.S. The broker, one in each country (Japan's will be the Optoelectronic Industry and Technology Development Association), will offer a service that brings together designers of innovative advanced computer systems and fabricators of optoelectronic components, which will allow the designers to evaluate their ideas by manufacturing experimental prototypes. The broker will also handle nontechnical issues such as intellectual property rights and import-export licenses to protect the interests of the participants and facilitate exchange.

NIST is in the process of selecting the broker in the U.S. Deadline for receipt of requests for proposal was September 12. According to French, the agency had about 50 at that date, and expected to award the contract within a matter of weeks. The Plan stipulates that it will remain in force for two years after signature of the Agreement, at which time it may be terminated by either of the parties.

One feature of the plan is sure to raise eyebrows: all the funding for the brokers' operations in both countries is to come from MITI, sponsor of the RWCP. Additional support will come from fees charged users, who in turn may receive federal funds through one of the advanced technology programs of Commerce, Defense, or another U.S. agency. But, as French put it, "nothing will flow to the brokers directly from the U.S. Treasury."

For more information contact the office of the Director of the Electronics and Electrical Engineering Laboratory at the National Institute of Standards and Technology (NIST), B358 Metrology Bldg., Gaithersburg, MD 20899-0001; Tel: (301) 975-2220; Fax: (301) 975-4091.

Robert S. Clark
Editor



ORIEL

NEW GATED INTENSIFIED CCD SYSTEMS not just another choice...but the BEST choice!!

If you need to measure photon light levels, with ns time resolution, you'll want to know about Oriel's new Intensified CCD systems. Their high sensitivity and detectability make them ideal for Raman, Luminescence, Microspectroscopy and Imaging. If our ICCD can't see it, then it's because there is nothing there! And, our ICCDs are the most compact available. The detector head incorporates an optimized three stage TE cooler, intensifier power supply and gating electronics. The sensor head saves space and requires no bulky cabling for easy adaptation to any experiment.

What do I get?

Choose between standard CCD sensor formats, 1024 x 256 (spectroscopy) or 576 x 384 (imaging) and 18 or 25 mm image intensifier. (Other CCD

formats are available on request.) We specially select the photocathodes for wide spectral coverage from the UV to the NIR, and the phosphors for high repetition rate gating. Gain is variable from 1 to 200 counts per photoelectron and noise is <2 count RMS. 16 bit A/D resolution, 5 ns minimum gate width and a comprehensive software package are

all included. And you'll love the software package - it gives you full control over intensifier gain, gate width and delay - perfect for fully automatic capture of fluorescence decay curves.

Interested in Finding Out More?

Give us a call today and one of our Spectroscopy Engineers will give you all the details, or request our free catalog.



For immediate response 24 hours a day, dial Oriel's



FAX ON DEMAND SYSTEM
1-800-949-4049

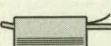

and respond with Program No. 300, Document No. 1006

ORIEL
INSTRUMENTS

Making Light • Moving Light • Measuring Light

250 Long Beach Blvd., P.O. Box 872, Stratford, CT. U.S.A. 06497

TEL: (203) 377-8282 • FAX: (203) 375-0851 • E-MAIL: 73163.1321@compuserve.com

BENELUX FRANCE GERMANY ITALY SWITZERLAND UNITED KINGDOM

NEW!



Motorized Beam Expander

Provides dynamic control of the laser beam size in a flying optics system. The lens spacing is adjusted by a motor driven micrometer which is remotely controlled via toggle switch or optional computer interface. Adaptable for systems where beams sizes must be controlled over large working distances.

For More Information Write In No. 302

NEW!



Parabolic Mirrors

II-VI offers Off-Axis Parabolic Mirrors - PM Series providing high power CO₂ laser users with diffraction limited performance. Ideally suited for laser power levels >5000W, where conventional transmissive lenses cannot be used.

For More Information Write In No. 321

NEW!



All Reflective Beam Expander

Ideal for broad band applications where refractive designs are not practical. Utilizes precision single point diamond turned mirrors. Interferometrically tested to insure product integrity. Well suited for field and laboratory conditions.

For More Information Write In No. 322

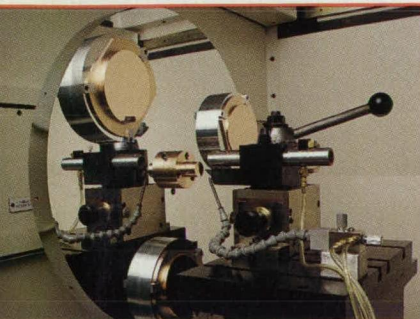

Precision Diamond Turning

II-VI offers ultra-precision 2 axis diamond turning achieving feedback resolution of 1.25 nanometers (0.05 microinches) with CNC, interferometer controls. Work piece capacity is 600 mm (24") in diameter.

For More Information Write In No. 323

NEW!



ATFR Beam Delivery Mirrors

Absorbing Thin Film Reflectors are designed for use in high power CO₂ lasers. They act as optical isolators to prevent unwanted reflections from re-entering the laser cavity. ATFR mirrors reflect $\geq 98.5\%$ of S-polarization to the work surface while reflecting $\leq 1.5\%$ of the P-polarization.

For More Information Write In No. 324

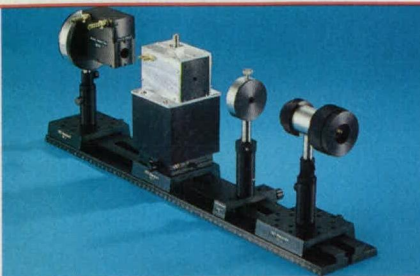

Multi-Component Optical Assemblies

Our technical staff provides simple solutions to complex problems. Combines standard II-VI components such as Electro-optic Modulators, Polarizers, Beam Expanders, and Waveplates to precisely control your laser beam parameters.

For More Information Write In No. 325

II-VI Incorporated

*Offering More In
IR Technology*

II-VI Incorporated is your single source for crystalline growth of ZnSe, ZnS and CdTe Materials... Finished Optics...Optical Thin Film Coatings...Optical, Electro-Optical and Opto-Mechanical Design...Optical Assemblies... Nuclear Radiation Detectors... Diamond Turning Services.

(412) 352-1504

Phone

(412) 352-4980

Fax

II-VI

INCORPORATED

375 Saxonburg Blvd.
Saxonburg, PA 16056

LASERTECH '94

EXHIBITS PREVIEW

LaserTech '94, the Photonics Technology Transfer Conference and Exhibition, will take place as part of Technology 2004 (November 8-10, Washington, DC convention center). The special Laser Pavilion, featuring the registrants named below, brings together exhibits by industry, government, and academia highlighting new inventions, products, processes, and services for license, sale, or cooperative partnerships. A daylong LaserTech '94 Technology Transfer Conference November 9 will spotlight commercially exploitable photonics technologies developed in federal laboratories. (For more information, see the facing page.) Below, in addition to exhibitors in the Laser Pavilion, are literature and other photonics-related exhibits.

LASER PAVILION

Alliance for Photonic Technology 612A
Albuquerque, NM
APT represents the photonics R&D capabilities of the federal laboratories in New Mexico and the University of New Mexico. Information will be available from Sandia National Labs, Los Alamos National Lab, Phillips Lab, and the UNM Center for High Tech Materials.

Big Sky Laser Technologies 711
Bozeman, MT,
specializes in compact, rugged, solid-state lasers for real-world applications. On display will be the model CFR 200 Nd: YAG Laser and various specialty laser pump cavities and accessories.

Carl Zeiss Optical 612B
Petersburg, VA,
will exhibit Micron Laser Eyewear, which offers protection against light from 180-2100 nm with optical densities up to 7. Three stylish frames with molded sideshields are available.

CEBAF 718
Newport News, VA,
will present a plan for a superconducting radio-frequency-driven free-electron laser that has promise as a source of tunable high average power coherent light for military and industrial applications.

IEEE/Lasers & Electro-Optics Society 714B
Piscataway, NJ,
will feature information on membership in IEEE and LEOS. Complimentary copies of LEOS publications and conference promotion will be available.

ILX Lightwave Corp. 716
Bozeman, MT,
manufacturers electro-optic instrumentation in the areas of laser diode control, fiber optic test and measurement, and laser measurement. Products include laser diode controllers and parameter analyzers, fiber optic light sources and meters, multimeters and wavelength meters.

IntraAction Corp.—Acousto Optics 614
Bellwood, IL,
will exhibit acousto-optic devices including modulators, deflectors, optical frequency shifters, tunable filters, mode lockers, Q-switches, a polychromatic modulator, and associated OEM or laboratory drive electronics including frequency synthesizers and RF power amplifiers.

Light Brigade Inc. 817
Kent, WA,
conducts training seminars and videotapes for fiber optics covering system design, installation, and maintenance. A catalog listing the various courses and videotapes is available. Supplies and tools for the technician and end user also will be on display.

Moyno Precision Coated Abrasives 713A
Montgomeryville, PA,
manufactures an integrated line of precision finishing

materials. Products include lapping film, abrasive powder, micro-finishing film, vehicle, coolant, and polishing pads.

Oriel Corporation 713B
Stratford, CT,
will exhibit its new ICCD detection system, InstaSpec V, a complete turnkey gated intensified CCD system that has a 5-nsec minimum gate width and comes with a spectroscopy and imaging PC-based software package.

Photonics Spectra 715
Pittsfield, MA
Free copies of Photonics Spectra magazine for photonics technology, covering optics, lasers, fiber optics, electro-optics, imaging and optical computing. Also on display will be the 4-book Photonics Directory Set.

QUEST Integrated Inc. 813
Kent, WA,
will display EUCLID™, an advanced laser alignment tool for use in aerospace manufacturing, civil engineering, ship construction, and large rotating machinery alignment.

Rocky Mountain Instrument 616
Logmont, CO,
will exhibit precision laser and imaging optics, coatings, assemblies, and instrumentation from UV to far infrared, custom, standard and OEM.

Spiricon Inc. 714A
Logan, UT,
will highlight state-of-the-art products for spatial intensity and propagational analysis of all laser sources, UV to far IR, CW and pulsed, from microwatts to megawatts.

SPINOFF PAVILION

Center for Optics Manufacturing 833
Rochester, NY,
will display information related to its OptiCAM, OptiCIM, Manufacturing Science, and OptiMOD programs.

LITERATURE EXHIBIT

Anorad Corp. 749
Hauppauge, NY
A positioning equipment technology guide provides an overview of engineered motion-control systems. Anorad's products include linear, rotary, and air-bearing stages; linear servo motors; and controls.

Automation Gages Inc. 749
Rochester, NY,
manufactures high-precision ball and cross roller linear bearings with travels from 1/2 inch to 35 inches and available in aluminum, steel, and cast iron.

Balzars 749
Hudson, NH
Literature will describe Balzars' Full Range™ vacuum gauge measures from atmosphere to UHV by utilizing two gauges in one. Turbomolecular Drag pumps permit the use of a

backing pump 100 times smaller for savings in cost, space, and power.

EPIX, Inc. 749
Buffalo Grove, IL
A brochure will detail the 4MEG VIDEO Model 12 for image acquisition, processing, and display on PC-compatible interfaces to almost any video source and offers up to 256 MB of image memory.

E-Tek Dynamics Inc. 749
San Jose, CA
The company's catalog features world-renowned fiber optic products including isolators, couplers, WDMs, passive components, electro-optic devices, laser instruments and systems.

Exciton, Inc. 749
Dayton, OH
A catalog will feature a broad range of laser dyes as well as the following technical information: wavelength, pump source, solvent concentration, and molecular weight. A complete set of references and a four-color laser wavelength chart also are included.

Fenix Technology 749
Yuma, AZ,
manufactures arclamps and flashlamps. Its brochure describes standard lamps suitable for a variety of lasers, CAD technology, and Thorium-free products.

ISOMET Corp. 749
Springfield, VA,
manufactures acousto-optic modulators and multi-channel modulators with integral beamsplitters, deflectors, frequency shifters, AOTFs and related RF drive electronics. Spectral ranges are UV, visible, and IR to 12 microns.

JML Direct Optics 749
Rochester, NY
The Second Edition of the JML Direct Optics catalog is available with complete design parameters for singlets, doublets, and triplets. Multi-element systems, coatings, cylinders, and prisms also are available from stock.

Optigain Inc. 749
Peace Dale, RI
Literature will describe rare-earth doped fiber amplifiers for 1550 nm, 1300 nm, and 800 nm bands and other custom-built active fiber devices including lasers and filters. Comprehensive computer models for fiber amplifiers, lasers, and single-mode fibers also will be highlighted.

Panasonic Broadcast & Television Systems 749
Rockville, MD,
manufactures a full line of professional/industrial video recorders, monitors, and production equipment.

Scientific Measurement Systems Inc. 749
Grand Junction, CO,
manufactures the Jarrell-Ash line of gratings, monochromators and spectrographs. The company's engineers can provide customized instruments.

LAST CHANCE TO PREREGISTER

LASERTECH '94

THE PHOTONICS TECH TRANSFER CONFERENCE

NOVEMBER 9, 1994
WASHINGTON, DC CONVENTION CENTER

Sponsored by Laser Tech Briefs magazine and the Technology Utilization Foundation in cooperation with the Federal Laboratory Consortium for Technology Transfer

LaserTech '94 will spotlight the latest laser, electro-optics, fiber optics, optics, and imaging technologies developed by U.S. national laboratories and their contractors under the government's \$75 billion annual R&D budget. This information-packed meeting, held in conjunction with the Technology 2004 conference, will expose a wealth of

commercially-promising, licensable inventions from NASA, NIST, the departments of Defense and Energy, and other major government agencies. LaserTech '94 specifically can help you:

- ▲ find new product ideas and design/manufacturing solutions;
- ▲ identify potential partners and funding sources;
- ▲ connect with the government's top technologists and tech transfer specialists in the photonics field;
- ▲ stay ahead of the technology curve — and the competition — by learning about the latest advances before they reach the market.

FOR A DETAILED PROGRAM WITH HOTEL INFO, CALL (212) 490-3999.

REGISTER BY OCTOBER 21 TO SAVE 15% OR MORE.

LASERTECH '94 PREREGISTRATION FORM

USE A SEPARATE FORM OR PHOTOCOPY FOR EACH REGISTRANT. BE SURE TO ANSWER ALL QUESTIONS BELOW.

Name _____

Title _____

Company _____

Address _____

City/St/Zip _____

Phone No. _____

Which of the following best describes your industry or service? (check one)

- | | |
|--|---|
| <input type="checkbox"/> A Electronics | <input type="checkbox"/> I Industrial Equipment |
| <input type="checkbox"/> B Computers | <input type="checkbox"/> J Manufacturing |
| <input type="checkbox"/> C Communications | <input type="checkbox"/> K Power/Energy |
| <input type="checkbox"/> D Transportation/Automotive | <input type="checkbox"/> L Biomedicine |
| <input type="checkbox"/> E Aerospace | <input type="checkbox"/> M University |
| <input type="checkbox"/> F Defense | <input type="checkbox"/> N Research Lab |
| <input type="checkbox"/> G Government | <input type="checkbox"/> O Other |
| <input type="checkbox"/> H Materials/Chemicals | specify _____ |

Which of these products do you recommend, specify, or authorize the purchase of? (check all that apply)

- | | |
|--|---|
| <input type="checkbox"/> P Lasers | <input type="checkbox"/> W Test & Measurement Equip. |
| <input type="checkbox"/> Q Laser Parts & Accessories | <input type="checkbox"/> X Electronics & Signal Analysis Equip. |
| <input type="checkbox"/> R Laser Systems | <input type="checkbox"/> Y Positioning & Support Equipment |
| <input type="checkbox"/> S Optical Components | <input type="checkbox"/> Z Materials and Substrates |
| <input type="checkbox"/> T Detectors/Sensors | <input type="checkbox"/> 1 Vacuum & Gas Handling Equipment |
| <input type="checkbox"/> U Cameras | <input type="checkbox"/> 2 Fiber Optic Components & Systems |
| <input type="checkbox"/> V Imaging/Display Equipment | |

Your principal job function is: (check one)

- | | |
|---|---|
| <input type="checkbox"/> A General & Corporate Management | <input type="checkbox"/> E Manufacturing/Production |
| <input type="checkbox"/> B Design & Development Engineering | <input type="checkbox"/> F Purchasing/Procurement |
| <input type="checkbox"/> C Engineering Services - Tests/Quality | <input type="checkbox"/> G Other |
| <input type="checkbox"/> D Basic Research | specify: _____ |

Please register me for the following: (check all that apply)

- | | |
|--|------------|
| <input type="checkbox"/> F LaserTech '94 Registration |\$120 |
| (includes continental breakfast and networking luncheon) | |
| <input type="checkbox"/> G Technology 2004 upgrade fee |\$165 |
| (LaserTech '94 registrants ONLY.) | |
| <input type="checkbox"/> E Exhibits Only |Free |

TOTAL: \$ _____

- Check/MO enclosed (payable to Technology Utilization Foundation)
 Charge my: Mastercard VISA Am Ex

Card No. _____ Expire Date _____

Signature _____ Date _____

Registrations are transferrable and may be cancelled until October 21, 1994. After that date no cancellations will be refunded.

Return with payment to: Technology Utilization Foundation
c/o LaserTech '94, PO Box 614, Brookfield, IL 60513-0614

FOR FASTEST REGISTRATION FAX TO: (708) 344-9482

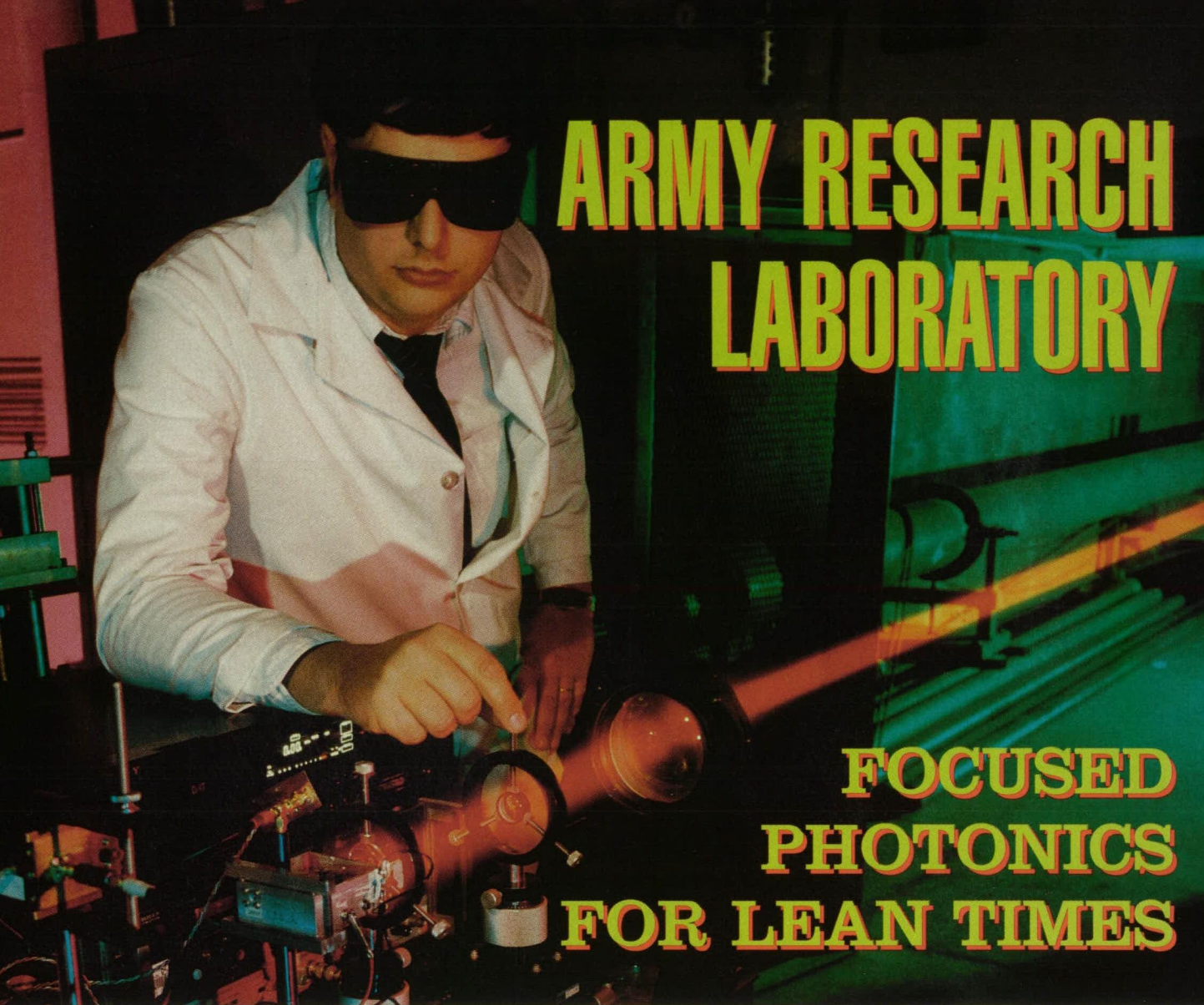

ARMY RESEARCH LABORATORY

FOCUSED PHOTONICS FOR LEAN TIMES

for the U.S. Army Research Laboratory, 1993 was a watershed year, a time of reorganization and consolidation. As its new director, Dr. John W. Lyons, took the helm to fuse the lab's existing constituent parts into a more cohesive whole, and to redefine ARL's mission, there were budget cuts and personnel reductions to contend with as well. But as Dr. Lyons puts it in the most recent ARL *Annual Review*, "I am convinced of the soundness of the concept of a single, central laboratory for technology base support of Army materiel....While our basic areas of endeavor will remain the same — basic research, technology development, and analysis — we will be shifting our focus somewhat more to the longer view, i.e., to fundamental studies of new and emerging areas with the potential to insure that the balance of technology remains in favor of the United States."

No technology sector could better fit the phrase "emerging areas" than photonics. Located at ARL's Adelphi, MD, Laboratory Center (many know it as the former Harry Diamond Laboratories) and at Ft. Monmouth,

NJ, the photonics programs are significant elements of the work of the Sensors, Signatures, Signal and Information Processing Directorate and the Electronics and Power Sources Directorate.

Currently the Laboratory as a whole has about 3500 employees and a budget running close to \$500 million. Of the staff, about 110 are involved in the photonics programs at the two sites. The budget for the S³I Directorate stands at about \$44 million and for the EPS Directorate at about \$2 million more than that.

Many Means, a Single Aim

The overall aim of the optical processing program is summed up as fast, accurate detection and processing of wide-bandwidth signals using compact hardware. Among the means the program contemplates for achieving this aim are acousto-optics, fiber optics, magneto-optics, diffractive optics, III-V optoelectronic devices, and integrated optics. The Army systems that will potentially benefit from development of optical signal and image processing modules are multi-role survivable radar, real-

Research into laser radar contemplates applications from automatic target recognition and low-signature detection to proximity fuzing and obstacle avoidance.

time synthetic aperture radar image formation, automatic target recognition, and electronic support measures (ESM) processing.

In the last category, a current project, in conjunction with researchers at Dynetics Inc. in Huntsville, AL, is the development of an acousto-optic correlator that will serve to upgrade an ESM receiver. The AO module is part of the Advanced Research Projects Agency Transition of Optical Processors into Systems (TOPS) program, and will be incorporated into an ESM testbed developed by the Intelligence and Electronic Warfare Directorate of the Army's Communications and Electronics Command.

Current ESM and electronic intelligence (ELINT) systems face a future in which radio frequency (RF) systems use more sophisticated wideband modulation techniques — direct-

Not only can it cut,

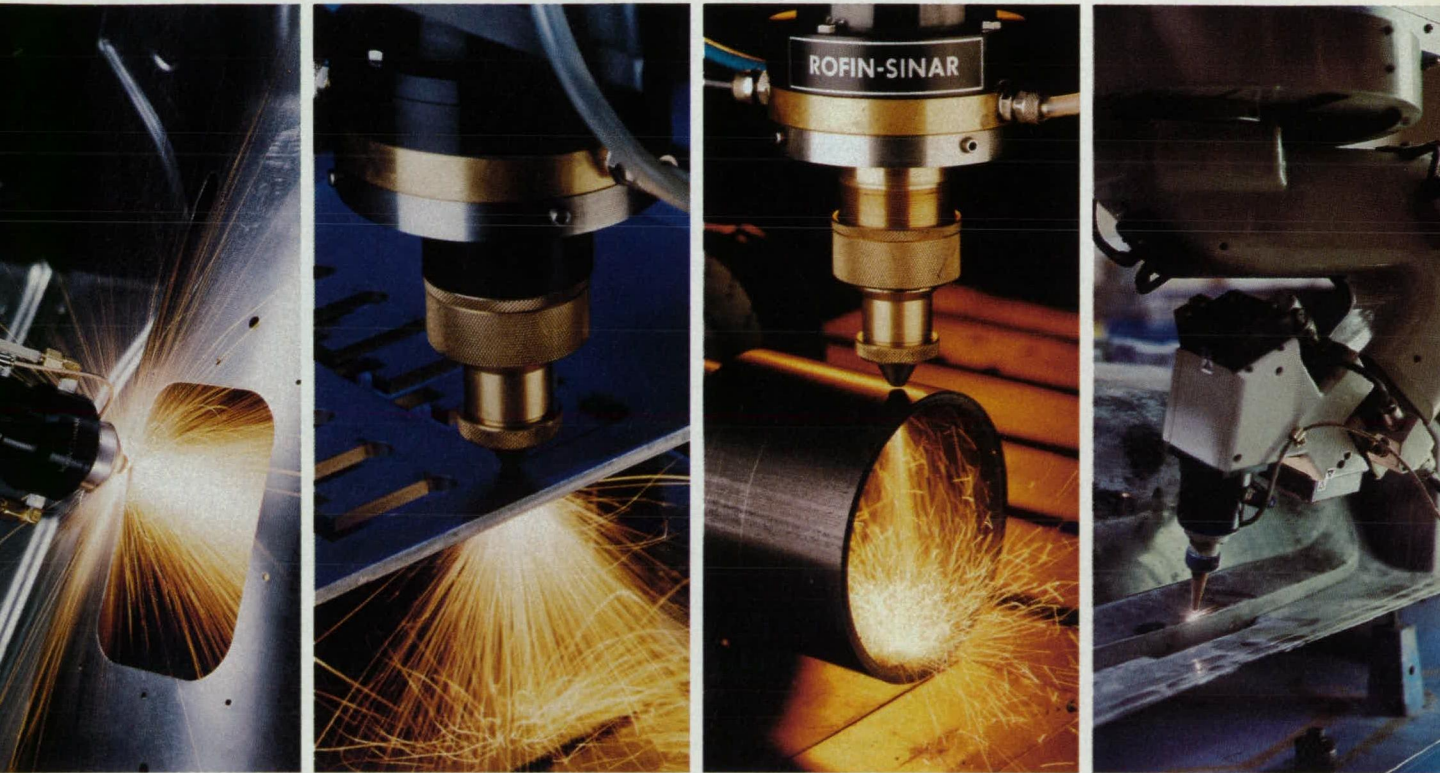

it can also trim some of the fat.

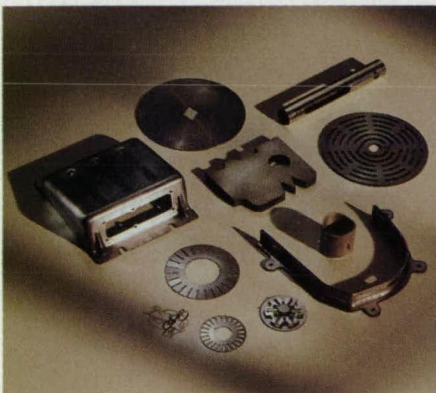

Time and time again, laser cutting has proven itself to be the most cost efficient and flexible way to cut when compared to other processes such as nibbling, punch press, flame and plasma, and stamping. And Rofin-Sinar has been the leading supplier of CO₂ and Nd:YAG lasers for cutting systems since 1984.

▶ When compared to nibbling and punch presses, laser cutting provides less set up time, less tool wear and maintenance costs, greater accuracies and the ability to 3-dimensionally cut.

▶ Lasers provide greater accuracy, a finer edge quality and minimal heat affected zone when compared to flame and plasma cutting.

▶ With regards to stamping, lasers offer the flexibility to change from job to job within

minutes, quickly generate new shapes, and cost, maintenance, and set up time of dies are virtually eliminated.

Laser cutting cuts down the time it takes for a part to go from the drawing board to reality. Within specified capacities and thicknesses, there's no job a laser cannot do.

So if your production is getting a bit heavy and you're looking for ways to save time and money, look to Rofin-Sinar to help you trim some of the fat. Call or write.

Rofin-Sinar, Inc.
45701 Mast Street, Plymouth, MI 48170
313/455-5400 FAX: 313/455-2741

For More Information Write In No. 305

THE POWER OF LIGHT
ROFIN SINAR
LASER
A SIEMENS Company

sequence, phase-modulated, frequency-hopped, and chirped signals — to achieve high range resolution and evade interception. Thus new ESM/ELINT receivers must evolve to detect and classify these signals. At present only about 7 percent of radars use spread-spectrum techniques, but Army sources estimate that the figure will be greater than 70 percent by 2020.

To Catch a Wide Bandwidth

The AO correlator will address these needs by adding to the testbed a capability to simultaneously detect and characterize a 500-MHz bandwidth signal. By contrast the existing detector processes a wide bandwidth signal but can only detect the presence of narrowband signals. The AO module is an in-line, time-integrating correlator architecture that detects and analyzes wideband signals in a small and lightweight package.

The correlator's first configuration was as a breadboard used to characterize mechanical sensitivities. The brassboard will be built on a Melles Griot breadboard that can be moved to the field test site, where a modularized demonstration is scheduled for next year. Through path folding and miniaturization, final dimensions are estimated at 10" x 7" x 7". Progress in miniaturization to date is shown in the illustrations.

In another aspect of the TOPS initiative, an ARL-Dynetics team aims to substitute an AO range-Doppler processor for several digital processor boards in an advanced ground-based radar system developed by the Army Missile Command. The new instrument's job is to perform real-time processing in parallel with the existing system. The processor requires three signals to form the range-Doppler images: the radar's return signal, a reference code for code correlation, and a chirp signal to form the desired Doppler filters. Its architecture consists of two AO modulators illuminated by a laser diode source in an interferometric additive arrangement. The reference code modulated onto a chirped carrier intensity-modulates the coherent source, the radar return waveform is input into one AO cell, and a chirp is input into the second. The combined outputs are imaged onto a two-dimensional photodetector array.

The array is a critical component in the system. Developed for ARL by David Sarnoff Research Center specifically for high speed and high performance, it is a high-fill-factor (100%) 512 x 512-element backside-illuminated split frame-transfer device with a 15-MHz data rate and readout through 16 output ports.

Assaying Charge Sampling

In another cooperative arrangement with Loral Fairchild Imaging Sensors, an ARL team is working on both one- and two-dimensional nonlinear charge-sampling CCD arrays. The technique, which achieves piecewise linear gain compression, has been applied in a 1-D

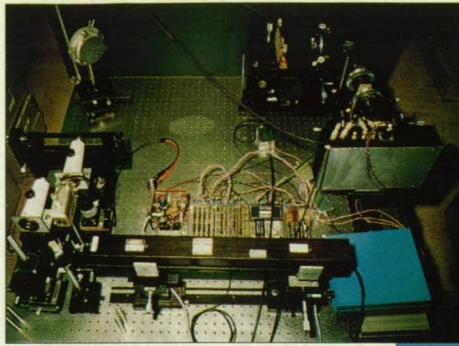

In the critical optical correlator program at ARL, progress in miniaturization since the early eighties has been dramatic, as these before-and-after photographs show.

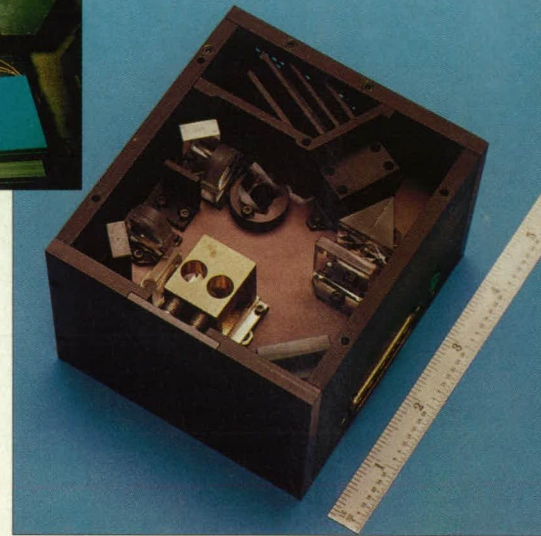

array and a design concept developed for a 2-D array. For low light levels, the photogenerated charge accumulates in a small potential well under the storage gate. When light levels exceeded the small well's capacity, additional charge collects in a large well that includes the photosite area under the photogate and the storage gate. Charge splitting provides a sample of the excessive charge just prior to readout, and the sum of small charge and sampled charge is then transferred into the shift register for readout.

After this process, the antiblooming gate is pulsed and any remaining charge under the photogate is swept into an antiblooming "drain" to clear the photosite for the next integration period. For very high light levels, at photosite saturation, charge spills preferentially into the antibloom sink diode. This structure allows individual pixels to operate at light intensities well above saturation without blooming into adjacent pixels. With this technique, the team has reached levels of 65 dB of optical dynamic range. Low-level signal sensitivity is maintained while high signal levels are attenuated.

Tomorrow's battlefield weaponry will depend greatly on automatic target recognition and detection of targets with hard-to-distinguish signatures. One of the most promising developmental areas is the use of laser transmitters in radar, often called ladar systems. In one corner of ARL a team is bouncing a near-IR injection laser beam off a dummy target at one end of a disused tunnel, developing the signature phenomenology, sensor data, and signal processing algorithms that will be used in future battlefield scenarios. Other applications of such transmitters and sensors might be in proximity fuzing, smart munitions, robotic navigation, and obstacle avoidance.

One of the most innovative areas of research is that of diffractive optics. ARL has

developed techniques for the design and fabrication of diffractive optical elements (DOEs) to replace bulky and larger refractive optics, with a particular focus on the design of binary-phase elements that realize complex transfer functions accurately and efficiently. DOEs are attractive for several applications, including optical interconnects, laser diode optics, and military imaging systems.

Steps Toward Athermalization

An ARL team has done work on the thermal behavior of both refractive and diffractive lenses. It has determined that the change in focal length of a diffractive lens is not linked to temperature-induced changes in the refractive index of the material, a fundamental difference in the thermal behavior of refractive and diffractive lenses.

The team gauged opto-thermal expansion coefficients of common materials for both lens types, including BK7, FK52, SF11, fused silica, acrylic, and germanium. The last two are commonly used materials, the first in consumer products and the second in infrared military systems. When compared with common glass materials, it is clear that they have extremely high opto-thermal expansion coefficients, making it difficult to design plastic and infrared optical systems to operate over wide temperature ranges. The ARL team's work suggests that the diffractive lens's low coefficients should make DOE designs for such applications easier to achieve.

A marriage of optoelectronic and microwave technologies is being applied to schemes for both control and isolation from electromagnetic interference. ARL researchers, led by the Weapons Technology Directorate, have demonstrated a hybrid optoelectronic limiter that is self-initiated by the EM event, and an

Multiple Pages Intentionally Left
Blank

attenuator for remotely controlling microwave integrated circuits. In both the technique involves optically illuminating one of two gaps between the center and outer conductors of a 50-ohm silicon coplanar waveguide-photoconductive switch. Using 143 mW of laser diode power, limiter isolation and microwave attenuation reaching 45 dB have been demonstrated at 1.7 GHz. According to the researchers, the figures are the highest reported to date for any limiter or attenuator scheme. The limiter's performance was attributed to the use of a silicon substrate, but the researchers plan to investigate an all-GaAs design, which would be more compatible with monolithic microwave integrated circuits.

Microphotonics is naturally a central watchword in the quest for greater speed and bandwidth and reduced size and weight. In the Electronics and Power Sources Directorate, a team uses advanced III-V semiconductor growth and device technology to integrate electronic and optical functions into lattice-matched GaAs/AlGaAs systems. Another program focuses on hybrid systems, especially on combining thin-film structures containing gallium arsenide and other III-V compounds with silicon substrates so that lasers and other components can be integrated with silicon-based digital electronics. The team is also working on

prototyping III-V semiconductor-based quantum-confinement devices such as bistable switches, single-mode waveguide structures with nonlinear elements, and multielement devices such as smart pixels.

Other programs in this Directorate investigate new materials and methods of fabricating detectors for uncooled IR systems. Thin-film technology is being used to make prototype uncooled detectors fabricated from thinned bulk ceramic ferroelectric materials such as barium strontium titanate. Another group is working on the next generation of focal plane arrays, developing ways to build electronic signal and image processing functions into the array rather than to do the processing externally.

Another of this Directorate's initiatives takes three approaches to extend diode and solid-state laser source technologies into new wavelength areas. The first is the use of wider-bandgap materials such as ZnSe and GaN for diodes that will emit at green, blue, and ultraviolet wavelengths. In a second approach, rare-earth ions such as praseodymium are embedded in host crystals to make visible solid-state lasers. Finally, investigation goes on into wavelength shifting techniques such as frequency doubling, optical parametric oscillation, and Raman shifting to convert near-IR output.

A Commitment to Technology Transfer

ARL looks on itself as the primary technology development force within the Army and therefore at the forefront of the response to the current administration's defense conversion and dual-use initiatives. The Army helped found the Federal Laboratory Consortium, which brought federal R&D organizations together with the aim of identifying and pursuing technology transfer.

Through its Domestic Technology Transfer (DTT) program, ARL has generated 99 Cooperative Research and Development Agreements (CRADAs) and 19 Patent License Agreements (PLAs) through August 1994, an achievement that it calls the best record in the Department of Defense. In fiscal year 1994 to date, ARL has a 250-percent improvement over 1993.

Among potentially marketable products supported by ARL CRADAs are sporting goods (new materials for windsurfer masts and hockey sticks), new lightweight printing rollers and shafts, laser-guided imaging for tooling, and composite wind turbine blades. With the current push to stimulate and sustain long-term economic growth, DTT is the mechanism by which the R&D resources of the Army can meld with those of private businesses, academia, and local and state governments for joint development of technologies. □

Our first step in lens production is to save you money.

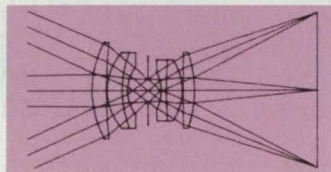

Sometimes savings are hidden in your designs.

Before producing any order, we at Plummer Precision Optics evaluate your specifications and produce test samples. We search to see whether a more efficient lens design might give you the performance you need, AND save you money. Then we refine manufacturing procedures to build in all the performance and economy your specifications will allow.

We custom produce every order.

From test sample, to its reproduction thousands of times, Plummer has invested over 50 years in refining optical manufacturing technology. We've learned that every order, to

be right, must be custom produced. And if the technology doesn't exist, we invent it...often to the benefit of the entire optics industry.

The result: the highest, most consistent lens quality for the most competitive prices to be found. Delivered on time!

Come see us. We'll be happy to show you some of the most advanced optics manufacturing technology in the world today...beginning with economy.



plummer
precision
optics

If it doesn't exist,
we invent it.

601 Montgomery Avenue, Pennsburg, PA 18073
800-4450-PPO • 215-679-6272 • FAX 215-679-2277

ELECTRONIC COMPONENTS AND CIRCUITS

Improved Thermoelectrically Cooled Laser-Diode Assemblies

Cooling decreases wavelength and increases efficiency and lifetime.

Goddard Space Flight Center, Greenbelt, Maryland

Two improved thermoelectrically cooled laser-diode assemblies that incorporate commercial laser diodes provide a combination of both high wavelength stability and broad wavelength tuning. These assemblies are prototypes of broadly tunable, highly stable devices for injection seeding of pulsed, high-power tunable alexandrite lasers that are to be used in lidar remote sensing of water vapor at wavelengths in the vicinity of 727 nm. Injection seeding is needed to ensure reliable narrowband operation and wavelength stability adequate for the water-vapor measurements. The laser spectral line must be narrower than 500 MHz, which is substantially less than the line width of a typical pulsed, high-power, tunable laser.

The improved thermoelectrically cooled laser-diode assemblies provide the temperature control needed to take advantage of the tunability of commercial AlGaAs laser diodes in the present injection-seeding application. These laser diodes emit light at wavelengths of about 740 nm at room temperature (nominally, 22 °C), and the wavelength decreases with temperature. Thus, by cooling to a suitable temperature below ambient, one can adjust the wavelength to 727 nm or any other desired value within the temperature-tuning range. Commercial thermoelectrically cooled laser-diode assemblies were found inadequate for this purpose in three ways: they lacked sufficient cooling power to produce temperatures below -15 °C (not cold enough to reach the desired wavelength), they did not include vacuum housings (which are needed to prevent condensation of water on the laser diodes), and their thermal masses were insufficient to provide the required thermal stability.

Figure 1 shows one of the improved thermoelectrically cooled laser-diode assemblies mounted in a 4-in. (about 10-cm) diameter vacuum chamber with electrical feedthroughs. In one assembly, the laser diode is clamped to a cold

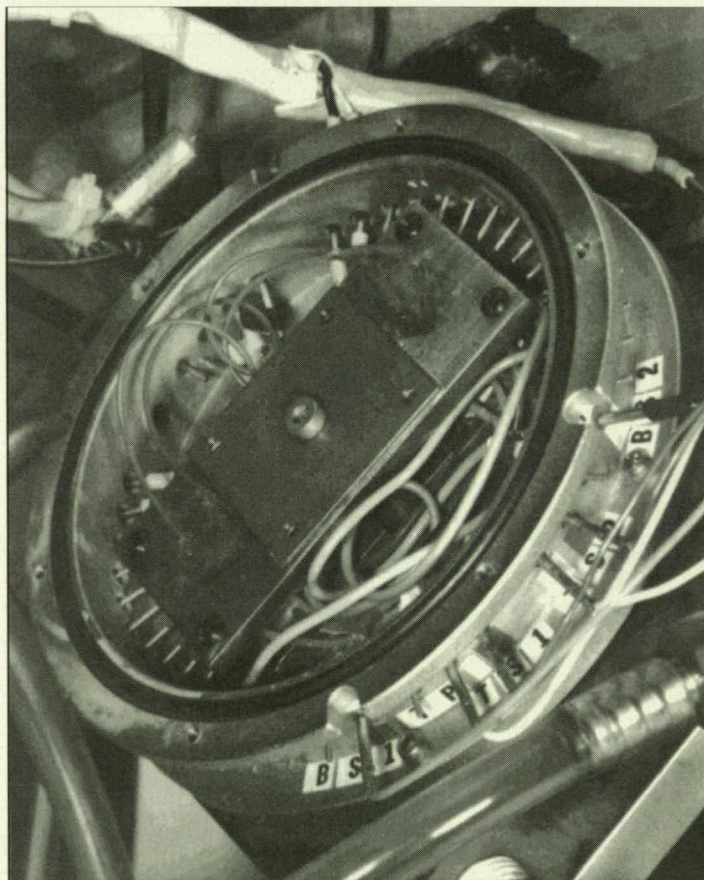

Figure 1. A **Thermoelectrically Cooled Laser-Diode Assembly** is mounted in a vacuum chamber to protect against condensation. The cover of the vacuum chamber has been removed for clarity. The cover includes a 2-in. (5.1-cm) window that transmits the laser light.

plate by a copper subassembly that contains the collimating optics for the laser diode and has sufficient thermal mass for a thermal time constant of several seconds. Cooling is provided by two two-stage thermoelectric stacks assisted by a channel plate through which cooling water is circulated at a temperature of 15 °C. This assembly can cool the diode laser to -40 °C. The other assembly contains a four-stage thermoelectric stack and can cool the laser diode to -65 °C.

In tests, laser diodes with nominal room-temperature wavelengths of 740 nm were shown to be tunable to 724 nm by cooling them to -65 °C. As a byproduct of chilled operation, these lasers exhibited increased efficiency. For example (see Figure 2), the output power of

one laser diode, to constant drive current, increased from 3.75 mW at room temperature to 7.60 mW at -65 °C.

Several advantages are realized by use of the improved thermoelectrically cooled laser-diode assemblies. Not only is the tuning range of any given diode extended to the required shorter wavelengths, but the gaps in the tuning band are smaller at reduced temperature. Because the output power at a given drive current increases with decreasing temperature, one can also take advantage of lower attainable operating temperature to obtain the same output power at lower drive current, thereby increasing the operating lifetime of a laser diode. Yet another advantage of decreasing operating temperature is an increase in spectral purity.

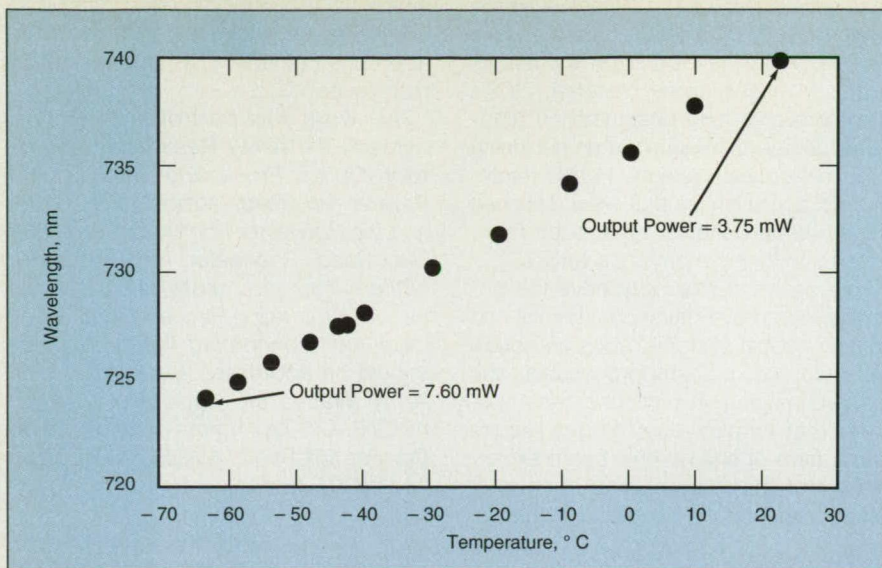

Figure 2. These **Temperature-Tuning Data** were obtained from measurements on a Mitsubishi ML-4405-01 laser diode operating at a drive current of 52 mA. The wavelength and output power vary nearly linearly with temperature, at rates of about 0.18 nm/°C and -44 mW/°C, respectively.

This work was done by Thomas R. Glesne, Geary K. Schwemmer, and Joe Famiglietti of **Goddard Space Flight**

Center. No further documentation is available.
GSC-13622

Diffraction Optics Enhance the Performance of Optical Signal Processors

Surface-relief DOEs reduce the size, weight, and complexity of Army systems.

Army Research Laboratory, Adelphi, Maryland

In an effort to improve the performance of optical signal processors, researchers at the Army Research Laboratory and the Rochester Photonics Corporation have investigated the application of surface-relief diffractive optical elements (DOEs) to the design of acousto-optic (AO) systems. The development of specialized signal processing systems is necessitated by the increasing use of wide-bandwidth signals for radar and communications. Furthermore, AO systems offer many advantages over their electronic counterparts, including low power consumption.

ARL has developed several AO processors that are rugged and lightweight, and have less volume than comparable electronic processors. Additional reductions in processor mass and volume can be realized if bulk optical elements can be replaced by surface-relief DOEs, which can be as thin as 2 μm . In addition, because DOEs can be fabricated using either standard lithographic processes or direct-write techniques, they can produce phase functions that

are difficult or impossible to realize with traditional elements fabricated using grinding and polishing.

As a general result, it was determined that two anamorphic DOEs can be used to replace four bulk refractive elements necessary for the anamorphic beam shaping required by most AO systems. Anamorphic beam expansion is the magnification of an input beam along orthogonal axes with different optical powers. In AO processors, such expansion is necessary to produce the proper beam shape for interaction in an AO Bragg cell. Limitations in traditional fabrication methods require that anamorphic beam expansion be achieved refractively by crossed cylindrical lenses or cascaded prism pairs. But such expansion can also be achieved by using two elliptical Fresnel zone plates in a telescopic arrangement. Rochester Photonics fabricated such elements for use in the ARL systems.

Processing of Doppler radar required an optical system that has a linearly variable magnification along a single axis.

LOOKING FOR PHOTONS ? SWIR • MWIR • LWIR

We Can Help You Find It: From Detector Components to Sub-Assemblies, to Complete Measurement Systems.

Detectors:

Ge•InGaAs•PbS(e)
InAs•InSb•HgCdTe

Electronics:

- Amplifiers
- Controllers

Cooling Systems:

- Thermoelectric
- Joule-Thompson
- Cryostat

Optical Interface:

- IR Fiber
- IR Lenses
- Receptacles



Electro-Optical Systems
1000 Nutt Rd
Phoenixville, Pa 19460
Tel: 610-935-5838
Fax: 610-935-8548

The effect of this system is to transform a square beam to one that is trapezoidal. A telescopic arrangement of two conical lenses can accomplish this refractively. But due to its unusual shape, the fabrication of a refractive conical lens is difficult, and two conical lenses in tandem produce prismatic effects that divert the transformed beam off-axis. Again, by exploiting the fact that DOEs can be fabricated to produce user-defined phase fronts, it was possible to design and fabricate a pair of diffractive conical lenses that met specifications.

Because military systems must operate in harsh environments, the performance of DOEs over wide temperature ranges had to be considered. It was determined

that thermal behavior of diffractive lenses is significantly different than for refractive lenses, which is true even for lenses made from the same material. DOEs therefore give lens designers an additional degree of freedom when designing athermal optical systems. Hybrid refractive-diffractive lenses that were designed for athermal behavior have been fabricated and their performance verified.

The results of this work have the potential to improve many commercial and military optical systems, such as optical data storage, material processing, and infrared imaging. In particular, most systems that employ laser diodes require some form of anamorphic beam expansion, and the thermal performance of plastic and infrared optical systems,

which have historically been difficult to compensate, should benefit from the application of diffractive athermalization techniques.

*This work was part of a joint effort between the **Army Research Laboratory**, Optical Processing Branch, 2800 Powder Mill Road, Adelphi, MD 20783, and the Rochester Photonics Corp., 330 Clay Road, Rochester, NY 14623. For further information **write in 101** on the Reader Information Request Card.*

Inquiries concerning this technology should be addressed to Director, U.S. Army Research Laboratory, Attn: AMSRL-CP-TA (Norma Vaught), 2800 Powder Mill Road, Adelphi, MD 20783-1145; (301) 394-2952. 0

Optoelectronic Attenuator for Microwave Signal Control

A technique for simultaneous control of microwave systems yields high speed and other advantages.

Army Research Laboratory, Adelphi, Maryland

The use of optoelectronic techniques to control microwave circuits and systems is an area of intense research and development. Besides the inherent speed advantages of this approach, use

of a laser to control multiple microwave circuits permits both a high degree of electrical isolation between the control signal and the microwave circuit, and timing precision that can easily be in the

picosecond regime. This is in addition to the inherent noise immunity of optical fibers. For applications where multiple microwave assemblies are to be controlled with precise timing accuracy, this



**Twice the Resolution...
Twice the Optical Quality...**

at the Price of a Quarter-Meter Monochromator

That's right. CVI proclaims a **REVOLUTION** against high prices. Our popular DIGIKRÖM DK480 Monochromator (1/2 Meter focal length) is now offered at the same price as our DK240 (1/4 Meter focal length)*. With industry standard RS232 or IEEE-488 connections for computer controlled slits and either dual or triple grating turrets, this **IS** the Performance/Price Leader in the industry.



- High Quality Optics
- Precision Machining
- Rugged Construction
- Newly-Revised Electronics

We are committed to **CUSTOMER SATISFACTION.**

* Prices are subject to change, so take advantage of this opportunity **today!**

CVI LASER CORPORATION

INSTRUMENTS

200 Dorado Place SE • P. O. Box 11308 • Albuquerque, NM 87192 • (505) 296-9541 • FAX (505) 298-9908

O M A[®] **NEW!**
4

Convenient, Ultra-Sensitive Spectroscopy



Model 1530-A Series
Air-Cooled CCD Detector

Air Cooled Spectroscopy CCD

Convenient because:

- No Water, No LN₂, and No N₂ Purge Gas
- Zero Vacuum Maintenance for Two Years
 - Eliminates Monthly Pump Down
 - True Vacuum
 - Lower Dark Current...Not Compromised by N₂ Back-fill
- ISO 9000 Certified Quality
 - Guarantees Reliable Products

Exclusive Performance Features

- 4-5e⁻ Noise
- Full 18 Bit Dynamic Range
- 333K Spectra/Sec Acquisition
- 1E-15 Watt/cm² Detectability
- VESA Board Compatible
- 20% Q.E. @ 200nm; 43% @ 650nm
- Long Integration Times w/o Water or LN₂
- Variety of CCD Formats & Vendors
- HiDRIS Imaging on 1 K², 512² and 256 x 1024 Chips

Global Support & Service

EG&G Instruments' world-class engineering and manufacturing centers are dedicated and committed to Total Quality. We take pride in the fact that our high quality instruments are used world-wide by the scientific community. We invite you to discuss your specific experiments with our Applications Specialist. EG&G Instruments has more than 50 world-wide offices that can provide the support and service you need. Contact our Princeton Headquarters or your local EG&G Instruments representative to learn more about the latest state-of-the-art scientific instruments.

 **EG&G INSTRUMENTS**
Princeton Applied Research

P.O. Box 2565 • Princeton, NJ 08543-2565 • (609) 530-1000 • Fax: (609) 883-7259

United Kingdom 0734/773003 • Canada (416) 827-2400 • Germany 089/926920 • Japan 03-3638-1506
Benelux - 034-0248777 • Italy 02/27003636 • France 1/69898920

L3908r1b

is perhaps the only available technique.

An optoelectronic attenuator scheme suitable for remotely controlling microwave integrated circuits has been demonstrated. A high-speed photoconductive (PC) switch was fabricated on a silicon substrate using standard photolithographic techniques. By optically illuminating the substrate, one can optically control the amplitude of a microwave signal or signals that propagate through the switch.

Figure 1 is a photograph of the optoelectronic attenuator. A commercially available fiber-pigtailed SDL laser diode was used to optically vary the attenuation of 10-MHz to 3-GHz signals through a silicon coplanar waveguide-photoconductive switch. Using a vector network analyzer (VNA) operating at a power level of -5dBm, the team measured the optically induced variation of both the power reflection from, and the power flow through, the silicon PC switch during optical illumination.

Figure 2 shows the optically induced attenuation for several laser diode power levels; up to 45 dB of attenuation (a reduction in signal strength of greater than a factor of 15,000) at 1.7 GHz was achieved using less than 150 mW of laser diode power. The corresponding reflected power level from the device

Figure 1. An **Optoelectronic Attenuator** showing high-speed photoconductive switch (left) and fiber-pigtailed SDL laser diode. The focusing optics have been removed for illustration.

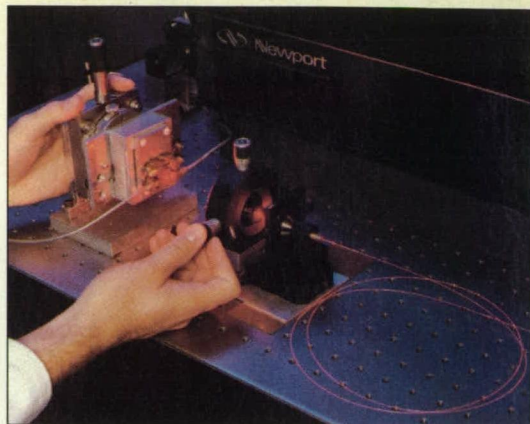

(not shown) decreased, thus indicating that the silicon PC switch had become "better matched" as the optically induced attenuation increased. This is important because there are no unwanted power reflections from the attenuator that could degrade system performance.

For applications such as the remote control of satellite links and radars, as well as high-speed electronic instrumentation, 45 dB of attenuation is adequate to provide functions such as transmitter on/off switching, receiver blanking during transmit, and so on. The team also measured the phase variation in the attenuator, and observed optically induced variations as large as 180° at 3

GHz. This demonstrates an additional application for the optoelectronic attenuator: phased-array radar antenna control, whereby both amplitude tapering of the array power, and phase control for electronic beam steering, might be achieved. For large arrays containing thousands of monolithic microwave integrated circuits (MMICs), this may perhaps be the best way to control so many individual elements simultaneously. Since optoelectronic and MMIC devices are both based on the use of gallium arsenide compound semiconductor technology, development of an all-GaAs-based system is more than feasible, where the optoelectronic atten-

FOR EVERYONE WHO'S NOT INTO HEAVY METAL

THE WEIGHT IS OVER. CARL ZEISS OPTICAL MICRON LASER EYEWEAR COMBINES LIGHTWEIGHT POLYCARBONATE LENSES WITH SPECIALLY ENGINEERED METAL FRAMES TO ASSURE COMFORTABLE PROTECTION.



TITMUS[®]
A Division of Carl Zeiss, Inc.

MICRON. WHERE SAFETY AND COMFORT ARE A PERFECT FIT.
(800) 338-2984

Get the Point!



Photometrics
introduces *ImagePoint*,
scientific imaging at the
TOUCH OF A BUTTON.

The world's first affordable, integrating,
scientific cooled CCD video camera.

Primary Point Digitization (PPD):™ Unlike conventional video cameras, ImagePoint digitizes the image immediately and stores the digital image in the camera. This greatly reduces electronic noise resulting in a clearer, higher quality image and improves the dynamic range of the camera.

Easy to Install and Use: Simply attach ImagePoint to a video monitor, plug in the hand-held controller to select image settings from an on-screen menu and you will be taking images within seconds. You don't even need a computer to begin capturing scientific-quality images. No other camera compares to the cost effective quality of ImagePoint for easy set-up and use.

APPLICATIONS

- Video microscopy
- Fluorescence microscopy
- FISH (Fluorescence *in situ* Hybridization)
- Gel electrophoresis
- Densitometry
- Surveillance
- OEM video camera upgrades
- Low light level imaging



Photometrics

ImagePoint

FEATURES & BENEFITS

- **Primary Point Digitization** — Low noise, scientific/quantitative imaging
- **Hand-held controller** — Control camera settings easily via on-screen menu
- **Compatible with all video equipment** — Easily integrated with your existing video equipment
- **Direct computer interface** — No need for an expensive frame grabber
- **Continuous or still imaging** — Allows for real-time, fast focusing or scientific still-image capture
- **Simplified 4-step start-up** — Simply unpack, plug in hand-held controller, attach a video monitor, power-up and you'll be taking images in seconds!
- **Peltier Cooled CCD** — Virtually eliminates dark current (noise) during longer exposures
- **Variable exposure times** — Allows on-chip integrated exposures up to 40 seconds for extremely low light level imaging
- **Built-in digital contrast enhancement** — Contrast stretching and pseudo-color LUTs permit visual display of faint image details and let you take full advantage of true, 8-bit dynamic range
- **Software Compatible with other Photometrics cameras** — Provides seamless upgrades to higher performance cameras if required and protects software investment

Photometrics

3440 East Britannia Dr. • Tucson, Arizona 85706 • FAX (602) 573-1944 • TEL (602) 889-9933
Worldwide distribution. Contact us for the representative nearest you.

For More Information Write In No. 325

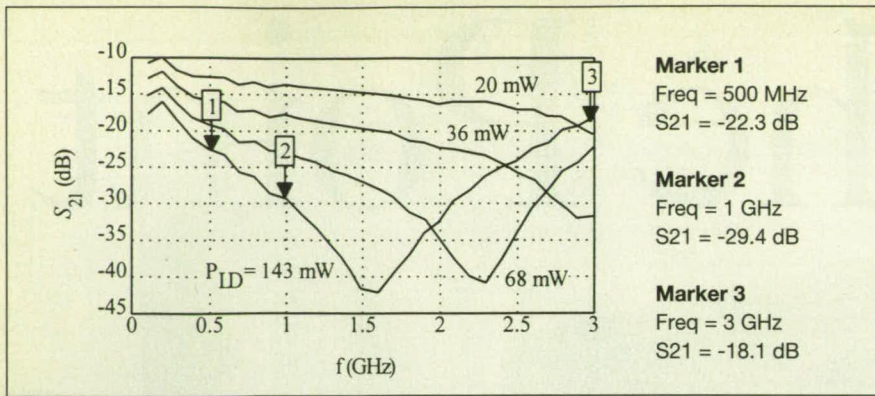

Figure 2. Optoelectronic attenuator performance measured using VNA. Plot shows the **Signal Amplitude versus Microwave Frequency and Laser Diode Power** (indicated on graph). Note greater than 40 dB signal attenuation with less than 150 mW of laser power.

uator would be integrated directly onto the MMIC chip, thus saving system cost while simultaneously achieving performance levels currently unattainable.

This work was performed by Stephen E. Sadow of the **Army Research Laboratory, Weapons Technology Directorate**, 2800 Powder Mill Road, Adelphi, MD, and C.H. Lee of the Department of Electrical Engineering, **University of Maryland**, College Park, MD.

Inquiries concerning this technology should be addressed to Director, U.S. Army Research Laboratory, Attn: AMSRL-CP-TA (Norma Vaught), 2800 Powder Mill Road, Adelphi, MD 20783-1145; (301) 394-2952.

PERFECT OPTICAL ALIGNMENT MADE SIMPLE.



The Lateral Transfer Hollow Retroreflector from PLX is a perfect device for applications such as Boresighting, Beam Alignment and Beam Delivery where critical alignment of one optical axis to another is required.

A monolithic structure, the LTHR is an invariant in all coordinates. It maintains sub-arc second accuracy, even in extreme environments, and eliminates the need for costly, inherently-unstable, mirror mount setups. Front-surface reflection permits maximization over a wide spectral range. Available also as a periscope, and in a multiple configuration for variable distances between the optical axes.

Call PLX today to discuss your application. Ask for a free copy of our technical booklet, "Perfect Optical Alignment Made Simple". PLX Inc., 40 W. Jefryn Blvd., Deer Park, NY 11729, USA. Phone: 516-586-4190. Fax: 516-586-4196.

(International Area Code: 01)
Patents nos. 5024514, 5301067



Optical Heterodyne With Lower Phase Noise

Two lasers would be injection-locked to a third, mode-locked laser.

NASA's Jet Propulsion Laboratory, Pasadena, California

A proposed improvement would enhance the utility of an optical-heterodyne apparatus used to generate a radio signal at a chosen frequency between 1 and 1,000 GHz. Heretofore, the optical heterodyning of the outputs of pairs of independent lasers has produced signals that have contained so much phase noise (that is, phase fluctuations) that they have been unusable in most applications: this is because the outputs of the individual independent lasers contain phase noise and the spectral widths of the beat-frequency outputs cannot be less than those of the lasers. Furthermore, the high-phase-noise beat-frequency outputs have not been phase-coherent with reference signals.

The basic idea of the improved optical heterodyne is to force the phases of the two lasers to be highly correlated by injection-locking each of them to a longitudinal optical mode of a third laser that is, in turn, actively mode-locked to a radio-frequency reference signal. The beat-frequency heterodyne output would

thus contain much less phase noise than it would if it were generated from the outputs of two independent lasers, and it would be phase-coherent with the reference signal. Potential applications for the improved optical-heterodyne concept include phased-array radar, fiber-optic communication systems, fiber-optic stabilized oscillators, and other applications that involve conversions between optical and millimeter-wave signals.

The figure illustrates one version of the proposed improved optical heterodyne. The resonant frequencies of the two injection-locked lasers would be chosen according to the same criterion as that for independent lasers in older optical heterodynes; namely, so that difference between these laser frequencies equals the desired beat (output) frequency. The actively-mode-locked laser used to injection-lock these lasers would be driven by an electronic oscillator at the reference frequency (f_{osc}), which must be a sub-harmonic of the desired output frequency; it must also equal the frequency separation between the longitudinal modes.

The output of the actively-mode-locked laser would be sent through an optical isolator to prevent reflected power from destabilizing it, then split, then coupled into lasers 1 and 2. Frequency-selective tuning elements in the resonant cavity of each of lasers 1 and 2 would select the desired longitudinal optical mode of the actively-mode-locked laser, causing each of lasers 1 and 2 to amplify only one mode of the multimode output spectrum generated by the actively-mode-locked laser.

The outputs of injection-locked lasers 1 and 2 would be combined at a photodetector to obtain the heterodyne signal. Optionally, the output signal could be modulated with a baseband information signal, by linearly modulating the phase of the output signal from laser 1 before combining it with laser 2. The output of the photodetector would include a component at the frequency difference of lasers 1 and 2. This frequency difference could be chosen to be an integral multiple of f_{osc} up to a maximum multiple equal to the number of locked modes. Because of the extremely wide optical bandwidths of laser gain media, it is common for mode-locked lasers to have hundreds of locked modes spanning more than 1,000 GHz. Therefore, it should be possible to generate signals over this wide range of frequencies.

This work was done by Ronald T. Logan of Caltech for NASA's Jet Propulsion Laboratory. For further information, write in 88 on the Reader Information Request Card.

In accordance with Public Law 96-

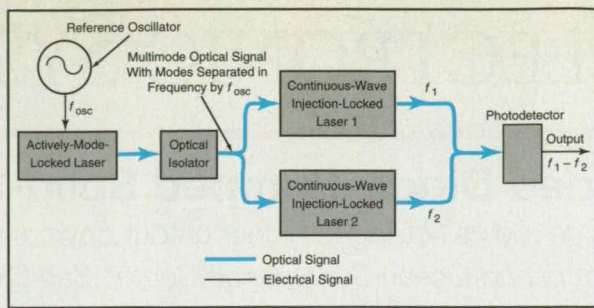

Continuous-Wave, Single-Frequency Lasers 1 and 2 would be injection-locked to different modes of the actively-mode-locked laser, which would, in turn, be mode-locked to the reference oscillator.

517, the contractor has elected to retain title to this invention. Inquiries concerning rights for its commercial use should be addressed to: William T. Callaghan, Manager, Technology Commercializa-

tion, JPL-301-350, 4800 Oak Grove Drive, Pasadena, CA 91109.

Refer to NPO-19199, volume and number of this Laser Tech Briefs issue, and the page number.

Electronic Film Imaging

Are you involved in LASER SCANNING, IMAGE DIGITIZING, X-RAY SCANNING, MICRO-DENSITOMETER RECORDING, PHOTO-TYPESETTING, HIGH-SPEED MICROFILM RETRIEVAL, MEDICAL IMAGING or any of the many forms of electronic imaging?

Mekel Engineering specializes in custom precision film transports... pin-registered or continuous movement, including electromechanical design and hardware to meet your specifications for film handling systems.

Mekel has the answers to processing your information for analysis, storage and retrieval.



Write for free literature on Mekel Capabilities

777 Penarth Ave., Walnut, CA 91789
909-594-5158 FAX 909-594-1216

Internally Folded Diode-Pumped Solid-State Laser

A novel resonator design allows scaling to higher output powers using multiple diode pumps.
Naval Command, Control and Ocean Surveillance Center, San Diego, California

Increasing the output power of longitudinally pumped lasers has been constrained by the power available from single-stripe laser diodes. An internally folded laser (IFL) represents a promising approach to scaling. In this design the gain element contains one or more flat faces from which the resonator mode is reflected or "folded back" into the gain medium at a non-normal angle. In addition to the fold faces, another face of the gain element is orthogonal to the resonator mode and serves as the highly reflective (HR) end mirror. Each fold face can be longitudinally pumped along two axes, where each is coincident with the incident or reflected resonator mode, respectively. These axes are used to supplement the pump power incident on the HR end face of the gain element. Since the pump power along each axis is concentrated in a spatially separate volume, the overall thermal loading is reduced.

The first IFL was demonstrated with an Nd:YAG gain element fabricated in the shape of an isosceles right-angle prism; a second, more efficient IFL contained an Nd:YAG gain element shaped as a penta prism. These elements are illustrated in the figure. The right-angle prism produced 1.3 W when pumped with 3.73 W; the penta prism produced 2.3 W, with an absorbed pump power of 4.16 W, a slope efficiency of 56 percent and an overall optical efficiency of 55 percent. End-pumping provides a "gain aperture" that naturally selects the TEM₀₀ mode. The ability to use both

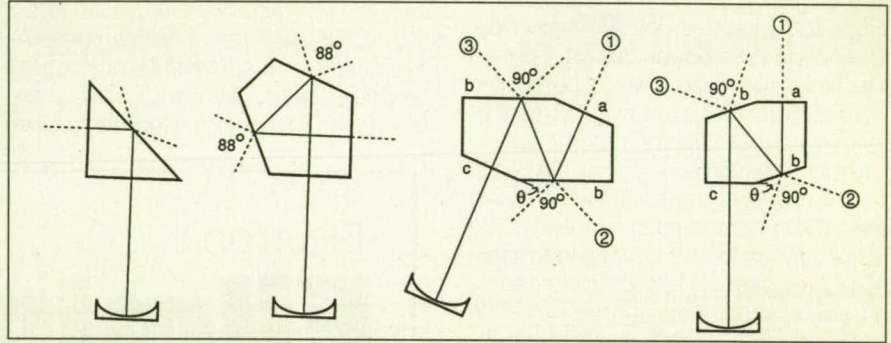

Four Internally Folded Laser Configurations, illustrating the resonator mode and pump

pump axes simultaneously at a given fold face of the penta-prism gain element is facilitated by the relatively large angle (88°) subtended by the two axes.

The orthogonal faces of both the right-angle and penta-prism gain elements were approximately 5 mm X 5 mm. Two additional IFL geometries were developed, both relatively simple to fabricate; these designs are also illustrated. Both Nd:YAG and Nd:YVO₄ gain media were demonstrated. For each crystal a resonator was established using an output mirror with a 10-cm radius of curvature aligned to provide a nearly hemispherical resonator mode.

The threshold power for the Nd:YAG laser was 40 mW. The total absorbed pump power of 3.94 W produced a maximum output power of 2.1 W at 1.06 micrometers with a 0.959-reflectivity output mirror. The slope efficiency was 54 percent and the optical conversion efficiency 53 percent. No indication of

thermal saturation was observed for Nd:YAG up to almost 4 W of pump power. Pumping the Nd:YVO₄ laser with 2.94 W of absorbed power produced 1.33 W of output; the slope efficiency was 47 percent. These designs have the potential for scaling to higher output power by pumping along additional axes. Using polarization combination along each pump axis, up to ten single-stripe laser diodes can be used to pump the gain elements longitudinally.

This work was performed by Richard Scheps of the Electro-Optics Branch, Code 754, of the Naval Command, Control and Ocean Surveillance Center, RDT&E Division. Inquiries concerning rights for the commercial use of this invention should be addressed to Harvey Fendelman, Legal Counsel for Patents, Code 0012, NRO, San Diego, CA 92152; (619) 553-3001.

Low-Cost Photoconductive Transmitter

The compact wide-bandwidth device is suitable for a variety of advanced applications.
Army Research Laboratory, Adelphi, Maryland

The optical generation of high-speed ultrawide-bandwidth (UWB) microwave signals is the subject of intense research. The ability to transmit truly UWB signals has many important applications, such as impulse and spread-spectrum communications, advanced automobile collision avoidance sensors, air traffic control radars, and so on. The ability to both transmit and receive UWB

information not only permits accurate identification of radar targets, but also insures that system performance is maintained in the vicinity of other electromagnetic emitters, such as radio stations, air traffic control radars, etc.

The following scheme generates short-duration electrical pulses, often referred to as ultrawideband, or impulse, technology, by converting DC energy to RF energy. An electrical bias

is applied to a photoconductive (PC) switch that has been placed in a high-speed transmission structure. Closing the PC switch results in the conversion of the DC bias into a fast-risetime electrical waveform (i.e., RF signal).

Free-space transmission of such a short-duration pulse produces an extremely wide frequency spectrum that can approach a few terahertz (THz) in bandwidth. However, the free-

burleigh Wavemeters®

- Fast, continuous wavelength verification without cumbersome calibration procedures – Eliminates dependency on manufacturers' calibration data.

- Ultra precise wavelength measurement for a wide range of applications – Ensures accurate and reproducible results.

- Easy to operate and easy to install – Integrates directly into your experiment.

- Real time measurement with automated data collection – Pulsed wavemeter operates with user's P.C.

Precise Laser Wavelength ...Or Is It?

Real Time Wavelength Monitoring For Pulsed or CW Tunable and Diode Lasers

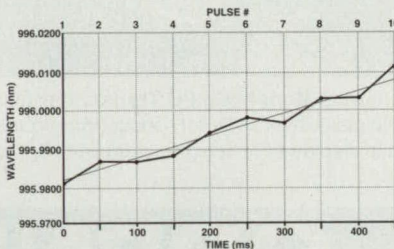
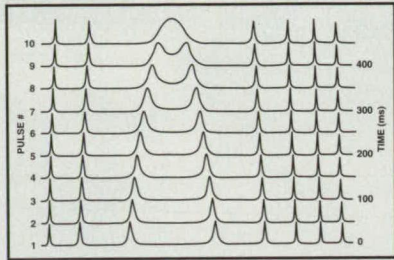

Burleigh Wavemeters® Quickly and Easily Confirm Actual Wavelength for Both Pulsed and CW Lasers

Burleigh UV to Near IR Pulsed Wavemeters

The Burleigh Pulsed Wavemeter

Pulsed Wavemeters

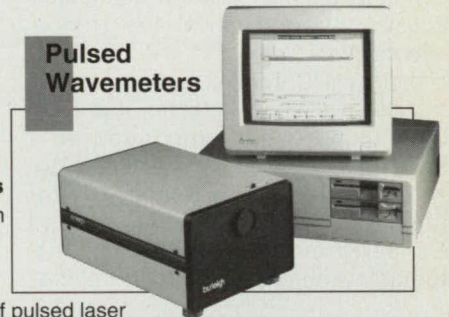

takes the hassle out of pulsed laser wavelength measurements. Simple to align and use, the Pulsed Wavemeter displays accurate ($\pm 0.02 \text{ cm}^{-1}$), continuous wavelength measurements from 190 nm to 680 nm (WA-5500) or 400 nm to 1100 nm (WA-4500) for both pulsed and CW lasers. Easy PC control with Windows® 3.1 permits wavelength data to be displayed in real time or stored for later analysis. Free demo disk available.

Burleigh CW Wavemeters

Burleigh CW Wavemeters are designed to measure the absolute wavelength of narrow bandwidth CW lasers operating between 400 nm and 4.0 μm . The WA-20 Wavemeter incorporates a scanning Michelson Interferometer inside a vacuum chamber to measure vacuum wavelengths to ± 1 part in 10^6 . The WA-10 Wavemeter operates without a vacuum chamber and determines the wavelength with an absolute accuracy of ± 5 parts per million. The operating range of the WA-10 is 400 nm to 1.0 μm .

Burleigh Wavemeter jr

The Wavemeter jr is a compact, very affordable fiber coupled wavelength measurement device. The WA-2000 covers the wavelength region from 400 nm to 1100 nm and the models WA-2100 and WA-2200 extend the wavelength coverage of the Wavemeter jr to 1800 nm. All three models of the Wavemeter jr provide measurements with an accuracy of 1 part in 10,000.

CW Wavemeters



Wavemeter jr



burleigh

Reliable Precision

Burleigh Instruments Inc.

Burleigh Park, Fishers, NY 14453

716/924-9355 • FAX: 716/924-9072

In the U.K.: Burleigh Instruments LTD (0582) 766888
FAX: (0582) 767888

In Europe: Burleigh Instruments GmbH (06157) 3047
FAX: (06157) 7530

Windows is a registered trademark of Microsoft Corporation.

For more information
and/or for a free demo disk
to experience the exclusive
features of the Burleigh
Pulsed Wavemeters call,
fax, or write:

For More Information Write In No. 354

space impulse electromagnetic radiation of THz-bandwidth signals requires optical activation of PC antenna structures by amplified femtosecond laser pulses — a drawback, because it results in a high-cost and large-volume laser system. In addition, these systems typically have low radiated power levels, and atmospheric attenuation further reduces their effective radiated power. For applications such as wireless communications, impulse radar for vehicle collision avoidance, and electronic countermeasures, system cost, effective range, and size are more important factors than THz bandwidths.

A team successfully demonstrated a compact and low-cost wide-bandwidth RF transmitter, with potential sensor applications such as automotive collision avoidance and wireless communications. This PC transmitter consists of an electrical energy storage medium (capacitor), the DC-to-RF converter (PC switch), and the radiating element (spiral antenna) that have been monolithically integrated on a single GaAs substrate. The transmitter was fabricated on a 3-inch, 3-mm-thick Si-GaAs wafer substrate, and Au-Ge/Ni metallizations were patterned using a standard photolitho-

Figure 2 Nd:glass laser experimental data showing **Fourier Spectrum for Transmitter** operating with a charging voltage of ± 600 V. Note Fourier spectrum shows a 450-MHz instantaneous bandwidth centered at 1.25 GHz.

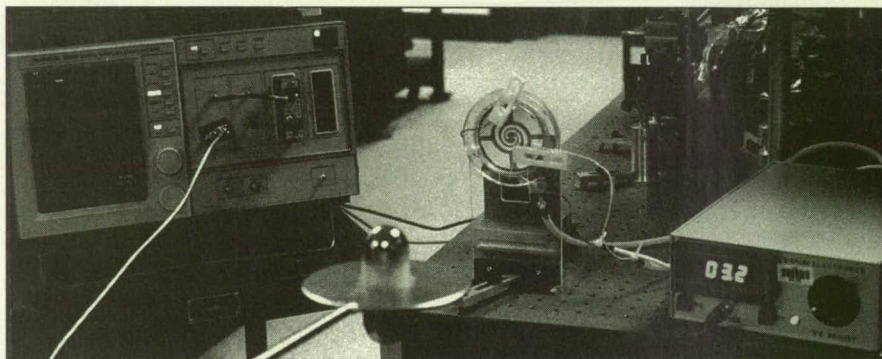
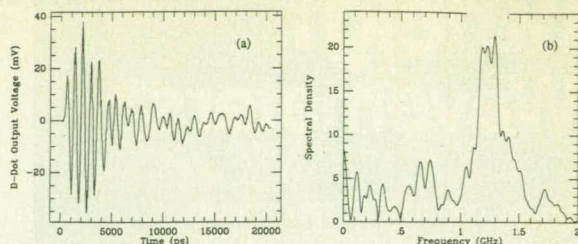

Figure 1. Photograph showing **Monolithic PC Transmitter** (center) being triggered by two optical fibers fed by an Nd:glass laser. A D-dot sensor (foreground) is used to record the transmitted waveform, which is displayed on a high-speed sampling scope (left).

CORNING

Imagine what we can do together

POLARCOR™ Polarizers for the Near-Infrared

CUSTOM POLARIZERS

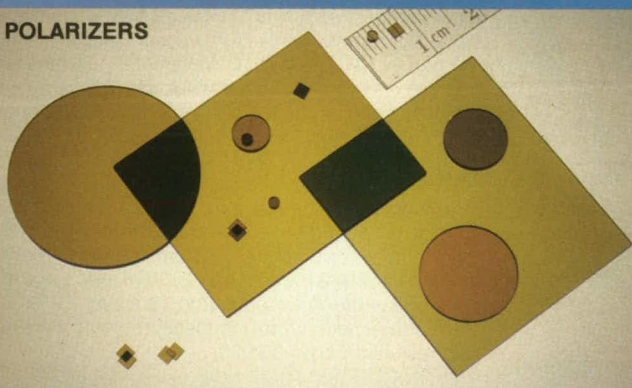

STOCK POLARIZERS

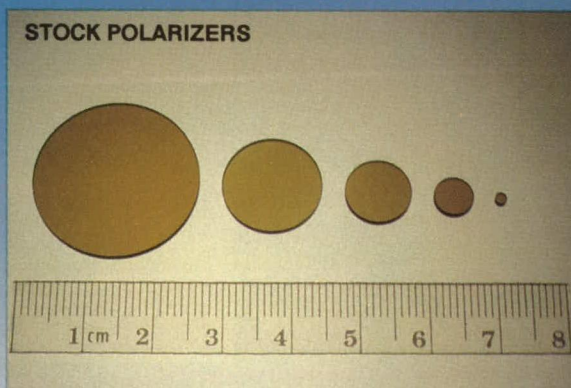

- Polarcor™ glass polarizers offer high performance in the near-infrared.
 - Unique features include:
 - High transmittance
 - Compact design
 - 400°C temperature use
 - Large acceptance angles
 - Custom shapes can be designed in 2-30mm diagonals.
- For More Information Write In No.312**

- Stock polarizers are available for immediate delivery.
- Stocked in sizes: 6-25mm diameters and 2mm x 2mm x 0.5mm (1300 and 1550nm)
- Polarizers are optimized for applications in the 740-1580nm range
- Three performance levels designed to meet diverse applications
 - Standard contrast (>500:1)
 - Enhanced contrast (>1000:1)
 - High contrast (>10,000:1)

Contact: 607-974-7966 for Service • 607-974-7470 for Sales • 607-974-7626 for Engineering

graphic metal liftoff process. Rather than simply feeding the antenna at the center, the pulse-biased energy — stored in the transmitter's electrodes — is directly converted to radiated RF energy upon closure of the photoconductive switch to electrical ground.

Figure 1 shows the experimental configuration; 10-ps optical pulses from a Nd:glass laser are delivered to the transmitter's PC switches using two fiber optic cables (center of photo, laser not in view). The energy storage elements are charged using the charging pulser shown in the lower right-hand corner. Upon arrival of the optical pulses, the stored DC energy is converted to RF energy, which is radiated by the spiral arm antenna. A voltage probe (foreground) picks up the radiated RF energy, which is then displayed on a high-speed sampling oscilloscope (left). The team measured an instantaneous bandwidth of greater than 1 GHz, with a fairly uniform spectral density of about 450 MHz centered at 1.25 GHz, using a mode-locked Nd:glass laser with pulses with < 1 nJ of energy at a 500-Hz repetition rate (Figure 2).

This compact wide-bandwidth transmitter is suitable for various applications such as wireless impulse communications, radar sensors, and electronic countermeasures. Future work includes (1) optimizing the transmitter performance by making improvements to the spiral arm antenna pattern to increase the radiated bandwidth, and (2) new techniques for increasing the radiation efficiency, such as employing photonic crystals to increase the radiation efficiency. A compact laser driver has been developed (mode-locked diode-pumped Nd:YLF laser) that greatly improves the PC transmitter, in terms of overall system performance, complexity, and cost. It is now possible to perform PC transmitter demonstration experiments in the field for any of the aforementioned applications.

This work was performed by Anderson Kim and Stephen Sadow, both of the **Army Research Laboratory**, and Chi H. Lee of the Department of Electrical Engineering, **University of Maryland**, College Park. The project was directed by Louis J. Jasper Jr., also of the Army Research Laboratory.

Inquiries concerning this technology should be addressed to Director, U.S. Army Research Laboratory, Attn: AMSRL-CP-TA (Norma Vaught), 2800 Powder Mill Rd., Adelphi, MD 20783-1145; (301) 394-2952.

Video Event Trigger

Only frames that show motion would be recorded.
Lewis Research Center, Cleveland, Ohio

The video event trigger (VET) processes video image data to generate a trigger signal when the image shows a significant change like motion or the appearance, disappearance, change in color, change in brightness, or dilation of an object. This system aids in the efficient utilization of image-data-storage and image-data-processing equipment in applications in which many video frames show no changes and it would

be wasteful to record and analyze all frames when only the relatively few frames that show changes are of interest. Examples of such applications include video recording of automobile crash tests (in which only the last fractions of a second are of interest) and automated video monitoring of entrances, exits, parking lots, and secure areas.

Designed to detect onset of motion

A laser diode OEM system that will fit your application ...

Modulation Solutions
Improved signal to noise ratio & AC coupling.
Beam identification in robotics & positioning systems.

Optical Solutions
Beam correction-circular, collimated, & non-astigmatic.
Wide range of line generation & focusing lens options.

Mechanical Solutions
Sub-Miniature system for limited space applications.
Separated topology for design & operational flexibility.

... and your pocketbook.



New! 16 page product guide.

Send for your free copy today!



Power Technology Incorporated

Address correspondence to: Box 191117 Little Rock, Arkansas 72219-1117 501-568-1995
Plant location 7925 Mabelvale Cutoff Mabelvale, Arkansas 72103 Fax 501-568-1994

within less than 5 ms after a new video frame becomes available from a digitizer, the VET supports acquisition and storage of many seconds of video frames when coupled with high-density frame-store memory capable of repeatedly reusing memory space that contains uninteresting video frames. With pretrigger and posttrigger capabilities, such memory could store an entire sequence of images, including all the subtle details and changes visible just before the main event.

The VET (see figure) uses a computer frame grabber, which acquires video frames from a video camera by use of standard circuits. Software and hardware in the computer control the acquisition process in such a way as to present video frames sequentially to the VET logic control circuitry, where they are captured and stored in k temporary memory buffers (typically, k would equal 5). Buffer k holds the oldest frame, buffer $k - 1$ the next oldest frame, and so on, with buffer 1 holding the newly acquired frame; processing would then involve comparison of the newly acquired frame with the others.

During initialization of the system, the first few frames are assumed to show no motion and are stored, one by one, in the k buffers, to be used as "learned"

The Video Event Trigger includes an event processor that compares the most recent video frame with $k - 1$ frames received previously. Upon detecting a significant change in the video image, the event processor issues a trigger signal, which would command other equipment to store and process the changing image.

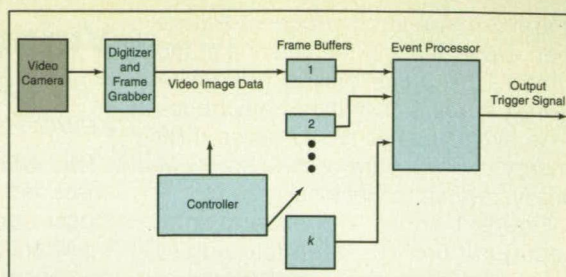

reference frames. "Learning" in this case means loading up the frame-buffer memories, one of which can be loaded every frame time.

There are two alternative methods of storing and comparing old and new video frames. In the first method, each new video frame is compared against a set of $k - 1$ older frames via subtraction and fuzzy-logic rules. If no motion is detected, the oldest of the k stored frames is discarded by rearranging pointers to the video frames. Effectively, all the frames are shifted down, and the newest frame is assigned to the first of the reordered k buffers. Then the next frame is acquired and the cycle repeated. This method offers the advantage of insensitivity to very slow changes in the video scene, similar to insensitivity to slow dc drift in a one-dimensional analog signal. Only significant changes in the latest video frame are sufficient to set off a trig-

ger. This is analogous in function to ac coupling.

In the second method, only the first of the k stored reference frames is ever updated. Each new video frame loaded into buffer 1 is discarded immediately after use. The remaining $k - 1$ stored frames are permanent, unchanging reference frames. This method is most useful in applications in which the interesting changes in the images could be fast or slow. In such an application, any changes would be important to the motion-detection process, and are reported when a specified threshold was exceeded. This is analogous in function to dc coupling.

This work was done by Glenn L. Williams and Michael J. Lichter of Lewis Research Center. For further information, write in 12 on the Reader Information Request Card. LEW-15076

OPTICAL ENGINEERING SERVICES

ORA is a unique group of optical system designers and engineers that is large enough to have the appropriate talent available when you need it and small enough to provide personal service.

We provide optical design and

engineering services to over 500 clients and have completed over 2700 optical projects since 1963. We always welcome the opportunity to be on your engineering team.

Please write or call for a copy of our engineering or CODE V™ brochure.

Government

Commercial/Industrial

Consumer

B.M.D. Systems	Anamorphic Projection Lenses	Audio-Compact Disc Players
Head Up Displays*	Medical Optics	Riflescopes
Laser Fusion Systems	Robotic Vision Optics	Binoculars
LLL TV/Night Vision	Microelectronic Printing	Digital Displays
Simulators	Simulator Optics	Plastic Lens Systems
FLIR Systems	Laser Scanners*	Cost Reduction Studies
Star Trackers	Optical Data Processors	Afocal Optics
IR Missile Sensors	Fourier Transform Lenses	TV Projection Lenses
Space Borne Optics	Laser Printers*	Microscopes
Aerial Reconnaissance Systems	TV/CRT Projection Optics	Single Lens Reflex Zoom Lenses
Spectrophotometers	Hybrid Holographic Systems	TV Camera Zoom Lenses

*Holographic and Classical

Optical Research Associates

550 N. Rosemead Blvd., Pasadena, CA 91107-2193 (818) 795-9101 FAX: (818) 795-9102 Telex: 75-2941 ORA PSD
 East Coast Office: 945 Concord Street, Framingham, MA 01701-4613 (508) 872-6001 FAX: (508) 879-0698 Telex: 94-8477 HQ FMH

Monolithic Optical-to-Electronic Receiver

This gallium arsenide integrated circuit is designed for control and data-transfer applications.

Lewis Research Center, Cleveland, Ohio

A monolithic optoelectronic integrated circuit converts multiplexed digital optical signals into electrical signals, separates them, and distributes them to their intended destinations. The circuit was developed to deliver phase and amplitude commands to the monolithic microwave integrated circuits (MMIC's) at the elements of a millimeter-wave phased-array antenna from a single optical fiber driven by an external array controller. The monolithic optical receiver is also used in the distribution of high-data-rate optical communications in local-area networks (LAN's). Distribution of digital signals in aircraft, automobiles, and ships is a potential application.

The integrated circuit (see figure) is a mass-producible, highly compact gallium arsenide chip. It includes an integral photodetector that receives at a wavelength of about 0.8 μm . The circuit chip also contains a low-noise amplifier, a data-decoder/clock-signal-recovery section, and a 1:8 demultiplexer/driver that accommodate data rates of 10 to 400 MHz. The clock-signal-recovery circuit requires little or no preamble for synchronization; therefore, it can accept data signals in either continuous or burst mode.

In the phased-array application, monolithic optical receivers like this one are spaced among the antenna elements, one chip for every eight elements. The array

controller provides optical data and clock signals to each chip, which detects the optical signal and amplifies the resulting electrical signals. In each chip, the signals are decoded and separated into data and clock signals; then the data are synchronously clocked into the demultiplexer. Finally, the demultiplexed data signals are shifted to the voltage levels required by the MMIC's at the antenna elements.

Without the monolithic optical receiver, it would be virtually impossible to distribute the MMIC control signals without compromising the radio-frequency performance of the antenna because of the space required for multiple MMIC control lines. The use of this receiver also minimizes electromagnetic interference because the antenna commands are transmitted optically.

Some notable features of the design include options for optical or electrical clock

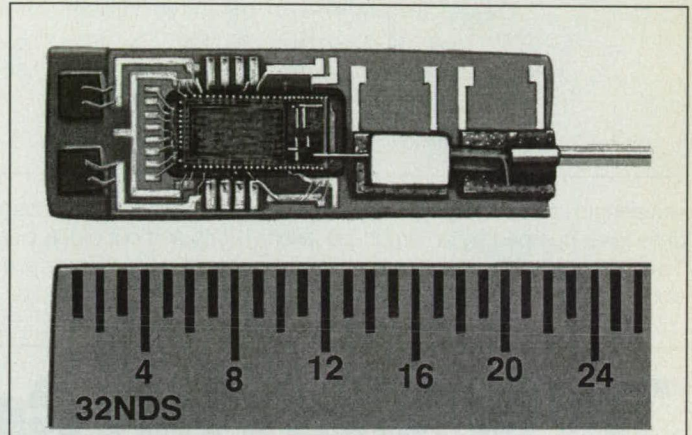

The **Monolithic Optical Receiver** fits in an 18- by 5.5-mm package with a connectorized multimode optical fiber.

inputs; outputs for raw data, addresses, and instructions for diagnosis; and an optical-signal-detection circuit that can be used to reduce power consumption by 80 percent between data-transmission times. The chip can be fabricated by processes available at many major semiconductor foundries.

This work was done by Richard Kunath of Lewis Research Center and Ross MacTaggart of Honeywell, Inc. For further information, write in 104 on the Reader Information Request Card. LEW-15783

Fiber-Optic Terahertz Data-Communication Networks

Network protocols would be implemented in the optical domain.

NASA's Jet Propulsion Laboratory, Pasadena, California

Fiber-optic data-communication networks of a proposed type would utilize fully the available bandwidth (about 10 THz) of single-mode optical fibers. A local-area network designed according to this concept would offer full crossbar functionality, security of data in transit through the network, and capacity about 100 times that of a typical fiber-optic local-area network in current use.

Current fiber-optic local-area networks underutilize the available optical bandwidth: their speeds are limited by the switching times of the optoelectronic devices at the optical/electronic interfaces and by the processing delays associated with the electronic implementation of multiple-access and multiplexing protocols. In the proposed method of overcoming these limitations, most or all of the network protocols would be implemented in

Figure 1. This **Fiber-Optic-Ring Laser System** would generate subpicosecond pulses for use in a terahertz fiber-optic communication network.

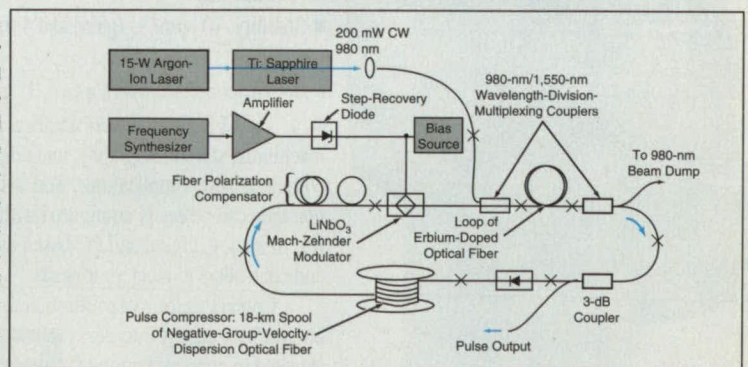

the optical domain.

The two key features of this method are the use of subpicosecond laser pulses as the carrier signals and the spectral phase modulation of the pulses for optical implementation of code-division multiple access as the multiplexing network protocol.

The source of the carrier pulses would be the ring laser system shown schematically in Figure 1. The gain section of the ring laser would be an erbium-doped optical fiber 0.8 m long with a core of 3.5- μm diameter. The gain section would be pumped with 200 mW of radiation at a

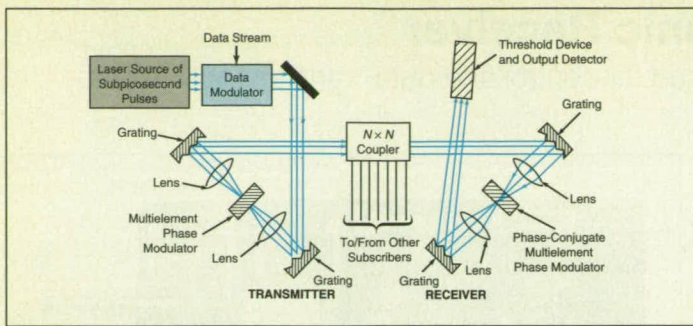

Figure 2. **Code-Division Multiple Access** with the security of spread-spectrum transmission would be accomplished by spectral phase encoding instead of temporal encoding.

wavelength of 980 nm from a titanium:sapphire laser pumped by an argon-ion laser. Two 980-nm/1,550-nm wavelength-division-multiplexing couplers would be used

to couple and decouple the pump beam into and out of the loop. An optical isolator with >60 dB suppression and 0.6 dB insertion loss would be included in the loop

to maintain unidirectional circulation of pulses. A LiNbO₃ integrated-optic Mach-Zehnder modulator with 3-GHz bandwidth, 30-dB contrast ratio, and 5-dB insertion loss would modulate the laser-cavity (ring) loss for active mode locking.

A step-recovery diode, driven by a frequency synthesizer, would generate 12-V-peak, 120-ps pulses at various repetition rates to drive the modulator. Optical power would be coupled out of the cavity by a 1:1 fused fiber-optic splitter. A 2-km spool of standard telecommunication single-mode optical fiber with 18 ps/nm/km dispersion would also be incorporated into the ring to ensure negative group-velocity dispersion and, thus, soliton pulse shaping.

In the code-division multiple-access scheme, each pulse would be decomposed into its spectral components (e.g., by diffraction gratings, in the example of Figure 2); then coding would be introduced in the form of phase shifts between spectral components by use of a multielement quartz phase modulator configured as a binary-coded optical phase plate at a Fourier plane. After encoding, symmetric dispersing optics would reassemble the spread-out beam back to a single coded pulse, which would then be transmitted through the fiber-optic network. At the receiving end, the same process would be implemented, except that a conjugate phase plate would be used to decode the pulse selectively from the background.

In this scheme, multiplexing would be achieved by use of code sequences that interfere minimally with each other (e.g., orthogonal or pseudonoise codes). Each such code could be decoded uniquely at the receiver, despite interference from simultaneous transmissions in other channels. The encoding process would map each narrow-band input signal into a redundant, wide-band signal that would be inherently secure and resistant to jamming. Another advantage of this scheme is that no coordination or synchronization among users would be necessary: the scheme would provide for asynchronous, simultaneous access by multiple users.

This work was done by Peter L. Chua, James L. Lambert, John M. Morookian, and Larry A. Bergman of Caltech for NASA's Jet Propulsion Laboratory. For further information, write in 83 on the Reader Request Card.

In accordance with Public Law 96-517, the contractor has elected to retain title to this invention. Inquiries concerning rights for its commercial use should be addressed to: William T. Callaghan; Manager, Technology Commercialization; JPL-301-350; 4800 Oak Grove Drive; Pasadena, CA 91109 Refer to NPO-18898, volume and number of this Laser Tech Briefs issue, and the page number.

THE M SERIES HAS GREAT MAGNETIC ATTRACTION.

Introducing The New M Series: A Family of Moving Magnet Optical Scanners

Design Engineers and Product Managers alike are finding themselves very attracted to our new scanner technology.

The patented compact M Series scanners have a standard indexable servo mount for ease of alignment. Their precision-machined solid magnet rotor provides the highest flexural rigidity and rotational accuracy of any device available. The stationary drive coil, embedded in a high thermal conductivity medium, allows highest torque without burnout.

- Advanced SMT-based position detector
- Linearity: 99.95% over 60° optical
- Repeatability: 1-2 μrad
- Stability: 10 ppm/°C (gain) and 4 μrad/°C (offset)
- Step response: <2 ms (5 g-cm², 1° mechanical)

The M Series scanners are ideal in micro-machining, stereolithography, imaging and communications applications. You will find that they can be easily configured with our full line of analog, digital and PC-based drivers and controllers to meet your needs.

Contact us for more information and find out just how easy it is to get attached to our new family of moving magnet scanners.



500 Arsenal Street, Watertown, MA 02172 Tel: (617) 924-1010 Fax: (617) 924-7250

Worldwide Locations: Banbury, England Tel: 44-295-270440 Paris, France Tel: 33-1-30-57-1915
Planegg, Germany Tel: 49-89-85-95031 Milan Italy Tel: 39-39-2025387 Tokyo, Japan Tel: 81-33-760-5510

Multiple Pages Intentionally Left
Blank

Reliability Program (SHARP), is investigating methods of converting electrical control signals to optical signals to drive an opto-hydraulic interface, which will convert optical energy to thermal energy, within specified electronic packaging and environmental constraints. The technology for purely electronic components to operate within this environment is well established; the challenge is to accomplish the same for electro-optics.

In this application, heat is used to produce a pressure differential within a fluid, and when this mechanism is amplified it can move an actuator (see Figure 1). Because of their size, efficiency and ease of modulation, semiconductor lasers are frequently used in fiber optic links. However, in this application there is no straightforward design. Commercial laser diode applications generally do not require elevated temperature operation, nor must they fit into a standardized military package. Active cooling of the diode is necessary for a commercially available semiconductor laser to operate in the extreme ranges of military environmental standards. All available actively cooled devices are too large to fit the specified E-format Standard Electronic Module (SEM) profile.

After exhaustive searches, Navy engineers at Crane identified an experimental

Figure 2. Optical Output Power vs. Laser Current for a commercial laser diode demonstrates a high increase in threshold current as operating temperature is increased.

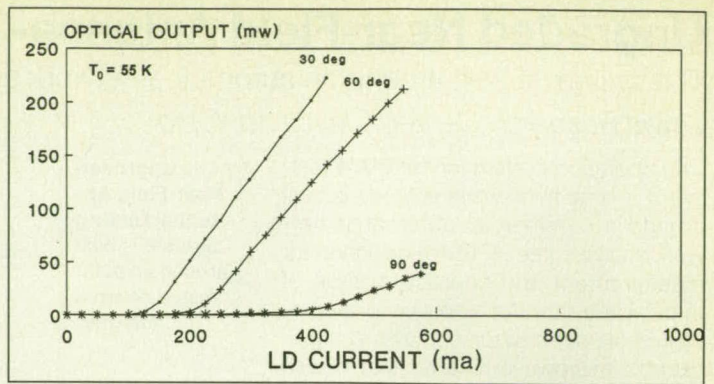
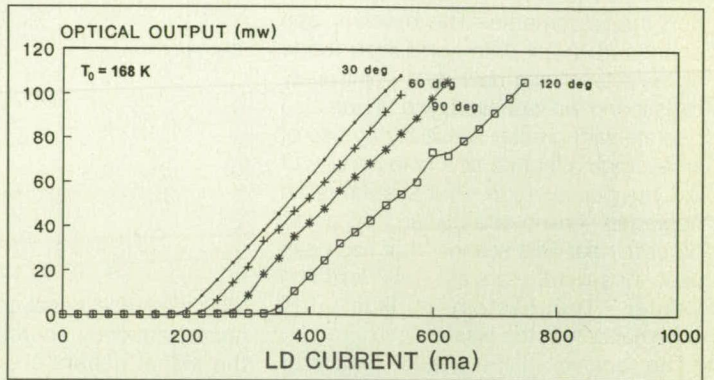

Figure 3. Optical Output Power vs. Laser Current test for experimental laser die demonstrates significantly less increase in threshold current.



laser die fabricated by Spectra Diode Labs (SDL) that was designed to operate within the environmental requirements without an active cooling capability. The die uses an aluminum gallium arsenide

(AlGaAs) material system and operates at a wavelength of ≈ 805 nm. The lasers were delivered in a low-profile, fiber-pig-tail package developed for a different application. They produce 100 mW mea-

High Efficiency IR to Visible Conversion

YAG Turkey

Yaglass

Photo Turkey-1

Photo Turkey-1 is an efficient infrared to visible upgrade converter for fiber optic communications. This IR sensing card is able to convert near infrared beams at $0.8\mu\text{m}$, $0.98\mu\text{m}$ or $1.53\mu\text{m}$ emitted from LD into green light ($0.55\mu\text{m}$) with an efficiency over 30 times greater than that of commercially available IR sensing cards.

YAG Turkey is an infrared sensing card equipped with a 42mm diameter ceramic phosphor used for detecting and positioning a 1064nm Nd: YAG laser beam. The YAG Turkey features high damage threshold of 30 W/mm^2 , along with sensitivity of 3 mW/mm², making it perfect for infrared detection at 900-1070nm. Operation based on infrared to-visible-upgrade conversion eliminates the need for pre-irradiation with ultraviolet light.

YAGGLASS is an IR checker/detector glass that can efficiently convert infrared beams, such as a YAG laser beam into visible light. Since it is made of transparent crystalized glass, it is suited for observation of beam modes, changes in quantity of light and three-dimensional observation of optical path of YAG lasers.

Specifications:

- Detecting section : 30 x 30 x 3 mm
- Detected wavelength range : 0.9-1,07 μm
- Sensitivity : 15 mW/mm²
- (at 1.06 μm in a dark room)
- Damage threshold : 110 W/mm² (during use with a continuous wave)
- Emission wavelengths : 0.55 μm , 0.66 μm

SUMITA OPTICAL GLASS, INC.

Main Factory: 4-7-25 Harigaya, Urawa-city, Saitama, 338 JAPAN
 Phone :048-832-3165 Fax : 048-824-0734

sured optical output power. Crane's Photonics Department procured four of the experimental diodes for testing. Although the laser diodes were experimental devices in development for high-temperature operation, no screening for performance or extensive burn-in or life test was performed prior to the Crane evaluation.

Test results must be viewed as mixed. The outlined test plan consisted of four phases:

- a. Measurement of output power vs. laser current at 30, 60, 90 and 120 °C.
- b. Thermal stress testing at 60, 75, 90, 105 and 120 degrees °C.
- c. Accelerated life tests at constant 100 mW optical output.
- d. Where required, failure analysis.

Although three of the four laser diodes failed during the tests, failure analysis conducted indicates that the failures of two of the diodes were the result of packaging problems. The fourth diode operated for 4200 hours, and appears to indicate that it is possible to fabricate AlGaAs semiconductor lasers that will survive and perform in this stressful environment. This conclusion is supported by tests performed on multiple unpackaged similar laser diodes at SDL, which show nearly flat degradation slopes out to 1000 hours at 120 °C — the best life-times reported for AlGaAs devices.

The output power vs. current tests were designed to measure laser performance at various elevated temperatures. As the test temperature was increased, the experimental lasers exhibited less increase in threshold current when compared to a 'standard' off-the-shelf device. The change in threshold current with increasing temperature can be quantified by a parameter T_0 (characteristic temperature). Higher values of T_0 have been shown to correspond to longer life lasers. The T_0 value calculated for the off-the-shelf laser was 55K (Figure 2) while values for the test devices ranged from 130K to 180K (Figure 3).

During stress testing the devices were operated at rated output power for a minimum of 24 hours, at each of the specified temperatures, to uncover any packaging defects. Two of the SDL devices became unstable and their output decreased dramatically at 75 °C; further testing was unfeasible. The other two laser diodes successfully completed the stress cycle. The SDL packages were fabricated as experimental samples, without detailed engineering effort for optimum high-temperature performance.

Accelerated life tests were conducted with the laser current adjusted to provide constant 100-mW optical output. The

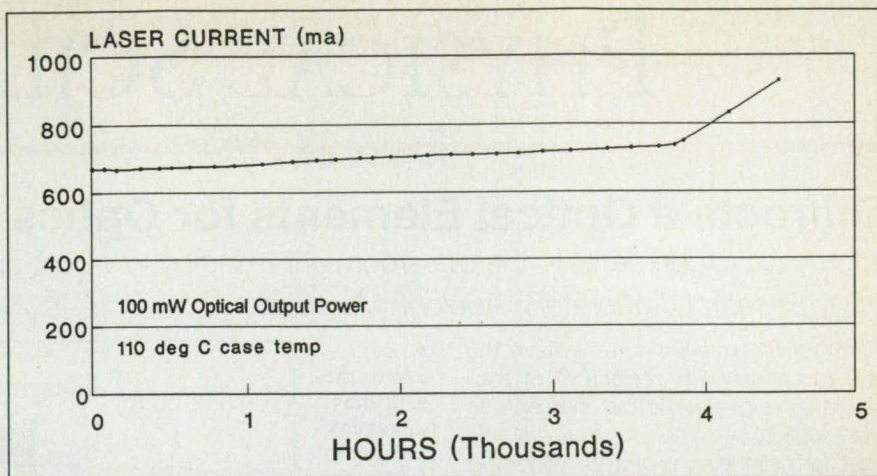

Figure 4. Accelerated Life Test results for remaining laser.

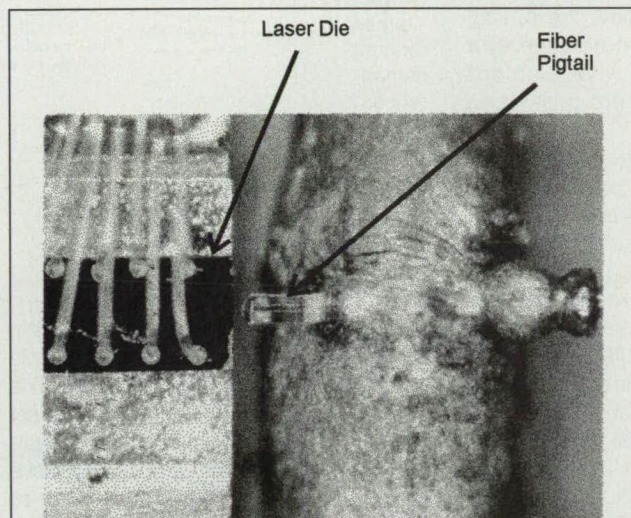

Figure 5. Photo taken during Failure Analysis.

test temperature (measured at the device case) was 125 °C based on the SEM specification. At this temperature, one diode failed after only 300 hours. The other laser demonstrated a degradation, in that the current necessary to maintain the specified output had increased beyond anticipated levels, and there was concern of inducing an outside (invalid) failure mechanism at the higher temperature. At this point, the test temperature was reduced to 110 °C for the remaining laser device, which corresponds to SDL's testing parameters. Under these conditions the laser operated for 4200 hours before failing (see Figure 4). This corresponds to a life of approximately 12,000 hours at the anticipated maximum module temperature of 85 °C.

Failure analysis was conducted on the two devices that failed during stress screening. Each of these failures has been determined to be the result of relative movement of the fiber pigtail to the laser output facet (Figure 5). It should be noted that the diode packages tested were designed by SDL for a totally separate application in a less severe temperature environment. There was no apparent failure of the laser die itself in these

cases. Crane's engineers concluded that the failures of the other two die were the result of normal laser failure mechanisms.

The relatively long life achieved by the one device demonstrates that, with appropriate packaging changes, the problems anticipated when operated at higher temperatures can be overcome in qualifying AlGaAs semiconductor lasers for a severe environment. Crane engineers are evaluating four additional SDL lasers. These devices are just laser chips mounted on a heat sink so packaging problems will not be encountered during the evaluation. Although these devices are targeted for another project, the Crane test team will gather data to validate the results and conclusions of this study. The schedule anticipates testing through FY95 and a report should be available by September 1995.

This work was done by Al Burckle of the Photonics Laboratory, Naval Surface Warfare Center, Crane Division, Crane, Indiana. Assistance was provided by Michael O'Leary of Systems Design and Analysis, Inc., Indianapolis, Indiana. For further information phone 1-812-854-3741.

Diffractive Optical Elements for Optics Education

Interactive experiments in the classroom are aided by low-cost diffractive component kits.
Army Research Laboratory, Adelphi, Maryland

Diffractive optical elements have the ability to enhance or replace more conventional refractive optical elements in many optical systems. Unfortunately, the cost for producing prototype diffractive elements generally remains high. Low-cost methods for producing these elements, however, can allow the optical designer to test the performance of a newly designed diffractive element before proceeding to more costly and precise elements.

Several investigators have pointed out that high-resolution laser printers can be used to produce binary-amplitude diffractive elements with relative ease and very low cost. When diffraction efficiency is not critical, the binary amplitude device serves as an excellent prototype. At ARL a team has exploited this known technique to test a variety of components including lenslet arrays and off-axis focused array generators for optical information processing.

The team has also found that the method can be used to perform in-class demonstrations for use in optics education. The key is to exploit a simple method for viewing far-field diffraction patterns. The method is illustrated in the figure. The student holds a fine-feature binary amplitude element up to the eye and looks through the element at a distant narrowband point source. The pattern incident on the retina is the far-field or Fraunhofer diffraction pattern of the element. This is an old but underused idea described in a variety of introductory optics texts.

A point source projects the diffraction pattern of the **Binary-Amplitude Diffractive Element** onto the human retina.

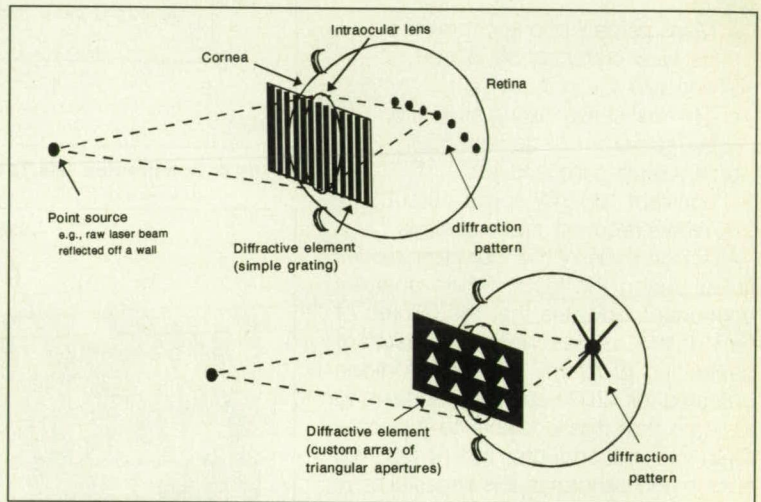

In the past, texts suggested that the viewer hold up objects such as simple gratings or pinholes made in tin foil. The advent of laser-printer-generated binary elements allows the instructor to create virtually arbitrary binary amplitude masks in large numbers and distribute them to the entire class. The best point source is a spot made by a laser beam directed at a white wall or a projection screen.

The ARL group has generated kits consisting of a variety of binary amplitude patterns including simple gratings, two pinhole pairs, circular apertures, ring apertures, and square apertures. The kits can be used to display diffraction and also to explain a number of phenomena such as chromatic dispersion, Young's fringes, the concept of a point spread function, and Rayleigh resolution (use elements such as circles or annuli

and view two point sources). Another experiment involves having the student determine the feature size of an element by estimating the angular extent of the diffraction pattern.

The technique has the potential to enhance the science and optics curriculum at a variety of educational levels. The main appeal is that the instructor can produce his own elements with limited resources.

*This work was done by Dr. Joseph van der Gracht of the **Army Research Laboratory, Adelphi, MD 20783.** Inquiries concerning this technology should be addressed to Director, U.S. Army Research Laboratory, Attn: AMSRL-CP-TA (Norma Vaught), 2800 Powder Mill Rd., Adelphi, MD 20783-1145; (301) 394-2952.*

Corrective Optics for Camera on Telescope

Tilted aspherical, circularly symmetric mirrors correct for aberrations and provide an unobscured aperture.

NASA's Jet Propulsion Laboratory, Pasadena, California

An assembly of tilted, aspherical, circularly symmetric mirrors has been proposed as a corrective optical subsystem for a camera mounted on a telescope that exhibits both large spherical wave-front error and inherent off-axis astigmatism. This subsystem would provide an unobscured camera aperture and diffraction-limited camera per-

formance, despite the large telescope aberrations.

The generic configuration and specific original designs of the assembly were conceived for a camera that is to be mounted in the Hubble Space Telescope to correct for its widely publicized manufacturing error; however, the generic configuration could be applied

in other optical systems in which aberrations are deliberately introduced into telescopes and are then corrected in the associated cameras. Thus, the concept of this corrective optical subsystem provides the designer with additional degrees of freedom that can be used to optimize an optical system.

In addition to an unobscured aperture,

If a picture is worth a thousand words ...

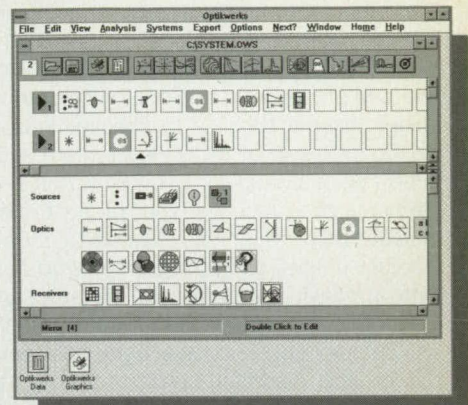

Optikwerks writes the book on object oriented laser & optical system design.

Optikwerks®

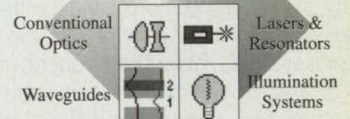

MTF * Lens Catalog Databases * Complex ABCD * Toroids * Ghost Analysis * Mirrors * Laser Beam Propagation * Object Oriented Graphical User Interface * ISO 10110 Element Drawings * AutoCAD export * Sensitivity Analysis * Laser Diodes * Optimization * Prisms * Radiometry * Thermal Analysis * Interferometric Surfaces * Extensive Graphics * Ray

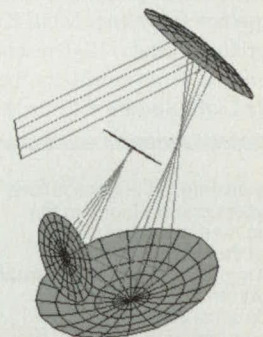

25 MM

716 321-1821

©1994 Optikwerk, Inc. Optikwerks is a registered trademark of Optikwerk, Inc.

Optikwerk Fax 716.321.1809

For More Information Write In No. 313

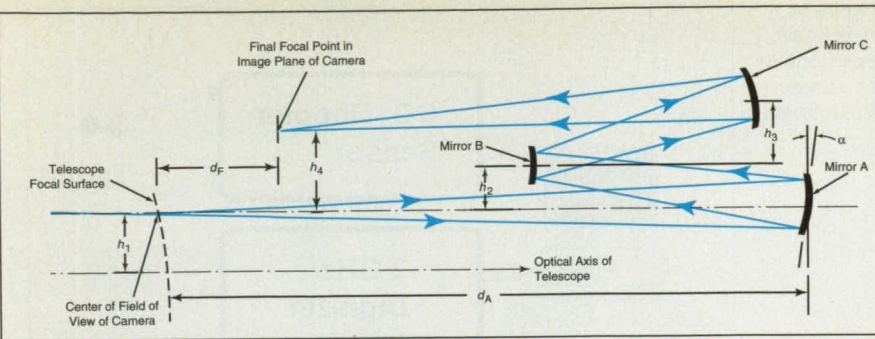

An Assembly of Circularly Symmetric Aspherical Mirrors can be designed to provide off-axis positioning of the center of the field of view, an unobstructed aperture, correction for telescope aberrations, and diffraction-limited performance.

one of the original design requirements was to position the center of the field of view of the camera somewhat to the side of the optical axis of the telescope. A conventional approach to satisfaction of these requirements would have involved the use of off-axis (non-circularly-symmetric) segments of aspherical mirrors, but segments of this type are difficult to manufacture and align. The circularly symmetric optical elements of the proposed assembly can be manufactured and aligned more easily. A ray-tracing design and optimization computer program showed that diffraction-limited performance can be obtained over a wide range of positions of the final focal point relative to the focal point of the telescope by use of three circularly symmetric mirrors, each having a different radius of curvature, aspheric power, and tilt.

The figure shows an example configuration in which the center of the field of view of the camera is at a lateral distance h_1 from the optical axis of the telescope. The beam of light from the telescope diverges to mirror A, which is

tilted at an angle α . Mirror B is located at the relayed pupil of the telescope formed by mirror A, centered a distance h_2 from the optical axis of the telescope. Mirror B corrects for the spherical aberration of the telescope over the entire field of view of the camera. The beam leaving mirror B arrives at mirror C, which is at lateral distance h_3 from the center of mirror B, selected to provide ample clearance. Mirror C has the curvature required to produce the final focal ratio of the camera at the image plane, which is located at axial distance d_f from the focal point of the telescope. The lateral distance, h_4 , of the focal point of the camera from the optical axis of the telescope is not selected in advance but is determined by the design equations from the chosen locations of mirrors A, B, and C.

This work was done by Steven A. Macenka and Aden B. Meinel of Caltech for NASA's Jet Propulsion Laboratory. For further information, write in 86 on the Reader Information Request Card.

NPO-19115

Laser Velocimeter for the Measurement of Hyper-Velocity Particles

The Doppler shift of a scattered carbon dioxide laser beam indicates the velocity of small targets (up to Mach 15).

Naval Air Warfare Center, Weapons Division, China Lake, CA

A laser velocimeter was constructed utilizing a single-frequency carbon dioxide laser integrated with a heterodyne receiver to measure the velocity of flyer plates (Figure 1). These small plates, approximately 200 microns in diameter, are made of Kapton® and are propelled at velocities up to 5000 meters per second. The desired data product of the velocimeter was a time-vs.-velocity profile of the projectile. The time interval of the measurement, as well as the target material, dictate the need to pursue optical

techniques in solving this problem.

Over the past several decades some important developments have taken place in the design and theory of flyer plates and high-velocity measurement techniques. Until recently, most hypervelocity (1000-5000 m/s) measurements of plates were made with devices such as the Fabry-Perot velocimeter, the Velocity Interferometer System for Any Reflector (VISAR), and the Optically Recording Velocity Interferometry System (ORVIS). All of these techniques depend upon the

number of fringes created by the difference in phase (differential Doppler) between a delayed and an immediate return signal from an accelerating target. The difficult parameter in the operation of interferometric systems is the need to maintain fringes with high contrast ratio. This requires matching the intensity of the reference- and target-scattered light.

Current advances in both high-speed digitizer and photovoltaic HgCdTe detector technology make it possible to directly measure the Doppler shift of a CO₂ laser beam scattered from a hypervelocity target with a simple heterodyne receiver. The resultant intermediate beat frequency, created by mixing Doppler-shifted target-backscattered light with a reference beam, was digitized and downloaded to a computer for data analysis. The Doppler frequency spectrum, as a function of time, was then calculated using fast Fourier transform (FFT) techniques. This frequency is a direct measure of the target's velocity.

This system is capable of measuring Doppler frequencies down to approximately 500 kHz over a 1-millisecond time interval (limited by the stability of the laser). This translates to a 2.65-m/s velocity error. The accuracy of a measurement varies with both the measurement time interval and the system's signal-to-noise ratio. The frequency spectrum of sequential (in-time) arrays was combined to produce a time-vs.-frequency (velocity) profile of the flyer plate. The equation

Figure 1. The basic components of a Laser Velocimeter

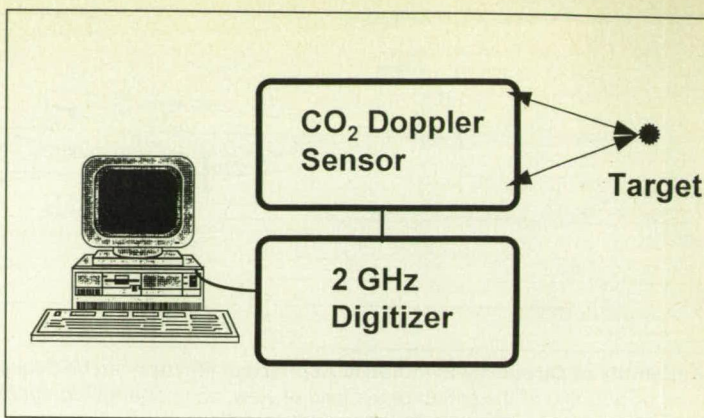
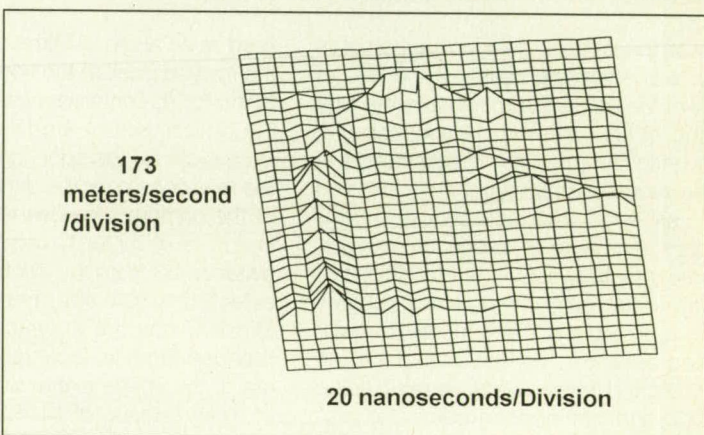

Figure 2. Three-dimensional plot of Time vs. Frequency as measured by a laser velocimeter.



used to calculate the velocity is

$$V = \frac{\Delta f \cdot \lambda}{2}$$

Δf would include that frequency read from the FFT plot plus a 40-MHz offset frequency generated by a modulator in the optical system. An 840-MHz term in the FFT would correspond to a 4906-m/s velocity. In general the data displays both the acceleration and deceleration of the flyer particle. This is shown in the three-dimensional rendering of the frequency-vs.-time plot in Figure 2. The horizontal axis is time increasing to the right; the vertical axis is frequency (velocity) increasing toward the top. The apparent mountain range that arises at the far left (zero time) of the plot is the start of motion. The upper ridge proceeding to the right on the plot is the signal resulting from the flyer plate itself. The large ridge that decreases more rapidly (in frequency) as it proceeds to the right is the signal from the propellant gases.

The team has demonstrated that a simple heterodyne Doppler receiver can measure the velocity of very high-speed particles. Comparisons between the experiments discussed here and VISAR (the current Los Alamos technique) results produced velocity numbers that would indicate measurement errors less than that expected from either technique. A CO₂ Doppler velocimeter is currently limited by detector technology to velocities of 15,750 m/s.

This work was performed by Wayne Willhite and George Hennings of the Naval Air Warfare Center (NAWC), Weapons Division, China Lake, CA. A patent application is on file under Navy case number 73704.

Further inquiries should be addressed to NAWC, 1 Administration Circle, Code C2151, Attn. Willhite, China Lake, CA 93555 or NAWC, 1 Administration Circle, Code C2743, Attn. Hennings, China Lake, CA 93555. Alternatively inquiries may be made to Dr. Bill Webster, ORTA, Commander, NAWC, Weapons Division, Code 0254, 1 Administration Circle, China Lake, CA 93555-6001; (619) 939-1074.

30,000 Pulses per Second!

Oxford Lasers' Copper Lasers provide the highest visible power commercially available. With repetition rates up to 30,000 pulses per second and pulse durations of less than 30 nsec, the copper laser has proven far superior for many applications over conventional argon ion or doubled yag.

The high pulse rates provide

- High Speed Imaging:** High resolution motion analysis
- Micromachining:** High throughput with minimal heating
- Dye Laser Pumping:** Excellent signal to noise ratios
- Frequency Doubling:** Multi-KiloHertz UV light source
- Laser Guide Star:** High resolution adaptive optics system
- Forensics:** High sensitivity fingerprint detection
- Laser Light Shows:** 4-Color, high brightness displays

With a diverse list of applications, our lasers can be found in the leading research laboratories around the world. These systems are available on a **rental or consulting** basis. We also provide an applications lab to meet your micromachining requirements.

In the US, call toll free:

(800)222-3632

"The EXCELLENT choice"

Prof. J Wallace-Univ of Maryland

"Powerful Performance

Thumbs Up!"

Prof. D Watt - UNH

"Put this on your MUST

SEE list!"

Prof. J Katz - Johns Hopkins

33 Nagog Park, PO Box 2620, Acton, MA
U.S.A. / Canada Tel (508)264-9110
Jahnstraße 10, D6116, Eppertshausen
Germany Tel 06071-33024
Abingdon Science Park, Abingdon, UK
Europe / Asia Tel (0235) 554211

OXFORD
LASERS

High-Temperature Microphone With Fiber-Optic Output

Features include flat frequency response, durability, and insensitivity to temperature.

Langley Research Center, Hampton, Virginia

An acoustic-pressure transducer (microphone) with fiber-optic output is designed to withstand a hot, loud, structurally vibrating environment like that of a jet engine. The microphone features flat frequency response out to frequencies well beyond the several-kilohertz range ordinarily needed to test for acoustic-pressure loads on engine structures.

This microphone (see figure), like others, includes a diaphragm that is deflected by the instantaneous acoustic pressure on its outer face. The deflection is measured by a fiber-optic interferometer mounted in the microphone housing behind the diaphragm. The interferometer, shown in more detail in the lower part of the figure, includes an input optical fiber and an output optical fiber that are fused at the microphone end. The fused end is cleaved and polished. An aluminum coat on half of the polished end serves as a reference mirror. The inner face of the diaphragm serves as a sensing mirror.

Infrared light from a laser diode, at a wavelength of about 1,300 nm, enters the microphone along the input optical fiber. Some of the light is reflected from the reference mirror, and some from the sensing mirror. Reflected light travels along the output optical fiber toward a photodetector and signal-processing circuitry. Because of interference between the reference- and sensing-mirror reflections in the output beam, the net intensity of light that reaches the photodetector varies sinusoidally with the distance between the reference mirror and the reflecting spot on the diaphragm. Because of the proximity of the reference and sensing mirrors, the re-

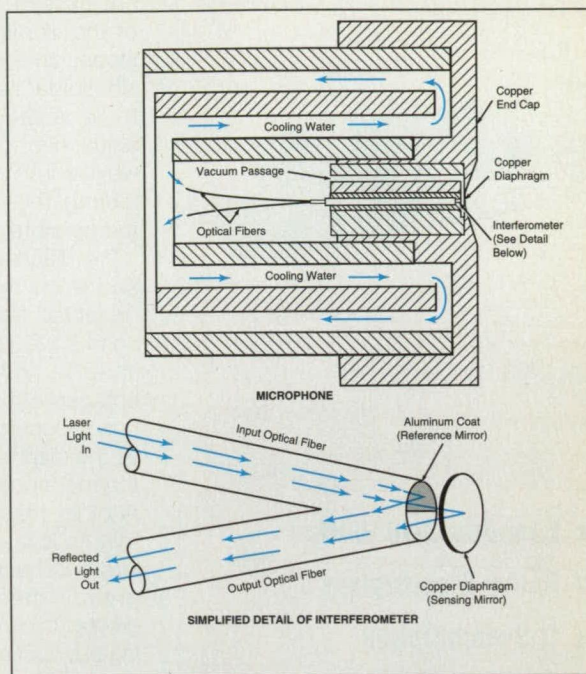

The **Fiber-Optic Interferometer** measures the deflection of the diaphragm. With water cooling, the microphone can operate at an ambient temperature of 1,600°C.

Quality Instruments for: Laser Diode Control Laser Measurement Fiberoptic Test & Measurement

ILX Lightwave offers an unparalleled selection of high quality, precision laboratory instrumentation. Backed by proven technology, our extensive line of instruments and accessories provide you with everything you need for complete electro-optic control, test and measurement. Just call our toll free number for free information.

See us at
Booth # 716

1-800-459-9459 ext. 1017



U.S.A.: ILX Lightwave Corp. (406) 586-1244, FAX: (406) 586-9405. AUSTRALIA: Fibernet, 3-764-2111. BRAZIL: ACC Optosystems, 11-272-1544. BENELUX: Te Lintelo Systems B.V., 8360-40804. CHINA: Superbin Ltd., 2-755-6578. DENMARK: BBT Instrumenter ApS 31-19-82-08. FINLAND: Cheos OY, 859-4441. FRANCE: Photonetics, 1-3916-3377. GERMANY: Laser 2000 GmbH, 8153-405-0. GREECE: Optronics EYT, 1-983-7121. HONG KONG: A&P Instrument Co., 2-755-6578. INDIA: Advanced Photonics, 22-578-0708. INDONESIA: C.V. Schmidt Mitra Indonesia, 73-380-7844. ISRAEL: New Technology R.K. Ltd., 03-324181. ITALY: Farnell Italia SRL, 39-9907612. JAPAN: Tokyo Instruments, Inc., Tokyo, 33-686-4711, Osaka, 06-393-7411. KOREA: Wooyang Trading Co. 2-525-3816-9. NORWAY: Mestec AS, 2268-25-70. TAIWAN: Titan Electro-Optics Co. Ltd., 2-788-9500. SWEDEN: Martinsson Elektronik AB, 8-744-03-00. SINGAPORE: Schmidt Scientific (PTE) Ltd., 272-7233. SPAIN: Photonetics Espana, 1-677-77-53. SWITZERLAND: GMP SA, 21-634-8181. UK: AG Electro-Optics, 829-733305. VENEZUELA: Tecnologia OMEGA, C.A., 2-283-6164.

ILX Lightwave
Lighting the Way in Electro-Optic Instrumentation.

"User Friendly" Nd:YAG Laser

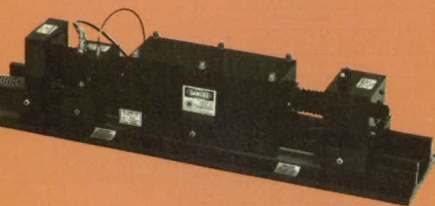

CW and Q-Switched

■ TEM₀₀-Mode Lasers

- 5 models 3-18 Watts
- Active Stabilization
- Q-Switch Option
- Applications

Resistor Trimming
Scribing/Cutting
Spectroscopy
Mode-Locking

■ Multimode Lasers

- Models 25W-1.8 kW
 - Q-Switching up to 200 W
 - Applications
- Marking / Engraving
Soldering / TAB
Welding

■ Features

- Computer Interface
 - OEM Configurations
 - Optical Accessories
- Fiber Optics
Beam Expanders
Focusing Optics

LEE LASER
718 VINELAND RD., ORLANDO, FLORIDA 32811 U.S.A.
TEL: 407-422-2476 FAX: 407-839-0294

sponse is insensitive to temperature.

The response can be made linear, to a close approximation, if the deflection of the diaphragm from its equilibrium (zero-sound-pressure) position does not exceed about 1/4 the wavelength of the illumination and the maximum-slope, zero-amplitude position of the sinusoidal response curve is adjusted to lie at the equilibrium position. This adjustment can be made by varying the wavelength of the illumination, by adjusting the operating current and/or temperature of the laser diode.

The diaphragm is made of copper foil and is clamped around its edge. It is protected from the hot environment by conductive cooling via contact between its edge and the water-cooled copper end cap of the microphone housing. Of course, one reason for choosing copper as the diaphragm material is that its high thermal conductivity facilitates cooling. Another reason for choosing copper is that its low modulus of elasticity allows larger deflection of the diaphragm (for greater measurement sensitivity) at greater thickness (which increases cooling but decreases deflection) than would be possible with other materials. At the same time, the modulus of elasticity of copper is not so low as to affect the fre-

quency response adversely: with a diameter of 1.25 mm and a thickness of 0.05 mm, the diaphragm theoretically has a natural vibrational frequency of 208 kHz, which is far more than adequate.

Assuming a theoretical signal-to-noise ratio of 70 to 80 dB, the minimum detectable displacement of the diaphragm should be about 1 Å; this represents a very small increment of acoustic pressure. In a test at an acoustic frequency of 1,000 Hz, the response of the microphone was found to be linear at sound-pressure levels from 130 to 160 dB.

This work was done by Richard F. Hellbaum of Langley Research Center and Michael F. Gunther, Richard O. Clause, and Kent A. Murphy of Virginia Polytechnic Institute and State University. For further information, write in 106 on the Reader Information Request Card.

This invention is owned by NASA, and a patent application has been filed. Inquiries concerning nonexclusive or exclusive license for its commercial development should be addressed to the Patent Counsel, Langley Research Center [see page 8]. Refer to LAR-14640.

Array of Sensors Measures Broadband Radiation

Active-cavity sensors are aimed at portions of the field of view.
Goddard Space Flight Center, Greenbelt, Maryland

Figure 1 illustrates an array of sensors that measure broadband (ultraviolet through far infrared) radiation. Each sensor is aimed at a solid angle, defined by a baffle, that is part of a larger solid angle that constitutes the total field of view. In its original form, the array is intended to be used aboard a satellite in orbit around the Earth to measure total radiation emitted, at the various viewing angles, by a mosaic of "footprint" areas (each defined by its viewing angle) on the surface of the Earth. Modified versions of the array may also be useful for angle-resolved measurements of broadband radiation in laboratory and field settings on Earth.

The sensors are mounted in a sup-

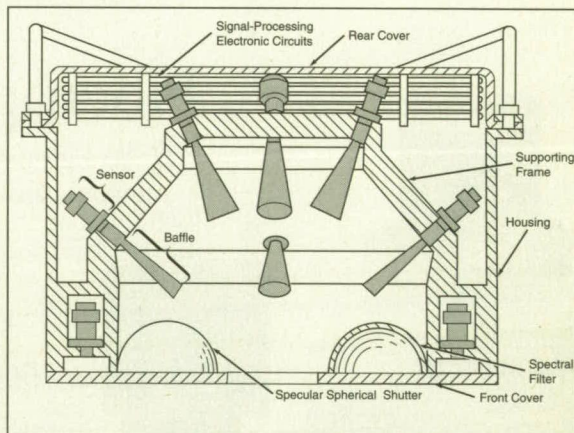
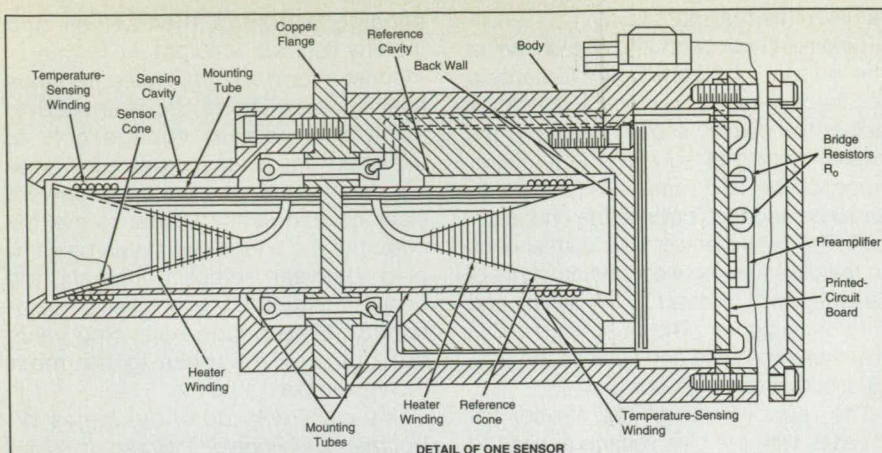
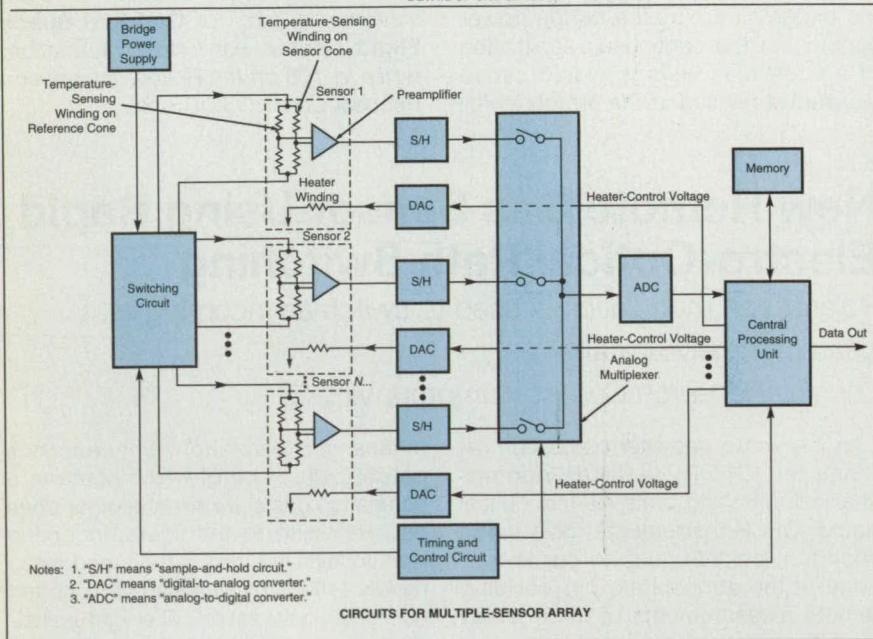

Figure 1. **Multiple Broadband Radiation Sensors** are aimed at various portions of the total field of view. All sensors are mounted in a supporting frame, which serves as a common heat sink and temperature reference.

porting frame that is sufficiently thermally conductive and thermally massive to serve as a common temperature reference and heat sink. The optical axes of most of the sensors intersect at the center of the aperture in the front cover.



DETAIL OF ONE SENSOR



CIRCUITS FOR MULTIPLE-SENSOR ARRAY

Figure 2. Each Sensor Includes a Heater Winding and a differential-temperature-sensing bridge circuit. The power in the heater winding is adjusted repeatedly in an effort to balance the bridge circuit

For calibration, a specularly reflecting hemispherical shutter can be slid across the aperture and positioned with its center coincident with that of the aperture, so that each sensor views its own internal radiation. For viewing short-wavelength radiation, a hemispherical filter that removes long-wavelength radiation can be placed across the aperture.

The operation of the sensors is based on a calorimetric-active-cavity principle. Each sensor (see Figure 2) contains a sensor cavity and a reference cavity in a thermally massive, thermally conductive body that is in thermal contact with the supporting frame/heat sink/temperature reference. The insides of the cavities are covered with specular black paint so that the cavities receive and absorb all incoming radiation via multiple reflections and absorptions.

Cones on mounting tubes in the cavities are sized, shaped, and oriented so that all radiation is trapped and convert-

ed to heat. The sensor cone receives radiation from the field of view; the reference cone receives radiation from a wall that is at the heat-sink temperature. Heat in the cones travels to the junctions with the mounting tubes, then along the mounting tubes to a flange that is part of the heat-sink body. The walls of the cones and mounting tubes are made thin to minimize thermal mass and thus maximize the temperature rise caused by incoming radiation.

The temperature near the junction of each cone and mounting tube is measured by a winding made of a wire (e.g., nickel) that has a high temperature coefficient of resistance. The temperature-sensing windings are connected into a bridge circuit, the other resistors of which are mounted at heat-sink temperature on a printed-circuit board in a separate cavity. A heater winding is mounted on the sensor cone. An identical heater winding that is not energized is mounted on the reference cone to

NEW HIGH POWER DIODE LASERS

Spire's Optoelectronics division now offers high power diode laser products including wafers, dice, bars, and mounted multibar arrays. These products have been designed to efficiently and reliably pump solid state laser rods and slabs for numerous commercial products.

Features include:

- ▶ High power:
 - 50W/bar pulsed operation (at 60A)
 - 100W/bar pulsed operation (at 95A)
 - 10W/bar CW operation (at 20A)
- ▶ Long life: Typically $> 5 \times 10^8$ shots (at 50W)
- ▶ Available wavelengths: 780 nm to 850 nm
- ▶ Custom designs available on special order

For more information, please call Optoelectronics Sales at 617-275-6000

spire

Spire Corporation
 One Patriots Park
 Bedford, MA 01730-2396/USA
 FAX 617-275-7470

NEW

Fiber Optic PC Plug-in UV, VIS, NIR Spectrometers

\$1999.⁰⁰

Versatility
and
Flexibility
with
"Plug & Play"
Fiber Optic
Accessories

Turn Your
PC into a
State of the Art
1024 Element CCD
Spectrophotometer

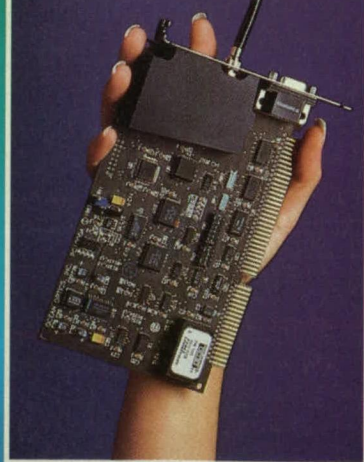

1104 Pinehurst Road
Dunedin, FL 34698
Phone: (813) 733-2447
FAX: (813) 733-3962

For More Information Write in No. 315

equalize thermal masses.

External control circuitry, also shown at the bottom of Figure 2, implements a feedback loop that repeatedly strives to adjust the current and/or voltage in the heater winding to equalize the temperatures of the two temperature-sensing windings and thus balance the bridge circuit. The heater power thus corresponds to the difference between the amounts of radiant power received by the sensor and reference cones. The heater power is therefore measured and used as the principal output of the sensor.

The responsivity of the sensor increases with the bias voltage applied to the bridge circuit by the bridge power supply, but the continuous application of a large bias voltage would cause substantial heating in the temperature-

sensing windings themselves and thereby degrade accuracy.

Consequently, to minimize spurious heating, a switching circuit is used to apply a large bias voltage only at assigned times for temperature measurements, only just long enough for electrical transients to settle so that the output of the bridge circuit can be sampled. Between sampling instants, the heater voltage and/or current is maintained at the bridge-balancing value computed in response to the most recent sample.

This work was done by James W. Hoffman and Ronald G. Grush of Space Instruments, Inc., for Goddard Space Flight Center. For further information, write in 108 on the Reader Information Request Card. GSC-13283

New Remote Gas Sensor Using Rapid Electro-Optical Path Switching

Polarization modulation is used to switch an incoming light beam nonmechanically.

Langley Research Center, Hampton, Virginia

An innovative gas filter correlation radiometer (GFCR) features nonmechanical switching of its internal optical paths. GFCR instruments have made important contributions to our knowledge of the atmosphere by providing remote measurements of trace gases from aircraft and spacecraft platforms. Although GFCR's have the ability to detect many gas species, they are generally mechanically complex, often requiring rapidly rotating gas cells or light choppers.

In this new GFCR, the incoming radiation is switched electro-optically, by

means of polarization, between two optical paths, one of which contains a correlation gas cell while the other does not. Referring to the figure, incoming light is polarized, and is then modulated rapidly (~40 kHz) between vertical and horizontal polarization. The light is incident on a polarization beam splitter, which passes the horizontally polarized light into the gas cell [containing, for example, carbon monoxide (CO)] and reflects vertically polarized light into the optical path that does not contain the cell. The two light paths are recombined, and the combined light is detect-

The Conceptual Design of a GFCR Aircraft Instrument shows electro-optical path switching by means of polarization modulation.

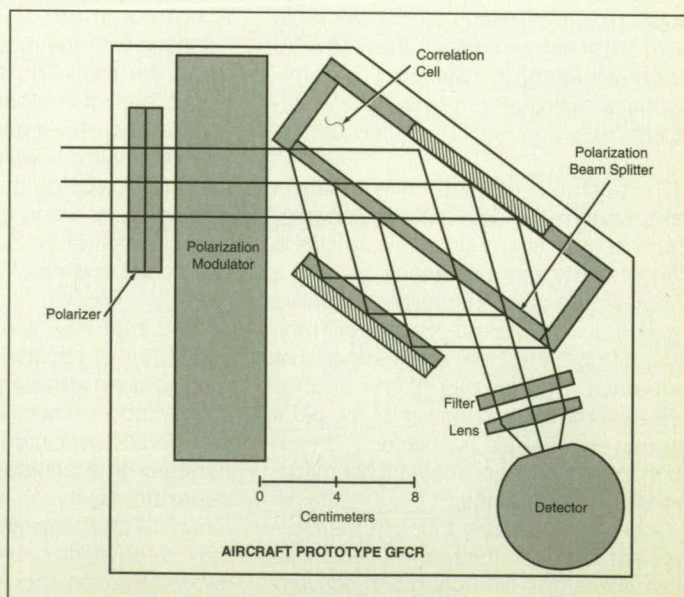

ed. A radiometric imbalance between the two optical paths can be related to the column density of that gas (e.g., CO) in the atmosphere. The instrument can be configured to use either reflected sunlight ($\lambda < 3 \mu\text{m}$) or thermal emission ($\lambda > 3 \mu\text{m}$) as the energy source. When using reflected sunlight, the instrument has peak sensitivity in the lower troposphere, an important region of the atmosphere that has not been accessible to past tropospheric instruments operating in the midinfrared.

Advantages of this new technique include its switching speed, 2 to 3 orders of magnitude faster than mechanical techniques, and high reliability, since there are no rapidly moving mechanical parts.

Atmospheric applications for this new technology include regional studies of atmospheric chemistry from either manned or unmanned aircraft as well as satellite studies of global distributions, sources and sink mechanisms for key species involved in the chemistry of

the troposphere. Commercial applications for the nonmechanical GFCR might include the ability to survey many miles of natural gas pipelines rapidly from an aircraft, pinpointing gas leaks by measuring methane at $2.3 \mu\text{m}$.

This work was done by G. W. Sachse, P. J. LeBel, H. A. Wallio, and S. A. Vay of Langley Research Center and L. G. Wang of the College of William and Mary. For further information, write in 74 on the Reader Information Request Card. LAR-14588

Improved Fiber-Optic-Coupled Pressure and Vibration Sensors

Sensitivities are increased, sizes are reduced, and operating temperatures are sometimes increased.

Langley Research Center, Hampton, Virginia

The figure illustrates an improved optical configuration for a fiber-optic-coupled pressure or vibration sensor or microphone of the kind based on modulation of the intensity of reflected light. In this configuration, a single optical fiber both (1) carries light from an optoelectronic transmitter to a reflective transducer in the sensor head and (2) carries the modulated, reflected light that bears the sensory information from the sensor head back to an optoelectronic receiver. This single-fiber configuration can be designed to couple light to and from the transducer more efficiently than can the older multiple-optical-fiber configurations of the sensors of this type. Thus, the sensitivity is increased, and the size is reduced. The increase in sensitivity and decrease in size provide increased margin for design of compact sensor heads that are not required to contain amplifier circuits and can therefore withstand higher operating temperatures.

The optical fiber is of the multimode, step-index type with a typical core diameter between 100 and 400 μm and a typical cladding thickness of 20 μm . The sensor head includes a probe-like housing (which could be made, for example, from a hypodermic needle). The optical fiber in the sensor head is connected to the external optical fiber via a commercial fiber-optic adapter. The end of the optical fiber in the sensor head is polished and positioned near the reflective transducer surface. In the case of a pressure sensor, the reflective transducer surface could be a metal diaphragm or the metalized surface of a nonmetallic diaphragm across which the pressure is applied; in the case of a vibration sensor, the reflective transducer surface is

attached to an accelerometer proof mass, which is spring-mounted so that it can move toward or away from the end of the optical fiber by an amount proportional to the component of acceleration along the axis of the fiber.

A key component of the sensor system is a 3- or 4-port fiber-optic coupler,

which is fabricated by fusing together two optical fibers along short lengths from which the claddings have been removed, then immobilizing the fibers in a potting compound. The configuration of the coupler is chosen so that a beam of light that enters through either port on either side is divided into two approxi-

Monochromatic Illumination

(Pick a wavelength. Any wavelength.)



Introducing the SEC MIS 1000 — a 1000 Watt integrated monochromatic illumination system... with $\pm 0.2\text{nm}$ resolution!

Cover the spectrum from 180-3000nm (and higher) with a Xenon arc source (UV-VIS-IR) or Xenon-Mercury source (for enhanced UV).

Enjoy maximum performance from a system designed to work as a system: with matched optics for uniform output, and a unitized baseplate for mechanical stability.

Choose from a broad range of accessories such as computer compatible motorized scan drives, sample chambers, optical feedback (for unsurpassed source stability), shutters, mirrors, and more.

No other manufacturer can offer the combined depth of experience in monochromator and source system design the SEC offers. Count on that expertise for monochromatic illumination systems from 150-2500 Watts.

Call or write today. SEC, 67 Woodland Ave., Westwood, N.J. 07675
Phone: 201-664-0876 FAX: (201) 664-1214
Offices in Waldbronn, W. Germany, Bedford, UK and Les Ulis, France. Representation worldwide.

SPECTRAL ENERGY

67 Woodland Ave.
Westwood, NJ 07675

EXCELLENT

BEAM QUALITY

PULSED N₂

LASERS

The Laser Science, Inc. series of VSL-337 **ND Near Diffraction Limited** nitrogen lasers (337nm) incorporate a proprietary resonator designed for high Beam Quality and Mechanical Stability.

Beam Divergence of < 0.3 mrad full angle yields:

- Smaller spot sizes
- Higher energy densities
- Greater fiber optic throughput
- Longer working distances

All VSL-337**ND** series lasers have:

- A self-contained plasma cartridge with no flowing gas
- Increased mechanical stability providing rugged and reliable operation for OEM's

Less than 1 ns jitter opto-sync is available with the VSL-337ND-S version along with a burst mode to selectively gate laser pulses.

The VSL-337**ND** series of nitrogen lasers are used for laser desorption/ionization, cell surgery, fluorescence, release of caged compounds, photo-chemical reactions, micro-machining, and spectroscopy.

Call **Laser Science, Inc.** at
1-800-447-1020
for application assistance
from our technical staff.

LSI *laser science, inc.*
75 Chapel Street
Newton, Massachusetts 02158
(617) 969-2211 FAX: (617) 969-3212
Outside MA: (800) 447-1020

For More Information Write In No. 423

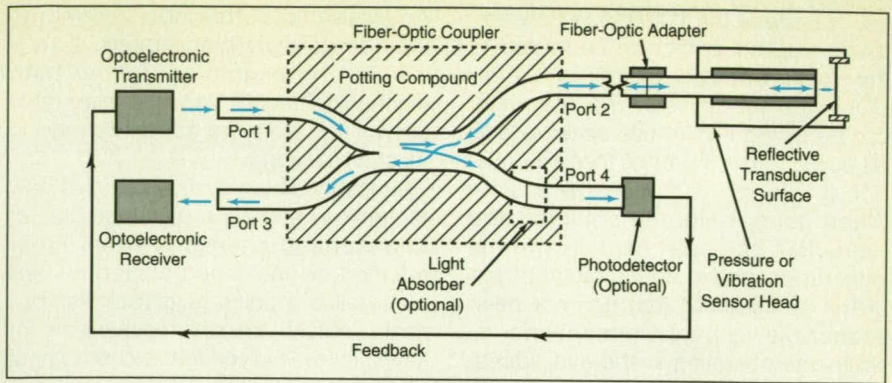

The Fiber-Optic Coupler enables the use of a single optical fiber to carry light to and from the sensor head. In addition to the advantages described in the text, the single-fiber configuration eliminates the problem of alignment of multiple fibers in the sensor head and simplifies calibration by making performance both more predictable and more stable.

mately equal beams that leave through the ports on the opposite side.

Thus, light from a light-emitting diode in the optoelectronic transmitter enters through port 1 and is divided into two beams, one of which travels to the sensor head, the other of which travels to port 4. Optionally, port 4 can be replaced by an optical absorber to prevent spurious reflections; otherwise, the transmitted light leaving through port 4 could be monitored by a photodetector, the output of which would constitute a feedback signal for maintaining constant transmitted optical power.

The light reflected from the transducer enters through port 2 and is also divided, so that about half travels toward the

receiver at port 3 while half travels back toward the transmitter. Although half the light is thus wasted, this loss is more than offset by the improved efficiency of coupling in the sensor head. In one design, for example, the estimated overall sensitivity is about twice that of a comparable multiple-fiber-coupled sensor, while the estimated minimum detectable displacement of the reflective transducer surface is less than half that of the multiple-fiber-coupled sensor.

This work was done by Allan J. Zuckerwar of Langley Research Center and Frank W. Cuomo. For further information, write in 19 on the Reader Information Request Card.
LAR-15084

Reflective Baffles for Telescope

Nonimaged light that would cause unacceptable heating is rejected instead of absorbed.

Marshall Space Flight Center, Alabama

Precise reflective baffles have been incorporated into a reflective telescope to prevent the undesired portion of incident light (light from directions not within the desired small field of view) from entering the sensitive optical and electronic instruments in the focal region of the main reflector. In the original intended application, the telescope and associated instruments are to be placed in geostationary orbit to observe a selected area of the Earth; the undesired light is solar light reflected from adjacent areas of the Earth or coming directly from the Sun when the line of sight to the Sun lies near the field of view. The undesired light can not only interfere with observations but can also cause excessive and/or uneven heating of the instruments. This can also be true of terrestrial optical instruments, which might therefore also be improved by the installation of reflective baffles.

Of course, the telescope and instrumental surfaces surrounding the optical paths can be painted flat black to absorb undesired light, as is done in many optical systems. However, the absorption of light causes heating of the surfaces, and this can also exert undesired effects on observations. Thus, the development of the present reflective-baffle configuration is motivated by the need to reflect the undesired light and its energy back out of the telescope rather than retain the energy within the telescope and instrument in the form of heat.

The figure is a simplified cross-sectional view of the telescope equipped with reflective baffles, plus an associated scanning mirror with a hole in its center. The incoming light is reflected from the scanning mirror into the telescope. The main reflector focuses the desired light from the area under

observation to a real image in the hole in the scanning mirror. The focused light from areas adjacent to the observed area strikes the corresponding areas on the scanning mirror away from the hole and is thus reflected back out of the telescope.

In addition, some incoming light that originates outside the field of view of the main telescope reflector and that would otherwise strike the inner surface of the telescope tube is intercepted by the polished front surfaces of the baffles and reflected outward. Other spurious light that reaches the main reflector bounces back out at an oblique angle and strikes the polished rear surfaces of the baffles, which are precisely angled so that this light is also ultimately reflected to the outside.

This work was done by Warren A. Hovis of Research Support Instruments, Inc., for Marshall Space Flight Center. For further information, write in 45 on the Reader Information Request Card.

In accordance with Public Law 96-517, the contractor has elected to

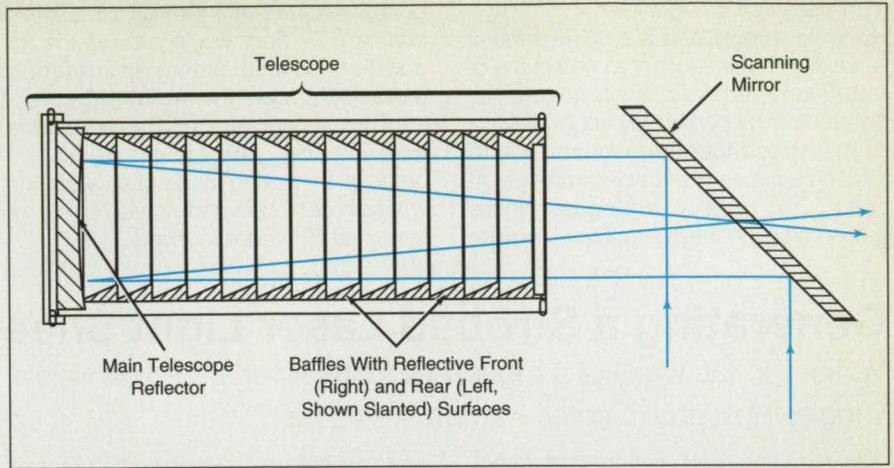

Reflective Baffles (instead of the usual black paint) reflect unwanted light out of the telescope (rejecting instead of absorbing it). The rays drawn here show the path taken by the light from the area under observation. Light from other directions is reflected out by the baffles, and/or the scanning mirror.

retain title to this invention. Inquiries concerning rights for its commercial use should be addressed to: Ted Lawsen, Research Support Instruments, Inc., 10610 Beaver Dam Road,

Hunt Valley, MD 21030

Refer to MFS-26249, volume and number of this Laser Tech Briefs issue, and the page number.

Triboluminescent Fiber-Optic Sensors Measure Stresses

These sensors could be used to monitor mechanical conditions in structures.

Langley Research Center, Hampton, Virginia

Triboluminescence involves the production of photons caused by mechanical stress. It was first recorded by Sir Francis Bacon (1605) while scraping lumps of sugar. The physical mechanism that produces the light is not well understood. Nevertheless, many materials exhibit the effect, including aluminum oxide, zinc sulfide, lithium fluoride, and calcium fluoride. Triboluminescence is exploited in a fiber-optic sensor system for measuring changes in pressures, strains, vibrations, and acoustic emissions, in structural members. The sensors can be embedded in the members for in situ monitoring of the condition of a structure.

A fiber made of triboluminescent material embedded in a graphite/epoxy composite generates photons under vibrational stress. It can provide a vibrational signature because the intensity of the stress-induced light oscillates at the frequency of vibration. Concentrations of stresses or information on values of stresses at discrete positions along the optical fiber can be detected by coding the fiber with sections of different materials that emit photons of different energy and therefore can be discriminated by filtering or dispersion. Diffraction gratings can be created at desired positions in the optical fibers so that the discrimination can be provided by the fibers themselves.

For example, three different materials that exhibit different fluorescence signatures can be used. These materials are labeled B = Blue, G = Green, and Y = Yellow, for the colors of light emitted. The simplest method involves placing sections of the fluorescent materials along the fiber at regular intervals. For example, a section of fiber 10 m long would contain B at 2.5 m from one end, G at 5 m, and Y at 7.5 m. The amount of mechanical stress at each position would be given by the intensity of light at each wavelength. A more-complex coding system, such as pairs or triplets of materials at specific locations, could provide stress information at

Laser Chillers

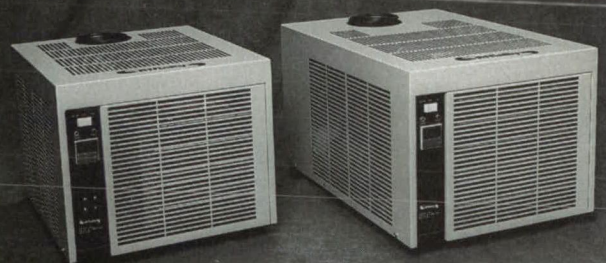

- Capacities from 1kW to 100kW
- Compact & Portable
- Refrigerated & Non-Refrigerated
- Custom Configurations
- Always CFC-Free

» Affinity »

603/539-3600 • FAX: 603/539-8484
PO Box 1000 Ossipee, NH 03864 USA

many locations along a fiber.

One advantage of this system is that it is passive in the sense that no source of radiation is required to interrogate the optical fiber. A particularly important use of the stress-location signature is in locating sources of acoustic emission. At present, optical-fiber sensing techniques that exploit phase modulation provide

complex signals that are difficult to interpret. A BGY fiber would provide the triangulation and timing information required to locate the origin of the pressure wave that excites the emissions from the fiber. This technique has the potential for a wide range of applications in which detection and measurement of structural stress are required.

This work was done by Robert S. Rogowski of **Langley Research Center**. No further documentation is available.

Inquiries concerning rights for the commercial use of this invention should be addressed to the Patent Counsel, Langley Research Center [see page 8]. Refer to LAR-14368.

Generating a Strobed Laser Light Sheet

Vortices in the wake of a model helicopter rotor are made visible.

Langley Research Center, Hampton, Virginia

An optoelectronic system that generates a synchronous, strobed sheet of laser light has been developed for use in making visible the flow of air about a model helicopter rotor. The system was used in wind-tunnel tests to determine actual locations of vortices for comparison with locations predicted by mathematical models to validate the models. Each blade tip produces a vortex. By establishing successive vortex locations, a researcher can determine the trajectory of the vortex pattern.

The light-sheet strobe circuits provided selection of blade position, strobe-pulse duration, and multiple pulses per revolution for rotors that have two to nine blades. To make the flow visible, vapor-

ized propylene glycol was injected upstream of the model. The system also provided cali-brated trigger delay of the strobe pulse, adjustable strobe-pulse duration, selectable number of blades, and slip-sync mode to make the flow visible as though in slow motion. A calibration grid for use in extracting quantitative data was placed in the plane of the light sheet and recorded by use of the same video camera and position as those used to record the flow field.

A compound cylindrical lens assembly was used to spread the laser beam to generate a single sheet of laser light (see figure). The source of light was an argon-ion laser operating in the "all lines" mode with an output of approximately 5 W. The light sheet was strobed by the addition of an acousto-optical Bragg cell shutter, placed between the laser and the optics package, which produced zero- and first-order light beams. The zero-order beam was unused and blocked. The first-order beam from the Bragg cell was chopped by the signal being fed to the cell from the synchro-

nization circuit.

The Bragg cell introduced color dispersion. This chromatic dispersion was corrected by the insertion of a dual prism assembly into the optical path just aft of where the beam left the Bragg cell. The dual prism assembly consisted of two rotatable prism wedges that could be adjusted to converge the different wavelengths back onto a common optical centerline.

Quantitative data were extracted by using the video record of the grid as an overlay for individual frames on the video record of the flow field. The system was used in the NASA Langley 14- by 22-ft (4.3- by 6.7-m) Subsonic Tunnel to make two-dimensional flow-field cuts of a four-bladed rotor operating at an advance ratio of 0.37 at wind-tunnel speeds up to 79.25 m/s (260 ft/s).

This work was done by Bradley D. Leighty, John M. Franke, David B. Rhodes, and Stephen B. Jones of **Langley Research Center**. For further information, write in 17 on the Reader Information Request Card. LAR-14556

The Optical Assembly of the light-sheet-generating system was installed in the test section of a low-speed wind tunnel.

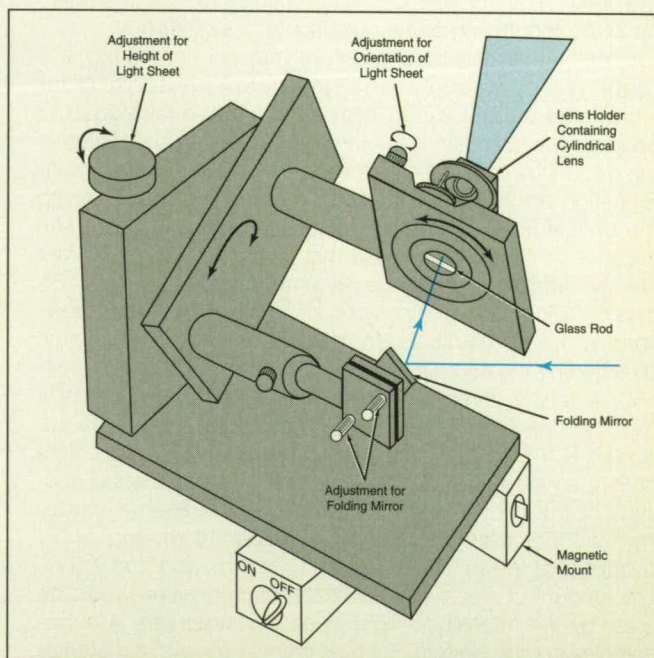

Custom Pellicles

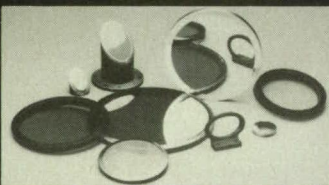

24 hours to 2 weeks!

1/16" to 48" and larger!

Ultra-custom designs estimated.

Custom Coatings

- Dichroic ■ Infrared ■ No Loss
- Attenuators ■ Anti-Reflective

Custom Frames

- Oval ■ Square ■ Rectangular ■ Brass
- Elliptical ■ Truncated Cylinders
- Stainless Steel ■ Aluminum ■ Others
- Critical Flatness/Transmission Requirements Met/Documented ■ Quantity discounts available ■ Expert Prototype Design

NATIONAL PHOTOCOLOR
CORPORATION

428 Waverly Avenue. P.O. Box 320.
Mamaroneck, NY 10543-0320 USA

Tel: 800-698-8151

Fax: 800-698-3629

MasterCard and VISA accepted.

Cubic GaS: A Surface Passivator for GaAs

Thus passivated, GaAs can be a substrate material for metal/insulator/semiconductor (MIS) capacitors.

Lewis Research Center, Cleveland, Ohio

Thin films of the cubic form of gallium sulfide (GaS) can be formed on the surfaces of gallium arsenide (GaAs) substrates via metal/organic chemical vapor deposition (MOCVD). As formed in nature and in other chemical processes, GaS normally has a hexagonal crystal lattice. The cubic form is an artificial form created by MOCVD from the engineered single source precursor material [(t-Bu)GaS]4, where "t-Bu" denotes the tertiary butyl [C(CH₃)₃] group (see Figure 1).

The deposited cubic GaS, the crystalline lattice of which is matched to that of the substrate GaAs, neutralizes electrically active defects on the surfaces of both n-doped and p-doped GaAs. This enables the important GaAs-based semiconducting materials to serve as substrates for metal/insulator/semiconductor (MIS) capacitors, which are critical components of many high-speed, low-power semiconductor devices.

Cubic GaS may also enable the fabrication of ZnSe-based blue lasers and light-emitting diodes. Because GaS is optically transparent, it could also be deposited to form window layers for such optoelectronic devices as light-emitting diodes, solar optical cells, and semiconductor lasers. Its transparency may also make it useful as an interconnection material in optoelectronic integrated circuits. It may also be useful in peeled-film technology because it can be selectively etched from GaAs.

With respect to utility in most electronic devices, GaAs has properties superior to those of silicon: it has higher electron mobility and drift velocity and a shorter minority-carrier lifetime than does silicon. Typically, a GaAs-based device exhibits 6 to 10 times the speed and 1/10 to 1/6 the power consumption of a Si-based device of otherwise similar design and function. Until now, however, gallium arsenide has usually not been the semiconductor of choice because it lacked a suitable insulating layer necessary for the formation of MIS capacitors.

By physical and chemical mechanisms that are not yet fully understood, a deposited layer of cubic GaS neutralizes

Figure 1. A **Passivating Layer of Cubic GaS** is deposited on the surface of GaAs at a temperature less than 400 °C, by use of an engineered precursor material that yields the desired cubic crystal lattice.

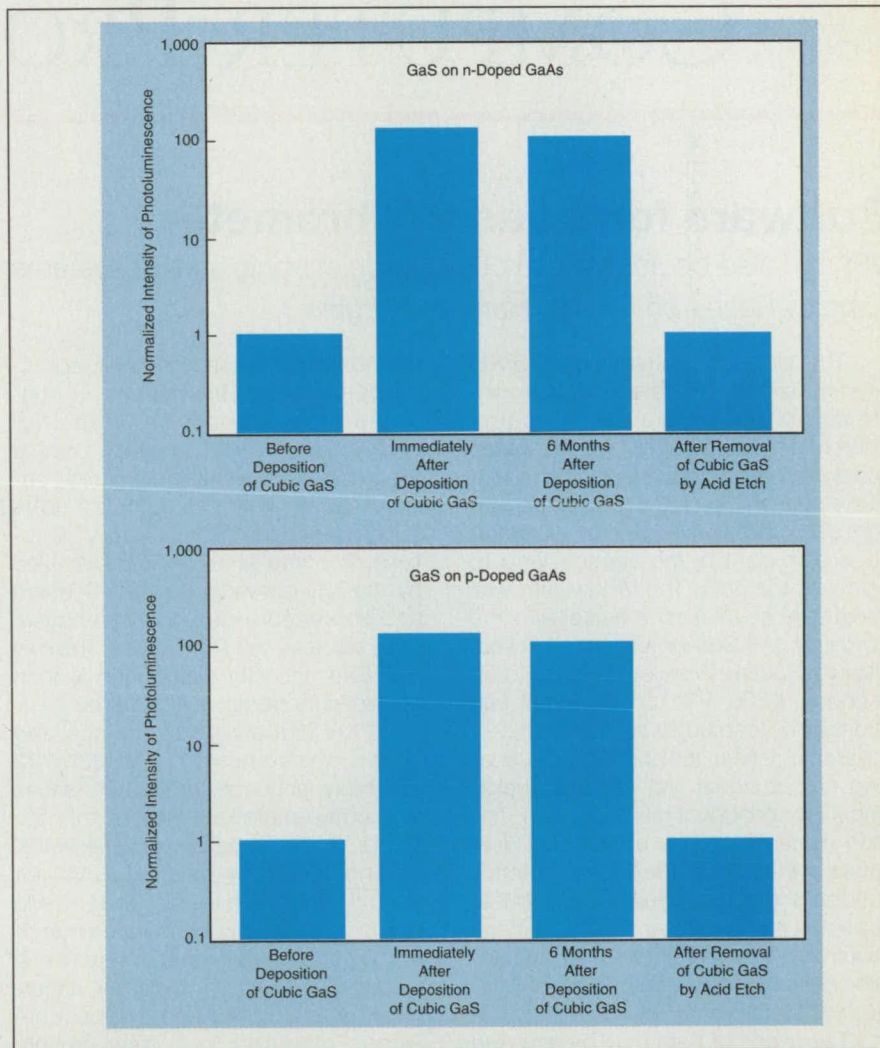
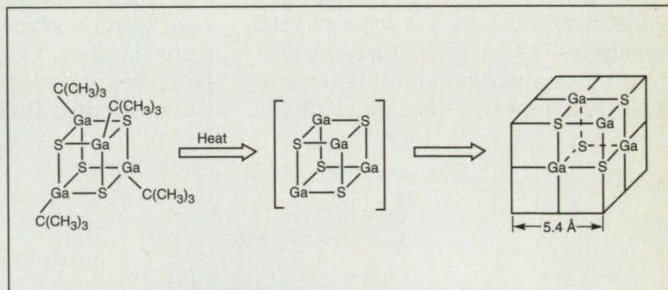

Figure 2. **Normalized Photoluminescence Intensities** were obtained on specimens of GaAs with and without passivating layers of cubic GaS.

electrically active defects on the surface of GaAs. Presumably, the defects are unpaired bonds at the gallium and

arsenic lattice sites. The experimental evidence available when the information was submitted for this article suggests

that the lattice of GaS is matched to that of GaAs and that GaS terminates the unpaired bonds lattice point by lattice point. Another possibility is that the GaS supplies sulfur (a known passivator of GaAs) to the GaAs surface and simultaneously covers the sulfur-terminated GaAs with a layer of GaS that prevents the absorption of oxygen, which would normally destroy the sulfur passivation.

Passivation of GaAs surfaces by cubic GaS was observed in experiments by comparing photoluminescence from GaAs surfaces with and without GaS overlayers. The intensity of the photoluminescence resulting from the generation of electron/ hole pairs via irradiation

at a wavelength of 514 nm by an argon-ion laser was found to increase with passivation because the passivation eliminated the surface states that give rise to nonluminescent pathways of recombination. As shown in Figure 2, the intensities of photoluminescence from passivated n-doped and p-doped GaAs increased by a factor of about 100 over those of the bare n-doped and p-doped GaAs surfaces. After the GaS layers were etched off by use of HCl, the intensities of photoluminescence of the bare GaAs surfaces returned to their starting values, indicating that the bulk properties were not altered by the deposition of cubic GaAs. Most strikingly,

there was little decrease in the intensities of photoluminescence even after storage in ambient laboratory conditions, with no attempt to exclude oxygen or atmospheric moisture, for 6 months after deposition.

This work was done by Aloysius F. Hepp of Lewis Research Center, Andrew R. Barron and Michael B. Power of Harvard University, Phillip P. Jenkins of Sverdrup Technology, Inc., and Andrew N. MacInnes of Gallia, Inc. For further information, write in 142 on the Reader Information Request Card. LEW-15775

COMPUTER PROGRAMS

Software for a Laser Vibrometer

VPI can also be adapted to other optoelectronic sensor systems.

Langley Research Center, Hampton virginia

The Vibration Pattern Imager (VPI) system and its software were designed to control and acquire data from laser vibrometer sensors. This system, based on a personal computer, includes a digital signal-processing (DSP) board and an analog input/output (I/O) circuit board to control the sensors and to process the data. The VPI system was originally developed for use with the Ometron VPI Sensor (Ometron Limited, Kelvin House, Worsley Bridge Road, London, SE26 5BX, England), but can be readily adapted to any commercially available sensor that provides an analog output signal and requires analog inputs for control of mirror position. The VPI system includes a graphical user interface that provides for interactive control through keyboard and mouse-selected menu options. The main menu controls all functions for setup, acquisition of data, display, file operations, and leaving the program.

Two types of data may be acquired with the VPI system: single point or "full field". In the single-point mode, time-series data are sampled by an analog-to-digital (A/D) converter on the I/O board at a rate defined by the user for the selected number of samples. The

position of the measuring point, adjusted by mirrors in the sensor, is controlled via a mouse input. In the "full field" mode, the measurement point is moved over a rectangular area, selected by the user, that contains up to 256 positions in both x and y directions. The time-series data are sampled by the A/D converter on the I/O board and converted to a root-mean-square (rms) value by the DSP board. The rms "full field" velocity distribution is then uploaded for display and storage.

VPI is written in C language and Texas Instruments' TMS320C30 assembly language for IBM PC-series and compatible computers running MS-DOS. The program requires 640K of random-access memory (RAM) for execution, and a hard disk with 10 Mb or more of disk space is recommended. The program also requires a mouse, a VGA graphics display, a four-channel analog I/O board (Spectrum Signal Processing, Inc.; Westborough, MA), a break-out box and a Spirit-30 circuit board (Sonitech International, Inc.; Wellesley, MA), which includes a TMS320C30 DSP processor, 256 Kb of zero-wait-state static RAM, and a daughter board with 8 Mb of one-wait-

state dynamic RAM. Please make contact with COSMIC for additional information on required hardware and software. To compile the provided VPI source code, a Microsoft C version 6.0 compiler, a Texas Instruments' TMS320C30 assembly language compiler, and the Spirit 30 run-time libraries are needed. A math coprocessor is highly recommended. A sample MS-DOS executable code is provided on the distribution medium. The standard distribution medium for this program is one 5.25-in. (13.34-cm), 360K MS-DOS-format diskette. The contents of the diskettes are compressed by use of the PKWARE archiving tools. The utility software to unarchive the files, PKUNZIP.EXE, is included. VPI was developed in 1991-1992.

This program was written by Stephen A. Rizzi and Thomas A. Shaffer of Langley Research Center and Donald E. Brown of Lockheed Engineering & Sciences Co. For further information, write in 100 on the Reader Information Request Card. LAR-14897

Multiple Pages Intentionally Left
Blank

FABRICATION TECHNOLOGY

Deposition of Carbide Coatings Using a Two-Laser Process

A system to produce refractory carbide coatings at low temperatures is under development.

Brookhaven National Laboratory, Upton, New York

The use of refractory carbide coatings for protecting materials from corrosive gases at high temperatures or to provide surface toughness is well established. Recently a Brookhaven team has become involved with the use of these materials for the protection of graphites and carbon-carbon composites from attack by hot hydrogen at high temperatures. Typically, these coatings have been applied to the carbon substrate using either conventional chemical vapor deposition (CVD) or chemical vapor reaction (CVR) techniques. The latter process has proven quite effective in producing dense adherent and protective coatings. In this process a metal halide vapor reacts with carbon in the substrate to produce the carbide.

For a refractory carbide such as tantalum, the reaction is:

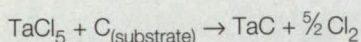

This reaction typically occurs at temperatures in the range of 1700-2600 K, depending on the carbide, with coating thicknesses on the order of 10-100 micrometers. Since these coatings are produced at high temperatures, the grain size is quite large.

In an effort to reduce the overall substrate temperature as well as to provide a means to perform "spot repairs" for coatings, a team at Brookhaven developed an alternative coating method that could achieve the same grain morphology and coating stoichiometry as the CVR process. Thermochemical data indicate that high surface temperatures are necessary for the carbide formation to proceed. Since the region of carbon diffusion is small, however, bulk heating of the substrate is not required. In the coating process, the metal halide is decomposed by ultraviolet radiation while the surface is heated using an infrared laser. These photochemical conditions result in coatings that are effectively the same as high-temperature CVR coatings yet are made at lower overall substrate-coating temperatures.

Tantalum carbide was selected as

the model carbide for the development of the coating process. The basic experimental setup consisted of a gas-handling system for the TaCl_5 vapor and a deposition cell (see figure). The vapor was produced by heating solid TaCl_5 in a reservoir. The gas from the reservoir was throttled through a heated needle valve and ducted to the deposition cell, where it was directed onto the graphite sample through a nozzle.

The graphite sample was attached to a heated stage whose temperature could be varied between room temperature and 700 K. Light from a carbon dioxide laser was focused on the sample through a KBr window, and light from an excimer laser, a KrF operating at 248 nm, was admitted through a quartz window at an angle of 90° to the CO_2 beam. The KrF line was chosen because it is coincident with the absorption maximum of the TaCl_5 . A 3.5-W CW CO_2 laser focused to about 1 mm in diameter heated the graphite locally.

Deposition was accomplished with the platform at 573 K. At this temperature only minimal chloride was deposited. This was presumably due to thermal decomposition of the pentachloride at the surface, resulting in traces of a chloride of lower vapor pressure that condensed during the course of the experiment. The coincident irradiation of the gas-phase pentachloride stream with excimer light at 248 nm resulted in the production of a coating that contained both Ta and C. The UV flux density was on the order of 2 W/cm^2 as a result of irradiation with unfocused excimer light. The pulse energy was approximately 145 mJ per pulse and the pulse duration was on the order of 20 ns.

The results of this experiment, when compared with those of infrared irradiation alone, indicate that UV absorption by the TaCl_5 vapor is instrumental in allowing the carbide formation to proceed. The TaC film formed by this process is quite fine-grained (on the

Schematic of a **Deposition Cell**. A. Silica window; B. KBr window; C. TaCl_5 inlet nozzle; D. Graphite substrate; E. Heated sample pedestal; F. excimer laser beam; G. carbon dioxide laser beam.

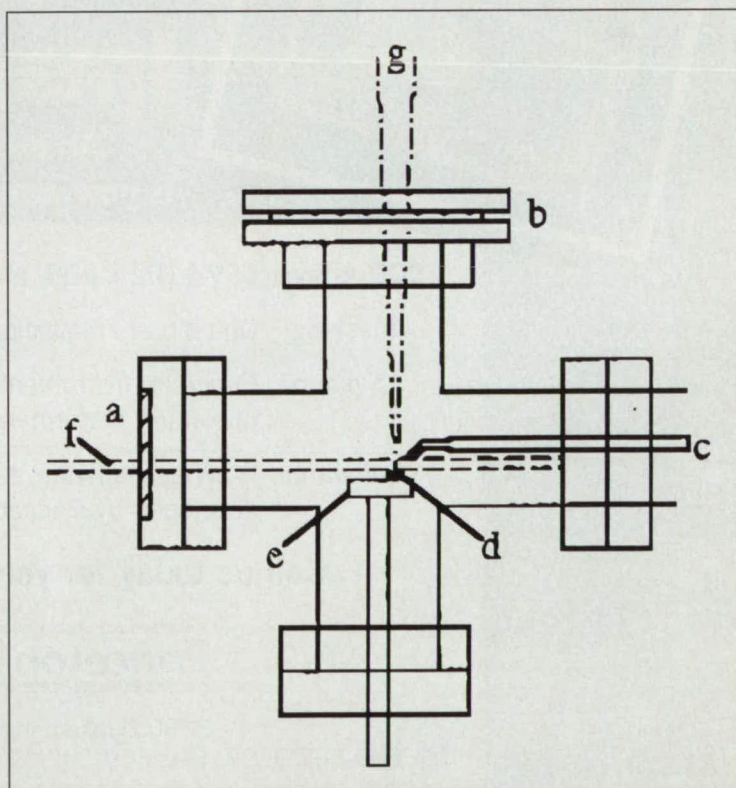

order of a few micrometers) and grows quite rapidly. The grain size of these initial coatings is much smaller than that seen in the TaC films produced by high-temperature CVR processes; however, coatings with thicknesses on the order of tens of microns can be readily deposited in a few minutes.

The results of the experiments performed to date indicate that it is possible to produce refractory metal carbides at very low substrate temperatures (less than 700 K), using a two-laser process. The photochemical process produces

carbides via a CVR-like reaction in which the carbon source is the substrate itself. This carbide formation reaction has been observed thermally only at temperatures nearly 2000 K higher. The UV photons in this carbide reaction give rise to dissociation of the halide reactant, while infrared photons cause heating of the immediate substrate surface. Work is planned to investigate the details of the process (photochemistry, photophysics, deposition rate, coating characteristics and hydrogen permeability, etc.), and it should be possible to extend the investi-

gations of this multiple laser coating process to other coating systems.

This work was done by R.E. Barletta, J. Veligdan, D. Branch, and P.E. Vanier of Brookhaven National Laboratory. For further information write in 143 on the Reader Information Request Card.

Inquiries concerning rights for the commercial use of this invention should be addressed to Margaret C. Bogosian, Deputy Manager, Brookhaven National Laboratory Office of Technology Transfer, Building 902-C, Upton, NY 11973; (516) 282-7338.

Etching Polymer Optical Waveguides with Atomic Beams

Smoother sidewalls can make the waveguides more efficient.

NASA's Jet Propulsion Laboratory, Pasadena, California

Directed beams of electrically neutral atoms would be used to etch smooth walls on polymer optical waveguides, according to a proposal. Conventional etching techniques like reactive ion etching, solvent etching, and ablation all result in rough sidewalls and undercutting of the masked areas that are not meant to be etched. Light scattered from rough walls leads to optical loss and thus reduced throughput.

In waveguide optical switches, such as directional couplers (see Figure 1), two waveguide channels are situated within a fraction of a micron to a few microns of each other to allow for coupling and transfer of optical energy. In order to achieve high-contrast switching, the coupling must be switched between two precisely defined values, e.g., with the use of an applied electric field. The precision of the coupling is limited by the

gap precision and the sidewall roughness. Thus, it would be ideal to fabricate the waveguide channels with smooth sidewalls and a gap that is maintained at a certain value with a high tolerance over a length of one to several centimeters.

The feasibility of the proposed atom-beam etching technique was tested by exposing a film of polyimide waveguide material (Amoco Ultradel, or equivalent) about $3\mu\text{m}$ thick to a beam of

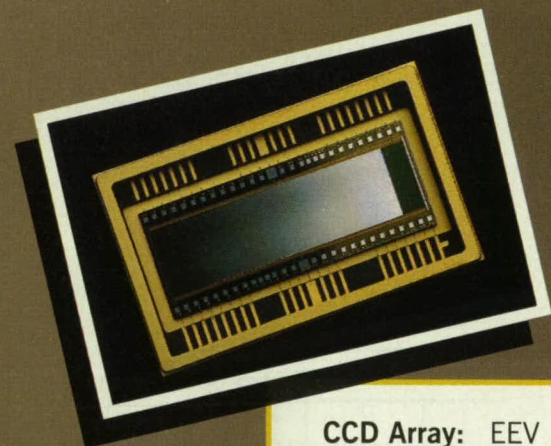

4,000 Frames/Second High Speed Imaging Systems

An exclusive high speed imaging system
is now available *only* from Princeton Instruments.

CCD Array: EEV 1152 x 298, imaging area 100 x 298.

Masking: On-chip aluminization, for precise separation of successive frames.

System: Princeton Instruments camera and controller software, offering maximum performance and minimum noise.

Software: WinView software, a Microsoft® Windows™ based application developed by Princeton Instruments.

Call us today for your complete imaging system.

Princeton Instruments, inc.

3660 Quakerbridge Road, Trenton, N.J. 08619
Tel: 609-587-9797 Fax: 609-587-1970 Call or write for the representative nearest you.

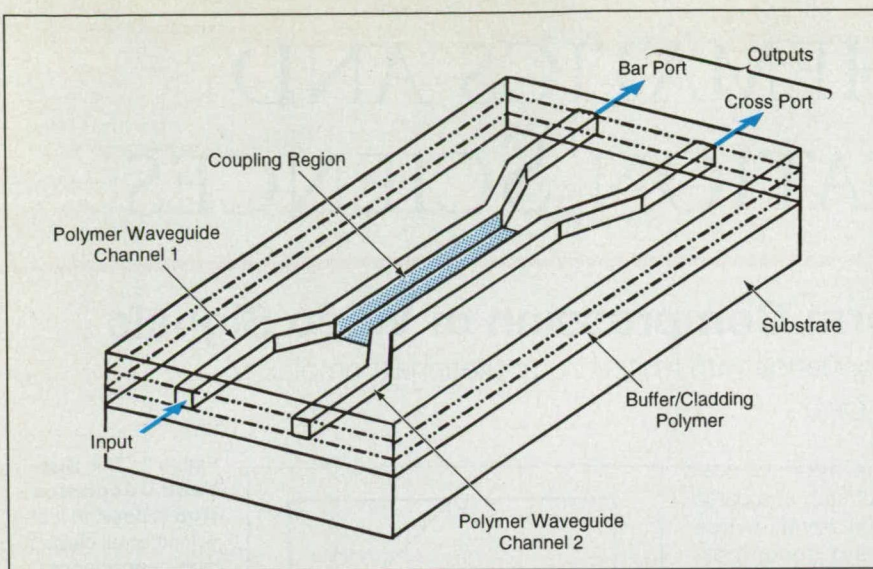

Figure 1. A **Polymer Waveguide Directional Coupler** is etched with atomic beams to attain the needed precision.

nominally 5 eV oxygen atoms until a fluence of 2.4×10^{20} atoms/cm² was accumulated. The beam was generated by a commercial fast-atom source capable of generating high-velocity atoms with translational energies in the range of 2 to 10 eV. The walls etched around a masked area by the beam (see Figure 2) appeared straight and smooth on a scale as small as 0.1 μ m. The O-atom fluence was high enough to etch about

7 μ m of the polyimide; however, the high overetch apparently had little negative effect on the straightness or smoothness of the sidewalls.

This work was done by Timothy K. Minton and Joseph W. Perry of Caltech for NASA's Jet Propulsion Laboratory. For further information write in 144 on the Reader Information Request Card. NPO-19121



Figure 2. The **Scanning Electron Micrographs** show two views of the sidewall of a mesa etched around a masked area by an atomic beam incident a few degrees off perpendicular from the surface. The bottom panel is an enlarged view of the lower right region of the same sidewall that is seen in the top panel. The fluted appearance of the wall is attributed to the rough edge of the mask.

Over 8,000 Optical Products OFF-THE-SHELF OPTICS

Edmund Scientific
1984 Annual Reference Catalog
For Optics, Science And Education

OFF-THE-SHELF OPTICS & COMPONENTS
FOR OEM AND RESEARCH APPLICATIONS

America's Largest Selection of Optics and Optical Components

- OEM Optics
- Optical Systems
- Video Systems
- Imaging Systems
- Positioning Equipment
- Machine Vision
- Critical Measuring
- Lasers, Laser Optics
- Electro Optics
- Magnifiers
- Comparators
- Microscopes
- Telescopes

1-800-573-6250
FAX 1-609-573-6250

Optical reference catalog featuring optics and optical instruments used in industry, science and research.

Write or call for 236 page full color catalog, complete with technical data and prices.



Edmund Scientific Co.

Dept 14B1, N952 Edscorp Bldg., Barrington, NJ 08007
PHONE: 1-609-573-6250 FAX: 1-609-573-6295

For More Information Write In No. 304

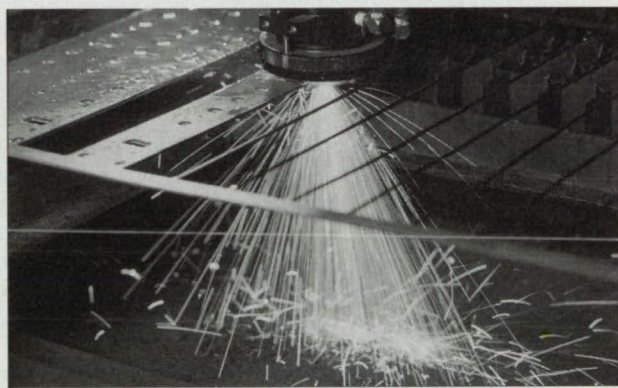

Focus in on Optimum Laser Performance

A Koolant Coolers system will dissipate heat output from the discharge tube at the optimum rate required by the laser manufacturer, with fluctuations as small as $\pm 1^\circ\text{F}$ ($\pm 0.56^\circ\text{C}$), if required--even in a rugged production environment. Call or write for a free brochure.

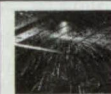

Achieving
Optimum Laser
Performance



Manufactures of
Industrial/Liquid Coolers since 1950
KOOLANT COOLERS, INC.
2625 Emerald Drive • Kalamazoo, Michigan 49001-4542

616-349-6800
FAX 616-349-8951
1-800-YOU-KOOL

For More Information Write In No. 425

MATHEMATICS AND INFORMATION SCIENCES

Subband and Transform Compression of Video Signals

Hierarchical coders offer good performance with limited computational complexity.

Lewis Research Center, Cleveland, Ohio

A class of hierarchical subband coders is being developed primarily for compression of image data at video rates. These coders offer good performance with limited computational complexity and with the flexibility inherent in subband decomposition.

The particular subband decomposition chosen for these coders appears to hide large quantitative errors effectively, largely because this decomposition occurs along two-dimensional spatial-frequency-domain boundaries that resemble the spatial-frequency-domain curves of constant sensitivity of the human visual system. These curves have been found to be approximately diamond-shaped: thus, low-pass filtering for reduction of data ideally involves nonrectangular passbands.

The concept of decomposition along diamond-shaped boundaries is implemented in a subband coder that is a precursor to the present coders. This coder low-pass filters each image, followed by a two-subband decomposition of the remaining image, as shown in Figure 1. The diamond-shaped passband enables a quincunx downsampling of the original image, with an immediate reduction of sampling density by a factor of 2. The quincunx image is subjected to one further spatial-frequency-band separation, with the lowest band coded by the discrete cosine transform.

If high-resolution imagery is to be available to devices that have widely varying sampling rates, transmitted through channels of varying capacities, it may be necessary to band-limit a given image at several levels. Inasmuch as the diamond-shaped sensitivity contours hold over a broad range of spatial frequencies, it appears desirable to have available a hierarchy (symbolically, a pyramid) of spatial-frequency subbands. This is also true for temporally adaptive three-dimensional coding of image sequences. The form of the proposed decomposition is simply a generalization of that in Figure 1, with the inner square further decomposed recursively. While

the pyramid need not stop at a particular level, a five-band decomposition has been found to be adequate for purposes of initial development.

The decomposition process can be understood by considering the transition from one level of the pyramid to one other. By limiting the image to the diamond-shaped band in the two-dimensional spatial-frequency domain, one can produce two images, the sum of which is the original image. Each of the resulting images is sampled at a rate equivalent to twice the necessary density (see Figure 2). Provided aliasing is excluded, each image can be decimated by a factor of 2 in a quincunx pattern. Should one wish to recombine to recover the original image, each subband can be interpolated to the original sampling rate and bandpass filtered before summing. Even when some aliasing exists in the decimated images, perfect-reconstruction filter banks can cancel aliasing and thus cancel errors in the final result.

The two quincunx-sampled subband images can be thought of as being represented in the spatial-frequency domain on a rectangular grid rotated by 45° from the original. In this orientation, one can think of again low-pass filtering the low-frequency image to separate bands as at the first level. The resulting decimated low-pass image is then sampled on a rectangular grid with decima-

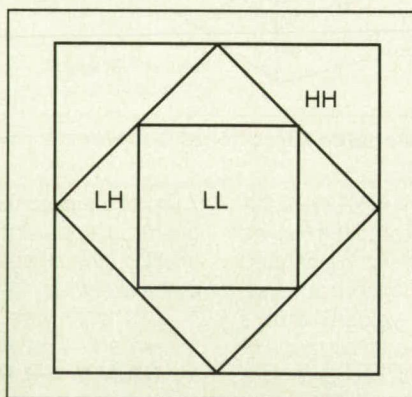

Figure 1. This **Subband Decomposition** is basic to a developmental class of high-performance, computationally efficient coders. The letters "H" and "L" denote subbands in the two-dimensional spatial frequency domain that contain various high- and low-spatial-frequency components, respectively.

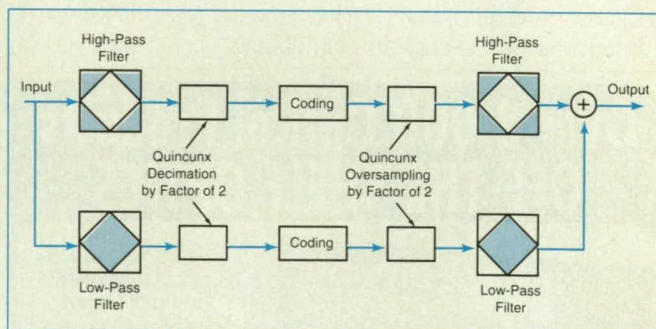

Figure 2. This **Single Stage of Decomposition** according to diamond-shaped subbands, shown here schematically, is one of several in the pyramidal coding scheme described in the text.

tion by a factor of 2 in each coordinate relative to the original. This process can be continued in a pyramid fashion, with successive low-pass images of smaller size, alternating between rectangular and quincunx grids.

One experimental pyramidal non-rectangular-subband coder of this type appears to perform well at intraframe bit rates of about 1.0 to 1.5 bits/pixel for color imagery. These rates would enable transmission of high-density television images at about 30 to 45 megabits/second by use of relatively inexpensive equipment.

This work was done by Ken Sauer and Peter Bauer of the University of Notre Dame for **Lewis Research Center**. For further information, write in **145** on the Reader Information Request Card. LEW-15732

LIFE SCIENCES

Intraocular Laser Surgical Probe

A probe is being developed to cut tissue deep within the human eye.

Armstrong Laboratory, Brooks Air Force Base, Texas

An intraocular laser surgical probe (ILSP) is being developed to cut collagen tissue that forms in patients with proliferative diabetic retinopathy. The tissue is currently cut from the eye with mechanical cutting tools that can cause retinal detachments or other damage to the retina via shearing and traction forces. ILSP will use sharply focused light to cut the membrane and insure widely divergent light posterior to the target cutting site to prevent damage to the retina itself.

The damage mechanism used for cutting with this probe is laser-induced breakdown (LIB), the ionization of water molecules to form a plasma spark due to high irradiances. Currently, LIB is used in many tissue ablation surgeries, including iridotomies, capsulotomies, and surgery to break up mem-

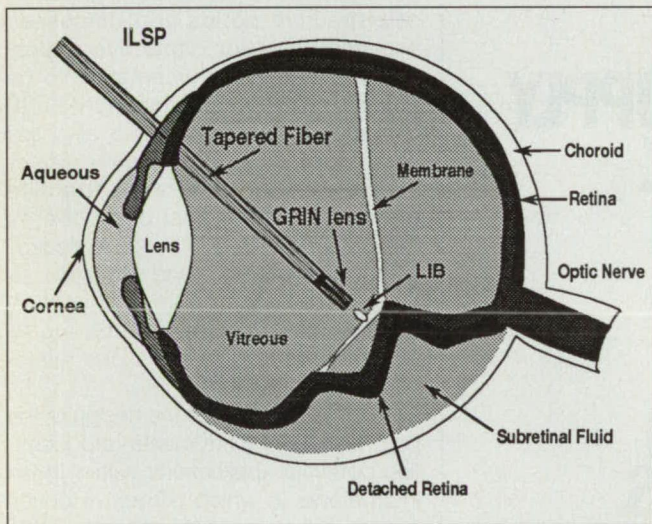

The **Intraocular Laser Surgical Probe** is inserted into the eye to cut membranes that are attached to the retina.

branes in the anterior portion of the eye. These technologies involve noninvasive techniques of focusing light from a source external to the eye with a contact lens placed on the cornea. ILSP is the first application of LIB deep within the posterior portion of the eye.

ILSP has a simple design of a special tapered fiber with a small cylindrical gradient index (GRIN) lens attached to it. The tapered fiber has a larger input diameter than output diameter. The reasons for using a tapered fiber are twofold. First, the large input diameter allows a large amount of energy to be launched into the fiber. Second, the small output diameter allows the GRIN lens to focus the light to the very small spot sizes required for breakdown.

The GRIN lens focuses light in a manner different from a conventional lens. Instead of using the curvature of the glass to

TEN REASONS WHY NEAR-IR VIEWER USERS PREFER FIND-R-SCOPES®!

The **FIND-R-SCOPE®** 84499 Series are the most widely used infrared viewers. **WHY?**

1. Sensitivity from 350nm to 1550nm
2. High resolution and low cost
3. Easily replaceable parts
4. 18 month warranty
5. Custom optics
6. UL listed
7. Tripod mountable
8. Free carrying case
9. Hand-held portability
10. Technical service available



Call our **TECHNICAL SALES GROUP** at 1-800-355-4FJW for more information.

FJW OPTICAL SYSTEMS, INC
629 VERMONT STREET
PALATINE, ILLINOIS 60067
PHONE: (708) 358-2500
FAX: (708) 358-2533



FIND-R-SCOPE®
Infrared Viewing

For More Information Write In No. 414

Tunable Dye Lasers at Moderate Cost

>High Energy: SLL Series to 30 J/pulse.

>High Power:
LFDL Series
to 50 Watts.



>Tunable Ultraviolet:
UV Series to 1 J/pulse.

Wavelength Meter



LS Series:
Accurate,
User friendly.

Cynosure, Inc.

Filling Flashlamp Excited Dye Laser Needs since 1970
35 Wiggins Ave., Bedford, MA 01730 Tel: (800) 886-2966 FAX: (617) 275-5449

For More Information Write In No. 318

bend the incident light rays, the GRIN lens has a graded index of refraction radially from the optical axis. Therefore, the index of refraction is highest in the center of the lens and decreases as you move outward. The GRIN lens is used because the probe needs to be very small and because the light needs to be focused very close to the tip of the probe (i.e., small working distance). Other methods of focusing light from a fiber, such as shaping the fiber tip with a CO₂ laser or placing a small spherical lens on the end of a fiber, are insufficient to achieve small enough spot sizes at the proper distance from the tip of the probe.

ILSP is being tested with a Q-switched Nd:YAG laser that operates at 1064 nm at a pulse duration of approximately 10 ns. However, the probe may be modified to be used with different lasers at different wavelengths.

The preliminary designs for the probe are being tested at Armstrong Laboratory and a prototype is expected by summer 1995. The technology will then proceed to in-vivo animal testing, FDA approval for human testing, and finally human tests.

ILSP technology has great potential to revolutionize eye surgery. In addition, the application of this technology may extend to other areas of the body where

the breakup of tissue is required.

This work was done by Lt. Daniel X. Hammer of Armstrong Laboratory, and Dr. Cynthia Toth of Duke University, as well as others from Armstrong Laboratory, Duke University, and Wilford Hall Medical Center. For further information, write in 146 on the Reader Information Request Card.

Inquiries concerning rights for the commercial use of this invention should be addressed to Dean Knisely, TASC, 750 E Mulberry Suite 302, San Antonio, TX 78212. (210) 536-3709. Refer to AF21422.

BOOKS AND REPORTS

Diffraction Optics for Geostationary Earth Observatory

A report reviews the basic principles of diffractive optics and discusses potential uses for diffractive optical components in instrumentation to be flown in NASA's Geostationary Earth Observatory (GEO). Of course, all optics are unavoidably at least slightly diffractive, but as used here, "diffractive optics" means optical components designed specifically to exploit electromagnetic interference and diffraction, as distinguished from conventional optical components designed according to principles of ray tracing to exploit refraction and/or reflection.

The report analyzes the design of the proposed GEO instruments and identifies potential applications within those instruments in which diffractive optics could improve performance while reducing weight and cost. These applications include the use of hybrid diffractive/refractive lenses in aft-optic imagers, and diffractive components that compensate for aberrations in reflecting imaging systems and in grating spectrometers.

This work was done by G. Michael Morris, Robert L. Michaels, and Dean Faklis of Rochester Photonics Corp. for Marshall Space Flight Center. To obtain a copy of the report, "Diffractive Optics Technology and the NASA Geostationary Earth Observatory (GEO)," write in 147 on the Reader Information Request Card. MFS-27290

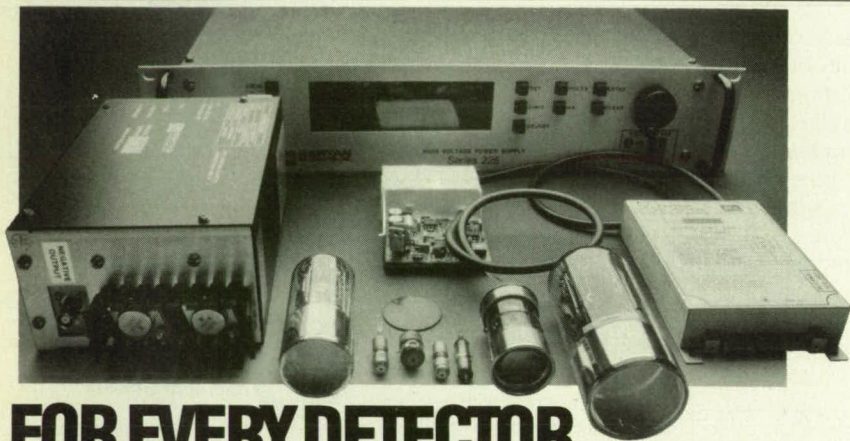

FOR EVERY DETECTOR, A HIGH VOLTAGE POWER SUPPLY THAT MATCHES PERFECTLY.

Bertan is the world leader in detector high voltage power supplies and can meet virtually every detector requirement, from lab to OEM. We can give you everything from regulated modules that are as inexpensive as unregulated supplies, to highly regulated instruments. Whichever you choose, you can be sure you're using the industry's standard for performance and reliability. In fact, we have MTBF success stories that others only dream about.

What's your application?

Photomultiplier tubes, proportional counters, avalanche photo diodes? Microchannel plates, channel electron multipliers or image intensifiers? Call Bertan because nobody knows high voltage power supplies like Bertan. Our units are being used across the board in research and industry. This unparalleled experience means that our people can help you get the best match of power supply to detector application. Ask for our free 102 page reference manual and catalog, "High Voltage Power Supply Solutions." Call or write. Toll free: **800-966-2776**.

In NY: 516-433-3110. Fax: 516-935-1766. Bertan High Voltage, Hicksville, NY 11801.

THE MATCH MAKERS.



BERTAN™

THE HIGH VOLTAGE PEOPLE™

For More Information Write In No. 309

See us at Accelerator Conf. 11/7-11/9 Denton, TX

NEW PRODUCT SHOWCASE

Big Sky Laser introduces an **optical parametric oscillator** utilizing KTP that converts the 1064-nm fundamental of the Nd:YAG laser to about 1570 nm, thus making it eyesafe. The company sees applications for these and other OPOs in laser ranging, lidar, illumination, and industrial sensing. The OPO is available as an attachment to Big Sky's CFR 200 Nd:YAG laser system. The company can custom design OPOs using KTA and other crystals as well.

For More Information Write In No. 701

Meadowlark Optics offers a new line of **polymer half-wave and quarter-wave retarders**, called the Performance Retarders, that are available with extremely accurate retardance values. Each retarder is individually mounted in a black-anodized aluminum housing with the fast axis clearly indicated. They are available off the shelf for the common laser wavelengths at 514.5, 632.8, 850 and 1064 nm.

For More Information Write In No. 702



New from Schott Glass Technologies is S-8612 **color filter glass** for night-vision and other display applications. S-8612 exhibits peak transmission of 90 percent at 500 nm and less than 2 percent at 700 nm. Coefficient of thermal expansion is 96×10^{-7} between 20-300 °C. The glass comes in stock sizes of 165.1-mm squares, and standard thickness is 3-4 mm.

For More Information Write In No. 703

The Maxim•GP **3D surface profiler** from Zygo Corp. can measure polymers, polished and lapped metals, glass materials, ceramics, silicon,



and many more surfaces. Lateral image resolution is $<0.5 \mu\text{m}$ and measurement areas are up to 4.5 mm square. Vertical surface profile resolution is less than 1 angstrom, and range is 10 μm . Zygo says that its MetroPro™ surface analysis software combines powerful surface data acquisition control with an easy-to-use windowing interface.

For More Information Write In No. 704

Scientific Computing International (SCI) announces "Film Wizard," its new **software program for optical thin-film design** and materials characterization. Its three global optimization techniques avoid local minima, and it permits constrained or unconstrained optimization. The program allows multiangle and multiwavelength analysis of spectrophotometric and ellipsometric data determine to determine thicknesses and indices of deposited layers.

For More Information Write In No. 705

Aerotech makes available the LZ3000 **laser interferometer system** for measurement, calibration, and position feedback applications. Resolution is to 0.6 nm and accuracy from 10 ppm uncompensated to 0.1 ppm in vacuum. Workpiece speeds can be 1 m/sec over a 10-m range even at submicron resolutions. The system consists of a laser head with patented beam frequency stabilization, a PC-based processor board with Windows-hosted software, and linear interferometer and retroreflector modules. Optionally available are environmental and material temperature sensor subsystems.

For More Information Write In No. 706

LASER DIODE OPTICS

When your application demands high quality laser diode optics, think of Optima. Our 336 Series collimating lenses have been used in space systems and in more down-to-earth applications like bar code readers, laser pointers, and smoke detectors.

Whether you need a custom assembly or just an off-the-shelf component, we'd like you to consider Optima. Please ask for our catalog covering the following items:

- COLLIMATED DIODE LASERS, VISIBLE THRU NEAR-INFRARED
- LASER DIODE MOUNTING KITS
- COLLIMATING AND OBJECTIVE LENSES -- GLASS OR PLASTIC
- SINGLETs, DOUBLETs AND ACHROMATs
- ANAMORPHIC PRISMS
- OPTICAL FLATS -- MIRRORs, BEAMSPLITTERs, FILTERs
- DIFFRACTION GRATINGS
- ASPHEIC LINE GENERATOR LENSES



OPTIMA

OPTIMA PRECISION INC., 775 SW LONG FARM ROAD, WEST LINN, OREGON 97068

PHONE: (503) 638-2525

OUTSIDE OREGON: (800) 544-4118

FAX: (503) 638-4545

For More Information Write In No. 320

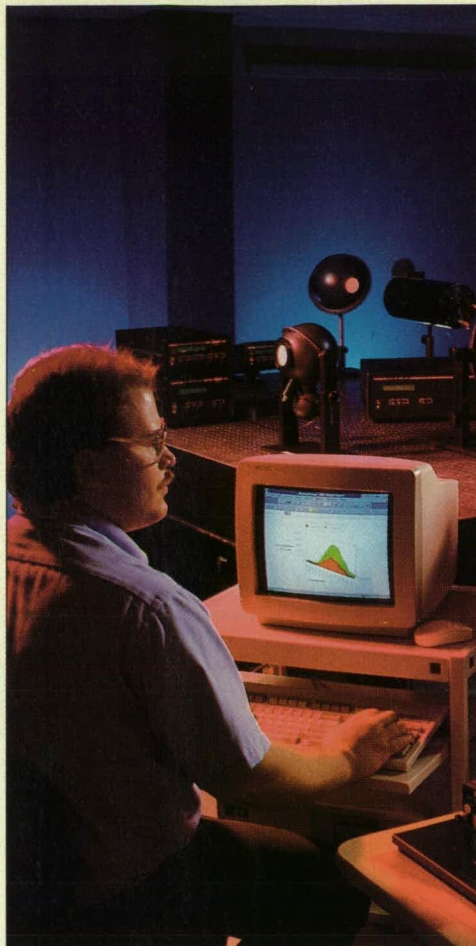

Integrating Sphere

REFLECTANCE/ TRANSMITTANCE SYSTEMS

Labsphere offers a complete line of Reflectance/Transmittance Integrating Sphere Systems designed for highly accurate measurements of a variety of materials. The systems are designed to meet ISO, ASTM and CIE specifications for the measurement of:

- Luminous Reflectance/Transmittance
- Laser Reflectance
- Total Integrated Scatter
- Spectral Analysis
- Haze

labsphere

P.O. Box 70
North Sutton, NH 03260
Tel: 603-927-4266
Fax: 603-927-4694

For More Information Write In No. 413

FREE: QUARTZ CRYSTAL HEADS AND FEEDTHROUGHS*

(No, you're not dreaming. Please read on!)

If you use quartz crystals to monitor your thin film coating processes, you've just discovered the best source for industry standard 5 and 6 MHz crystals and stainless steel hardware in the USA!

Cold Springs R&D carries a full line of quartz crystals for your Inficon, Sycon, Intellimetrics, Balzers and Sloan monitors. We also make stainless steel crystal heads (dual and single), feedthroughs (1" and flanged types), crystal head cables and replacement parts. And to top it off, we will build or repair just about any quartz crystal related item. (All quotes are free of charge).

Call us today at 1-800-798-COLD (1-315-673-3714 outside the US) or fax us at 1-315-673-3766. Stretch your R&D dollars by saving with us!

*Oh, the free part. With every order of 1000 quartz crystals (new or recoated) we will ship you either a single 6 MHz crystal head or 1" bolt crystal head feedthrough. All hardware is constructed of 304SS, fully leak tested and carries a 1 year warranty. Crystals can be purchased over 1 year to reach the 1000 piece level.

Cold Springs R&D

19 South Street
Marcellus, NY 13108

Inficon, Sycon, Intellimetrics, Balzers, and Sloan are trademarks of their respective owners.

MADE IN USA

For More Information Write In No. 319



CHECK US OUT...

FOR COST EFFECTIVE
PROTOTYPING AND SMALL
VOLUME PRODUCTION

Total foundry service for custom Diffractive Optics Elements

- Microlens Arrays
- Beam Splitting
- Beam Shaping
- Binary Gratings
- On / off axis lens
- Phase Masks

Call today to discuss your
application

QPS Technology Inc.

Tel: (514) 695 7690 • Fax: (514) 695 2401
email: info@qpstech.ca

For More Information Write In No. 680

Hewlett-Packard Corp. introduces what it calls the first production **fiber amplifier** that operates in the 1300-nm transmission window, an optical wavelength used for cable-television trunk and other multikilometer fiber optic communication systems. The praseodymium-doped PFA 1000 is capable of +17 dBm optical output power and greater than 30 dB small-signal gain. Pump power is generated by a compact Nd:YAG laser. The unit can also be used in research for four-wave mixing, and to amplify the output of 1300-nm tunable ring lasers.

For More Information Write In No. 707

Honeywell's Micro Switch Division is offering the HLC1395 Series **miniature reflective sensor**, an IR sensor designed to detect objects at short distances. The HLC1395-001 has a minimum of 0.30 mA on-state collector current, and the HLC1395-002 is specified at 0.60 mA. Operating temperature range is -40-85 °C. Both models are available from stock, and price is less than \$0.90 in quantities of 50,000.

For More Information Write In No. 708

Raytek announces Thermalert Compact Infrared **microelectronic pyrometers**, a non-contact sensor about the size of a roll of dimes. In a threaded stainless steel cylinder, the unit covers 0-500 °C to within 2 percent accuracy,



and has a measurement response time of 300 ms. Spectral response is 7-18 microns and optical ratio is 5:1. Output is either J or K thermocouple (50 ohms) substitute, or an optional linear proportional voltage range (10mV/°C).

For More Information Write In No. 709

Physical Optics Corp. says its new **light diffuser**, based on holographic technology, has unusually efficient light shaping and transmission characteristics. Called Light Shaping Diffusers (LSDs), the devices are surface-relief holograms available in a variety of substrates. LSDs are not wavelength-sensitive, but diffuse light throughout the visible spectrum. The company says they perform extremely well in white light from any source, including fluorescents, filament lamps, LEDs, tungsten halogen lamps, and arc lamps.

For More Information Write In No. 710

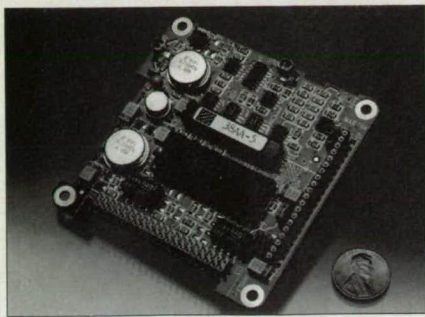

Dalsa adds a new 12-bit high-speed **video digitizing** option for its standard camera products. The analog-to-digital board, designated X354, features correlated double sampling video processing for higher dynamic range without cooling. Pixel rates range from 1.7 to 10 Mpixels/sec. Gain can be adjusted from 1X-10X with the low-gain version of the board, and 10X-50X with the high-gain version.

For More Information Write In No. 711

Brimrose Corp. of America announces a new series of bulk **fiber optically pigtailed acousto-**

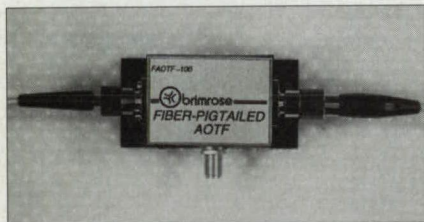

optic tunable filters. They offer resolution of 1.0-1.5 nm over the wavelength range of 1200-1700 nm. Total insertion loss is less than 4.0 dB. They are available with FC/PC or custom connectors. Computer interface drivers include parallel port and serial port (RS-232) and AT synthesizer card RF drivers.

For More Information Write In No. 712

New from Rodenstock Precision Optics is a line of **CCD camera lenses** for 1/3", 1/2", and 2/3" formats. The company says the lenses offer high resolution, excellent contrast, and almost distortion-free performance. Magnification range is from 0.1x to 18x onto the CCD. A C-mount focusing unit from Rodenstock enables the use of the company's high-resolution enlarging lenses with CCD cameras.

For More Information Write In No. 713

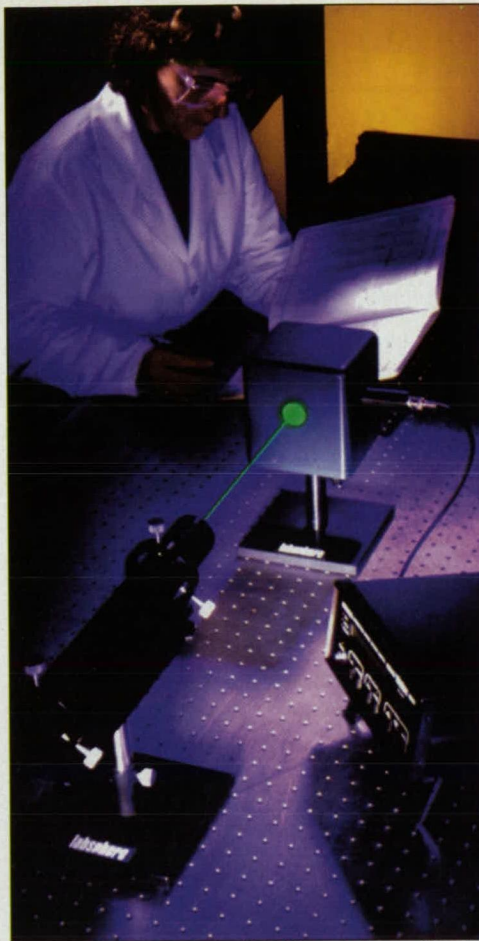

Integrating Sphere

LASER POWER MEASUREMENT SYSTEMS

Labsphere precision optical Laser Power Measurement Systems are designed to measure the total output power of lasers and laser diodes over the wavelength range of 0.25 - 26µm. Integrating sphere technology allows for accurate, repeatable measurements without involved positioning and alignment procedures.

Laser Power Measurement System options include:

- UV-VIS Measurement
- NIR-IR Measurement
- Spectral Measurement

labsphere

P.O. Box 70
North Sutton, NH 03260
Tel: 603-927-4266
Fax: 603-927-4694

For More Information Write In No. 412

LIGHT CONTROL PRODUCTS

Liquid crystal products for your light control needs

- Light valves, spatial light modulators with phase-only capability
- Shutters and attenuators for various speed and aperture needs
- Polarization control, including liquid crystal polarizers and rotators

Micro-Optics Technologies is your source of liquid crystal light control products—stock or custom.

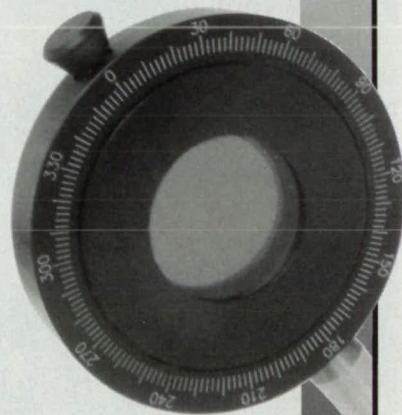

MICRO-OPTICS
TECHNOLOGIES, INC.

MICRO-OPTICS TECHNOLOGIES, INC.

8606 University Green #5
P.O. Box 620377
Middleton, WI 53562
608-831-0655
FAX 608-831-5821

For More Information Write In No. 421

NEW LITERATURE

Optical Research Associates offers an 8-page full-color brochure describing its CODE V™ optical design and analysis software. Capabilities of the program include lens entry and editing, diagnostic analysis options, image evaluation options, fabrication and miscellaneous options. The company says its Global Synthesis optimization tool for lens design can handle constrained optimization problems of 60 variables or more.

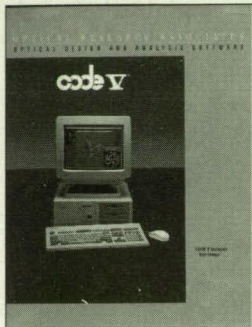

For More Information Write In No. 400

Available from Electro-Optic Systems Inc. are a series of specification sheets on its detector components, specialty detectors, electronics, accessories, and engineering services. The company can make single- and

multielement assemblies from silicon, germanium, InGaAs, ZnSe, ZnS, InAs, InSb, and HgCdTe for ambient, TE and cryogenic operation.

For More Information Write In No. 401

Spectrex Inc. offers a full-color specification sheet on its new optical flame detector, the SharpEye™ 20/20I. The UV/IR detector operates on three different spectral bands: within CO₂, outside CO₂, and over a background broad band. Each source has its own IR spectral signature, producing different signals at each source, thus distinguishing between a fire scenario and interfering infra-red stimuli.

For More Information Write In No. 402

SPECTREX INC. IR[®] Flame Detector SharpEye 20/20I

High Spectral Range
Narrow Bandwidth
Low Programmable Configuration
Rapid Response Time
Automatic and Manual Mode On/Off
Nighttime/Daytime
Modular and Compact
NEMA 4X Mounting
FM, CSA and UL/ULC Approval
1. 20/20I and 20/20I are not to be used in the presence of flammable and/or explosive atmospheres.
2. 20/20I and 20/20I are not to be used in the presence of dust or dirt.
3. 20/20I and 20/20I are not to be used in the presence of steam or smoke.
4. 20/20I and 20/20I are not to be used in the presence of high humidity.
5. 20/20I and 20/20I are not to be used in the presence of high temperature.
6. 20/20I and 20/20I are not to be used in the presence of high pressure.
7. 20/20I and 20/20I are not to be used in the presence of high vibration.
8. 20/20I and 20/20I are not to be used in the presence of high shock.
9. 20/20I and 20/20I are not to be used in the presence of high impact.
10. 20/20I and 20/20I are not to be used in the presence of high acceleration.

Aerotech's new **Electro-Optics Product Guide** provides technical and design data for the company's extensive lines of linear and rotary manual positioners, gimbal optical mounts, and green and red HeNe lasers and laser power supplies. Among new products included are the LZR3000 laser interferometer position measurement system, the SL series of lightweight breadboards, and others.

For More Information Write In No. 403

A new handbook from Philips Photonics describes the principles and applications of **photomultiplier tubes**. Construction, operating characteristics and considerations, supply and operating advice and nonscintillator applications are among the topics covered.

For More Information Write In No. 404



Uncommon Versatility in Imaging Boards & Software

Now... up to 256 MBYTE Image Memory

Expansion Board Accepts up to 256 MBytes of Configurable Image Memory

64 Mbyte Image Memory
On-Board DSP
50 MHz A-D

4MEG VIDEO™ Model 12

- 50MHz to 2MHz Sampling & Display Rate
- RS-170, CCIR Capture & Display
- Non-Standard Area & Line Scan Interface
- Analog & Digital Inputs
- 256 MByte to 4 MByte Image Memory
- 12 MIPS Programmable Image Accelerator

SILICON VIDEO® MUX™

- 40MHz to 2MHz Sampling & Display Rate
- 8000 to 8 Pixels per Line
- Composite Sync or H, V, Pixel Clock
- 6 Input Video Multiplexer
- 4 MByte or 1 MByte Configurable Memory

VERSATILE SOFTWARE

- Menu Driven Processing & Analysis
- "C" Object Code for DOS & Windows
- Extensive Image Processing Library
- Programmable Video Formats
- Unlimited Applications:

Medical Imaging
Image Analysis
Motion Capture

Machine Vision
Document Imaging
Quality Inspection

EPIX® Call or fax for specifications!

Image Processing Products for Research and Industry
EPIX' products are designed and manufactured in the United States of America.
EPIX, Inc. - 381 Lexington Drive, Buffalo Grove, IL 60089 USA - 708 465 1818 Fax 708 465 1919

INDUSTRY LEADERS

Profiles of Pathsetting Companies In The Photonics Field

II-VI Inc.

SPECIALISTS IN INFRARED TECHNOLOGY

II-VI Incorporated is a fully integrated manufacturer of infrared materials, optics, optical components and assemblies, optical systems, and electro-optic products.

Founded in 1971, II-VI today employs over 200 infrared specialists at facilities in Saxonburg, PA, and Singapore.

The II-VI product line includes a complete range of infrared products and services for industrial, commercial, medical, military, and research lasers, covering the 2.0-20 micron range. Vertical integration, from IR materials to finished optics, has enabled II-VI to produce infrared products with superior quality, consistency, and reliability, the cornerstones of II-VI's recognized leadership throughout the IR industry. Consistent quality and customer satisfaction are made possible by the energy and dedication of our employees, over 30 percent of whom are scientists, engineers, and technicians.

The II-VI commitment to a total-quality approach for meeting customer requirements and specifications has enabled us to develop long-term relationships with the leading manu-

facturers of high-power CO₂ lasers worldwide.

Recent new product introductions include: off-axis parabolic mirrors for diffraction-limited perfor-

mance; ATFR beam-delivery mirrors to prevent unwanted reflections from re-entering the laser cavity; all-reflective beam expanders for broadband applications where reflective designs are not practical; and motorized beam expanders for dynamic control of the laser-beam size in flying optic systems.

Contact: II-VI Incorporated, 375 Saxonburg Blvd., Saxonburg, PA 16056; Tel. (412) 352-1504, Fax (412) 352-4980.



For More Information Write In No. 590

GENERAL SCANNING, INC.

HIGH-PERFORMANCE LASER-BEAM POSITIONING

Located just outside of Boston, Massachusetts, the Optics Business Unit of General Scanning has been developing high-quality OEM laser beam-positioning components and subsys-

tems since 1968. With products being used in over 100 different markets, the Optics Business Unit consists of four product/market groups structured to penetrate and support specific markets and applications. These groups are the Military/Aerospace, Medical, GMAX (General Scanning Multi-Axis Systems) and Components Products Group. General Scanning has offices located worldwide as part of its commitment to supporting its customers. The adjoining picture illustrates only a few of the different products that are used in applications such as FLIR (Forward Looking InfraRed), microscopy, laser micromachining and laser output to film and plate.

Contact: Sharon Mooney, General Scanning, Inc., 500 Arsenal Street, Watertown, MA 02172. Tel: 617-924-1010 x247; Fax: 617-924-7250

For More Information Write In No. 591

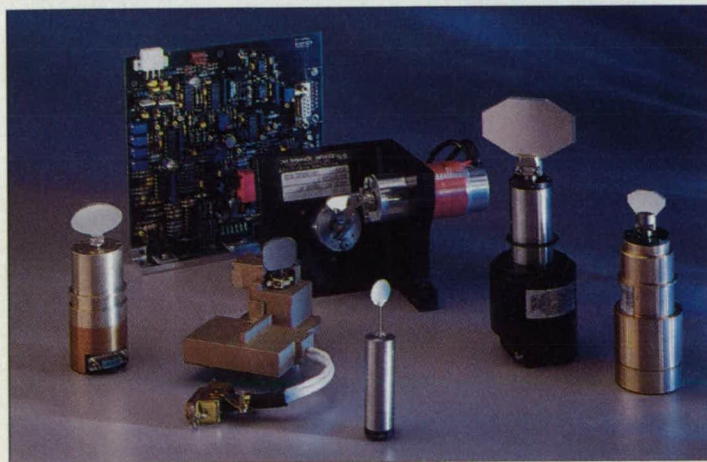

DAVID SARNOFF RESEARCH CENTER

PARTNERS FOR INDUSTRY AND GOVERNMENT IN ADVANCED PRODUCT DEVELOPMENT

The David Sarnoff Research Center, a subsidiary of SRI International, conducts research in consumer electronics, solid-state physics, materials science, and communications.

Sarnoff is a client-supported facility with expertise in software and digital IC design, process and materials research, digital signal processing hardware and software, electromechanical devices, and displays. This expertise is applied to projects for both commercial and government customers.

Many of the major advances in electronics during the past 50 years have been pioneered at the David Sarnoff Research Center in Princeton. Originally it was established as RCA Laboratories, but after RCA was sold to General Electric in 1986, the Sarnoff Center became part of SRI International, in Menlo Park, CA. Developments made at Sarnoff include color television, high-speed computer memories, injection lasers, liquid crystal technology, solid state amplifiers for satellite communications, MOS transistors and logic arrays, and optical and capacitive video disc systems.

To be competitive in the Information Age, Sarnoff is finding new and different ways to "partner" with clients to leverage resources and maximize benefits. Rather than adhere to one narrowly defined business model, Sarnoff's approach is to be flexible and to add value to product development.

Examples of partnering efforts include continuing partici-

pation in the Grand Alliance, which is developing a system for HDTV; membership in the Phosphor Technology Center of Excellence, bringing together academia, government, and industry to develop advanced phosphor technology; and being a founding member of the Consortium for Educational Process and Technology to develop collaborative and long-distance learning techniques.

Sarnoff is also commercializing some of its own technologies through new spin-out companies. SENSAR, the first spin-out, was introduced in 1992 to commercialize computer vision hardware and software, and now offers three products.

For more information, please contact Cynthia S. Gray, Manager, Media Relations, David Sarnoff Research Center, CN 5300, Princeton, NJ 08543-5300. Tel: 609-734-3038; Fax 609-734-2870. **For More Information Write In No. 592**



The David Sarnoff Research Center offers a full line of visible and infrared detectors and cameras, as well as III-V semiconductor components.

EG&G HEIMANN

GLOBAL MARKETER AND MANUFACTURER

Heimann was founded more than 40 years ago as a research enterprise pioneering imaging technology into the television market. In 1950, the Resiston™ was developed in parallel with RCA's Vidicon to become the first truly compact and efficient electronic camera tube. These and other special high-definition camera tubes manufactured by Heimann offer proven performance in the most sophisticated medical instruments as well as in other high-resolution imaging applications.

Today, EG&G Heimann Optoelectronics is a high-volume global marketer and manufacturer of flashlamps, camera tubes, IR sensors and large-area imagers. Corporate headquarters and manufacturing are located in Wiesbaden, Germany. The company also operates three additional ISO 9001-approved manufacturing sites in Singapore, Shenzhen (China), and Batam (Indonesia). As a worldwide competitor, Heimann Optoelectronics maintains its entrepreneurial spirit and its commitment to consistent product quality, on-time delivery and responsive customer service.

The company's infrared products include pyroelectric and thermopile sensors that are widely used in intrusion alarm, gas analysis, energy management, and other temperature measure-

ment applications. Heimann is also a recognized leader in the flashtube industry with applications in photography, warning beacons, strobes, and airport and aircraft lighting. The lamp products feature high power density, color-corrective coatings, high reliability and predictable life.

As sensor and imaging applications in markets such as the medical, automotive, and industrial create an ever-increasing demand for new products, ongoing research and development efforts at Heimann are focused on expanding its opto technology into other product areas, including micro-machined accelerometers and amor-

phous silicon large-area sensors.

EG&G Heimann Optoelectronics supports its products worldwide with dedicated sales/marketing and customer-service locations in Wiesbaden, Singapore, and Montgomeryville, PA.

For more information, contact Theresa Perrotta, EG&G Heimann Optoelectronics, 221 Commerce Drive, Montgomeryville, PA 18936; Tel: 1-800-995-0602; Fax: 215-368-4790.

For More Information Write In No. 593

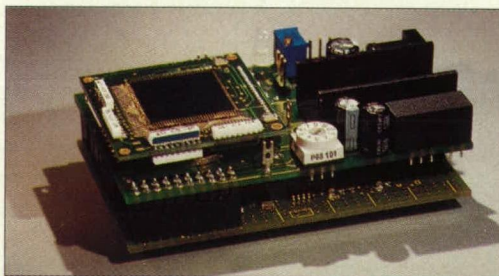

EG&G JUDSON

LEADERS IN INFRARED DETECTORS

Established in 1969 in suburban Philadelphia, EG&G Judson is a leading designer and manufacturer of high-performance infrared detectors and accessory products. Known worldwide for quality and innovation, we produce high-performance detector components for a wide range of industrial, scientific, military, and space applications.

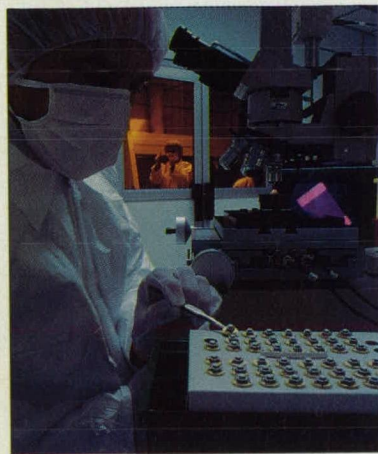

Specializing in germanium (Ge), indium arsenide (InAs), indium antimonide (InSb), and mercury cadmium telluride (HgCdTe) detector materials, our technology and products span the IR spectrum. These products range from simple photodetectors to TO-style packages to sophisticated integrated assemblies containing detector,

dewar, and preamplifier electronics for operation at cryogenic temperatures.

Judson's design services include specialized detectors, cooler systems, and preamplifier electronics, as well as multielement

detector arrays. Our initiatives in research and development have routinely resulted in new technology, all in response to evolving optoelectronic needs.

Recent contracts include: InAs detectors for NASA's HALOE satellite, HgCdTe detectors for the U.S. DOD DMSP project and NASA's GOES weather satellites, and radiometric-standard detectors for the National Institute of Standards and Technology.

Judson shares many outstanding qualities with others in the EG&G Optoelectronics group. An acknowledged industry leader, we are powerful enough to open new markets, and committed to the pursuit of excellence in everything we do. Total in-house capability (detector design, fabrication, and packaging) permits custom solutions. Judson excels in advanced material process development, fully space-qualified/MIL-spec hardware programs, engineering prototype programs, environmental/qualification testing, pilot-run and full-scale production, and technical support.

Judson's biggest success is in effectively meeting the needs of the individual customer.

Contact: Susan Justice, EG&G Judson, 221 Commerce Dr., Montgomeryville, PA 18936. Tel: (215) 368-6901; Fax: (215) 368-6927.

For More Information Write In No. 594

ROCKY MOUNTAIN INSTRUMENT CO.

FULL-SPECTRUM OPTICS, COATINGS, AND E-O PRODUCTS

RMI has been providing quality components to the optical community since 1957. After being purchased by Dr. Yubong Hahn, a recognized high-power coating expert, in 1983, RMI became a world-class leader in high-power thin-film coatings, laser, and imaging optics, from ultraviolet to far IR, as well as assemblies and electro-optical systems. In-house capabilities include grinding and polishing, coating, environmental testing, and optical subsystem assembly. By not having to rely on outside sources, we can more effectively serve our customers and control both quality and costs. Regardless of the requirement, from prototype to production, industrial standard to highly specialized, RMI optics, coatings, and assemblies are specifically designed to meet or surpass your most exacting specifications. RMI's excimer, Nd:YAG and CO₂ coatings have been proven to have the highest damage thresholds in the industry. Our Research and Development Department is constantly searching for, and developing, better materials, methods, designs, and controls to

increase productivity, efficiency, and ultimately product performance. Recent developments include a 45-degree optically contacted, high-power polarizing cube that can withstand 5 GW/cm².

To augment our 45,000-sq.-ft. manufacturing plant in Longmont, we have established Woo Kyung E-O in a new 72,000-sq.-ft. building in Ansan, Korea. This expansion has increased RMI's capabilities to include high-production lenses, prisms, night observation and thermal imaging devices.

Although we are justifiably proud of our manufacturing capabilities, our greatest commitment is to the customer. Over the past decade we have found that holding the philosophy that "All things are possible" has not only kept RMI but also its customers on the leading edge of technology. Contact: Debbie Hunt, Rocky Mountain Instrument Co., 1501 S. Sunset St., Longmont, CO 80501; Tel: (303) 651-2211; Fax: (303) 651-2648.



For More Information Write In No. 595

LITERATURE SPOTLIGHT

Free catalogs and literature for Laser Tech Briefs' readers. To order, write in the corresponding number on the Reader Information Request Form (page 55).

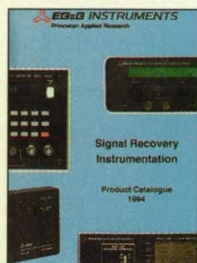

SIGNAL RECOVERY INSTRUMENTATION

EG&G Instruments (Princeton Applied Research) offers a 6" X 8" 60-page catalog that provides descriptions and specifications of its complete signal recovery line, including

preamplifiers, accessories, lock-in amplifiers, light choppers, signal averagers, photon counting equipment, digital delay generators, and multichannel scalars. Each section begins with a users' introduction. A list of sales offices and agents closes the catalog.

EG&G Instruments

For More Information Write In No. 600

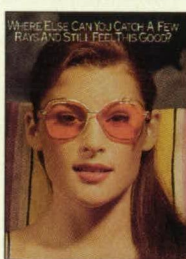

MICRON LASER-PROTECTIVE EYEWEAR

A full-color foldout brochure from Carl Zeiss Optical Group contains details of the Titmus Micron line of laser-protective eyewear. The line spans models for CO₂/UV, argon, ruby/di-

ode (670-725 nm), two other diode options (700-800 nm, 800-1200 nm), HeNe, Nd:YAG, KTP/Nd:YAG doubled, Nd:YAG/Nd:YAG doubled, and two broad-band options.

Carl Zeiss Optical/Titmus

For More Information Write In No. 601



AUTOMATIC OPTICAL TESTING

OPTOMATIC is the first fully-automated test instrument featuring fast, ultra-accurate, objective performance characterization of optical components and lens systems. Focal length, flange focal length, radius of curvature, angles and

power of wedges and prisms, MTF and centering errors can be precisely measured. Typical accuracy of 0.05% for focal length, 0.002 diopter for power of prisms and less than 1 arc sec. for angles.

Mildex Inc.

For More Information Write In No. 602

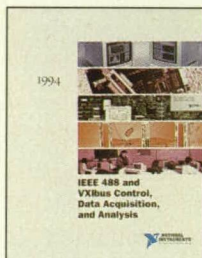

COMPUTER-BASED INSTRUMENTATION

Free 1994 catalog of hardware and software for computer-based instrumentation. Features software for Windows, Windows NT, Macintosh, UNIX, and DOS, including LabVIEW, LabWindows, and the new LabWindows/CVI. Describes IEEE 488.2 interfaces, plug-in data acquisition boards, VXIbus controllers, and signal conditioning accessories. Customer education classes also detailed. Includes tutorials and glossary.

National Instruments

For More Information Write In No. 603

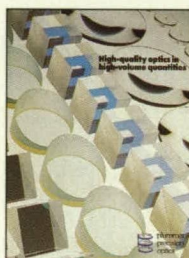

HIGH-QUALITY OPTICS IN HIGH-VOLUME QUANTITIES

Plummer Precision Optics' full-color brochure outlines its total in-house capabilities, from polishing and coating to finished assemblies — everything needed to manufacture high-quality

optics ranging from 0.2-12 in. diameter. Plummer delivers quality custom optics in high volumes economically and on time. Statistical Process Control monitors product quality and controls processes, and sophisticated testing equipment insures conformity to MIL-I-45208.

Plummer Precision Optics

For More Information Write In No. 604



AFFORDABLE CCD VIDEO CAMERA

Photometrics' brochure describes ImagePoint™, the first affordable, integrating, scientific cooled CCD video camera. ImagePoint combines Primary Point Digitization (PPD)™ and Peltier cooling

to yield higher image quality, lower noise, and larger dynamic range than traditional video cameras. ImagePoint is easy to use, is compatible with existing video systems, and requires no framegrabber.

Photometrics Ltd.

For More Information Write In No. 605

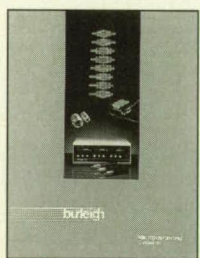

BURLEIGH MICROPOSITIONING SYSTEM

Burleigh has supplied unique solutions for demanding micropositioning applications for over 20 years. We have refined our technology to make even nanometer-scale positioning routine with

our latest generation of Inchworm® motors and related piezoelectric-based products.

Burleigh Instruments

For More Information Write In No. 606

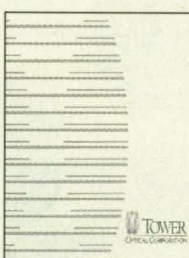

QUARTZ WAVEPLATES: ZERO ORDER \$215/MULTI-ORDER \$160

Free literature package describes this U.S. manufacturer's products, including quartz waveplates, Glan laser calcite polarizers, UV fused silica best-form lenses, high-power laser beam expanders, and microlenses.

Toll free: 1-800-335-5582; FAX 201-305-1175.

Tower Optical Corp.

For More Information Write In No. 607



HI-PRECISION LINEAR MOTION COMPONENTS

Our new 28-page catalog has it all — complete product line, prices, repair kits with instructions, machining guidelines, engineering data, and more. Features AG's proven patented adjustable preload, expanded V-rail product

line, and positioning stages which have been standardized for faster delivery. We continue to encourage custom alteration to your specifications. Tel: 1-800-922-0329; FAX 716-338-7370.

Automation Gages Inc.

For More Information Write In No. 608



PULSED NITROGEN AND DYE LASERS

Oriel Corp. has a new line of pulsed UV nitrogen lasers that utilizes an innovative hard-seal technology developed by its laser research group. This hard seal allows significantly

longer tube life — up to 10⁸ shots. Oriel offers a high-pressure 600-ps-pulse laser, and a higher-energy 5-ns-pulse version. The company has also introduced a tunable dye laser module that attaches to the output of either nitrogen laser and is tunable from 350-750 nm.

Oriel Corp.

For More Information Write In No. 634

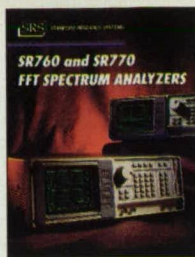

100-KHZ FFT SPECTRUM ANALYZERS

SRS spectrum analyzers offer 90 dB dynamic range, frequency spans from 191 MHz to 100 kHz, and a fast 100-kHz real-time bandwidth. The SR770's low-distortion (-80 dBc) source generates sine waves, two-tone signals, white

and pink noise, and frequency chirps for accurate frequency response measurements (to 100 kHz) with 0.05 dB precision. SR760 FFT Analyzer: U.S. list price \$4750; SR770 FFT Analyzer (with source): U.S. list price \$6500. Tel: 408-744-9040.

Stanford Research Systems

For More Information Write In No. 635



MULTI-AXIS SYSTEMS SCANNERS

Leading the General Scanning Multi-Axis Systems (GMAX™) line is the HPM™ series. The HPMs consist of a compact X-Y scanner head with on-board electronics that are easily interfaced to a PC for direct computer

control. Included for precision beam positioning is a field-flattening lens. Able to be used in the harshest environments. With exceptional versatility, the HPM and your laser can be used for marking, soldering/welding, material processing, and other vector-plotting tasks.

General Scanning

For More Information Write In No. 636

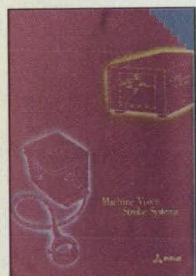

MACHINE-VISION STROBE ILLUMINATION SYSTEMS

EG&G Electro-Optics' new machine-vision strobe (MVS) system catalog features the complete family of strobe lighting systems and accessories. Individual data sheets describe a broad

packaged system line for uniform direct lighting, fiber optic lighting, or collimated lighting patterns for a variety of machine-vision and production-line applications.

EG&G Electro-Optics

For More Information Write In No. 637



LEADERS IN INFRARED DETECTORS

EG&G Judson's new 1994 catalog features 53 pages of new and improved products that meet the evolving challenges of the marketplace. Emphasis has been placed on custom engineering services that include: • Design of specialized detectors • Cooler systems • Preamplifier electronics • Multichannel detector arrays • Space and MIL-spec qualified detectors. For further information, contact Tel 215-368-6901; FAX 215-368-6927.

EG&G Judson

For More Information Write In No. 638



256 MEGABYTES OF IMAGE MEMORY

Literature is available for the 4MEG VIDEO Model 12 image capture, processing, and display board for the PC which now offers up to 256 Mbytes of image memory. The Model 12 features sampling/display rates up to 50 MHz, from 2 to 256 Mb of image memory, and a 50-MHz processor. The Model 12 interfaces to most video sources for single or sequential image capture. Tel 708-465-1818; FAX 708-465-1919.

EPIX Inc.

For More Information Write In No. 639

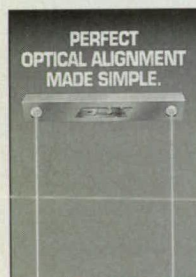

PERFECT OPTICAL ALIGNMENT MADE SIMPLE

The Lateral Transfer Hollow Retroreflector from PLX is a perfect device for applications such as bore-sighting, beam alignment, and beam delivery, where critical alignment of one

optical axis to another is required. Once installed in your system, the LTHR never needs adjustment. Our new technical booklet explains this unique instrument. Tel: 516-586-4190; Fax: 516-586-4196. International area code: 01.

PLX Incorporated

For More Information Write In No. 640



LASER DYES

With Exciton, you get a specialized team of professionals knowledgeable in the field of laser dyes. Since more than one dye may cover a given spectral region, we provide the latest information concerning the best dye selection for a specific laser system and application. Exciton Inc., PO Box 31126, Overlook Station, Dayton, OH 45431.

Exciton Inc.

For More Information Write In No. 641



SPECIALTY OPTICAL LIQUIDS

A new catalog of specialty optical liquids features high-transmission, safe-handling laser liquids plus fused silica matching liquids and specific refractive index liquids (1.300-2.1nD). MELTMOUNTS™ optical adhesives offer defined nD and easy removal. Microscopists and optical engineers will find it useful having basic information on Cargille refractive-index products consolidated in one publication.

R.P. Cargille Laboratories

For More Information Write In No. 642



NEW ELECTRO-OPTICAL PRODUCT GUIDE

Aerotech's new Electro-Optical Product Guide contains in-depth technical and design data for linear and rotary manual positioners, gimbal optical mounts, and green and red HeNe lasers and laser

power supplies. New products include the LZR3000 laser interferometer position measurement system and the lightweight SL series of breadboards. Contact Aerotech at 412-963-7470 or FAX at 412-963-7459.

Aerotech

For More Information Write In No. 643



LASER-BASED STRUCTURED LIGHT PROJECTORS

Lasiris Inc. is offering a complete line of laser-based structured light projectors for machine vision and alignment. Featured are focusable line generators from single-line to 99 parallel lines of a uniform, non-Gaussian distribution of intensity; single-circle and concentric-circle projectors; and dots to dot-matrix optical alignment, interrupt sensors, and 3-D mapping. Tel 1-800-814-9552; FAX 514-335-4576.

Lasiris Inc.

For More Information Write In No. 644



FREE CATALOG: OFF-THE-SHELF OPTICS

Free 130-page product catalog from Rolyon, the world's largest supplier of "off-the-shelf" optics. 24-hour delivery of simple or compound lenses, filters, prisms, mirrors, beamsplitters, reticles, objectives, eyepieces plus thousands of other stock items. Rolyon also supplies custom products and coatings in prototype or production quantities.

Rolyon Optics Co.

For More Information Write In No. 645

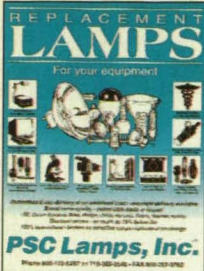

FREE LAMP CATALOG

This catalog features replacement lamps at discount prices for all types of audio visual, photographic, micrographic and graphic arts equipment. 100% guaranteed brand names - toll free ordering - no minimum order - ALL deliveries via UPS Second-Day

Air at no extra cost. Also, lamps for medical and electronic instruments, microscopes and video use. Tel: 1-800-772-5267, Fax: 1-800-257-0760. PSC Lamps, Inc. 435 W. Commercial St., E. Rochester, NY 14445.

PSC Lamps, Inc.

For More Information Write In No. 646



FREE ACCESS TO FEDERALLY FUNDED TECHNOLOGY

National Technology Transfer Center offers free access to federally funded technology, an electronic bulletin board announcing technology transfer opportunities, training on technology transfer issues, and strategic partnering conferences. Why not call (800) 678-6882 today and discover the research opportunities right at your fingertips.

National Technology Transfer Center

For More Information Write In No. 647

REACH 48,000 LASER/OPTICS PROFESSIONALS DIRECT

Laser Tech Briefs' Action Cards are direct business reply postcards bound into each issue to carry your message to 48,000+ laser, optics, and photonics professionals in industry, government, and the academy. These are technology managers, design engineers, and scientists who will avail themselves of this direct method of obtaining information on your product or service. The Spring 1995 issue is your next opportunity to use this marketing tool. Contact your Laser Tech Briefs sales representative (listed on page 6) or call Joe Pramberger at (212) 490-3999.

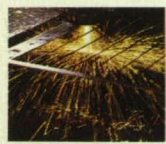

Achieving Optimum Laser Performance

ACHIEVING OPTIMUM LASER PERFORMANCE

Koolant Coolers, Inc. is offering a brochure on its standard and custom-designed single- and dual-circuit water chillers for lasers. The dual-circuit models permit optimum

cooling of resonator and optics for increased power and decreased beam diameter. All models can maintain required coolant temperature, with fluctuations as small as $\pm 1^\circ\text{F}$ ($\pm .56^\circ\text{C}$), if required.

Koolant Coolers

For More Information Write In No. 649



SPECIALTY GAS AND EQUIPMENT CATALOG

Free! The 1993 rare and specialty gas and equipment catalog from Spectra Gases of Irvington, NJ, contains specifications on rare gases, excimer laser gas mixtures, halogen gas pre-mixtures, helium-3 and isotopic gases, research gases and mixtures, gas safety cabinets, automatic and manual gas-handling systems, and related equipment. Krypton and argon ion-laser tube remanufacturing, halogen scrubbers, and "oil-free" vacuum pumps are highlighted.

Spectra Gases

For More Information Write In No. 650

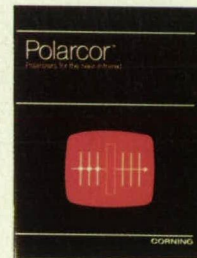

POLARCOR NEAR-IR GLASS POLARIZERS

Polarcor dichroic near-IR glass polarizers offer high contrast (to 10,000:1) and high transmittance (>90%). Features include 400 °C use temperature and large acceptance angles. Wave-

lengths from 632 to 2100 nm. In stock polarizer diameters of 6-25 mm, custom shapes with 2-30 mm diagonals possible. Contact Corning, Inc., Polarcor Sales, MP-21-4, Corning, NY. Tel: 607-974-7966.

Polarcor

For More Information Write In No. 651

Advertiser Index

Aerotech Inc.(RAC 643)	71	FJW Industries(RAC 414)	61	Photometrics Ltd.(RAC 335, 605) ...	25, 70
Affinity Chillers(RAC 316)	51	General Scanning.....(RAC 308, 636)...	34, 71	Plummer Precision Optics(RAC 312, 604) ...	19, 70
Applied Laser Systems.....(RAC 511)	1	II-VI, Inc.(RAC 302, 321, 322, 323, 324, 325)	11	PLX Incorporated(RAC 340, 640) ...	26, 71
Automation Gages Inc.....(RAC 608)	70	ILX Lightwave Corp.(RAC 314)	45	Polytec.....(RAC 361).....	COV 3
Bertan High Voltage.....(RAC 309)	62	Koolant Coolers Inc.(RAC 425, 649)	59, 72	Power Technology Inc.(RAC 360)	31
Burleigh Instruments.....(RAC 354, 606)29, 70		Labsphere Inc.....(RAC 413, 412)	64, 65	Princeton Instruments Inc.(RAC 430)	58
R.P. Cargille Laboratories(RAC 642)	71	Laser Tech '94	13	PSC Lamps Inc.....(RAC 646)	72
Carl Zeiss Optical (RAC 306, 601)	24, 70	Laser Science Inc.....(RAC 423)	50	QP Semiconductor Technology (RAC 319)	64
Coherent Laser Group.....(RAC 351).....	COV 4	Lasiris.....(RAC 644)	71	Rocky Mountain Instrument .(RAC 505)	7
Cold Springs R&D.....(RAC 680)	64	Lee Laser(RAC 418)	46	Rofin-Sinar Inc.(RAC 350)	15
Corning Polarcor Team(RAC 311, 651)30, 72		Master Bond Inc.(RAC 578)	6	Rolyn Optics Co.(RAC 645)	71
CVI Laser Corp.....(RAC 317)	22	Mekel Engineering Inc.....(RAC 307)	27	David Sarnoff Research Center (RAC 592)	68
Cynosure Inc.(RAC 318)	61	Micro-Optics Technologies Inc. (RAC 421)	65	Spectra Gases.(RAC 650)	72
Daedal(RAC 781)	35	Mildex Inc.(RAC 602)	70	Spectral Energy.....(RAC 419)	49
Edmund Scientific Co.....(RAC 304)	59	National Photocolor Corp.(RAC 427)	52	Spire Corp.(RAC 433)	47
EG&G Electro-Optics.....(RAC 637)	71	National Technology Transfer (RAC 647)	72	Stanford Research Systems Inc. (RAC 503, 635)	3, 71
EG&G Heimann.....(RAC 593)	68	National Instruments(RAC 603)	70	Sumita Optical Glass Inc.(RAC 310)	40
EG&G Instruments (PAR)(RAC 305, 600)23, 70		Ocean Optics(RAC 315)	48	Tower Optical Corp.(RAC 607)	70
EG&G Judson.....(RAC 300, 638) .COV 2, 71		Optical Research Associates..(RAC 431)	32	United Technologies Photonics (RAC 301)	9
EG&G Optoelectronics(RAC 371)	4-5	Optikwerks.....(RAC 313)	43	Velmex Inc.(RAC 355, 795)	6, 37
EG&G Reticon.....(RAC 791)	35	Optima(RAC 320)	63		
Electro-Optical Systems(RAC 303)	21	Oriel.....(RAC 334, 634) ...	10, 71		
EPIX, Inc.(RAC 404, 639) ...	66, 71	Oxford Lasers Inc.(RAC 422, 796) ...	37, 44		
Exciton Inc.(RAC 641)	71				

PI

Why OEMs Move In Our Direction.

Piezotechnology Nanopositioning Solutions in x,y,z

Courtesy of Zygo Corporation

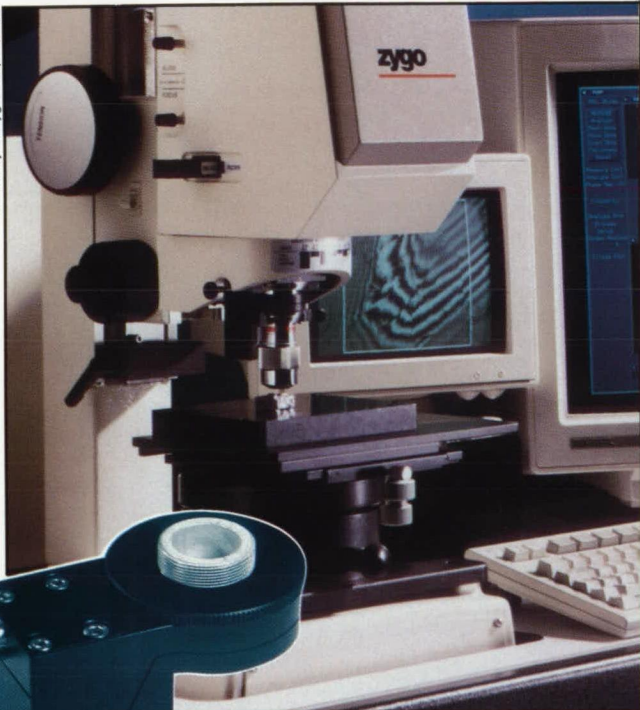

Zygo required a compact device to focus microscope objectives to subnanometer accuracy over a 100 μm range. They chose a Physik Instrumente PIFOC, off-the-shelf from Polytec PI. The result? The NewView 100 3D Imaging Surface Structure Analyzer, Photonics Circle of Excellence and R&D 100 Award Winner.

East Coast Office:

23 Midstate Dr., Suite 104
Auburn, MA 01501
☎ 508 832 3456 / FAX 508 832 0506

Germany: Physik Instrumente (PI) GmbH
☎ + 7243 6040 / FAX + 7243 604145

France: Polytec PI/RMP
☎ + 1 4700 2800 / FAX + 1 4700 2904

Japan: PI Polytec KK
☎ + 423 27-5400 / FAX + 423 27-5401

Great Britain: Lambda Photometrics Ltd.
☎ + 582 764334 / FAX + 582 712084

When Technical Instrument Company needed a precise Z-Stage for the KMS300T Photomask Inspection System, they also called us. We responded with a custom, 8X8 inch clear aperture piezoelectric stage providing 30 μm motion and 5 nanometer resolution.

Dozens of companies serving semiconductor, disk drive and medical

industries rely on Polytec PI for off-the-shelf and custom solutions to unusual and demanding nanopositioning problems. We can help you too; with over 20 years experience in harnessing piezotechnology, we have a wide repertoire of solutions adaptable to your needs at a fair price, with reasonable delivery. Give us a call.

West Coast Office:

3152 Redhill Ave., Suite 110
Costa Mesa, CA 92626
☎ 714 850 1835 / FAX 714 850 1831



Courtesy of Technical Instrument Company

 **Polytec PI**

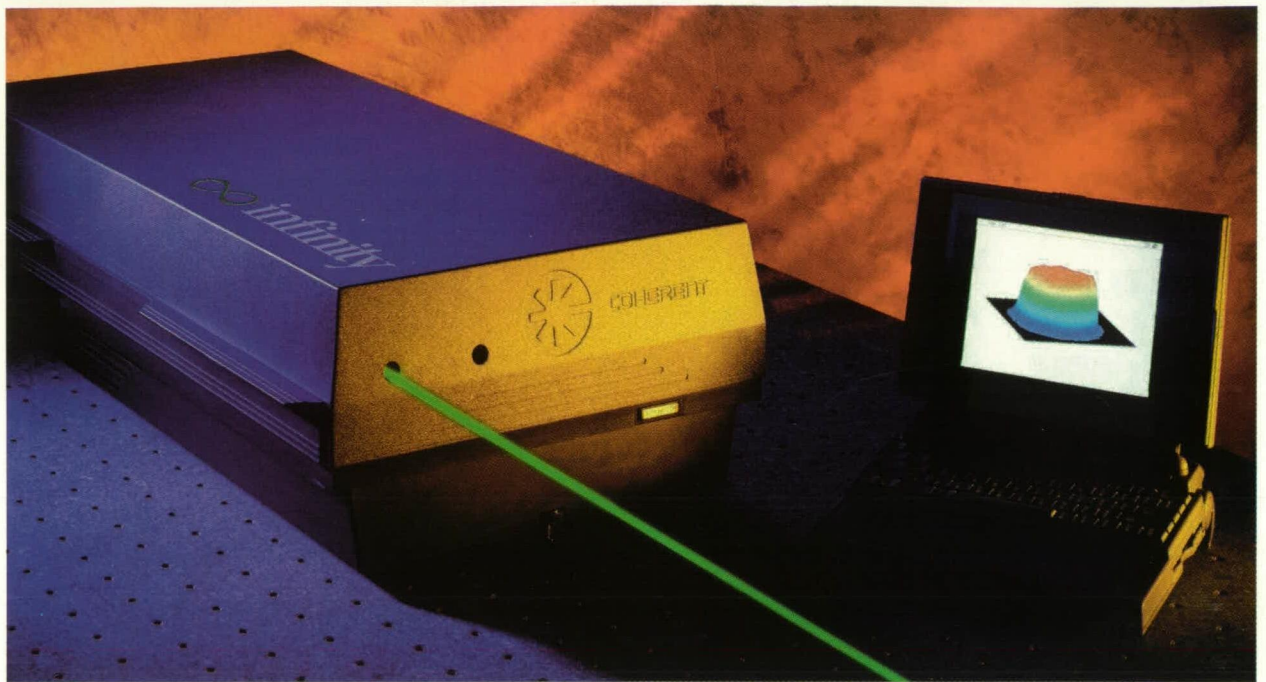

Infinity.™ A Revolutionary Approach to Pulsed Lasers.

Coherent's New, Pulsed Nd:YAG Laser Delivers 40W at 100 Hz in a Near Diffraction-Limited Beam.

Power. Repetition rate. Mode quality. Until now, you had to sacrifice one, or more, to achieve the others. The Infinity pulsed Nd:YAG laser provides all three, *simultaneously*.

A unique combination of optical phase-conjugation and relay imaging enhances gain extraction and delivers unrivaled mode quality. The performance is impressive: 400 mJ/pulse at 1064 nm or 200 mJ/pulse at 532 nm with variable repetition rates from single-shot to 100 Hz. And this performance is achieved with a single flashlamp, saving substantial time and money during the lifetime of the laser.

Many applications can benefit from Infinity's performance. Its power and repetition rate facilitate data acquisition. Single-frequency output and near 'top hat' mode profile are ideal for LIDAR, pumping OPOs, and pulsed video holography. And Infinity has ample green output for pumping tunable lasers like Lambda-Physik's SCANMATE.™

To learn more about Infinity, contact your local Coherent representative or call us today.

1-800-527-3786



Laser Group 5100 Patrick Henry Drive, Santa Clara, CA 95054
Telephone 408-764-4983 • Fax 1-800-362-1170 or 408-988-6838 • E-mail: tech_sales@clg.com • Japan (03) 3639-9811
Benelux (079) 621313 • France (01) 6985 5145 • Germany (06071) 9680 • United Kingdom (0223) 424065